

Operating and Installation Instructions

Laboratory Glassware Washer G 7883 CD

To prevent accidents
and machine damage
read these instructions

before

installation or use.

en - US, CA

M.-Nr. 07 157 440

IMPORTANT SAFETY INSTRUCTIONS	5
Guide to the lab washer	9
Description of the machine	11
Opening and closing the door	12
Water softener	13
Setting the water softener	13
Filling the salt reservoir	15
Salt indicator	16
Rinse Aid	17
Rinse aid indicator light	18
Setting the rinse aid dosage	18
Neutralizing agent	19
Adding neutralizer	19
Neutralizer indicator light	20
Detergent	21
Setting the liquid detergent dosage	21
Loading the machine	24
Spring adapter for the water connection	26
Adjusting the upper basket	26
Use	30
Turning on	30
Starting a program	30
Selecting the (optional) drying function	30
Program sequence display	31
End of a program	32
Additional drying	32
Turning off	32
Canceling a program	33

Contents

Program Guide	34
Programming functions	36
The following instructions apply to all programming functions:.. . . .	36
To access the programming mode	36
Saving to memory and exiting the programming mode	36
Exiting the programming mode without saving	36
DOS 1 (liquid detergent)	37
Setting the detergent dosage	37
Priming the dosage system	37
DOS 3 (neutralizer)	38
Setting the neutralizer dosage	38
Priming the dosage system	38
Buzzer	39
Changing program parameters	40
Changing the temperature	41
Changing the holding time	41
Restoring the factory settings	42
Setting the time and date.	43
Resetting the coarse and fine filter timer	44
Data transfer (optional)	45
Maintenance	46
Routine checks	46
Cleaning and Care	47
Frequently asked questions	54
Thermo switch	63
After Sales Service	64
INSTALLATION INSTRUCTIONS	65
Installation	66
Electrical connection	68
Plumbing	69
Technical data	73
Caring for the environment	74

IMPORTANT SAFETY INSTRUCTIONS

This machine conforms to current safety requirements. However, inappropriate use can lead to personal injury and property damage. Read the operating instructions carefully before using this machine.

The manufacturer cannot be held responsible for damage caused by non-observance of these Important Safety Instructions.

WARNING - To reduce the risk of fire, electric shock or injury:

Use

- ▶ This machine is not intended for any purpose that is not indicated in the operating instructions. Conversions, modifications, and other unintended uses are considered to be dangerous. The cleaning processes described here apply only to those medical products that are specifically designed by the manufacturer to be re-used. Follow the product manufacturer's instructions. Miele will not be held liable for damage caused by incorrect use of any kind.
- ▶ The installation of this unit in non stationary locations (e.g. ships) must be performed by a qualified installer or service agency in strict accordance with national and local safety regulations and standards.

Please pay attention to the following notes to maintain safe procedures.

- ▶ The machine should be installed, commissioned and maintained only by a Miele Service Technician. Repairs by unqualified persons could be dangerous.
- ▶ Do not install the machine in an area where a danger of explosion or freezing may be present.
- ▶ Be certain this appliance is properly installed and grounded by an authorized technician. To guarantee the electrical safety of this appliance, continuity must exist between the appliance and an effective grounding system. It is imperative that this basic safety requirement be met. If there is any doubt, have the electrical system checked by a qualified technician. The manufacturer cannot be held responsible for damage or injury caused by the lack, or inadequacy, of an effective grounding system (e.g. electric shock).
- ▶ A damaged machine is dangerous. Turn off the machine immediately at the main switch and call the Miele Service Department.
- ▶ Personnel operating the machine should be trained regularly. Children and untrained personnel must not be allowed access to the machine or its controls.

IMPORTANT SAFETY INSTRUCTIONS

- ▶ Take care when handling processing chemicals (detergents, softeners, neutralizers, etc.). These may contain irritant or corrosive ingredients. Do not use organic solvents as these could cause an explosion. Wear protective gloves and goggles. With all chemical agents the manufacturer's safety conditions must be observed.
- ▶ Do not stand, sit or lean on the opened machine door. This could cause the machine to tip over, resulting in injuries and damage.
- ▶ Do not touch the heating elements during or directly after the end of a program, burns could result. The elements remain hot for some time after the end of the program.
- ▶ The water in the machine must not be used as drinking water.
- ▶ Be careful when sorting items with sharp, pointed ends. Carefully position these items in the machine, so that you will not hurt yourself or create a danger for other operators.
- ▶ When using this machine regard the high temperatures and be especially careful not to scald or burn yourself. When opening the door bypassing the electrical lock, a danger of burning, scalding or corrosion exists or when using disinfection agents, the inhalation of toxic fumes. Let baskets and inserts cool. Empty any water from parts into the wash cabinet.
- ▶ If you are exposed to toxic vapors or processing chemicals, consult the manufacturer's material safety data sheets for emergency procedures.
- ▶ Always allow mobile units, modules, inserts, and loads to cool before removing. Be sure to empty any water from concave items into the wash cabinet before removing.
- ▶ After drying open the door to allow the items and inserts to cool.
- ▶ Never clean the machine or near its vicinity with a water or high pressure hose.
- ▶ Avoid inhaling powder products. They can cause burning in the mouth and throat if swallowed, and can inhibit breathing.
- ▶ Before servicing, disconnect the power supply by either removing the fuse, unplugging the unit or manually "tripping" the circuit breaker.
- ▶ Whenever work is conducted on the tap water network, the water supply line to the washer must be cleared of air. Failure to do so can result in damage to the water softener.

IMPORTANT SAFETY INSTRUCTIONS

The following points should be observed to assist in maintaining quality standards for critical labware and to avoid damage to the loads being cleaned.

▶ For this type of cleaning, the program must not be interrupted until completion. In other words, the On/Off Button must not be used. Interruptions should also be avoided for all other programs, such as during performance testing, because this can negatively affect the cleaning and rinsing results. After any interruption, the program should be restarted from the beginning.

▶ Only use cleaning agents formulated for special processes and approved by Miele for use with this machine. Use of unsuitable cleaning agents could adversely affect the components of the machine.

▶ Use only Miele approved cleaning agents with this machine. Use of unsuitable cleaning agents could adversely affect the components of the machine. Damages resulting from using unsuitable cleaning agents are not covered by the warranty.

▶ Pre-treatments with cleaning agents can create suds, as can certain rinsing agents. For pre-treatment and / or cleaning, only use low-sudsing detergents which have been approved by Miele. Suds can have an adverse effect on the cleaning process.

▶ If toxic chemicals may be present in the wash cabinet, beware of this risk when interrupting a program and opening the washer. The door seal and steam condensor must always be checked for soundness.

▶ The machine must only be operated with water and the recommended cleaning agents. Organic solvents must not be used in the machine as there is the danger, under certain circumstances, of explosion and damage to rubber and synthetic materials. Follow the dosage recommendations of the cleaning agent's manufacturer.

▶ In critical applications where very stringent requirements have to be met, it is strongly recommended that all the relevant factors for the process, such as detergent, quality of water, etc. are discussed with a Miele Application Technology specialist.

▶ It is the responsibility of the operator to routinely check that the required cleaning standards are being met. Therefore, results need to be regularly tested and documented, both thermo electrically and through inspection. For thermo chemical processes, additional testing is required using chemical or biological indicators.

▶ The performance of the cycles was tested using Neodisher products. The use of other products is not discouraged but may not yield identical results. Please be aware that changes in formulation, storage conditions, etc. which may not be publicized by the chemical manufacturer can have a negative effect on cleaning results, and are not the responsibility of the machine manufacturer.

IMPORTANT SAFETY INSTRUCTIONS

▶ When using cleaning agents and specialized products, it is essential that the manufacturer's instructions are followed. Only use the product for the application described by the manufacturer to avoid any material damage or the occurrence of strong chemical reactions.

▶ The mobile units, baskets and special inserts should only be used for their specific applications. Instruments with hollow parts must be flushed through with wash water.

▶ Empty all containers and utensils before arranging them in the machine.

▶ Do not allow any remains of acids, solvents or corroding ferrous material, and in particular hydrochloric acid or chloride solutions to get into the wash cabinet. The presence in compounds of any solvents should be minimal, (especially those in hazard class A1).

▶ To avoid any corrosion damage ensure that solutions or steam containing hydrochloric acid do not come in contact with the stainless steel casing of the machine.

▶ Please follow the installation advice in these instructions and the separate Installation Instructions.

Please note the following symbols on the machine:



Caution : See Operating Instructions!



Caution : Danger of electric shock!

Accessories

▶ Only genuine, Miele parts and accessories should be used with this machine, including Miele mobile units, baskets and inserts.

▶ Adequate cleaning results cannot be guaranteed when non-Miele accessories are used, or when Miele accessories are altered. Damages resulting from the use of unsuitable accessories are not covered by the warranty.

Disposal of an old appliance

▶ Obsolete appliances should be made unusable. To do this, first disconnect the appliance from the power supply, then cut off the power cord. It is important to note that the old appliance may be contaminated from exposure to pathogens, genetically modified material, blood, etc., and therefore must be decontaminated before disposal.





For safety and environmental protection, be sure to remove all chemical residue, in compliance with safety regulations (wear protective eyewear and gloves!).

Remove or destroy the door latch, to prevent children from locking themselves inside. The appliance can now be sent for disposal through the proper resource recovery facilities.

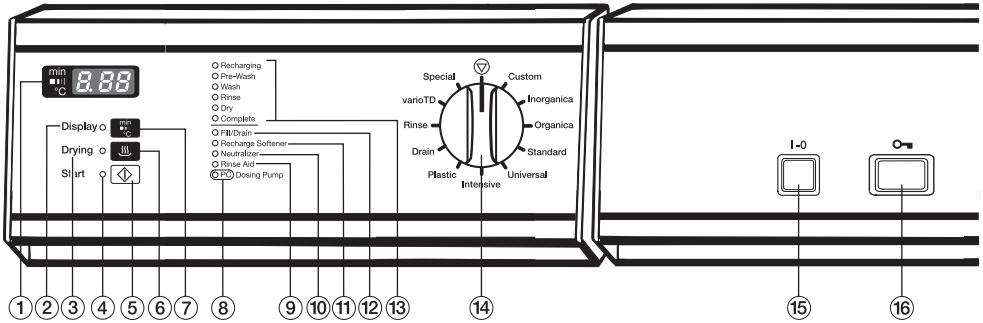
SAVE THESE INSTRUCTIONS

Guide to the lab washer



- ① Display
- ② "Display" indicator
- ③ "Drying" indicator
- ④ "Start" indicator
- ⑤ "Start"  button
- ⑥ "Drying"  button
- ⑦ "Display"  toggle button (toggles between the elapsed time, active wash blocks and temperature displays)
- ⑧ "OPC" Dosing pump" indicator
- ⑨ "Rinse aid" indicator
- ⑩ "Neutralizer agent" indicator
- ⑪ "Recharge Softener" indicator
- ⑫ "Fill/Drain" indicator
- ⑬ Program sequence display
- ⑭ Program selector
- ⑮ "On/Off" **I - 0** button
- ⑯ "Door"  button

Guide to the lab washer

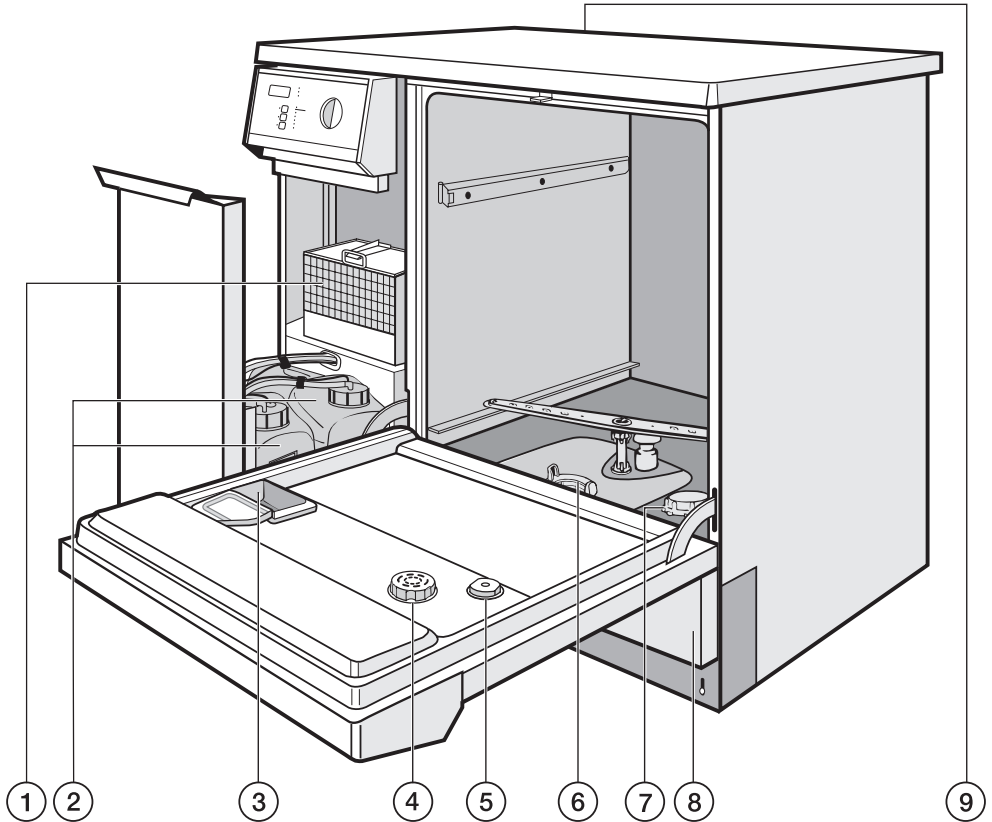

- ① Drying unit
- ② Dispensers for neutralizer (red) and **liquid** detergent (blue)
- ③ Dispenser for **powdered** detergent
- ④ Rinse aid reservoir (with dosage selector)
- ⑤ Level indicator for rinse aid
- ⑥ Filter combination
- ⑦ Salt reservoir (water softener)
- ⑧ Service panel
- ⑨ Serial interface

Description of the machine

Miele laboratory washers are designed to clean, rinse, and dry laboratory equipment.

In this operating manual, the general term "labware" is used to cover a range of laboratory equipment.

Always follow the labware manufacturer's instructions. Individual items need to be checked to ensure that they are designed to withstand the temperatures and acid / alkaline environment in the machine.

Standard model

The labwasher comes as standard with a:

- drying unit
- serial interface
- water softener
- steam condenser
- flow meter

Intended applications: Laboratory equipment

Lab equipment includes a wide range of items:

- Glassware, such as beakers, round-bottomed flasks, Erlenmeyer flasks, bottles, test tubes, funnels,
- measuring vessels, such as graduated flasks, graduated cylinders, pipettes
- dishes, such as petri dishes, watch glasses, mortars, and
- hardware, such as stoppers, spatulas and stirrers.

Labware can be made of glass, heat-resistant plastic, ceramic, stainless steel, or coated metal (e.g., stirrers).

Opening and closing the door

Electric door lock

The machine is equipped with an electric door lock.

The door can only be opened when

- the electrical supply to the machine is turned on, and the
- **On-Off** switch is pressed.

To open the door

- Press the  button in as far as it will go. At the same time, grip the handle and open the door.

 Do not touch the heating elements when you open the door at the end of a program. They remain hot for some time and can cause burns.

Once a program has started, the door stays locked until completion and cannot be opened. However, the two programs "Rinse" and "Drain" are exempt from the electric door lock. The door can be programmed to open during the "Drying" cycle, if desired.

To close the door

- Lift the door upwards and push it until it clicks shut. Do not press the release catch while shutting the door.

Emergency release

The emergency release feature should only be used when it is not possible to open the door normally, for example after a power outage.

- Turn the program selector to .
- Press the **On-Off** button to switch off the machine.

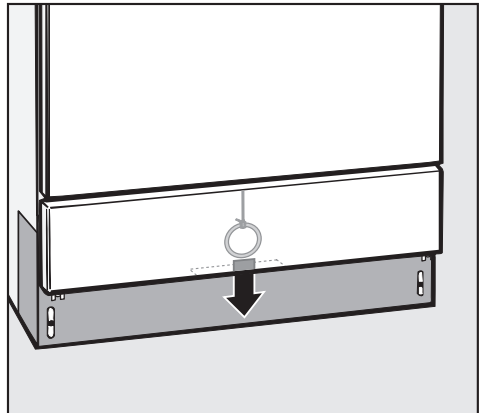

- Locate the ring for the emergency release cable (at the bottom of the machine, behind the service panel), and pull the ring downward to open the door.

Before using the machine for the first time, the water softener should be programmed. The water needs to be softened to avoid calcium deposits on the items being cleaned and in the machine itself.

If the water supply is harder or softer than the factory setting (including below 4 gr/gal or 70 ppm), the setting will need to be changed. See "Setting the water softener".

- In order to function properly, the water softener requires a supply of reactivation salt.
- The cleaner must be correctly programmed to match the hardness of the tap water supply.
- Your local water authority can provide information about the hardness of the tap water in your area.

If the water hardness is known to fluctuate, always program for the highest value.



The built-in water softener can be programmed at settings from 1 - 60 gr/gal or 20 - 1080 ppm.

It is useful to make a note of your water hardness so that you can provide the service technician with this information in the event of any service calls.

Please note the water hardness in the space provided here:

_____ gr/gal or ppm

Setting the water softener

- Use the **I - 0** button to switch off the machine.
- Turn the program selector to .
- **Simultaneously** press and hold the  and  buttons, while turning the machine on with the **On-Off** button.

The current program status **P...** will appear in the display, and the "Fill/Drain" indicator will come on.

- Press the  button one time.

EO1 will appear in the display.

- Turn the program selector one switch position clockwise (to 1 o'clock).

The number **19** will appear in the display (this indicates the factory setting in gr/gal).

- Press and hold the  button until the required value appears in the display.

Please refer to the "Settings" table for detailed water hardness tables (water hardness in gr/gal and ppm).

Once the **50** setting has been reached, the counter begins again from **0**.

- Press the  button.

SP will appear in the display.

- Press the  button again.

The setting you selected will now be stored in memory. The display light(s) will turn off.

The machine is now ready for use.

Water softener

Settings

Settings 1 - 30	gr/gal 1 - 30	ppm CaCO ₃
1	1	20
2	2	40
3	3	50
4	4	70
5	5	90
6	6	110
7	7	130
8	8	140
9	9	160
10	10	180
11	11	200
12	12	220
13	13	230
14	14	250
15	15	270
16	16	290
17	17	310
18	18	320
19	19 *)	340
20	20	360
21	21	380
22	22	400
23	23	410
24	24	430
25	25	450
26	26	470
27	27	490
28	28	500
29	29	520
30	30	540

Settings 31 -60	gr/gal 31 -60	ppm CaCO ₃
31	31	560
32	32	580
33	33	590
34	34	610
35	35	630
36	36	650
37	37	670
38	38	680
39	39	700
40	40	720
41	41	740
42	42	760
43	43	770
44	44	790
45	45	810
46	46	830
47	47	850
48	48	860
49	49	880
50	50	900
51	51	920
52	52	940
53	53	950
54	54	970
55	55	990
56	56	1010
57	57	1030
58	58	1040
59	59	1060
60	60	1080

*) factory setting

Filling the salt reservoir

Only special, coarse-grained reactivation salt* should be used in this machine.

*Available from Miele. Please see back page for more information.

Do not use other types of salt, e.g. table salt, agricultural or gritting salt. These could contain components which are insoluble in water and could damage the water softener. If in doubt, consult Miele Technical Service.

The salt reservoir holds approximately 2.5 kg salt.

 Inadvertently filling the salt reservoir with detergent will damage the water softener. Before filling the reservoir, make sure that you are using **reactivation salt**.

- Remove the bottom basket from the machine.
- Unscrew the salt reservoir cap.

Before filling the salt reservoir for the first time fill the reservoir with approximately 2.5 liters of water, so that the salt can dissolve properly. Once the washer has been operated, there will always be enough water in the reservoir.

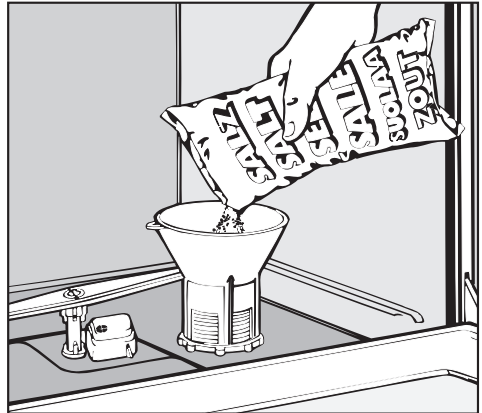

- Place the funnel provided in place.
- Carefully fill the reservoir with the reactivation salt.

Some displaced water will run out - this is normal.

- Wipe any residual salt off the screw threads of the reservoir.
- Screw the cap on securely.
- **Immediately after this step**, start the "Rinse" program, to remove any traces of salt from the inside of the machine.

Note: There may be a delay of a few minutes before the "Rinse" program starts due to the reactivation of the water softener.

Water softener

Salt indicator

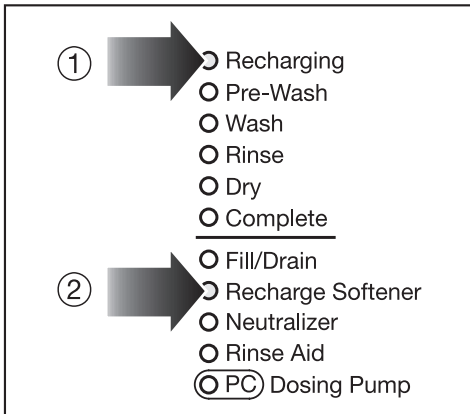

When the salt reservoir is empty, the "Recharge Softener" indicator ② lights to remind you to fill the reservoir.

Reactivation takes place automatically as needed during a program. The "Recharging" indicator ① lights while this is occurring.

Adding rinse aid

Rinse aid is not used in laboratory glassware cleaning applications.

If rinse aid is required, the rinse aid dosage must be activated with assistance from Miele Technical Service.

Rinse aid (e.g., MieleClear) is filled in the storage container, and the selected dose is then dispensed automatically. The rinse aid reservoir holds approximately 180 ml.

⚠ Inadvertently filling the rinse aid reservoir with detergent will damage the machine. **Be sure only to use rinse aid in the rinse aid reservoir.**

- Open the washer door.

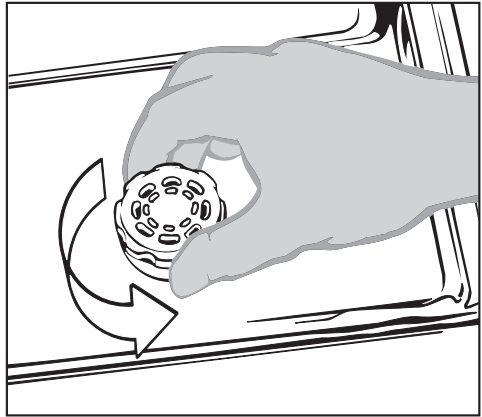

- Unscrew the reservoir cap.

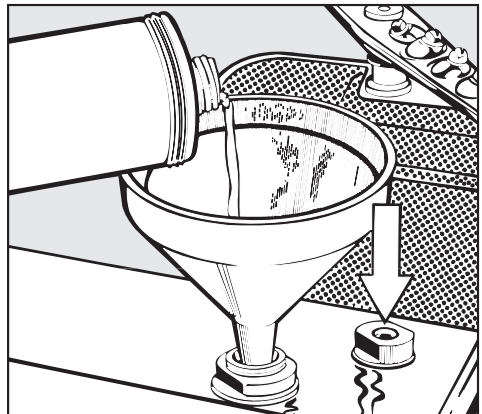

- Pour enough rinse aid into the reservoir so that the level indicator (see arrow) is dark. Use a funnel if necessary.
- Replace and tighten the reservoir cap.
- Wipe up any spilled rinse aid, to prevent over sudsing during the next wash cycle.

Rinse Aid

Rinse aid indicator light

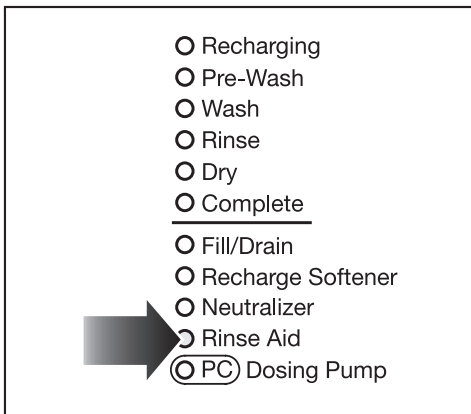

- Rinse aid does not need to be refilled until the "Rinse aid" indicator light comes on in the display.

Setting the rinse aid dosage

The dosage selector has settings from 1 to 6 (1 - 6 ml). The factory setting is at 3 (3 ml).

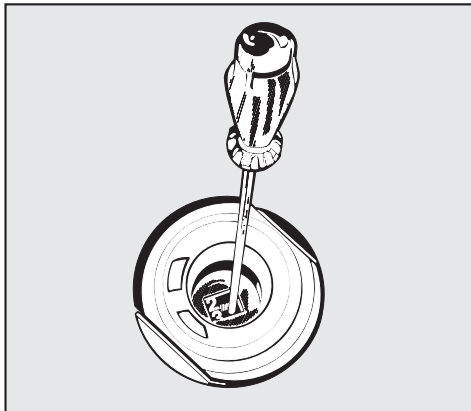

If the glassware shows spots after washing,

- adjust to a higher setting.

If the glassware shows smearing or cloudy streaks after washing,

- adjust to a lower setting.

Adding neutralizer

Neutralizer has an acidic pH, and works by neutralizing any traces of (alkaline) cleaner from the surface of the glassware.

When a mild alkaline detergent is used for washing, select a neutralizer that contains phosphoric acid.

The neutralizer is automatically dispensed during the second rinse after the main wash cycle. To function properly, the neutralizer container must be filled and cleared of air.

For specific instructions, please read the section on "Programming functions".

Note: the program "Inorganica" dispenses neutralizer after the pre-wash.

- Open the door of the storage cabinet that houses the neutralizer and detergent dispensers.

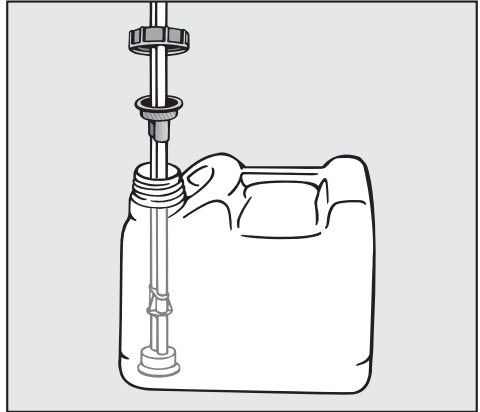

- Take out the (red) neutralizer container and refill it or replace it with a filled container.
- Insert the siphon tube into the container opening and screw it into place. Make sure to observe the color coding.

Neutralizing agent

Neutralizer indicator light

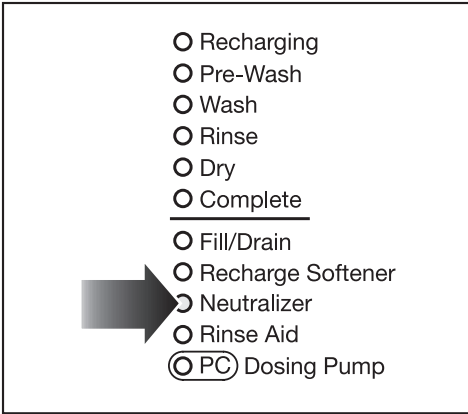

- When the "Neutralizer" indicator light comes on, it is important to promptly refill or exchange the neutralizer container.

Make sure to refill / exchange the container before it becomes completely empty.

Adding detergent

 Use only cleaning agents formulated for this machine. **Do not use detergents formulated for household dishwashers.**

The factory setting is designed for liquid detergents. Although powered detergents can be used, Miele recommends that you use liquid detergents instead.

Note also that the program "Organica" can only be used with liquid detergents.

Setting the liquid detergent dosage

The liquid detergent is automatically dispensed during Main Wash 1 and/or Main Wash 2 in the program sequence. The detergent dispenser must be properly filled and cleared of air.

For specific instructions, please read the section on "Programming functions".

- Open the door of the storage cabinet that houses the neutralizer and detergent dispensers.
- Take out the (blue) liquid detergent container and refill it or replace it with a filled container.

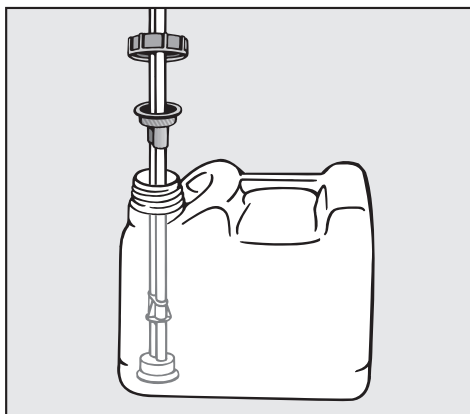

- Insert the siphon tube into the container opening and screw it into place. Make sure to observe the color coding.

Detergent

Liquid detergent refill light

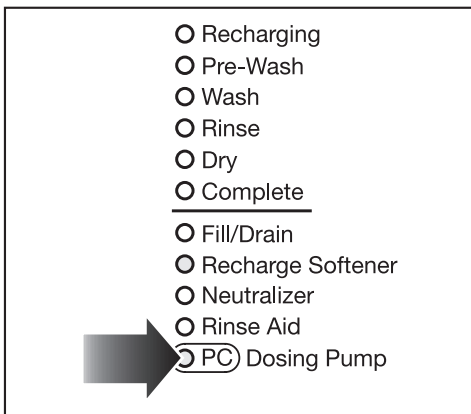

- When the "PC Dosing Pump" indicator comes on, it is important to promptly refill or exchange the detergent container.

Make sure to refill / exchange the container before it becomes completely empty.

Before starting the program, load the powdered detergent into the compartment (except for the programs "Rinse" and "Drain").

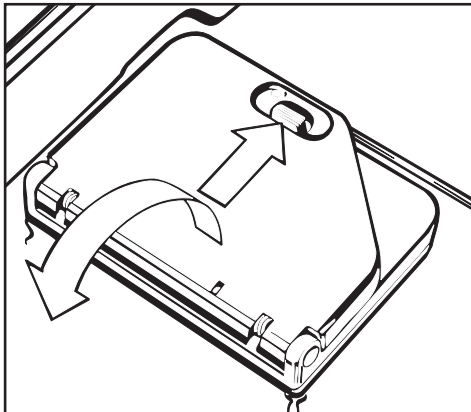

- Press the button on the dispenser cover. The cover will pop open.

The flap is always open at the end of a program.

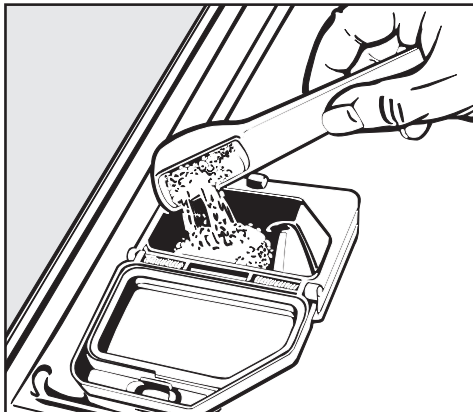

- Load the detergent into the compartment.

Dosage: To achieve a detergent concentration of approximately 3 g/l, use 30 g of detergent.

Always follow the detergent manufacturer's recommendations for dosage concentration.

- Snap the cover closed.

Loading the machine

Depending on the type of labware you wish to clean, the washer can be used with an upper basket, lower basket, or injector wagon, as well as an assortment of inserts and special baskets to suit your needs.

Baskets and inserts should be properly selected to match the application desired.

Before every program start, conduct the following visual inspection:

- Is the labware properly loaded and secured in the machine?
- Are the hollow vessels properly loaded so that all cavities and channels will be flushed clean?
- Are the spray arms clean, and can they rotate freely?
- Is the filter combination free of coarse debris (remove any coarse material and clean the coarse, fine, flat, and micro-fine filters as needed)?
- Is the basket adapter properly connected to the water supply for the spray arms and nozzles?
- Are the chemical dispensers filled?

After every program completion, conduct the following visual inspection:

- Inspect the labware for cleanliness.
- Has any hollowware been dislodged from its proper position on the nozzles?

 Any items that were dislodged from the adapters during a program cycle must be washed again.

- Are the cavities and channels in any hollow vessels cleaned through?
- Are the nozzles and connections firmly attached to the baskets/inserts?

Loading the machine

- Always load items in a way that all surfaces are exposed. This ensures that the items will be properly cleaned.
- Do not nest any items inside other items. Keep each item separate.
- Hollow vessels must be arranged for complete inside exposure to the cleaning water.
- Hollow vessels should be inverted and placed in suitable baskets and inserts so that water will have unrestricted access and exit.
- Deep-based items should be arranged at an angle, so that water can run off easily.
- Tall, narrow pieces should be placed in the center of the basket for best water coverage.
- Baskets and inserts with an adapter must be properly connected.
- The spray arms must not be blocked by items that are too tall or hang through the baskets.
- To avoid corrosion, only load stainless steel instruments in good condition.
- Do not use this machine to wash nickel-plated items or discolored (oxidized) aluminum items.
- Do not load plastics unless they are heat-resistant.

Prepare items before loading

- Empty all glassware before loading into the machine. Comply with all applicable infection-control regulations.
- Remove all agar residue from petri dishes.
- Remove any blood clots and blood residue.
- Remove all stoppers, corks, labels, sealing wax residue, etc.

 Ensure that no acid or solvent residues, especially hydrochloric acid or chlorides, get inside the machine.

Special preparations before operating the machine

Items affected by heavy contamination that resists removal, such as vacuum grease, paper labels, etc., can affect the cleaning and rinsing of the whole load. Pre-treat these items before loading.

Lab equipment that is contaminated by microbiological material, pathogens, propathogens, genetically altered material, etc., may need to be sterilized before being washed in the machine. The user is responsible for this decision.

Loading the machine

Spring adapter for the water connection

The spring adapter for the water connection must be properly engaged when a basket or the injector wagon is inserted into the machine. It must be 4 - 5 mm higher than the water inlet in the machine.

If this is not the case, the adapter needs to be adjusted as follows:

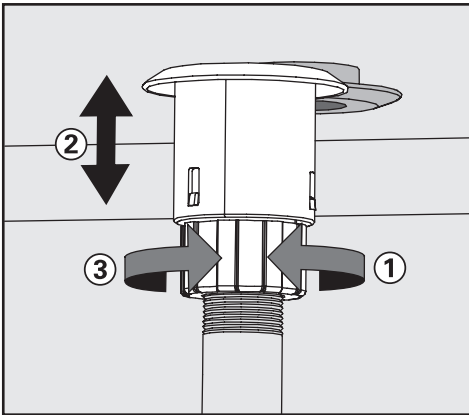

- Loosen the locking ring ①.
- Move the adapter up to the proper height ②.
- Tighten the locking ring ③.

Adjusting the upper basket

The upper basket can be adjusted above and below the middle position, by 2 cm.

Depending on the height selected and which inserts are used, labware of various heights can be arranged in the baskets.

To adjust the upper basket:

- Pull the upper basket out as far as it will go, lift it up off the runners and remove.
- Use a wrench to unscrew the roller bearings on either side of the basket, then reposition as required.

Laboratory equipment

Wide-necked labware, e.g., beakers, wide-necked Erlenmeyer flasks and Petri dishes, or cylindrical items, e.g., test tubes, can be cleaned inside and out by the rotating spray arms. For proper cleaning, load these items in whole, half or quarter inserts, and place them in an empty lower basket or upper basket with spray arm.

Narrow-necked items, e.g., narrow necked Erlenmeyer flasks, round flasks, volumetric flasks and pipettes, require the use of injector wagons or injector baskets.

Separate instructions are included for the use of injector baskets and inserts for narrow-necked labware.

This section only covers basic information on how to prepare and load labware.

- Petri dishes and similar items should be loaded in a suitable insert with the soiled side facing center.
- Pipettes should be placed with the narrow end facing down.
- Protective netting can be used to avoid glass breakage.
- Quarter baskets should be loaded at least 3 cm away from the edge of the wagon.

Loading the machine

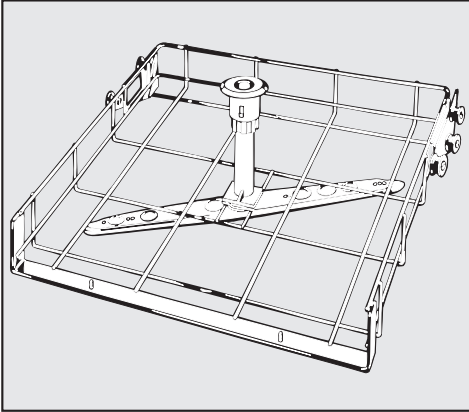

Upper basket O 188

For various inserts.

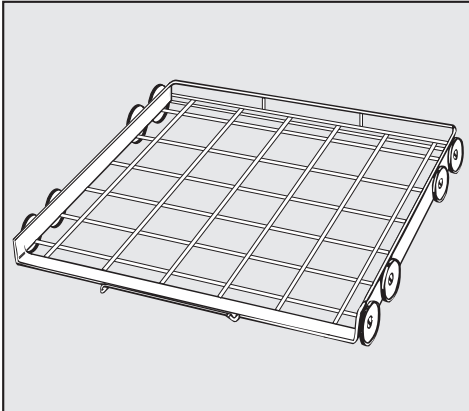

Lower basket U 874

For various inserts.

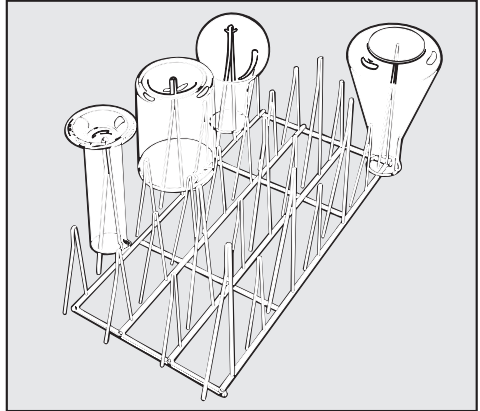

E 106

Stainless steel half insert with 28 spring hooks in 2 different heights for various glassware, e.g. narrow necked flasks, graduated cylinders, medicine bottles, etc.

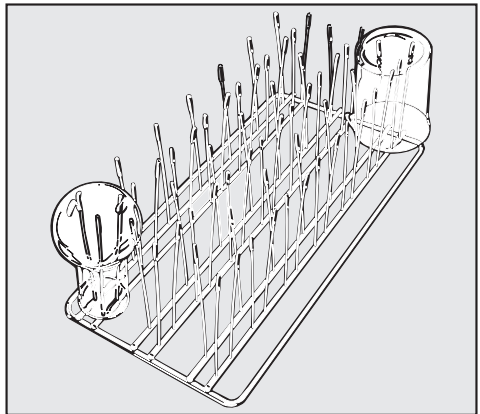

E 109

Stainless steel half insert to accommodate 21 beakers up to 250 ml, Erlenmeyer flasks, round flasks, etc.

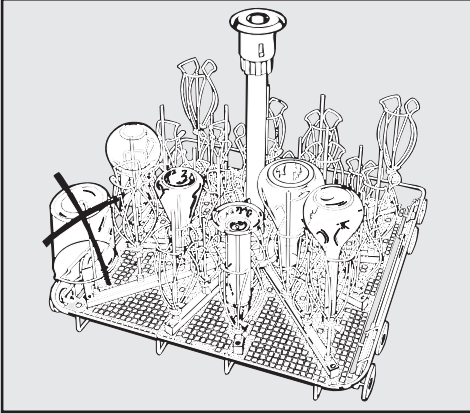

E 350 **Injector wagon**

For narrow necked glassware,
15 injectors, 160 mm high;
18 injectors, 220 mm high.



O 187 **Injector wagon**

(Upper basket) For direct injection of
narrow necked glassware,
34 injectors, 160 mm high.

Use

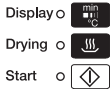

- Recharging
- Pre-Wash
- Wash
- Rinse
- Dry
- Complete
- Fill/Drain
- Recharge Softener
- Neutralizer
- Rinse Aid
- Dosing Pump

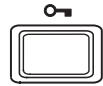
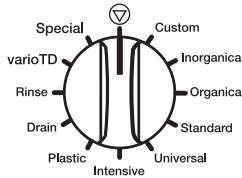

Turning on

- Close the door.
- Press the **I-0** button.

If the program selector is in the position, an indicator light will appear in the display.

Starting a program

- Turn the program selector clockwise or counterclockwise to the desired program. Refer to the "Program Guide" for more details.

The display shows the "Main Wash 1" temperature of the selected program (except for "Rinse" and "Drain"). The "Start" indicator flashes.

Selecting the (optional) drying function

The additional function "Drying" can be selected immediately after a program has been selected (except for "Rinse" and "Drain").

- Press the "Drying" button.

The options Drying 1 (if available) and Drying 2 will now be added - see the Program Guide for details.

The selected Drying 2 time appears in the display. The drying time can be changed in 5-minute increments, using the button.

Once the program has started the changed drying time for the selected program is stored. The total duration of the program adjusts accordingly.

- Press the "Start" button.

The display shows the current temperature.
The "Start" indicator comes on.

Once a program cycle has started, all other programs are locked until completion. If the program selector is turned to a different program, the display goes out. The display will re-appear if the program selector is turned back to the running program.

During a program, the "Display"  button can be used to toggle between the:

- actual temperature
- elapsed program time, and
- active wash block (depending on model):
 - 1 = Pre-rinse 1
 - 2 = Pre-rinse 2
 - 3 = Main wash 1
 - 4 = Main wash 2
 - 5 = Chemical disinfection
 - 6 = Interim rinse 1
 - 7 = Interim rinse 2
 - 8 = Interim rinse 3
 - 9 = Interim rinse 4
 - 10 = Final rinse 1
 - 11 = Final rinse 2
 - 12 = Drying 1
 - 13 = Drying 2

Program sequence display

Whenever a program is running, the indicator light for that program will remain on.

Recharging

Pre-Wash 1 + 2

Wash 1 + 2 *

Rinse 1 - 4 / Final rinse 1 + 2

Dry

Complete

(Program parameter achieved)

Use

End of a program

Once the "Start" indicator goes out, and the "Complete" indicator comes on, the program has ended. You will see a **D** in the middle of the display, and all other indicators will show a running light.

A buzzer sounds for a maximum of 30 seconds by default.

To change the buzzer function, see "Programming functions".

- Use the "Display" button to view the total running time or temperature of the program.

Additional drying

If additional drying is required after the end of a program, you can use the "Drain" program with Drying (optional function). This program runs for approximately 1 min in addition to the drying time selected.

Turning off

- Press and release the **I - 0** button.

Because of the electric door lock, the door can only be opened if the **I - 0** button is pressed (see "Opening and closing the door").

Canceling a program

Avoid canceling a running program unless absolutely necessary, for example if the glassware is moving around excessively or the wrong program has been selected.

 In cases of officially recognized epidemics, contaminated water must NEVER be drained from the machine.

- Turn the program selector to .

The program is canceled after 2 seconds.

- Open the door.

 Caution! Water and items in the machine may be hot. There is a danger of burning or scalding.

- Rearrange the items securely. Wear protective gloves as needed, and comply with all applicable health and safety regulations for infectious disease control.
- Replenish powder detergent if necessary.
- Close the door.
- Start the "Drain" program.
The water will be drained away.
- Select and start the program.

Program Guide

Program	Description
Custom	Open program available for programming by end user.
INORGANICA	For removing inorganic residue; generally for analytical applications, for light to moderate soiling, with moderate to high rinse requirements.
ORGANICA	For removing organic residue, such as oils, fats, wax, agar, preparation applications and for some analytical applications, with moderate to heavy soiling, and moderate rinse requirements. Liquid detergent required , cold, warm, and a DI water supply is recommended.
STANDARD	For a wide range of soiling types that do not denature or precipitate in alkaline environments, for some preparation and analytical applications, for light soiling, and low rinse requirements.
UNIVERSAL	For removing organic residue (such as proteins, oils and some fats) and some inorganic residues (pH 7, water-soluble metallic salts), for preparation applications and for some analytical applications, moderate to heavy soiling and moderate rinse requirements.
INTENSIVE	For removing organic residue (such as proteins, cell and tissue cultures, oils and some fats) and some inorganic residues (pH 7, water-soluble metallic salts), for preparation applications and analytical applications, moderate to heavy soiling, and moderate to high rinse requirements.
PLASTIC	For temperature-sensitive labware, such as plastic bottles (minimum required temperature resistance 55°C, for preparation applications and for some analytical applications, for light to moderate soiling, for moderate rinse requirements.
DRAIN	To pump away water, for example when a program is canceled.
RINSE	To rinse heavily soiled labware, e.g., to pre-treat heavy soiling, remove residue or to avoid drying and encrusting before a full program is run.
varioTD	For cleaning and thermal disinfection at 93 °C with 5 min holding time (as per EN ISO 15883-1).
SPECIAL 93°C - 10'	For cleaning and thermal disinfection at 93 °C with 10 min holding time (as per ¶ 18 of Germany's infectious disease control act, section A/B, fungicidal, bactericidal, and virus-inactivating).

CW = cold water, HW = hot water, DI = distilled water, °F (C°) = Temperature, min = holding time

* The DOS 2 rinse aid dosage must be activated by Miele Technical Service

Program Guide

Program sequence											
Pre-Wash		Main Wash		Rinse		Rinse		Final Rinse *		Drying ^x	
1	2	1	2	1	2	3	4	1	2	1	2
CW			HW DOS 1 80°C 3 min		HW DOS 3	HW	DI		DI 75°C 1 min	99°C 25 min	70°C 5 min
	CW DOS 3 50°C 1 min		HW DOS 1 75°C 3 min		HW DOS 3	DI	DI		DI 70°C 1 min	99°C 25 min	70°C 5 min
		HW 65°C 3 min	HW DOS 1 85°C 3 min		HW DOS 3	HW	DI		DI 80°C 1 min	99°C 25 min	70°C 5 min
			HW DOS 1 75°C 3 min		HW DOS 3		DI		DI 75°C 1 min	99°C 25 min	70°C 5 min
CW			HW DOS 1 80°C 3 min		HW DOS 3	HW	DI		DI 75°C 1 min	99°C 25 min	70°C 5 min
CW			HW DOS 1 85°C 3 min		HW DOS 3		DI	DI	DI 80°C 1 min	99°C 25 min	70°C 5 min
CW			CW DOS 1 55°C 5 min		CW DOS 3	CW	DI	DI	DI 55°C 1 min	65°C 5 min	55°C 35 min
											65°C 30 min
							CW				
CW		CW DOS 1 55°C 5 min			HW DOS 3	HW			DI 93°C 5 min		99°C 35 min
		CW DOS 1 93°C 10 min			HW DOS 3	HW			DI 75°C 3 min		99°C 35 min

x = Additional function DOS 1 = Detergent dosage from 131°F (55°C)

DOS 3 = Neutralizer dosage after water inflow

Programming functions

For future servicing, be sure to document any changes made to the factory settings in the fields provided.

General information:



- Program selector positions that have no assigned function are represented by a bar (-) in the middle of the display.
- To call up the programming level, use the  position. The status *E.* will appear in the display.

The following instructions apply to all programming functions:

To access the programming mode

■ Turn the program selector to .

■ Turn off the machine.

■ **Simultaneously** press and hold the  and  buttons, while turning on the machine by pressing the **On-Off** button. The current program status *P.* appears in the display. The Fill/Drain indicator lights.

Saving to memory and exiting the programming mode

■ Press the  button. *SP* appears in the display.

■ Press the  button again. The change will now be stored in the memory.



Exiting the programming mode without saving

■ Press the **On-Off** button to switch off the machine. The change is canceled.

DOS 1 (liquid detergent)

Setting the detergent dosage

The dosage concentration only needs to be set for liquid detergents. Set the concentration according to the detergent manufacturer's recommendations. Do not change the setting if you are using powdered detergent in the door dispenser.



Step	Display / Result
■ Press the  button until E02 appears in the display.	<i>E02</i>
■ Turn the program selector to "Inorganica".	
Using door dispenser	<i>10</i> = 10 sec dosage length
Using DOS module	<i>1.00</i> = 1.0 % dosage concentration
■ Press or hold down the  button until the required value appears in the display, e.g., 0.5.	<i>0.50</i> The dosage time / dosage concentration is now set.

Dosage concentration setting: _____

Priming the dosage system

The dosage system does not need to be primed (cleared of air) unless:

- the dosage concentration is being set for the first time,
- the liquid detergent container was inadvertently completely emptied .



Step	Display / Result
■ Press the  button until E02 appears in the display.	<i>E02</i>
■ Turn the program selector to "Custom".	<i>do1</i>
■ Press the  button.	The dosage system will be primed automatically. Priming is complete when <i>0</i> appears in the display.
■ Exit the programming mode. Start "Rinse" program.	This will rinse away any agents that entered the wash cabinet during priming.

Programming functions

DOS 3 (neutralizer)

Setting the neutralizer dosage

Set dosage concentration according to the neutralizer manufacturer's recommendations.



Step	Display / Result
■ Press the  button until E02 appears in the display.	<i>E02</i>
■ Turn the program selector to "Intensive".	The programmed dosage concentration appears in the display, e.g., <i>0.10</i> = 0.10 %
■ Press and hold the  button until the required value appears in the display, e.g., 0.2.	<i>0.20</i> The dosage concentration is now set.

Dosage concentration setting: _____

Priming the dosage system

The dosage system does not need to be primed (cleared of air) unless:

- the dosage concentration is being set for the first time,
- the neutralizer container was inadvertently completely emptied .

Step	Display / Result
■ Press the  button until E02 appears in the display.	<i>E02</i>
■ Turn the program selector to "Universal".	<i>do3</i>
■ Press the  button.	The dosage system will be primed automatically. Priming is complete when <i>0</i> appears in the display.
■ Exit the programming mode. Start "Rinse" program.	This will rinse away any agents that entered the wash cabinet during priming.



Buzzer

The buzzer can be programmed for the following functions:

- a continuous tone at the end of a program,
- an error signal that beeps in 1-second intervals, and
- a sample-collection signal (allows a sample of the final rinse water to be collected) that beeps in sets of 3 followed by a 2-sec pause. Contact Miele Technical Service to program the sample-collection signal.

The numbers shown in the display correspond to the following settings:



- 20** Buzzer off
- 21** End of program (factory setting)
- 22** Error
- 23** End of program + Error
- 24** Sample-collection signal
- 25** End of program + Sample-collection signal
- 26** Error + Sample-collection signal
- 27** All functions (End of program + Error + Sample-collection signal)

Step	Display / Result
■ Press the  button until E04 appears in the display.	<i>E04</i>
■ Turn the program selector to "Inorganica".	<i>21</i>
■ Press and hold the  button until the required value appears in the display, e.g., 26.	<i>26</i>

Value selected: _____

The buzzer will sound for 30 sec during the selected setting.

To switch it off earlier:

- Turn the program selector to .
- Press the  button.
- Interrupt the power supply, e.g., open the door.

Programming functions

Changing program parameters

The factory settings for various parameters are listed in the "Program Guide".

Program parameters cannot be changed unless they are activated within a given program (see "Program Guide").

It is important to document any changes e.g., by recording them in the corresponding column in the program guide.

Changing the wash and rinse parameters

The wash programs can be adjusted to meet various technical requirements. For example, the temperatures and cycle times for the program blocks Main Wash 1 and Main Wash 2, and Rinse 1 and Rinse 2, can be changed.

Available temperature range:
30 °C - 93 °C in all programs except "Rinse", "Drain" and "Special".

Available time range:
1 - 15 min.

Changing the drying parameters



The drying parameters within the various wash programs can be adjusted to meet specific requirements. For example, the temperatures and drying times within the program blocks Drying 1 (if available) and 2 can be changed.

Available temperature range:
50 °C - 99 °C



Available drying time range for:
Drying 1: 1 - 99 min in 1 min increments
Drying 2: 5 - 95 min in 5 min increments

The drying time in the Drying 2 program block can also be changed by using the  button (see "Selecting the drying function").

Changing the temperature



Step	Display / Result
<ul style="list-style-type: none"> Press and hold the  button until the setting of the desired program block appears in the display. 	<i>E09</i> for Main Wash 1 <i>E12</i> for Main Wash 2 <i>E22</i> for Rinse 1 <i>E25</i> for Rinse 2 <i>E28</i> for Drying 1 <i>E31</i> for Drying 2
<ul style="list-style-type: none"> Set the program selector to the program you wish to change, e. g., "Custom". 	°C - 75
<ul style="list-style-type: none"> Press and hold the  button until the desired value appears in the display, e.g., 70 °C. 	°C - 70

Changing the holding time

Step	Display / Result
<ul style="list-style-type: none"> Press and hold the  button until the setting of the desired program block appears in the display. 	<i>E10</i> for Main Wash 1 <i>E13</i> for Main Wash 2 <i>E23</i> for Rinse 1 <i>E26</i> for Rinse 2 <i>E29</i> for Drying 1 <i>E32</i> for Drying 2
<ul style="list-style-type: none"> Set the program selector to the program you wish to change, e. g., "Custom". 	min - 7
<ul style="list-style-type: none"> Press and hold the  button until the desired value appears in the display, e.g., 10. 	min - 10

Programming functions

Restoring the factory settings

Step	Display / Result
■ Press and hold the  button until E33 appears in the display.	<i>E33</i>
■ Turn the program selector to a program.	
Default factory setting(s):	<i>00</i>
Re-programmed setting(s):	<i>PP</i>
■ When <i>PP</i> appears in the display, press the  button.	<i>00</i> , the factory settings have been restored.

The water softener has been restored to the factory settings. Reprogramming is required (see "Setting the water softener"). Program changes to the open programs "Custom", "Inorganica" and "Organica" remain unchanged.

Setting the time and date

The date and time are set in the serial interface (optional accessory). This information appears in the print log.

The date and time can be changed, e.g., from daylight saving to standard time.

Use the program selector to activate the desired time and date:

1 o'clock position: Calendar day *01 - 31*



2 o'clock position: Month *01 - 12*

3 o'clock position: Year *00 - 99 = 2000 - 2099*

4 o'clock position: Hours *00 - 23*

5 o'clock position: Minutes *00 - 59*

When level **E34** is selected without an activated serial interface, a "-" appears in the display for all program selector positions.



Step	Display / Result
■ Press and hold the  button until E34 appears in the display.	<i>E34</i>
Wait approximately 30 sec before the next step.	The control unit retrieves the currently stored values.
■ Switch the program selector to the position for the value you wish to change, e.g., to the 4 o'clock position to set the hour.	<i>10</i>
■ Press and hold the  button until the required value appears in the display, e.g., 1 x.	<i>11</i> , the hour is changed.
Wait approximately 30 sec before turning off the machine.	The updated values are transmitted to the serial interface.

Once the values are saved and you have exited the programming mode, the updated values are transmitted to the interface. Therefore wait about 30 seconds before switching off the machine.

Programming functions

Resetting the coarse and fine filter timer

Whenever the coarse or fine filter in the drying unit are changed, the service timer should be reset to zero.

Step	Display / Result
■ Press and hold the  button until E04 appears in the display.	<i>E04</i>
Switch the program selector to the position for the value you wish to change. Coarse filter = 6 o'clock position Fine filter = 7 o'clock position	The control unit shows the currently stored values, e.g., <i>105</i> <i>512</i>
■ Press and hold the  button until the service timer is erased.	<i>000</i>

Data transfer (optional)

The machine is equipped with an interface socket so that data can be transferred from Novotronic to a log printer.

Please contact Miele Technical Service to order printer cables.

The serial interface is RS 232 compatible.

Various printer types with Epson-compatible fonts can be used for printing.

Miele Technical Service maintains a list of recommended printers.

Pin assignment 9-pin sub-D connector:

5 GND (ground)

3 TXD (send)

1-4-6 (bridge)

7-8 (CTS)

 Printer initialization must only be performed by Miele. Consult Technical Service using the contact information on that back of this manual.

During program operation a protocol is prepared. It can be printed using an external printer.

The protocol contains the following information:

- date and device number
- program start time and name
- rinse blocks used
- dosage system with dosage temperature and target dosage amount
- target values for temperature and holding times
- minimal temperature during the holding time
- all errors (e.g., water supply defect)
- program end time
- warnings, e.g., salt required.

Maintenance

Periodic maintenance for the machine is recommended annually.

Routine checks

The routine checks must be done daily by the user before using the machine. For the routine checks a checklist is supplied with the washer.

Check the following points:

- the filters in the base of the wash cabinet must be empty,
- the spray arms in the machine and at the baskets should be clear,
- the wash cabinet and the door gasket should be clear,
- the dispensing systems, and
- the baskets and inserts.

 Wear protective gloves and goggles when cleaning this machine.

Cleaning the filters in the wash cabinet

 The machine must not be used without all filters in place. The filters protect the circulation pump from damage caused by foreign objects.

The filter combination in the base of the wash cabinet should be inspected regularly and cleaned if necessary.

Watch out for sharp objects which could cause injury e.g. glass splinters.

Cleaning the coarse filter

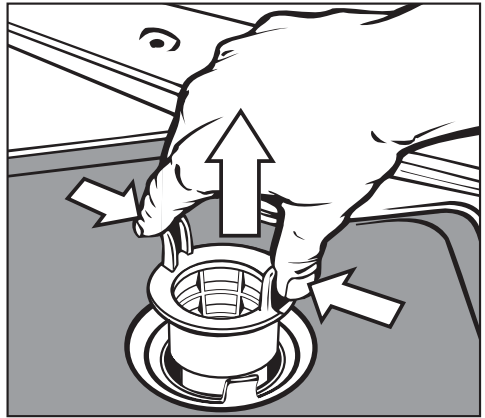

- Press the two tabs together, remove and clean the coarse filter.
- Put the clean filter back in position and press until it clicks into place.

Cleaning and Care

Cleaning the fine, flat and micro-fine filters

- Remove the coarse filter.
- Remove the fine filter from between the flat and micro-fine filters.

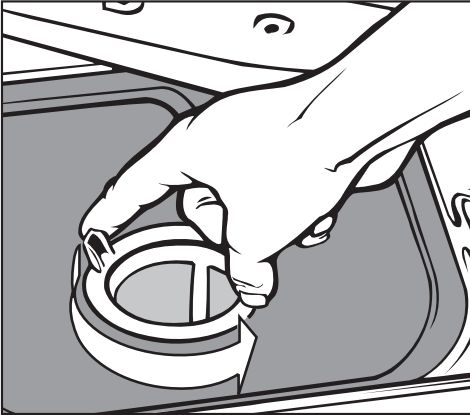

- To unscrew the micro-fine filter, grasp the two tabs and turn twice counterclockwise.

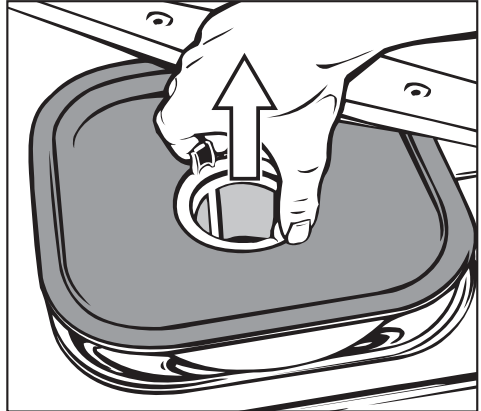

- Then remove together with the flat filter.
- Clean the filters.
- Replace the filter combination in reverse order. The flat filter must lie flat in the base of the wash cabinet.

Cleaning the spray arms

The spray arms can get clogged. Check daily and clean if necessary.

Removing the spray arms

- Remove the baskets.

Spray arm at the upper basket or mobile unit (if available):

- Loosen the knurled nut and remove the spray arm.

Metal knurled nuts have a left-hand thread. Ceramic knurled nuts have a right-hand thread.

- Unscrew the upper spray arm.
- Loosen the knurled nut of the lower spray arm and remove.
- Use a sharp pointed object to push particles into the spray arm jets and rinse thoroughly under running water.
- Refit the spray arms in reverse order after cleaning.

After replacing the spray arms check that they can rotate freely.

Cleaning and Care

Cleaning the drain pump and non-return valve

If water has not been pumped away at the end of a program the drain pump or the non-return valve may be blocked.

- Turn off the machine.
- Remove the filter combination out of the wash cabinet.

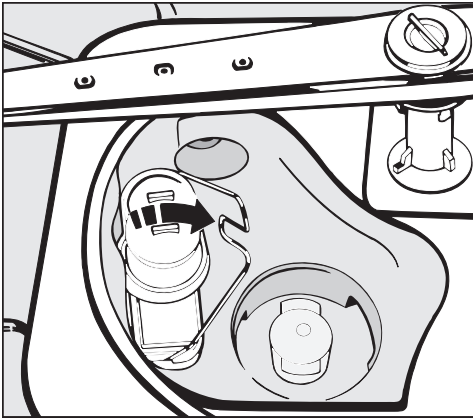

- Tilt the locking clamp to the side.
- Pull out the non-return valve and rinse well under running water.

The drain pump is beneath the non-return valve (see arrow).

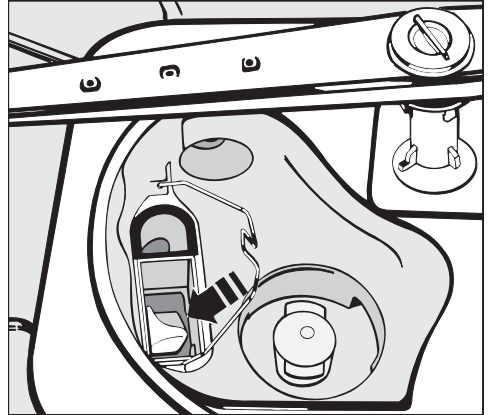

- Before refitting the non-return valve, check that the drain pump is not blocked. Spin the propeller several times in both directions to check for obstructions.
- Carefully refit the non-return valve and secure it with the locking clamp. Refit and lock the filter in place.

For safety the load should be washed again.

Cleaning the water inlet filters

To protect the water inlet faucet, filters are incorporated in the intake hose attached to the water supply. If the filters are soiled they must be cleaned to ensure sufficient water intake to the wash cabinet.

 The plastic housing of the water connection contains electrical components and should not be submerged or run through water.

Cleaning the filters

- Disconnect the machine from electricity (unplug it or "trip" the circuit breaker).
- Close the water supply and unscrew the water inlet faucet.
- Carefully remove the rubber seal.
- Take out the filters with needle nose pliers.

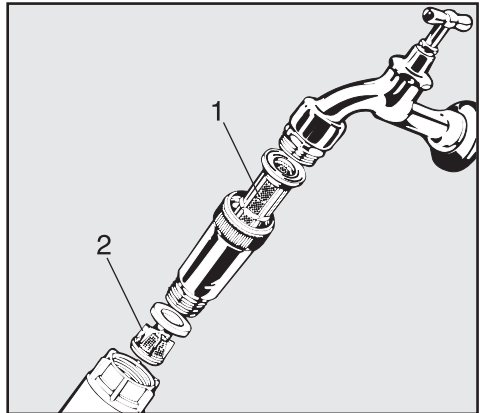

- Rinse the large area filter **1** and fine filter **2** under running water, and replace if necessary.
- Return filters and seal. Make sure they are seated correctly.
- Reconnect the hose to the water faucet, checking that it is not cross-threaded.
- Open the water supply.
- Check for leaks.

Cleaning and Care

Cleaning the control panel

- The control panel should only be cleaned with a damp cloth or a suitable cleaner for use on plastic materials.

 Do not use abrasive cleaners, glass cleaners or all-purpose cleaners! They **will** damage the control panel.

Cleaning the exterior

- Stainless steel surfaces can be cleaned using a non-abrasive stainless steel cleaner or dishwashing detergent and warm water.
- To help prevent resoiling, a conditioner for stainless steel can also be used. Apply sparingly with even pressure.

 Do not use cleaners containing thinner or ammonia. They will damage the surface.

 Never clean the machine or near its vicinity with a water or high pressure hose.

Cleaning the wash cabinet

The wash cabinet is mostly self cleaning.

If deposits have built, contact Miele for info.

Cleaning the door seal

Clean the door seal regularly with a damp cloth to remove soiling.

To replace damaged or leaking door seals please contact Miele's Technical Service Dept.

Dispensing systems

Check the consumption of the used chemicals regularly to notice any irregularities of the dispensing.

Baskets and inserts

To ensure the function of baskets and inserts, they must be checked daily. A checklist is supplied with the machine.

Check the following points:

- Are the rollers in the proper condition and are they securely fixed in the mobile unit/insert?
- Is the basket connection set to the correct height and tightened?
- Are all spray jets, spray sleeves and hose adapters tightly connected to the basket/insert?
- Are all spray jets, spray sleeves and hose adapters, unclogged so that the wash water can flow through?
- Are covers and fasteners tightly screwed on the spray sleeves?

If available:

- do the spray arms rotate freely?
- Are the spray jets clogged? See "Cleaning and Care - Cleaning the spray arms"?

Frequently asked questions

The following guide can be used to help address minor problems without a service call.

 Repairs should only be performed by Miele Technical Service. Work performed by unqualified persons can place the user at considerable risk of harm.

To help avoid unnecessary service calls, please be sure to check first whether an error message is due to operator error.

To do so:



- Turn the program selector to . The error message is erased.
- Press the **On-Off** button to switch off the machine.
- Turn the machine back on and re-start the program.
- If the error occurs again and cannot be corrected, contact Miele Technical Service for assistance.
- You will need to provide the error code ("F...") .

What if...	Possible fault	Solution
The washer will not start.	The door is not properly closed.	Close the door firmly.
	The machine is not plugged in.	Plug in the power cord.
	The fuses are defective or the circuit breaker has tripped.	Make sure the breaker has not tripped.
	The washer is not turned on.	Press the On-Off button and select a program.
The program does not continue.	Error message: <i>F 04 - F 17, F 20 - F 26, F 28 - F - -</i>	Contact Miele Technical Service.
	Fault code <i>F 31 - 33</i>	Dosing system faulty. Contact Miele Technical Service.

Frequently asked questions

What if...	Possible fault	Solution
<p>Before the start of a program, the "ⓄPC Dosing Pump" indicator flashes, and the program can not be started.</p>		<p>Before addressing the error:</p> <ul style="list-style-type: none"> – Turn the program selector to Ⓞ. The error message is erased. – Press the On-Off button to switch off the machine.
	<p>Error message: Fdo: The liquid detergent container is empty.</p>	<p>Refill or replace the liquid detergent container.</p>
		<p>Then:</p> <ul style="list-style-type: none"> – Switch the washer on. – Restart the program.
<p>A few minutes after the start of a program, the "ⓄPC Dosing Pump" indicator flashes, and the program stops.</p>		<p>Before addressing the error:</p> <ul style="list-style-type: none"> – Turn the program selector to Ⓞ. The error message is erased. – Press the On-Off button to switch off the machine.
	<p>Error message: Fdo: There is a problem dispensing the liquid detergent.</p>	<p>Refill or replace the liquid detergent container. Prime the dosage system (see "Programming functions").</p>
		<p>Then:</p> <ul style="list-style-type: none"> – Switch the washer on. – Restart the program.

Frequently asked questions

What if...	Possible fault	Solution
<p>Before the start of a program, the "Neutralizer" indicator flashes, and the program can not be started.</p>		<p>Before addressing the error:</p> <ul style="list-style-type: none"> - Turn the program selector to . The error message is erased. - Press the On-Off button to switch off the machine.
	<p>Error message: Fdo: The neutralizer container is empty.</p>	<p>Refill or replace the neutralizer container.</p>
		<p>Then:</p> <ul style="list-style-type: none"> - Switch the washer on. - Restart the program.
<p>A few minutes after the start of a program, the "Neutralizer" indicator flashes, and the program stops.</p>		<p>Before addressing the error:</p> <ul style="list-style-type: none"> - Turn the program selector to . The error message is erased. - Press the On-Off button to switch off the machine.
	<p>Error message: Fdo: There is a problem dispensing the neutralizer.</p>	<p>Refill or replace the neutralizer container. Prime the dosage system (see "Programming functions").</p>
		<p>Then:</p> <ul style="list-style-type: none"> - Switch the washer on. - Restart the program.

Frequently asked questions

What if...	Possible fault	Solution
The "Recharge" indicator flashes.	The water softener has run out of salt.	Refill the salt reservoir.
A few minutes after the start of a program, the "Fill/Drain" indicator flashes, and the program stops.		<p>Before addressing the error:</p> <ul style="list-style-type: none"> – Turn the program selector to . The error message is erased. – Press the On-Off button to switch off the machine.
	<p>Error message: F..E: There is a problem with the water intake.</p>	<ul style="list-style-type: none"> – Open the water valve completely. – Clean the water inlet filters. – The flow pressure at the water connection is too low. Contact a qualified plumber for advice.
		<p>Then:</p> <ul style="list-style-type: none"> – Switch the washer on. – Restart the program.

Frequently asked questions

What if...	Possible fault	Solution
<p>The rinse program is interrupted and the "Fill/Drain" indicator light is flashing.</p>		<p>Before addressing the error:</p> <ul style="list-style-type: none"> - Turn the program selector to . The error message is erased. - Press the On/Off button to switch off the machine.
	<p>Error message: F..A: There is a problem with the water out take.</p>	<ul style="list-style-type: none"> - Clean the filter combination in the wash cabinet. - Clean the drain pump. - Clean the non-return valve. - Remove any kinks in the drain hose.
		<p>Then:</p> <ul style="list-style-type: none"> - Switch the washer on. - Drain the water. - Restart the program.
<p>The water in the wash cabinet does not get hot; the program sequence lasts too long.</p>	<p>Error message: <i>F01 - F03, F18, F19, F27</i> The washer is equipped with a temperature sensor that switches off the heater when it begins to overheat. Overheating can occur when, e.g., large items cover the heating elements, or when the filters in the wash cabinet are blocked.</p>	<ul style="list-style-type: none"> - Clean the filter combination in the wash cabinet. - Rearrange the glassware. - Reset the Thermo switch. See "Frequently asked questions - Thermo switch".

Frequently asked questions

What if...	Possible fault	Solution
After a program, there is powdered detergent residue left behind in the door dispenser.	The dispenser was wet when it was loaded.	Make sure the dispenser is dry before loading it.
	The powdered detergent dispenser cover was blocked by glassware.	Always arrange glassware so the dispenser cover can open.
The powdered detergent dispenser cover will not close.	Detergent residue is blocking the latch.	Wipe away any detergent residue.
A banging noise can be heard in the wash cabinet.	A spray arm is hitting the glassware.	Interrupt the program and re-arrange any glassware that it blocking the wash arm, (see "interrupting a program").
A rattling noise can be heard in the wash cabinet.	Glassware is moving around in the wash cabinet.	Interrupt the program and re-arrange any glassware that is loose, (see "interrupting a program").
A banging noise is coming from the water pipes.	This may be caused by the installation or the diameter of the pipes.	Consult a qualified plumber for advice.

Frequently asked questions

What if...	Possible fault	Solution
Items made of glass show signs of corrosion.	The items are not washer-safe.	Only use washer-safe glassware.
	No neutralization took place in the program sequence.	Fill the neutralizer container.
	Excessively high temperatures are causing glass corrosion.	Select an appropriate program or lower the wash temperature.
	Too alkaline detergent is causing glass corrosion.	Choose a milder detergent or lower the DOS1 concentration.
Items made of stainless steel show signs of corrosion.	The chloride content of the water is too high.	Test your water composition. If needed, condition the water externally and use DI water.
	The screw cap on the reactivation salt reservoir is not tightened.	Properly thread the cap and screw it tightly.
	No neutralization took place in the program sequence.	Fill the neutralizer container.
	Rust articles or a rust film appears in the wash cabinet, due to: <ul style="list-style-type: none"> – excessive iron content in the water, or – rusty items in the washer. 	<ul style="list-style-type: none"> – Check the piping. – Remove all rusty items from use.
	The grade of stainless steel is not washer-safe.	Only use high grade stainless steel.

Frequently asked questions

What if...	Possible fault	Solution
There are white deposits and/or spots on the labware.	The water softener setting is too low.	Test the tap water hardness and program the water softener according.
	Too much powder detergent is being used.	Be sure you are using the correct amount of detergent.
	The neutralizer is not dispensing properly.	Check the neutralizer dispenser.
	There is no reactivation salt in the reservoir.	Carefully fill the reservoir with the reactivation salt.
	The screw cap on the reactivation salt reservoir is not tightened.	Properly thread the cap and screw it tightly.
	The rinse water quality was insufficient.	<ul style="list-style-type: none"> – Use water with a lower conductivity. – If the washer is connected to a demineralizing cartridge, check the status and change as needed.

Frequently asked questions

What if...	Possible fault	Solution
The wash result is unacceptable.	The baskets and inserts were incorrectly loaded or overcrowded.	Properly arrange the glassware. Do not overload baskets and inserts.
	The program used was not suited to the type/amount of soiling.	Select an appropriate program or modify the program.
	The detergent used was not suited to the type/amount of soiling.	Use a suitable detergent for machine washing.
	The labware was left soiled for too long.	Do not leave soiled labware unwashed for more than 6 hours.
	A spray arm is blocked.	Arrange the items do not block the spray arms.
	Jets are blocked in the spray arms or inserts.	Check the spray jets and clean as needed.
	The basket or insert is not properly connected to the water supply.	Use the adapter to properly connect the water supply to the basket or insert.

Thermo switch

This machine has a resettable heater limiter which will shut off the elements in the event of over-heating. This could be caused for example, if large articles cover the heating elements or if the filters in the wash cabinet are blocked.

If the following fault shows: *F01 - F03, F18, F19, F27* (Water in the wash cabinet is not heated, the program cycle takes too long). Please proceed as follows.

- Remove the cause of the problem.
- Remove the service plinth.
- Press the reset button on the temperature sensor on the right side.

If this switch trips repeatedly, contact the Miele Technical Service Department.

After Sales Service

In the event of a fault which you cannot correct yourself please contact the Miele Technical Service Department

USA 1-800-991-9380
techserv@mieleusa.com

CDN 1-800-565-6435
service@miele.ca

- Please quote the model of your machine. This information can be found on the machine's front panel.

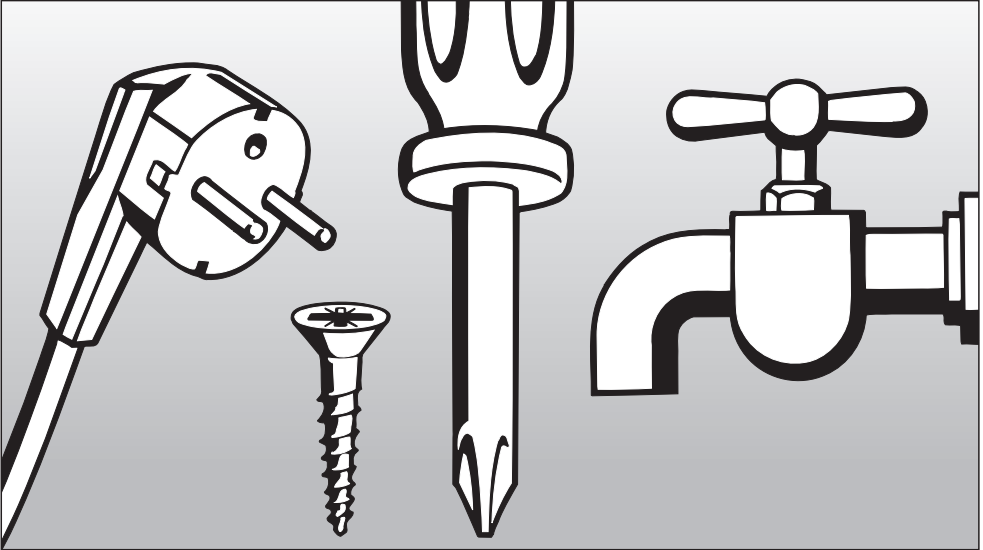

INSTALLATION INSTRUCTIONS

Installation

Please refer to the installation diagram supplied with the machine.

⚠ Furniture and fittings installed near the machine must be of a commercial standard, able to withstand the effects of steam.

Installation options

- **Free-standing**
- **Slot-in**, next to other machines or furniture or in a suitable space. The space must be at least $35 \frac{7}{16}$ " (90 cm) wide and $27 \frac{9}{16}$ " (70 cm) deep
- **Undercounter**

The machine can be installed under a continuous counter top or sink drain.

The niche must be at least:

Width $35 \frac{7}{16}$ " (90 cm)

Depth $29 \frac{7}{16}$ " (75 cm)

Height $32 \frac{5}{16}$ " (82 cm).

The lab washer can be built into a recess of $32 \frac{5}{16}$ " (82 cm) high by removing the lab washer top.

Leveling the legs

Any unevenness in the floor can be compensated for and the height of the machine raised or lowered by adjusting the four screw feet.

When the feet are screwed in, the machine can be moved back and forth on its rollers.

Positioning and securing the machine

To ensure stability, the machine must be aligned and screwed to the counter.

- Open the door.

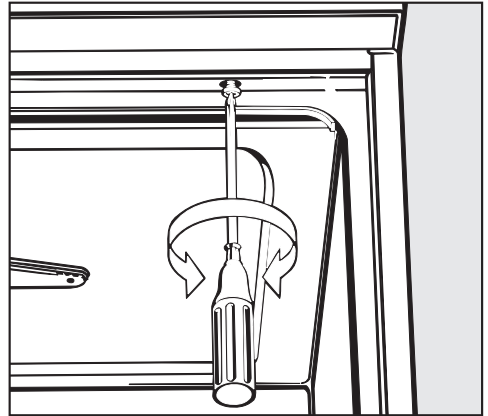

- Secure the machine to the front edge of the countertop using screws through each of the 2 holes in the front trim.
- When not mounted undercounter, floor mounting brackets must be used.

Do not use silicone sealant to seal the gaps between the machine and any neighboring units. This will hinder ventilation to the circulation pump.

Removing the lid (if necessary)

- Open the door.
- Remove the fixing screws on both sides using a cross slotted screwdriver.
- Pull the machine lid approx. 5 mm forwards, lift upwards and remove.

Protecting the countertop

Important for machines with steam condenser (depending on model):

To prevent steam damage to the countertop, adhere the protective foil $9 \frac{13}{16}'' \times 22 \frac{13}{16}''$ (25 x 58 cm) underneath the countertop near the steam condenser.

Depending on the requirements for installation, the following **kit** can be ordered from the Miele Technical Service Department.

Cover plate (protects the countertop)

The underside of the countertop is protected from steam damage by a stainless steel plate.

Electrical connection

 All electrical work must be carried out by a suitably qualified electrician in accordance with local and national safety regulations.

- Connection should be made via a suitable isolator, with an on-off switch that is easily accessible for servicing work.
- The electrical connection is made through a receptacle according to national requirements. The receptacle has to be easily accessible after installation.
- To increase the security it is recommended to install a protective switch (30 mA) before the machine.
- For technical data see the data plate or wiring diagram supplied.

The machine must only be operated with the voltage, frequency and fusing shown on the data plate.

The machine can be converted according to the supplied converting diagram and wiring diagram.

The data plate is located at the rear of the machine and behind the plinth on the plastic cover.

The wiring diagram is supplied with the machine.

See also the supplied installation diagram.

A damaged power cord must only be replaced with a genuine Miele cord by a Miele service technician.

WARNING
THIS APPLIANCE MUST BE GROUNDED

Grounding connection

- The ground lead must be connected to the screw connection point (marked with the ground symbol 8) at the back of the machine.

The machine must only be operated with the voltage, frequency and fusing shown on the data plate located on the rear of the machine, and on the plinth (behind the service panel).

The conversion diagram and the wiring diagram is secured to the inner side of the service panel.

Connecting the water inlet

 The water in the machine is not drinkable.

- The machine must be connected to the water supply in accordance with local and national regulations.
- The washer is constructed so it may be connected to a suitable supply without an extra non-return valve unless required by code.
- High iron content can leave a rust film on stainless steel labware and the machine itself.
When the chloride content in the domestic water supply is above 100mg/l, the risk of corrosion damage to stainless steel labware is greatly increased.
- In certain regions (e.g., mountainous areas) the water composition may cause condensate to form, requiring the use of softened water in the steam condenser.
- An acceptable water pressure (flow rate) is 10 - 147 psi. However, the recommended pressure is 25 - 60 psi.
If the water pressure is below 30 psi, the fill time will take longer.
If the "Fill/Drain" indicator fault code "F..E" lights, contact the Miele Technical Service Department.
- The maximum permissible static water pressure is 145 psi over pressure.
- If the water pressure lies outside these ranges, please contact Miele Technical Service for advice (the "Fill/Drain" indicator, may appear in the display "F E").
- The machine is designed for connection to cold water (blue marking) and hot water (red marking) up to 158°F (70°C) max.
Connect the water intake hoses to the cold and hot water faucets.
- If there is no hot water supply, the intake hose with the red marking must also be connected to the cold water supply.

Plumbing

- Connect the intake hose for the steam condenser (without water safeguard) to the cold water faucet.
- See the next page for how to connect the DI water line.
- Water valves with $\frac{3}{4}$ inch thread are to be provided on site. They should be easily accessible, because the water supply will need to be turned off when not in use.
- The inlet hoses are approx. 5 $\frac{1}{2}$ ft (1.7 m) long pressure hoses with $\frac{3}{4}$ inch thread. **Do not remove the water inlet filters in the threads.**
- Install the large surface area filters (in the kit supplied with the machine) between the water valve and the water inlet hose (see illustration in "Cleaning the water inlet filters"). The large surface area filter for distilled water is made of stainless steel and can be recognized by the matte surface.

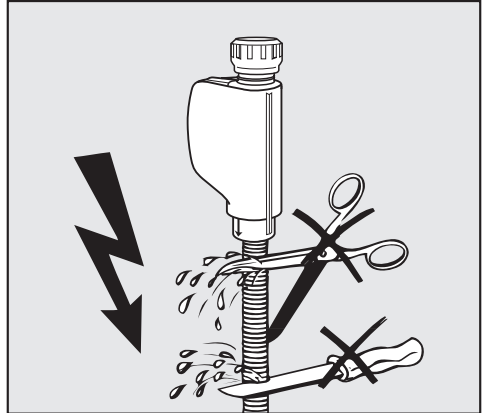

Do not cut or damage the inlet hose in any way.

Please also refer to the installation diagram.

DI Connection (pressurized)

The machine comes factory standard for connection to a pressure resistant system. The recommended water pressure (flow rate) is 25 - 60 psi however, water pressure that is 10 - 147 psi is acceptable.

- The DI pressure tested hose (marked "H2O pure" with a 3/4" hose thread must be connected to the on-site water valve for DI purified water.

If the DI water connection is not used, the electronic needs to be reprogrammed by Miele Technical Service. The water intake hose remains at the rear side of the machine.

DI connection (unpressurized) (optional)

For connection to 1.23 - 8.7 psi the machine must be modified, if this has not done at the factory. If a feed pump is to be installed, this must only be done by Miele Technical Service.

The discharge port for any DI container (unpressurized) must be at least the height of the upper edge of the machine (see "Installation instructions").

Plumbing

Drainage

- The drainage system is fitted with a non-return valve which prevents dirty water from flowing back into the machine via the drain hose.
- The machine should preferably be connected to a **separate** drainage system onsite.
If separate drainage is not available contact Miele Technical Service for advice.
The onsite drain connection point should be located between 1 ft. (0.3 m) and 3 ft. (1 m) **above the lower edge of the machine.**
If it is lower than 1 ft. (0.3 m), lay the hose in a curve at a height of at least 1 ft. (0.3 m).
The drainage system must be able to take a minimum drainage flow of 16 l/min.
- The drain hose is approx. 5 ft. (1.5 m), is flexible and has an internal diameter of $\frac{7}{8}$ in. (22 mm). It must not be shortened. Hose clamps are supplied for securing it in position.
- A longer drain hose (up to 13 ft. [4 m]) is available to order from Miele.
- The drainage system must not exceed 13 ft. (4 meters).
- See the supplied installation diagram.

Technical data

	English	Metric
Height:		
with lid	33.5"	85 cm
without lid	32.3"	82 cm
Width:	35.4"	90 cm
Depth:	27.5"	70 cm
Depth with the door open:	49.8"	126.5 cm
Net weight:	265 lbs	120 kg
Voltage / Fuse:	see data plate	
Power cord	approx. 5.11 ft.	approx. 1.8 m
Water temperature:		
Cold water	max. 68°F	20 °C
Hot and DI water connection	max. 158° F	70 °C
Static water pressure	max. 145 psi (10 bar)	
Hot, Cold and DI Water Connection:		
Acceptable water pressure (flow rate)	10 - 147 psi	.7 - 10 bar
Recommended water pressure (flow rate)	25 - 60 psi	1.72 - 4.13 bar
DI Water Connection (pressureless)		
optional	1.23 - 8.70 psi	.09 - .6 bar
Delivery head:	min. 1 ft. (0.3 m), max. 3.3 ft. (1 m)	
Surrounding temperature:	from 40°F (5°C) to 104°F (40°C)	
Max. relative humidity	80% for temperature up to 88°F (31°C)	
Linear reduction up to	50% for temperature up to 104°F (40°C)	
Height above sea level:	up to 1640 yds	1500 m
Noise level in dB (A):		
Sound pressure level LpA during washing and drying	<70	
Test marks:	CSA	
CE-mark:	MPG-Guidelines 93/42/EWG, Class IIa	

Caring for the environment

Disposal of the packing materials

The cardboard box and packing materials protect the appliance during shipping. They have been designed to be biodegradable and recyclable.

Ensure that any plastic wrappings, bags, etc. are disposed of safely and kept out of the reach of children.

Danger of suffocation! Please recycle.

Disposal of an old appliance

Old appliances may contain materials that can be recycled. Please contact your local authorities about recycling in your area.

Ensure that the appliance presents no danger to children while being stored for disposal. See "Important Safety Instructions".

**Please have the model and serial number
of your appliance available before
contacting Technical Service.**



**U.S.A.
Miele, Inc.**

National Headquarters

9 Independence Way
Princeton, NJ 08540

Phone: 800-991-9380
609-419-9898

Fax: 609-419-4241

www.miele.com

**Technical Service & Support
Nationwide**

Phone: 800-991-9380

Fax: 888-586-8056

TechnicalService@mieleusa.com

**Canada
Miele Limited**

National Headquarters

161 Four Valley Drive
Vaughan, ON L4K 4V8

Phone: 800-643-5381
905-660-9936

Fax: 905-532-2290

www.miele.ca

professional@miele.ca

MieleCare National Service

Phone: 800-565-6435

905-532-2272

Fax: 905-532-2292

service@miele.ca (technical enquiries)

Free Manuals Download Website

<http://myh66.com>

<http://usermanuals.us>

<http://www.somanuals.com>

<http://www.4manuals.cc>

<http://www.manual-lib.com>

<http://www.404manual.com>

<http://www.luxmanual.com>

<http://aubethermostatmanual.com>

Golf course search by state

<http://golfingnear.com>

Email search by domain

<http://emailbydomain.com>

Auto manuals search

<http://auto.somanuals.com>

TV manuals search

<http://tv.somanuals.com>