

# Operating instructions Commercial Dishwasher G 7859

---

It is **essential** to read these operating instructions before installing, commissioning or using the machine, to avoid the risk of accident or damage



M.-Nr. 05 339 030

# Contents

---

<b>Description of the machine</b> . . . . .	3
<b>Guide to the machine</b> . . . . .	4
<b>Warning and safety instructions</b> . . . . .	6
<b>Warning and Safety instructions</b> (detachable) . . . . .	Centre pages
<b>Caring for the environment</b> . . . . .	10
<b>Before using for the first time</b> . . . . .	11
<b>Opening and closing the door</b> . . . . .	12
<b>Water softener</b> . . . . .	13
Setting the water softener . . . . .	15
Filling the salt reservoir . . . . .	16
Salt indicator . . . . .	17
<b>Loading the machine</b> . . . . .	18
Adjusting the upper basket . . . . .	21
Items not suitable for dishwashers. . . . .	21
<b>Adding rinse aid</b> . . . . .	22
Setting the dosage . . . . .	24
<b>Adding cleaning agent</b> . . . . .	25
<b>Programme selection</b> . . . . .	27
<b>Programme chart</b> . . . . .	28
<b>Switching the machine on and off</b> . . . . .	30
Switching on. . . . .	30
Switching off. . . . .	31
Cancelling a programme . . . . .	32
<b>Programming special functions</b> . . . . .	33
<b>Cleaning and care</b> . . . . .	38
<b>Correcting minor faults</b> . . . . .	42
After Sales Service . . . . .	43
<b>Installation</b> . . . . .	44
<b>Electrical connection</b> . . . . .	46
<b>Plumbing</b> . . . . .	47
<b>Technical data</b> . . . . .	49

# Description of the machine

---

This Miele machine is a frontloading commercial dishwasher, with very short batch times especially suitable for use in restaurants, cafés, fast food outlets, boarding houses, etc.

It operates on the freshwater system and is equipped with a water softener and electro-thermal door lock as standard.

## **Optional extra**

- Steam condenser (DK)

# Guide to the machine

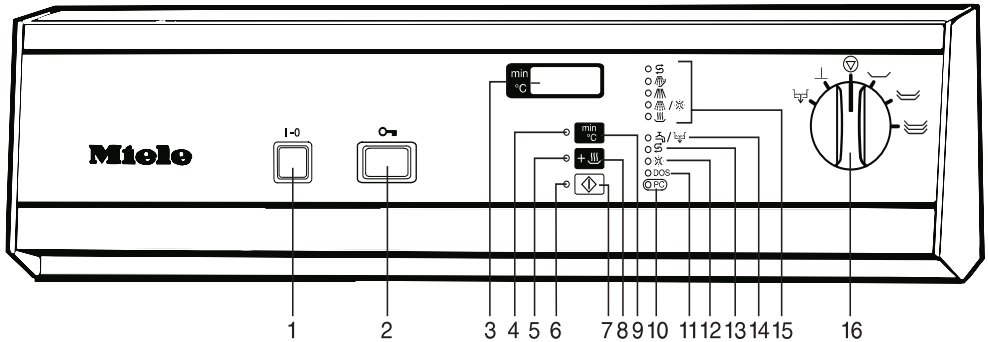

- |   |  |
|---|--|
| <ul style="list-style-type: none"> <li>1 On/Off button (I-O)</li> <li>2 Door release</li> <li>3 Display field</li> <li>4 “Delay start” indicator light<br/>(see “Programming special functions”)</li> <li>5 “Drying” indicator light</li> <li>6 “Programme start” indicator light</li> <li>7 Start button</li> <li>8 Drying button</li> <li>9 Switch to change display from<br/>“Actual temperature” to “Elapsed programme time”</li> </ul> | <ul style="list-style-type: none"> <li>10 Optical interface<br/>(for service technician)</li> <li>11 “Add (liquid) detergent”<br/>indicator light<br/>(only where special DOS module is<br/>connected externally)</li> <li>12 “Add rinse aid” indicator light</li> <li>13 “Reactivate water softener”<br/>indicator light</li> <li>14 “Check water inlet/outlet”<br/>indicator light</li> <li>15 Programme sequence indicators</li> <li>16 Programme selector</li> </ul> |
|---|--|

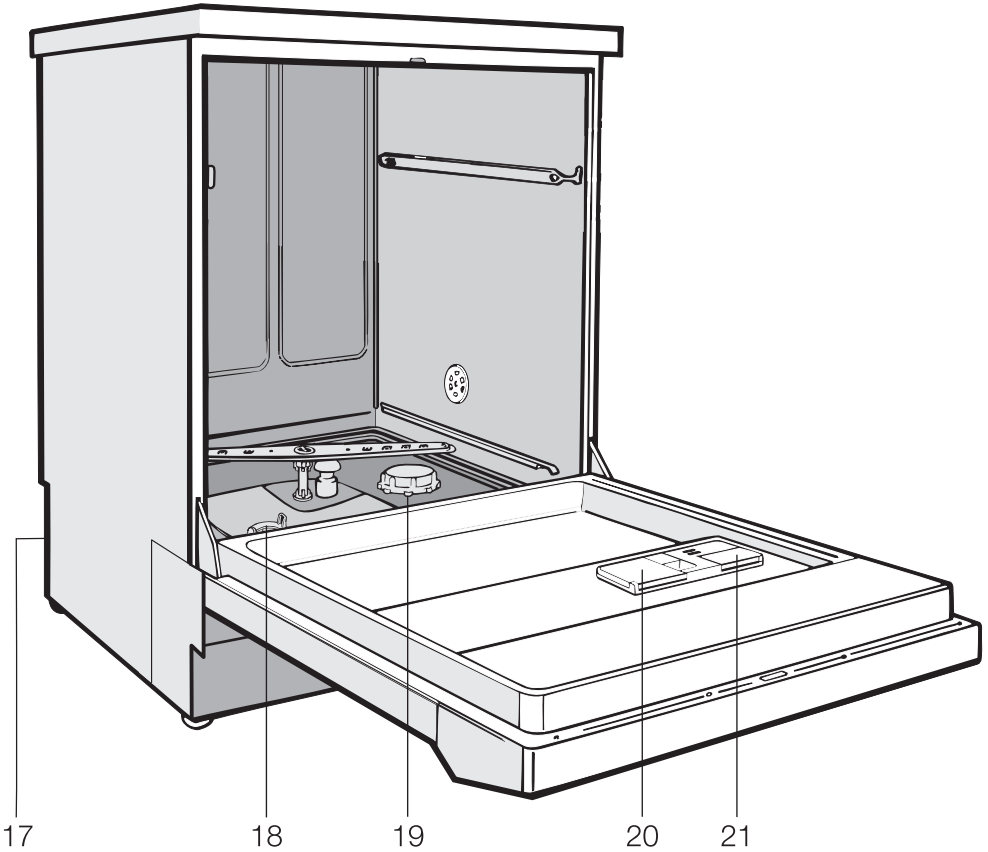

17 Connection for DOS dispenser module at the rear (Dispenser pump for liquid detergent)

18 Filter combination

19 Salt reservoir (Water softener)

20 Dispenser for powder detergent

21 Dispenser for rinse aid (with dosage selector)

# Warning and safety instructions

---

This machine conforms to current safety requirements. Inappropriate use can however lead to personal injury and damage to property. Read the operating instructions carefully before starting to use this machine. This way you will avoid the risk of accidents and damage to the machine.

Keep these instructions in a safe place, and make them available to future users.

## Appropriate usage

This machine is designed for commercial use and for specialised applications only, as described in these Operating Instructions. Using it for purposes other than those for which it was designed would be unauthorised and could cause harm.

The manufacturer cannot be held responsible for damage caused by improper use.

This equipment is not designed for maritime use or for use in mobile installations such as caravans, aircraft etc. However it may be suitable for such usage subject to a risk assessment of the installation being carried out by a suitably qualified engineer.

## The following notes are to help avoid personal injury

The machine should be commissioned and then maintained only by a Miele authorised and trained service technician or other suitably qualified and competent persons.

Do not install the machine in an area

where there is a danger of explosion or of freezing conditions.

The electrical safety of this machine can only be guaranteed when continuity is complete between the machine and an effective earthing system on site. It is imperative that this basic safety requirement is tested and, where there is any doubt, the electrical system checked out by a qualified electrician.

The manufacturer cannot be held responsible for damage or injury caused by missing or defective earthing, such as electric shock.

A damaged machine is dangerous. Switch off at the mains immediately and call the Miele Service Department or an authorised and trained Miele Service Dealer or other suitably qualified and competent person.

Repair work may only be carried out by an authorised Miele service technician or other suitably qualified and competent person. Repairs by unqualified persons could be dangerous.

Personnel operating the machine should be trained regularly. Children and untrained personnel should not be allowed access to the machine or its controls.

Do not allow children to play in or around the dishwasher, or to operate it. There is a danger they could get into the machine and lock themselves in.

# Warning and safety instructions

---

■ Take care when handling liquid agents/additives. These may contain irritant or corrosive ingredients. On no account use any organic solvent, as there may be the danger of an explosion occurring.

Follow the instructions and relevant safety procedures carefully. Wear protective gloves and goggles. With all chemical agents the manufacturer's safety instructions must be observed.

■ Avoid inhalation of powder detergents.

They can cause burning in the mouth and throat if swallowed, or inhibit breathing.

■ The water in the machine must not be used as drinking water.

■ Do not sit or lean on the open door. This could cause the machine to tip and be damaged.

■ Be careful when sorting sharp-pointed items. You may prefer to place cutlery with sharp points with the handles upwards to avoid possible injury.

■ When using this machine in the higher temperature ranges be especially careful not to scald or burn yourself. Baskets and inserts must first cool down. Any water which may remain in containers will be very hot and must be emptied into the wash cabinet.

■ Do not touch the heating elements during or directly after the end of a programme, you could burn yourself. They remain hot for a while after the end of a programme.

■ Never clean the machine or close vicinity with a water hose or a high pressure hose.

■ Before any maintenance or repair work is undertaken, the machine must be disconnected from the mains supply by switching off at the mains isolator or switching off the mains fuse.

## **The following notes should help to avoid material damage.**

■ Only use detergents formulated for special processes and approved by Miele for use with this machine. Use of unsuitable detergents could adversely affect the components of the machine as well as items being cleaned.

■ For pre-treatment and / or cleaning only use low-foaming detergents and disinfecting agents which have been approved by Miele. Foam can have an adverse effect on the disinfection and cleaning process.

# Warning and safety instructions

---

Where a chemical additive is recommended on technical grounds (e.g. with a cleaning agent), this does not imply that the manufacturer of the machine takes responsibility for the compatibility with the items being cleaned.

Please be aware that changes in formulation, storage conditions etc., which may not be publicised by the chemical producer, can have a negative effect on the cleaning result.

When using cleaning agents and specialised products, it is essential that the manufacturer's instructions are followed. Only use the product for the application described by the manufacturer, to avoid any material damage or the occurrence of strong chemical reactions.

The machine is designed only for operation with water and cleaning agents. Organic solvents must not be used in the machine, as there is the danger under certain circumstances of explosion. (Although this is not the case with all organic solvents, other problems could arise with their use, for example damage to rubber and synthetic materials).

In critical applications where very stringent requirements have to be met, it is strongly recommended that all the relevant factors for the process, such as cleaning agent, quality of water, etc. are discussed with the Miele Application Technology specialists.

If the cleaning result is subject to particularly stringent requirements (e.g. chemical analysis, specialised processes, etc.), a regular quality control test must be carried out by the user to ensure that required standards of cleanliness are being achieved.

The special inserts should only be used for their specific application.

Empty any containers or utensils before arranging them in the machine.

Do not allow any remains of acids or solvents, and in particular hydrochloric acid or chloride solutions to access the wash cabinet. Similarly avoid any materials with a corrosive effect. The presence in compounds of any solvents should be minimal, (especially those in hazard class A1).

Ensure that solutions or steam containing acid salts do not come into contact with the steel outer casing of the machine, to avoid any corrosion damage.

Please follow the advice on installation in these instructions and in the separate Installation Instructions.

In countries where there are areas which may be subject to infestation by cockroaches or other vermin, pay particular attention to keeping the appliance and its surroundings in a clean condition at all times. Any damage which may be caused by cockroaches or other vermin will not be covered by the appliance guarantee.



## Use of accessories

Only specific additional equipment, made by Miele should be connected to this machine. Consult Miele on the type and application of such equipment.

## Disposal of the old machine

When disposing of your old machine first make it unusable. Disconnect from the mains power supply, cut off the cable and any plug from the cable.

For environmental and safety reasons, ensure the machine is completely drained of any residue water and cleaning agent. (Observe safety regulations and wear safety goggles and gloves). Make the door lock inoperative, so that children cannot accidentally shut themselves in. Make appropriate arrangements for the safe disposal of the machine.

For tank system machines ensure that any water is emptied out of the tank.

The manufacturer cannot be held responsible for any damage caused through non-observance of these Warning and Safety instructions.

# Caring for the environment

---

## **Disposal of the packing material**

The transport and protective packing has been selected from materials which are environmentally friendly for disposal and can normally be recycled.

Rather than just throwing these materials away, please ensure they are offered for recycling.

## **Disposal of your old machine/appliance**

Old machines/appliances contain materials which can be reclaimed or recycled. Please contact your dealer, your waste collection centre or scrap merchant about potential recycling schemes.

Ensure that the machine/appliance presents no danger to children while being stored for disposal.

See the appropriate section in the Warning and Safety instructions.

# Before using for the first time

---

Before using for the first time please pay special attention to the following points:

Detailed information on these points can be found in the relevant section of the Operating Instructions.

## **Setting the water softener.**

The water softener unit must be set to deal with the water hardness level in your area.

The salt reservoir must also first be filled with water and then with dish-washer reactivation salt.

### Important

Filling the salt reservoir with detergent by mistake will cause serious damage to the water softener.

Please check every time before refilling that the package contains dishwasher reactivation salt.

## **Adding rinse aid.**

Inadvertently filling the reservoir for rinse aid with powder or liquid detergent, or washing up liquid, will cause serious damage to the reservoir.

## **Only use designated cleaning agents for special applications.**

Do not use detergents formulated for use in domestic dishwashers.

## **Loading the crockery correctly.**

Arrange the load so that water will come into contact with all the surfaces. This ensures that they will be properly cleaned.

The spray arms must not be blocked by any items.

## **Adding the correct amount of cleaning agent.**

Follow the detergent manufacturer's recommendations. Using less than advised can adversely affect cleaning results.

The amount dispensed will depend on the type of detergent used and the programme selected.

Read the notes on dosage given in the programme chart.

Cleaning results may vary from brand to brand. If you are not satisfied with the results from one brand, try another quality brand before contacting the Customer Service Department for advice.

## **The filter combination in the base of the wash cabinet and the spray arms must be kept clean.**

Regular checking and cleaning are essential.

# Opening and closing the door

## Electric door lock

The machine is equipped with an electric door lock.

The door can only be opened when:

- the machine is connected electrically
- the main switch **I-0** is on.



## To open the door

- Press the door button in fully and at the same time pull open the door.

Do not touch the heating elements if you open the door during or directly after the end of a programme. The heating elements remain hot for some time after the end of a programme.

## To close the door

- Lift the door upwards until it clicks into position. Do not push in the door release button as you do so.

The door is locked approx. 1.5 mins. after programme start, except in the programmes  (COLD),  (DRAIN) and during the drying phase (additional programme).

The door remains locked until the end of the programme, when it can be opened again.

## Cancelling a programme

If a programme has to be cancelled in extreme cases, e.g. when articles in the machine jostle against each other or the programme is interrupted with a fault indication, the door must be opened (deliberate intervention):

- Turn the programme selector switch to  (the programme is cancelled after approx. 2 secs.).

**Important:** Further procedures are described in the section “Switching on and off” under “Cancelling a programme”.

## Opening the door with the emergency release

The emergency release should only be used when the door cannot be opened normally (e.g. power failure).

- Turn the programme selector switch to .

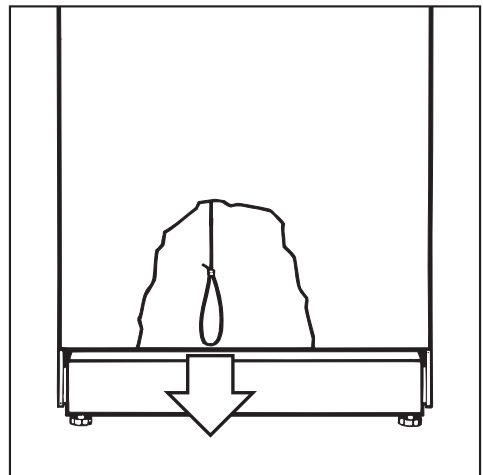

- Switch off the machine (**I-0** switch).
- Pull down the emergency release behind the door outer panel.

To avoid the build-up of calcium deposits on items being cleaned and in the machine the water needs to be softened.

To ensure a steady supply of soft water the water softener unit must always be:

1. correctly set (programmed) and
2. the salt reservoir must be filled.  
(If the water hardness level is below 70 mg/l (4°d) the water does not need to be softened.)

The machine is set at the factory for a water hardness level of 340 mg/l (19 °d).

If the water supply is harder or softer than this (including below 70 mg/l or 4°d) the factory setting will need to be changed following the instructions in the section "Setting the water softener". For settings, see chart on the next page.

Your local water authority will advise you on the water hardness in your area.

For fluctuating levels (e.g. 140 - 310 mg/l or 8 - 17°d) set the water softener to the highest setting (in this example to 310 mg/l or 17°d).

### Important

The built-in water softener has settings from 20 mg/l to 1080 mg/l or 1°d - 60°d.

For future servicing it is useful to make a note of your water hardness level.

- Enter details of your water hardness level here: \_\_\_\_\_ °d / mg/l

# Water softener

**Table of settings**









°d	mg/l	°f	Setting
1	20	2	<b>1</b>
2	40	4	<b>2</b>
3	50	5	<b>3</b>
4	70	7	<b>4</b>
5	90	9	<b>5</b>
6	110	11	<b>6</b>
7	130	13	<b>7</b>
8	140	14	<b>8</b>
9	160	16	<b>9</b>
10	180	18	<b>10</b>
11	200	20	<b>11</b>
12	220	22	<b>12</b>
13	230	23	<b>13</b>
14	250	25	<b>14</b>
15	270	27	<b>15</b>
16	290	29	<b>16</b>
17	310	31	<b>17</b>
18	320	32	<b>18</b>
<b>19 *)</b>	340	34	<b>19</b>
20	360	36	<b>20</b>
21	380	38	<b>21</b>
22	400	40	<b>22</b>
23	410	41	<b>23</b>
24	430	43	<b>24</b>
25	450	45	<b>25</b>
26	470	47	<b>26</b>
27	490	49	<b>27</b>
28	500	50	<b>28</b>
29	520	52	<b>29</b>
30	540	54	<b>30</b>
31	560	56	<b>31</b>
32	580	58	<b>32</b>
33	590	59	<b>33</b>
34	610	61	<b>34</b>
35	630	63	<b>35</b>
36	650	65	<b>36</b>
37	670	67	<b>37</b>
38	680	68	<b>38</b>
39	700	70	<b>39</b>
40	720	72	<b>40</b>
41	740	74	<b>41</b>
42	760	76	<b>42</b>
43	770	77	<b>43</b>
44	790	79	<b>44</b>
45	810	81	<b>45</b>

°d	mg/l	°f	Setting
46	830	83	<b>46</b>
47	850	85	<b>47</b>
48	860	86	<b>48</b>
49	880	88	<b>49</b>
50	900	90	<b>50</b>
51	920	92	<b>51</b>
52	940	94	<b>52</b>
53	950	95	<b>53</b>
54	970	97	<b>54</b>
55	990	99	<b>55</b>
56	1010	101	<b>56</b>
57	1030	103	<b>57</b>
58	1040	104	<b>58</b>
59	1060	106	<b>59</b>
60	1080	108	<b>60</b>

\*) factory setting

Machines without a water softener are set to "0" at the factory. This setting of "0" must not be changed on these machines.

## Setting the water softener

- Switch the machine off.
- Turn the programme selector to  “STOP”.
- Press  and  at the same time, hold them in and whilst doing so switch on the machine with the I-O main switch.  
The actual programme status “P...” appears in the display.  
The  /  indicator light illuminates.
- Press  once. “E01” (programme level 1) appears in the display.
- Turn the programme selector six switch positions to the right (6 o'clock position).  
The number “19” appears in the display (the factory water hardness setting in °d, equivalent to 340 mg/l).
- Press  as many times as is necessary, or hold it in until the required water hardness level appears in the display.  
The counter returns to “0” after reaching “60”.
- Press . “SP” is displayed.
- Press  once more. The setting will now be saved. The display clears.
- The machine is now ready for operation.

# Water softener

## Filling the salt reservoir

Please only use specialised reactivation salt, if possible coarse grained re-activation salt, with granules of approximately 1- 4 mm. Under no circumstances must other salts be used, e.g. table salt, or gritting salt. These could contain components which are insoluble in water which could result in damage to the water softener.

The salt reservoir holds about 2.5 kg of salt.

Inadvertently filling the salt reservoir with dishwasher detergent always causes serious damage to the water softener.

Make sure that you have picked up the right packet of re-activation salt before filling the salt reservoir.

Remove the bottom basket.

- Unscrew the salt reservoir cap.

Before filling the salt reservoir with salt for the first time, fill it with approx. 2.5 litres of water.

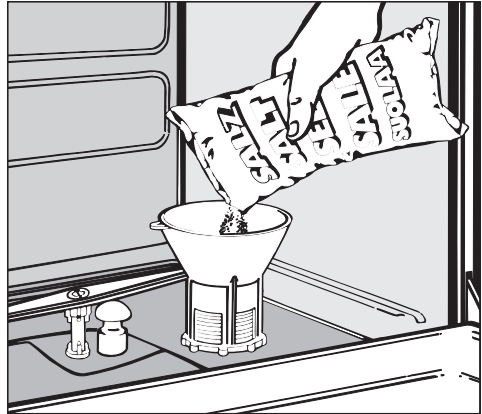

- Place the funnel provided in place.
- Fill carefully with salt, (as it is filled displaced water will run out).
- Clean salt from the screw threads of the socket.
- Screw the cap on firmly.
- Run the "COLD" programme immediately to remove any traces of salt water from the cabinet.

### Important:

If, after switching on, the immediately (COLD) programme start is delayed for a few minutes this is not a fault. The water softener is being reactivated.



## Salt indicator

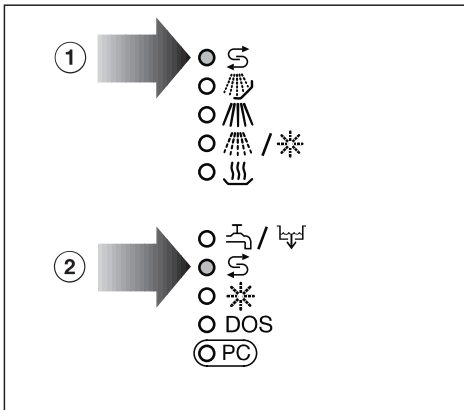

When the salt reservoir is empty the **S** indicator light ② comes on. The reservoir should be refilled with dishwasher salt for reactivation.

The reactivation programme runs automatically during a programme. The indicator light **S** ① on the programme sequence display lights up during this process.

# Loading the machine

---

## Loading the machine

### Preparation

- Empty all containers before loading into the machine.

Ensure that no acid or solvent residues, especially hydrochloric acid or chlorides access the wash cabinet.

### Notes

- Load items so that water will come into contact with all surfaces. This ensures that they will be properly cleaned.
- Do not place items to be cleaned inside other pieces where they may be concealed.
- Hollow vessels such as cups, glasses, pots etc. should be inverted and placed in the correct inserts.
- Deep based items should be placed at an angle to ensure that water runs freely off them.
- Tall, narrow, hollow pieces should be placed in the centre of the basket to ensure good coverage of water.
- Small pieces should be placed on the cup racks in the upper basket. Do not obscure them by larger items below. Cups should be on the lower rack and bowls on the top rack so that water reaches all pieces.

- The water duct for the spray arm in the middle of the upper basket must not be covered.
- The spray arms must not be blocked by items which are too tall or which hang down in their path. If necessary, manually rotate the arms to test.

### Use the upper basket for:

- small, lightweight, delicate items such as cups, saucers, glasses, dessert bowls etc. as well as for lightweight thermally stable plastic items.

### Use the bottom basket for:

- larger and heavier items such as plates, serving platters, saucepans, bowls etc. Glasses may only be cleaned in the bottom basket if it is fitted with a special glassware insert or if there is a special bottom basket.

### Cutlery

- Unsorted cutlery should be placed in the cutlery holders with the handles facing downwards.

Select baskets and inserts which are appropriate for the application.

### See examples on the following pages

# Loading the machine

## Loading examples:

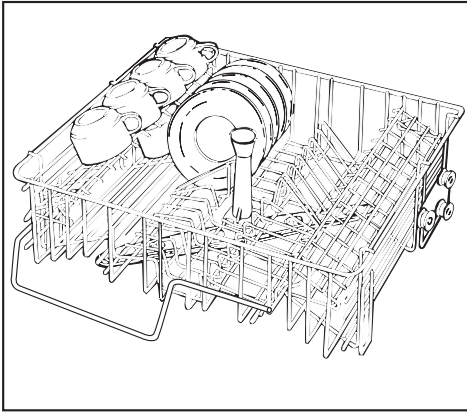

### O 881 upper basket

for 20 cups, 24 saucers or 12 dessert plates.

## Individual upper and lower baskets

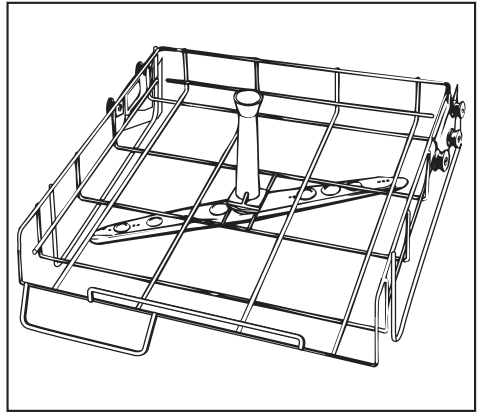

### O 889 upper basket, open front

for various inserts, e.g. containers for cutlery and glasses.

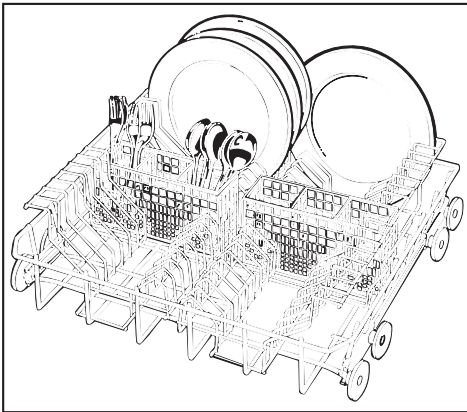

### U 880 lower basket

with 2 x E 216 half inserts each for 15 plates Ø 240 mm and 2 x E 165 cutlery baskets for various items of cutlery.

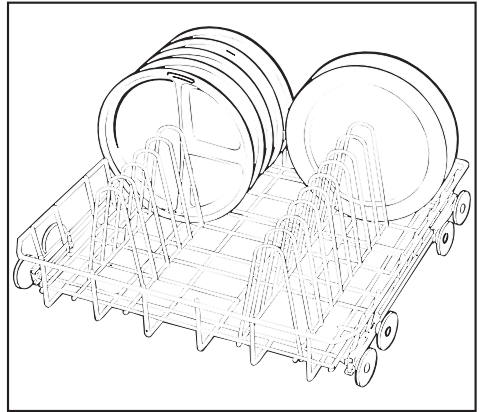

### U 880 lower basket

with E 884 insert 1/1 for 20 large plates or 10 trays.

# Loading the machine

---

## Glassware set GG/F-GL

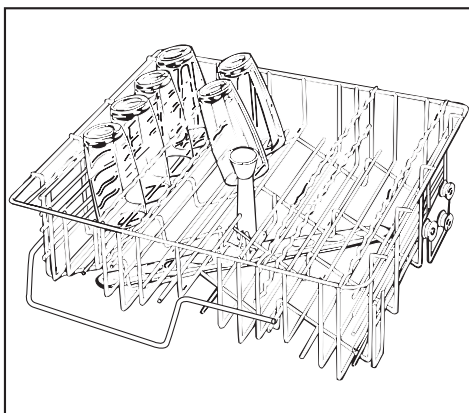

### **O 882 upper basket**

for 27 glasses Ø 65 mm.

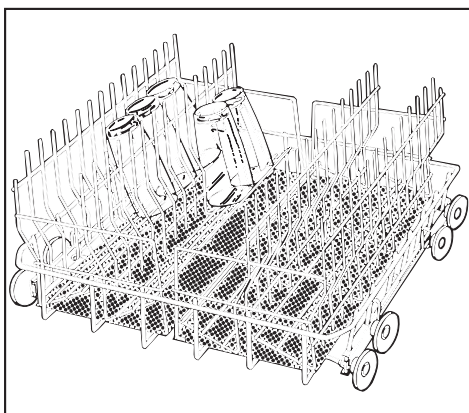

### **U 880 lower basket**

with 2 x E 205 half inserts each for  
14 glasses Ø 65 mm.

## Adjusting the upper basket

The upper basket can be adjusted above and below the middle position by 2.5 cm. It is set in the middle position on delivery.

Depending on the position of the upper basket plates of the following diameter can be accommodated in the baskets:

### Example: Upper basket O 881

Upper basket position	Upper basket plate Ø cm	Bottom basket plate Ø cm
top	max. 16.5	24 *)
middle	max. 19	24 *)
bottom	max. 21.5	24 *)

\*) in insert E 216. For plates up to Ø 30 cm use insert E 888.

### To adjust the upper basket:

- Pull the upper basket out until a resistance is felt, lift from the runners and remove.
- Unscrew the knurled nuts (roller bearings) on both sides of the basket with a spanner and reposition as required.

## Items not suitable for dishwashers

- Cutlery with wooden or horn handles.
- Wooden or laminated cutting boards.
- Glued items, e.g. old knives with handles which have been glued on.
- Hand-made craft items.
- Copper or tin items.
- Plastic items which are not heat resistant.

### Please note

- Silver and aluminium items can suffer some discolouration.
- Colours painted over a glaze may fade after a number of washes.
- Clouding may occur on glasses after frequent washing.

### Our recommendations

- Wash delicate glassware by hand.
- When purchasing new glasses, dishes and cutlery make sure they are dishwasher-proof.

## Adding rinse aid

Rinse aid is necessary to ensure that water does not cling and leave marks on utensils during the drying phase. Rinse aid is poured into the storage reservoir and the amount set is dispensed automatically in the final rinse. The rinse aid reservoir holds approx. 125 ml.

Inadvertently filling the rinse aid reservoir with powder detergent (or liquid detergent) always causes serious damage to the reservoir. Only use rinse aid formulated for this machine.

### Adding rinse aid

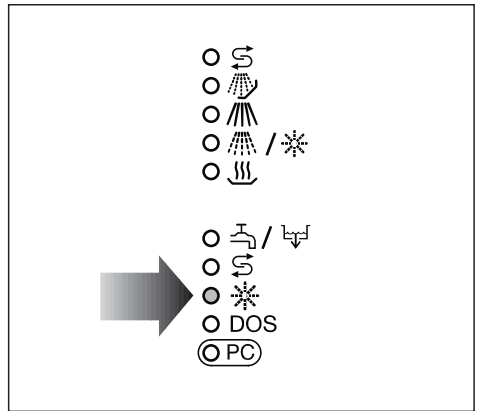

If the indicator light \* “Add rinse aid” on the control panel comes on, the rinse aid reservoir must be refilled.

- Open the door fully.

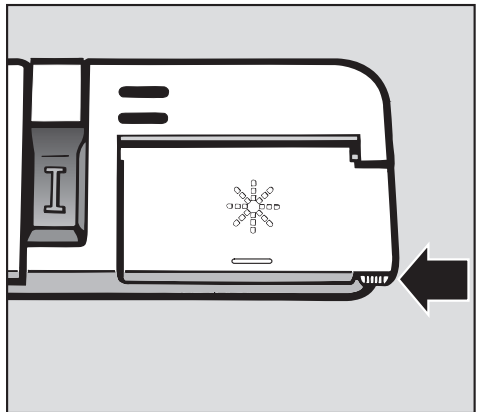

- Press the button in the direction of the arrow until the flap springs open.

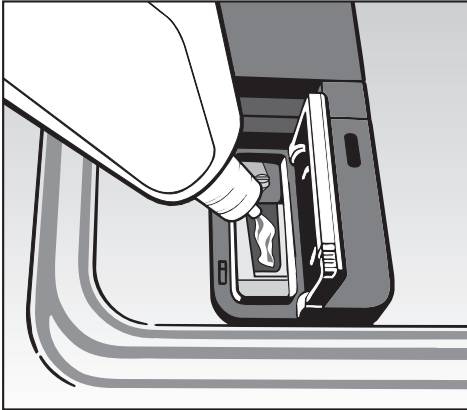

- Add rinse aid only until the surface is visible in the opening.
- Close the flap firmly. The flap must audibly engage, otherwise water could get into the rinse aid reservoir during the programme.
- Mop up any spilt rinse aid. This prevents over-foaming occurring during the next programme.

The flap should always remain closed. Only open it to add more rinse aid.

- Wait until the rinse aid indicator light ✱ on the control panel lights up again before adding any more rinse aid.

# Adding rinse aid

---

## Setting the dosage

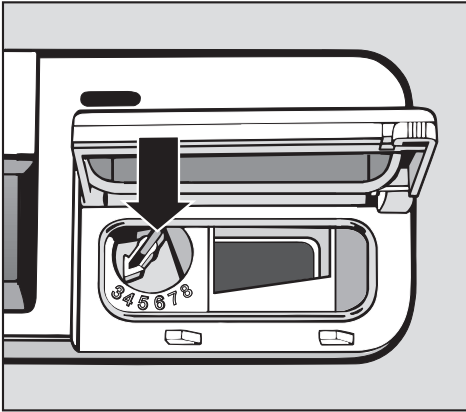

The dosage adjuster (see arrow) in the opening has settings adjustable from 1 to 6 (1-6 ml). It is set to “3” (3 ml) at the factory as the recommended dose.

- If there are flecks on utensils after drying use a higher setting.
- If clouding or smearing occurs on utensils after drying use a lower setting.



## Adding cleaning agent

Only use cleaning agents formulated for specialist machines. Do not use detergents formulated for domestic dishwashers.

Powder cleaning agent is dispensed via the dispenser for powder cleaning agents in the door or liquid cleaning agent via the DOS module (available as an optional extra - see "Note" on the next page).

If liquid cleaning agent is not being used then, powder cleaning agent must be placed in the detergent container prior to every programme (except PRE-RINSE) (see also the note in the "Programme chart").

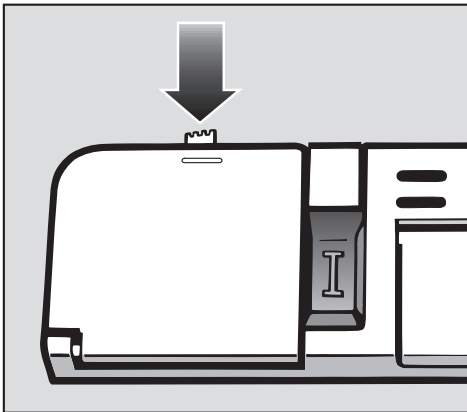

- Press the opening catch on the container flap (see arrow) forwards. The flap will spring open. (The flap is always open at the end of a programme).

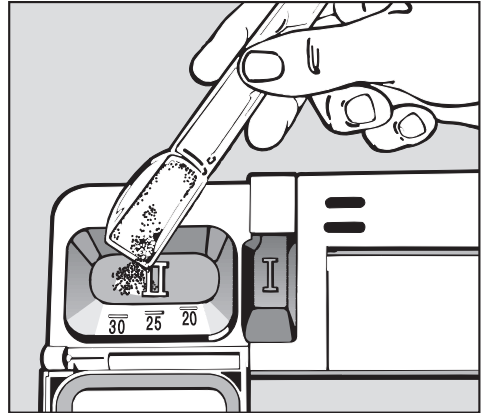

- Add powder cleaning agent to compartment II.

Dosage: approx. 3 g/l, corresponding to approx. 20 g per cleaning stage. During the "Cleaning (main wash)" stage approx. 7 litres of water are used.

Follow manufacturer's instructions if they differ.

- Close the dispenser lid.

Under certain circumstances, i.e. special soiling, different combinations of cleaning agents and other additives may be necessary. The Miele Professional Department (Applications Technology) will be pleased to advise you.

# Adding cleaning agent

---

## Note

As a chargeable optional extra this machine can also be fitted with a "dispenser pump for liquid cleaning agent" (DOS module G 60). This is connected externally.

See "Programming special functions" for information on venting the dispensing system and setting the dosage.

See separate instructions for "Installation and connection of the optional DOS module"

## Dispensing system maintenance

To ensure safe functioning, maintenance work should be carried out at specified intervals.

The work should only be carried out by a Miele authorised and trained service technician or other suitably qualified and competent person.

### Every 1 - 1 1/2 years

Exchange the hoses in the dispensing systems / DOS modules.

Take great care when handling liquid agents. They may contain acids or caustic substances. Please follow the safety instructions. Wear protective goggles and gloves if necessary.

**To the person responsible for this machine:**

- Make this pull-out with the Warning and Safety instructions available to any operators of the machine. Place it near the machine, where it can be seen and not removed.
- Ensure that operators know and understand these Warning and Safety instructions, and observe them in use.

This machine conforms to current safety requirements. Inappropriate use can however lead to personal injury and damage to property. Read the operating instructions carefully before starting to use this machine. This way you will avoid the risk of accidents and damage to the machine. Keep these instructions in a safe place, and make them available to future users.

**Appropriate usage**

■ This machine is designed for commercial use and for specialised applications only, as described in these Operating Instructions. Using it for purposes other than those for which it was designed would be unauthorised and could cause harm.

The manufacturer cannot be held responsible for damage caused by improper use.

■ This equipment is not designed for maritime use or for use in mobile installations such as caravans, aircraft etc. However it may be suitable for such usage subject to a risk assessment of the installation being carried out by a suitably qualified engineer.

**The following notes are to help avoid personal injury**

- The machine should be commissioned and then maintained only by a Miele authorised and trained service technician or other suitably qualified and competent person.
- Do not install the machine in an area where there is a danger of explosion or of freezing conditions.
- The electrical safety of this machine can only be guaranteed when continuity is complete between the machine and an effective earthing system on site. It is imperative that this basic safety requirement is tested and where there is any doubt, the electrical system is checked out by a qualified electrician.  
The manufacturer cannot be held responsible for damage or injury caused by missing or defective earthing, such as electric shock.
- A damaged machine is dangerous. Switch off at the mains immediately and call the Miele Service Department or an authorised and trained Miele Service Dealer or other suitably qualified and competent person.



# Warning and Safety instructions

---

Repair work may only be carried out by an authorised Miele service technician or other suitably qualified and competent person. Repairs by unqualified persons could be dangerous.

Personnel operating the machine should be trained regularly. Children and untrained personnel should not be allowed access to the machine or its controls.

Do not allow children to play in or around the dishwasher, or to operate it. There is a danger they could get into the machine and lock themselves in.

Take care when handling liquid agents/additives. These may contain irritant or corrosive ingredients. On no account use any organic solvent, as there may be the danger of an explosion occurring.

Follow the instructions and relevant safety procedures carefully. Wear protective gloves and goggles. With all chemical agents the manufacturer's safety instructions must be observed.

Avoid inhalation of powder detergents. They can cause burning in the mouth and throat if swallowed, or inhibit breathing.

The water in the machine must not be used as drinking water.

Do not sit or lean on the open door. This could cause the machine to tip and be damaged.

Be careful when sorting sharp-pointed items. You may prefer to place cutlery with sharp points with the handles upwards to avoid possible injury.

When using this machine in the higher temperature ranges be especially careful not to scald or burn yourself. Baskets and inserts must first cool down. Any water which may remain in containers will be very hot and must be emptied into the wash cabinet.

Do not touch the heating elements during or directly after the end of a programme, you could burn yourself. They remain hot for a while after the end of a programme.

Never clean the machine or close vicinity with a water hose or a high pressure hose.

Before any maintenance or repair work is undertaken, the machine must be disconnected from the mains supply by switching off at the mains isolator or switching off the mains fuse.

# Warning and Safety instructions

---

## The following notes should help to avoid material damage.

Only use detergents formulated for special processes and approved by Miele for use with this machine. Use of unsuitable detergents could adversely affect the components of the machine as well as items being cleaned.

For pre-treatment and / or cleaning only use low-foaming detergents and disinfecting agents which have been approved by Miele. Foam can have an adverse effect on the disinfection and cleaning process.

Where a chemical additive is recommended on technical grounds (e.g. with a cleaning agent), this does not imply that the manufacturer of the machine takes responsibility for the compatibility with the items being cleaned.

Please be aware that changes in formulation, storage conditions etc., which may not be publicised by the chemical producer, can have a negative effect on the cleaning result.

When using cleaning agents and specialised products, it is essential that the manufacturer's instructions are followed. Only use the product for the application described by the manufacturer, to avoid any material damage or the occurrence of strong chemical reactions.

The machine is designed only for operation with water and cleaning agents. Organic solvents must not be used in the machine, as there is the danger under certain circumstances of explosion. (Although this is not the case with all organic solvents, other problems could arise with their use, for example damage to rubber and synthetic materials).

In critical applications where very stringent requirements have to be met, it is strongly recommended that all the relevant factors for the process, such as cleaning agent, quality of water, etc. are discussed with the Miele Application Technology specialists.

If the cleaning result is subject to particularly stringent requirements (e.g. chemical analysis, specialised processes, etc.), a regular quality control test must be carried out by the user to ensure that required standards of cleanliness are being achieved.

The special inserts should only be used for their specific application.

Empty any containers or utensils before arranging them in the machine.

Do not allow any remains of acids or solvents, and in particular hydrochloric acid or chloride solutions to access the wash cabinet. Similarly avoid any materials with a corrosive effect. The presence in compounds of any solvents should be minimal, (especially those in hazard class A1).

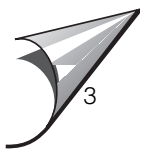

# Warning and Safety instructions

---

■ Ensure that solutions or steam containing acid salts do not come into contact with the steel outer casing of the machine, to avoid any corrosion damage.

■ Please follow the advice on installation in these instructions and in the separate Installation Instructions.

■ In countries where there are areas which may be subject to infestation by cockroaches or other vermin, pay particular attention to keeping the appliance and its surroundings in a clean condition at all times. Any damage which may be caused by cockroaches or other vermin will not be covered by the appliance guarantee.

## Use of accessories

■ Only specific additional equipment, made by Miele should be connected to this machine. Consult Miele on the type and application of such equipment.

## Disposal of the old machine

■ When disposing of your old machine first make it unusable. Disconnect from the mains power supply, cut off the cable and any plug from the cable.

For environmental and safety reasons, ensure the machine is completely drained of any residue water and cleaning agent. (Observe safety regulations and wear safety goggles and gloves). Make the door lock inoperative, so that children cannot accidentally shut themselves in. Make appropriate arrangements for the safe disposal of the machine.







For tank system machines ensure that any water is emptied out of the tank.

The manufacturer cannot be held responsible for any damage caused through non-observance of these Warning and Safety instructions.

Choose your programme according to the type of utensil being cleaned and the degree of soiling.

The different programmes and their uses are described overleaf in the **Programme chart**.

# Programme chart

Programme	When to use	Detergent (when not using liquid detergent)
		<b>Observe the manufacturer's instructions</b>
 COLD	To rinse heavily soiled items, (e.g. for removing soiling or to prevent soiling drying on to dishes when a full programme does not yet need to be run).	
 SHORT	"Quick programme" for lightly soiled crockery.	20 grammes in the powder dispenser
 UNIVERSAL	For normally soiled crockery.	20 grammes in the powder dispenser
 INTENSIVE	For heavily soiled crockery. The soiling is removed in an intensive cold water pre-rinse.	20 grammes in the powder dispenser
 DRAIN	For draining away cleaning water, e.g. when a programme has been interrupted. The programme selector must be at  "STOP".	



Programme sequence

1. Pre- liminary pre-wash	2. Pre-wash	3. Main wash	4. Economy Interim rinse	5. Interim rinse I	6. Interim rinse II <sup>2)</sup>	7. Final rinse	8. Drying phase (Extra prog.)
				X			
X		X 65°C/1' 1)			(X)	X 85°C/1' 1)	(X)
X		X 65°C/1' 1)		X	(X)	X 85°C/1' 1)	(X)
X	X	X 65°C/3' 1)		X	(X)	X 85°C/1' 1)	(X)

X = sections included in a programme (with temperature/temperature holding time)

<sup>1)</sup> To change a temperature or temperature holding time see "Programming special functions".

<sup>2)</sup> To select a second interim rinse II see "Programming special functions".

# Switching the machine on and off

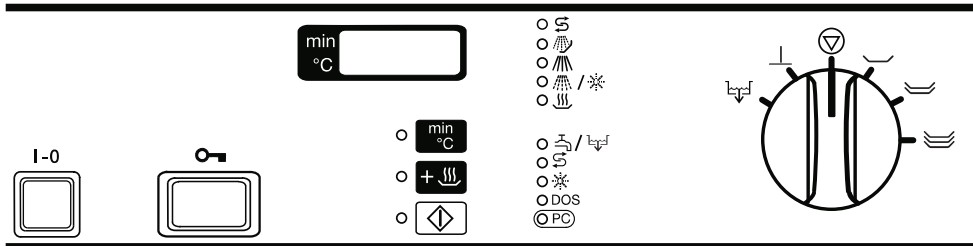





## Switching on

- Close the door.
- Open the stopcocks (if turned off) .
- Press the **I-0** button.

When the programme selector is at the  "STOP" position a point lights up in the display field.

## Starting the programme

- Turn the programme selector clockwise or anti-clockwise to the required programme.  
The wash temperature of the selected programme is shown in the display field, except with  (COLD) and  (DRAIN).
- Select additional function  (DRYING) if required, (see "Selecting an additional function").
- Press the  "Start" button. The display field will now show the actual temperature.  
The indicator light next to the "Start" button comes on.

Once the programme has started, all other programmes are blocked. If the programme selector is then turned to another programme, the values shown in the display field go out. The values can be seen again only if the programme selector is turned back to the position of the programme currently in operation.



- Press the  button to alternate the display between elapsed time and actual temperature.

Note that during the heat-up stage in "Main wash" and "Final rinse" the desired temperature is shown in the elapsed time display field.

# Switching the machine on and off



## Changing a programme

Provided the “Start” button has not yet been pressed, a wrongly selected programme may be changed as described below, (if it has been pressed see “Cancelling a programme”):

- Turn the programme selector to the required function.
- Select additional function  (DRYING) again if required (see “Selecting an additional function”).
- Press the “Start”  button.





## Selecting an additional function

The following additional function can be selected:

-  DRYING  
“Drying” may be selected as an additional function as soon as a programme has been selected (except with  “COLD RINSE” and  “DRAIN”). The drying phase operates with pulsed heating for 10 minutes. The total running time of the programme is lengthened accordingly.

## Programme sequence indicator

The indicator light for the active programme stage lights up during the programme.

-  Reactivation
-  Pre-rinse
-  Main wash
-  Interim rinse / Final rinse
-  Drying (additional function)

## Programme end

The programme has ended when no more programme sequence indicators are lit up and the “Start” indicator light  has gone out. An “0” is shown in the middle of the display field.

Use the  button to see how long a programme has to run or to see the actual temperature.

## Switching off

- Press in and release the **I-0** button.

### Note:



As the machine is fitted with an electric door lock, the door can only be opened if the **I-0** button is pressed in (see “Opening and closing the door”).

# Switching the machine on and off

---

## Cancelling a programme

Once a programme is running it should only be cancelled in extreme cases, e.g. when articles in the machine rattle or bump against each other and have to be rearranged.

- Turn the programme selector to the  position (the programme is cancelled after approx. 2 secs.).
- Open the door .

Take care! Water and items in the machine may be hot, there is a danger of scalding or burning.

- Replace the articles securely and correctly.  
(Wear protective gloves where necessary, and observe appropriate health and safety regulations relating to infectious diseases).
- Replenish (powder) detergent if necessary.
- Close the door.
- Select programme  (DRAIN), (wash water is pumped away).
- Select the cleaning programme again and start it as previously described.

# Programming special functions











In the event of a service call at a later date, any changes made to the factory setting should be documented here.

Make a note of any changes made in the "Value set: \_\_\_\_\_" box.

## 1. Setting the cold water inlet from: "Nominal water intake" to "Nominal water intake + 1 l".

The amount of water taken into the machine at each intake can be increased by 1 litre to a maximum of 9.5 litres.











Proceed as follows:

- Turn the programme selector to the  "STOP" position.
- Switch off the machine.
- Press  and  at the same time, hold them in and whilst doing so switch the machine on with the **I-0** button.  
The current programme status "P..." appears in the display.  
The  /  indicator light comes on.
- Press  once, "E01" (programming level 1) appears in the display.
- Turn the programme selector to the  position, "10" or "11" appears in the display.  
"10" = Nominal water intake  
"11" = Nominal water intake + 1 l
- Press  to change from "10" to "11" or vice versa.
- Press . "SP" appears in the display.
- Press  again. The change has been recorded.

Value set: \_\_\_\_\_

## 2. Selecting a second interim rinse

A second interim rinse can be programmed in to improve interim rinsing in all programmes (except  COLD).

- Turn the programme selector to the  "STOP" position.
- Switch off the machine.
- Press  and  at the same time, hold them in and whilst doing so switch the machine on with the **I-0** button.  
The current programme status "P..." appears in the display.  
The  /  indicator light comes on.
- Press  once, "E01" (programming level 1) appears in the display.
- Turn the programme selector to , "30" or "31" appears in the display.  
"30" = One interim rinse.  
"31" = Two interim rinses.
- Press  to change from "30" to "31" or vice versa.
- Press . "SP" appears in the display.
- Press  again. The change has been recorded.

Value set: \_\_\_\_\_

# Programming special functions







## 3. Delay start and setting the delay start time



The start of a wash programme can be delayed by up to 9 hours and 30 minutes in 30 minute stages.

### Note:

Delay start should only be selected with the Universal and Intensive programmes. Items in the machine stand for a longer period before being cleaned and residues can dry on if the start time is delayed. Delaying the start time in shorter programmes can impair cleaning results.

### a) To activate delay start

- Turn the programme selector to the  "STOP" position.
- Switch off the machine.
- Press  and  at the same time, hold them in and whilst doing so switch the machine on with the **I-O** button.  
The current programme status "P..." appears in the display.  
The  /  indicator light comes on.
- Press  once, "E01" (programming level 1) appears in the display.
- Turn the programme selector to the 8 o'clock position.  
"80" or "81" appears in the display.  
"80" = Delay start not selected.  
"81" = Delay start activated.
- Press  to change from "80" to "81" or vice versa.

- Press . "SP" appears in the display.
- Press  again. The change has been recorded.

Value set: \_\_\_\_\_

### b) Setting the delay start period







The delay start period (from 30 minutes to 9 hours and 30 minutes) must be set before a programme is started.

- After selecting a programme (see "Switching on"), press the  button or hold it in until the required value is displayed. The "Delay Start" indicator light comes on.



After the "Start" button  is pressed, the delay start period will count down in the display until the programme automatically starts.

# Programming special functions

## 4. Venting and setting the dosage on “DOS module G 60 or C 60” (special version)

- Set the dosage selector on the DOS module to the “10” position (on DOS module C 60 only).
- Turn the programme selector to the  “STOP” position.
- Switch off the machine.
- Press  and  at the same time, hold them in and whilst doing so switch the machine on with the **I-O** button.  
The current programme status “P...” appears in the display.  
The  /  indicator light comes on.
- Press  twice, “E02” (programming level 2) appears in the display.

### Venting the dispensing system:

- Turn the programme selector to the  position. “do1” appears in the display.
- Press  for 90 seconds.  
The dispensing system is vented.

If only venting is required:

- Switch the machine off with the **I-O** button.

Immediately after this: start the  (COLD) programme, so that after venting any agents in the wash cabinet are diluted before being drained away.

### Setting the dosage:

Set the amount to dispense according to the detergent manufacturer’s recommendations.



The machine needs 7 litres of water in the “Main wash” programme stage.

#### Example:



The detergent manufacturer recommends 4 ml cleaning agent per litre of water.

$$7 \text{ l} \times 4 \text{ ml/l} = 28 \text{ ml.}$$

2 ml  1 sec. dispensing time; i.e. programming to 14 secs.

- Turn the programme selector to the  position, the dispensing time in seconds appears in the display, e.g “10”.
- Press  repeatedly or hold it in, until the number “14” appears in the display (dispensing time 14 seconds  28 ml - see example).  
The dispensing time/amount is set.

### Having changed a value or all values:

- Press . “SP” appears in the display.
- Press  again. The change has been recorded.

Value set:

If the dispensing system also needs to be vented:

- Start the  (DRAIN) programme, so that after venting any agents in the wash cabinet are diluted before being drained away.





# Programming special functions







## 5. Altering the wash temperature and/or the temperature holding time in the “Main wash” and “Final rinse” programme stages

In the event of a service call-out, assist the service technician by making a note of any change to the wash temperature and / or the temperature holding time in the “Programme chart”.

Factory settings for the main wash temperature and temperature holding times and for the final rinse temperature and its holding time are given in the programme chart.

The main wash and final rinse temperatures can be set from 30°C - 70°C and the temperature holding time from 1 to 10 minutes.

- Turn the programme selector to the  “STOP” position (the programming level is displayed only in this switch position).
- Switch off the machine.
- Press  and  at the same time, hold them in and whilst doing so switch the machine on with the **I-0** button.  
The current programme status “P...” appears in the display.  
The  /  indicator light comes on.

- **“Main wash” temperature:**  
Press  three times, “E03” (programming level 3) appears in the display.
- Turn the programme selector to the programme which needs to be changed. The actual value appears in the display after **°C**.
- Press  or hold it in, until the required value appears in the display.
- **“Main wash” temperature holding time:**  
Turn the programme selector to the  “STOP” position (the programming level is only displayed in this switch position).
- Press  again, “E04” (programming level 4) appears in the display. Then:
- Turn the programme selector back to the programme which needs to be changed. The actual value appears in the display after **min**.
- Press  until the required value appears in the display.
- **“Final rinse” temperature:**  
Turn the programme selector to the  “STOP” position (the programming level is displayed only in this switch position).
- Press  again, “E05” (programming level 5) appears in the display. Then:





# Programming special functions

- Turn the programme selector back to the programme which needs to be changed. The actual value appears in the display after **°C**.

- Press  or hold it in, until the required value appears in the display.

## ■ “Final rinse” temperature holding time:



Turn the programme selector to the  “STOP” position (the programming level is only displayed in this switch position).

- Press  again, “E06” (programming level 6) appears in the display. Then:

- Turn the programme selector back to the programme which needs to be changed. The actual value appears in the display after **min**.

- Press  until the required value appears in the display.





## ■ Having changed a value or all values:

- Press . “SP” appears in the display.
- Press  again. The change has been recorded.

## 6. Re-setting all changes back to the factory setting.

- Turn the programme selector to the  “STOP” position.

- Switch off the machine.

- Press  and  at the same time, hold them in and whilst doing so switch the machine on with the **I-0** button.  
The current programme status “P...” appears in the display.  
The  /  indicator light comes on.

- Press  seven times, “E07” (programming level 7) appears in the display.

- Turn the programme selector to any setting (except “STOP”).  
“00” or “PP” appears in the display.  
“00” = factory setting  
(the electronic unit has not been re-programmed).  
“PP” = the electronic unit has been reprogrammed.

- If “PP” is displayed, press  to change from “PP” to “00”.

- Press . “SP” appears in the display.

- Press  again. Values which had been changed are now reset.

### Important

If the hardness level setting in the water softener had been changed this will reset to the factory setting of 340 mg/l (19 °d). This will need to be reset to suit the hardness level in your area.

# Cleaning and care

## Cleaning the filters in the wash cabinet

The machine must not be used without all the filters in place.

The filter combination in the base of the wash cabinet should be inspected regularly and cleaned if necessary.

### Caution:

Watch out for glass splinters which could cause injury.

### Cleaning the coarse filter

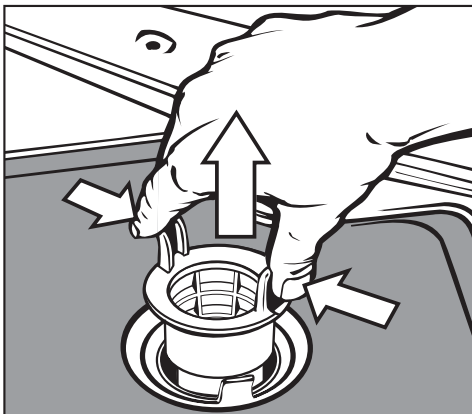

- Press the two lugs together, remove and clean the filter.
- Put the clean filter back in position and press it until it clicks into place.

### Cleaning the flat and the micro-fine filters

- Remove the coarse filter.

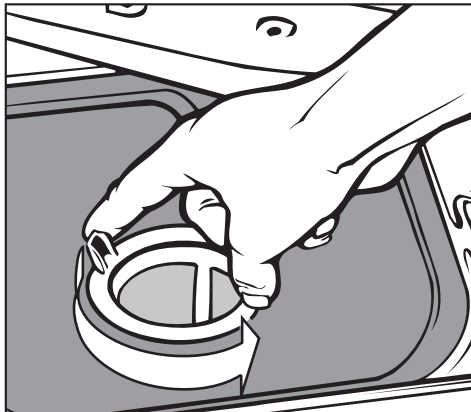

- To unscrew the micro-fine filter, take hold of the two lugs and turn twice in an anti-clockwise direction,

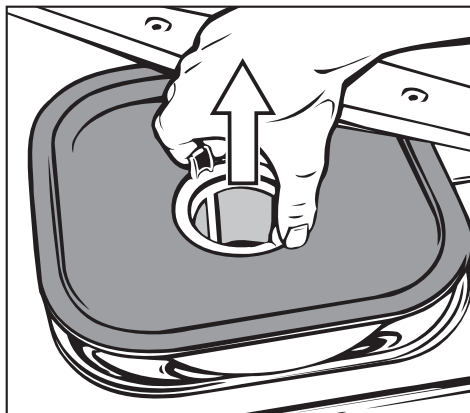

- and remove, together with the flat filter.
- Clean the filters.
- The filter combination is then replaced in the reverse order in which it was removed.

## Cleaning the spray arms

Waste particles can lodge in the spray arm jets.

The spray arms should be inspected and cleaned regularly (approx. every 6 months).

- Use a sharp pointed object to push particles into the spray arm jets and rinse well under running water.

Remove the spray arms as follows:

- Unscrew the **upper** spray arm.
- Remove the **middle** spray arm (on the top basket) by unscrewing the knurled nut.

Important:

The knurled nut has a left-hand thread, and to unscrew it it must be turned clockwise with the spray arm.

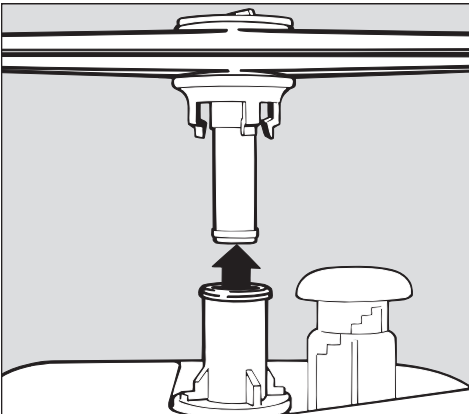

- Take off the **lower** spray arm. The lower basket must be removed first.

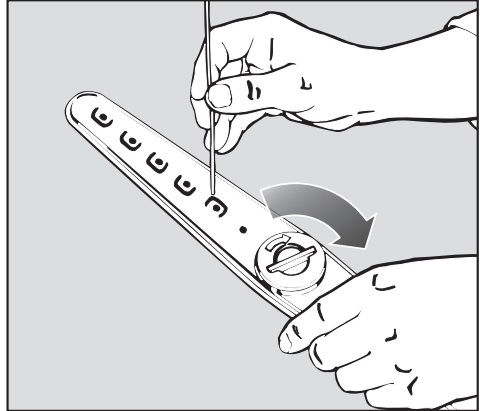

Particles in the lower spray arm are easier to rinse out if the cap is first opened.

- Open the cap in the direction of the arrow. After cleaning, close up the cap again.

Important:

After replacing the spray arms, check that they move freely.

# Cleaning and care

## Cleaning the drain pump and non-return valve

If water has not been pumped away at the end of a programme the drain pump or the non-return valve might be blocked. They are, however, easy to clean.

- Take the filter combination out of the wash cabinet.

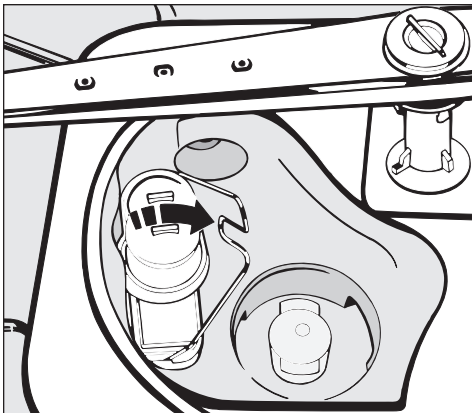

- Release the locking clamp.
- Lift up the non-return valve and rinse under running water.

The drain pump is situated under the non-return valve (see arrow).

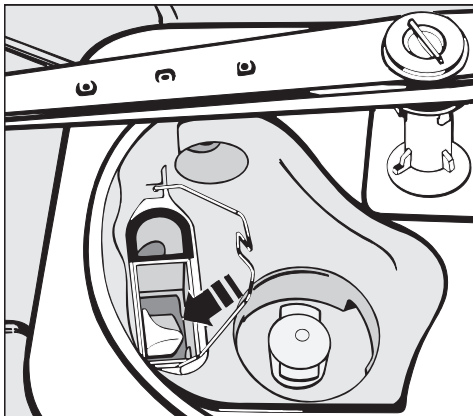

- Before replacing the non-return valve, check that the drain pump is free of extraneous objects.
- Carefully replace the non-return valve and secure with the locking clamp.

## Cleaning the filters in the water inlet

For the protection of the inlet valve, filters are incorporated in the screw connection of the water inlet hose. The filters must be cleaned when dirty, otherwise insufficient water flows into the wash cabinet.

The plastic housing of the water connection contains an electrical component. It must not be immersed in water.

### To clean the filters

- Disconnect the machine from the mains supply (switch off at the main socket and pull out the plug, switch off the appropriate circuit at the fuse box or switch off the mains fuse).
- Turn off the stopcock and unscrew the water inlet hose.

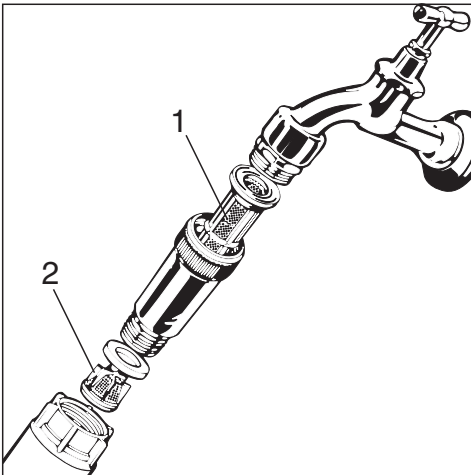

- Clean the large area filter (1) and the fine filter (2) or replace if necessary.

- Replace filter and seal. Make sure they are sitting correctly.
- Screw back into place on the water inlet, taking care that the connection goes back on straight.
- Open the stopcock carefully. If there is a leak, screw the connections on more tightly.

## Cleaning the fascia panel

- This should only be cleaned with a damp cloth or a suitable cleaner for use on plastic materials, or with a disinfectant tested and recognised as suitable for this use.

Do not use an abrasive cleaner, a glass cleaner or an all-purpose cleaner. Because of their chemical composition they could cause serious damage to plastic surfaces.

## Cleaning the front of the machine

- Clean using a suitable proprietary cleaning agent.

Do not use any cleaner containing ammonia or thinners.

# Correcting minor faults

---

With the aid of the following explanatory notes, minor faults can be corrected without contacting the Miele Service Dept.

Any work on the electrical components of the machine should only be carried out by a suitably qualified and competent person in accordance with local and national safety regulations. Unauthorised repairs could be dangerous.

## Faults / possible causes

### The machine does not start

- the door is not properly closed
- the plug is not properly inserted
- the fuse has blown

### A few minutes after switching on, the / indicator light flashes (fault code F..E appears in the display)

- the stopcocks are closed
- the filters in the water inlet hose are dirty
- water pressure is too low.
- Turn the programme selector to the  “STOP” position (the fault code goes out).
- Switch the machine off (press **I-0**).
- Open the stopcocks or clean the filters (see “Cleaning and care”).
- Switch on the machine again and re-select the programme.

### The wash cycle finishes too early and the / indicator light flashes (fault code F A appears in the display)

- the drain hose is kinked
- the drain pump is blocked
- Turn the programme selector to the  “STOP” position (the fault code goes out).
- Correct the fault.
- Pump away the water and start the programme again (see additional programme “DRAIN” and “Switching on”).

## Water in the wash cabinet is not heated; the programme sequence lasts too long

This machine has a resettable thermal cutout which will switch off the heaters in the case of overheating. This could be caused, for example, if large articles cover the heating elements or if the filters in the wash cabinet are blocked.

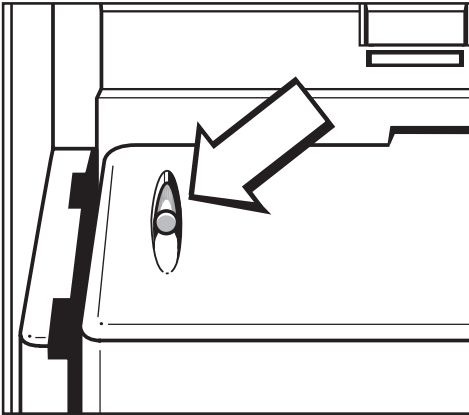

- Remove the cause of the fault.
- Take off the service panel (see “Electrical connection”).
- Press the reset button on the heater limiter (yellow) located on the left hand side of the plastic cover.

**If this switch trips again, the Miele Service Dept. must be contacted.**

## After Sales Service

Should you still have any difficulties or if the fault code “F...” shows in the display field please contact your authorised Service Dealer or the Miele Service Department.

See back cover for addresses.

- Please quote the fault code “F...” as well as the model type and number of your machine.

This information can be found on the data plate inside the door (see also “Electrical connection”).

Please note that telephone calls may be monitored and recorded to improve our service.

# Installation

## **Please refer to the installation diagram supplied with the machine.**

Furniture and fittings installed near the machine must be of a commercial standard able to withstand the effects of steam and condensed water.

The machine must be installed correctly and levelled.

Any unevenness in the floor level can be compensated for and the height of the machine raised or lowered by adjusting the four screw feet.

The machine can be installed in the following ways:

- Freestanding:
- Slot-in or at the end of a row:

The machine can be installed adjacent to other equipment or furniture or in a recess at least 60 cm wide and 60 cm deep.

- Building under:

The machine should be positioned under a continuous worktop or sink drainer.

The niche must be at least 60 cm wide, 60 cm deep and 82 cm high.

If necessary the machine lid can be removed as follows:

- Open the door.

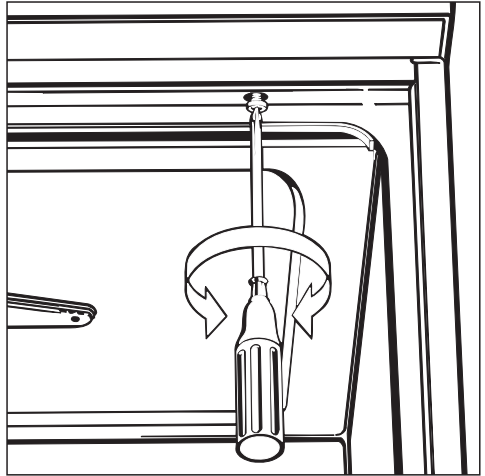

- Remove the fixing screws on the left and right hand sides using a cross slotted screwdriver.
- Pull the machine lid approx. 5 mm forwards, lift upwards and remove.

## **Important for machines without a steam condenser:**

The cabinet vent at the rear of the machine must be connected to an on-site duct system.

## **Important for machines with a steam condenser:**

To protect the underside of the worktop against water ingress, the protective foil (25 x 58 cm, self-adhesive) should be stuck under the worktop in the area of the steam condenser.



## **Position and secure the machine**

To ensure stability the machine must first be aligned and then screwed to the worktop.

- Open the door. Through each of the two holes in the front rim, left and right, screw the machine to the front edge of the continuous worktop.
- Do not use silicone sealant to seal the gaps between the machine and any neighbouring units as this would hinder ventilation of the circulation pump.

Depending on the requirements for building under, the following kit can be ordered from the Miele Spare Parts Department:

## **Coverplate (protects the worktop)**

The underside of the worktop is protected from water ingress by a stainless-steel plate.

## **Decor frame fitting kit**

The machine front can be fitted with a decor panel to match kitchen units. The decor frame is supplied with its own fitting instructions.

## Electrical connection

All electrical connection work must be carried out by a qualified electrician in compliance with local and national regulations.

- For extra safety it is advisable to install a residual current device (RCD) with a trip current of 30 mA.
- Technical data is available on the data plate or in the enclosed wiring diagram.

The voltage, rated load and plug rating must correspond to that given on the data plate.

Conversion can only be undertaken in compliance with the conversion and wiring diagrams and only on machines without a steam condenser.

A conversion diagram is to be found at the back of the machine and on the back of the service panel.

The relevant wiring diagram is to be found on the left-hand side behind the plinth, attached to the base of the machine.

The data plate with the relevant test certification is on the rear of the machine and on the plinth (behind the service panel).

### To remove the service panel and plinth:

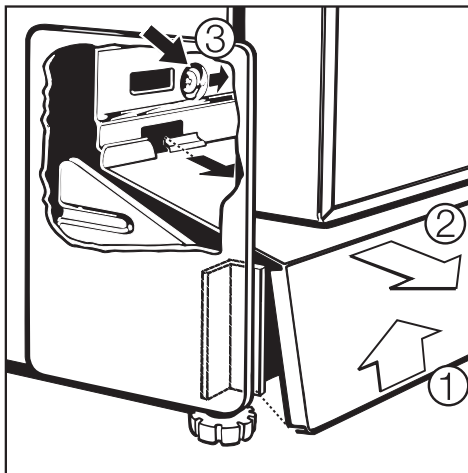

Disconnect the machine from the mains.

- Remove fixing screws “a”.
- Take hold of both sides of the service panel and pull forward.
- Remove plinth fascia screws “b”.
- Disconnect earth lead if necessary.
- Remove plastic protective cap.

To reassemble:



- Replace plastic protective cap, plinth fascia and service panel in reverse order.

Make sure the earth lead is reconnected.

Also refer to the installation instructions enclosed.

## Connection to the water inlet

Water in the machine must not be used as drinking water.

- The machine must be connected to the water supply in accordance with local and national regulations.
- The machine is constructed to comply with Australian regulations, and may be connected to a suitable supply without an extra non-return valve provided that national regulations allow this.
- The water pressure (flow pressure) must be a minimum of 2 bar (200 kPa) and a maximum of 10 bar (1000 kPa). If it is below 2 bar (200 kPa) the water intake time is automatically extended.  
Should the water pressure (flow pressure) fall below 0.5 bar (50 kPa) the machine will not function. (The  /  -indicator light may come on and the fault code "F2E" show in the display field). Please consult the Miele Service Department with regard to corrective measures.
- The machine is supplied as standard for connection to a cold (coded blue) or a hot (coded red) water supply up to a max. temperature of 70°C. The inlet hose should be connected to the stopcocks for the hot or cold water supply.

If a hot water supply is not available, the inlet hose (coded red) should also be connected to the cold water supply. In this case both inlet hoses are connected to the cold water supply.

- A stopcock with 3/4 inch male thread must be provided on site. It should be easily accessible because the water supply must be turned off when the machine is not in use.
- The DN 10 inlet hose is approx. 1.7 m long terminating in a 3/4 inch female thread. On no account may the inlet filter be removed.
- The large surface area filters (supplied with the machine) must be installed between the stopcock and the inlet hose. (For illustration see "Cleaning and Care" and "Water inlet").

The inlet hose must not be shortened or damaged in any way.

See also the installation diagram supplied.

# Plumbing

---

## Drainage

- The drainage system is fitted with a non-return valve which prevents dirty water from flowing back into the machine.
- The machine should preferably be connected to a separate drainage system on-site.  
If no separate drainage system is available, contact the Miele Service Department.  
The on-site drain connection point should be located between 0.3 m and 1 m above the lower edge of the machine.  
If the connection is lower than 0.3 m, the hose should loop at a height of at least 0.3 m to ensure correct drainage.  
The drainage system must have the capacity to take a minimum drainage flow of 16 litres/minute.
- The machine is supplied with approx. 1.4 m of flexible drain hose with an internal diameter of 22 mm. Two hose clips are also supplied for connection.  
The drain hose must not be shortened.
- A longer drain hose (up to 4 m long) is available to order from the Miele Spare Parts Dept.
- The drainage system must not exceed 4 metres.

See also the installation diagram supplied.

Height:	85 (82) cm
Width:	60 cm
Depth:	60 cm
Voltage:	see data plate
Rated load:	see data plate
Fuse rating:	see data plate
Connection cable:	approx. 1.8 m
Water pressure (flow pressure):	0.5 - 10 bar (50 - 1000 kPa)
Cold or hot water connection:	up to max. 70 °C
Drainage length:	max. 4 m
Delivery head:	min. 0.3 m , max. 1 m
Inlet hose:	approx. 1.7 m
Drain hose:	approx. 1.4 m
Noise level:	Freestanding: 65 dB (A) Built under: 61 dB (A)
Test marks:	Typetest Mark, C-Tick Mark
Electrically suppressed according to	AS/NZS 1044





**Australia:**

Miele Australia Pty. Ltd., A.C.N. 005635398

1 Gilbert Park Drive, Knoxfield, VIC 3180

Telephone: (03) 9764 7100, Fax: (03) 9764 7129

Miele Australia Pty. Ltd., 3 Skyline Place, Frenchs Forest, NSW 2086

Telephone: (02) 8977 4200, Fax: (02) 8977 4219

Miele Australia Pty. Ltd., 25 Lavarack Avenue, Eagle Farm, QLD 4009

Telephone: (07) 3632 2400, Fax: (07) 3632 2449

Miele Australia Pty. Ltd., 209 Richmond Road, Richmond, SA 5033

Telephone: (08) 8351 8500, Fax: (08) 8354 1717

**Distributor Western Australia:**

G.B.I. Sales Pty. Ltd., 52 Wickham Street,

P.O. Box 6300, East Perth, WA 6004

Telephone: (08) 9221 1455, Fax: (08) 9221 3475

**Distributor New Zealand:**

Steelfort Engineering Company. Ltd.

500 Rangitikei Street, Palmerston North, Priv. Bag 11045, NZ

Telephone: (06) 357 1099, Fax: (06) 356 1507

Steelfort Engineering Company Ltd.,

Unit L, 10-20 Sylvia Park Road,

Mt. Wellington, Auckland, NZ

Telephone: (09) 573 1269, Fax: (09) 573 1268

**Canada:**

Miele Limited

55G East Beaver Creek Road

Richmond Hill, Ontario L4B 1E5

Phone: 905-707-1171

Toll-Free: 1-800-565-6435

Fax: 905-707-0177

Internet: [www.miele.ca](http://www.miele.ca)

E-Mail: [info@miele.ca](mailto:info@miele.ca) (general enquiries)

E-Mail: [service@miele.ca](mailto:service@miele.ca) (technical service)

**USA:**

Miele, Inc.

9 Independence Way

Princeton, NJ 08540

Phone: 800-843-7231 or 609-419-9898

Technical Service: 800-999-1360

Fax: 609-419-1435

[www.mieleusa.com](http://www.mieleusa.com)



## Free Manuals Download Website

<http://myh66.com>

<http://usermanuals.us>

<http://www.somanuals.com>

<http://www.4manuals.cc>

<http://www.manual-lib.com>

<http://www.404manual.com>

<http://www.luxmanual.com>

<http://aubethermostatmanual.com>

Golf course search by state

<http://golfingnear.com>

Email search by domain

<http://emailbydomain.com>

Auto manuals search

<http://auto.somanuals.com>

TV manuals search

<http://tv.somanuals.com>