

Operating and installation instructions

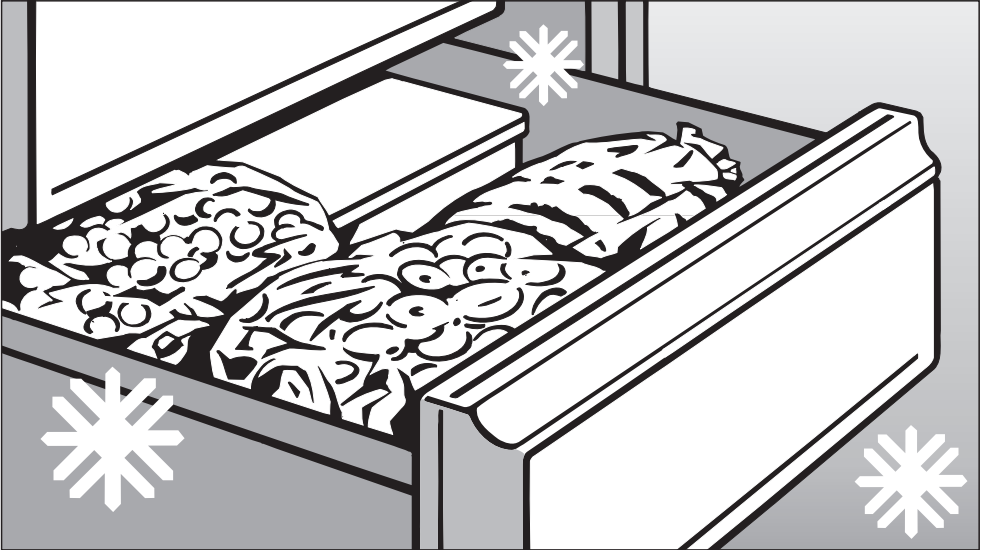

Freezer

F 12016 S-2

F 12020 S-2

F 12020 S-3

To avoid the risk of accidents or damage to the appliance, it is **essential** to read these operating instructions before it is installed or used for the first time.

en - GB

M.-Nr. 09 290 840

Contents

Guide to the appliance	4
Caring for the environment	6
Warning and Safety instructions	7
How to save energy	12
Switching on and off	14
Switching on	14
Switching off	14
Switching off for longer periods of time	14
Customising settings	15
Settings mode '≡'	15
Altering the brightness of the display	15
Activating or deactivating the lock	16
The correct temperature	18
Setting the temperature	18
Temperature range	19
Temperature display	19
Alarm	20
Temperature alarm	20
Activating the alarm system	20
Switching the alarm off early	20
Super freeze	21
Freezing and storing food	22
Maximum freezing capacity	22
Freezing fresh food	22
Storing frozen food	22
Home freezing	23
Hints on home freezing	23
Packaging	23
Before placing food in the freezer	24
Placing food in the freezer	24
Defrosting	25
Ice cubes	25
Cooling drinks	25
Defrosting	26
Cleaning and care	28
Cleaning the interior and accessories	28
Appliance door, side panels	29

Contents

Ventilation gaps	29
Door seal	29
Problem solving guide	30
Noises	35
After Sales / Guarantee	36
Information for dealers	37
Demo mode 	37
Electrical connection	38
Installation	39
Location	39
Climate range	39
Ventilation	40
Appliances with wall spacers supplied	40
Installation	40
Aligning the appliance	40
Appliance dimensions	41
Changing the door hinging	42
Changing over the door handle	43
Building in the appliance	44

Guide to the appliance

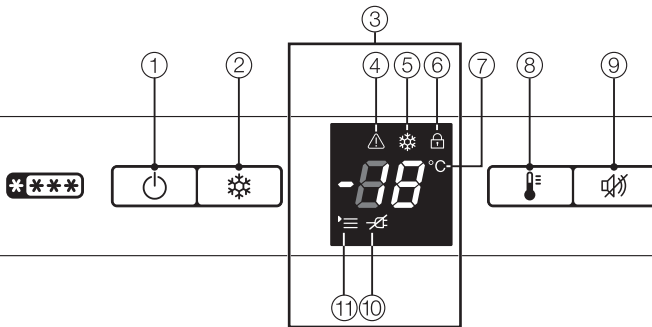

① On/Off button

② Super freeze button

③ Display

If the appliance is not operated for some time, the display will revert automatically to the brightness level which has been set.

As soon as a button is pressed the display will light up at the brightest setting.

④ Alarm symbol

⑤ Super freeze symbol

⑥ Lock symbol

⑦ Temperature display

⑧ Temperature selector button

⑨ Alarm off button

⑩ Power failure symbol

⑪ Menu symbol

Setting mode for:

- the brightness level of the display
- switching the lock on/off

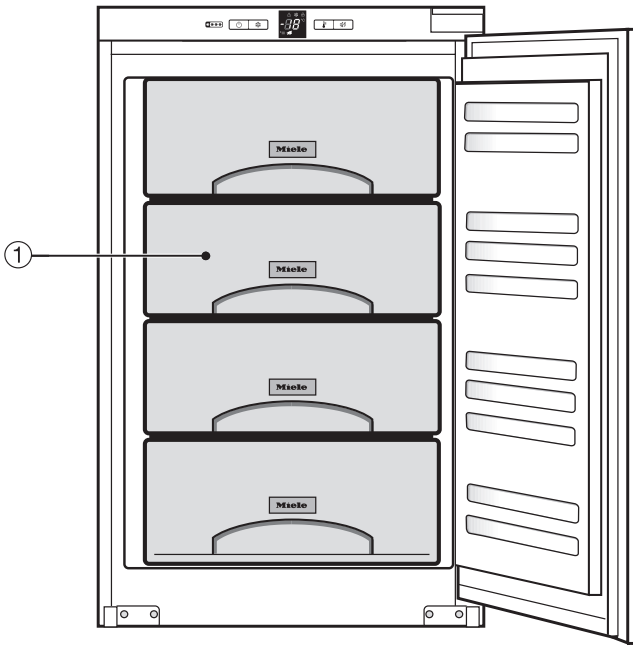

① Freezer drawers

Caring for the environment

Disposal of the packing material

The transport and protective packing has been selected from materials which are environmentally friendly for disposal, and should be recycled.

Ensure that any plastic wrappings, bags etc. are disposed of safely and kept out of the reach of babies and young children. Danger of suffocation!

Disposal of your old appliance

Electrical and electronic appliances often contain materials which, if handled or disposed of incorrectly, could be potentially hazardous to human health and to the environment. They are, however, essential for the correct functioning of your appliance. Please do not therefore dispose of it with your household waste.

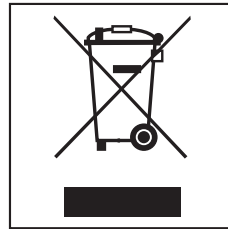

Please dispose of it at your local community waste collection / recycling centre or contact your dealer for advice. Ensure that it presents no danger to children while being stored for disposal.

Take care not to damage the pipework at the back of it before or during transportation to an authorised collection depot.

In this way, refrigerant in the pipework and oil in the compressor will be contained, and will not leak out into the environment.

Warning and Safety instructions

This appliance complies with all relevant safety requirements. Improper use can, however, present a risk of both personal injury and material damage.

To avoid the risk of accidents and damage to the appliance, please read these instructions carefully before installation and before using it for the first time. They contain important notes on installation, safety, operation and maintenance.

Keep these instructions in a safe place and pass them on to any future user.

Correct application

► The appliance is not designed for commercial use. It is intended for use in domestic households and in similar working and residential environments such as:

- Shops
- Offices and showrooms

and by residents in establishments such as:

- Hostels and guest houses.

The appliance is not intended for outdoor use.

It must only be used as a domestic appliance to store deep frozen food, to freeze fresh food and to prepare ice.

Any other usage is not supported by the manufacturer and could be dangerous. Miele cannot be held liable for damage resulting from incorrect or improper use or operation of the appliance.

► The appliance can only be used by people with reduced physical, sensory or mental capabilities, or lack of experience and knowledge, if they are supervised whilst using it, or have been shown how to use it in a safe way and understand the hazards involved.

Safety with children

► Children 8 years and older may use the appliance only if they have been shown how to use it in a safe way and understand the hazards involved.

► Children under 8 years of age must be kept away from the appliance unless they are constantly supervised.

► This appliance is not a toy! To prevent the risk of injury, do not allow children to play with it or near it, or to play with the controls, or to swing on the door.

► Do not allow children to play with the packaging material, e.g. plastic bags and wrappings. Danger of suffocation.

Warning and Safety instructions

Technical safety

► Before setting up the appliance, check it for any externally visible damage. Do not install and use a damaged appliance. It could be dangerous.

► If the connection cable is faulty it must only be replaced by a service technician authorised by the manufacturer to protect the user from danger.

► This appliance contains the coolant Isobutane (R600a), a natural gas which is environmentally friendly. Although it is flammable, it does not damage the ozone layer and does not increase the greenhouse effect. The use of this coolant has, however, led to a slight increase in the noise level of the appliance. In addition to the noise of the compressor, you might be able to hear the coolant flowing around the system. This is unavoidable, but does not have any adverse effect on the performance of the appliance. Care must be taken during the transportation and installation of the appliance that no parts of the cooling system are damaged. Leaking coolant can damage the eyes.

In the event of any damage:

- avoid open flames and anything which creates a spark,
- disconnect from the mains,
- air the room in which the appliance is located for several minutes and
- contact the Service Department for advice.

► The more coolant there is in an appliance, the larger the room it should be installed in. In the event of a leakage, if the appliance is in a small room, there is the danger of combustible gases building up. For every 8 g of coolant at least 1 m³ of room space is required. The amount of coolant in the appliance is stated on the data plate inside the appliance.

► Safe operation of the appliance is only assured if it has been installed and connected in accordance with these operating and installation instructions.

► Before connecting the appliance, make sure that the connection data on the data plate (voltage and frequency) matches the mains electricity supply. This data must correspond in order to avoid the risk of damage to the appliance. Consult a qualified electrician if in any doubt.

► Do not connect the appliance to the mains electricity supply by a multi-socket adapter or an extension lead. These do not guarantee the required safety of the appliance (e.g. danger of overheating).

Warning and Safety instructions

- ▶ The electrical safety of this appliance can only be guaranteed when it is correctly earthed. It is most important that this basic safety requirement is observed and tested regularly, and where there is any doubt, the household wiring system should be inspected by a qualified electrician. The manufacturer cannot be held liable for damage or injury caused by the lack of or inadequacy of an effective earthing system (e.g. electric shock).
- ▶ Installation, maintenance and repairs may only be carried out by a suitably qualified and competent person in strict accordance with current national and local safety regulations. Repairs and other work by unqualified persons could be dangerous. The manufacturer cannot be held liable for unauthorised work.
- ▶ While the appliance is under guarantee, repairs should only be undertaken by a service technician authorised by the manufacturer. Otherwise the guarantee will be invalidated.
- ▶ The appliance must be isolated from the electricity supply during installation, maintenance and repair work.
- ▶ Faulty components must only be replaced by genuine Miele original spare parts. The manufacturer can only guarantee the safety of the appliance when Miele replacement parts are used.
- ▶ The appliance must not be used in a non-stationary location (e.g. on a ship).
- ▶ In areas which may be subject to infestation by cockroaches or other vermin, pay particular attention to keeping the appliance and its surroundings clean at all times. Any damage caused by cockroaches or other vermin will not be covered by the guarantee.

Warning and Safety instructions

Correct use

▶ The appliance is designed for use within certain climate ranges (ambient temperatures), and should not be used outside this range. The climate range for your appliance is stated on the data plate inside the appliance.

Installing it in a room with too low an ambient temperature, e.g. a garage, can lead to the appliance switching off for longer periods so that it cannot maintain the required temperature.

▶ Do not block the ventilation gaps in the appliance as this would impair the efficiency of the appliance, increase the electricity consumption and could cause damage to the appliance.

▶ The lid on the appliance has a plastic edge. Keep oil and fat spills away from this as they could cause the plastic to crack and split.

▶ Do not handle frozen food with wet hands. Your hands may freeze to the frozen food. Danger of frost burn.

▶ Do not take ice cubes out with your bare hands and never place ice cubes or ice lollies in your mouth straight from the freezer.

The very low temperature of the frozen ice or lollies can cause frost burn to the lips and tongue.

▶ Do not refreeze partially or fully defrosted food.

Consume defrosted food as soon as possible, as it will lose its nutritional value and spoil if left for too long. Defrosted food may only be re-frozen after it has been cooked.

▶ Do not store cans or bottles containing carbonated drinks or liquids which could freeze in the freezer. The cans or bottles could explode. Danger of injury and damage to the appliance.

▶ When cooling drinks quickly in the freezer, make sure bottles are not left in for more than one hour, otherwise they could burst. Danger of injury and damage to the appliance.

▶ Observe the "use by" dates given on food to avoid the risk of food poisoning. Storage times will depend on several factors, including the freshness and quality of the food as well as the temperature at which it is stored. Follow the instructions given on food manufacturer's packaging regarding storage conditions and "use by" dates.

▶ Do not store explosive materials in the appliance or any products containing propellants (e.g. spray cans). Thermostats switching on may produce sparks which could present a fire hazard. Flammable compounds could explode.

Warning and Safety instructions

▶ Do not operate any electrical equipment (e.g. an electric ice-cream maker) inside the appliance. Danger of sparking and explosion.

- ▶ Do not use sharp edged objects to
- remove frost and ice,
 - separate frozen foods or remove ice trays.

They will damage the evaporator, causing irreversible damage to the appliance.

▶ Do not place electric heaters or candles in the appliance to defrost it. These can damage the plastic parts.

▶ Do not use defrosting sprays or de-icers, as they might contain substances which could damage the plastic parts or which could cause a build-up of gases and pose a danger to health.

▶ Do not use a steam-cleaning appliance to defrost or clean this appliance. Steam could reach electrical components and cause a short circuit.

▶ Do not use any oils or grease on the door seal, as these will cause the seal to deteriorate and become porous with time.

Disposal of your old appliance

▶ Before disposing of an old appliance, first make the door latch or lock unusable.

This way you will prevent children from accidentally locking themselves in and endangering their lives.

▶ Be careful not to damage any part of the pipework whilst awaiting disposal, e.g. by

- puncturing the refrigerant channels in the evaporator.
- bending any pipework.
- scratching the surface coating.

Splashes of refrigerant can damage the eyes.

The manufacturer cannot be held liable for damage caused by non-compliance with these Warning and Safety instructions.

How to save energy

	Normal energy consumption	Increased energy consumption
Installation site	In a ventilated room.	In an enclosed, unventilated room.
	Protected from direct sunlight.	In direct sunlight.
	Not near to a heat source (radiator, oven).	Near to a heat source (radiator, oven).
	Where the ideal ambient room temperature is approx. 20°C.	Where there is a high ambient temperature.
	Ventilation gaps uncovered and dusted regularly.	Ventilation gaps covered or dusty.
	Compressor and metal grille (heat exchanger) dusted at least once a year.	Dust build-up on the compressor and metal grille (heat exchanger).
Temperature setting with a thermostat which is approximate (set in stages).	With a medium setting of 2 to 3.	With a higher setting: the lower the temperature in the compartment, the higher the energy consumption.
Temperature setting with a thermostat which is exact to the degree (digital display).	Cellar section 8 to 12 °C	On appliances with winter setting, please make sure that the winter setting is switched off when the ambient temperature is warmer than 18°C.
	Refrigerator section 4 to 5 °C	
	PerfectFresh zone just above 0 °C	
	Freezer section -18 °C	
	Wine storage section 10 to 12 °C	

How to save energy

	Normal energy consumption	Increased energy consumption
Use	Drawers, shelves and racks arranged as they were when the appliance was delivered.	
	Only open the doors when necessary and for as short a time as possible. Store food in an organised way.	Opening doors frequently and for long periods results in loss of coolness and influx of warmer ambient air. The appliance works harder to cool down and the compressor runs for longer periods.
	Take a cool bag with you when shopping and on return place food into the appliance immediately. Replace any food removed rapidly, before it begins to thaw. Allow hot food and drinks to cool down before placing them in the appliance.	Hot food or food at room temperature raises the temperature inside the appliance. The appliance works harder to cool down and the compressor runs for longer periods.
	Store food covered or packaged.	The evaporation or condensation of liquids will cause a loss of coldness in the refrigerator.
	Place frozen food in the refrigerator to defrost.	
	Do not over-fill the appliance to allow air to circulate.	
Defrosting	Defrost the freezer section when a layer of ice 0.5 cm (max.) thick has built up.	A build-up of ice slows down the cooling process.

Switching on and off

Before using for the first time

- Clean the inside of the appliance and the accessories with lukewarm water and a little washing-up liquid, and then dry with a soft cloth.

Switching on



- Press the On/Off button.

The appliance will start to cool. The temperature display and the alarm symbol  will flash until the temperature in the freezer is cold enough.

To enable the temperature to get sufficiently cold inside the appliance, allow it to run for a few hours before placing food in it. Do not place food in the appliance until the temperature is at least -18°C .

Switching off



- Press the On/Off button until the display goes out.

The cooling system is switched off.

Switching off for longer periods of time

If the appliance is not going to be used for a longer period of time, e.g. whilst on holiday:

- switch the appliance off,
- disconnect it from the mains,
- clean the appliance out and
- leave the door ajar to air it.

If, during a long absence, the appliance is switched off but not cleaned out and the door is left shut, there is a danger of mould and odours building up inside the appliance.

Settings mode

Certain settings on the appliance can be changed using Settings mode.

The brightness of the display can be altered	<i>h</i>
The lock can be activated or deactivated	<i>c</i>

Settings mode is represented in the display by the Menu symbol . The following section describes how to access Settings mode and alter settings.

Altering the brightness of the display

The display brightness can be adjusted to suit the lighting conditions of the room.

You can select one of the five display brightness settings from *h1* to *h5*. The factory default setting is *h1* or *h3* (depending on model).



- Press the Super freeze button for approx. five seconds.

The Menu symbol  will light up and *c* will start flashing in the display. Settings mode is now activated.



- Press the temperature selector button to call up the Brightness function.

The Menu symbol  will light up and *h* will flash in the display.



- Press the Super freeze button briefly to confirm this.

The display brightness setting last selected will appear in the display.

Customising settings



- Press the temperature selector button repeatedly until the brightness level required is reached:

h1: dimmest setting

h5: brightest setting.



- Press the Super freeze button briefly to confirm your selection.

The newly selected setting has been saved.

To come out of Settings mode:

- Press the On/Off button.

Activating or deactivating the lock

The lock can be activated to prevent the appliance being switched off by mistake.

– To activate the Lock



- Press the Super freeze button for approx. five seconds.

The Menu symbol \equiv will light up and ϵ will start flashing.

Settings mode is now activated.



- Press the Super freeze button briefly to call up the Lock function.

$\epsilon 1$ will appear in the display.



- Press the Super freeze button briefly to activate the lock.

The Lock symbol \mathcal{L} will light up.

To come out of Settings mode:



- Press the On/Off button.

– To deactivate the Lock



- Press the Super freeze button for approx. five seconds.

The Menu symbol \equiv will light up and ϵ will start flashing in the display. Settings mode is now activated.



- Press the Super freeze button briefly to call up the Lock function.

ϵ will appear in the display.



- Press the Super freeze button briefly to deactivate the lock.

The Lock symbol \mathfrak{L} will go out.

To come out of Settings mode:



- Press the On/Off button.

The correct temperature

It is very important to set the correct temperature for storing food in the appliance. Micro-organisms will cause food which is not stored at the correct temperature to deteriorate rapidly. Temperature influences the growth rate of these micro-organisms. Reducing the temperature reduces their growth rate.

To freeze fresh food and to store frozen food for a long time, a temperature of **-18 °C** is required. At this temperature the growth of micro-organisms is generally halted. As soon as the temperature rises above -10 °C, the micro-organisms become active in the food again so that it cannot be kept as long. For this reason, partially defrosted or defrosted food must not be re-frozen. Food may be re-frozen once it has been cooked, as the high temperatures achieved when cooking destroy most micro-organisms.

The temperature in the appliance will rise:

- the more often the door is opened and the longer it is kept open,
- if too much food is stored in it at once,
- if too much fresh food is being frozen at once,
- the higher the ambient temperature surrounding the appliance.

The appliance is designed for use in specific ambient temperatures (climate ranges). Do not use in ambient temperatures for which it is not designed.

Setting the temperature



- Press the temperature selector button repeatedly until the temperature you want lights up in the display.

The first time you press the button the indicator light for the last temperature you set will flash in the display.

The temperature value will change up until the setting for -28 °C is reached. It will then drop back to the -14 °C setting.

Approx. 5 seconds after the last press on the button, the current **actual** temperature of the freezer is automatically shown.

If you have adjusted the temperature, **wait for approx. 6 hours if the appliance is not very full** and **for approx. 24 hours if the appliance is full** before checking the temperature display as it will take this long for the display to give an accurate reading. If, after this time, the temperature is still too high or too low, you will need to adjust it again.

The correct temperature

Temperature range

The temperature can be adjusted from: -14 °C to -28 °C

The ambient temperature in the room and the installation location can affect the time it takes for the appliance to reach the lowest temperature. If the ambient temperature is too high, the appliance may not reach the lowest temperature.

Temperature display

The temperature display on the control panel shows the temperature in the warmest part of the appliance.

The **temperature display will flash** if

- the temperature in the appliance is not within the possible temperature range, e.g. immediately after the appliance has been switched on.
- a different temperature is being set,
- the temperature in the appliance has risen by several degrees, indicating that the appliance is warming up too much.

This loss of coldness is no cause for concern in the following circumstances:

- when the door has been left open for a while, e.g. for removing or storing a large amount of food,
- when fresh food is being frozen.

As soon as the temperature has fallen to approx. -10 °C, the temperature display ceases to flash and lights up constantly.

However, if the temperature remains above -18 °C for a long time, check that the frozen food has not started to defrost. If it has, make sure that the food is safe to use and, if it is, then use it as soon as possible.

Alarm

Your appliance has been fitted with a warning system which ensures that the temperature in the freezer cannot rise unnoticed.

Temperature alarm

If the temperature in the freezer becomes too warm, an alarm will sound. At the same time the temperature display and the Alarm symbol  will flash.

The temperature the appliance is set at determines the temperature the appliance recognises as being too warm.

For example, the alarm may sound and the temperature display and the Alarm symbol  may flash,

- when freezing large amounts of food at once,
- when freezing fresh food which is still warm,
- if a lot of room air enters the freezer when food is being loaded, re-arranged or taken out,
- in the event of a power cut,
- if the appliance is faulty.

The alarm will stop and the indicators will go out as soon as the temperature has dropped down to the correct level again.

Activating the alarm system

The alarm system works automatically once the temperature in the freezer is cold enough.

Switching the alarm off early

As soon as the temperature in the freezer has dropped sufficiently, the alarm switches off and the temperature display stops flashing and lights up constantly. However, if the noise disturbs you, you can switch the alarm off before this if you wish.



- Press the alarm off button.

The alarm will stop. The temperature display will continue to flash until the set temperature has been reached. The display then stops flashing and lights up constantly. The alarm system is then ready should it be needed again.

Switch on Super freeze before putting fresh food into the freezer.

This helps food to freeze quickly and retain its nutrients, vitamins, flavours and appearance.

Super freeze is not necessary:

- when placing food in the freezer that is already frozen.
- when freezing up to 1 kg fresh food daily.

Switching on Super freeze

When freezing small quantities of food in the freezer, the Super freeze function should be switched on **6 hours beforehand**. When freezing **the maximum load of food** the Super freeze function should be switched on **24 hours beforehand**.



- Press the Super freeze button briefly.

The Super freeze symbol ❄️ will light up.

The appliance will work at full power to lower the temperature in the appliance.

The compressor can switch on up to 8 minutes later. This is due to an built-in delay switch, which helps prolong the life of the appliance.

Switching off Super freeze

The Super freeze function will switch off automatically after approx. 30 - 65 hours. The Super freeze symbol ❄️ will go out and the appliance will run at normal power again.

To save energy the Super freeze function can be switched off once a **constant** temperature of -18°C or colder has been reached in the freezer. Check the temperature inside the appliance.



- Press the Super freeze button.

The Super freeze symbol ❄️ will go out.

The appliance will continue running at normal power.

Freezing and storing food

Maximum freezing capacity

To ensure that fresh food placed in the freezer freezes through to the core as quickly as possible, the maximum freezing capacity must not be exceeded. The maximum freezing capacity for freezing within a 24-hour period is given on the data plate: "Freezing capacitykg/24 hrs".

The maximum freezing capacity given on the data plate has been calculated according to DIN EN ISO 15502 Standard.

Freezing fresh food

Fresh food should be frozen as quickly as possible. This way the nutritional value of the food, its vitamin content, appearance and taste are not impaired.

Food which takes a long time to freeze will lose more water from its cells, which then shrink.

During the defrosting process, only some of this water is reabsorbed by the cells; the rest collects around the food.

If food is frozen quickly, the cells have less time to lose moisture, so they shrink less. As there is not so much moisture loss, it is easier for the food to reabsorb it during the defrosting process, and very little water collects around the defrosted food.

Storing frozen food

When buying frozen food to store in your freezer, check

- that the packaging is not damaged,
 - the use-by date,
 - the temperature at which the frozen food is being stored in the shop. The length of time it can be kept is reduced if it has been stored at a temperature warmer than -18 °C.
- Buy frozen food once you have finished the rest of your shopping, and wrap it in newspaper or use a cool bag or cool box to transport it.
 - Store it in the freezer as soon as possible.

Never re-freeze partially or fully defrosted food. Consume defrosted food as soon as possible as it will lose its nutritional value and spoil if left for too long. Defrosted food may only be re-frozen after it has been cooked.

Home freezing

Only freeze fresh food which is in a good condition.

Hints on home freezing

- The following types of food **are suitable** for freezing:
Fresh meat, poultry, game, fish, vegetables, herbs, fresh fruit, dairy products, pastry, leftovers, egg yolks, egg whites and a range of pre-cooked meals.
- The following types of food **are not suitable** for freezing:
Grapes, lettuce, radishes, sour cream, mayonnaise, eggs in their shells, onions, whole raw apples and pears.
- To retain colour, taste and vitamin C, vegetables should be blanched after they have been trimmed and washed. To blanch: bring a large saucepan of water to the boil, immerse the vegetables in the fast boiling water for 2-3 minutes, depending on variety. Remove, and plunge into ice-cold water to cool quickly. Drain and pack ready for freezing.
- Lean meat freezes better than fatty meat, and can be stored for considerably longer.
- To prevent chops, steaks, cutlets or rolled meat from freezing together in solid blocks when packed, separate with a sheet of plastic freezer film.
- Do not season fresh food or blanched vegetables before freezing. Only season cooked food lightly before freezing, but care

should be taken as the taste of some spices alters when frozen.

- Do not place hot food or drinks in the freezer. This causes already frozen food to thaw, and increases the energy consumption considerably. Allow hot food and drinks to cool down before placing them in the freezer.

Packaging

- Freeze food in portions.

Unsuitable packaging material

- wrapping paper
- grease-proof paper
- cellophane
- bin bags
- plastic carrier bags

Suitable packaging material

- plastic freezer film
- freezer bags
- aluminium foil
- freezer containers

- Expel as much air as possible from bags etc. before sealing them, to prevent freezer-burn on food.
- Close the packaging tightly with
 - rubber bands
 - plastic clips
 - string or bag ties
 - freezer tape.

Freezer bags may also be sealed using home heat sealing kits.

- Make a note of the contents and the date of freezing on the packaging.

Freezing and storing food

Before placing food in the freezer

- When freezing more than 1 kg of fresh food, switch on the Super freeze function for some time before placing the food in the freezer (see "Super freeze").

This helps food that is already in the freezer to stay frozen.

Placing food in the freezer

The following maximum capacities must be observed:

- freezer drawer = 25 kg
- glass cold plate = 35 kg

Food to be frozen must on no account touch food which is already frozen to avoid partial thawing.

- Make sure that the packaging and containers are dry to prevent them sticking together when frozen.

– Freezing small portions

Place the food in the lower freezer drawers.

- Place the food flat in the bottom of the drawers so that it freezes through to the core as quickly as possible.

– Freezing the maximum amount (see data plate)

- Remove the lowest freezer drawer.
- Place the food flat on the bottom of the appliance or in contact with the interior side walls, so that it freezes through to the core as quickly as possible.

Once frozen:

- Place the frozen food in the freezer drawer and push it back in.

– Large items

If you wish to freeze large items such as a turkey or game, the glass cold plates between the drawers can be removed.

- Remove the freezer drawers and carefully lift and slide out the glass cold plates.

Defrosting

Frozen food can be defrosted in different ways:

- in a microwave oven,
- in an oven using the "Fan" or "Defrost" setting,
- at room temperature,
- in the refrigerator (the cold given off by the frozen food helps to keep the other food cold),
- in a steam oven.

Poultry It is particularly important to observe food hygiene rules when defrosting poultry. Do not use the liquid from defrosted poultry. Pour it away and wash the container it was in, the sink and your hands. Danger of salmonella poisoning.

Ensure that **meat and fish** (e.g mince, chicken, fish fillets) do not come into contact with other foods while defrosting. Catch the liquid and dispose of it carefully.

Fruit should be defrosted at room temperature in its packaging, or in a covered bowl.

Most vegetables can be cooked while still frozen. Just put straight into boiling water or hot fat. The cooking time is slightly less than that of fresh vegetables due to changes in the cell structure.

Never re-freeze partially or fully defrosted food. Consume defrosted food as soon as possible as it will lose its nutritional value and spoil if left for too long. Defrosted food may only be re-frozen after it has been cooked.

Ice cubes

(depending on model)

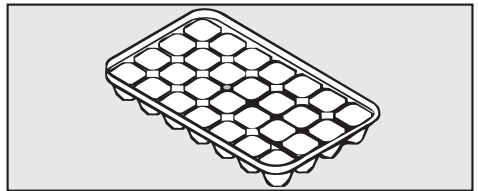

- Fill the ice tray three quarters full with water, and place it in the bottom of one of the drawers.
- Once frozen, use a blunt instrument, for example a spoon handle, to remove the ice tray from the freezer.
- Ice cubes can be removed easily from the tray by twisting the tray gently or by holding it under cold running water for a short while.

Cooling drinks

Do not store cans or bottles containing carbonated drinks or liquids which could freeze in the freezer. The cans or bottles could explode.

When cooling non-carbonated drinks quickly in the freezer, make sure bottles are not left in for more than one hour, otherwise they could burst.

Defrosting

In normal use, ice and frost will form in the freezer, e.g. on the internal walls. How much ice and frost accumulates in the appliance will depend on the following:

- whether the appliance door has been opened frequently or left open for a while.
- whether a large quantity of fresh food has been placed in the freezer at once.
- whether there has been an increase in the humidity in the room.

Too thick a layer of ice will make it hard to remove freezer drawers, and in certain circumstances can prevent the door from closing properly. Too thick a layer of ice also reduces efficiency and increases energy consumption.

- The freezer should be defrosted from time to time. It must be defrosted if a layer of ice approx. 0.5 cm thick has accumulated.

The best time to defrost the freezer is when:

- there is very little food or no food left in the freezer,
- the humidity level in the room is low and the ambient temperature in the room is also low.

Do not scrape off ice and frost and do not use any sharp edged or pointed instruments to aid the defrosting process.

This would damage the evaporator, causing irreversible damage to the appliance.

Before defrosting

- Switch on the Super freeze function at least 4 hours before defrosting to ensure frozen food retains its cold reserve for longer when taken out of the freezer.
- Remove the frozen food from the freezer and place it in a cool box, or wrap it in several layers of newspaper or cloths and store in a cool place until the freezer is ready for use again.
- Remove all the freezer drawers and glass cold plates from the freezer.

To defrost

Carry out the defrosting procedure as quickly as possible. The longer the food is left out at room temperature, the faster it defrosts.

Do not use a steam-cleaning appliance to aid the defrosting process. Steam could reach electrical components and cause a short circuit.

Never place electric heaters or candles etc. inside the appliance to defrost it. They will damage plastic parts.

Do not use defrosting sprays or de-icers as they might contain substances which could damage the plastic parts or which could cause a build-up of gases and pose a danger to health.

- Switch the appliance off.

If the temperature display does not go out, then the lock is still activated.

- Disconnect the appliance from the mains.
- Leave the freezer door open.

To speed up defrosting, two bowls of hot water (not boiling), with plates underneath them, can be placed in the appliance. Closing the door in this instance will help retain the warmth and speed up the defrosting process.

- Remove any loose pieces of ice.
- Use a sponge or towel to soak up the defrosted water, as often as necessary.

After defrosting

- Clean the appliance and then dry it thoroughly.
- Close the appliance door.
- Reconnect to the mains and switch the appliance back on.
- Switch on the Super freeze function so that the appliance can cool down quickly.
- Once the temperature in the freezer is sufficiently low, slide the glass cold plates back into the freezer, then replace the food in the freezer drawers and put them back in the freezer.
- When the temperature in the freezer is a constant -18 °C or colder press the Super freeze button to switch the Super freeze function off.

Cleaning and care

Make sure that no water can penetrate into electronic unit or into the ventilation gaps.

Do not use steam cleaning apparatus to clean the appliance. Steam could reach electrical components and cause a short circuit.

The data plate located inside the appliance must not be removed. It contains information which is required in the event of a service call.

To avoid damaging the surface of your appliance, do not use:

- cleaning agents containing soda, ammonia, acids or chlorides,
- cleaning agents containing descaling agents,
- abrasive cleaning agents, e.g. powder cleaners and cream cleaners,
- solvent-based cleaning agents,
- stainless steel cleaning agents,
- dishwasher cleaner,
- oven sprays,
- glass cleaning agents,
- hard, abrasive sponges and brushes, e.g. pot scourers,
- melamine eraser blocks,
- sharp metal scrapers.

Before cleaning

- Switch the appliance off.
- Disconnect the appliance from the mains.
- Take any frozen food out of the appliance and store it in a cool place.
- Take out any removable parts for cleaning.
- Defrost the freezer.

Cleaning the interior and accessories

- Use lukewarm water with a little washing-up liquid.

The ice cube tray (depending on model) is dishwasher safe.

The temperature of the dishwasher programme must not exceed 55 °C. Contact with some foodstuffs, such as carrots, tomatoes or ketchup can cause plastic items to discolour. However, this discolouration will not affect the stability of plastic items.

- Clean the drawers and glass cold plates by hand. They are **not** suitable for cleaning in a dishwasher.
- After cleaning, wipe the interior and accessories with a damp cloth and dry with a soft cloth. Leave the door open to air the appliance for a short while.

Appliance door, side panels

Remove any soiling from the appliance door and side panels immediately.

If this is not done, it might become impossible to remove and could cause the surface to alter or discolour.

All surfaces are susceptible to scratching. Contact with unsuitable cleaning agents can alter or discolour the surfaces.

- The surfaces should be cleaned using a solution of hot water and a little washing-up liquid applied with a soft sponge. They can also be cleaned with a damp microfibre cloth (without using any cleaning agent).
- After cleaning, wipe with clean water and dry with a soft cloth.

Ventilation gaps

- The ventilation gaps should be cleaned regularly with a brush or vacuum cleaner. A build-up of dust will increase the energy consumption of the appliance.

Door seal

Do not use any oils or grease on the door seal as these will cause the seal to deteriorate and become porous over time.

The door seal should be cleaned regularly with clean water and then wiped dry with a soft cloth.

Back of appliance - compressor and metal grille

The compressor and the metal grille at the back of the appliance (heat exchanger) must be dusted at least once a year. A build-up of dust will increase the energy consumption of the appliance.

Make sure that the cable and other components do not get broken off, bent or damaged in any way during cleaning.

After cleaning

- Close the appliance door.
- Reconnect to the mains and switch the appliance back on.
- Switch on the Super freeze function so that the appliance can cool down quickly.
- Once the temperature in the freezer is sufficiently low, replace the glass cold plates and drawers in the freezer. Store the food in the drawers.
- When the temperature in the freezer is a constant -18°C or colder press the Super freeze button to switch the Super freeze function off.

Problem solving guide

Some minor problems can be corrected without contacting Miele. If having followed the suggestions below, you still cannot resolve the problem, please contact Miele.

To prevent unnecessary loss of temperature it is advisable not to open the door while waiting for the appliance to be serviced.

Installation, maintenance and repairs may only be carried out by a suitable qualified and competent person in strict accordance with current national and local safety regulations.

Repairs and other work by unqualified persons could be dangerous. The manufacturer cannot be held liable for unauthorised work.

Problem	Possible cause	Remedy
The appliance does not get cold.	The appliance has not been switched on. The temperature display is not lit up.	■ Press the On/Off button.
	The plug is not inserted in the socket correctly.	■ Insert the plug in the socket correctly.
	Check whether the mains fuse has tripped. There could be a fault with the appliance, the household electrical wiring or another electrical appliance.	■ Contact a qualified electrician or Miele.
The door cannot be opened several times in succession.	The suction caused by opening and closing the door several times in succession is preventing it from opening. Wait a few minutes and then try again. It should now open without force.	



Problem solving guide

Problem	Possible cause	Remedy
The temperature inside the appliance is too low.		<ul style="list-style-type: none"> ■ Set a warmer temperature.
	<p>The Super freeze function is still switched on. The Super freeze function switches itself off automatically after approx. 30 - 65 hours.</p>	<p>You can switch off the Super freeze function earlier to save energy:</p> <ul style="list-style-type: none"> ■ Press the Super freeze button.
The compressor is switching in too frequently or for too long.	<p>The ventilation gaps have been covered over or become dusty.</p>	<ul style="list-style-type: none"> ■ Do not cover or block the ventilation gaps. ■ Dust the compressor and the ventilation gaps and the heat exchanger regularly.
	<p>Check whether the compressor, the metal grille (heat exchanger) at the rear of the appliance have become dusty.</p>	
	<p>The door has been opened too frequently, or a large amount of fresh food has been put in at once for freezing.</p>	<p>Only open the door when necessary and for as short a time as possible. The required temperature will re-establish itself after a while.</p> <ul style="list-style-type: none"> ■ See "The correct temperature" for more information.
	<p>The door cannot be closed correctly.</p>	
	<p>The ambient temperature is too high. The higher the ambient temperature, the longer the compressor will run for.</p>	<ul style="list-style-type: none"> ■ See "Installation - Location" for more information.

Problem solving guide

Problem	Possible cause	Remedy
<p>The compressor runs continuously.</p>	<p>To save energy, the compressor runs at a lower speed, but for longer, when less cooling is required.</p>	
	<p>Super freeze is switched on. Food is frozen rapidly, preserving nutrients, vitamins and flavour.</p>	<p>The Super freeze function switches itself off automatically after approx. 30 - 65 hours. You can switch off the Super freeze function earlier to save energy:</p> <ul style="list-style-type: none"> ■ Press the Super freeze button.
<p>Two bars appear in the display.</p>	<p>The temperature will only show in the display once the temperature inside the appliance falls below 0 °C.</p>	<ul style="list-style-type: none"> ■ Check the temperature display about 6 hours after switching on the appliance.
	<p>The temperature has risen above 0 °C at some point during the last couple of days because of a power cut.</p>	
<p>The  symbol lights up.</p>	<p>Demo mode has been activated. This allows the appliance to be displayed in the showroom without the cooling system being switched on. Do not activate this setting for domestic use!</p>	<ul style="list-style-type: none"> ■ Deactivate Demo mode (see "Information for dealers - Demo mode").

Problem solving guide

Problem	Possible cause	Remedy
<p>The Alarm symbol  flashes.</p>	<p>The temperature inside the appliance is too low.</p> <ul style="list-style-type: none"> – The door has been opened too frequently. – A large amount of fresh food has been put in at once for freezing without switching on the Super freeze function. – There has been a lengthy interruption to the power supply. 	<p>The alarm will stop and the Alarm symbol  will go out when the temperature reaches the correct level again.</p> <p>Depending on the temperature in the freezer, you should check the condition of the food. If food has defrosted or started to defrost, check that it is still safe to use, and if so, use it as quickly as possible. Defrosted food may only be re-frozen after it has been cooked.</p>
<p>The alarm sounds and the Power failure symbol  flashes in the display.</p> <p>The temperature display will show the warmest temperature recorded in the freezer during the power cut.</p>	<p>The temperature has risen too high at some point during the last couple of hours or days because of a power cut.</p>	<p>Depending on the temperature in the freezer, you should check the condition of the food. If food has defrosted or started to defrost, check that it is still safe to use, and if so, use it as quickly as possible. Defrosted food may only be re-frozen after it has been cooked.</p> <p>■ Press the alarm off button.</p> <p>The warmest recorded temperature will go out in the display. The display will then revert to showing the current temperature in the freezer.</p>
<p>F0 to F5 appears in the display.</p>	<p>There is a fault.</p>	<p>■ Call Miele Service.</p>

Problem solving guide

Problem	Possible cause	Remedy
The external side panels of the appliance feel warm.	The warmth created by the evaporator is used to prevent condensation.	
Food has frozen together.		■ Use a blunt instrument, e.g. a spoon handle or plastic scraper, to prise it apart carefully.
There is a thick layer of ice in the freezer.	The door is not properly closed.	■ Defrost and then clean the freezer. Too thick a layer of ice reduces efficiency and increases energy consumption.
You cannot switch the appliance off.	The lock has been activated.	■ Deactivate the lock (see "Customising settings - To deactivate the lock").

Normal noises	What causes them
Brrrrr...	Humming noise made by the motor (compressor). This noise can get louder for brief periods when the motor is switching on.
Blubb, blubb....	A gurgling noise can be heard when coolant is circulating through the pipes.
Click....	Clicking sounds are made when the thermostat switches the motor on and off.
Sssrrrrr....	On multi-zone and frost-free appliances you can sometimes just hear the movement of air circulating inside the appliance.
Creak ...	Creaking sounds can be heard when material inside the appliance expands.

Remember that the noise of the compressor and the coolant circulating in the system is unavoidable.

Noises that you can easily rectify	Possible cause	Remedy
Rattling, vibrating	The appliance is uneven.	Realign the appliance using a spirit level, by raising or lowering the screw feet underneath the appliance.
	The appliance is touching another appliance or piece of furniture.	Move it away.
	Drawers, baskets or shelves are unstable or sticking.	Check all removable items and refit them correctly.
	Are any bottles or containers unstable or knocking against each other?	Separate them.
	The transport cable clips are hanging loose at the back of the appliance.	Remove the clips.

After Sales / Guarantee

In the event of a fault which you cannot correct yourself, or if the appliance is under guarantee, please contact:

– your Miele Dealer

or

– Miele
(see back cover for contact details).

When contacting your Dealer or Miele, please quote the model and serial number of your appliance. This information is given on the data plate inside your appliance.

Please note that telephone calls may be monitored and recorded for training purposes.

N.B. A call-out charge will be applied for service visits where the problem could have been resolved as described in these instructions.

Guarantee

For information on the appliance guarantee specific to your country please contact Miele. See back cover for contact details.

In the U.K. your appliance is guaranteed for 2 years from the date of purchase. However, you must activate your cover by calling 0845 365 6640 or registering online at www.miele.co.uk.



Demo mode

The appliance can be demonstrated in the showroom or at exhibitions in "Demo mode". In this mode the display and the controls are functioning but the compressor remains switched off.



Demo mode is represented in the display by the  symbol.

To activate Demo mode

- Press the On/Off button.
- Press the On/Off button and the Temperature selector button at the same time for approx. 5 seconds.

The Menu symbol  and the  symbol will flash.

- Press the Super freeze button.



The Menu symbol  will flash and  will appear in the display.

- Press the Super freeze button.



The  symbol and the last temperature selected will light up.
Demo mode is active.

To deactivate Demo mode

- Press the On/Off button and the Temperature selector button at the same time for approx. 5 seconds.

The Menu symbol  and the  symbol will flash. The  symbol will light up.

- Press the Super freeze button.

The  symbol will light up and  will appear in the display. The Menu symbol  will flash.

- Press the Super freeze button.

The  symbol will go out.
Demo mode has now been deactivated.

Electrical connection

Electrical connection U.K.

All electrical work should be carried out by a suitably qualified and competent person in strict accordance with current local and national safety regulations (BS 7671 in the UK).

The appliance is supplied with a mains cable and moulded plug ready for connection to an a.c. single phase 220-240 V 50 Hz supply.

Please ensure that the connection data quoted on the data plate match the household mains supply.

Connection should be made via a suitable switched socket which is easily accessible. For extra safety it is advisable to protect the appliance with a suitable residual current device (RCD).

Do not connect the appliance to the mains electricity supply by an extension lead. Extension leads do not guarantee the required safety of the appliance (e.g. danger of overheating).

This appliance must not be connected to the inverter of an autonomous power supply, e.g. a solar power system. When switching the appliance on, a surge in power could trigger the safety cut-out mechanism. This could damage the electronic unit.

The appliance must not be used with so-called energy saving devices. These reduce the energy supply to the appliance which could then become too warm. Using such devices could alter the specification of the product.

Non-rewireable plugs (BS 1363)

The fuse cover must be re-fitted when changing the fuse, and if the fuse cover is lost, the plug must not be used until a suitable replacement is obtained. The colour of the correct replacement cover is that of the coloured insert in the base of the plug, or the colour that is embossed in words in the base of the plug (as applicable to the design of the plug fitted).

Replacement fuses should be ASTA approved to BS 1362 and have the correct rating. Replacement fuses and fuse covers may be purchased from your local electrical supplier.

WARNING
THIS APPLIANCE MUST BE
EARTHED

Do not place any appliance which gives off heat, such as a toaster or microwave oven, on top of this appliance, as this would increase the appliance's energy consumption.

This appliance must not be installed directly next to another refrigerator or freezer. It does not have side-wall heating, so installation next to another refrigerator or freezer could cause a build-up of condensation between them. Further information is available from your dealer.

Important: tropical / humid environments

During periods of high humidity, some condensation may appear on outside surfaces of cooling appliances. This condensation will disappear when humidity levels drop. For prevention, it is advisable to install the appliance with sufficient ventilation in a dry and/or an air-conditioned room. Please ensure that doors are closing and sealing properly. Please ensure that the appliance is installed in accordance with these installation instructions and that the handle is fitted correctly. Should you require further assistance please contact your Miele customer service centre.

Location

This appliance should not be installed where it is exposed to direct sunlight or directly adjacent to a heat-producing appliance such as an oven or a radiator. The higher the ambient temperature of the room, the more energy the appliance requires to operate.

The appliance should be installed in a dry well ventilated room.

Climate range

The appliance is designed for use within certain climate ranges (ambient temperatures), and should not be used outside this range. The climate range of the appliance is stated on the data plate.

Climate range	Ambient room temperature
SN	+10 °C to +32 °C
N	+16 °C to +32 °C
ST	+16 °C to +38 °C
T	+16 °C to +43 °C

Operating in a room which is too cold will cause the cooling system to switch off for too long, causing the internal temperature in the appliance to rise with the risk of food deteriorating and going off.

Installation

Ventilation

Air at the back of the appliance gets warm. To ensure sufficient ventilation, the ventilation gaps must not be covered or blocked in any way. They should be dusted on a regular basis.

Appliances with wall spacers supplied

Fitting the wall spacers supplied onto the back of the appliance assists in attaining lower energy consumption. Appliance depth without the wall spacers fitted is reduced by 35 mm. If the wall spacers are not used, this does not influence the functionality of the appliance. Energy consumption is only minimally increased if there is little distance between the appliance and the wall.

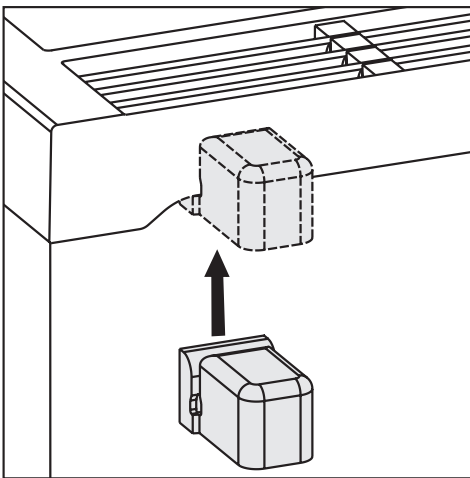

- Fit the wall spacers onto the back of the appliance on the top left and right.

Installation

Two people are required to install the appliance. Only move the appliance when it is empty.

- **Do not** remove the following from the back of the appliance:
 - Depending on model, the bags located between the back of the appliance and the metal grille (heat exchanger). They are important for the correct functioning of the appliance. The contents are harmless and do not contain toxic gases.
- Remove the cable clip from the back of the appliance.
- Check that all parts at the back of the appliance are unhindered. Carefully remove any hindrance.
- Carefully push the appliance into position.
- Position the appliance with the wall spacers (if used) or the back close to the wall.

Aligning the appliance

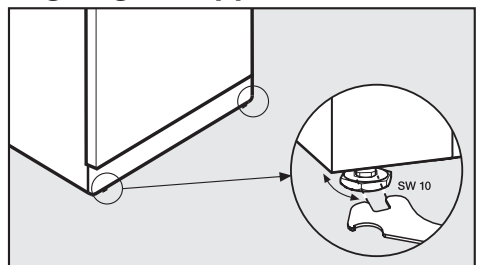

- To align the appliance, adjust the feet using a suitable spanner.

Appliance dimensions

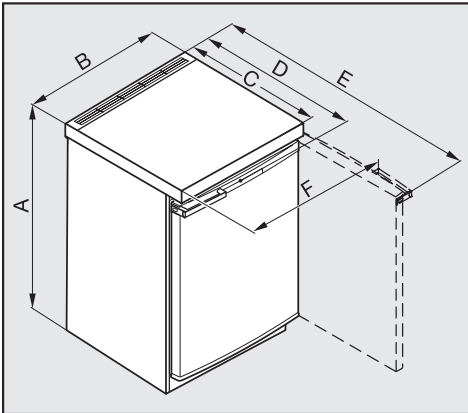

	A	B	C	D	E	F
F 12016 S-2	850 mm	555 mm	611 mm	624 mm	1174 mm	595 mm
F 12020 S-2	850 mm	600 mm	611 mm	624 mm	1174 mm	640 mm
F 12020 S-3	850 mm	600 mm	646 mm*	665 mm*	1209 mm*	640 mm

* Measurement with wall spacers fitted. If the wall spacers are not fitted, the measurement is reduced by 35 mm.

Changing the door hinging

The appliance is supplied right hand hinged. If left hand door hinging is required, follow the instructions below.

- Close the door.

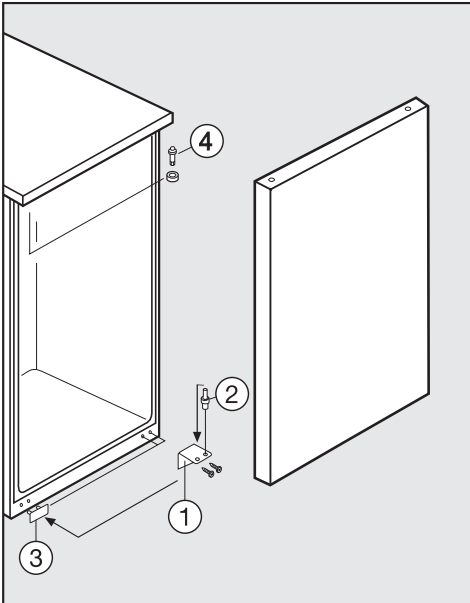

- Unscrew lower hinge bracket (1), and remove.
- Then lift the door down and off.
- Take hinge pin (2) out of hinge bracket (1), then refit in the other hole of the hinge bracket.
- Remove cover (3) and use it to cover the now empty holes on the opposite side.

- Unscrew upper hinge pin (4) and refit it on the other side.
- Take care not to lose the washer.
- Remove the cover at the top left of the door and refit it on the opposite side.

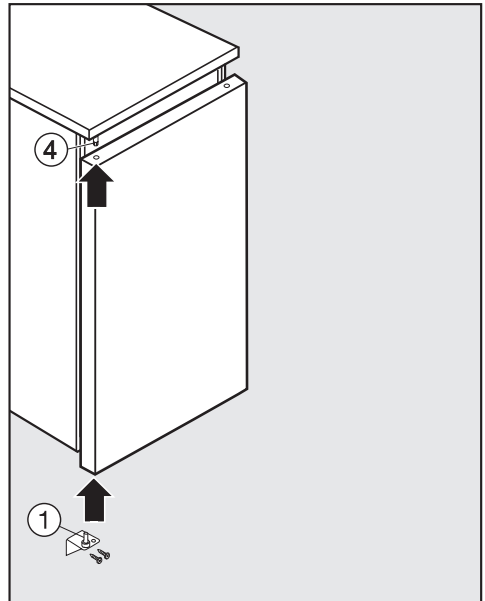

- Fit the appliance door from below onto upper hinge pin (4) and then close the appliance door.
- Screw hinge bracket (1) into the lower door bearing.
- Use the long slots in the hinge bracket to align the door. Make sure you have tightened all screws properly.

Changing the door hinging

Changing over the door handle

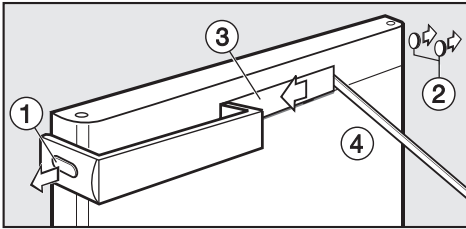

- Carefully remove cover ① and stoppers ② from the sides using a flatheaded screwdriver.
- Slide cover ③ over to the left and then insert a suitable plastic or wooden tool ④ into the gap on the right hand side.
- Carefully lever cover ③ out.

Be careful not to let the tool slip, causing damage to the appliance.

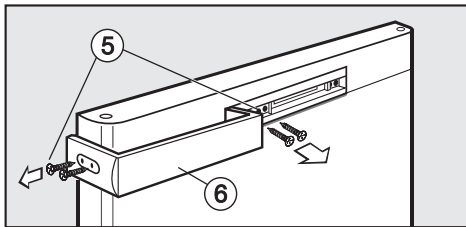

- Loosen screws ⑤ on the handle side and in the middle, and remove handle ⑥.

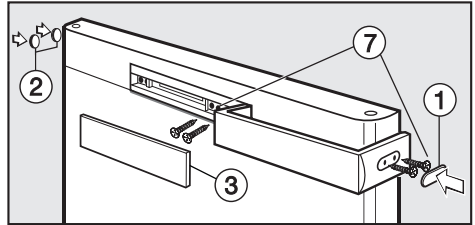

- Turn the handle 180° and fit to the opposite side.
- First screw it at the side and then in the middle ⑦.
- In the same way, replace cover ① and stoppers ② on the opposite side.
- Replace middle cover ③ by pushing it in, first on the left hand side, and then on the right.

Building in the appliance

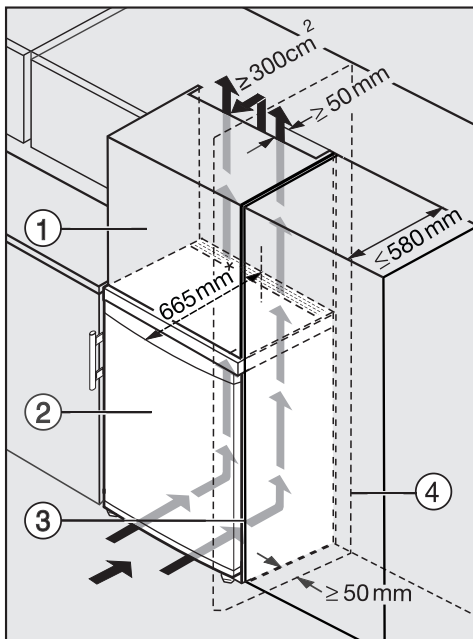

* For appliances supplied without wall spacers or without the wall spacers fitted, this measurement is reduced by 35 mm.

- ① Top box
- ② Appliance
- ③ Housing unit
- ④ Wall

The appliance can be installed in a kitchen run. To match the height of the rest of the kitchen, the appliance can be fitted with a suitable top box ①.

- A ventilation gap of at least 50 mm depth must be allowed for behind the appliance for air to circulate.

- The ventilation cross-section of the air outlet below the ceiling must be at least 300 cm² to ensure that air can circulate without hinderance.

The compressor will operate more economically, the larger the ventilation cross-section. Otherwise the appliance has to work longer and harder, resulting in an increase in electricity consumption and also an increase in the operating temperature of the compressor, which can result in damage to the compressor.

The ventilation gaps must not be covered or blocked in any way. They should be dusted on a regular basis.

When built into a kitchen run (max. depth 580 mm) the appliance can be installed directly next to a kitchen furniture housing unit. The appliance door will protrude in front of furniture fronts at the sides by 69 mm* and by 90 mm* in the middle of the door. This enables the door to be opened and shut without being obstructed.

When installed **next to a wall** ④ a distance of approx. 50 mm must be maintained on the hinge side between the wall ④ and the appliance ②, so that the door and the handle have sufficient space for opening.

United Kingdom

Miele Co. Ltd.
Fairacres, Marcham Road
Abingdon, Oxon, OX14 1TW
Tel: 0845 365 0555
Fax: 0845 365 0777
Customer Contact Centre Tel: 0845 365 6600
E-mail: info@miele.co.uk
Internet: www.miele.co.uk

Australia

Miele Australia Pty. Ltd.
ABN 96 005 635 398
1 Gilbert Park Drive, Knoxfield, VIC 3180
Tel: 1300 464 353, Fax: (03) 9764 7149
Internet: www.miele.com.au

China

Miele (Shanghai) Trading Ltd.
1-3 Floor, No. 82 Shi Men Yi Road
Jing' an District
200040 Shanghai, PRC
Tel: +86 21 6157 3500
Fax: +86 21 6157 3511
E-mail: mieleshanghai@cn.miele.com
Internet: www.miele.cn

Miele (Hong Kong) Limited

41/F - 4101, Manhattan Place
23 Wang Tai Road
Kowloon Bay
Hong Kong
Tel: (852) 2610 1331
Fax: (852) 2610 1013
Email: mielehk@miele.com.hk

India

Miele India Pvt. Ltd.
Ground Floor, Copia Corporate Suites
Plot No. 9, Jasola
New Delhi - 110025
Tel: 011-46 900 000, Fax: 011-46 900 001
E-mail: customercare@miele.in
Internet: www.miele.in

Manufacturer: Germany - Miele & Cie. KG
Carl-Miele-Straße 29, 33332 Gütersloh

Miele

Ireland

Miele Ireland Ltd.
2024 Bianconi Avenue
Citywest Business Campus, Dublin 24
Tel: (01) 461 07 10, Fax: (01) 461 07 97
E-Mail: info@miele.ie, Internet: www.miele.ie

New Zealand

Miele New Zealand Limited
Unit L, 10-20 Sylvia Park Road
Mt. Wellington, 1060, Auckland, NZ
Tel: 0800 264 353, Fax: 0800 463 453
Internet: www.miele.co.nz

Singapore

Miele Southeast Asia
Miele Pte. Ltd.
163 Penang Road
04 - 02/03 Winsland House II
Singapore 238463
Tel: +65 6735 1191, Fax: +65 6735 1161
E-Mail: infosea@miele.com.sg
Internet: www.miele.sg

South Africa

Miele (Pty) Ltd
63 Peter Place, Bryanston 2194
P.O. Box 69434, Bryanston 2021
Tel: +27 (0) 11 548-1900
Fax: +27 (0) 11 548-1935
E-mail: info@miele.co.za
Internet: www.miele.co.za

United Arab Emirates

Miele Appliances Ltd.
P.O. Box 11 47 82
Gold & Diamond Park
Sheikh Zayed Road
Building 6 / Offices Nos. 6-214 to 6-220
Dubai
Tel: +971-4-341 84 44
Fax: +971-4-341 88 52
E-Mail: info@miele.ae
Internet: www.miele.ae



Free Manuals Download Website

<http://myh66.com>

<http://usermanuals.us>

<http://www.somanuals.com>

<http://www.4manuals.cc>

<http://www.manual-lib.com>

<http://www.404manual.com>

<http://www.luxmanual.com>

<http://aubethermostatmanual.com>

Golf course search by state

<http://golfingnear.com>

Email search by domain

<http://emailbydomain.com>

Auto manuals search

<http://auto.somanuals.com>

TV manuals search

<http://tv.somanuals.com>