

## Operating instructions

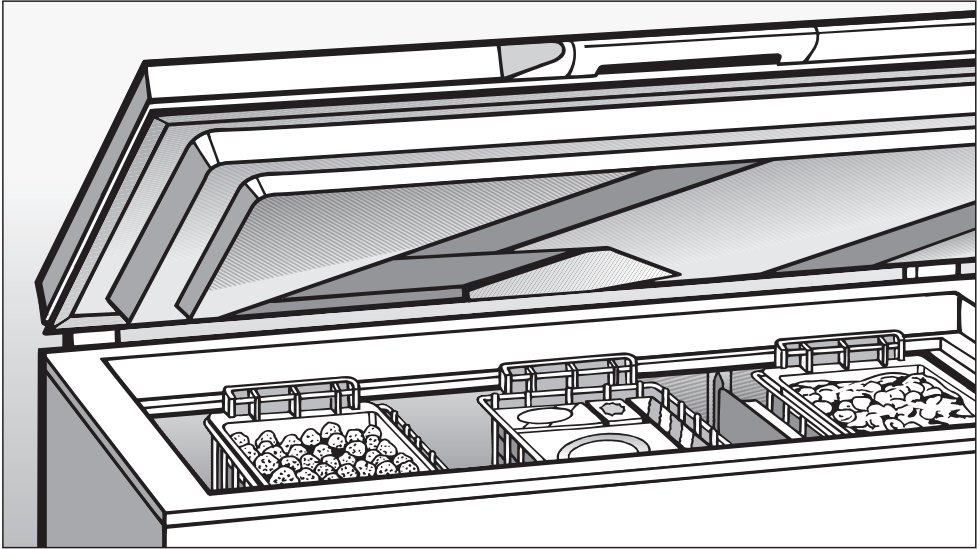

### Chest freezer with "Stop Frost" System GT 316 ES

To avoid the risk of accidents or damage to the appliance, it is **essential** to read these operating instructions before it is installed or used for the first time.

en - GB

M.-Nr. 07 524 490

# Contents

---

<b>Description of the appliance</b> . . . . .	4
<b>Caring for the environment</b> . . . . .	5
<b>Warning and Safety instructions</b> . . . . .	6
<b>How to save energy</b> . . . . .	11
<b>Switching on and off</b> . . . . .	12
Safety lock . . . . .	13
Switching off for longer periods of time . . . . .	14
<b>The correct temperature</b> . . . . .	15
Temperature selection . . . . .	15
Temperature range . . . . .	16
Temperature display . . . . .	16
<b>Alarm</b> . . . . .	17
Temperature alarm . . . . .	17
Alarm when the lid is left open . . . . .	17
Switching on the alarm system . . . . .	17
Switching the alarm off early . . . . .	17
<b>Super freeze</b> . . . . .	18
Super freeze . . . . .	18
<b>Interior</b> . . . . .	19
Baskets . . . . .	19
Initial freezing section . . . . .	19
<b>Freezing and storing food</b> . . . . .	20
Maximum freezing capacity . . . . .	20
Freezing fresh food . . . . .	20
Storing frozen food . . . . .	20
Home freezing . . . . .	21
Hints on home freezing . . . . .	21
Packing . . . . .	21
Before placing food in the freezer . . . . .	22
Placing food in the freezer . . . . .	22
Freezer planner . . . . .	22
Defrosting . . . . .	22
Cooling drinks . . . . .	23
Freezer tray . . . . .	23
Cool pack . . . . .	23

# Contents

---

<b>Defrosting</b> .....	24
"Stop Frost" system .....	24
<b>Cleaning and care</b> .....	26
Cleaning the outer casing, the interior and accessories .....	26
Ventilation gap .....	26
Freezer lid seal .....	26
<b>Problem solving guide</b> .....	28
<b>Noises</b> .....	31
<b>After sales service</b> .....	32
<b>Electrical connection</b> .....	33
<b>Installation</b> .....	34
Location .....	34
Climate range .....	34
Ventilation .....	34

# Description of the appliance

**Miele**  
ELECTRONIC

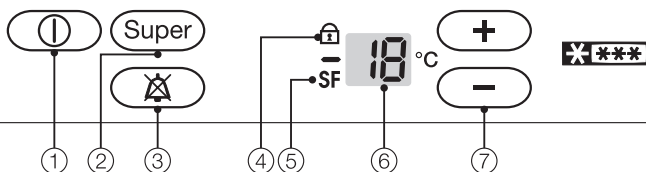

- ① On/Off button
- ② Super freeze button
- ③ Alarm off button
- ④ Safety lock indicator light
- ⑤ Super freeze indicator light
- ⑥ Temperature display
- ⑦ Buttons for setting the temperature  
(+ : warmer, - : colder)

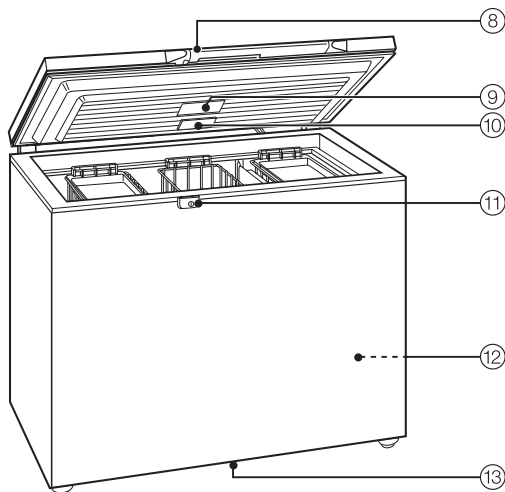

- ⑧ Control panel
- ⑨ Freezer planner
- ⑩ Interior lighting
- ⑪ Lock
- ⑫ Ventilation gap
- ⑬ Defrosting outlet

### Disposal of the packing material

The transport and protective packing has been selected from materials which are environmentally friendly for disposal, and can normally be recycled.

Ensure that any plastic wrappings, bags etc. are disposed of safely and kept out of the reach of babies and young children. Danger of suffocation!

Rather than just throwing these materials away, please ensure that they are recycled.

### Disposal of your old appliance

Electrical and electronic appliances often contain materials which, if handled or disposed of incorrectly, could be potentially hazardous to human health and to the environment. They are, however, essential for the correct functioning of your appliance. Please do not therefore dispose of it with your household waste.

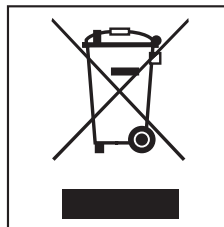

Please dispose of it at your local community waste collection / recycling centre or contact your dealer for advice. Ensure that it presents no danger to children while being stored for disposal.

It should be unplugged or disconnected from the mains electricity supply by a competent person.

Take care not to damage the pipework at the back of it before or during transportation to an authorised collection depot.

In this way, refrigerant in the pipework and oil in the compressor will be contained, and will not leak out into the environment.

# Warning and Safety instructions

---

This appliance complies with all relevant legal safety requirements. Improper use can, however, present a risk of both personal injury and material damage.

To avoid the risk of accidents and damage to the appliance, please read these instructions carefully before installation and before using it for the first time. They contain important notes on the installation, safety, operation and care of the appliance.

Keep these instructions in a safe place and pass them on to any future user.

## Correct application

► This appliance is intended for domestic use only, to store deep frozen food, freeze fresh food, and to make ice.

Any other usage is not supported by the manufacturer and could be dangerous. The manufacturer cannot be held liable for damage resulting from the incorrect or improper use of the appliance.

► This appliance is not intended for use by persons (including children) with reduced physical, sensory or mental capabilities, or lack of experience and knowledge, unless they are supervised whilst using it, or have been shown how to use it correctly by a person responsible for their safety.

## Safety with children

► This appliance is not a toy! To avoid the risk of injury or damage to the appliance, do not allow children to play on or near it, and do not let them hang from the lid or to play with the controls. With older children make sure that they are shown how to use it safely, and that they recognise the dangers of misuse.

► Lockable chest freezers:  
Do not keep the key near the appliance or within the reach of children. They could lock themselves in the appliance.

# Warning and Safety instructions

---

## Technical safety

▶ Before setting up the appliance, check it for any externally visible damage. Do not install and use a damaged appliance.

A damaged appliance is dangerous.

▶ If the connection cable is faulty it must only be replaced by a service technician authorised by the manufacturer to protect the user from danger.

▶ This appliance contains the coolant Isobutane (R600a), a natural gas which is environmentally friendly. Although it is flammable, it does not damage the ozone layer and does not increase the greenhouse effect. The use of this coolant has, however, led to a slight increase in the noise level of the appliance. In addition to the noise of the compressor, you might be able to hear the coolant flowing around the system. This is unavoidable, but does not have any adverse effect on the performance of the appliance.

Care must be taken during the transportation and installation of the appliance that no parts of the cooling system are damaged. Leaking coolant can damage the eyes.

In the event of any damage:

- avoid open flames and anything which creates a spark,
- disconnect from the mains,
- air the room in which the appliance is located for several minutes and
- contact the Service Department for advice.

▶ The more coolant there is in an appliance, the larger the room it should be installed in. In the event of a leakage, if the appliance is in a small room, there is the danger of combustible gases building up. For every 8 g of coolant at least 1 m<sup>3</sup> of room space is required. The amount of coolant in the appliance is stated on the data plate inside the appliance.

▶ Safe operation of the appliance is only assured if it has been installed and connected in accordance with these operating and installation instructions.

▶ Before connecting the appliance, make sure that the connection data on the data plate (voltage and connected load) match the mains electricity supply.

This data must correspond in order to avoid the risk of damage to the appliance. Consult a qualified electrician if in any doubt.

▶ Do not connect the appliance to the mains electricity supply by a multi-socket unit or an extension lead. These do not guarantee the required safety of the appliance (e.g. danger of overheating).

# Warning and Safety instructions

---

► The electrical safety of this appliance can only be guaranteed when continuity is complete between it and an effective earthing system which complies with current local and national safety regulations. It is most important that this basic safety requirement is present and tested regularly, and where there is any doubt, the household wiring system should be inspected by a qualified electrician. The manufacturer cannot be held liable for damage or injury caused by the lack of or inadequacy of an effective earthing system (e.g. electric shock).

► Installation, maintenance and repairs may only be carried out by a suitably qualified and competent person in strict accordance with current national and local safety regulations. Repairs and other work by unqualified persons could be dangerous. The manufacturer cannot be held liable for unauthorised work.

► While the appliance is under guarantee, repairs should only be undertaken by a service technician authorised by the manufacturer. Otherwise the guarantee will be invalidated.

► The appliance must be isolated from the electricity supply during installation, maintenance and repair work. The appliance is only completely isolated from the electricity supply when:

- it has been switched off at the wall socket and the plug has been withdrawn, or
- the fuse from the fused spur connection unit has been withdrawn, or
- the mains fuse has been disconnected, or
- the screw-out fuse is removed (in countries where this is applicable).

► Faulty components must only be replaced by genuine Miele original spare parts. The manufacturer can only guarantee the safety of the appliance when Miele replacement parts are used.

► This appliance may only be used in mobile installations such as ships if a risk assessment of the installation has been carried out by a suitably qualified engineer.

► In countries where there are areas which may be subject to infestation by cockroaches or other vermin, pay particular attention to keeping the appliance and its surroundings in a clean condition at all times. Any damage which may be caused by cockroaches or other vermin will not be covered by the guarantee.



# Warning and Safety instructions

---

## Correct use

- ▶ Never handle frozen food with wet hands. Your hands may freeze to the frozen food. Danger of frost burn.
- ▶ Do not take ice cubes out with your bare hands and never place ice cubes or ice lollies in your mouth straight from the freezer.  
The very low temperature of the frozen ice or lollies can cause frost burn to the lips and tongue.
- ▶ Do not refreeze thawed or partially thawed food.  
Defrosted food should be used up as quickly as possible, as food soon loses its nutritional value and goes off.  
Defrosted food may only be re-frozen after it has been cooked.
- ▶ Do not store explosive materials in the appliance or any products containing propellants (e.g. spray cans). Thermostats switching on may produce sparks which could present a fire hazard. Flammable compounds could explode.
- ▶ Do not operate any electrical equipment (e.g. an electric ice-cream maker) inside the appliance. Danger of sparking and explosion.
- ▶ Do not store cans or bottles containing carbonated drinks or liquids which could freeze in the freezer. The cans or bottles could explode.  
Danger of injury and damage to the appliance.

- ▶ When cooling drinks quickly in the chest freezer make sure bottles are not left in for more than one hour, otherwise they could burst. This could result in injury or damage.
- ▶ Observe the "use-by" dates given on food to avoid the risk of food poisoning. Storage times will depend on several factors, including the freshness and quality of the food as well as the temperature at which it is stored. Follow the instructions given on the food manufacturer's packaging regarding storage conditions and "use-by" dates.
- ▶ Do not use sharp edged objects to
  - remove frost and ice,
  - separate frozen foods or remove ice trays.They will damage the evaporator, causing irreversible damage to the appliance.
- ▶ Never place electric heaters or candles in the appliance to defrost it. These can damage the plastic parts.
- ▶ Do not use defrosting sprays or de-icers, as they might contain substances which could damage the plastic parts or which could cause a build-up of gases and pose a danger to health.
- ▶ Do not use any grease or oil on the seal of the freezer lid, as these will cause the seal to deteriorate and become porous with time.

# Warning and Safety instructions

---

▶ Do not block the ventilation gap in the appliance as this would impair the efficiency of the appliance, increase the electricity consumption and could cause damage to the appliance.

▶ The appliance is designed for use within certain climate ranges (ambient temperatures), and should not be used outside this range. The climate range for your appliance is stated on the data plate inside the appliance.

Installing it in a room with too low an ambient temperature, e.g. a garage, can lead to the appliance switching off for longer periods so that it cannot maintain the required temperature.

▶ Do not use a steam-cleaning appliance to defrost or clean this appliance. Steam could reach the electrical components and cause a short circuit.

## Disposing your old appliance

▶ Before disposing of an old appliance first make the lid latch or lock unusable.

This way you will prevent children from accidentally locking themselves in and endangering their lives.

▶ Be careful not to damage any part of the pipework whilst awaiting disposal, e.g. by

- puncturing the refrigerant channels in the evaporator.
- bending any pipework.
- scratching the surface coating.

Splashes of refrigerant can damage the eyes.

The manufacturer cannot be held liable for damage caused by non-compliance with these Warning and Safety instructions.

# How to save energy

	<b>Normal energy consumption</b>	<b>Increased energy consumption</b>
<b>Installation site</b>	In a ventilated room.	In an enclosed, unventilated room.
	Protected from direct sunlight.	In direct sunlight.
	Not situated near to a heat source (radiator, oven).	Situated near to a heat source (radiator, oven).
	Where the ideal ambient room temperature is approx. 20°C.	Where there is a high ambient room temperature.
<b>Temperature setting with a thermostat which is approximate (set in stages).</b>	With a medium setting of 2 to 3.	With a high setting: the lower the temperature in the compartment, the higher the energy consumption.
<b>Temperature setting with a thermostat which is exact to the degree (digital display).</b>	Cellar section 8 to 12°C	On appliances with winter setting, please make sure that the winter setting is switched off when the ambient temperature is warmer than 16 °C.
	Refrigerator section 4 to 5 °C	
	PerfectFresh zone just above 0 °C	
	Freezer section -18°C	
	Wine storage section 10 to 12 °C	
<b>Use</b>	Only open the doors when necessary and for as short a time as possible.	Frequent opening of the doors for long periods will cause a loss of coldness.
	Store food in an organised way.	If food is not stored in an organised way, searching for an item will mean the door is open for longer.
	Allow hot food and drinks to cool down before placing them in the appliance.	Placing hot food in the appliance will cause the compressor to run for a long time, as the appliance will have to work harder to lower the temperature.
	Store food covered or packaged.	The evaporation or condensation of liquids will cause a loss of coldness in the refrigerator.
	Place frozen food in the refrigerator to defrost.	
	Do not over-fill the appliance to allow air to circulate.	
<b>Defrosting</b>	Defrost the freezer compartment when a layer of ice 0.5 cm thick has built up.	A layer of ice hinders the cold from reaching the frozen food, and causes an increase in energy consumption.

# Switching on and off

## Before using for the first time

- Clean the appliance interior and all accessories with warm water and a little washing up liquid, and then dry with a soft cloth.

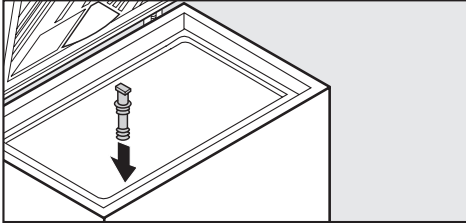

- Use the stopper supplied to plug the defrosting outlet in the bottom of the interior of the appliance.

Important: To ensure correct functioning of the appliance, let it stand for between 1 ½ and 2 hours after transporting it to its final location before connecting it to the mains.

## Switching on

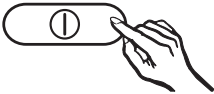

- Press the On/Off button.

Bars will light up in the temperature display. The freezer starts cooling. The interior light will come on when the lid is opened.

Allow the appliance to run for a few hours before placing food in it. This will ensure that the temperature is sufficiently low.

## Cool pack

To ensure that the cool pack freezes through quickly, place it at the bottom of the freezer in a corner against two of the side walls.

The cool pack will be at its most effective after it has been in the freezer for approx. 24 hours.

To save space, place the cool pack on the freezer tray once it is frozen.

## Switching off

- Press the On/Off button for approx. 3 seconds until the temperature display goes out.

If the temperature display does not go out, the safety lock is activated.

## Safety lock

The safety lock can be activated to prevent the appliance being switched off inadvertently.

### To activate the safety lock

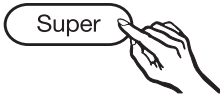

- Press and hold the Super freeze button for about 3 seconds.

*SF* will flash and *ε* will light up in the display.

- Press the Super freeze button again.

The *SF* and *ε* will flash and *Ⓛ* will light up in the display.

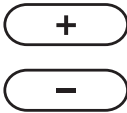

- Press one of the two temperature buttons.

The *SF* and *ε* will flash and *Ⓛ* will light up in the display.

- Press the Super freeze button.

The *SF* will flash and the safety lock symbol  and *Ⓛ* will light up in the display.

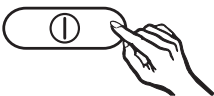

- Press the On/Off button.

The safety lock has been activated.

## De-activating the safety lock

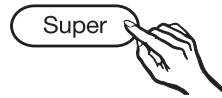

- Press and hold the Super freeze button for about 3 seconds.

*SF* will flash, and the safety lock symbol  and *Ⓛ* will light up in the display.

- Press the Super freeze button again.

*SF* and *ε* will flash, and the safety lock symbol  and *Ⓛ* will light up in the display.

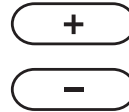

- Press one of the two temperature buttons.

*SF* and *ε* will flash and the safety lock symbol  and the *Ⓛ* will light up in the display.

- Press the Super freeze button.

The safety lock symbol  will go out. *SF* will flash and *Ⓛ* will light up in the display.

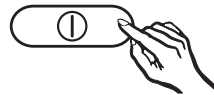

- Press the On/Off button.

The safety lock has been de-activated.

# Switching on and off

---

## Switching off for longer periods of time

If the appliance is not going to be used for a longer period of time, e.g. whilst on holiday

- switch off at the wall socket and withdraw the plug,
- defrost the appliance and then clean it, and
- leave the lid open to air the appliance.

If, during a long absence, the freezer is switched off but not cleaned out and the lid is left shut, there is a danger of mould and odours building up inside the appliance.

# The correct temperature

It is very important to set the correct temperature for storing food in the freezer. Micro-organisms will cause food which is not stored at the correct temperature to deteriorate rapidly. Temperature influences the growth rate of these micro-organisms. Reducing the temperature reduces their growth rate.

To freeze fresh food and to store frozen food for a long time, a temperature colder than **-18 °C** is required. At this temperature the growth of micro-organisms is generally halted. As soon as the temperature rises above -10 °C, the micro-organisms become active in the food again so that it cannot be kept as long. For this reason, partially defrosted or defrosted food must not be re-frozen. Food may be re-frozen once it has been cooked, as the high temperatures achieved when cooking destroy most micro-organisms.

The temperature in the freezer will rise:

- the more often the lid is opened and the longer it is kept open,
- if too much food is stored in it at once,
- the warmer the food is which is being put into it,
- the higher the ambient temperature surrounding the freezer.

The appliance is designed for use in specific ambient temperatures (climate ranges). Do not use in ambient temperatures for which it is not designed.

## Temperature selection

The temperature inside the appliance can be selected by pressing the +/- buttons.

Press the

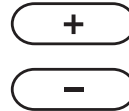

- + button: to raise the temperature
- button: to reduce the temperature

The temperature being set will flash in the display whilst you are setting it.

After setting the temperature you can see the following information in the display by pressing the +/- buttons:

- When first pressed, the **last temperature selected** flashes.
- Each subsequent press of the button adjusts the temperature shown in 1 °C steps.
- Keeping the button pressed in adjusts the temperature continually.

Approx. 5 seconds after letting go of the button, the current **actual** temperature of the freezer is automatically shown.

# The correct temperature

---

If you have adjusted the temperature, **wait for approx. 6 hours if the appliance is not very full and for approx. 24 hours if the appliance is full**, before checking the temperature display as it will take this long for the display to show the accurate temperature of the appliance. If, after this time, the temperature is still too high or too low, you will need to adjust it again.

## Temperature range

Temperatures between  $-14\text{ }^{\circ}\text{C}$  and  $-28\text{ }^{\circ}\text{C}$  can be selected.

The ambient temperature in the room and the installation location can affect the time it takes for the appliance to reach the lowest temperature. If the ambient temperature is too high, the appliance may not reach the lowest temperature.

## Temperature display

During normal operation, the temperature display on the control panel shows the average temperature in the freezer.

If the temperature in the appliance is not within the range that the appliance is able to display (i.e. if it is above  $0\text{ }^{\circ}\text{C}$ ), only bars will light up in the temperature display.

The **temperature display will flash**, if

- a different temperature is being set,
- the temperature has risen too much, as a warning that the appliance is no longer cold enough.

This loss of coldness is no cause for concern in the following circumstances:

- when the lid has been left open for a while, e.g. for removing or storing a large amount of food,
- when fresh food is being frozen.

As soon as the temperature has fallen to approx.  $-10\text{ }^{\circ}\text{C}$ , the temperature display ceases to flash and lights up constantly.

However, if the temperature remains above  $-18\text{ }^{\circ}\text{C}$  for a long time, check that the frozen food has not started to defrost. If this is the case, check that the food is safe to use and, if it is, then use it as soon as possible.



Your freezer has been fitted with a warning system which ensures that the temperature in the freezer cannot rise unnoticed and to avoid energy being wasted if the lid is left open.

## Temperature alarm

An alarm will sound and the temperature display will flash if the temperature becomes too warm.

The alarm will sound and the temperature display will also flash:

- if the freezer lid has been left open for a while, e.g. in order to load, re-arrange or take food out of the freezer.
- when freezing large amounts of food.
- if the appliance has been switched off for an extended period, and is switched on again.

## Alarm when the lid is left open

The alarm will sound if the lid is left open for longer than approx. 60 seconds.

## Switching on the alarm system

The warning system works automatically once the temperature in the freezer is cold enough.

## Switching the alarm off early

As soon as the temperature in the freezer has dropped sufficiently, the alarm switches off and the temperature display stops flashing and lights up constantly. However, if the noise disturbs you, you can turn the alarm off before this if you wish.



- Press the alarm off button.

The alarm will stop. The temperature display will continue to flash until the temperature in the freezer has reached  $-10^{\circ}\text{C}$ . The display then stops flashing and lights up constantly. The alarm system is now ready should it be needed again.

# Super freeze

---

## Super freeze

Switch the Super freeze function on before putting fresh food into the freezer.

### Exceptions:

- when putting in food that is already frozen.
- when freezing less than 2 kg fresh food daily.

## Switching on Super freeze

When freezing small quantities of food in the freezer, the Super freeze function should be switched on **6 hours beforehand**. When freezing **the maximum load of food** the Super freeze function should be switched on **24 hours beforehand**.

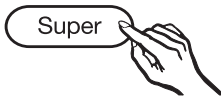

- Press the Super freeze button.

The Super freeze indicator light **5F** comes on.

The temperature in the freezer falls, and the freezer operates on the coldest setting.

## Switching Super freeze off

Depending on the amount of food placed in the freezer, the Super freeze function will switch off automatically after approx. 30 to 60 hours. The Super freeze indicator light will go out and the appliance will continue to operate at normal power.

To save energy, the Super freeze function can be switched off once a **constant** temperature of -18 °C or colder has been reached in the freezer.

- Press the Super freeze button.

The Super freeze indicator light **5F** will go out, and the appliance will continue to operate at normal power.

## Baskets

The baskets make it easier to arrange the food in the freezer.

- Hang the baskets by hooking the handles onto the rim of the freezer, or
- Stack the baskets in the freezer:
  - place one of the baskets on the floor of the freezer.

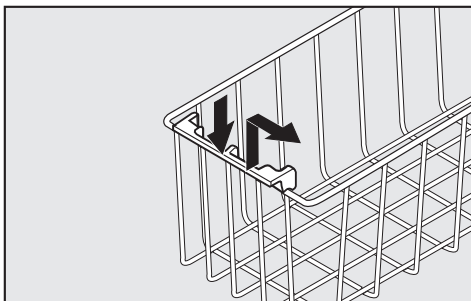

- press the handles down on this basket, then lift them up and swing them inwards.
- now place another basket on top of the lower basket.

## Initial freezing section

(One or two freezer trays are supplied, depending on model.)

You can use the freezer trays to create a separate zone in the freezer.

This zone can then be used for freezing fresh food separately from food which is already frozen.

To create a separate freezing zone

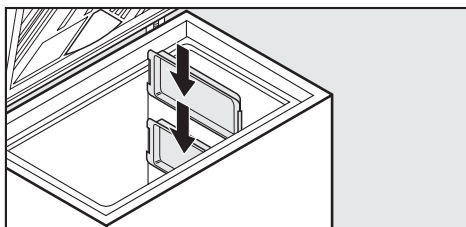

- Slide the freezer trays one above the other into the slots provided.

If you do not wish to have a separate freezing zone, stack the freezer trays under one of the baskets.

# Freezing and storing food

---

## Maximum freezing capacity

To ensure that fresh food placed in the freezer freezes through to the core as quickly as possible, the maximum freezing capacity must not be exceeded. The maximum freezing capacity for freezing within a 24-hour period is given on the data plate "Freezing capacity ....kg/24 hrs".

## Freezing fresh food

Fresh food should be frozen as quickly as possible. This way the nutritional value of the food, its vitamin content, appearance and taste are not impaired.

Food which takes a long time to freeze will lose more water from its cells, which then shrink.

During the defrosting process, only some of this water is reabsorbed by the cells; the rest collects around the food. In practice this means that the food loses a large degree of its moisture.

If food is frozen quickly, the cells have less time to lose moisture, so they shrink less.

As there is not so much moisture, it is easier for the food to reabsorb it during the defrosting process and very little water collects around the defrosted food.

## Storing frozen food

When buying frozen food to store in your freezer, check

- that the packaging is not damaged,
- the use-by date,
- the temperature at which the frozen food is being stored in the shop. The length of time it can be kept is reduced if it has been stored at a temperature warmer than -18 °C.

- Buy frozen food once you have finished the rest of your shopping, and wrap it in newspaper or use a cool bag or box to transport it.
- Store it in the freezer as soon as possible.

Never re-freeze partially or fully defrosted food. Consume defrosted food as soon as possible as it will lose its nutritional value and spoil if left for too long. Defrosted food may only be re-frozen after it has been cooked.

## Home freezing

Only freeze fresh food which is in good condition.

### Hints on home freezing

- The following types of food **are suitable** for freezing:  
Fresh meat, poultry, game, fish, vegetables, herbs, fresh fruit, dairy products, pastry, leftovers, egg yolks, egg whites and a range of pre-cooked meals.
- The following types of food **are not suitable** for freezing:  
Grapes, lettuce, radishes, sour cream, mayonnaise, eggs in their shells, onions, whole raw apples and pears.
- To retain colour, taste and vitamin C, vegetables should be blanched after they have been trimmed and washed. To blanch: bring a large saucepan of water to the boil and immerse the vegetables in the fast boiling water for 2-3 minutes, depending on the variety. Remove, and plunge into ice cold water to cool quickly. Drain and pack ready for freezing.
- Lean meat freezes better than fatty meat, and can be stored for considerably longer.
- To prevent chops, steaks, cutlets or rolled meat from freezing together in solid blocks when packed, separate with a sheet of plastic freezer film.
- Do not season fresh foods or blanched vegetables before freezing. Only season cooked dishes

sparingly, but care should be taken as the taste of some spices alters when frozen.

- Do not place hot food or drinks in the freezer. This causes already frozen food to thaw and increases the energy consumption considerably. Allow hot food and drinks to cool down before placing them in the freezer.

### Packing

- Freeze food in portions.

#### Unsuitable packing material

- wrapping paper
- grease-proof paper
- cellophane
- bin bags
- plastic carrier bags

#### Suitable packing material

- plastic freezer film
- freezer bags
- aluminium foil
- freezer containers

- Expel as much air as possible from bags etc. before sealing them, to prevent freezer burn on food.
- Close the packaging tightly with
  - rubber bands
  - plastic clips
  - string or bag ties
  - freezer tape.

Freezer bags may also be sealed using home heat-sealing kits.

- Make a note of the contents and the date of freezing on the packaging.

# Freezing and storing food

---

## Before placing food in the freezer

- When freezing more than 2 kg of fresh food, switch on the Super freeze function for some time before placing the food in the freezer (see "Super freeze").

## Placing food in the freezer

- Place fresh food into the area that you have already divided from the rest of the freezer by means of the two freezer trays, so that it is separated from food which is already frozen.

When freezing, make sure that food already frozen does not come into contact with fresh food being frozen as this could cause the frozen food to begin to defrost.

- Arrange frozen food in an organised way in the freezer.
- Make sure that the packaging and containers are dry to prevent them sticking together when frozen.

Do not stack food higher than the top of the basket.

## Freezer planner

The freezer planner on the inside of the lid shows the number of months for which various foods can be stored effectively. However, these times should be regarded only as a guide, as various factors can affect the storage time, e.g. the quality of the food, how it is handled prior to freezing etc.

## Defrosting

Frozen food can be defrosted in different ways:

- in a microwave,
- in an oven using the "Fan" or "Defrost" setting,
- at room temperature,
- in a refrigerator,
- in a steam oven.

**Fruit** should be defrosted at room temperature in its packing, or in a covered bowl.

**Most vegetables** can be cooked while still frozen. Just put straight into boiling water or hot fat. The cooking time is slightly less than that of fresh vegetables.

**Poultry** It is particularly important to observe food hygiene rules when defrosting poultry. Do not use the liquid from defrosted poultry. Pour it away, wash the container it was in, the sink and your hands.

Never re-freeze partially or fully defrosted food. Consume defrosted food as soon as possible as it will lose its nutritional value and spoil if left for too long. Defrosted food may only be re-frozen after it has been cooked.

## Cooling drinks

When cooling drinks quickly, make sure bottles are not left in the freezer for **more than one hour**, as they could burst.

## Freezer tray

The freezer tray is useful for freezing small items such as berries and vegetables. They can be frozen individually and therefore maintain their shape when defrosted.

- Place the food spaced out on the tray.

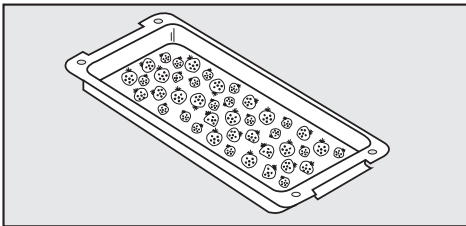

- Hang the tray in a basket.

Leave food for 10 - 12 hours to freeze thoroughly on the tray. Transfer it to a freezer bag or suitable container once frozen.

## Cool pack

The cool pack prevents the temperature in the freezer rising too quickly in the event of a power cut.

To ensure that the cool pack freezes through quickly, place it at the bottom of the freezer in a corner against two of the side walls.

The cool pack will be at its most effective after it has been in the freezer for approx. 24 hours.

To save space, place the cool pack on the freezer tray once it is frozen.

If there is a power cut, place the cool pack directly on top of the frozen food so that the food will be kept cold for the longest time possible.

The cool pack can also be used in a cool bag to keep food or drinks cool for a short period of time.

# Defrosting

## "Stop Frost" system

In normal use, ice and frost will form on the evaporator plates. If allowed to accumulate, this will impair the efficiency of the freezer and increase the consumption of electricity.

The "Stop Frost" system reduces the build up of ice and frost by approx. 70 % in comparison to other appliances. Moisture entering the appliance is quickly collected and removed. This means that it is not necessary to defrost the appliance nearly as often.

Only use the scraper supplied with the appliance to scrape off ice and frost.

Otherwise the evaporator plates could become damaged, making the freezer unusable.

The freezer should be defrosted from time to time. It must be defrosted if a layer of ice approx. 0.5 cm thick has accumulated. It is best to defrost when only very little food or no food at all is left in the freezer.

## Before defrosting

- Switch on the Super freeze function approx. 1 day before defrosting to ensure frozen food retains its cold reserve for longer when taken out of the freezer.
- Remove the frozen food from the freezer and place it in another freezer, or in a cool-box, or wrap it in several layers of newspaper or cloth and store in a cool place until the freezer is ready for use again.

## To defrost

Carry out the defrosting procedure as quickly as possible if food has not been placed in another freezer. The longer the food is left out at room temperature, the more it defrosts.

- Switch the appliance off.

If the temperature display does not switch off, the safety lock is activated.

- Switch off at the wall socket and withdraw the plug.
- Place a freezer tray or a flat container under the defrosting outlet. Any defrosted water will then collect in the tray / container.

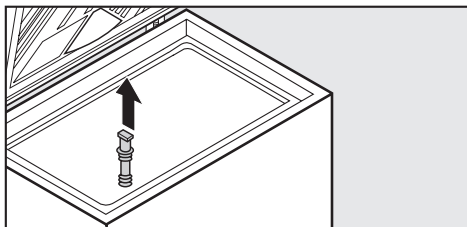

- Wait until the stopper has defrosted, and then pull it out of the floor of the appliance.
- Leave the lid of the freezer open.

To speed up defrosting, a bowl containing hot water (not boiling) can be placed in the appliance.



We do not recommend the use of hot air blowers such as hairdryers for defrosting your appliance.

Never place electric heaters or candles in the appliance to defrost it. These can damage the plastic parts.

Do not use defrosting sprays or de-icers, as they could contain substances which could damage the plastic parts and which may cause a build-up of gases and pose a danger to health.

## After defrosting

- Mop up any residual water still in the freezer with a sponge or absorbent cloth.
- Clean the freezer and then dry it thoroughly.
- Plug the outlet for defrosted water with the stopper.
- Close the lid and insert the mains plug in the wall socket and switch it on.
- Switch on the Super freeze function so that the freezer section can cool down quickly.  
The **5F** indicator light will come on.
- Place the food back in the freezer once the temperature is cold enough.
- The Super freeze function can be switched off as soon as  $-18\text{ }^{\circ}\text{C}$  is reached.  
The indicator light will go out.

# Cleaning and care

---

A range of Miele branded cleaning and conditioning products is available from the Miele Spare Parts Department or via the internet at [www.miele-shop.com](http://www.miele-shop.com).

Never use cleaning agents containing abrasive substances such as sand, soda, acids or chemical solvents. "Non-abrasive" cleaning agents are also unsuitable as they can cause matt areas to appear.

Do not let water get into the electronic unit or into the ventilation gap.

Do not use steam cleaning apparatus to clean the appliance. Steam could reach the electrical components and cause a short circuit.

The data plate must not be removed. It contains information which is required in the event of a service call.

- The appliance must be switched off at the wall socket and the plug removed. Take any food out of the appliance and store it in a suitable cool place (e.g. cool box or another freezer). Take out the accessories for cleaning.
- Clean the appliance immediately after defrosting it.

## Cleaning the outer casing, the interior and accessories

Use warm water with a little washing up liquid. Wash all accessories by hand only. Do not wash in a dishwasher.

- After cleaning wipe the outer casing, interior and accessories with a damp cloth and dry with a soft cloth. Leave the lid of the freezer open for a while.

## Ventilation gap

- Dust the ventilation gap regularly with a brush or vacuum cleaner. A build-up of dust will increase the energy consumption of the appliance.

## Freezer lid seal

Do not use any grease or oil on the seal as these will cause the seal to deteriorate and become porous over time.

The seal should be cleaned regularly with clean water and then wiped dry with a soft cloth.

### After cleaning

- Close the lid, insert the mains plug, switch on at the wall socket and switch the appliance on.
- Switch on the Super freeze function so that the freezer can cool down quickly.  
The indicator light will come on.
- Place the food back in the freezer once the temperature has cooled down sufficiently (it must be -10°C or colder).
- The Super freeze function can be switched off as soon as -18 °C is reached.  
The indicator light will go out.

# Problem solving guide

---

Repairs to electrical appliances should only be carried out by a suitably qualified and competent person in accordance with local and national safety regulations. Repairs and other work by unqualified persons could be dangerous. The manufacturer cannot be held liable for unauthorised work.

## What to do if . . .

### . . . the appliance does not get cool.

- Check that the appliance is switched on. The temperature display must be lit up.
- Check that the plug is correctly inserted in the socket and switched on.
- Check that the fuse is not defective and that the mains fuse has not blown. If it has, contact the Miele Service Department.

### . . . the temperature is too low.

- Select a warmer temperature.
- The Super freeze function is switched on. The indicator light is still on.

### . . . the appliance is switching in too frequently and for too long.

- Check whether the ventilation gap has been covered over or become too dusty.
- The lid has been opened too frequently, or a large amount of fresh food has been put in at once for freezing.

- Check that the lid has been closed properly.
- Check whether a thick layer of ice has built up. If it has, then the freezer will need defrosting.

### . . . the alarm sounds

- Has the lid been open for longer than 60 seconds?

### . . . the alarm sounds and the temperature display flashes.

The freezer is too warm, because

- the lid has been opened too frequently, or large amounts of fresh food have been put in at once for freezing.
- the appliance has been switched off for an extended period, and has been switched on again.
- the ventilation gap is blocked.

Once the temperature has reached  $-10^{\circ}\text{C}$ , the alarm will stop and the temperature display will light up constantly.

### . . . bars light up in the temperature display.

Check the temperature display about 6 hours after switching on the appliance. The temperature will only show in the display once the temperature inside the appliance falls below  $0^{\circ}\text{C}$ .

### **... "F4" or "F5" appears in the temperature display.**

There is a fault. Call the Service Department. The safety switch-off device will maintain the temperature of the appliance. Keep the lid shut.

### **... the alarm sounds and "nA" appears in the temperature display.**

The temperature has risen too high at some point during the last couple of days because of a power cut.

- Press the alarm button whilst "nA" is lit up in the display.

The alarm will stop. The temperature display will show the warmest temperature recorded in the freezer during the power cut.

Depending on the temperature displayed, you should check the condition of food in the freezer. If it has defrosted or started to defrost check that it is still safe to use, and if so, use it as quickly as possible. Defrosted food may only be re-frozen after it has been cooked.

The warmest temperature will show in the display for about 1 minute. The display will then revert to showing the actual current temperature in the freezer.

The display can be switched off manually by pressing the alarm off button.

### **... the Super freeze indicator light does not light up even though the appliance is working.**

It can take up to 8 minutes for the appliance to switch on after the Super freeze button has been pressed. This is due to a built-in delay switch, which helps prolong the life of the appliance.

### **... you cannot switch the appliance off.**

The safety lock has been activated.

### **... food has frozen together.**

Use a blunt instrument, e.g. a spoon handle or plastic scraper, to prise it apart carefully.

### **... there is a thick layer of ice in the freezer.**

- Check that the lid has been properly closed.
- Defrost and then clean the freezer.

Too thick a layer of ice reduces efficiency and increases energy consumption.

## Problem solving guide

---

### . . . the interior light is not working.

The lamp needs changing.

- Switch off at the wall socket and withdraw the plug.

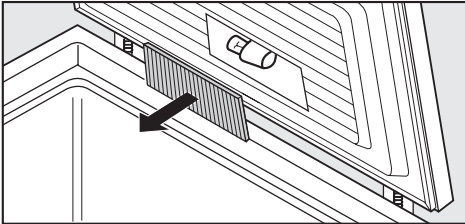

- Take off the cover in the direction of the arrow.
- Unscrew the lamp and replace it with a new one.

Lamp specification:  
220-240 V, **max. 15 W**, E 14 fitting.

- Replace the cover.

If you still cannot remedy the fault having followed these suggestions, please contact the Miele Service Department.

To prevent unnecessary loss of temperature, it is advisable not to open the lid while waiting for the appliance to be serviced.

Normal noises	What causes them
<b>Brrrrr...</b>	Humming noise made by the motor (compressor). This noise can get louder for brief periods when the motor is switching on.
<b>Blubb, blubb....</b>	A gurgling noise can be heard when coolant is circulating through the pipes.
<b>Click....</b>	Clicking sounds are made when the thermostat switches the motor on and off.
<b>Sssrrrrr....</b>	On multi-zone and frost-free appliances you can sometimes just hear the movement of air circulating inside the appliance.

Remember that the noise of the compressor and the coolant circulating in the system is unavoidable.

Noises that you can easily rectify	What causes them, and what can you do about them?
<b>Rattling, vibrating</b>	<b>The appliance is uneven:</b> Realign the appliance using a spirit level, by raising or lowering the screw feet underneath the appliance.
	<b>The appliance is touching another appliance or piece of furniture:</b> Move it away.
	<b>Drawers, baskets or shelves are unstable or sticking:</b> Check all removable items and refit them correctly.
	<b>Are any bottles or containers unstable or knocking against each other?</b> Separate them.
	<b>The transport cable clips are hanging loose at the back of the appliance:</b> Remove the clips.

## After sales service

---

In the event of a fault which you cannot correct yourself, or if the appliance is under guarantee, please contact:

– your Miele Dealer

or

– the Miele Service Department  
(see back cover for contact details).

When contacting your Dealer or Miele, please quote the model and serial number of your appliance, both of which are shown on the data plate on the outside of the appliance.

Please note that telephone calls may be monitored and recorded for training purposes.

N.B. A call-out charge will be applied for service visits where the problem could have been resolved as described in these instructions.

### **Guarantee**

For information on the appliance guarantee specific to your country please contact Miele. See back cover for contact details.

In the U.K. your appliance is guaranteed for 2 years from the date of delivery. However, you must activate your cover by calling 08706 080028 or registering online at [www.miele.co.uk](http://www.miele.co.uk).



## Electrical connection U.K.

All electrical work should be carried out by a suitably qualified and competent person in strict accordance with current local and national safety regulations (BS 7671 in the UK).

The appliance is supplied with a mains cable and moulded plug ready for connection to an a.c. single phase 220-240 V 50 Hz supply.

Please ensure that the connection data quoted on the data plate match the household mains supply.

Connection should be made via a suitable switched socket which is easily accessible. For extra safety it is advisable to install a suitable residual current device (RCD).

Do not connect the appliance to the mains electricity supply by an extension lead. Extension leads do not guarantee the required safety of the appliance (e.g. danger of overheating).

The appliance must not be connected to an inverter and must not be used with a plug adapter as these can cause damage to the appliance's electronic unit.

## Non-rewireable plugs (BS 1363)

The fuse cover must be re-fitted when changing the fuse, and if the fuse cover is lost, the plug must not be used until a suitable replacement is obtained. The colour of the correct replacement cover is that of the coloured insert in the base of the plug, or the colour that is embossed in words in the base of the plug (as applicable to the design of the plug fitted).

Replacement fuses should be ASTA approved to BS 1362 and have the correct rating. Replacement fuses and fuse covers may be purchased from your local electrical supplier.

**WARNING**  
**THIS APPLIANCE MUST BE**  
**EARTHED**

# Installation

---

## Location

The appliance should be installed on a level and stable surface.

Do not install the appliance up against other appliances or units. There must be a minimum distance of 20 mm all around the appliance to ensure sufficient ventilation.

It should be situated far enough away from a wall to ensure that the lid can be opened and closed easily.

The appliance should be installed in a dry, well-ventilated room.

The room temperature should not go above or below the climate range for which the appliance is designed.

The higher the ambient temperature of the room, the more energy the appliance requires to operate.

It should not be installed where it is exposed to direct sunlight or directly adjacent to a heat-producing appliance such as an oven or a radiator.

## Climate range

The appliance is designed for use within certain climate ranges (ambient temperatures), and should not be used outside this range. The climate range of this appliance is stated on the data plate on the outside the appliance.

---

<b>Climate range</b>	<b>Ambient room temperature</b>
SN, N	up to +32 °C
ST	up to +38 °C
T	up to +43 °C

---

The appliance will function perfectly down to an ambient temperature of +5 °C.

## Ventilation

In order to ensure sufficient ventilation

- the gap between the bottom edge of the freezer and the floor on which it is standing must not be covered.
- there must be a minimum distance of 20 cm from the ventilation gap to the wall to ensure that ventilation to and from the appliance is unhindered.
- the ventilation gap should be dusted on a regular basis.





## United Kingdom

Miele Co. Ltd.  
Fairacres, Marcham Road  
Abingdon, Oxon, OX14 1TW  
Tel: (01235) 554455  
Fax: (01235) 554477  
Customer Contact Centre Tel: (08707) 554466  
E-mail: [info@miele.co.uk](mailto:info@miele.co.uk)  
Internet: [www.miele.co.uk](http://www.miele.co.uk)

## Australia

Miele Australia Pty. Ltd.  
ABN 96 005 635 398  
1 Gilbert Park Drive, Knoxfield, VIC 3180  
Tel: (03) 9764 7130  
Fax: (03) 9764 7149  
Internet: [www.miele.com.au](http://www.miele.com.au)

## China

Miele Shanghai  
Suite 4105-06, Plaza 66  
1266 Nanjing Road West  
Jing An District  
Shanghai 200040, PRC  
Tel: +86 21 6288 4200  
Fax: +86 21 6288 4100  
E-mail: [miele Shanghai@cn.miele.com](mailto:miele Shanghai@cn.miele.com)  
Internet: [www.miele.cn](http://www.miele.cn)

## Hong Kong

Miele (Hong Kong) Limited  
AIA Plaza, 24<sup>th</sup> Floor  
18 Hysan Avenue  
Causeway Bay  
Tel: +852- 2610-1331  
Fax: +852-2610-1013  
E-mail: [mielehk@miele.com.hk](mailto:mielehk@miele.com.hk)  
Internet: [www.miele.hk](http://www.miele.hk)

## Ireland

Miele Ireland Ltd.  
Broomhill Road, Tallaght, Dublin 24  
Tel: (01) 461 0710  
Fax: (01) 461 07 97  
E-Mail: [info@miele.ie](mailto:info@miele.ie)  
Internet: [www.miele.ie](http://www.miele.ie)

## New Zealand

Miele New Zealand Limited  
Unit L, 10-20 Sylvia Park Road  
Mt. Wellington, 1060, Auckland, NZ  
Tel: 0800 264 353  
Fax: 0800 463 453  
Internet: [www.miele.co.nz](http://www.miele.co.nz)

## South Africa

Miele (Pty) Ltd  
63 Peter Place, Bryanston 2194  
P.O. Box 69434, Bryanston 2021  
Tel: +27 (0) 11 548-1900  
Fax: +27 (0) 11 548-1935  
E-mail: [info@miele.co.za](mailto:info@miele.co.za)  
Internet: [www.miele.co.za](http://www.miele.co.za)

## Singapore

Miele Southeast Asia  
Miele Pte. Ltd.  
163 Penang Road  
# 04 - 02/03 Winsland House II  
Singapore 238463  
Tel: +65 6735 1191  
Fax: +65 6735 1161  
E-Mail: [infosea@miele.com.sg](mailto:infosea@miele.com.sg)  
Internet: [www.miele.sg](http://www.miele.sg)

## United Arab Emirates

Miele Appliances Ltd.  
P.O. Box 11 47 82  
Gold & Diamond Park  
Sheikh Zayed Road  
Building 6 / Offices Nos. 6-214 to 6-220  
Dubai  
Tel: +971-4-341 84 44  
Fax: +971-4-341 88 52  
E-Mail: [info@miele.ae](mailto:info@miele.ae)  
Internet: [www.miele.ae](http://www.miele.ae)



## Free Manuals Download Website

<http://myh66.com>

<http://usermanuals.us>

<http://www.somanuals.com>

<http://www.4manuals.cc>

<http://www.manual-lib.com>

<http://www.404manual.com>

<http://www.luxmanual.com>

<http://aubethermostatmanual.com>

Golf course search by state

<http://golfingnear.com>

Email search by domain

<http://emailbydomain.com>

Auto manuals search

<http://auto.somanuals.com>

TV manuals search

<http://tv.somanuals.com>