

Operating instructions

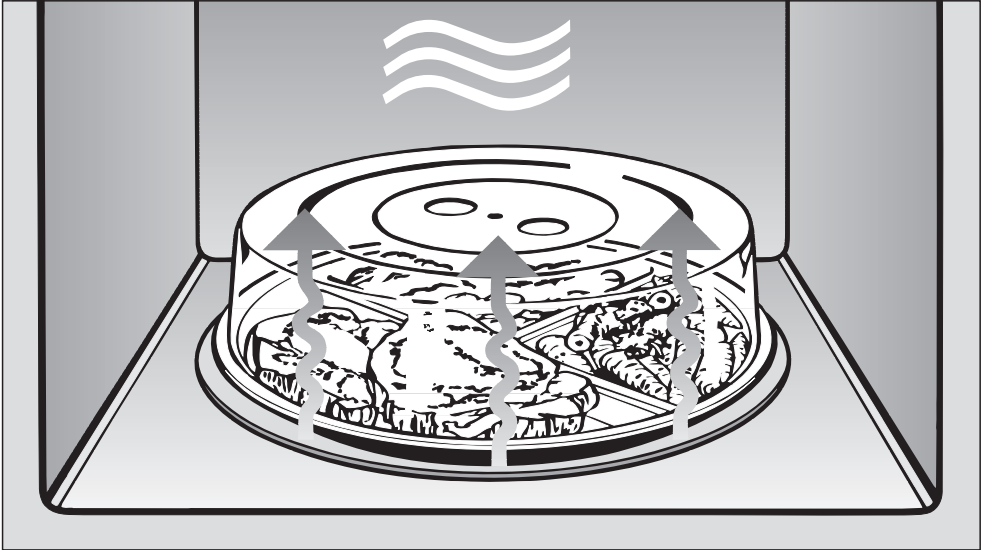

Microwave oven M 8151-1 M 8161-1

To avoid the risk of accidents or damage to the appliance it is **essential** to read these instructions before it is installed or used for the first time.

en - GB

M.-Nr. 07 088 080

Contents

Description of the appliance	4
Oven interior and accessories	4
Control panel	5
Accessories supplied	6
Grilling rack	6
Glass tray	6
Gourmet plate	6
Cover	6
Boiling rod	6
Caring for the environment	7
Warning and Safety instructions	8
How the microwave oven works	14
Modes of operation	15
What can a microwave oven do?	15
In what ways can a microwave oven be used?	15
Microwave Solo mode	15
Grilling	15
Combination mode (Microwave + Grill)	15
Automatic programmes	15
Suitable containers for microwave ovens	16
Material and shape	16
Testing dishes for their suitability	18
The cover	19
Before using for the first time	20
Time of day display	21
Setting the time of day	21
Altering the time of day	21
Switching off the time of day display	21
Night time switch-off	21
Operation	22
To open the door	22
Placing the dish in the oven	22
Turntable	22
To close the door	22
Starting a programme	22
"door" message	23

Interrupting or re-starting a programme	24
Altering the settings	24
To cancel a programme	24
At the end of a programme	24
Automatic warming function	24
Quick start (programmable)	25
System lock	25
Minute minder	26
Altering a minute minder entry	26
Minute minder + cooking function	26
Operation - Grilling	27
Gourmet plate.	29
Use.	29
Some suggested uses.	29
Recipes	30
Operation - Automatic programmes	34
Automatic defrosting	34
Automatic cooking	34
Saving your favourite programme	36
Changing the settings	38
Reheating	40
Cooking.	41
Defrosting/Defrosting and reheating or cooking	42
Some suggested uses	43
Cleaning and care	44
Oven interior and inside of the door	44
Appliance front	45
Accessories supplied	46
Problem solving guide	47
After sales service	49
Electrical connection	50
Installation	51

Description of the appliance

Oven interior and accessories

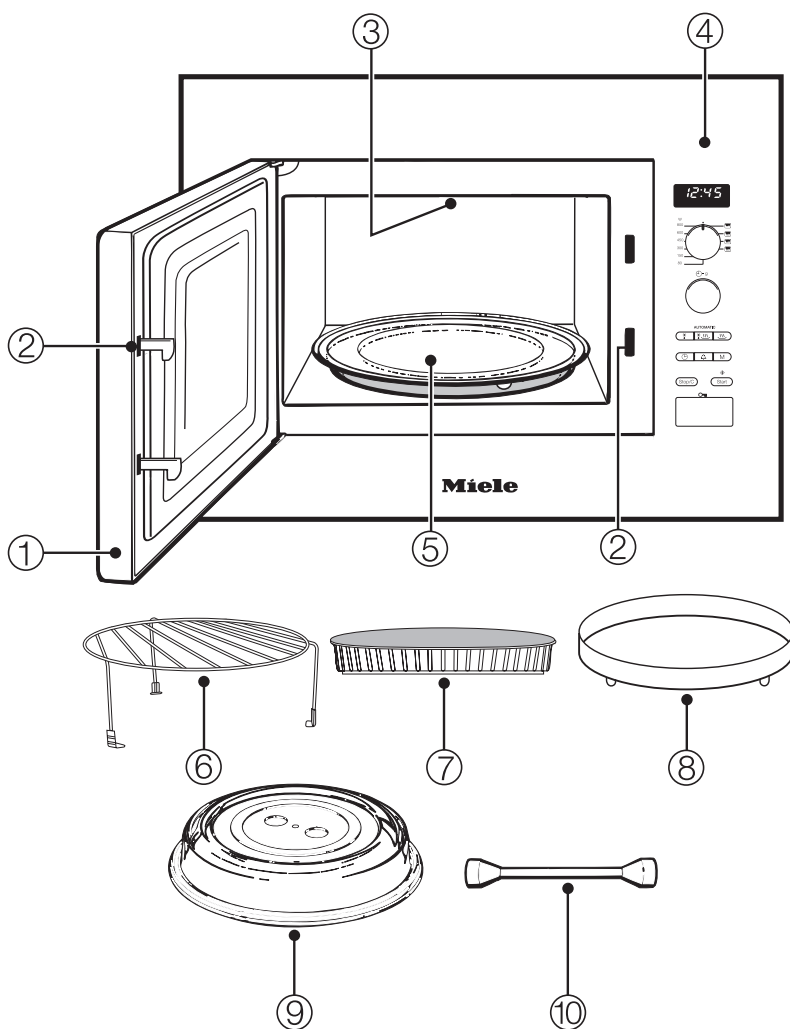

① Oven door

② Door locking mechanism

③ Quartz grill

④ Control panel

⑤ Turntable

⑥ Grilling rack

⑦ Glass tray

⑧ Gourmet plate

⑨ Cover

⑩ Boiling rod

Control panel

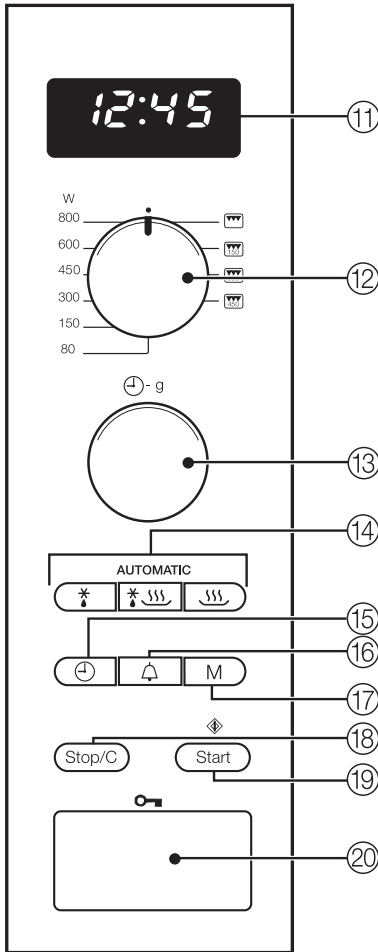

- ① Electronic timer and clock display
- ② Rotary selector for microwave power, grill and combination programmes
- ③ Rotary selector to enter time and weight
- ④ Automatic programme buttons
- ⑤ Time of day button ⊖
- ⑥ Minute minder button ⚠
- ⑦ Memory button (to save a 1-3 stage programme sequence)
- ⑧ Stop/cancel button
- ⑨ Start button / Add a minute button / Quick start button (programmable) ⏻
- ⑩ Door release button 🔑

Description of the appliance

Accessories supplied

Grilling rack

The grilling rack can be used for all functions with and without microwave power, **except** for Microwave Solo mode.

To avoid the grilling rack being used inadvertently on Microwave Solo, it should not be kept inside the microwave oven.

Glass tray

The glass tray is suitable for use with all cooking functions.

When grilling directly on the rack, the glass tray should be placed underneath the rack to catch any fat or juices.

Gourmet plate

The gourmet plate is a round, non-stick grilling plate. It can be used to heat snacks or small meals quickly whilst maintaining crispness.

Cover

The cover supplied must only be used in the Microwave Solo mode.

It prevents the food from drying out and the oven from becoming dirty, and it accelerates the heating process.

Boiling rod

When heating liquids, the boiling rod provided should always be placed in the container. It helps liquids to heat evenly.

Disposal of the packing material

The transport and protective packing has been selected from materials which are environmentally friendly for disposal, and can normally be recycled.

Ensure that any plastic wrappings, bags, etc. are disposed of safely and kept out of the reach of babies and young children. Danger of suffocation.

Dispose of or recycle all packaging materials safely as soon as possible.

Disposal of your old appliance

Electrical and electronic appliances often contain materials which, if handled or disposed of incorrectly, could be potentially hazardous to human health and to the environment. They are, however, essential for the correct functioning of your appliance. Please do not therefore dispose of it with your household waste.

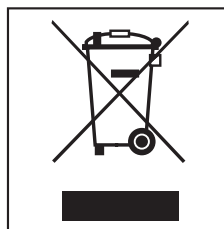

Please dispose of it at your local community waste collection/recycling centre, and ensure that it presents no danger to children while being stored for disposal.

It should be unplugged or disconnected from the mains electricity by a competent person.

Warning and Safety instructions

This appliance complies with all relevant local and national safety requirements. Improper use can present a risk of both personal injury and material damage.

To avoid the risk of accidents and damage to the appliance, please read these instructions carefully before installation and before using it for the first time. They contain important notes on installation, safety, operation and care of the appliance.

Keep these instructions in a safe place and pass them on to any future user.

▶ Never use the microwave to store or dry items which could ignite easily. Moisture evaporates. Fire hazard.

Safety with children

▶ This appliance is not a toy! To avoid the risk of injury, keep children away from it at all times, and do not let them play with it or use the controls. They should be supervised whenever you are working in the kitchen.

▶ Older children may only use the microwave oven if its operation has been clearly explained to them and they are able to use it safely, recognising the dangers of misuse.

Correct application

▶ The appliance is intended for domestic use only: to cook, defrost, reheat and grill food. Any other usage is not supported by the manufacturer and could be dangerous.

The manufacturer cannot be held liable for damage caused by improper or incorrect use of the appliance.

▶ This appliance is not intended for use by persons (including children) with reduced physical, sensory or mental capabilities, or lack of experience and knowledge, unless they have been given supervision or instruction concerning its use by a person responsible for their safety.

Technical safety

▶ Before setting up the appliance, check it for any externally visible damage. Never install or attempt to use a damaged appliance. Danger of injury.

▶ If the connection cable is damaged, it must be replaced by a Miele approved service technician.

▶ Do not use the microwave if

- the door is warped.
- the door hinges are loose.
- holes or cracks are visible in the casing, the door or the oven interior walls.

Operating the appliance with this type of damage will result in microwave leakage and present a hazard to the user.

Warning and Safety instructions

▶ Never open the casing of the appliance.

Tampering with electrical connections or components and mechanical parts is highly dangerous and can cause operational faults or electric shock.

▶ Before connecting the appliance to the mains supply, make sure that the rating on the data plate corresponds to the voltage and frequency of the household supply. This data must correspond in order to avoid risk of damage to the appliance. Consult a qualified electrician if in any doubt.

▶ Do not connect the appliance to the mains electricity supply by an extension lead or a multi-socket unit. These do not guarantee the required safety of the appliance (e.g. danger of overheating).

▶ The electrical safety of this appliance can only be guaranteed when continuity is complete between it and an effective earthing system which complies with current local and national safety regulations. It is most important that this basic safety requirement is present and tested regularly, and where there is any doubt, the household wiring system should be inspected by a qualified electrician. The manufacturer cannot be held liable for the consequences of an inadequate earthing system (e.g. electric shock).

▶ For safety reasons, this appliance may only be used when it has been fully installed.

▶ Repairs may only be carried out by a suitably qualified and competent person in accordance with national and local safety regulations. Repairs and

other work by unqualified persons could be dangerous. The manufacturer cannot be held liable for unauthorised work.

▶ While the appliance is under guarantee, repairs should only be undertaken by a service technician authorised by the manufacturer. Otherwise the guarantee will be invalidated.

▶ The appliance is only completely isolated from the electricity supply when:

- it is switched off at the wall socket and the plug removed.
- the mains fuse is disconnected,
- or the screw-out fuse is removed (in countries where this is applicable).

▶ Faulty components must only be replaced by genuine Miele original spare parts. The manufacturer can only guarantee the safety of the appliance when Miele replacement parts are used.

▶ This equipment may only be used in mobile installations such as ships, caravans, aircraft etc. if a risk assessment of the installation has been carried out by a suitably qualified engineer.

▶ In countries where there are areas which may be subject to infestation by cockroaches or other vermin, pay particular attention to keeping the appliance and its surroundings in a clean condition at all times. Any damage which may be caused by cockroaches or other vermin will not be covered by the guarantee.

Warning and Safety instructions

Correct use

▶ Always ensure that food is sufficiently heated.

Many factors will affect the overall cooking time, including the size and amount of food, its initial temperature, changes to the recipe, and the shape and size of the cooking container. Some foods may contain micro-organisms which are only destroyed by thorough cooking, therefore when cooking or reheating foods, e.g. poultry, it is particularly important that food is fully cooked through (at temperatures over 70°C for more than 10 minutes). If in doubt, select a longer cooking or reheating time.

▶ It is important that the heat is allowed to spread evenly throughout the food being cooked. This can be achieved by stirring and/or turning the food, and by observing a sufficiently long standing time, which should be added to the time needed for cooking, reheating or defrosting.

▶ Always remember that times for cooking, reheating and defrosting in a microwave oven are usually considerably shorter than with traditional methods of food preparation. Excessively long cooking times can lead to food drying out and burning, or could even cause it to catch fire. There is also a danger of fire if breadcrumbs, flowers, herbs, etc., are dried in the microwave oven. Always ensure that this type of procedure is supervised.

▶ Do not use the microwave function to heat up cushions or pads filled with cherry kernels, wheat grains, lavender or gel, such as those used in aromatherapy. These pads can ignite when heated, even after they have been removed from the microwave.

▶ Exercise caution when cooking or reheating food with a high sugar content, e.g. Christmas pudding. If heated for too long, the sugar may caramelize or ignite.

▶ The microwave is not suitable for cleaning or disinfecting items. Items can get extremely hot, and there is a danger of burning when the item is removed from the microwave. Fire hazard.

▶ Do not use full power to warm empty dishes or to dry out herbs. Do not use the appliance without food, or if it is incorrectly loaded.

▶ Never cook or reheat food or liquids in sealed containers, jars or bottles. With baby bottles, the screw top **and** teat must be loosened. Otherwise pressure builds up which can cause the bottle or container to explode, posing a severe risk of injury.

Warning and Safety instructions

► Before serving, remember to allow a sufficient standing time and then always check the temperature of the actual food itself after taking it out of the microwave. The temperature of the container is not an indication of the temperature of the food or liquid in it.

This is particularly important when preparing food for babies, children, and the elderly or infirm. Shake or stir baby milk and food thoroughly after heating, and try it for temperature to ensure that it will not scald the baby. When heating food and drinks, remember that the heat is created in the food itself, and that the container will normally be cooler. The dish is only warmed by the heat of the food.

► When heating liquids, the boiling rod provided should always be placed into the container.



When heating liquids, milk, sauces etc. in the oven without the boiling rod, the boiling point of the liquid may be reached without the production of typical bubbles. The liquid does not boil evenly throughout. This so-called 'boiling delay' can cause a sudden build-up of bubbles when the container

is removed from the oven or shaken, which can lead to the liquid boiling over suddenly and explosively. Danger of burning.

The formation of bubbles can be so strong that the pressure forces the oven door open, with a danger of burning. The boiling rod ensures that bubbles are produced, and that liquids heat evenly.

► To avoid fuelling any flames, do not open the oven door if smoke occurs in the oven interior.

Interrupt the process by pressing the Stop/C button twice. Switch off at the wall socket, and where applicable, remove the plug. Do not open the door until the smoke has dispersed.

► Never heat undiluted alcohol in the microwave, as this can easily ignite. Fire hazard.

► Do not heat up tins in the microwave. Pressure can build up and they may explode, resulting in injury or damage.

► Cover any food which is left in the microwave to be kept hot, as moisture in the food could lead to corrosion damage in the microwave. This also prevents the food from drying out.

► Try to avoid the interior walls being splashed with food or liquids containing salt. If it does happen, wipe these away thoroughly to avoid corrosion on the stainless steel surface.

Warning and Safety instructions

▶ Do not use any containers or cutlery made from or containing metal, aluminium foil, lead crystal glassware, temperature-sensitive plastics, wooden utensils or cutlery, metal clips or wire ties. Do not use bowls with milled rims, or plastic pots with the foil lid only partially removed. Such items could be damaged or cause a fire hazard. The rack and gourmet plate supplied with the appliance are designed to be compatible with microwaves and can therefore be used for grilling with or without the microwave function. Do not use the rack for Microwave Solo.

▶ Do not use the rack and the gourmet plate at the same time. This will damage the gourmet plate. Always place the gourmet plate directly on the turntable.

▶ Do not use the cover with the gourmet plate, as the cover will get too hot.

▶ Do not leave the oven unattended when reheating or cooking food in disposable containers made of plastic, paper or other inflammable materials. Before using single-use plastic containers, make sure they are suitable for use in microwave ovens. See "Suitable containers for microwave ovens".

▶ Eggs can only be cooked in their shells in the microwave oven in a specially designed egg-boiling device available from specialist shops. Similarly, hard-boiled eggs should not be reheated in the microwave oven as this may lead to the eggs bursting, even after they have been taken out of the oven.

▶ Eggs can be cooked without their shells using microwave heat only if the yolk membrane has been punctured several times first. The pressure could otherwise cause the egg yolk to explode. Danger of injury.

▶ Food with a thick skin or peel, such as tomatoes, sausages, jacket potatoes and aubergines, should be pierced or the skin cut in several places before cooking to allow steam to escape and prevent the food from bursting.

▶ Do not reheat food in the oven in heat-retaining bags which are intended for normal ovens, such as roasting bags. These heat-retaining bags usually contain a thin layer of aluminium foil which reflects microwaves. This reflected energy can, in turn, cause the outer paper covering to become so hot that it ignites.

▶ Always ensure that food, the gourmet plate or a browning dish has been placed in the microwave, and that the turntable is in place, before switching on.

▶ Do not use the appliance for deep frying food, and do not leave it unattended when cooking with oils and fats as these can be a fire hazard if allowed to overheat.

Warning and Safety instructions

- ▶ Ovenproof earthenware can retain a considerable amount of moisture. Earthenware and porcelain containers with hollow handles and lid knobs must only be used in this oven if they have vent holes which allow the moisture to escape. Without vent holes pressure can build up, causing the container to crack or shatter with the danger of injury.
- ▶ When grilling with or without the microwave function, the oven interior, grill element and door can get hot. Do not let small children touch the oven while it is in operation, as there is the danger of being burnt. Supervise its use by elderly or infirm people.
- ▶ Wear oven gloves when placing dishes in, and taking them out of the oven, or when handling dishes or food in the oven if the grill is on or has just been in operation. Danger of burning.
- ▶ The gourmet plate gets extremely hot when in use. Always use oven gloves when handling it to avoid burns. Place it on a suitable heat-resistant mat or pot rest. The rack and glass tray get hot during grilling (with and without the microwave function). Take care not to burn yourself on them.
- ▶ Never place the hot glass tray (or any other hot cooking containers) on a cold surface, such as a tiled or granite worktop. The glass tray or container could crack or shatter, and the worktop surface could get damaged. Use a suitable heat-resistant mat or pot rest.
- ▶ Do not use the appliance to heat up the room. Due to the high temperatures radiated, objects left near the appliance could catch fire.
- ▶ When using kitchen appliances connected to sockets near the appliance, ensure that the cable cannot get trapped in a hot oven door, which could melt the cable insulation and be dangerous.
- ▶ To check food temperature, first interrupt the cooking process. Only use a thermometer specifically approved for food use to measure the temperature of the food. Never use a thermometer containing mercury or liquid, as these are not suitable for use with very high temperatures and will break very easily.
- ▶ Do not use a steam-cleaning appliance to clean this appliance. Pressurised steam could reach the electrical components and cause a short circuit.

The manufacturer cannot be held liable for damage caused by non-compliance with these Warning and Safety instructions.

How the microwave oven works

In a microwave oven there is a high-frequency tube called a magnetron. This converts electrical energy into microwaves. These microwaves are distributed evenly throughout the oven interior, and rebound off the metal sides of the oven interior to reach the food from all sides. Microwave distribution is improved with the turntable engaged.

In order for microwaves to reach the food, they must be able to penetrate the cooking utensil being used. Microwaves can penetrate porcelain, glass, cardboard and plastics, but not metal. Do not, therefore, use utensils made of metal, or which contain metal, for example in the form of gold or silver trim. The metal reflects the microwaves and this could lead to the creation of sparks. The microwaves cannot be absorbed.

Microwaves pass through a suitable container and find their way directly into the food. All food contains moisture molecules which, when subjected to microwave energy, start to oscillate 2.5 thousand million times a second. The friction caused by this vibration creates heat, which first starts developing around the outside of the food and then slowly penetrates towards the centre. The moisture, fat and sugar content of food will affect the speed at which it is cooked.

As heat is produced directly in the food,

- food can generally be cooked without adding much liquid or cooking oil.

- cooking, reheating and defrosting in a microwave oven is quicker than using conventional methods.
- nutrients, such as vitamins and minerals, are generally retained.
- the colour, texture and taste of food are not impaired.

Microwaves stop being produced as soon as the cooking process is interrupted or the appliance door is opened.

When the appliance is in operation, the closed, sealed door prevents microwaves escaping from the appliance.

What can a microwave oven do?

In the microwave oven, food is cooked, reheated or defrosted quickly.

You can use the microwave in the following ways:

- Food can be defrosted, reheated or cooked by entering a power setting and a time.
- Deep-frozen, ready-made meals can be defrosted and then reheated or cooked.
- The microwave oven can also be used for other tasks, e.g. for proving dough, melting chocolate and butter, dissolving gelatine etc.

In what ways can a microwave oven be used?

Microwave Solo mode

Suitable for defrosting, reheating and cooking.

Grilling

Ideal for grilling very thin cuts of meat, e.g. bacon.

Combination mode (Microwave + Grill)

Ideal for browning dishes with toppings. The microwave cooks the food, and the grill browns it.

Automatic programmes

You can choose from the following automatic programmes:

- Five defrosting programmes
(☼: Ad 1 to Ad 5),
- Four cooking programmes for frozen food
(☼ ☺☺☺: AC 1 to AC 4).
- and eight cooking programmes for fresh food
(☺☺☺: AC 1 to AC 8).

These programmes are weight dependent. You enter the weight of the food, and then the cooking time is calculated automatically.

Suitable containers for microwave ovens

Microwaves

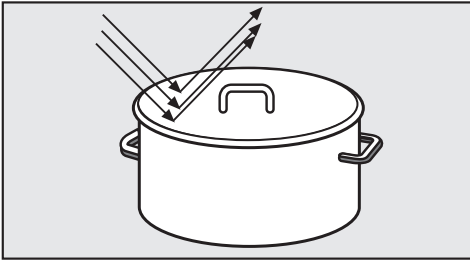

- are reflected by metal,

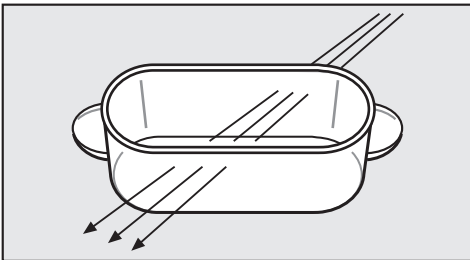

- pass through glass, porcelain, plastic and card,

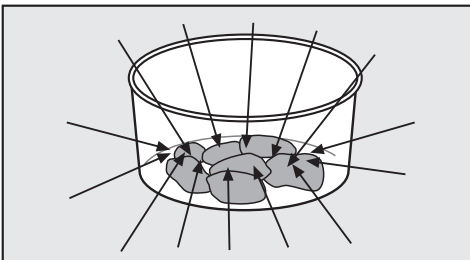

- and are absorbed by food.

Material and shape

The material and shape of containers used affect cooking results and times. Heat distribution is more even in round and oval shaped flat containers than in rectangular containers, providing better results.

Containers and lids with hollow handles or knobs in which moisture can collect are unsuitable, unless the hollowed areas are adequately vented. Without vent holes pressure can build up, causing the container to crack or shatter with the danger of injury.

Metal

Metal containers, aluminium foil, metal cutlery, and china with metallic decoration such as gold rims or cobalt blue must not be used on microwave mode. Metal reflects microwaves and obstructs the cooking process. Also, avoid using plastic pots where the foil lid has not be completely removed.

Exceptions:

- Ready meals in aluminium foil dishes

These can be defrosted and reheated in the microwave oven, if recommended by the manufacturer.

Remove the lid and make sure the foil dish is at least 2 cm from the oven walls at all times.

Important:

As food is only heated from the top, it is better to remove the food from the aluminium foil container and transfer it to a dish suitable for a microwave oven. The heat distribution will be more even.

Suitable containers for microwave ovens

Do not place aluminium foil dishes on the grilling rack in case the dish sparks or arcs. If sparks occur, transfer food to a microwave-safe container.

- Pieces of aluminium foil

For even defrosting and to avoid overcooking unevenly shaped cuts of meat, poultry or fish, small pieces of aluminium foil may be used to mask wingtips or other thin parts for the last few minutes of the programme.

Make sure that the aluminium foil is at least 2 cm from the oven walls at all times. It must not touch the walls.

- Metal meat skewers or clamps

These should only be used if they are very small in comparison to the size of the cut of meat.

Glassware

Heat-resistant glass or ceramic glass are ideal for use in the microwave oven.

Crystal glass is unsuitable as it contains lead which could cause the glass to crack in the microwave.

Porcelain

Porcelain is a suitable material.

Do not use porcelain with gold or silver edging or items with hollow knobs or handles, as insufficient ventilation may cause pressure.

Earthenware

Decorated earthenware is only suitable if the decoration is beneath an all-over glaze.

Earthenware can get very hot, and may crack.

Glazes and colours

Some glazes and colours contain metals which make them unsuitable for use in a microwave oven.

Wood

Wooden dishes are not suitable. Moisture contained in the wood evaporates when exposed to microwave energy, causing the wood to dry and crack.

Plastics

When purchasing plasticware, make sure that it is suitable for use in a microwave oven.

Plastics must only be used with Microwave Solo.

They must be heat-resistant to a minimum of 110°C. Otherwise the plastic may melt and fuse with the food.

Special plastic utensils designed for use in microwave ovens are available from good retail outlets.

Melamine is not suitable as it absorbs energy and heats up.

Suitable containers for microwave ovens

Disposable containers, such as trays made from polystyrene, can only be used for very short, timed warming and reheating of food.

Plastic boiling bags can be used for cooking and reheating. They should be pierced beforehand so that steam can escape. This prevents a build-up of pressure and reduces the risk of the bag bursting.

Do not use metal clips, plastic clips containing metal parts, or paper ties containing wire. There is a danger that they will ignite when heated.

Disposable containers

Only those plastic disposable containers which are specified by the manufacturer as suitable for use in a microwave oven may be used.

Do not leave the oven unattended when reheating or cooking food in disposable containers made of plastic, paper or other inflammable materials.

Disposable containers are not always recyclable or bio degradable.

Testing dishes for their suitability

If in doubt as to whether glass, earthenware or porcelain plates or dishes are suitable for use in a microwave oven, a simple test can be performed:

- Place the item you wish to test in the centre of the oven, fill a suitable glass with water and also place this in the oven.
- Close the door.
- Turn the power selector to 800 W.
- Enter a time of 30 seconds with the time selector.
- Press the Start button.

At the end of the test, the water in the glass should be warm and the dish cool. If the dish is hot and the water cold, it would be unwise to use the dish.

If a crackling noise is heard accompanied by sparks during the test, switch the appliance off immediately (press button Stop/C twice).

Any crockery which causes this reaction is unsuitable for use with microwave power.

If any doubt exists about the suitability of containers, please contact the supplier.

This test cannot be used to check whether items with hollow knobs or handles are suitable for use with microwave power.

Suitable containers for microwave ovens

The cover

- prevents too much steam escaping, especially when cooking foods which need longer to cook, such as potatoes.
- speeds up the cooking process.
- prevents food from drying out.
- helps keep the oven interior clean.



Always cover food with the cover supplied.

Alternatively, use lids or covers made of microwave-safe glass or plastic, or use a clingfilm recommended for use in a microwave oven (pierce as instructed by the manufacturer).

Heat can cause normal clingfilm to distort and fuse with the food.

Sealed glass containers, such as jars of baby food, must be opened before they are placed in the oven.

Do not use a lid or cover if

- food coated with breadcrumbs is being cooked.
- cooking meals which are to be given a crisp finish.
- the gourmet plate is being used.

Because the cover can only withstand temperatures of up to 110°C, it must only be used in Microwave Solo mode. It must not be used in conjunction with the gourmet plate. At temperatures in excess of 110°C, the plastic can melt and get into the food.

The cover should not form a seal with the container. If the cover is used with a container which only has a narrow diameter, there might not be enough room for condensation to escape through the holes in the top. The cover could get too hot and could start to melt.

Before using for the first time

Important:

After unpacking, let the appliance stand for approx. 2 hours at room temperature after transporting it to its final location before connecting it to the mains.

This is important for the correct electronic functioning of the appliance.

- Remove all the packaging materials and any protective foil from the appliance.

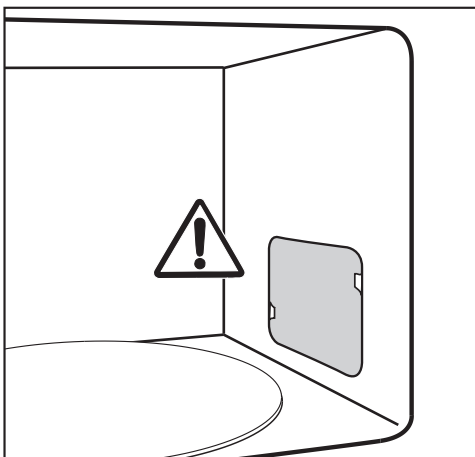

Do not remove the cover to the microwave outlet inside the oven, nor the film covering the inside of the door.

- Check the appliance for any damage.

Do not use the microwave if

- the door is warped.
- the door hinges are loose.
- holes or cracks are visible in the casing, the door or the oven interior walls.

Operating the appliance with this type of damage will result in microwave leakage and present a hazard to the user.

- Clean the inside of the oven and all the accessories with warm water applied with a well wrung-out soft sponge or cloth.

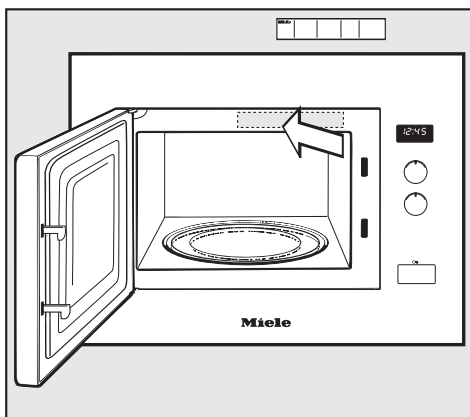

- Stick the enclosed short instructions to the frame behind the door as illustrated, making sure they do not block any of the vents.

Setting the time of day

- Connect the appliance to the mains electricity supply.
12:00 and the ☰ symbol will flash in the display until the current time of day is set. Before this, the time of day will start to run from 12:00, as the clock will start as soon as the appliance is connected to the mains electricity supply.

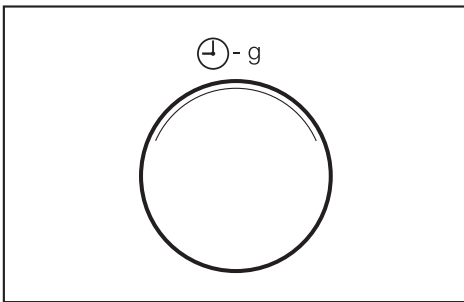

- Turn the time selector to set the hour.
- Press the ☰ button.
- Then turn the time selector to set the minutes.
- Press the ☰ button to confirm, or wait a few seconds.
The set time is now registered. The colon between hours and minutes flashes.

Altering the time of day

- Press the ☰ button.
The ☰ symbol will flash in the display, and the current hour will light up for a few seconds.
- Use the time selector to alter the hour.

- Press the ☰ button to confirm, or wait a few seconds.
The ☰ symbol will flash, and the current minutes will light up for a few seconds.
- Use the time selector to alter the minutes.
- Press the ☰ button to confirm, or wait a few seconds.

Switching off the time of day display

- Press and hold the ☰ button in until the display goes dark.

Pressing and holding the ☰ button again will bring the time of day back in the display.

Night time switch-off

The time of day display can be set to switch itself off from 23:00 hrs until 04:00 hrs.

Setting the time of day display to switch off at night

- Press and hold in the Stop/C button, and at the same time press the ☰ button.

ON appears in the display.

The appliance can still be operated.

To switch the display back on:

- Press and hold the Stop/C button, and at the same time press the ☰ button.

OFF appears in the display.

Operation

To open the door

- Press the  button to open the door.

If the microwave oven is being used, opening the door will interrupt the cooking programme.

Placing the dish in the oven

Ideally the dish should be placed in the middle of the oven.

Turntable

The turntable helps the food to cook, reheat or defrost evenly.

Do not operate the microwave without the turntable in place.

The turntable starts turning automatically when the appliance is operated.

Do not cook, reheat or defrost food directly on the turntable. Check that the dish is not larger in size than the turntable.

Stir or turn food during cooking, or turn the dish so that it heats up evenly.

To close the door

- Push the door firmly shut.

Press the Start button again to resume an interrupted cooking programme.

The appliance will not start again if the door has not been closed properly.

Starting a programme

Use the appropriate selector to choose the microwave power level and the cooking time.

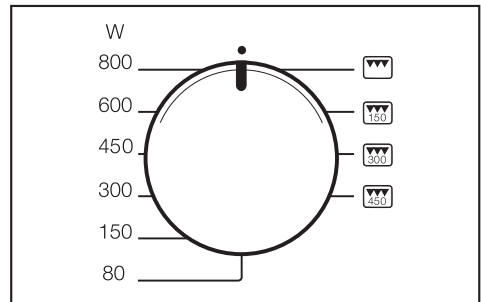

- Use the power selector to select a microwave power level.

The  symbol lights up in the display and 0:00 flashes.

There is a choice of 6 power levels. The higher the power level, the more microwaves reach the food.

When heating up food which cannot be stirred or turned during cooking, as with a plated meal, it is best to use a lower microwave power level.

This ensures the heat is distributed evenly. Heat for long enough to cook the food properly.

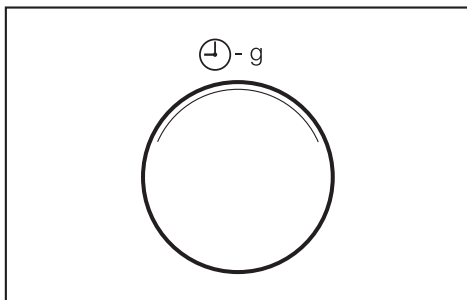

- Set the required time using the time selector.

Any time between 10 seconds and 90 minutes can be selected.

Exception: If the maximum microwave power is selected, a maximum cooking duration of 15 minutes can be set. If you then continue to select full power, the power level may reduce to 450 W, and this is shown in the display (protection against overheating).

The time required depends on:

- the initial temperature of the food.
Food taken from the refrigerator will need longer to reheat or cook than food already at room temperature.
- the type and texture of the food.
Fresh vegetables contain more water and cook more quickly than stored vegetables.

- the frequency of stirring or turning the food.
Frequent stirring or turning heats the food more evenly, and it is therefore ready in a shorter time.

- the amount of food.

As a general rule, allow approx. time and a half for double the quantity. For a smaller quantity, possibly shorten the time but ensure food is cooked thoroughly.

- the shape and material of the container.

- Press the Start button to start the programme.
The interior lighting comes on.

A programme can only be started if the door is closed.

"door" message

The "door" message in the display is a reminder that the appliance should not be used without food inside it.

Operating the appliance without food can damage the appliance.

If the door has been closed for 20 minutes or longer when the Start button is pressed, the word **door** will appear in the display to remind you to open the door and make sure there is food in the oven before you press Start. You cannot start a process until you do this.

Operation

Interrupting or re-starting a programme

At any time you can . . .

. . . interrupt a programme:

- Press the Stop/C button, or open the appliance door.

The time stops counting down.

. . . continue the programme:

- Close the door and press Start.

The programme continues.

Altering the settings

If you discover after starting a programme that . . .

. . . the **Microwave power level** is too high or too low, you can

- select a new level.

. . . the **time** set is too short or too long, you can

- interrupt the programme (press the Stop/C button once), use the time selector to set a new time and continue the programme (press the Start button),

or alternatively:

- the cooking duration can be increased by pressing the Start button during operation. Each time the Start button is pressed, the cooking duration is increased by another minute. (Exception: the increased cooking time is in increments of 30 seconds when the microwave is being used on maximum power.)

To cancel a programme

- Press the Stop/C button twice.

At the end of a programme

An audible tone will sound when the cooking programme is complete. The oven interior lighting goes out.

The audible tone will sound briefly as a reminder every 5 minutes for 20 minutes after the end of the programme.

- If you want to stop the audible tone, press the Stop/C button.

Automatic warming function

The warming function will switch on automatically at 80 W for a maximum of 15 minutes approx. 2 minutes after the end of a cooking programme which has used at least 450 W, providing the door remains closed and no buttons are pressed.

 80 W and **H:H** will light up in the display.



Opening the door or operating one of the buttons or selectors while the warming function is in progress cancels the function.

The warming function cannot be set as a separate function.

Quick start (programmable)

Pressing the Start button  is sufficient to set the appliance operating on maximum power.

Three set times are stored in the memory:

- 30 secs: Press Start  once
- 1 min: Press Start  twice
- 2 min: Press Start  three times

Pressing the Start  button four times in succession will bring back the first stored time and so on.

The cooking duration can be increased by pressing the Start button during operation; each time the Start button is pressed, the cooking duration is increased by another 30 seconds.

Programming times

To alter the set times:

- Use the Start  button to select the time you want to reprogramme (press once, twice or three times), and hold the Start  button pressed in.
- While holding the Start button pressed in, alter the time with the time selector (to max. 15 minutes). The altered programme runs when the Start  button is released.

An interruption to the power supply will cancel any altered programmed times, and they will need to be entered again.

System lock

The system lock prevents the appliance being used by children, for example.

To activate the system lock

- Press and hold the Stop/C button in until an audible tone sounds and the key symbol appears in the display:



The key symbol will go out after a short time.

The key symbol reappears whenever any button or one of the rotary selectors is operated.

After an interruption to the mains power supply, the system lock will need to re-activated.





To cancel the system lock

- Press the Stop/C button again and hold it pressed in until an audible tone sounds.

Operation

Minute minder

The minute minder can be used to time any activity in the kitchen, e.g. boiling eggs. The time set counts down in one second steps.



- Press the  button.
0:00 flashes in the display and the  symbol lights up.
- Use the time selector to set the minute minder time you require.
- Press the Start button to start the minute minder.
The minute minder time will start itself after a few seconds if the Start button is not pressed.
- At the end of the minute minder time, an audible tone sounds. The time of day reappears and the  symbol flashes.
- Press the Stop/C button once and the  symbol disappears.

Altering a minute minder entry

- Press the Stop/C button.
The minute minder time is interrupted.
- Set a new minute minder time, as described above.

Minute minder + cooking function

The minute minder can be used at the same time as a cooking function, and counts down in the background.

- Press the  button whilst the cooking function is in progress.
0:00 flashes in the display and the  symbol lights up.
- Use the time selector to set the minute minder time you require.
- After a few seconds the minute minder time set will begin to count down.
A few seconds later, the display will change again to show the cooking duration counting down. The minute minder time is represented by the  symbol in the background.

The Start button is not used in this instance to start the minute minder, as pressing the Start button would also increase the cooking duration by a minute.

To find out the minute minder time remaining

- Press the  button.
The minute minder time still remaining will show in the display.

The grill can be used on 4 settings: by itself, and in combination with the Microwave function at one of three different power levels.

If the total grilling time required is less than 15 minutes, the grill should be pre-heated for approx. 5 minutes before placing food under it.

Thin, flat cuts of fish and meat should usually be turned half way through grilling for even results. Larger, chunkier pieces should be turned several times.

Grilling times depend on the type and thickness of the food and on the user's preference for a rare or well-cooked result.

When grilling directly on the rack, the glass tray should be placed underneath the rack to catch any fat or juices.

- Place the food in a suitable dish.
- Place the glass tray, the rack and glass tray, or the dish containing the food on the turntable.

Caution. The rack and glass tray become hot during use.
Danger of burning.

The glass tray and grill rack will be easier to clean if washed in soapy water immediately after grilling.

Grilling without the Microwave function

Ideal for grilling thin cuts of meat, e.g. steak or sausages.

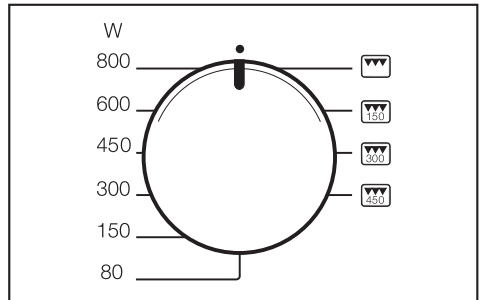

- Turn the power selector to . The grill symbol will light up in the display. 0:00 will flash.
- Select a cooking duration using the time selector.
- Press the Start button. An audible tone will sound at the end of the process.

To change a cooking duration

The cooking duration can be changed during operation. To do this, interrupt the cooking programme by pressing the Stop/C button, and change the duration. Continue the cooking process by pressing the Start button.

The cooking duration can also be extended during operation by pressing the Start button once for each minute you wish to extend the cooking duration by.

The area on the ceiling around the grill becomes discoloured over time. This is an unavoidable consequence of use, and does not impair the function of the appliance in any way.

Operation - Grilling





Combination mode - Microwave + Grill

This function is very good for baking and browning. The microwave cooks the food, and the grill browns it.

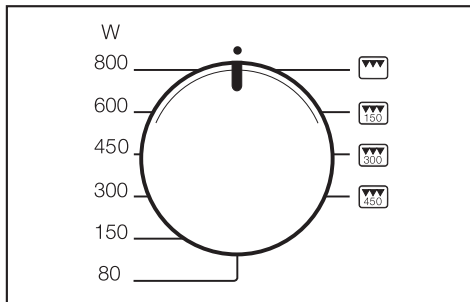
The grill can be combined with one of three different microwave power levels: 150, 300 and 450 Watt.

It is possible during the cooking process to switch between the different power levels without interrupting the programme.



- Use the programme selector to select the required combination ,  or , the microwave power level and the grill symbol  will light up in the display. 0:00 will flash.
- Select a cooking duration using the time selector.
- Press the Start button.
An audible tone will sound at the end of the process.

To change a cooking duration

The cooking duration entered can be changed during operation if required. Interrupt the process by pressing the Stop/C button, and change the duration. To continue, press the Start button.

The cooking duration can also be extended during operation by pressing the Start button once for each minute you wish to extend the cooking duration by.

Use

The gourmet plate gets extremely hot when in use. Always use oven gloves when handling it to avoid burns. Place it on a suitable heat-resistant mat or pot rest.

Before using for the first time

Before using the gourmet plate for the first time, fill it with 400 ml water and add 3-4 tbsps vinegar or lemon juice. Heat for 10 minutes on 450 W + Grill

 450.

The gourmet plate has an easy to clean anti-stick coating so that food can be removed easily. The coating is susceptible to cuts and scratches. Therefore do not cut food up directly on the plate.

Use wooden or plastic utensils to mix or turn food. Metallic or sharp objects can damage the coating.

Searing/browning food

- When using the gourmet plate, make sure that the food is ready to transfer to the gourmet plate as soon as it has heated up.
- Place the gourmet plate directly on the turntable.

Do not place it on the rack as this could cause sparking and damage the gourmet plate.

- Heat the plate up on 450 W + Grill  for approx. 5 minutes.

If using oil, you can either heat up the oil on the gourmet plate, or you can heat the oil separately and then add it to the plate.

Butter, however, should always be added after heating up the gourmet plate. It has a lower burning point than oil and would get too dark or burn if added too soon.

Always dry meat, poultry, fish and vegetables thoroughly before placing them on the gourmet plate.

Do not use the gourmet plate to cook eggs or reheat cooked eggs. The eggs can burst.

Some suggested uses

Pre-heat the gourmet plate directly on the turntable for 5 minutes at 450 W + Grill .

Fish fingers (frozen),

150 g + 2 tbsp oil
, 3-4 minutes each side

Hamburgers 2 burgers + 2 tbsp oil

, 3-4 minutes each side

Croquette potatoes (frozen),

10-12 + 2 tbsp oil
, 6-8 minutes, turning halfway through

Fillet steak, approx. 200 g

, 5 minutes each side (according to taste)

Pizza (frozen), 300 g,

, 7-9 minutes

Pizza (fresh), without pre-heating

, 15 minutes approx. (depending on topping)

Gourmet plate

Recipes

Croque monsieur (Serves 3)

6 slices of bread
30 g soft butter
75 g grated Emmental cheese
3 slices of cooked ham

Butter the bread. Add the cheese to three of the bread slices in equal amounts and add a slice of ham. Place the remaining three slices of bread on top of the ham with the buttered side face down. Pre-heat the gourmet plate for 5 minutes at 450 W + Grill. Remove from the oven, then place the bread on the gourmet plate. Now place the gourmet plate back on the turntable, and brown for approx 3 minutes per side at 450 W + Grill.

Other fillings could include drained tuna fish, finely sliced onion rings, pineapple, cheese and ham.

Vegetable medley (Serves 3)

2 onions
2 tbsp oil
100 g mushrooms, cleaned
150 g baby carrots or carrot slices
100 g broccoli florets
1 red pepper
1 tomato
Salt, pepper
30 g grated Parmesan cheese

Slice the onions into fine rings. Half, quarter and deseed the pepper, and then cut into strips. Dice the tomato. Place the gourmet plate on the turntable, and pre-heat for approx. 5 minutes at 450 W + Grill. Place the oil and the onions on the gourmet plate, and brown the onions for approx 2 minutes at 450 W + Grill. Add the mushrooms, carrots, broccoli, pepper strips, diced tomato and seasoning. Mix well. Cook for 6 minutes at 450 W + Grill. Turn out and sprinkle with Parmesan cheese before serving.

Home-made potato rösti (Serves 2)

400 g peeled potatoes
2 small onions
50 g grated Emmental cheese
Salt, pepper
20 g butter

Coarsely grate the potato and onion, and mix together with the cheese, salt and pepper. Place the gourmet plate on the turntable, and pre-heat for approx. 5 minutes at 450 W + Grill. Melt the butter on the hot gourmet plate. Remove from the oven, and add the potato mixture and press it into the gourmet plate. Place the gourmet plate back on the turntable, and cook for approx 8 minutes at 450 W + Grill. Turn over, and cook for a further 4 minutes until golden.

Garnish with smoked salmon or strips of ham.

Pork fillets (Serves 2)

1 piece pork fillet (approx. 400 g)
4 rashers streaky bacon
Salt, pepper
10 g butter
200 g sliced mushrooms
200 ml double cream
2 tbsp brandy

Cut the pork into 4 slices. Season each slice with salt and pepper, and wrap in a rasher of streaky bacon. Secure with a cocktail stick if necessary. Place the gourmet plate on the turntable, and pre-heat for approx. 5 minutes at 450 W + Grill. Remove from the oven. Add the butter to the plate, and place the pork slices on top. Now place the gourmet plate back on the turntable, and cook for approx 3 minutes per side at 450 W + Grill. Transfer the meat to a serving dish, cover and keep warm. Add the mushrooms, cream and brandy to the juices from the meat. Lightly cook for approx. 4 minutes at 800 W. Serve with the meat.

Pork fillet in a Roquefort sauce

Cut a piece of pork into 4 slices. Cook for approx. 4 minutes in the pre-heated gourmet dish at 450 W + Grill. Add 50 ml white wine, 125 ml double cream, 2 tbsp roux (made from 1 tbsp each of flour and melted butter) and 150 g Roquefort cheese. Stir the sauce until smooth, and cook for a further 3 minutes.

Gourmet plate

Curried chicken (Serves 3)

600 g chicken or turkey breasts
2 tbsp oil
2 tbsp white wine
2 tbsp apple juice
1 tbsp lemon juice
Salt, freshly ground black pepper
1 tsp curry powder
A pinch of finely chopped rosemary
A pinch of ground ginger
A pinch of cayenne pepper
1/2 tsp Tabasco sauce
20 g butter

Dice the meat into 2 x 2 cm pieces. Combine the rest of the ingredients apart from the butter, mix together well, and sprinkle over the meat. Turn the meat so it is well coated with the herbs and spices, and leave to stand for approx. 30 minutes. Place the gourmet plate on the turntable, and pre-heat for approx. 5 minutes at 450 W + Grill. Remove from the oven, melt the butter in the heated plate, then add the meat. Place the plate back on the turntable, and cook for approx. 4 minutes at 450 W + Grill. Turn the meat, and cook for a further 4 minutes at the same setting. Drain surplus liquid from the meat if necessary so that it browns well.

Fisherman's salmon (Serves 2)

2 pieces of salmon fillet (each 150 g)
1 tbsp lemon juice
Salt, white pepper

Drizzle the salmon with the lemon juice, and leave to stand for approx. 10 minutes. Place the gourmet plate on the turntable, and pre-heat for approx. 5 minutes at 450 W + Grill. Remove from the oven, pat the fish dry with kitchen paper, and place on the gourmet plate. Place the gourmet plate back on the turntable, and cook for approx 1 1/2 - 2 minutes per side at 450 W + Grill.

Serve with rice, hollandaise sauce or melted butter and a fresh green salad.

Pineapple cake

For the cake:

2 eggs

80 g sugar

1½ ripe bananas

30 g chocolate chips

100 g plain flour

¾ tsp. baking powder

Topping:

1 tin pineapple chunks

(drained weight 240 g)

1½ tbsp brown sugar

1½ tbsp desiccated coconut

Beat together the eggs and sugar until frothy. Mash the bananas with a fork, and add to the egg mixture. Sift together the flour and the baking powder, stir in the chocolate chips, and fold into the mixture. Spread the mixture into the gourmet plate. Scatter the drained pineapple over the mixture, and sprinkle over the sugar and desiccated coconut. Place the gourmet plate on the turntable. Bake the cake for approx. 10 minutes at 450 W + Grill until golden. Cut into 8 slices.

Quick almond tart

For the pastry:

100 g plain flour

½ level tsp baking powder

75 g butter or margarine

30 g sugar

Filling:

75 g butter

100 g chopped almonds

Few drops of almond essence

30 g sugar

½ packet vanilla sugar

75 ml double cream

To spread over the top:

50 g apricot jam

Mix together the flour, baking powder, butter and sugar, and knead to a smooth dough. Roll out the mixture into the gourmet plate, and build up the edges to 1 cm. Place the gourmet plate on the turntable, and bake the pastry for approx. 4 minutes at 450 W + Grill. For the filling, melt the butter in a pan on the hob, stir in the rest of the ingredients and simmer for approx. 5 minutes. Whilst still hot, spoon the mixture into the pastry case. Place the gourmet plate on the turntable, and bake the tart for approx. 5 minutes at 450 W + Grill until golden. When cool, spread with apricot jam. Cut into 8 slices.

Operation - Automatic programmes

All of the automatic programmes are weight dependent.

After selecting a programme, enter the weight of the food. The microwave automatically calculates the time according to the weight given.

After cooking, allow the food to stand at room temperature for the suggested number of minutes ("standing time") to allow the heat to be distributed evenly through the food.

Automatic defrosting

There are five programmes for defrosting different types of food (button ) . The standing time for programme Ad 3 is up to 30 minutes, depending on the weight, and approx. 10 minutes for the remaining programmes.

Ad 1  Steak, cutlets (0.2 – 0.8 kg)

Ad 2  Mince (0.2 – 0.8 kg)

Ad 3  Chicken, small, whole (0.9 -1.5 kg)

Ad 4  Cakes (0.1 – 1.4 kg)

Ad 5  Bread (0.1 – 1.0 kg)

Automatic cooking

There are four programmes for frozen food and eight programmes for fresh food. The standing time for each programme is approx. 2 minutes.

Cooking food from frozen

AC 1  Vegetables (0.1 – 0.6 kg)

AC 2  Ready meal which can be stirred (0.3 –1.0 kg)

AC 3  Bakes and gratins (0.2 – 0.6 kg)

AC 4  Chips (0.1 – 0.3 kg)

Cooking fresh food

AC 1  Vegetables (0.1 – 0.6 kg)

AC 2  Potatoes (0.1 – 0.8 kg)

AC 3  Fish pie (0.4 – 1.2 kg)

AC 4  Kebabs (0.2 – 0.8 kg)



AC 5  Chicken (small, whole) (0.9 – 1.4 kg)

AC 6  Chicken drumsticks (0.25 – 0.75 kg)

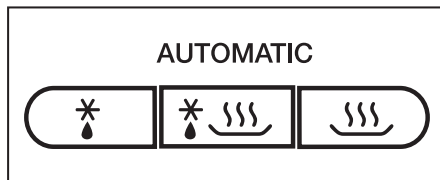

AC 7  Fish pie (0.6 –1.2 kg)

AC 8  Savoury bakes, e.g. Potato gratin (0.5 – 1.5 kg)





- Press the relevant button repeatedly until the automatic programme required shows in the display. For example, to call up programme AC 5  (Chicken, small, whole), press  five times.

Operation - Automatic programmes

g will flash in the display to request the weight to be entered, and the programme (e.g. AC 5) will light up, together with the symbols for the functions being used ( for Microwave and  for Grill).

- Use the rotary selector to enter the weight.
- Press the Start button.

The time (which depends on the weight) will begin to count down, and the symbols for the functions that are currently in use will light up ( and/or ).

An audible tone will sound halfway through the cooking time.

- Interrupt the programme to turn or stir the food, and then continue the programme.

The programmed time can, if necessary, be extended by a few minutes during operation by pressing the Start button repeatedly until the time required shows in the display. On all programmes it is only possible to extend the time by a few minutes.

An audible tone will sound when the cooking programme is complete. The interior lighting of the oven goes out.

Saving your favourite programme

One favourite programme can be saved in memory. This programme can be used for your most frequently cooked recipe. This programme can have up to 3 stages (e.g.: 1 minute at 600 W, followed by 2 minutes on Grill, and finally 3 minutes at 150 W + Grill).

Programming

(The example given is for a 3-stage programme.)

- First select the function for the first stage.
- Then select the duration.

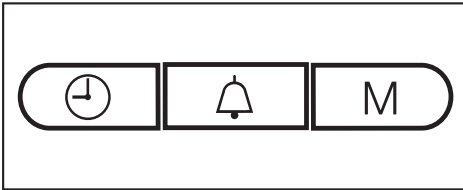

- Press button M. 1 will light up in the display, and 2 will flash.
- Then select the second function and duration.
- Press button M again. 2 will light up in the display, and 3 will flash.
- Now select the third function and duration, and then press the M button.

After this third step, you can use the M button to scroll through your entry and check it.

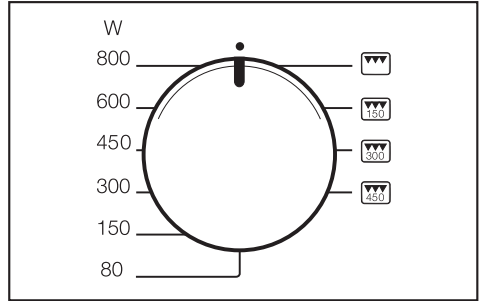

- When you have finished programming, turn the power selector to the 12 o'clock position.
- Start the programme to save the entry. Only ever run the entire programme with food in the appliance.

If there is no food in the appliance, then press the Stop/C button twice as soon as you have started it so that the appliance is not damaged by having no food in it.

1- and 2-stage programmes can be saved in the same way: the programming process is finished when the programme selector is in the 12 o'clock position and the Start button has been pressed, while pressing the M button shows the next stage.

Changing an entry

- Entering a new programme overrides the previously saved programme.

Saving your favourite programme

To call up your favourite programme

- Turn the programme selector to the 12 o'clock position.
- Press the M button.
- Press the Start button.

In the event of a power cut, the favourite programme is no longer saved and must be re-entered.

Changing the settings

Some of the standard settings for the appliance (which are set at the factory) have an alternative which you can select if required.

Please consult the chart for the different options. The factory settings are marked with a star* on the chart.

Proceed as follows:

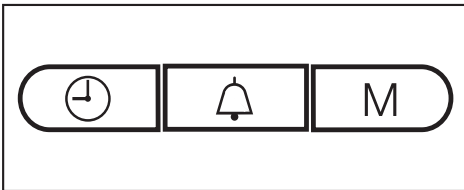

- Press and hold the ⌚ and M buttons at the same time until **P 1** and  light up in the display. Then release them. If you press them for too long, the time of day will appear again in the display.
- Use the time selector to select the setting that you wish to change (**P 1** to **P 5** and **P 0**). Turn it until the setting required shows in the display.
- Then press the M button to call up the setting.
5 will appear in the display to show that the setting can be changed.
- Turn the time selector if you wish to change the setting (see chart), and confirm your entry by pressing the M button (for **P 5** and **P 0**, press and hold the M button for approx. 4 seconds).

The change is then stored in memory. **P** will appear in the display again, together with the number for the setting.

The other settings can be changed in the same way.

- When you have finished making the changes you require, press the Stop/C button.

The altered settings are retained after a power cut.

Changing the settings

Setting		Settings available (* factory default)	
<i>P 1</i>	Night time switch-off	<i>5 0*</i> <i>5 1</i>	Night time switch-off is deactivated. Night time switch-off is activated. The time of day display is switched off from 11 pm to 4 am.
<i>P 2</i>	Automatic warming function	<i>5 1*</i> <i>5 0</i>	The automatic warming function is activated. The automatic warming function is deactivated.
<i>P 3</i>	"door" message	<i>5 1*</i> <i>5 0</i>	The "door" message appears if the door has not been opened during the 20 minutes before Start is pressed. Start is then blocked, as it is assumed that there is no food in the microwave. The "door" message does not appear.
<i>P 4</i>	Audible tone	<i>5 1*</i> <i>5 0</i>	The audible tone sounds briefly as a reminder every 5 minutes for 20 minutes after the end of the programme. The audible tone is deactivated.
<i>P 5</i>	Demo mode (for dealer showroom use only)	<i>5 0*</i> <i>5 1</i>	Demo mode is deactivated. When demo mode is deactivated, _ _ _ _ appears briefly in the display. The microwave is set to the showroom demo mode. When a button or selector is operated, <i>MES_</i> shows briefly in the display. The appliance can be operated, but the microwave and grill functions do not come on.
<i>P 0</i>	Factory default	<i>5 1*</i> <i>5 0</i>	Factory default settings have been restored, or have not been changed. Factory default settings have been changed.

Reheating

Select the following microwave power levels to reheat food:

- Drinks 800 W
- Food 600 W
- Food for babies and toddlers . 450 Watt

We do not recommend heating or reheating food or drinks for babies or young children in the microwave oven. Any decision to do this is the responsibility of the user, and should only be done with the utmost care. Pasteurised or sterilised cooked food should be gently heated at 450 W, and tasted to make sure it is not too hot for a baby's palate before serving. When reheating other food or drink, heat to a high temperature and allow to cool to a suitable heat for eating. For formula milk follow the manufacturer's instructions.

Tips on reheating

Always use a lid or cover for reheating food, except when a drier finish is needed, e.g. breaded poultry/meat.

Always remove the lids from jars, especially jars of baby food. Loosen the screw cap and the rubber teat before warming baby bottles. When reheating liquids, place the boiling rod supplied with the appliance into the cup or glass. Never reheat hard boiled eggs in a microwave oven, even without the shell. The eggs can burst.

Food taken straight from the refrigerator will take longer to reheat than food stored at room temperature. The time required depends on the nature of the food, its initial temperature and the amount to be cooked.

Always ensure that food is sufficiently cooked or reheated.

If in any doubt that a sufficiently high temperature has been reached, continue reheating for a little longer.

Stir or turn food from time to time during cooking. Stir the food from the outside towards the middle, as food heats more quickly from the outside.

After reheating

Be careful when removing a dish from the oven. It may be hot.

Although heat is not normally produced in the container itself by the microwaves (apart from stoneware), heat transfer from the food to the container may be considerable, making the container itself hot.

Allow food to stand for a few minutes at room temperature at the end of a reheating process to enable the heat to spread evenly throughout the food.

After heating food, especially food for babies and small children, stir the food or shake the container and check that the temperature does not pose any danger. Double check after it has been left to stand.

Place the food in a microwave-proof dish and cover it.

When cooking, it is a good idea to select a power level of 800 W to start with and then when the food is hot reduce the power level to 450 W for more gentle continued cooking.

For dishes such as **rice or semolina pudding**, first select a power level of 800 W, and then reduce it to 150 W for simmering.

Tips on cooking

Vegetable cooking times depend on the texture of the vegetable.

Fresh vegetables contain more water than vegetables which have been stored, and usually cook more quickly. Add a little water to vegetables which have been kept stored.

Food taken straight from the refrigerator takes longer to cook than food which has been kept at room temperature.

Stir or turn food from time to time during cooking to help it cook more evenly.

Ensure that food such as meat and fish are thoroughly cooked for an appropriate length of time.

Food with a thick skin or peel, such as tomatoes, sausages, jacket potatoes and aubergines, should be pierced or the skin cut in several places before cooking to allow steam to escape and to prevent the food from bursting.

Eggs can only be cooked in their shells in the microwave oven in a specially designed egg-boiling device available from specialist shops.

Eggs can burst, even after they have been taken out of the oven.

Eggs can be cooked without their shells in the microwave oven, only if the yolk membrane has been punctured several times first.

The pressure could otherwise cause the egg yolk to explode.

After cooking

Be careful when removing a dish from the oven. It may be hot.

Although heat is not normally produced in the container itself by the microwaves (apart from stoneware), heat transfer from the food to the container may be considerable, making the container itself hot.

Allow food to stand for a few minutes at room temperature at the end of cooking to enable the heat to spread evenly throughout the food.

Defrosting/Defrosting and reheating or cooking

Defrosting

Select the following microwave power settings to reheat food:

- 80 W
for defrosting very delicate food, e.g. cream, butter, gateau and cheese.
- 150 W
for defrosting everything else.

Remove the food from its packaging and place in a microwave-proof container. Do not cover. Turn, stir or separate the food about halfway through the defrosting time.

To defrost meat, unpack the frozen meat and place it on an upturned plate in a glass or china container so that the meat juice can run off and be collected. Turn halfway through defrosting.

It is particularly important to observe food hygiene rules when defrosting poultry. Do not use the liquid from the defrosted poultry. Pour it away, and wash the tray, the sink and your hands. Danger of salmonella poisoning.

Fish does not need to be fully defrosted before cooking.

Defrost so that the surface is sufficiently soft to take herbs and seasoning.

Defrosting followed by reheating or cooking

Deep-frozen food can be defrosted and immediately reheated or cooked.

After defrosting, select 800 W followed by 450 W.

Remove the food from its packaging and place in a covered microwave-proof dish for defrosting and reheating or cooking. Exception: Minced meat should be left uncovered while cooking.

Soups, stew and vegetables should be stirred several times during the process. Carefully separate and turn slices of meat halfway through the programme. Turn pieces of fish at the halfway stage.

After defrosting followed by reheating or cooking

Allow the food to stand at room temperature for a few minutes to enable the heat to spread evenly throughout the food.

Some suggested uses

Food	Quantity	Micro-wave power level (in watts)	Time (in minutes)	Notes
Melting butter and margarine	100 g	450	1:00 – 1:10	Do not cover.
Melting chocolate	100 g	450	3:00 – 3:30	Do not cover. Stir halfway through melting.
Dissolving gelatine	1 packet + 5 tbsp water	450	0:10 – 0:30	Do not cover. Stir halfway through dissolving.
Preparing flan topping/jelly glaze	1 packet + 250 ml liquid	450	4 – 5	Do not cover. Stir halfway through heating.
Yeast dough	Made with 100 g flour	80	3 – 5	Cover and leave to prove.
Popcorn	1 tbsp (20 g) popcorn	800	3 – 4	Place popcorn in a 1-litre container, cover and cook.
Salad dressings	125 ml	150	1 – 2	Heat uncovered on a gentle heat.
Tempering citrus fruits	150 g	150	1 – 2	Place on a plate, do not cover.
Bacon	100 g	800	2 – 3	Place on kitchen paper, do not cover.
Softening ice cream	500 g	150	2	Place open ice cream container in microwave.
Warming plates	4 plates	800	2 – 3	Do not heat plates with metal rim or decoration in microwave.
Skinning tomatoes	3 tomatoes	450	6 – 7	Cut a cross shape into the top of each tomato, cover, and heat in a little water. The skins will slip off easily. Take care, as the tomatoes may get very hot.
Strawberry jam	300 g strawberries, 300 g jam sugar	800	7 – 9	Mix the fruit and sugar in a deep container, cover and cook.
Defrosting and baking bread rolls	2 rolls	150 + Grill Grill	1 – 2 4 – 6	Place on the rack, turning halfway through.

The information given in this chart is intended only as a guide.

Cleaning and care

In the UK, Miele branded cleaning and conditioning products, as well as a microfibre E-Cloth which is suitable for cleaning surfaces such as stainless steel, glass, plastic and chrome without the use of chemicals, are available to purchase from your Miele retailer, the Spare Parts Department or on-line at www.miele-shop.com.

Disconnect the microwave oven from the power supply before cleaning (e.g. switch off at the socket and remove the plug).

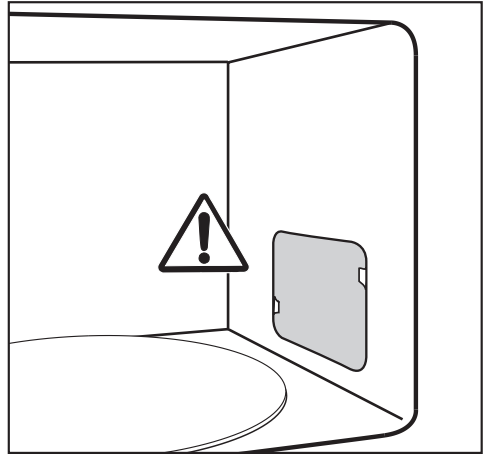

Oven interior and inside of the door

The oven interior can get hot during use. To avoid the danger of being burnt, wait until it has cooled down before cleaning. It should be cleaned after each use. Waiting too long can make cleaning unnecessarily difficult and in some cases impossible.

In certain circumstances, very heavy soiling can even damage the appliance.

The oven interior and door interior can be cleaned using a damp cloth with a little washing-up liquid or a mild detergent and water. Wipe dry with a soft cloth.

For more heavy soiling, heat a glass of water for 2 to 3 minutes until the water begins to boil. The steam will collect on the walls and soften the soiling.

The oven interior can now be wiped clean using a little washing-up liquid if necessary.

Do not remove the cover to the microwave outlet inside the oven, nor the film covering the inside of the door.

Do not let water or any small particles penetrate the vents in the appliance.

Wring out cloths before using them to wipe out the oven to avoid moisture getting into the openings.

Do not use abrasive cleaners, as these scratch the surface.

To neutralise odours in the oven, put a cup of water with some lemon juice in the oven and simmer for a few minutes.

The door should be kept clean at all times and checked at regular intervals for any signs of damage.

If any damage is noticed, the appliance should not be used until the fault has been rectified by a Miele authorised and trained service technician.

To clean the interior:

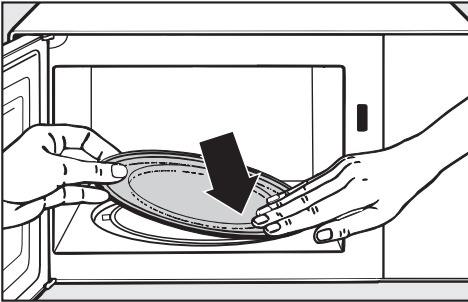

- Remove the turntable, and wash in the dishwasher or by hand.

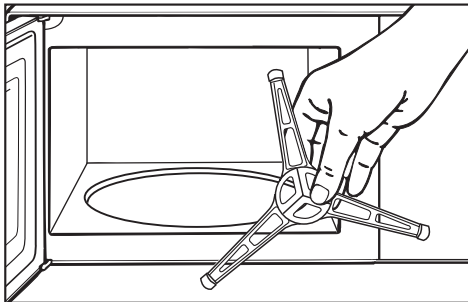

- Always keep the roller ring underneath it clean as well as the oven floor to enable the turntable to turn smoothly.

- Clean the area between the turntable and the carrier.

Do not turn the carrier manually, as this could damage the drive motor.

Appliance front

Remove any soiling immediately. If not, it might become impossible to remove and could cause the surface to alter or discolour.

Clean the front using a Miele microfibre E-cloth or with a sponge and a solution of hot water and washing-up liquid. Then dry with a soft cloth.

All types of outer surface are susceptible to scratching. Scratches on glass surfaces could even cause a breakage.

Contact with unsuitable cleaning agents can alter or discolour the outer surfaces.

On stainless steel surfaces to help prevent re-soiling, a conditioning agent for stainless steel can also be used. Follow the manufacturer's instructions on the packaging.

Cleaning and care

To avoid damaging the outer surface, do not use:

- cleaning agents containing soda, ammonia, acids or chlorides,
- cleaning agents containing descaling agents,
- abrasive cleaning agents, e.g. powder cleaners and cream cleaners.
- solvent-based cleaning agents,
- stainless steel cleaning agents,
- dishwasher cleaner,
- oven sprays,
- glass cleaning agents,
- hard, abrasive sponges and brushes, e.g. pot scourers,
- sharp metal scrapers.

Accessories supplied

Boiling rod

The boiling rod can be washed in a dishwasher.

Cover

Wash and dry the cover after each use. The cover can be washed in a dishwasher. However, discolouration caused by natural dyes, e.g. from carrots, tomatoes or ketchup, may occur.

This discolouration is irreversible but does not affect the stability of the cover.

Rack

Wash and dry the rack after each use. It is dishwasher-proof, or can be washed by hand in hot water with a little washing up liquid. Remove stubborn soils with a stainless steel cleaner.

Glass tray

The glass tray can be washed by hand using a solution of hot water and washing up liquid or in a dishwasher. Do not use abrasive cleaning agents.

Gourmet plate

Clean the gourmet plate with hot water and a cloth with a little washing-up liquid to remove any grease.

Do not use wire wool, or abrasive sponges, aggressive or abrasive cleaning agents.

The gourmet plate is not suitable for cleaning in a dishwasher.

If the gourmet plate has been used to prepare foods with a strong aroma, you can neutralise any odours by adding some water and lemon juice to the gourmet plate and heating in the microwave at maximum power for a few minutes. Rinse the gourmet plate afterwards with clean water.

Repairs to this appliance must only be carried out by a Miele approved service technician in strict accordance with current local and national safety regulations. Repairs and other work by unqualified persons could be dangerous. The manufacturer cannot be held liable for unauthorised work.

Some minor problems can be corrected without contacting the Miele Customer Contact Centre.

What to do if . . .

. . . a programme will not start.

Check whether,

- the appliance door is closed properly.
- the system lock has been activated (see "System lock").
- the appliance is plugged into the mains supply and switched on at the socket.
- the mains fuse has tripped (call a qualified electrician or the Customer Contact Centre if it has. See "After sales service").

. . . a noise can be heard after a cooking programme.

This is not a fault.

The cooling fan will continue to run for a while after the oven has been switched off to dispel any moisture from the oven and prevent it settling on the control panel or surrounding furniture. It will switch off automatically.

. . . the display does not light up.

Check whether,

- the time of day display has been switched off (press and hold the ⊕ button for a few seconds).
- the time of day display has been programmed to switch off at night.

. . . the turntable does not turn smoothly.

- Check whether the area underneath the roller ring is clean.
- Check whether the surfaces between the turntable and the carrier are clean.

Remove any soiling.

. . . food is not adequately defrosted, heated or cooked at the end of the selected cooking duration.

- Check whether the correct power level was selected for the duration set.
The lower the power level, the longer the duration required.
- Check whether the programme has been interrupted and not restarted.

Problem solving guide

. . . strange noises are heard when the microwave oven is being used.

Check whether,

- the food is covered with aluminium foil.
If so, remove it.
- Sparks are being created by the use of crockery with a metallic finish. See notes on suitable types of containers.

. . . the time of day in the display is not accurate.

If there has been a power cut, the time automatically switches back to 12:00. The time of day needs to be re-set.

- Set the correct time of day.

. . . food cools down too quickly.

In the microwave oven, food begins to cook from the outside first, the inside of the food relying on the slower conduction of heat.

If food is cooked at a high power level, it is possible that the heat may not have reached the centre of the food, so it is hot on the outside but cold in the centre. During standing time heat is transferred to the centre of the food. This may leave the food warm in the middle but cool on the outside. When reheating food with different densities, such as plated meals, it is therefore sensible to select a lower power level and lengthen the duration required.

. . . the microwave switches itself off during a cooking, reheating or defrosting programme.

There may be insufficient air circulation.

Check whether,

- the air inlet or outlet is blocked.

Remove any objects if necessary. The appliance switches off automatically in cases of overheating. Cooking can be continued after a cooling-down period.

If the microwave oven switches itself off repeatedly, please call the Miele Customer Contact Centre.

If it is not possible to remedy a fault by following the instructions given above, on no account open the appliance casing.

This microwave oven should only be repaired by a suitably qualified technician trained by Miele.

In the event of any faults which you cannot remedy yourself, or if the appliance is under guarantee, please contact:

– your Miele Dealer

or

– the Miele Customer Contact Centre
(see back cover for address).

When contacting your Dealer or the Miele Customer Contact Centre, please quote the model and serial number of your appliance. These are to be found on the data plate inside the front of the appliance.

Please note that telephone calls may be monitored and recorded to improve our service.

Electrical connection

Before connecting the appliance, ensure that it has not been damaged in any way. Do not use a damaged appliance.

Electrical connection U.K.

All electrical work should be carried out by a suitably qualified and competent person in strict accordance with current national and local safety regulations (BS 7671 in the UK).

The appliance is supplied with a mains cable and moulded plug ready for connection to an a.c. single phase 220-240 V 50 Hz supply.

The voltage and connected load are given on the data plate which is located inside the door to the appliance. Please ensure that these match the household mains supply. The fuse rating is quoted on the plug.

Connection should be made via a fused connection unit or a fused plug and a suitable switched socket, or via a suitable isolator, which complies with national and local safety regulations, and the on/off switch should be easily accessible after the appliance has been installed. If it is installed via an isolator switch, connection **must** be carried out by an electrician.

When switched off there must be an all-pole gap of 3 mm in the isolator switch (including switch, fuses and relays acc. to EN 60335).

If the switch is not accessible after installation (depending on country) an additional means of disconnection must be provided for all poles.

For extra safety it is advisable to install a residual current device. Please contact a qualified electrician for advice.

WARNING
THIS APPLIANCE MUST BE EARTHED

Non-rewireable plugs BS 1363

The fuse cover must be re-fitted when changing the fuse, and if the fuse cover is lost the plug must not be used until a suitable replacement is obtained. The colour of the correct replacement cover is that of the coloured insert in the base of the plug, or the colour that is embossed in words on the base of the plug, (as applicable to the design of plug fitted).

Replacement fuses should be ASTA approved to BS 1362 and have the correct rating. Replacement fuses and fuse covers can be purchased from your local electrical supplier.

If the connection cable is damaged it must be replaced by a Miele approved Service Technician only.

This appliance conforms with European Standard EN 55011 as a Group 2, Class B product. Group 2 appliances use high frequency energy in the form of electro-magnetic waves to create heat in food. Class B is assigned to appliances that are suitable for domestic use.

When building in the appliance, ensure that the vent outlets at the front of the appliance are not hindered, and that there is adequate ventilation to the rear of the housing unit by leaving a large enough gap (see diagram: 16 mm x unit width). Do not block the ventilation gaps with any objects.

For safety reasons, do not build the appliance into a wall unit that is directly above a hob.

A minimum installation height of 850 mm must be maintained.

To transport the appliance, make sure that you lift it by the appliance housing and not by the frame. The frame is not sturdy enough to bear the weight of the appliance when it is being carried.

The appliance can fit into a 350 mm high niche in a tall unit or a wall unit, or a 360 mm high niche in a tall unit.

Building-in dimensions

M 8161

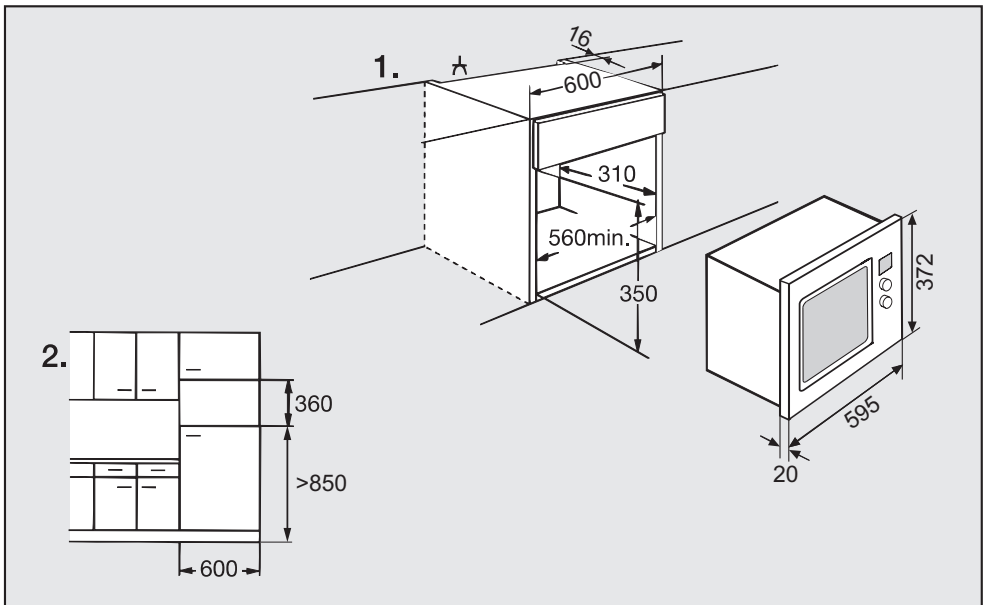



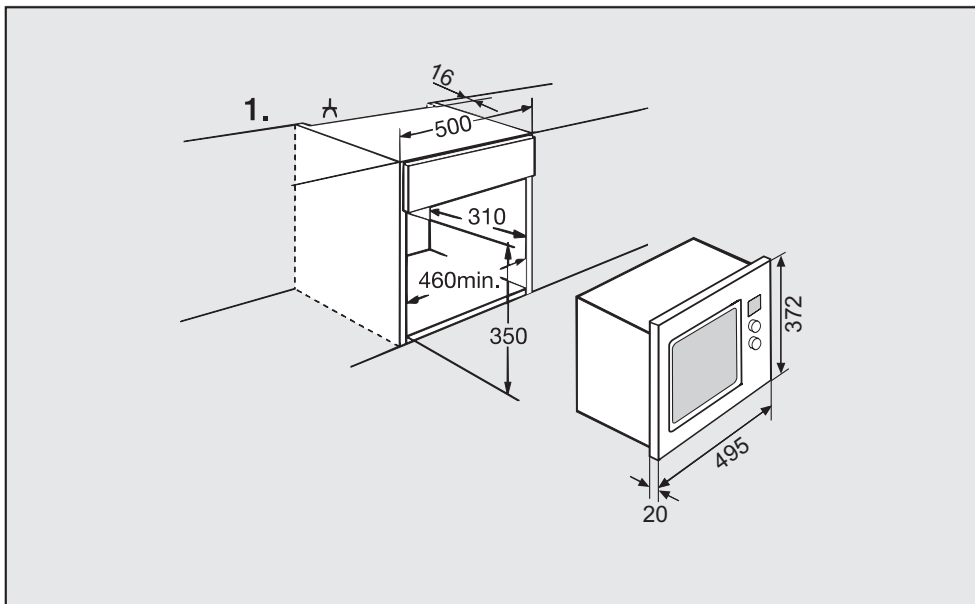

Installation

M 8151



Building-in kit

The following items are supplied in the accessory pack for installing the appliance:

 4 x 16mm	A	3x
	B	1x
	C	3x
 4 x 20mm	D	2x

Installation

The appliance must be built in before it can be used. Otherwise it poses an electric shock hazard.

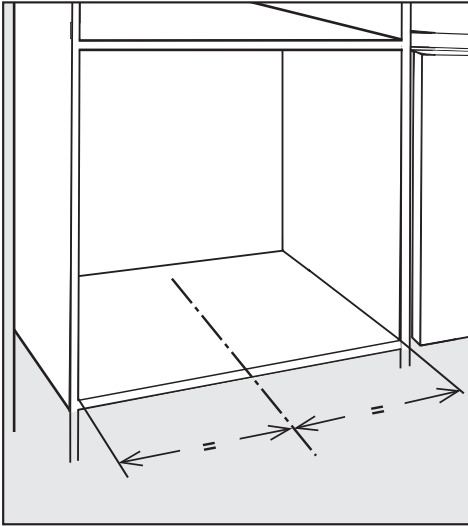

- Draw a line inside the housing unit to mark the middle of the unit as illustrated.

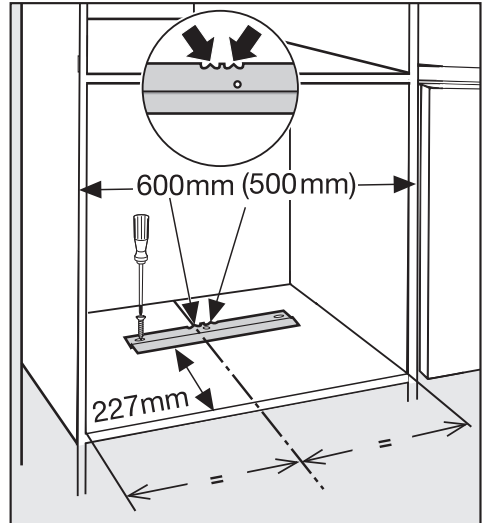

- Position the fixing bracket on this middle line. There are two indented marks on the bracket to guide you. Use the appropriate one for the width of your kitchen cabinet.
- Fit one screw (A) into the centre of the first long slot.
- Check the alignment with the front edge of the unit and with the middle line, and then fit another screw (A) into the other long slot.
- Then tighten both of these screws.

1. Niche height 350 mm

- Place the appliance in the housing unit and using your hands push on both sides of the back of the oven interior to move the appliance into position. It will engage in position when it is correctly installed.
- Check that it is correctly aligned.

Installation

- If it is not aligned correctly, carefully pull it back out of the niche and realign it by slightly adjusting the position of the bracket on the long slots.
- When correctly aligned, insert the third screw (A) into the middle of the bracket to prevent the bracket moving out of position.

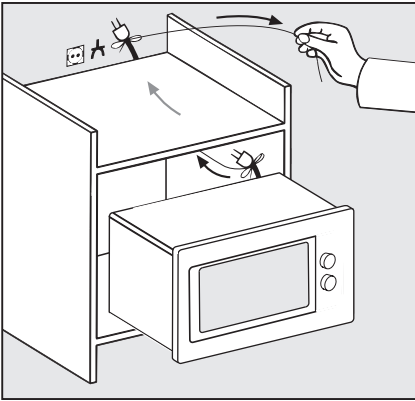

- Slide the appliance into the housing unit, and pull the cable with the plug* through the back of the unit.
- Connect the appliance to the electricity supply.
- Then push the appliance right back into the housing unit as described above.

* Plug shown is for illustration purposes only.

2. Niche height 360 mm

- Remove all the accessories, including the turntable and the roller ring, from the microwave oven cavity.
- Place the microwave oven on its side.
- Unscrew the front left foot and using the same screw fit foot (B) in its place.
- Then unscrew both back feet and fit a spacer (C) between each foot and the base plate. Use the two larger screws (D) for securing these 10 mm higher feet.
- Then take the third spacer (C) and using one of the two shorter screws taken from the back feet, screw it into the drill hole on the underside of the appliance next to the cable entry point.
- Now proceed as described in "1. Niche height 350 mm".



United Kingdom:

Miele Co. Ltd.
Fairacres, Marcham Road
Abingdon, Oxon, OX14 1TW
Tel: (01235) 554455
Fax: (01235) 554477
Customer Contact Centre Tel: (08707) 554466
E-mail: info@miele.co.uk
Internet: www.miele.co.uk

Australia:

Miele Australia Pty. Ltd.
A.C.N. 005635398
1 Gilbert Park Drive, Knoxfield, VIC 3180
Tel: (03) 9764 7130
Fax: (03) 9764 7149
Internet: www.miele.com.au

China

Miele Shanghai Rep. Office
Room 4105 - 6, 41 Floor
Plaza 66, 1266 Nan-Jing Road/ West
Shanghai 200040
Tel: +86 21 6288 4200
Fax: +86 21 6288 4100
E-mail: mieleshanghai@cn.miele.com
Internet: www.miele.cn

Hong Kong:

Miele (Hong Kong) Limited
AIA Plaza, 24 Floor
18 Hysan Avenue
Causeway Bay
Tel: +852- 2610-1331
Fax: +852-2610-1013
E-mail: mielehk@miele.com.hk
Internet: www.miele.hk

Ireland:

Miele Ireland Ltd.
Broomhill Road, Tallaght, Dublin 24
Tel: (01) 461 0710
Fax: (01) 461 07 97
E-Mail: info@miele.ie
Internet: www.miele.ie

New Zealand

Miele New Zealand Limited
Unit L, 10-20 Sylvia Park Road
Mt. Wellington, 1060, Auckland, NZ
Tel: (09) 573 1269
Fax: (09) 573 1268
Internet: www.miele.co.nz

South Africa:

Miele (Pty) Ltd
63 Peter Place, Bryanston 2194
P.O. Box 69434, Bryanston 2021
Tel: +27 (0) 11 548-1900
Fax: +27 (0) 11 548-1935
E-mail: info@miele.co.za
Internet: www.miele.co.za

Singapore:

Miele Southeast Asia
Miele Pte. Ltd.
163 Penang Road
04 - 02/03 Winsland House II
Singapore 238463
Tel: +65 6735 1191
Fax: +65 6735 1161
E-Mail: infosea@miele.com.sg
Internet: www.miele.sg

United Arab Emirates

Miele Appliances Ltd.
P.O. Box 11 47 82
Gold & Diamond Park
Sheikh Zayed Road
Building 6 / Offices Nos. 6-214 to 6-220
Dubai
Tel: +971-4-341 84 44
Fax: +971-4-341 88 52
E-Mail: info@miele.ae
Internet: www.miele.ae



Free Manuals Download Website

<http://myh66.com>

<http://usermanuals.us>

<http://www.somanuals.com>

<http://www.4manuals.cc>

<http://www.manual-lib.com>

<http://www.404manual.com>

<http://www.luxmanual.com>

<http://aubethermostatmanual.com>

Golf course search by state

<http://golfingnear.com>

Email search by domain

<http://emailbydomain.com>

Auto manuals search

<http://auto.somanuals.com>

TV manuals search

<http://tv.somanuals.com>