

## Operating instructions

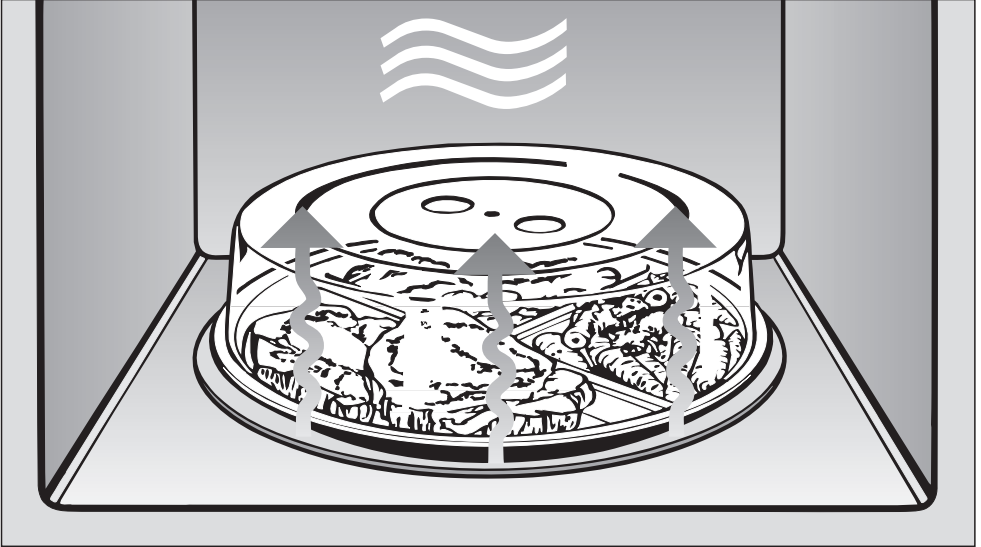

### Microwave ovens

M 616 EG

M 626 EG, M 636 EG

M 626 EC, M 636 EC

It is **essential** to read these operating instructions before installing or using the machine, to avoid the risk of accident, or damage to the machine.



M.-Nr. 04 674 691

# Contents

---

<b>Description of the appliance</b> . . . . .	4
<b>Caring for the environment</b> . . . . .	5
<b>Warning and Safety instructions</b> . . . . .	6
<b>How does the microwave oven function?</b> . . . . .	11
<b>Calculating power settings</b> . . . . .	12
<b>Suitable containers for microwave ovens</b>	
Material and shape . . . . .	13
Testing dishes for their suitability . . . . .	15
<b>Preparation for use</b>	
Setting the time of day . . . . .	17
Minute minder . . . . .	17
Audible tone . . . . .	17
Opening the door . . . . .	17
Closing the door . . . . .	17
<b>Operating modes</b> . . . . .	18
<b>Operation</b>	
Microwave-Solo . . . . .	19
Automatic "Keeping warm" . . . . .	19
Switching off the turntable . . . . .	20
Interrupting a process . . . . .	20
Cancelling a process . . . . .	20
Fault indication . . . . .	20
Fan Heat (only on models M 626 EC and M 636 EC) . . . . .	21
Fan Grilling (only on models M 626 EC and M 636 EC) . . . . .	21
Grilling . . . . .	22
Combination mode - Microwave with Grilling . . . . .	22
Combination mode - Microwave with Fan Heat (only on models M 626 EC and M 636 EC) . . . . .	23

Combination mode - Microwave with Fan Grilling (only with models M 626 EC and M 636 EC) . . . . .	23
Automatic defrosting . . . . .	24
Automatic cooking . . . . .	24
Combining Automatic programmes . . . . .	25
Short step system . . . . .	26
Delaying start (only on models M 626 EC and M 636 EC) . . . . .	27
<b>Practical tips</b> . . . . .	28
Reheating . . . . .	28
Cooking . . . . .	29
Defrosting . . . . .	30
Defrosting and reheating or cooking . . . . .	30
Examples . . . . .	31
<b>Cleaning and care</b> . . . . .	32
<b>Problem solving guide</b> . . . . .	34
<b>After sales service</b> . . . . .	36
<b>Installation and electrical connection</b> . . . . .	37
<b>Technical data</b> . . . . .	39

# Description of the appliance

M 616 EG, M 626 EG, M 636 EG

M 626 EC, M 636 EC

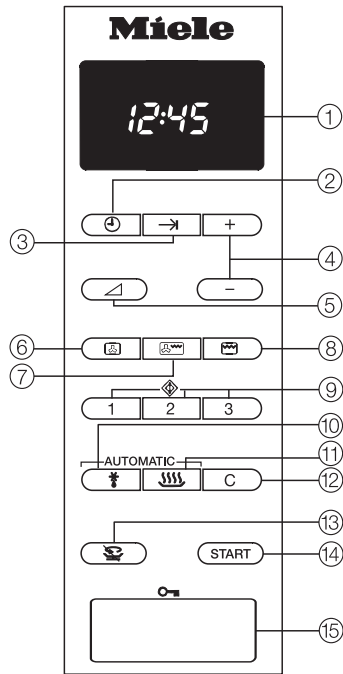
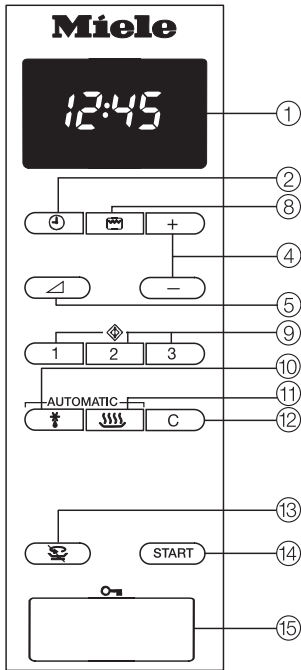

- ① Electronic clock with display area
- ② Touchpad to set time ⌚
- ③ Touchpad for delayed start →|
- ④ Input touchpads +/-
- ⑤ Microwave power setting touchpad ▽
- ⑥ Fan heat touchpad [fan]
- ⑦ Fan grilling touchpad [fan with grill]
- ⑧ Grill touchpad [grill]
- ⑨ Programme memory store touchpad 1, 2, 3
- ⑩ Automatic defrosting touchpad \*
- ⑪ Automatic cooking touchpad [wavy lines]
- ⑫ Cancel touchpad C
- ⑬ Turntable touchpad [turntable]
- ⑭ START touchpad
- ⑮ Door button [door]

### **Disposal of the packing material**

The transport and protective packing has been selected from materials which are environmentally friendly for disposal and can normally be recycled.

Rather than just throwing these materials away, please ensure they are offered for recycling.

### **Disposal of your old machine / appliance**

Old machines / appliances may contain materials which can be reclaimed or recycled. Please contact your dealer, your local waste collection centre or scrap merchant about potential recycling schemes.

Ensure that the machine / appliance presents no danger to children while being stored for disposal

See the appropriate section in the "Warning and Safety" instructions.

# Warning and Safety instructions

---

This appliance complies with all relevant legal safety requirements. Improper use of the appliance can, however, present a risk of both personal injury and material damage. Before installation and before using the appliance for the first time, read the operating instructions carefully. They contain important notes on safety, on the operation and care of the appliance. This way you will avoid the risk of accidents and damage to the appliance. Do not let children access the appliance or its controls. Supervise its use by the elderly or infirm. Keep these instructions in a safe place and pass them on to any future user.

## Correct usage

The appliance is intended for domestic use only: to cook food, and in particular to defrost, re-heat, cook, and to grill. Any other usage is at the owner's risk and could be dangerous. The manufacturer cannot be held responsible for damage caused by improper use of the appliance.

## Technical safety

Do not use the microwave if

- the door is warped.
- the door hinges are loose.
- holes or cracks are visible in the casing, the door, the door seal or the oven interior walls. Switching on with this type of damage could result in microwaves no longer being contained within the oven, and presenting a hazard to the user.

Repairs may only be carried out by suitably competent and qualified service technicians trained by Miele to ensure safety. Repairs and other work by unqualified persons could be dangerous.

Never open the casing of the appliance. Tampering with electrical connections or components and mechanical parts is highly dangerous to the user and can cause operational faults or electric shock.

If the connection cable is damaged the new cable must be fitted by a Miele service engineer or an authorised agent.

Before connecting the appliance to the mains supply make sure that the rating on the data plate corresponds to the voltage and frequency of the household supply. It is essential that these data correspond as otherwise damage will occur to the machine. If in doubt consult a suitably competent person.

The electrical safety of this appliance can only be guaranteed when continuity is complete between the appliance and an effective earthing system, which complies with local and national regulations. It is most important that this basic safety requirement is tested by a qualified electrician. The manufacturer cannot be held responsible for the consequences of an inadequate earthing system such as electric shock.

# Warning and Safety instructions

---

■ The appliance is only completely isolated from the electricity supply when:

- it is switched off at the wall socket and the plug removed.
- Hold the plug and do not pull on the cable to remove the plug.
- The house mains fuse is switched off.
  - The fuse is screwed out ( in countries where this is applicable).

■ Do not connect the appliance to the mains electricity supply by an extension lead.

Extension leads do not guarantee the required safety of the appliance, (for example danger of overheating).

## Use

■ Always ensure that food has been thoroughly heated before eating. Many factors will affect the overall cooking time, including the size and amount of food, its initial temperature, changes to the recipe and the shape and size of cooking container. Some foods may contain micro organisms which are only destroyed by thorough cooking, therefore when cooking or reheating foods, e.g. poultry it is particularly important that food is fully cooked through (at more than 70 °C, for more than 10 minutes). If in any doubt as to whether the selected time or temperature is sufficient, select a slightly longer time or higher temperature.

■ It is important that the heat is allowed to spread evenly throughout the food being cooked. This can be achieved by stirring and/or turning the food, and by observing a sufficiently long standing time, which

should be added to the time needed for cooking, reheating or defrosting

■ Always remember that cooking times in a microwave oven are usually considerably shorter than with traditional methods of food preparation. Excessively long cooking times can lead to food drying out and eventually burning, or could even cause it to catch fire.

There is also a danger of fire if bread-crumbs, flowers, herbs, etc., are dried in the microwave oven. Always ensure that this type of procedure is supervised.

■ Do not use full power if you warm empty dishes or dry herbs. The lack or minimum amount of food could cause damage to the appliance.

■ Never cook or reheat food or liquids in sealed containers or bottles. With babies' bottles the screw top **and** teat must be removed. Otherwise pressure builds up which can cause the bottle or container to explode posing a severe risk of injury.

■ Always check the temperature of the actual food itself after taking it out of the microwave. Do not be misled by the temperature of the container. **In particular when preparing food for babies, children, and the elderly or infirm, it is essential to check the temperature of the food or liquid itself, after stirring and before serving to avoid a burnt mouth.** The temperature of the container does not necessarily give a correct indication of the temperature of the food or liquid it contains.

# Warning and Safety instructions

---

■ When heating liquids, the boiling rod provided should be placed into the container.

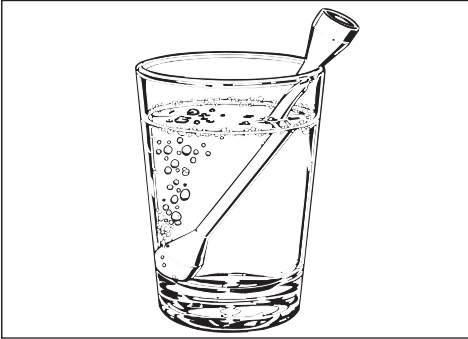

When heating, and especially reheating liquids, milk, sauces etc., in the microwave oven, the boiling point of the liquid may be reached without the production of typical bubbles. The liquid does not boil evenly throughout. This so-called 'boiling delay' can cause a sudden build up of bubbles, when the container is removed from the oven or shaken. This can lead to the liquid boiling over suddenly and explosively. There is a danger of burning. The formation of bubbles can be so strong that the pressure forces the oven door open. The user could be injured and the appliance damaged.

The boiling rod ensures that the liquid boils evenly and that bubbles form at an early stage during the operation.

■ If smoke occurs in the oven interior do not open the oven door, to avoid fuelling any flame. Cancel the process (press button C twice), switch off at the wall socket, and where applicable, remove the plug. Do not open the door until the smoke has dispersed.

■ Never heat undiluted alcohol in the microwave oven as this can easily ignite.

■ Do not use any containers, crockery or cutlery made from or containing metal, aluminium foil, lead crystal glassware, temperature-sensitive plastics, wooden utensils or cutlery, metal clips or wire ties. Do not use bowls with milled rims or cream pots with the tinfoil lid only partially removed. Such items could be damaged, or cause a fire hazard.

The rack supplied with the appliance is designed to be compatible with microwaves, and can therefore be used for grilling with and without the microwave function.

■ Eggs can only be cooked in their shells in the microwave oven in a specially designed egg-boiling device. Similarly, hard-boiled eggs should not be reheated in the microwave oven as this may lead to the eggs bursting, even once they have been removed from the oven.

■ Eggs can be cooked without their shells in the microwave oven only if the yolk membrane has been punctured several times first. The pressure could otherwise cause the egg yolk to explode.

■ Food with a thick skin or peel, such as tomatoes, sausages, jacket potatoes, aubergines, should be pierced or cut in several places to allow steam to escape and prevent the food from bursting.



# Warning and Safety instructions

---

Do not reheat food in the oven in heat-retaining bags intended for normal ovens.

These heat-retaining bags usually contain a thin layer of aluminium foil which reflects microwaves. This reflected energy can, in turn, cause the outer paper covering to become so hot that it ignites.

Always ensure that food or the browning dish has been placed in the microwave, and that the turntable is in place, before switching on.

Do not leave the oven unattended when cooking with oils and fats as these can be a fire hazard if allowed to overheat.

Ovenproof earthenware can retain a considerable amount of moisture. Earthenware and porcelain containers with hollow handles and lid knobs must only be used in this oven if they have vent holes, which allow the moisture to escape. Without vent holes there can be a pressure build-up, causing the container to crack or shatter, with the danger of injury.

In all operating modes, except Microwave-Solo, the oven interior, the grill element, the side runners, the oven door and the housing get hot. Do not let small children touch the oven while it is in operation, there is a danger of being burnt. Supervise its use by the elderly or infirm.

Wear oven gloves when taking dishes in and out of the oven, or when handling dishes or food in the oven if the oven is or has just been in operation.

Use the rack only for grilling with or without microwave mode. Use the baking tray only for Fan Heat. Take care not to burn yourself.

During use the grill and baking tray will get hot. Use oven gloves when handling them.

Do not use the oven to heat up the room. Due to the high temperatures radiated, objects left near the oven could catch fire.

To measure the temperature only use a thermometer only specifically approved for use in a microwave oven. Never use a thermometer with mercury or liquid.

In countries which may be subject to infestation by cockroaches or other vermin, pay particular attention to keeping the appliance and its surroundings in a clean condition at all times. Any damage which might be caused by cockroaches or other vermin will not be covered by the appliance guarantee.

Under no circumstances use a steam cleaner to clean this appliance. Pressurised steam could give rise to a short circuit, or cause permanent damage to the surface and to components, for which the manufacturer of the oven cannot accept any responsibility.

# Warning and Safety instructions

## Special accessories

Never place the hot glass tray (or any other hot cooking containers) onto a cold surface, such as a tile or granite worktop. The tray or container could shatter or break and the worktop surface could be damaged. Use a heat-resistant mat or wire cooling rack.

Only for microwave ovens built in with a lift-up door:

Do not bring this down into the closed position when the oven is in operation.

An anti-splash roof liner is available as an optional extra. You can slide this in above the grill before using the oven.

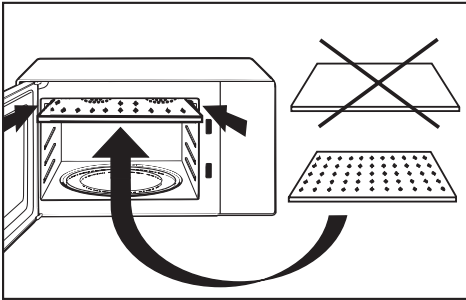

M 616 EG

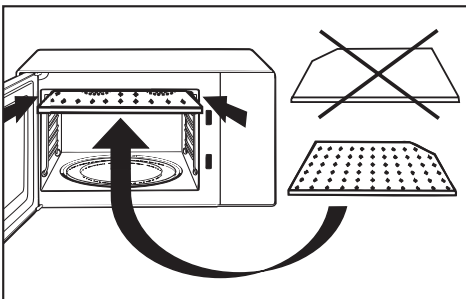

M 626 EG, M 626 EC, M 636 EC

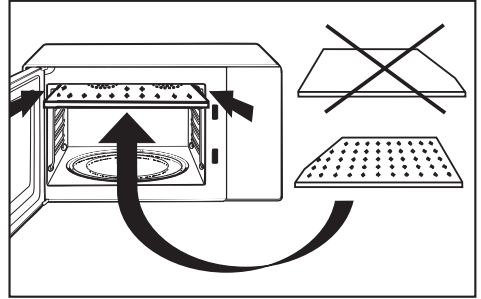

M 636 EG

## When using browning dishes:

Always use oven gloves when handling the browning dish to avoid burns.

Never place a browning dish directly on to a table or worksurface. Instead use a suitable heat-resistant mat, grid or board to protect the work surface or table, which could otherwise be heat-marked.

Use browning dishes in a microwave oven only, or as a serving dish. In a conventional oven the special glaze would suffer damage.

## Disposal of old machines / appliances

Before discarding an old machine or appliance switch off and disconnect it from the power supply. Cut off and render any plug useless.

Cut off the cable directly behind the machine to prevent misuse.

The manufacturer cannot be held liable for damage caused by non-compliance with safety instructions.

# How does the microwave oven function?

In the microwave oven, food is cooked, reheated or defrosted more quickly than by any other method.

## How does the microwave oven function?

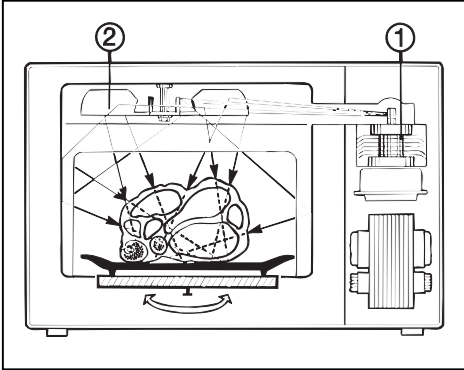

In a microwave oven there is a high-frequency tube called a magnetron ①. This converts electrical energy into microwaves. These microwaves are distributed evenly throughout the oven interior by a metal fan blade known as a stirrer ②, rebounding off the metal sides of the oven interior and thereby reaching the food from all sides. Microwave distribution is improved by engaging the turntable.

In order for microwaves to reach the food, they must be able to penetrate the cooking utensil being used. Microwaves can penetrate porcelain, glass, cardboard and plastics but not metal. Do not, therefore, use utensils made of metal, or which contain metal, for example in the form of gold or silver trim. The metal reflects the microwaves and this could lead to the creation of sparks. The microwaves cannot be absorbed.

Microwaves pass through a suitable container and find their way directly into the foodstuff. All foodstuffs contain moisture molecules which, when subjected to microwave energy, start to oscillate 2.5 thousand million times a second. The friction caused by this vibration creates heat, which first starts developing around the outside of the foodstuff and then slowly penetrates towards the centre. The moisture, fat and sugar content of food will affect the speed at which it is cooked.

As heat is produced directly in the food,

- food can generally be cooked without adding much liquid or cooking oil.
- cooking, re-heating and defrosting in a microwave oven is quicker than using conventional methods.
- nutrients, such as vitamins and minerals, are retained.
- colour, texture and taste of food are not impaired.

# Calculating power settings

---

This microwave has 9 power settings. Very often, power is expressed in watts on food packaging or in general recipes for microwaving.

The following table should help to convert the watts given to a matching power setting with these ovens.

Set- ting	Microwave oven with max.:		
	750 Watt [Watt]	850 Watt [Watt]	900/ 1000 Watt [Watt]
1	80	80	100
2	150	150	200
3	200	250	300
4	300	350	400
5	400	450	500
6	450	500	600
7	550	600	700
8	600	700	800
9	750	850	900/1000

## Example:

A recipe states:  
Cook in the microwave at 850 watts initially for approx. 5 minutes. Then continue for 20 minutes at 450 watts.  
For the microwave with 850 watts maximum power, using the table for guidance this converts to:

Cook in the microwave at setting 9 initially for approx. 5 minutes. Then continue for 20 minutes at setting 5.

Where the recipe gives a wattage which does not correspond exactly to the table, select the nearest power setting available. It may be necessary to adjust the time very slightly to compensate.

For appliances with a maximum setting of 1000 watts we recommend using the top setting (9) to heat clear liquids and keep them simmering. To prepare noodles and vegetables setting 8 is suggested followed by 4 or 5.

See recipes for cooking times. Be prepared to make adjustments where appropriate.

The maximum microwave power output in watts and the intermediate scale of settings in watts are given for each model of oven on the data plate, located at the rear of the oven.

Please make a note of these.

Examples of use given later in this book refer to oven models with a maximum microwave power output of 900/1000 watts. Adjust according to the table on this page for ovens with a different scale of output watts.

# Suitable containers for microwave ovens

## Microwaves

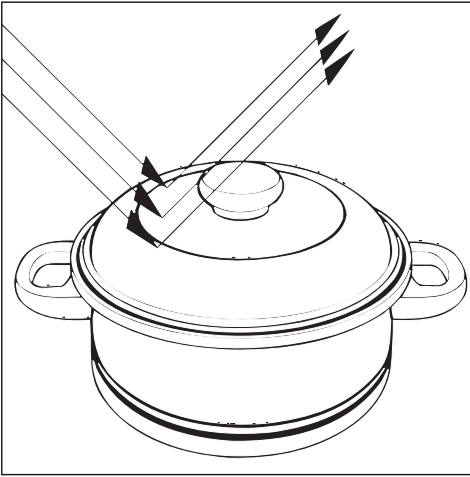

– are reflected by metal.

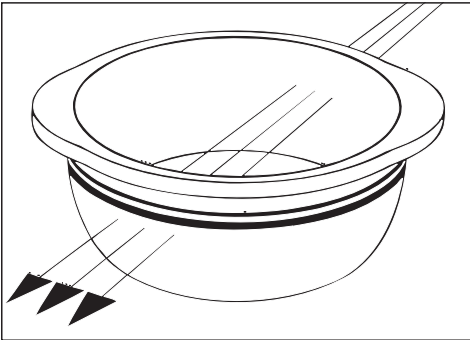

– pass through glass and china-ware, . . .

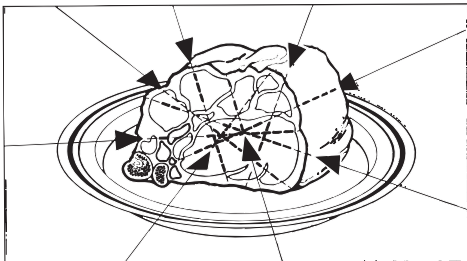

– and are absorbed by food.

## Material and shape

The material and shape of containers used affect the cooking results and times. Round and oval shaped ones provide good results. Heat distribution is more even than it is in rectangular containers.

## Metal

The following do not belong in an oven being used in microwave mode. Metal containers, aluminium foil and metal cutlery, or china with metallic decoration, such as gold rims or cobalt blue.

The metal reflects the microwaves, hindering the cooking process.

Exceptions:

– If recommended by the producer, pre-cooked meals packed in aluminium foil containers can be defrosted and reheated in the microwave oven. Important: remove the lid first. The disadvantage is that the food is only heated from the top. It is better to remove the food from the aluminium foil container and transfer it to a dish suitable for a microwave oven. The heat distribution will be more even.

If sparks and arcing occur when using a metal container, stop and transfer the food to a microwave safe container.

– Small pieces of aluminium foil. For even defrosting and to avoid overcooking unevenly shaped cuts of meat, poultry or fish, small areas of aluminium foil may be used to mask wingtips or other thin parts for the last few minutes

# Suitable containers for microwave ovens

---

of the process. The aluminium foil must not touch the interior walls of the oven.

Make sure that the aluminium foil is at least 2 cm from the oven walls at all times. It must not touch the walls.

– Metal meat skewers or clamps:  
Metal skewers and clamps should only be used if they are very small in comparison to the size of the cut of meat.

## Glassware

Heat-resistant glass or ceramic glass are ideal for use in the microwave oven.

Crystal glass contains lead which could cause the glass to crack. Glass dishes with a milled rim are subject to the same risk. Both are unsuitable for use.

## Porcelain (chinaware)

Porcelain (chinaware) is a suitable material.

Do not use porcelain with gold or silver edging or items with hollow knobs or handles, as insufficient ventilation may cause pressure.

## Earthenware

Decorated earthenware is only suitable if the decoration is beneath an all-over glaze. Earthenware can get very hot, and may crack.

## Glazes and colours

Some glazes and colours contain metal.

This makes them unsuitable for use in a microwave oven.

## Plastics

Plastic containers must only be used for microwave mode alone and not in normal oven mode. Plastics must be heat-resistant to a minimum of 180°C.

Otherwise the plastic may melt and fuse with the food.

Special plastic utensils, designed for use in microwave ovens are available from most department and hardware stores. Melamine ware is not suitable as it absorbs energy and heats up.

When purchasing plasticware, make sure that it is suitable for use in a microwave oven.

Disposable containers, such as trays made from polystyrene, can only be used for very short timed warming and re-heating of food.

Plastic boiling bags can be used for cooking and re-heating. They should be pierced beforehand so that steam can escape.

This prevents a build-up of pressure and reduces the risk of the bag bursting.

# Suitable containers for microwave ovens

**Roasting bags** and **tubes** can be used. Roasting tubes should be about 40 cm longer and roasting bags about 20 cm longer than the food being roasted, and carefully tied with string. Turn the ends over and secure them. Holes should be made according to the manufacturer's instructions.

Do not use metal clips or wire ties, even if bound by paper.

There is a danger that they will ignite when heated.

## Wood

Wooden dishes are not suitable

Moisture contained in the wood evaporates when exposed to microwave energy, causing the wood to dry and crack.

## Disposable containers



Only those plastic disposable containers which are specified by the producer as suitable for use in a microwave oven may be used.

Do not leave the oven unattended when re-heating or cooking food in disposable containers made of plastic paper or other inflammable material.

Disposable containers are not always recyclable or degradable.

## Testing dishes for their suitability

If in doubt as to whether glass, earthenware or porcelain plates or dishes are suitable for use in a microwave oven, a simple test can be performed:

- Place the item you wish to test in the centre of the oven, fill a suitable glass with water and also place this in the oven.
- Close the door.
- Enter a time of 30 seconds with the time selector .
- Select power setting P 8 with the  touchpad, or for the M 616 EG P 9.
- Do not switch off the turntable .
- Press the START control.

If a crackling noise is heard accompanied by sparks during the test, switch off the appliance immediately.

Any crockery which causes this reaction is unsuitable for use in the microwave oven.

The water in the glass should be warm, but the dish cool. If the dish is very hot and the water is cold, it would be unwise to use the dish.

# Suitable containers for microwave ovens

**Note:** Although some ovenproof earthenware can be used in a microwave oven, it may contain a considerable amount of moisture, causing it to become hot during use. It is normally advisable to avoid using it in a microwave oven.

If any doubt exists about the suitability of containers, please contact the maker.

This test cannot be used to check whether items with hollow knobs or handles are suitable for use in a microwave oven.

## A cover

- prevents too much steam escaping, especially when cooking foodstuffs which need longer to cook, such as potatoes.
- shortens and evens out the cooking process.
- keeps the oven interior cleaner.
- prevents food from drying out.
- contains the aroma.



Always use lids or covers made of microwave-safe glass or plastic, or use a clingfilm recommended for use in a microwave oven, (pierce as instructed by the producer).



Sealed glass containers, such as jars of food, must be opened before they are placed in the oven.

## Do not use a lid or cover if:

- food coated with breadcrumbs is being cooked.
- cooking meals which are to be given a crisp finish.
- using the grill.



## Setting the time of day





- Connect the appliance to the electricity supply.  
0:00 flashes in the display area.
- Use the +/- touchpads to set the hours (0 to 23).
- Press the  touchpad and use the +/- touchpads to set the minutes.
- Press the  touchpad again to confirm the time now showing in the display area.

The appliance is now ready for use.

## Altering the time of day

- Press the  touchpad twice.  
0:00 flashes in the display area.
- Alter the time of day as described above.

## Minute minder

- Press the  touchpad and then use the +/- touchpads to set the minute minder time you require (5 seconds up to 99 minutes).
- Press the  touch pad.  
The symbol  for microwave mode flashes in the display and P 9 appears.
- Hold the - touchpad pressed in until P 0 appears.  
The  symbol disappears and the  symbol for the minute minder flashes.

- Press the START touchpad.  
The time which has been entered appears in the display area and begins to count down in one second steps.
- An audible tone sounds when the minute minder time has elapsed.

## Audible tone

An audible tone sounds when the set time has elapsed. This is repeated after a few seconds.

- Press touchpad C to turn off the tone early.  
The time of day reappears in the display area.

## Opening the door

- Press the  button to open the door.  
The light comes on.

If the microwave is being used, opening the door will interrupt the cooking process. The relevant operating mode indicator will flash in the display area.

## Closing the door

- Push the door shut.

Press the START touchpad to continue an interrupted cooking process.

# Operating modes











---

## M 626 EC, M 636 EC

The 7 operating modes detailed below are available.



## M 616 EG, M 626 EG, M 636 EG

Here you can choose between 3 operating modes, Microwave Solo, Grill and a combination of these two, see 1, 4, and 7 below; (Fan Heat and Fan Grilling (with or without microwave mode) are not available).

- **1. Microwave-Solo mode**    
 Suitable for defrosting, reheating or cooking.
- **2. Fan Heat**  \*   
 Ideal for baking.
- **3. Fan Grilling**  \*   
 Use to grill or roast thicker cuts of meat and pieces of poultry. The fan and the grill heating element operate at the same time.
- **4. Grilling**    
 Ideal for grilling thinner items e.g. steaks or sausages.
- **5. Combination mode - Microwave**  **with Fan Heat**  \*   
 You can use this combination mode to prepare puddings very quickly.
- **6. Combination mode - Microwave**  **with Fan Grilling**  \*   
 This combination is particularly suitable for roasting and grilling.
- **7. Combination mode - Microwave**  **with Grilling**    
 Ideal for crisping and browning. The microwave cooks the food, the grill browns and crisps the surface.

\* only with models M 626 EC and M 636 EC

## Automatic programmes

The Automatic Defrosting programme  offers 4 programmes (d1 – d4). The Automatic Cooking programme  offers 8 programmes (C1 – C8). All the automatic programmes are weight dependent, which means that the weight of the food must be entered. The automatic programmes for defrosting and cooking can also be set to run one after the other.

## Short step system

Touchpads 1, 2, 3 allow you to store in the memory programmes you use frequently. Each memory store can be used again with a different programme.

## Delaying start

**(only on models M 626 EC and M 636 EC)**

The length of cooking time and the end of a process can be pre-programmed up to 24 hours beforehand.

## Automatic "Keeping warm"

The automatic "keeping warm" function will switch on for a maximum of 15 minutes after a cooking process using a power setting of 5 or higher has finished.

## Microwave-Solo

There is a choice of 9 power settings. The higher the power setting, the more microwaves reach the food.

When heating up food of differing composition, or which cannot be stirred or turned during cooking, as with a plated meal, it is preferable to heat these on a lower power setting. This ensures that the heat is distributed evenly. Heat for long enough to reach the temperature required.

### Times for defrosting, reheating and cooking

The necessary time depends on:





- the initial temperature of the food.  
Food taken from the refrigerator will need longer to be reheated or cooked than food already at room temperature.
- the type and texture of the food.  
Fresh vegetables probably contain more water and cook more quickly than stored vegetables.
- the shape and material of the container.
- the amount of food.

In general:

Double the amount of food - at least one third extra cooking time.

For smaller amounts of food reduce the time accordingly.

Ideally the container should be placed in the middle of the oven.

- Press the  touchpad and use the +/- touchpads to enter the cooking time you require (5 seconds up to 99 minutes).
- Press the  touchpad.  
The  symbol for microwave mode flashes in the display area and P 9 appears.
- Use the +/- touchpads to select the power setting you require.  
The  symbol flashes and the selected power setting appears.
- Press the START touchpad.  
The set time appears in the display area and begins to count down in one second steps.  
An audible tone sounds when the cooking time has elapsed.
- Press touchpad C to turn off the tone early.

Press the  touchpad if you want to call up the power setting while the appliance is in operation.

## Automatic "Keeping warm"

The automatic "keeping warm" function will switch on for a maximum of 15 minutes after a cooking process using a power setting of 5 or higher has finished.

H:H and the symbol  appear in the display area. The turntable continues to operate.

The process is cut short if the door is opened during this time.



The "keeping warm" stage cannot be set separately.

# Operation

---

## Switching off the turntable

The turntable is always switched on and should only be switched off if there is a danger of something blocking it, e.g. a large dish which is wider than the turntable.

- Press the  touchpad before you start the cooking process to switch off the turntable.  
The  symbol for the switched off turntable appears in the display area.

If you want to switch off the turntable while the microwave is being used, you must interrupt the cooking process by twice pressing the C touchpad and then re-enter the settings.

## Interrupting a process

- Press the C touchpad once to stop an operating function.  
The symbol for the operating function flashes in the display area and the time remaining appears.
- Press the START touchpad to continue the process.

## Cancelling a process

- Press the C touchpad twice to cancel the operating function which is in progress.

The time of day appears.

## Fault indication

- Press the C touchpad once if you make an unintentional entry and the letter E appears in the display area. You can then re-enter the settings.
- If E15 appears in the display this indicates overheating in the oven interior. Let the appliance cool down with the door open for 15 – 20 minutes. Afterwards, press the C touchpad and enter the settings again.

Dear Customer,

Congratulations on the purchase of your new Miele microwave oven. We trust you will be delighted with the wide range of programmes and applications it has to offer.

To help you make the most of your oven, we would be pleased to send you, free of charge, a copy of the

***Good Housekeeping Essential Microwave Handbook.***

This prestigious book contains over a hundred delicious recipes, all tested on Miele 850 W microwave ovens. Furthermore, it offers comprehensive advice on the basics of microwave cooking, how to use the different cooking techniques to best advantage and timing charts for thawing and cooking many types of food.

Please fill in the slip below and send it to:

Miele Company Limited, Fairacres, Marcham Road, Abingdon, Oxon OX14 1TW

Please note, this offer applies only to new microwave ovens purchased in the UK.

✂ .....

I have purchased a Miele microwave oven, model .....

from (name of retailer).....town.....

Please send me the ***Good Housekeeping Essential Microwave Handbook.***

Name:.....

Address:.....

.....

.....

.....

Signed:.....Date:.....















## Fan Heat

(only on models M 626 EC and M 636 EC)

- Press the  touchpad and use the +/- touchpads to set the cooking time you require (5 seconds to 99 minutes).
- Press the  touchpad.  
The set time as well as the pre-set temperature appear in the display area. The  symbol for the Fan Heat mode flashes.
- Use the +/- touchpads to select the temperature you require (50 °C – 250 °C).
- Press the START touchpad.  
The set time appears in the display area and begins to count down in one second steps.  
A red dot also lights up in the display area (heat warning indicator).  
An audible tone sounds when the cooking time has elapsed.

## Fan Grilling

(only on models M 626 EC and M 636 EC)

- Press the  touchpad and use the +/- touchpads to set the cooking time you require (5 seconds to 99 minutes).
- Press the  touchpad.  
The set time as well as the pre-set temperature appear in the display area and the  symbol for the Fan Grilling mode flashes.
- Use the +/- touchpads to select the temperature you require (50 °C – 200 °C).
- Press the START touchpad.  
The set time appears in the display area and begins to count down in one second steps.  
A red dot also lights up in the display area (heat warning indicator).  
An audible tone sounds after the cooking time has elapsed.

## Recommendations



The turntable should always be switched on when using the Fan Heat mode if placing the dish on the turntable.

You can take out the side runners (where fitted) when using larger dishes. Make use of the residual heat by leaving the food in the appliance for 5 minutes after the cooking time has finished.

# Operation

---

## Grilling







- Press the  touchpad and use the +/- to set the cooking time you require (5 seconds to 99 minutes).
- Press the  touchpad.  
The set time as well as the pre-set temperature appear in the display area. The  for the Grilling mode flashes.
- Use the +/- touchpads to select the temperature you require. (50 °C – 200 °C).
- Press the START touchpad.  
The set time appears in the display area and begins to count down in one second steps.  
A red dot also lights up in the display area (heat warning indicator).  
An audible tone sounds once the cooking time has elapsed.

## Recommendations

Turn over meat and fish half-way through the cooking time so that both sides are cooked and browned evenly. Thin slices and pieces only require to be turned over once, whereas larger, thicker pieces should be turned several times.

If the total grilling time is less than 15 minutes, pre-heat the grill for about 5 minutes.







## Combination mode - Microwave with Grilling

- Press the  touchpad and use the +/- touchpads to set the cooking time you require (5 seconds to 99 minutes).
- Press the  touchpad.  
The symbol  for the Microwave mode and P 9 appears.
- Use the +/- to select the power setting you require.  
The  symbol flashes and the selected power setting appears.
- Now press the  touchpad.  
The set time as well as the pre-set temperature appear in the display area. The  and  symbols flash.
- Use the +/- touchpads to select the temperature you require (50 °C – 200 °C).
- Press the START touchpad.  
The set time appears in the display area and begins to count down in one second steps.  
A red dot also lights up in the display area (heat warning indicator).  
An audible tone sounds after the cooking time has elapsed.

Press the  touchpad if you wish to call up the power setting while the appliance is in operation.

## Combination mode - Microwave with Fan Heat

(only on models M 626 EC and M 636 EC)

- Press the  touchpad and use the +/- touchpads to set the cooking time you require (5 seconds to 99 minutes).
- Press the  touchpad.  
The symbol  for the Microwave mode flashes in the display and P 9 appears.
- Use the +/- touchpads to select the power setting you require.  
The  symbol flashes and the selected power setting appears.
- Now press the  touchpad.  
The set time as well as the pre-set temperature appear in the display area. The  and  symbols flash.
- Use the +/- to select the temperature you require (50 °C – 250 °C).
- Press the START touchpad.  
The set time appears in the display area and begins to count down in one second steps.  
A red dot also appears in the display area (heat warning indicator).  
An audible tone sounds after the cooking time has elapsed.







Press the  touchpad if you wish to call up the power setting while the appliance is in operation.

## Recommendation

The turntable should always be switched on when the Microwave with Fan Heat mode is in use.

## Combination mode - Microwave with Fan Grilling

(only with models M 626 EC and M 636 EC)

- Press the  touchpad and use the +/- touchpads to set the cooking time you require (5 seconds to 99 minutes).
- Press the  touchpad.  
The  symbol for the Microwave mode flashes in the display area and P 9 appears.
- Use the +/- to select the power setting you require.  
The  flashes and the selected power setting appears.
- Now press the  touchpad.  
The set time as well as the pre-set temperature appear in the display area. The  and  symbols flash.
- Use the +/- touchpads to select the temperature you require (50 °C – 200 °C).
- Press the START touchpad.  
The set time appears in the display area and begins to count down in one second steps.  
A red dot also lights up in the display area (heat warning indicator).  
An audible tone sounds after the cooking time has elapsed.





Press the  touchpad if you wish to call up the power setting while the appliance is in operation.

# Operation



## Automatic defrosting

There is a choice of 4 Automatic defrosting programmes.

Programme	Food type
d 1	Poultry
d 2	Meat
d 3	Fish
d 4	Light textured bakes, e.g cream gateaux

- Press the  touchpad.  
The symbol  flashes in the display area and d 1 appears.
- Press the  touchpad enough times to select the programme you require.
- With the +/- touchpads enter the weight of the food (50 g – 4000 g).  
The symbol  flashes in the display area, and the food weight entered appears.

The defrosting time is calculated automatically by the appliance.



- Press the START button.  
The defrosting time which has been calculated appears in the display area and begins to count down in one second steps. The symbols  and  also appear.  
An audible tone sounds at the end of the defrosting time.

The fault message "E 15" appears in the display if the oven interior is still warm from previous use. Wait until it has cooled down.

## Automatic cooking

There is a choice of 8 Automatic cooking programmes.

Programme	Food type
C 1	boiling potatoes
C 2	Boiling vegetables
C 3	Poaching fish
C 4	Frozen vegetables
C 5	Heating liquids
C 6	Reheating conserves
C 7	Chilled plated meals
C 8	Frozen plated meals







- Press the  touchpad.  
The weight symbol flashes in the display area, and C 1 appears.
- Press the  touchpad enough times to select the programme you require.
- With the +/- touchpads enter the weight of the food.  
The weight symbol flashes in the display area, and the food weight entered appears.

The cooking time is calculated automatically by the appliance.



- Press the START button.  
The cooking time which has been calculated appears in the display area and begins to count down in one second steps. The symbols  and the weight symbol also appear.  
An audible tone sounds at the end of the cooking time.

## Combining Automatic programmes

The two Automatic Programmes can be set to run so that defrosting runs followed by cooking.

- Press the  touchpad.  
The symbol  flashes in the display area and d 1 appears.
- Press the  touchpad enough times to select the programme you require.
- With the +/- touchpads enter the weight of the food (50 g – 4000 g).  
The symbol  flashes in the display area, and the food weight entered appears.
- Now press touchpad .  
The weight symbol flashes in the display area, and C 1 appears.
- Press the  touchpad enough times to select the programme you require.
- With the +/- touchpads enter the weight of the food.  
The weight symbol flashes in the display area, and the food weight entered appears.

The defrosting time and cooking time are calculated automatically by the appliance.

- Press the START button.  
The defrosting time which has been calculated appears in the display area and begins to count down in one second steps. The symbols  and  also appear.

The automatic cooking programme will switch on automatically once the defrosting time has elapsed.

The cooking time which has been calculated appears in the display area and begins to count down in one second steps.

 and the weight symbol also appear.

An audible tone sounds once the cooking time has elapsed.

# Operation

---

## Short step system

Touchpads 1, 2, and 3 allow you to store in memory programmes which you frequently use.

There are three memory stores where frequently used programmes can be recorded.

You can store all the operating functions, e.g. grilling, combination functions, and automatic programmes.

You can also store the command to switch the turntable function on or off.

Each memory store can be used again with a different programme.

- Proceed as for setting the operating mode.
- Do not however press the START button at the end, instead select one of the three programmes 1, 2, or 3 and store the setting.  
The code number of the stored programme will appear in the display.
- Finally press touchpad C to confirm the setting.  
The time of day appears in the display area.

## Calling up the "Short step system"

- Press the relevant storage touchpad, 1,2 or 3.  
The stored settings for the operating function appear in the display area. The symbol for the function flashes and the number of the programme store appears.

- Press the START button.  
In the display area the codes for the operating functions appear and the time counts down in one second steps. An audible tone sounds at the end.

If you press the START button immediately after selecting the programme 1, 2, or 3, this will avoid the whole sequence showing in the display area.

Storing a new programme will automatically delete any previously stored programme.

In the event of a power cut the stored programmes will be deleted, and will need to be re-entered. Make a note of the programme sequences, so that they are available for use when you need them.

## Delaying start

### (only on models M 626 EC and M 636 EC)

The length of time and also the end of a process can be pre-programmed up to 24 hours beforehand.

- Proceed as before to set the operating mode.
- After setting the mode do not however press the START touchpad but instead press the →| touchpad. 0:00 and →| the symbol for delaying start flash in the display area.
- Now enter the time at which you wish the process to end. Use the +/- touchpads to enter the hours. Press the ⊕ touchpad and then finally use the +/- to set the minutes.
- Press the START touchpad. The current time of day and the →| symbol appear in the display area.

The appliance will then switch on and off at the required time.

If you are using the delaying start function with the microwave mode, the food must have already been placed in the cooking compartment.

# Practical tips

---

## Reheating

Select the following microwave power settings to reheat food:

Drinks . . . . .	8
Food . . . . .	6
Food for babies * . . . . .	4

(See table on page 12 for ovens with maximum microwave output of less than 900/1000 watts.)

\* We do not recommend heating or re-heating foods or drinks for babies or young children in the microwave oven. Any decision to do this is the responsibility of the user, and should only be done with the utmost care. Pasteurised or sterilised cooked food should be gently heated on level 4, (5 or 6) according to model, see table on page 12, and tasted so that it is not too hot for a baby's palate before serving. Other food or drink when reheated should be heated to a high temperature and allowed to cool to a suitable heat for eating. For made-up milk follow the maker's instructions.

Always use a lid or cover for re-heating food, except when a drier finish is needed, e.g. breaded poultry/meat.

Always remove the lid from jars, especially jars of baby food.  
Remove the rubber teat and seal top before warming baby bottles. When re-heating liquids place the boiling rod supplied with the machine into the cup or glass.  
Never reheat hard boiled eggs in a microwave oven, even without the shell. The eggs can burst.

The time required depends largely on the nature and initial temperature of the food and the amount to be cooked. Food taken straight from the fridge or freezer requires for example longer to reheat than food stored at room temperature.

Always ensure that the food is thoroughly heated.

If in any doubt that a sufficiently high temperature has been reached, continue re-heating for a little longer.

Stir or turn food from time to time during cooking. Stir the food from the outside towards the middle, as food heats more quickly from the outside.



## After re-heating

Be careful when removing a dish from the oven. It may be hot.

Although heat is not normally produced in the container itself by the micro-waves, (apart from stoneware and similar dishes), heat transfer from the food to the container may be considerable, making the container itself hot.

Allow food to stand for a few minutes once a programme has ended to allow heat to be distributed evenly.

After re-heating food, especially food for babies and small children, stir the food or shake the container and check that the temperature does not pose any danger. Double check after it has been left to stand.

## Cooking

Place the food in a covered microwave-safe dish.

When cooking fresh **vegetables, fish, meat, poultry** first select power setting 8 or for M 616 EG setting 9, and then select power setting 5 or for M 616 EG setting 6 to continue cooking.

Add a little water to vegetables which have been kept stored. Vegetable cooking times depend on the texture of the vegetable. Fresh vegetables contain water and usually cook more quickly. Stir and turn food at least once during cooking.

Ensure that perishable types of food, such as meat and fish, are cooked for an appropriate length of time.

For dishes such as **rice or semolina pudding** first select power setting 8 or for M 616 EG setting 9 and then turn down to power setting 2 to complete cooking.

For **food with skin or peel**, such as tomatoes, some types of sausage, jacket potatoes and aubergines, should be pricked or the skin cut several times before cooking to prevent food from bursting.

Boiling eggs in the microwave oven is not possible without a special egg-boiling device, available from specialist shops.

Otherwise the eggs will burst. Eggs can only be cooked in a microwave oven out of their shells in a glass dish. The yolk must be pricked several times first with a sharp object.

# Practical tips

---

## Defrosting

Remove the frozen food from its packaging and place in a covered microwave-safe container, to defrost without a lid. Turn, stir or separate the food about half-way through the programme.

To defrost **delicate foods**, e.g. cream, butter, gateaux and cheese, select the microwave setting 1. However to achieve an even result remove from the oven and allow to finish defrosting at room temperature.

To defrost **meat** unpack the frozen meat and lay it on an upturned plate in a glass or china container so that the meat juice can run out, but be collected. Turn half way through defrosting.

For defrosting **basic food** stuffs such as bread, cakes or fruit microwave power setting 2 is recommended.

## After defrosting

Allow the food to stand at room temperature for approximately the same amount of time spent for defrosting to enable the heat to spread evenly throughout the food.

## Defrosting and reheating or cooking

Deep-frozen pre-cooked food can be defrosted and immediately reheated or cooked, using the combination of the two automatic programmes, Auto defrost and Auto cook.

Remove the food from its packaging and place in a covered microwave-safe dish for defrosting and re-heating or cooking. Exception: Minced meat should be left uncovered while cooking. Soups, stew and vegetables should be stirred several times during the process. Separate slices of meat half-way through the programme. Turn pieces of meat and fish at the half-way stage.

Deep-frozen pre-cooked meals in cardboard trays which, according to manufacturer's instructions are suitable for use in a conventional oven, are microwave-safe.

## After defrosting followed by re-heating or cooking.

Allow the food to stand at room temperature long enough to enable the heat to spread evenly throughout the food.

## Examples

### Melting margarine, butter

Melt 100 g at setting 5 uncovered, for approx 1-1<sup>1</sup>/<sub>2</sub> minutes.

### Melting chocolate

Break 100 g into pieces, melt at setting 5 uncovered, for approx. 2 minutes.

### Dissolving gelatine

Melt at setting 5 uncovered, for approx. <sup>1</sup>/<sub>2</sub>-1 minutes, stirring occasionally, (N.B. follow the instructions on the packet if these differ and for the amount of water).

### Preparing flan topping/jelly glaze

Gently heat 1 sachet + <sup>1</sup>/<sub>4</sub> l liquid at setting 5 uncovered, for approx. 4-5 minutes, stirring occasionally.

### Proving dough

(500 g flour) leave covered to rise for approx. 8-10 minutes at setting 1.

### Skimming tomatoes

Score 3 tomatoes crosswise at the bottom, drop into water and heat at setting 5 for approx. 2 minutes. The skin can now be peeled away easily. Take care, the tomatoes may be very hot.

The examples below are for an oven with a maximum microwave power output of 900/1000 watts.

For models with a different power output scale, adjust according to the table on page 12. E.g. for a 750 watt model use setting 6 instead of setting 5.

### Bottling

Bottling should only be undertaken by an experienced cook who has received proper training in this method of preserving fruit and vegetables in an oven or microwave oven, and understands the implications of the chemical reactions involved.

# Cleaning and care

## Microwave oven

Disconnect the microwave oven from the power supply before cleaning.

### Oven housing and interior

The housing and interior can be cleaned using a damp cloth with a solution of washing up liquid or a mild detergent and water. Wipe dry with a soft cloth.

Avoid too much water as this could penetrate the openings of the oven interior.

Do not use a scouring agent which could scratch.

The stainless steel surfaces can be cleaned with a non-abrasive cleaner for stainless steel.

To neutralise odours in the microwave put a cup of water with some lemon juice in the oven and simmer for a few minutes.

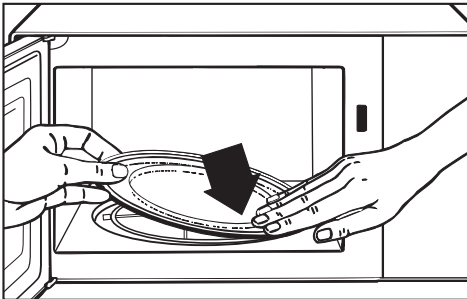

- The **turntable** can be removed for cleaning.

- Always keep the **roller ring** underneath it clean as well as the oven floor. Otherwise the ring might not run smoothly.

Do not turn the carrier manually, as this could damage the drive motor.

### Door interior

Always keep the door interior clean. Do not use any scouring agent. Check the door and door seal at regular intervals for any sign of damage. If any damage is noticed, the oven should not be used again in microwave mode until the fault has been rectified by a service engineer trained by Miele.

### Air vents

Do not let water or any other object find its way into the ventilation outlets.

## Accessories (depending on model)

### Boiling rod

The boiling rod can be washed in a dishwasher.

### Side runners

The side runners can be removed to clean the oven interior walls.

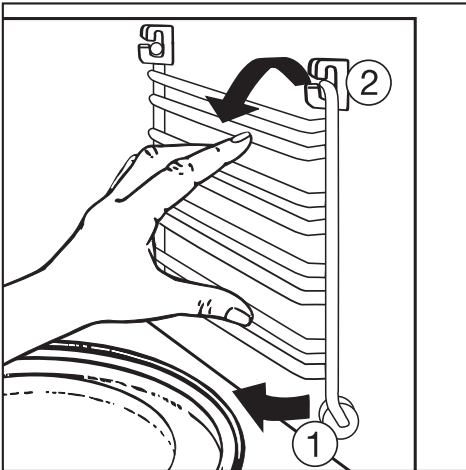

- Take the runners out at the bottom from the side wall, pull upwards and un-hook.
- Reassemble in reverse order.

### Rack, baking tray and runners

Wash and dry after each use. Remove stubborn soils

- from stainless steel:  
with a stainless steel cleaner.
- from enamel:  
Soak to loosen the soil and then clean with a soft brush or a sponge.

### Glass tray

The glass tray can be washed in a solution of hot water and washing up liquid or in the dishwasher.

Do not use scouring agents, as these would scratch the surface.

### Ceramic anti-splash roof liner

Take out and clean with washing up liquid and water after each use.

# Problem solving guide

---

Repairs to electrical appliances should only be carried out by suitably qualified and competent service technicians trained by Miele. Improper repairs may pose a serious risk to the user.

The following minor malfunctions however can usually be resolved without calling the Service Department:

## What to do if . . .

### . . . a process cannot be started.

Check whether,

- the appliance door is closed properly.
- a time has been entered.
- the appliance is plugged in to the mains supply.
- the mains fuse has blown (call a qualified electrician or the Service department, see "After Sales Service").

### . . . food is not adequately defrosted, heated or cooked at the end of the selected process time.

- check whether the correct power setting was selected for the time set.

The lower the power setting the longer the time required.

- check whether the process has been interrupted and not restarted.

### . . . the turntable does not turn smoothly.

- Check whether the path described by the ring on the base of the oven interior under the turntable is clean, and if not remove any soiling.

### . . . strange noises are heard when the microwave oven is being used.

Check whether,

- the food is covered with aluminium foil.  
If it is remove it.
- Sparks are being created by the use of crockery with a metallic finish. See notes on types of containers.

### . . . food cools down too quickly.

In the microwave oven, food begins to cook from the outside first, the inside of the food relying on the slower conduction of heat.

If food is cooked at a high power level it is possible that the heat may not have reached the centre of the food. During standing time heat is transferred to the centre of the food. Food may be warm in the middle but cool on the edge.

When reheating food with different densities, such as plated meals it is sensible to start with a low power level and lengthen the time required.

### **. . . the microwave switches itself off during a cooking, reheating or defrosting process.**

There may be insufficient air circulation.

Check whether:

- the air inlet is blocked.
- Any object is blocking the ventilation outlets.
- whether anything is blocking the gap between the base of the unit and the worktop surface.

Remove any objects if necessary. The appliance switches off automatically in the case of overheating. Cooking can be recontinued after a cooling-down period.

If the microwave oven switches itself off repeatedly, please call the Service Department.

### **. . . an E appears in the display**

This appears with an incorrect entry.

- Press the C touchpad once. Afterwards, it is possible to enter the settings again.

### **. . . an E 15 appears in the display**

The oven interior is too hot.

- Let the appliance cool down with the door open for 15 – 20 minutes. Afterwards, press the C touchpad and enter the settings again.

If it is not possible to remedy a fault by following the instructions given above, on no account open the appliance casing.

These microwave ovens should only be repaired by suitably qualified technicians trained by Miele.

## After sales service

---

In the event of any faults which you cannot easily remedy, please contact

- your Miele dealer
- the nearest Miele Service Department.

See address on the back page.

When contacting the service department please quote the Model and Serial number of your appliance, given on the data plate which is located externally, on the rear wall of the appliance.



# Installation and electrical connection

All electrical work should be carried out by a competent person, in accordance with national and local safety regulations.

The microwave oven is supplied with a mains cable and plug for connection to a single phase 230-240 V, 50 Hz a. c. supply. The voltage, rated load and fuse rating are given on the data plate. Please ensure that these match the household mains supply.

If the cable is damaged it must be replaced by a special cable which must be fitted by a competent person trained by the manufacturer. Please consult the Customer Service dept.

For extra safety it is advisable to install a residual current device (RCD) with a trip current of 30 mA.

## GB / IRL

Connection should be made via a fused connection unit or a fused plug and a suitable switched socket, (rated load under 3000 W), or via suitable isolator (rated load over 3000 W), which is easily accessible.

## AUS / NZ

The plug rating is 10 A.

This appliance is electrically suppressed according to AS / NZS 4052 : 1992

## Important

The wires in the mains lead are coloured in accordance with the following code:

Green/yellow = earth

Blue = neutral

Brown = live

As the colours of the wires in the mains lead of this appliance may not correspond with the coloured markings identifying the terminals in your plug, proceed as follows:

The wire which is coloured green and yellow must be connected to the terminal in the plug which is marked with the letter E or by the earth symbol  $\perp$  or coloured green or green and yellow.

The wire which is coloured blue must be connected to the terminal which is marked with the letter N or coloured black.

The wire which is coloured brown must be connected to the terminal which is marked with the letter L (GB / IRL) or A (AUS / NZ) or coloured red.

**WARNING**  
THIS APPLIANCE MUST  
BE EARTHED

# Installation and electrical connection

## Non rewirable plugs BS 1363 (GB / IRL)

If this machine or appliance is fitted with a non-rewirable plug, the following information applies:

If the socket outlets are not suitable for the plug supplied with this product, it must be cut off and an appropriate plug fitted.

The plug cut from the flexible cord should be disposed of and on no account be inserted into a socket elsewhere in the house (electric shock hazard).

The fuse cover must be refitted when changing the fuse, and if the fuse cover is lost, the plug must not be used until a suitable replacement is obtained. The colour of the correct replacement cover is that of the coloured insert in the base of the plug, or the colour that is embossed in words in the base of the plug (as applicable to the design of plug fitted).

The correct fuse rating of the replacement fuses that are ASTA approved to BS 1362 should be fitted. Replacement fuse covers may be purchased from your local electrical suppliers, or Miele Service Agent.

Do not position the appliance too close to adjacent furniture. A space of 5 cm (M 636 EG: 10 cm) is required all round the appliance for ventilation.

The microwave oven should be positioned or built-in at least 85 cm above the ground (EN 60335) except for M 636 EC.

When installing a microwave oven care should also be taken that the air can be freely discharged from under and behind the appliance. Do not place any objects on the ventilation outlets or block the space between the appliance floor and the surface upon which it is placed.

The microwave oven can be:

- placed on a worktop
- built under a wall unit in conjunction with a building under frame (M 616 EG) only.
- built into a wall unit (M 616 EG only) or into a tall unit.  
M 636 EC on the other hand can be built under a worktop, with the exception of the stainless steel version.

Use the appropriate building frame and follow the fitting instructions.

The special fitting kit with instructions is available from the Miele specialist dealer or the Domestic Sales Department.

## M 616 EG

Voltage . . . . . 230-240 V, 50 Hz  
Rated load . . . . . see data plate  
Power settings . . . . . 9 (80/150/200/300/  
. . . . . 400/450/550/600/750 W)  
Fuse/plug rating . . . . . see data plate  
Timer switch . . . . . up to 99 minutes

### Freestanding appliance:

Dimensions (H x W x D) in mm:  
Housing . . . . . 296 x 440 x 316  
Net weight . . . . . 15 kg

## M 626 EG

Voltage . . . . . 230-240 V, 50 Hz  
Rated load . . . . . see data plate  
Power settings . . . . . 9 (80/150/250/350/  
. . . . . 450/500/600/700/850 W)  
Fuse/plug rating . . . . . see data plate  
Timer switch . . . . . up to 99 minutes

### Freestanding appliance:

Dimensions (H x W x D) in mm:  
Housing . . . . . 296 x 496 x 384  
Net weight . . . . . 17 kg

## M 626 EC

Voltage . . . . . 230-240 V, 50 Hz  
Rated load . . . . . see data plate  
Power settings . . . . . 9 (80/150/250/350/  
. . . . . 450/500/600/700/850 W)  
Fuse/plug rating . . . . . see data plate  
Timer switch . . . . . up to 99 minutes

### Freestanding appliance:

Dimensions (H x W x D) in mm:  
Housing . . . . . 296 x 496 x 460  
Net weight . . . . . 25 kg

## M 636 EG

Voltage . . . . . 230-240 V, 50 Hz  
Rated load . . . . . see data plate  
Power settings . . . . . 9 (100/200/300/400/  
. . . . . 500/600/700/800/900 W)  
Fuse/plug rating . . . . . see data plate  
Timer switch . . . . . up to 99 minutes

### Freestanding appliance:

Dimensions (H x W x D) in mm:  
Housing . . . . . 348 x 555 x 429  
Net weight . . . . . 22kg

## M 636 EC

Voltage . . . . . 230-240 V, 50 Hz  
Rated load . . . . . see data plate  
Power settings . . . . . 9 (80/150/250/350/  
. . . . . 450/500/600/700/850 W)  
Fuse/plug rating . . . . . see data plate  
Timer switch . . . . . up to 99 minutes

### Freestanding appliance:

Dimensions (H x W x D) in mm:  
Housing . . . . . 348 x 555 x 484  
Net weight . . . . . 26kg

# Miele

## **Australia:**

Miele Australia Pty. Ltd., A.C.N. 005635398

1 Gilbert Park Drive, Knoxfield, VIC 3180

Telephone: (03) 9764 7100, Fax: (03) 9764 7129

Miele Australia Pty. Ltd., 3 Skyline Place, Frenchs Forest, NSW 2086

Telephone: (02) 8977 4200, Fax: (02) 8977 4219

Miele Australia Pty. Ltd., 4 Wandoo Street, Fortitude Valley, QLD 4006

Telephone: (07) 3852 2533, Fax: (07) 3852 2920

Miele Australia Pty. Ltd., 209 Richmond Road, Richmond, SA 5033

Telephone: (08) 8351 8500, Fax: (08) 8354 1717

## **Distributor Western Australia:**

G.B.I. Sales Pty. Ltd., 52 Wickham Street,

P.O. Box 6300, East Perth, WA 6004

Telephone: (08) 9221 1455, Fax: (08) 9221 3475

## **Distributor New Zealand:**

Steeffort Engineering Company. Ltd.

500 Rangitikei Street, Palmerston North, Priv. Bag 11045, NZ

Telephone: (06) 357 1099, Fax: (06) 356 1507

Steeffort Engineering Company Ltd., Unit L, 10-20 Sylvia Park Road,  
Mt. Wellington, Auckland, NZ

Telephone: (09) 573 1269, Fax: (09) 573 1268

## **United Kingdom:**

Miele Co. Ltd.

Fairacres, Marcham Road, Abingdon, Oxon, OX14 1TW

tel. Abingdon (01235) 554455 - fax (01235) 554477

Service Office, tel. Abingdon (01235) 554466

## **Ireland:**

Miele Ireland Ltd.

Wilton House, Naas Road, Dublin 22

Tel. (01) 4504024, Fax (01) 4504037

## **South Africa:**

Miele (Pty.) Ltd.

304 Tungsten Road, Strydom Park 2194

P.O.Box 1654, Randburg 2125

Tel. (011) 793-7452, Telefax (011) 793-7447

E-mail: mieleza@iafrica.com

## Free Manuals Download Website

<http://myh66.com>

<http://usermanuals.us>

<http://www.somanuals.com>

<http://www.4manuals.cc>

<http://www.manual-lib.com>

<http://www.404manual.com>

<http://www.luxmanual.com>

<http://aubethermostatmanual.com>

Golf course search by state

<http://golfingnear.com>

Email search by domain

<http://emailbydomain.com>

Auto manuals search

<http://auto.somanuals.com>

TV manuals search

<http://tv.somanuals.com>