

Miele

Operating and Installation instructions

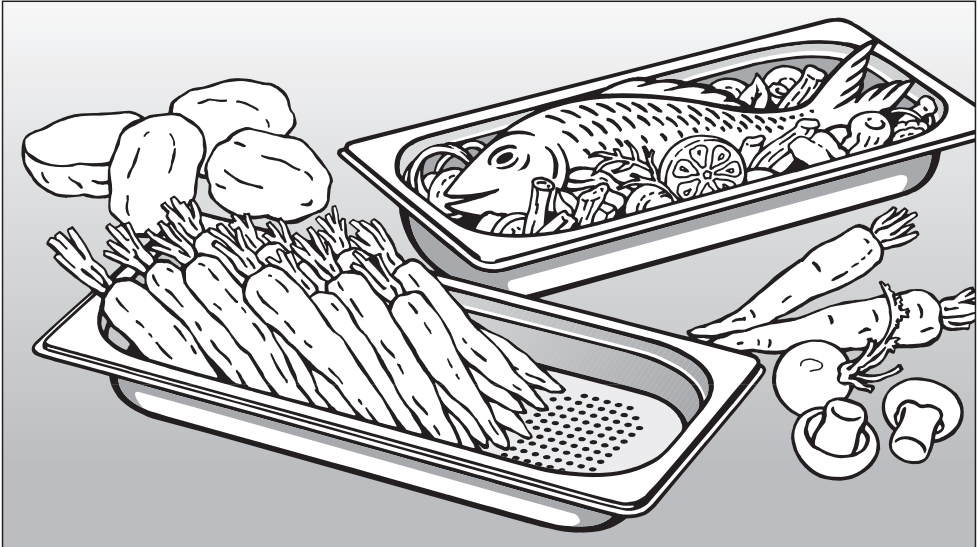

Steam oven

DG 5070

DG 5080

DG 5088

To avoid the risk of accidents or damage to the appliance it is **essential** to read these instructions before it is installed and used for the first time.

en - GB

M.-Nr. 07 207 620

Contents

Warning and Safety instructions	5
Caring for the environment	10
Guide to the appliance	11
Front view	11
Accessories supplied	12
Control panel	14
Description of the functions	15
Sensors	15
Display	16
Condensate tray	17
Water container	17
Temperature	17
Cooking duration (time)	17
Noises	17
Heating-up phase	18
Cooking phase	18
Steam reduction	18
Keeping warm	18
Before using for the first time	19
Setting up the appliance for using for the first time	19
Cleaning for the first time	21
Setting the correct boiling point for water	22
Functions	23
Brief operating instructions	24
Preparing the appliance for use	24
Selecting a function	24
Setting the temperature	24
Setting a cooking duration	24
At the end of the duration	25
After use	25

Operation	26
During operation	26
Interrupting operation	26
Changing a programme	26
Saving settings	27
Insufficient water	27
Automatic	28
Menu cooking (cooking whole meals)	29
User programmes	30
Additional functions	32
Start time / Finish	32
Pre-heat	32
Minute minder time	34
System lock	35
Settings	36
Language 	36
Time of day	36
Start	37
Steam reduction	37
Keeping warm	37
Pre-heat	37
Recommended temperatures	37
Water hardness	38
Display	38
Volume	38
Safety	38
Units	39
Showroom programme	39
Factory default	39
Cleaning and care	40
General notes	40
Appliance front	41
Oven interior	42

Contents

Condensate tray, rack and cooking containers.	42
Automatic door release	42
Water container	43
Coupling seal	44
Descaling.	45
Removing and refitting the door	47
Problem solving guide	48
Optional accessories	51
Cooking containers	51
Cleaning and care products	53
Safety instructions for installation	55
Appliance and building-in dimensions	56
Installation in a tall unit.	56
Installation in a base unit.	57
Installation in a tall unit in combination with an oven.	58
Installing the appliance	59
Electrical connection	60
After sales service, data plate	62

Warning and Safety instructions

This steam oven conforms to current safety requirements. Inappropriate use can, however, lead to personal injury and damage to property.

To avoid the risk of accidents and damage to the steam oven, please read these instructions carefully before installation and before using it for the first time. They contain important notes on the installation, safety, operation and care of the appliance.

Keep these instructions in a safe place and ensure that new users are familiar with the content. Pass them on to any future owner.

Correct application

► This steam oven is intended for domestic use only, and must only be used as described in these instructions. Any other usage is at the owner's risk and could be dangerous. The manufacturer cannot be held liable for damage resulting from incorrect or improper use or operation.

► This steam oven is not intended for use by persons (including children) with reduced physical, sensory or mental capabilities, or lack of experience and knowledge, unless they are supervised while using it or have been given instruction concerning its use by a person responsible for their safety.

Warning and Safety instructions

Safety with children

- ▶ Activate the safety lock to ensure that children cannot switch on the appliance inadvertently.
- ▶ Keep children away from the steam oven at all times. It is not a toy! To avoid the risk of injury do not allow them to play with it or to play with the controls. Supervise children whilst you are using it.
- ▶ Older children may use the appliance only when its operation has been clearly explained to them and they are able to use it safely, recognising the dangers of incorrect use.
- ▶ Make sure that children do not attempt to open the door when the appliance is in operation. To safeguard against burning, keep children well away from the appliance at all times.
- ▶ Do not allow children to lean against the open oven door, nor to sit on it or swing on it.
- ▶ Packaging, e.g. cling film, polystyrene and plastic wrappings, must be kept out of the reach of babies and young children. Danger of suffocation. Dispose of or recycle all packaging safely as soon as possible.

Technical safety

- ▶ Before installation, check the steam oven for visible signs of damage. Do not install and use a damaged appliance. A damaged appliance is dangerous.
- ▶ Before connecting the appliance to the mains supply, ensure that the connection data on the data plate (voltage and connected load) match the mains supply. Consult a qualified electrician if in any doubt.
- ▶ The electrical safety of this appliance can only be guaranteed when continuity is complete between it and an effective earthing system which complies with current local and national safety regulations. It is most important that this basic safety requirement is present and regularly tested, and where there is any doubt, the household wiring system should be inspected by a qualified electrician. The manufacturer cannot be held liable for the consequences of an inadequate earthing system (e.g. electric shock).

Warning and Safety instructions

► This appliance is supplied with a moulded plug ready for connection to a switched socket. If you wish to connect it to a double-pole fused spur connection unit, or to an isolator switch or if the appliance is supplied without a plug, it must be installed by a suitably qualified and competent person in strict accordance with current local and national safety regulations. The manufacturer cannot be held liable for damage caused by incorrect installation or connection.

► For safety reasons, this appliance may only be used when it has been built in. This is necessary to ensure that all electrical components are shielded.

► Never open the casing of the appliance.

Tampering with electrical connections or components and mechanical parts is highly dangerous to the user and can cause operational faults.

► Installation, maintenance and repairs may only be carried out by a suitably qualified and competent person in strict accordance with current national and local safety regulations. Repairs and other work by unqualified persons could be dangerous. The manufacturer cannot be held liable for unauthorised work.

► If the connection cable is damaged, it must be replaced with a special connection cable of type H 05 V V-F (pvc insulated), available from the Miele Spare Parts Department.

► Faulty components must only be replaced by genuine Miele original spare parts. The manufacturer can only guarantee the safety of the appliance when Miele replacement parts are used.

► During installation, maintenance and repair work, the appliance must be disconnected from the mains electricity supply. It is only completely isolated from the electricity supply when:

- the mains fuse is disconnected,
- the screw-out fuse is removed (in countries where this is applicable),
- it is switched off at the wall socket and the plug is withdrawn from the socket, or it is switched off at the isolator.

► While the appliance is under guarantee, repairs should only be undertaken by a service technician authorised by the manufacturer. Otherwise the guarantee is invalidated.

► Do not connect the steam oven to the mains electricity supply by a multi-socket unit or an extension lead. These do not guarantee the required safety of the appliance (e.g. danger of overheating).

► In countries where there are areas which may be subject to infestation by cockroaches or other vermin, pay particular attention to keeping the appliance and its surroundings in a clean condition at all times. Any damage caused by cockroaches or other vermin will not be covered by the guarantee.

Warning and Safety instructions

Correct use

► For added protection, it is advisable to use heat-resistant pot holders or gloves when using the appliance. Do not let them get damp or wet, as this causes heat to transfer through the material more quickly with the risk of scalding or burning yourself.

► When putting cooking containers or the condensate tray into the oven or taking them out, take care not to spill the contents. Avoid contact with hot steam, and do not touch the hot oven interior walls. Danger of burning and scalding.

► If using plastic cooking containers, make sure that they are heat- and steam-resistant to 100 °C. Otherwise they may melt, distort or break.

► Do not use the appliance to heat up food in sealed jars and tins. Pressure will build up inside them and they can explode causing damage to the appliance, as well as the risk of injury and scalding.

► Always ensure that food is sufficiently cooked or reheated. Some foods may contain micro-organisms which are only destroyed by thorough cooking at a sufficiently high temperature for long enough. Therefore, when cooking or reheating food such as poultry, it is particularly important that the food is completely cooked through. If in doubt, select a longer cooking or reheating time.

► Do not leave cooked food in the oven and do not use any cooking containers which are susceptible to corrosion as this could lead to corrosion in the appliance.

► The appliance is designed in such a way that there will always be a little residual water left in the water container after use. If there is no residual water, there is something wrong. Call the Service Department.

► Do not immerse the water container in water, or clean it in a dishwasher. Connecting the water container into the appliance when wet could cause an electric shock.

► For reasons of hygiene and to prevent the build-up of moisture in the appliance, the water container should be emptied after each use.

► Take care not to tip the water container when taking it out of the appliance. Hot water can scald.

Warning and Safety instructions

▶ When using an electric socket near the steam oven, care should be taken that the cable of the appliance cannot get trapped by the steam oven door. The insulation on the cable could become damaged, giving rise to an electric shock hazard.

▶ Do not place heavy objects on the open door. The door can support a maximum weight of 8 kg.

▶ If the appliance is not going to be used for a longer period of time, e.g. whilst on holiday, it should be thoroughly cleaned and dried beforehand to prevent the build-up of odours etc. Make sure that the water container is empty. Leave the door open.

The manufacturer cannot be held liable for damage caused by non-compliance with these Warning and Safety instructions.

Caring for the environment

Disposal of the packing material

The transport and protective packing has been selected from materials which are environmentally friendly for disposal, and can normally be recycled.

Ensure that any plastic wrappings, bags, etc. are disposed of safely and kept out of the reach of babies and young children. Danger of suffocation.

Rather than just throwing these materials away, please ensure they are recycled.

Disposing of your old appliance

Electrical and electronic appliances often contain materials which, if handled or disposed of incorrectly they could be potentially hazardous to human health and to the environment. They are, however, essential for the correct functioning of your appliance. Please do not therefore dispose of it with your household waste.

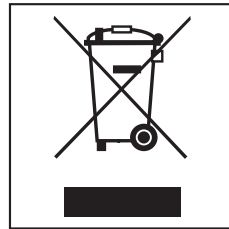

Please dispose of it at your local community waste collection/recycling centre or contact your dealer for advice. Ensure that it presents no danger to children while being stored for disposal.

Front view

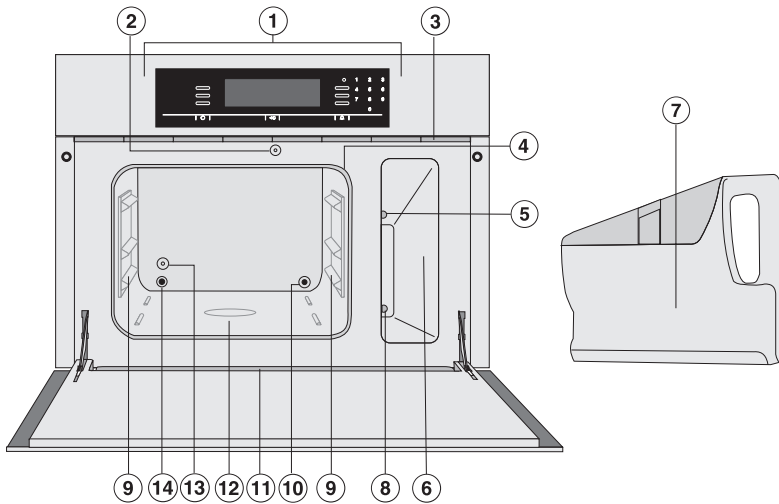

- ① Control panel
- ② Automatic door release for reducing steam
- ③ Ventilation outlet
- ④ Door seal
- ⑤ Steam channel
- ⑥ Compartment for water container
- ⑦ Water container (with insert)
- ⑧ Contact point for water container
- ⑨ Shelf levels
- ⑩ Steam inlet
- ⑪ Drip channel in the oven
- ⑫ Floor heater
- ⑬ Temperature sensor
- ⑭ Outlet for air from oven interior

Guide to the appliance

Accessories supplied

The accessories supplied with your appliance as well as a range of optional ones are available to order from Miele (see "Optional accessories").

Condensate tray

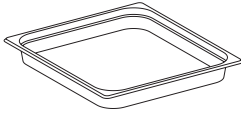

To catch excess moisture
Gastronorm size GN 2/3
325x350x40 mm (WxDxH)

DGGL 8

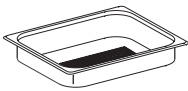

1 perforated cooking container
gross capacity 2.0 litres / useable capacity 1.7 litres
Gastronorm size GN 1/2
325x265x40 mm (WxDxH)

DGGL 1

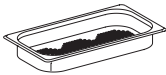

2 perforated cooking containers
gross capacity 1.5 litres / useable capacity 0.9 litres
Gastronorm size GN 1/3
325x175x40 mm (WxDxH)

Rack

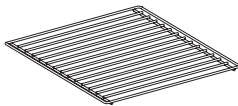

For placing your own cooking containers on

Silicone grease



For lubricating the coupling seal on the water container

Descaling tablets

For descaling the water container.

Miele steam oven cookbook

A selection of the best recipes from the Miele test kitchen.

Guide to the appliance

Control panel

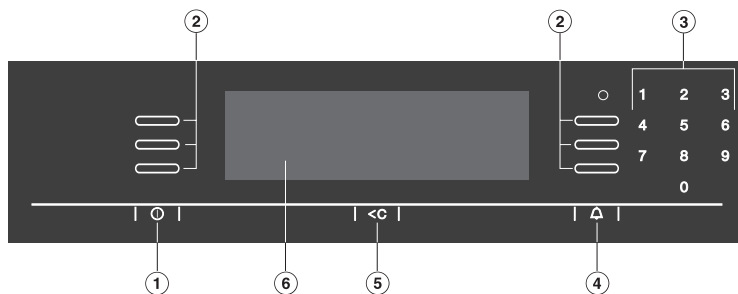





- ① On/Off sensor
- ② Selector sensors
- ③ Numerical keypad
- ④ Minute minder
- ⑤ "Clear"
- ⑥ Display

Description of the functions

Sensors







Lightly touch the sensors to operate the appliance. An audible tone will sound each time a sensor is touched. You can adjust the volume in the Settings menu (see "Settings / Volume").

Sensor	Function
	For switching the appliance on and off.
	For scrolling through the menus. For selecting the option or value shown in the display next to the sensor. (The sensors light up when it is possible to make a selection).
0, 1, 2, ...	For entering temperatures. For entering times. (The sensors light up when an entry is possible or necessary).
	For reverting to the previous menu. For deleting the previous entry.
	For activating and deactivating the minute minder. For selecting the minute minder time.

Description of the functions

Display

The following symbols will appear in the display in addition to the text:

Symbol	Meaning
•	Appears beside an option or a prompt, e.g. "Continue" and is allocated to a sensor. You select the option you want by pressing the sensor beside the dot.
	A maximum of 3 options can be shown in the display. These arrows indicate if more than three options are available.
- - - -	A dotted line will appear under the last option available. The beginning of the list will appear under the dotted line.
+ / -	For entering temperatures. For entering times. (These only appear when an entry is possible or necessary).
✓	A tick will appear beside the option which is currently selected.
	Water level in the water container: full half full nearly empty.
	Start time
	Programme finished
	System lock changed to "Permitted": Off = operation possible
	On = operation not possible.

Condensate tray

When you are using perforated containers, place the condensate tray on the floor of the appliance to collect any drops of liquid and allow them to be removed easily.

Water container

The maximum water level is 1.2 litres, the minimum 0.75 litres. The water level markers are located inside and outside the container. On no account exceed the upper or maximum level marker.

The maximum quantity of 1.2 litres of water is sufficient to run a cooking programme at 100 °C for approx. 2 hours, and the minimum quantity of 0.75 litres of water is sufficient to run a cooking programme at 100 °C for approx. 30 minutes, providing the door is not opened.

The water level in the water container is represented by a symbol in the display.

Temperature

Some of the functions are allocated with a recommended temperature. You can alter the recommended temperature for an individual cooking process or permanently (see "Settings / Recommended temperature").

Cooking duration (time)

A duration of between 1 minute (-:-1) and 10 hours (10:00) can be set.

If you are using the numerical keypad, you must enter the duration in hours and minutes if it is more than 59 minutes.

Example: Duration of 80 minutes = 1:20.

Noises

You can hear the noise of the fan when the appliance is operating.

Noises similar to those of a kettle can be heard when steam is being generated.

Description of the functions

Heating-up phase

During the heating-up phase the oven compartment is heated to the set temperature. The display will show the temperature of the cooking compartment as it rises.

The duration of the heating-up phase will depend on the quantity and the temperature of the food. In general the heating-up phase will last for approx. 7 minutes. The duration will be longer if you are preparing frozen or refrigerated food. Filling the water container with hot water will shorten the heating-up time.

Cooking phase

The cooking phase begins when the set temperature is reached. During the cooking phase the duration remaining (time left) will be shown in the display.

Steam reduction

The steam oven is delivered with this function activated. It reduces the amount of steam which escapes from the appliance when the door is opened at the end of the cooking duration. You can deactivate the steam reduction function (see "Settings / Steam reduction").

Keeping warm

The steam oven is set at the factory so that if it is not switched off at the end of a cooking programme, it will maintain a temperature of 70°C for a maximum of 15 minutes to keep food warm. You can deactivate the keeping warm function (see "Settings / Keeping warm").

Please note that delicate food, especially fish, can continue cooking whilst being kept warm.

Please refer to the "User instructions" booklet supplied with your appliance for more information and tips on how to use your steam oven.

Before using for the first time

Setting up the appliance for using for the first time

The appliance will switch on automatically when it is connected to the electricity supply.

A welcome screen will appear in the display and you will then be requested to select some basic settings which are needed to set up the appliance up for using for the first time.

Follow the instructions in the display.

Setting the language

The welcome screen will be replaced by the request to set a language:

- Touch one of the sensors next to the arrows until the language you want appears in the display.
- Touch the sensor to the left hand side of the language you want.

A tick ✓ will appear beside the language selected. If you have chosen the wrong language by mistake you can follow the flag symbol 🚩 to return to the Language sub-menu.

- Confirm your selection by touching the sensor next to "OK" (the lowest of the three sensors beside the display on the right hand side).

Clock format

The request to select a Clock format will appear. The default setting for the clock is 24 h.

- Touch the sensor next to the clock format you want.
- Touch the sensor next to "OK" to confirm your selection.

Before using for the first time

Time of day

You will then be requested to enter the Time of day.

You can either use the sensors next to **+** and **-** or the numerical keypad to enter the time.

Enter the time as 4 figures, e.g. 10 minutes past 9 o'clock in the morning = 09:10.

■ Enter the hour and minutes and confirm with "OK".

Time of day display

You will then be asked if you want the display to always show the time:

On = the display will always show the time of day

On for 60 seconds = the display will show the time for 60 seconds after the appliance is switched off

Do not display = the display will only show the time when the appliance is switched on

■ Select the option you want.

After you have confirmed your selection with "OK", the display will show messages to tell you that:

– your appliance is set up ready to take the Miele@home system.

– your appliance has been successfully set up to use it for the first time.

■ Confirm with "OK".

Your steam oven is now ready for use.

Before using for the first time

Please stick the extra data plate for the appliance supplied with this documentation in the space provided in the "After sales service" section of this booklet.

Cleaning for the first time

Remove any protective foil and adhesive labels.

Water container

Take the water container out of the appliance and remove the insert (see "Cleaning and care / Water container"). Rinse the water container and the insert thoroughly by hand using hot water. Do not use any washing-up liquid or detergent.

Do not clean the water container or the insert in a dishwasher. Do not immerse the water container in water.

Accessories / Oven interior

Take all accessories out of the oven. Wash them in a mild solution of washing-up liquid and hot water or in the dishwasher.

The interior of the steam oven has been treated at the factory with a conditioning agent. To remove this, clean the oven interior with a mild solution of washing-up liquid and hot water and then dry thoroughly with a soft cloth.

Before using for the first time







Setting the correct boiling point for water

The boiling point for water at a high altitude above sea level will be lower than the boiling point for water at sea level. To adjust the boiling point for the altitude in your area, fill the water container with mains tap water (see "Brief operating instructions / Preparing the appliance for use") and then run the Steam cooking / Universal (100 °C) programme for 15 minutes. Proceed as described in "Brief operating instructions".

This procedure sets the correct boiling point for water for the altitude in your area and also flushes out the waterways. Warning! A lot of steam will be emitted from the appliance.

If you **move house**, the appliance will need to be re-set for the new altitude if this differs from the old one by more than 300 m. To do this, descale the appliance (see "Cleaning and care / Descaling").

Please refer to the "User instructions" booklet supplied with your appliance for more information on the following functions as well as tips on how to use your steam oven.

	Function / Menu	Recommended temperature	Temperature range
	Steam cooking universal For cooking of all types of food, bottling, extracting juice with steam, menu cooking	°C 100 °F 212	°C 40 - 100 °F 105 - 212
	Cook fish	°C 85 °F 185	°C 75 - 100 °F 165 - 212
	Cook vegetables	°C 100 °F 212	°C 90 - 100 °F 195 - 212
	Cook meat	°C 100 °F 212	°C 90 - 100 °F 195 - 212
	Reheat	°C 100 °F 212	°C 80 - 100 °F 175 - 212
	Defrost	°C 60 °F 140	°C 50 - 60 °F 120 - 140
	Descal For descaling the water container	-	-
	Automatic	-	-
	Menu cooking Various types of food can be cooked to be ready at the same time	-	-
	User programmes You can create and store cooking processes	-	-
	Settings You can change the factory default settings	-	-

Brief operating instructions

Preparing the appliance for use

- Fill the water container with mains tap water up to at least the "min" marker. You do not need to remove the insert.

Only use **mains tap water**. Never use distilled or mineral water or other liquids.

- Push the water container into the appliance until it connects.

If the water container is not positioned correctly, the appliance will not heat up and after a while **F20** will appear in the display (see "Problem solving guide").

- Place the food in the oven.

Selecting a function

- Switch on the appliance ①.
- If the function displayed is not the one you want, touch one of the illuminated sensors next to the arrows in the display until the function you want appears.
- Touch the sensor beside the function to select it.

Setting the temperature

- If you want to use the recommended temperature then confirm with "OK". If you want to change the temperature, enter the new temperature with either **- / +** or the numerical keypad. Confirm with "OK".

Setting a cooking duration

- Enter the cooking duration you require with **+ / -** or the numerical keypad, e.g. 20 minutes.
- Confirm your selection by touching "OK".

The appliance will start automatically after the duration has been confirmed.

At the end of the duration

At the end of the cooking duration an audible tone will sound and "Steam reduction" and "Programme finished" will appear in the display. The door will open slightly during steam reduction.

Wait until "Steam reduction" goes out in the display before opening the door and removing the food.

- Switch off the appliance.

The fan will continue to run for a while after the oven has been switched off. If you want to reduce the run-on time, you can do so by removing the water container as soon as you have switched the appliance off.

The keeping warm function will be activated if you do not switch the oven off.

When putting cooking containers or the condensate tray into the steam oven or taking them out, take care not to spill the contents. Avoid contact with hot steam, and do not touch the hot oven interior walls. Danger of burning and scalding.

After use

- Remove the condensate tray and empty it.
- Remove the water container by pushing upwards slightly as you take it out of the appliance. Empty it.
- After each use, clean and dry the whole appliance as described in "Cleaning and care".
- Leave the door open until the cooking compartment is completely dry.

The appliance is designed in such a way that there will always be a little residual water left in the water container after use. If there is no residual water, there is something wrong. Call the Service Department.

Operation

During operation

Interrupting operation

Operation is interrupted as soon as the door is opened. The heating will be switched off and the cooking duration remaining stored in memory.

Steam will escape when the door is opened. Step back from the steam oven and wait until the steam has dissipated.

When putting cooking containers or the condensate tray into the oven or taking them out, take care not to spill the contents. Avoid contact with hot steam, and do not touch the hot oven interior walls. Danger of burning and scalding.

Operation will resume when the door is closed.

When the door is closed, the pressure has to equalise, which can cause a whistling sound.

The oven will heat up again and the display will show the temperature of the cooking compartment as it rises. Once the set temperature has been reached, the display will change to show the cooking duration remaining as it counts down.

Changing a programme

- Select "Change".
- Select the setting you wish to change, e.g. "Temperature" and then enter the change.
- Confirm with "OK".

Saving settings

You can save the settings for a cooking programme while it is in progress, so that you can call it up again from the User programmes menu at a later date.

- Select "Change".
- Touch one of the sensors next to the arrows until "Save as" appears.
- Select "Save as".

A summary will appear in the display.

- Confirm with "Continue".
- Follow the instructions given in "User programmes - Save".

Insufficient water

If the steam oven runs out of water during operation, an audible tone will sound and the display will prompt you to fill the water container with fresh tap water.

- Remove the water container and fill it with fresh tap water.
- Push the water container into the appliance until it connects.
- Close the door.

Operation will continue.

Operation

Automatic

The weight entry in the Automatic programmes refers to the weight per piece. For example, you can cook just one piece of salmon weighing 250 g or 10 pieces of salmon weighing 250 g at the same time.

- Fill the water container with fresh tap water and push it into the appliance.
- Insert the condensate tray, if required, at the lowest level.
- Place the food in the appliance.
- Switch on the appliance ①.

- Select the programme you want.
- Select the food you want.

Depending on the programme and the type of food selected, the display will prompt you to enter the size and how well done you want the food. The factory default setting is medium (for how well done you want the food). It is best to use the preset value to start with. If food is not cooked sufficiently it can be put back in the oven and cooked some more.

- Enter the values you want and confirm with "Continue".
- Start the cooking programme straight away or enter a start time or end time (see "Start time / Finish").

Menu cooking (cooking whole meals)

You can select up to three ingredients, e.g. fish, rice and vegetables. The steam oven uses cooking duration for its calculations so the food with the longest cooking duration must be placed in the oven first.

- Fill the water container with fresh tap water and push it into the appliance.
- Insert the condensate tray, if required, at the lowest level.
- Switch on the appliance ①.
- Select "Menu cooking".
- Select the food you want.

Depending on the type of food selected the display will prompt you to enter the size and how well done you want the food.

- Select or enter the values you want and confirm with "Continue".
- Select "Add next ingredient".
- Select the food you want and proceed in the same way as with the first ingredient.
- Repeat for the third food type.

After you have confirmed "Start menu cooking", the display will show the food type and the shelf runner.

At the end of the heating-up phase, the display will show when the next food type is to be placed in the oven. When the time for the next food type to be placed in the oven is reached, the display will show the food type and the shelf runner. This process will be repeated for the third food type.

You can also use the steam oven to cook a menu / whole meal using types of food which do not appear in the display list. See "Menu cooking" in the User instructions supplied with the appliance for more information on how to do this.

Operation

User programmes

You can save up to 25 cooking programmes under their own individual names in the User programmes menu.

If you have not yet created any user programmes, the display will only show the functions.

If user programmes have already been created and saved, the following will appear:

Select

User programmes can be called up and started.

Create

You can create user programmes.

Change

Existing programmes will be shown in the display and can be altered.

Delete

Existing programmes can be deleted.

Use in main menu

You can place up to three existing programmes in the main menu. When doing this you can allocate the programme to a specific position at the end of the Main menu.

Create

- Select "User programmes".
- Select "Create".
- Select the function you want.
- Enter the settings as normal and confirm with "Continue".

A summary will appear in the display.

- Confirm with "Continue".

You can now save the cooking programme.

Save

The programme can be saved under the pre-set name, e.g. "Dish 1", under a name of your choice, e.g. "Minestrone" or a combination of both, e.g. "Dish 1 Minestrone"

Use the sensors on the left and right hand side of the alphabet to highlight the letters you want and confirm them with "Select character". The appliance will enter the letters as lower or upper case automatically. Complete the process with "Confirm name".

Additional functions

Start time / Finish

You can delay the start of a programme. The oven will then switch on automatically.

With "Start time" you enter the time of day at which you want the programme to start. With "Finish" you enter the time of day at which you want the programme to end.

The difference between the Start time and Finish is the cooking duration selected plus the heating-up time which the steam oven calculates.

It is only possible to delay the start within 60 seconds after making an entry. This function cannot be used if the temperature in the oven is above 40°C, e.g. after a cooking process.

Cooking results can be impaired if there is a long delay between the food being placed in the oven and the start of cooking.
Fresh food can change its colour and even deteriorate.

- Select the function, temperature and duration in the normal way.
- Then select "Start time" or "Finish" and enter the time you want the cooking programme to begin or end at.
- Confirm with "OK".

Pre-heat

Your appliance has a pre-heating function. This heats the oven interior to approx. 40°C. The heating-up time is then shorter as the oven interior is pre-heated and therefore the cooking process takes less time.

The appliance is delivered with the pre-heating function deactivated. If you wish to use it you will need to alter the setting (see "Settings / Pre-heat").

When the pre-heat function has been activated you can still choose whether you want to use it for each programme.

The water container must be filled with water for pre-heating.

The pre-heating process will be cancelled if the door is opened. You can start the process again by switching the appliance off and back on again.

If the door is not opened within 30 minutes of the end of the pre-heating process, the main menu will appear in the display.

Using pre-heat

- Switch on the appliance.

The main menu will appear in the display. **Do not select a function.**

The display will change after a few seconds and the appliance will start heating up. When the heating up process has finished "Programme finished" will appear in the display.

- Place the food in the oven.

The main menu will appear in the display.

- Select the settings as normal.

Not using pre-heat

- Place the food in the oven.

- Switch on the appliance.

Select the function and set the temperature and duration as normal.

Additional functions

Minute minder time

The minute minder can be used to time any activity in the kitchen, e.g. boiling eggs.

You can also use the minute minder when a programme is running, e.g. as a reminder to stir a dish or add seasoning etc.

You can set a time for the minute minder of between 1 second (-:- :-1 h:min:sec) and 9 hours 59 minutes 59 seconds (9:59:59).

A minute minder time of up to 10 minutes will be shown in min:sec in the display, and a minute minder time of more than 10 minutes in h:min.

The minute minder time must be entered in minutes and seconds or hours, minutes and seconds.

Example: 8 minutes = -:-8:00.

At the end of the minute minder time you will hear an audible tone. Switch the minute minder time off by touching "<C". If you do not switch the minute minder off, the time will carry on counting in seconds and the Δ symbol will flash in the display. This will tell you how much time has passed since the minute minder time elapsed.

Setting the minute minder time

- Touch the Δ sensor.
- Use the sensors next to +/- or the numerical keypad to enter the minute minder time.
- Confirm with "OK".

Changing the minute minder time

- Touch the Δ sensor, enter the new time and confirm with "OK".

Deleting the minute minder time

- Touch the Δ sensor, touch <C and confirm with "OK".

System lock

The lock prevents the steam combi oven being switched on unintentionally, by children for example.

The appliance is delivered with the lock deactivated (factory default setting). Before this feature can be activated, you will need to change the factory default setting to "Permitted" (this only needs to be done once, see "Settings / Safety").

To activate the system lock

- Select the  symbol.
- Select "On" and confirm with "OK".

To deactivate the system lock

- Select the  symbol.
- Select "Off" and confirm with "OK".

Settings

Some of the standard steam oven settings (factory default settings) have an alternative which you can select if required. You can alter several settings one after the other.

Proceed as follows:

- Switch on the appliance.
- Select the Settings menu.
- Select the setting you want to change.

A tick ✓ will indicate which setting is currently selected.

If you do not make a selection in the sub-menu within approx. 5 seconds, the display will revert to the Settings menu.

Language 🚩

You can set the display to show the language of your choice.

You do this via the Languages 🚩 sub-menu.

If you have selected the wrong language by mistake you can follow the flag symbol 🚩 to return to the Language sub-menu.

Time of day

Display: You can choose whether you want the time of day to be displayed all the time when the appliance is switched off or for it to go out after 60 seconds or not to be shown.

Clock format: The time of day can be set to appear either as a 24 hour or 12 hour clock.

Set: Set the time of day

Start

The appliance has been set at the factory so that the programme will start automatically a few seconds after the last entry is made. You can alter this setting so that the programme has to be started manually.

Steam reduction

This function can be activated or deactivated. It is best to deactivate it when you are cooking different types of food at the same time, e.g. when cooking a whole meal and the dishes need to be put into the steam combi oven at different times.

Please note that when steam reduction is deactivated a lot of steam will escape when you open the door and that the keeping warm function cannot be used.

Keeping warm

This function can be activated or deactivated.

Pre-heat

This function can be activated or deactivated.

Recommended temperatures

If you frequently change a recommended temperature it may be a good idea to change it permanently. You can change the temperatures within the permitted range.

Settings

Water hardness

The steam oven is set at the factory to water hardness setting IV (Very hard 4). You can set the steam oven for the water hardness level in your area.

You can use the test strip supplied to check the water hardness level, or your local water supplier will be able to advise you on the water hardness of your area.

The water hardness is shown as settings I to IV equivalent to the German scale 1 to >21 °dH (0.2 >3.8 mmol/l).

Hardness level	Hardness range	Setting
I	1-7 °dH (0.2-1.3 mmol/l)	Soft 1
II	8-14 °dH (1.4-2.5 mmol/l)	Medium 2
III	15-21 °dH (2.7-3.8 mmol/l)	Hard 3
IV	>21 °dH (above 3.8 mmol/l)	Very hard 4

Display

The contrast and brightness can be adjusted.

Volume

The volume of the buzzer and also the keypad tone which sounds each time a sensor is touched can be altered. The keypad tone can also be switched off.

Safety

Once the setting under "System lock" has been changed to "Permitted", you will be able to activate the system lock to prevent the steam oven being switched on unintentionally, by children for example.

Units

You can choose for the weight to be shown in kg or lbs, the temperature in °C or °F and the depth / thickness in cm or inches.

Showroom programme

This programme is for dealers who want to demonstrate the appliance without the heater elements working. Do not activate this setting for domestic use!

If you select and activate this option by mistake, you can deactivate it as follows:

- Demo programme
 - Select the "Off" option and follow the instructions in the display.
- Continuous loop, Demo mode
 - Touch one of the sensors next to the display and follow the instructions in the display.

Factory default

All settings: any changes you have made to settings in the "Settings" menu will be reset to the factory default setting. Saved user programmes will be kept.

User programmes: all saved user programmes will be deleted.

Main menu: the main menu will be reset to the factory default setting.

Recommended temperatures: recommended temperatures which have been changed will be reset to the factory default settings.

Cleaning and care

Miele offer a range of branded cleaning and conditioning products. See “Optional accessories”.

General notes

Disconnect the appliance from the electricity supply and allow it to cool down to a safe temperature before cleaning.

It should be cleaned after each use.

Make sure the appliance is completely dry before closing the door.

Do not use a steam cleaning appliance to clean this appliance. The steam could reach the electrical components and cause a short circuit.

Do not use commercial cleaning agents. Only use agents designed for domestic use.

Do not use cleaning agents or washing-up liquids containing aliphatic hydrocarbons as these could cause the seals to swell.

Appliance front

Remove any soiling immediately.
If not, it might become impossible to remove and could cause the surface to alter or discolour.

Clean the front using a damp Miele microfibre E-cloth or with a clean sponge and a solution of hot water and washing-up liquid. After cleaning dry with a soft cloth.

The external surfaces of this appliance are all susceptible to scratching. Scratches on glass surfaces could even cause a breakage.

Contact with unsuitable cleaning agents can alter or discolour surfaces.

To avoid damaging your appliance, do not use:

- cleaning agents containing soda, alkalines, ammonia, acids or chlorides,
- cleaning agents containing descaling agents,
- abrasive cleaning agents, e.g. powder cleaners and cream cleaners,
- solvent-based cleaning agents,
- stainless steel cleaning agents,
- dishwasher cleaner,
- oven sprays,
- glass cleaning agents,
- hard, abrasive sponges and brushes, e.g. pot scourers,
- sharp metal scrapers.

Cleaning and care

Oven interior

Dry the oven interior, oven interior roof, door seal, drip channel, inside of the door and the compartment for the water container after each use. Use a sponge or absorbent cloth to wipe off the condensate which has built up in the compartment.

Remove grease deposits with a clean sponge and a solution of hot water and washing-up liquid. Rinse with clean water and then dry the oven interior with a soft cloth.

After prolonged use, the **floor heater** can become discoloured by drops of liquid. This discolouration can be removed easily with the Miele ceramic and stainless steel hob cleaner (see "Optional accessories"). After cleaning, wipe the surface with a damp cloth to remove any cleaning agent residues.

Replace the **door seal** with a new one if it becomes porous or brittle. Door seals can be ordered from the Miele Spare Parts Department.

When fitting the new seal make sure that any joint is at the top.

Condensate tray, rack and cooking containers

Wash and dry the condensate tray, rack and cooking containers after each use. They are all dishwasher safe.

Use a little vinegar to remove any bluish discolouration on the cooking containers.

You could also use the Miele ceramic and stainless steel hob cleaner (see "Optional accessories"). Rinse the containers thoroughly with clean water to remove any residual cleaning agent.

Automatic door release

Make sure that the door release does not get clogged with food deposits. Remove soiling with a clean sponge and a solution of hot water and washing-up liquid. Rinse with clean water and then dry the oven interior with a soft cloth.

Water container

Remove, empty and dry the water container after each use.

- Release the insert by pushing the catches on the sides in towards each other and then pull it out of the container.

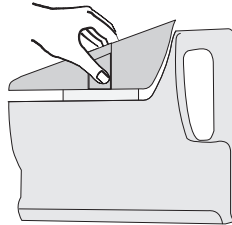

- After cleaning, dry both parts of the insert thoroughly before replacing it in the water container. When replacing the insert, guide it in at an angle ① and then push it downwards ② as illustrated.

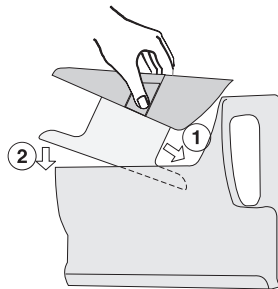

Do not immerse the water container in water or clean it in a dishwasher.

It is important to empty the water container after each use for hygiene reasons, and also to prevent condensate building up in the appliance.

Do not use scouring pads or hard brushes.

Cleaning and care

Coupling seal

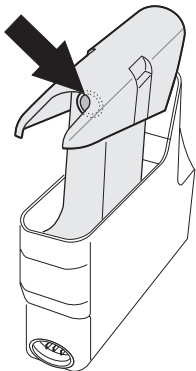

If the water container becomes difficult to remove and replace or the fault message *F20* appears, rub a small amount of the silicone grease supplied (see "Guide to the appliance / Accessories supplied") into the inside of the coupling seal. Do not take the seal out to lubricate it!

When handling silicone grease, please observe the following safety measures:

- Remove any silicone grease from your skin either by wiping it off or by washing it off.
- If the grease gets into the eyes, it must be rinsed out with plenty of clean water.
- If it is swallowed, seek medical advice.

The coupling seal should be replaced with a new one if it becomes brittle or porous or if an unusually large amount of water collects on the floor of the water container compartment.

Coupling seals can be ordered from the Miele Spare Parts Department.

Only use the silicone grease supplied. On no account must margarine or oil or any other domestic grease or fat be used, as these can cause the seal to swell.

Descaling

For optimum cleaning results we recommend that you use Miele descaling tablets to descale your steam oven (see "Optional accessories"). A proprietary citric acid based descaling agent can also be used. Follow the manufacturer's instructions on the packaging.

Ensure that the descaling agent does not come into contact with the door handle or the metal control panel as this could cause marks. However, should any descaling agent get onto these surfaces, wipe it away immediately.

The water container will need descaling after a certain number of operating hours. The display will alert you when this needs to be done.

The appliance will lock out after you have run the tenth programme.

However, we recommend that you descale the appliance before it locks out.

- Fill the water container with 1 litre of descaling solution. Follow the instructions on the descaling agent packaging carefully.
- Push the water container into the appliance until it connects.
- Switch the appliance on and select "Descale".
- Confirm with "Continue".

The descaling process will now begin. It is only possible to cancel the descaling process during the first minute. After that the process cannot be cancelled.

Do not switch the appliance off during the descaling process. If it is switched off before the end of the process, the whole process will have to be started from the beginning again.

After 12 minutes, the appliance will prompt you to fill it with fresh tap water.

Cleaning and care

- Remove the water container and empty it. Remove the insert.
- Rinse the water container and the insert thoroughly.
- Replace the insert and fill the water container with 1 litre of fresh tap water. Push the water container into the appliance until it connects.

The descaling process will continue automatically when the water container is pushed back into the appliance.

After descaling:

- Switch off the appliance.
- Open the door.
- Remove the water container and empty it.
- Dry the appliance thoroughly.
- Make sure the appliance is completely dry before closing the door.

Removing and refitting the door

It is much easier to clean the steam oven interior if you remove the door first.

To remove the door

- Open the door fully.
- Flip up the release levers in front of the door hinges.

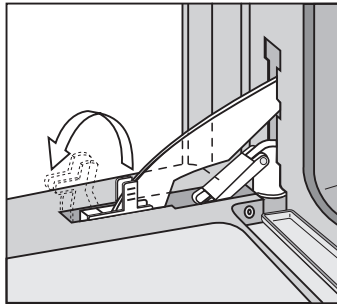

- Slowly close the door until the raised levers are touching the frame.
- Holding the door evenly with both hands, lift the door up and off the hinges.

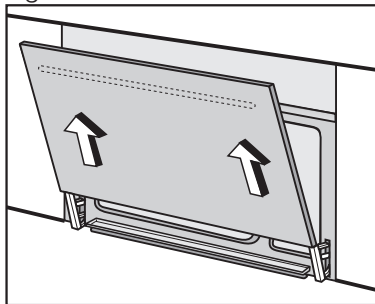

To refit the door

- Fit the door on the hinges.
- Open the door fully.
- Then push the levers back down.
- Close the door.

Problem solving guide

 Installation work and repairs to electrical appliances must only be carried out by a suitably qualified and competent person in strict accordance with current local and national safety regulations (BS 7671 in the UK). Repairs and other work by unqualified persons could be dangerous. The manufacturer cannot be held liable for unauthorised work.

What to do if ...

... you cannot switch the appliance on.

Check whether the mains fuse has tripped.

If this is not the case, then disconnect the appliance from the electricity supply for approx. 1 minute. To do this:

- switch off at the socket and withdraw the plug, or
- switch off at the isolator, or
- disconnect the mains fuse.

Reset the trip switch in the mains fuse box, and switch the appliance back on. If it still will not switch on, contact a qualified electrician or the Miele Service Department.

... the appliance is in demo mode.

The appliance will not heat up if it is in demo mode. See "Settings / Showroom programme".

... the fan can still be heard after the appliance has been switched off.

The appliance is fitted with a fan which removes steam from the oven.

The fan will continue to run for a while after the appliance has been switched off.

... the water container has become harder to put into the appliance and take out again.

Lightly lubricate the coupling seal on the water container with silicone grease, as described in "Cleaning and care / Coupling seal".

... the heating-up phase lasts an unusually long time.

Check the bottom of the water container.

If a thick layer of limescale has built-up, check the water hardness level that has been set. Set the correct water hardness level for your water supply (see "Settings / Water hardness"), and descale the appliance as described in "Cleaning and care / Descaling".

If the water hardness level was in fact set correctly or the problem occurs again, contact the Service Department.

... after moving house the appliance no longer switches from the heating up phase to the cooking phase.

Altitude affects the boiling point of water. If you move house, the appliance will need to be re-set for the new altitude if this differs from the old one by more than 300 m. To do this, descale the appliance (see "Cleaning and care / Descaling").

... during operation an unusually large amount of steam escapes or steam escapes from parts of the steam oven where it does not usually.

Check whether

- the door is closed properly.
- the door seal is fitted correctly. If necessary, press it in all the way round the door to make sure it is fitted evenly.
- the door seal is damaged, e.g. cracks can be seen. The seal must be replaced with a new one.

If this does not solve the problem, call the Miele Service Department.

Problem solving guide

... a whistling sound is heard when the appliance is switched on again.

When the door is closed, the pressure has to equalise, which can cause a whistling sound. This is not a fault.

... F and a number appear in the display.

This combination indicates a fault.

- F 20: The appliance does not heat up.

Check whether the water container has been pushed right into the appliance so that it connects.

Switch the appliance off and then back on again.

- A fault message will appear if the temperature of the oven compartment has not risen by at least 2 °C within 5 minutes of the start of the heating up phase. This can occur if, for example, a large quantity of frozen food is being prepared.
- Lightly lubricate the coupling seal on the water container with silicone grease, as described in "Cleaning and care / Water container / Coupling seal".

If the appliance still will not start, switch it off and contact the Miele Service Department.

- Other fault messages:

Call the Service department.

Optional accessories

Miele offers a range of useful accessories as well as cleaning and conditioning products for your appliance.

These can be ordered via the internet at www.miele-shop.com

or from Miele (see back cover for contact details) or from your Miele dealer.

Cooking containers

Each stainless steel cooking container has a Gastro-Norm (GN) size (Example GN 1/3). 1/3 or 1/2 is the width and depth of the cooking containers as shown below.

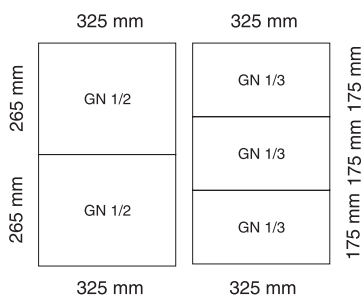

DGGL 1



Perforated cooking container, GN 1/3
Gross capacity 1.5 litres / Usable capacity 0.9 litres
325x175x40 mm (WxDxH)

DGG 2

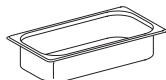

Solid cooking container, GN 1/3
Gross capacity 2.5 litres / Usable capacity 2.0 litres
325x175x65 mm (WxDxH)

Optional accessories

DGG 3

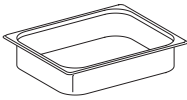

Solid cooking container, GN 1/2
Gross capacity 4.0 litres / Usable capacity 3.1 litres
325x265x65 mm (WxDxH)

DGGL 4

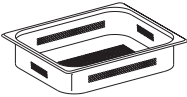

Perforated cooking container, GN 1/2
Gross capacity 4.0 litres / Usable capacity 3.1 litres
325x265x65 mm (WxDxH)

DGGL 5

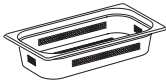

Perforated cooking container, GN 1/3
Gross capacity 2.5 litres / Usable capacity 2.0 litres
325x175x65 mm (WxDxH)

DGGL 6



Perforated cooking container, GN 1/3
Gross capacity 4.0 litres / Usable capacity 2.8 litres
325x175x100 mm (WxDxH)

DGG 7



Solid cooking container, GN 1/3
Gross capacity 4.0 litres / Usable capacity 2.8 litres
325x175x100 mm (WxDxH)

DGGL 8

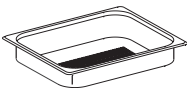

Perforated cooking container, GN 1/2
Gross capacity 2.0 litres / Usable capacity 1.7 litres
325x265x40 mm (WxDxH)

DGD



Lid for GN 1/3 cooking containers

Condensate tray

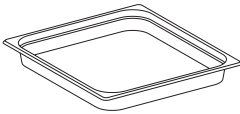

To catch excess moisture, GN 2/3
325x350x40 mm (WxDxH)

Rack

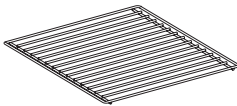

For placing your own cooking containers on

Cleaning and care products

Miele descaling tablets

6 tablets



For descaling the water container.

Optional accessories

Ceramic and stainless steel hob cleaner 250 ml



Removes discolouration from the floor heater caused by drops of liquid.
Removes discolouration from cooking containers.

E-Cloth (microfibre cloth)

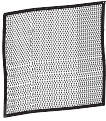

Removes finger marks and light soiling.

Silicone grease



For lubricating the coupling seal.
Please read the relevant instructions in "Cleaning and care".

Safety instructions for installation

- ▶ Before connecting the appliance, make sure that the connection data on the data plate (voltage and connected load) match the mains electricity supply. This data must correspond in order to avoid the risk of damage to the appliance. Consult a qualified electrician if in any doubt.
 - ▶ The socket and on-off switch should be easily accessible after the appliance has been installed.
 - ▶ This appliance may only be used in mobile installations such as ships, caravans, aircraft etc. if a risk assessment of the installation has been carried out by a suitably qualified engineer.
 - ▶ The appliance must be positioned so that you can see the contents of a cooking container placed on the top runner. Otherwise you may risk scalding or burning yourself with hot water and food when taking containers out of the oven.
- All dimensions in this instruction booklet are given in mm.

Appliance and building-in dimensions

Installation in a tall unit

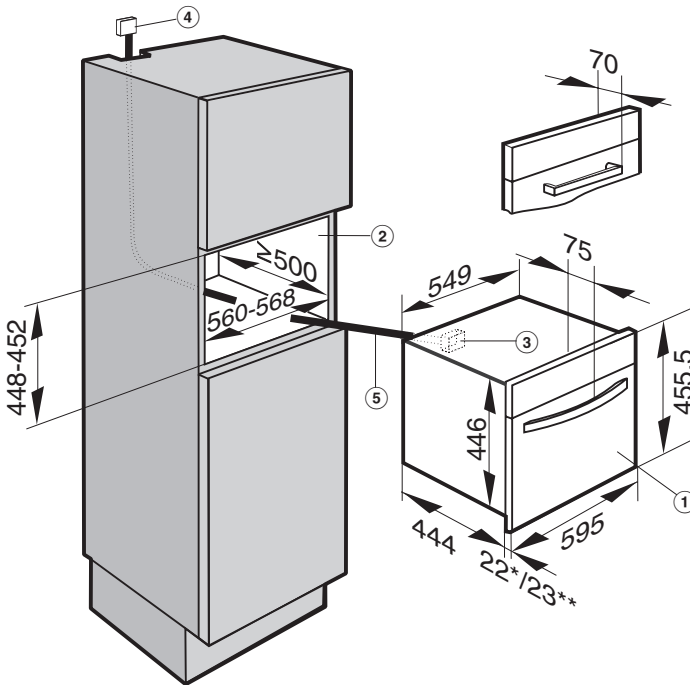

* Appliances with glass front

** Appliances with metal front

- ① Steam oven
- ② Building-in recess
- ③ Inlet for mains connection cable to the appliance
- ④ Recommended position for electrical socket.
Important: Do not position behind the appliance!
- ⑤ Mains connection cable

Appliance and building-in dimensions

Installation in a base unit

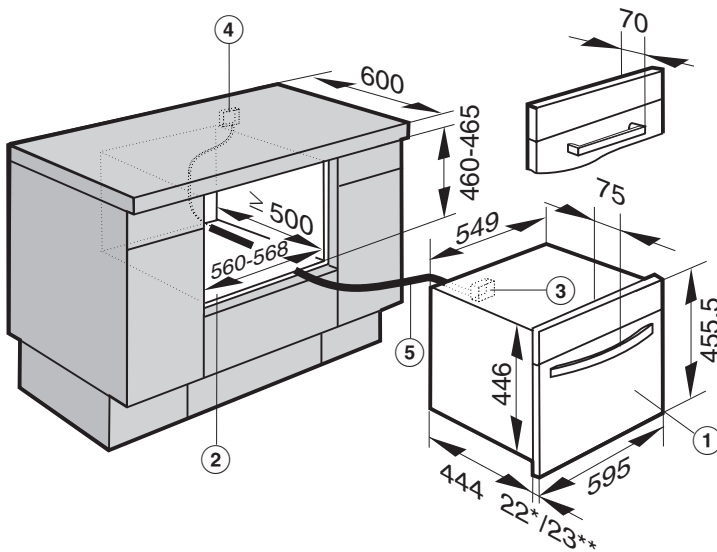

* Appliances with glass front

** Appliances with metal front

- ① Steam oven
- ② Building-in recess
- ③ Inlet for mains connection cable to the appliance
- ④ Recommended position for electrical socket.
Important: Do not position behind the appliance!
- ⑤ Mains connection cable

N.B. Undercounter installation is not recommended if there are young children in the home.

Appliance and building-in dimensions

Installation in a tall unit in combination with an oven

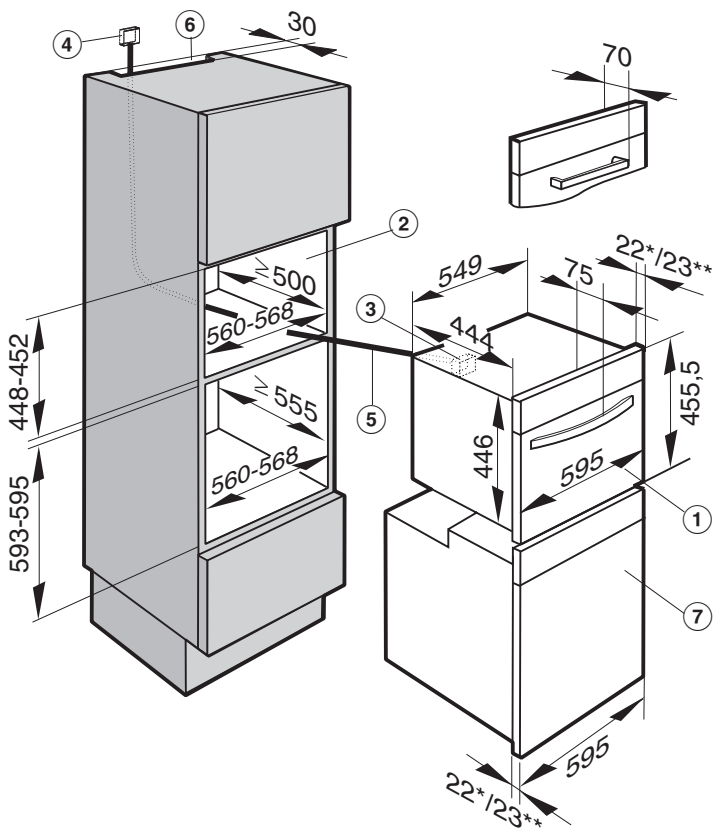

* Appliances with glass front

** Appliances with metal front

① Steam oven

② Building-in recess

③ Inlet for mains connection cable to the appliance

④ Recommended position for electrical socket.
Important: Do not position behind the appliance!

⑤ Mains connection cable

⑥ Vent cut-out for when appliance is installed in combination with a pyrolytic oven

⑦ Oven

Installing the appliance

- Push the appliance into the recess and align it.
- Secure the appliance by screwing the two wood screws 3.5 x 25 mm ⑨ (supplied) into the vertical trim on either side of the appliance (see illustration).

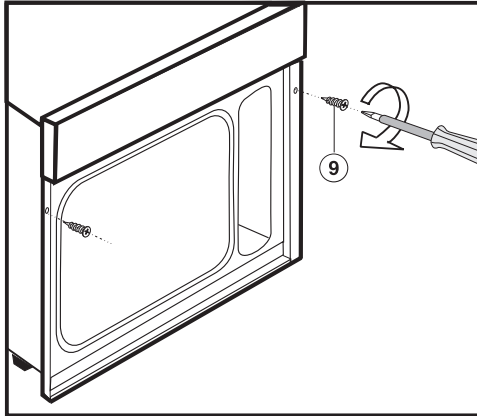

Electrical connection

All electrical work should be carried out by a suitably qualified and competent person, in strict accordance with current local and national safety regulations (BS 7671 in the UK).

Installation, repairs and other work by unqualified persons could be dangerous. The manufacturer cannot be held liable for unauthorised work.

Ensure power is not supplied to the appliance until after installation work has been carried out.

The appliance must only be operated when built-in. This is to ensure that all electrical parts are shielded. Live parts must not be exposed.

Do not connect the appliance to the mains electricity supply via an extension lead. These do not guarantee the required safety of the appliance.

Please ensure that the connection data quoted on the data plate match the household mains supply.

This appliance is supplied with a cable and moulded plug for connection to a suitable switched socket which should be easily accessible after installation.

It can, if necessary, be connected to a suitable isolator or a double pole fused spur connection unit which complies with national and local safety regulations by a suitably qualified electrician.

If the switch is not accessible after installation (depending on country) an additional means of disconnection must be provided for all poles.

For extra safety it is advisable to install a suitable residual current device.

When switched off there must be an all-pole contact gap of 3 mm in the isolator switch (including switch, fuses and relays).

Important U.K.

This appliance is supplied for connection to a single phase 230-240 V 50 Hz supply with a 3-core cable.

The wires in the mains lead are coloured in accordance with the following code:

Green/yellow = earth

Blue = neutral

Brown = live

WARNING: THIS APPLIANCE MUST BE EARTHED

Non-rewireable plugs BS 1363

The fuse cover must be refitted when changing the fuse, and if the fuse cover is lost, the plug must not be used until a suitable replacement is obtained. The colour of the correct replacement cover is that of the coloured insert in the base of the plug, or the colour that is embossed in words on the base of the plug (as applicable to the design of plug fitted).

Replacement fuses should be ASTA approved to BS 1362 and have the correct rating. Replacement fuses and fuse covers may be purchased from your local electrical supplier.

Important

The electrical safety of this appliance can only be guaranteed when continuity is complete between the appliance and an effective earthing system, which complies with local and national regulations. It is most important that this basic safety requirement is tested regularly and where there is any doubt the household wiring should be inspected by a qualified electrician. The manufacturer cannot be held liable for the consequences of an inadequate earthing system such as electric shock.

The manufacturer cannot be held liable for damage caused by incorrect installation or connection.

After sales service, data plate

In the event of any faults which you cannot remedy yourself, or if the appliance is under guarantee, please contact:

- Your Miele dealer, or
- the Miele Customer Contact Centre (see back cover for address).

Please note that telephone calls may be monitored and recorded to improve our service.

When contacting Miele, please quote the model and serial number of your appliance, which are given on the data plate.

Space in which to stick the extra data plate supplied with the appliance. Ensure that the model number is the same as the one on the front of these instructions.

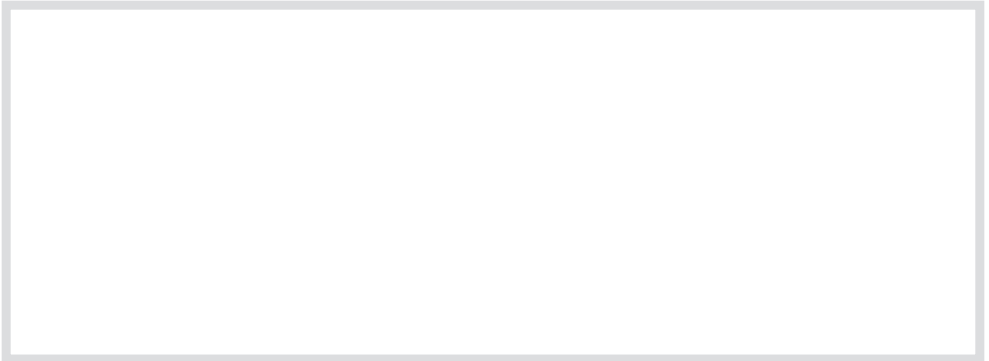



United Kingdom:

Miele Co. Ltd.
Fairacres, Marcham Road
Abingdon, Oxon, OX14 1TW
Tel: (01235) 554455
Fax: (01235) 554477
Customer Contact Centre Tel: (08707) 554466
E-mail: info@miele.co.uk
Internet: www.miele.co.uk

Australia:

Miele Australia Pty. Ltd.
A.C.N. 005635398
1 Gilbert Park Drive, Knoxfield, VIC 3180
Tel: (03) 9764 7130
Fax: (03) 9764 7149
Internet: www.miele.com.au

China

Miele Shanghai Rep. Office
Room 4105 - 6, 41 Floor
Plaza 66, 1266 Nan-Jing Road/ West
Shanghai 200040
Tel: +86 21 6288 4200
Fax: +86 21 6288 4100
E-mail: miele.shanghai@cn.miele.com
Internet: www.miele.cn

Hong Kong:

Miele (Hong Kong) Limited
AIA Plaza, 24 Floor
18 Hysan Avenue
Causeway Bay
Tel: +852- 2610-1331
Fax: +852-2610-1013
E-mail: mielehk@miele.com.hk
Internet: www.miele.hk

Ireland:

Miele Ireland Ltd.
Broomhill Road, Tallaght, Dublin 24
Tel: (01) 461 0710
Fax: (01) 461 07 97
E-Mail: info@miele.ie
Internet: www.miele.ie

New Zealand

Miele New Zealand Limited
Unit L, 10-20 Sylvia Park Road
Mt. Wellington, 1060, Auckland, NZ
Tel: (09) 573 1269
Fax: (09) 573 1268
Internet: www.miele.co.nz

South Africa:

Miele (Pty) Ltd
63 Peter Place, Bryanston 2194
P.O. Box 69434, Bryanston 2021
Tel: +27 (0) 11 548-1900
Fax: +27 (0) 11 548-1935
E-mail: info@miele.co.za
Internet: www.miele.co.za

Singapore:

Miele Southeast Asia
Miele Pte. Ltd.
163 Penang Road
04 - 02/03 Winsland House II
Singapore 238463
Tel: +65 6735 1191
Fax: +65 6735 1161
E-Mail: infosea@miele.com.sg
Internet: www.miele.sg

United Arab Emirates

Miele Appliances Ltd.
P.O. Box 11 47 82
Gold & Diamond Park
Sheikh Zayed Road
Building 6 / Offices Nos. 6-214 to 6-220
Dubai
Tel: +971-4-341 84 44
Fax: +971-4-341 88 52
E-Mail: info@miele.ae
Internet: www.miele.ae



Free Manuals Download Website

<http://myh66.com>

<http://usermanuals.us>

<http://www.somanuals.com>

<http://www.4manuals.cc>

<http://www.manual-lib.com>

<http://www.404manual.com>

<http://www.luxmanual.com>

<http://aubethermostatmanual.com>

Golf course search by state

<http://golfingnear.com>

Email search by domain

<http://emailbydomain.com>

Auto manuals search

<http://auto.somanuals.com>

TV manuals search

<http://tv.somanuals.com>