

Miele

Operating and Installation Instructions



Ovens

H 4744 BP

H 4746 BP

To prevent accidents
and machine damage,
read these instructions



before

installation or use.

en - US, CA

M.-Nr. 07 964 080

Contents

IMPORTANT SAFETY INSTRUCTIONS	4
Guide to the oven	8
Guide to the display	9
Function selector	9
Temperature selector	9
Touch controls	10
Display	11
Triangle ▲ in the display	11
Oven accessories	12
Roasting pan, wire rack	12
Slide opener	12
Locking the oven	13
Settings	14
Changing the status of a setting	15
Before using the oven	16
To set the time of day for the first time	16
Heat the oven	17
Operation	18
Selecting a function	18
Cooling system	18
Adjusting the oven temperature	19
Temperature indicator	19
Pre-heating, "Rapid Heat" function	20
Delay Start  / 	21
Duration	21
End time	22
At the end of cooking	23
To check and change an entered time	24
To delete an entered time	24
Setting the timer	25
Setting the clock	26
Guide to the functions	27

Baking	28
Baking functions	28
Baking tips	28
Roasting	33
Roasting functions	33
Roasting tips	33
Broiling	36
Broiling functions	36
Broiling tips	36
Dehydrate	40
Proof	41
Defrost	42
Defrosting tips	42
Cleaning	43
Front of appliance	43
PerfectClean	44
Removing the oven door.	46
Removing the runners.	48
Lowering the upper heating element	48
Self Cleaning	49
Changing the light bulb	52
Frequently asked questions	53
Technical Service	54
Optional accessories	55
Installation instructions	57
Caring for the environment	58
Disposal of the packing materials	58
Disposal of an old appliance	58
Electrical connection	59
Appliance and Cut-out Dimensions	60
Installing the oven	62

IMPORTANT SAFETY INSTRUCTIONS

This appliance is intended for residential use only.

Only use the appliance for its intended purpose.

This appliance complies with current safety requirements. Improper use of the appliance can lead to personal injury and material damage.

Read all instructions before installing or using the oven for the first time.

Keep these operating instructions in a safe place and pass them on to any future user.

Use

▶ The appliance is intended for domestic use only: cooking, baking, roasting, broiling, defrosting and heating of food.

It is not designed for industrial or laboratory use.

▶ Do not use the appliance to store or dehydrate flammable materials. This is a fire hazard.

▶ Persons who lack physical, sensory or mental abilities, or experience with the appliance should not use it without supervision or instruction by a responsible person.

Children

▶ Children should not be left unattended in an area where the appliance is in use. Never allow children to hang or lean on any part of the appliance.

▶ Children should not use the unit without supervision unless its operation has been sufficiently explained so they can run it safely. Children must be able to recognize potential hazards or improper operation.

▶ Do not allow children to touch or play in, on or near the oven when it is in operation. The oven gets hot at the oven door glass, the vapor vent, the handle and the operating controls. Danger of burns.

IMPORTANT SAFETY INSTRUCTIONS

Installation

▶ Before installation, make sure that the voltage and frequency listed on the data plate correspond with the household electrical supply. This data must correspond to prevent injury and machine damage. Consult a qualified electrician if in doubt.

▶ Be certain your appliance is properly installed and grounded by a qualified technician.

To guarantee the electrical safety of this appliance, continuity must exist between the appliance and an effective grounding system. It is imperative that this basic safety requirement be met. If there is any doubt, have the electrical system of the house checked by a qualified electrician.

▶ The oven is not to be operated until it has been properly installed within cabinetry.

▶ Installation, maintenance and repair work should be performed by an authorized service technician. Work by unqualified persons could be dangerous and may void the warranty.

▶ Before installation or service, disconnect the power supply to the work area by removing the fuse, "tripping" the circuit breaker, or shutting off the power main.

Oven use

 **WARNING:** Ovens can produce high temperatures that can cause burns.

▶ Prevent children from touching the appliance while in use.

▶ Use heat-resistant potholders when placing items in the oven, turning them, or removing them from the oven. The upper heating element and oven racks can become very hot and cause burns.

▶ To prevent burns, always place oven racks at their desired height while the oven is cool.

▶ Open the door carefully to allow hot air or steam to escape before placing or removing food.

▶ To prevent burns, allow the heating element to cool before cleaning by hand.

▶ During the self cleaning function the oven will become very warm. Prevent children from coming in contact with the oven.

▶ Remove all accessories from the oven before starting the self cleaning function. The high temperatures needed for this program will damage the accessories.

▶ The door gasket is essential for a good seal. Care should be taken not to rub, damage or move the gasket.

▶ Only clean parts listed in this manual.

IMPORTANT SAFETY INSTRUCTIONS

- ▶ **Caution:** Heating elements may be hot even though they are not glowing. During and after use, do not let clothing or other flammable materials come in contact with heating elements or interior surfaces of the oven until they have had sufficient time to cool. External parts of the oven such as the door glass, vents, and the control panel can become hot.
- ▶ Do not block any vent openings.
- ▶ Aluminum foil should not be used to line the oven floor. To avoid damage, do not place pots, pans or baking sheets directly on the oven floor.
- ▶ Do not let metal objects (aluminum foil, pans) come in contact with the heating element.
- ▶ Do not slide pots or pans on the oven floor. This could scratch and damage the surface.
- ▶ Do not lean, sit, or place heavy items on the open oven door.
- ▶ Do not heat unopened containers of food in the oven, pressure may build up and cause them to explode.
- ▶ Never add water to food on a hot tray or pan or directly onto food in a hot oven. The steam created could cause serious burns or scalds.
- ▶ This oven must only be used for cooking. Do not use it as a dryer, kiln, dehumidifier, etc. Fumes or vapors given off by glues, plastics or flammable liquids and materials could be hazardous.
- ▶ Never store flammable liquids and materials in, above or under an oven, or near cooking surfaces.
- ▶ When baking frozen pizzas or pies, place them on the rack lined with parchment paper. Do not use the baking tray or the roasting pan for frozen foods with a large surface area. The tray or pan could become warped and difficult to remove from the oven when hot. Frozen food like french fries, fish sticks, chicken fingers etc. can be baked on the baking tray.
- ▶ Always check that food is sufficiently heated. The time required varies depending on a number of factors, such as initial temperature, quantity, type and consistency of the food, and changes in the recipe. Germs present in the food are killed off only at a sufficiently high temperature (> 158° F / 70 °C) and after a sufficiently long time (> 10 Min.). Select a longer cook time if you are unsure if food is thoroughly heated. To ensure temperature is distributed evenly, stir and rotate food occasionally before serving.

IMPORTANT SAFETY INSTRUCTIONS

General notes

▶ Do not use a steam cleaner to clean the oven. Steam could penetrate electrical components and cause a short circuit.

▶ Children should not be left alone or unattended in an area where an oven is in use. Never allow children to sit or stand on any part of the oven.

Caution: Do not store items of interest to children in cabinets above an oven. Children climbing on the oven to reach these items could be injured.

▶ Do not leave the oven unattended when cooking with oils or fats, they are a fire hazard if overheated.

▶ Do not use water on grease fires! Smother the fire with a properly rated dry chemical or foam fire extinguisher.

▶ Be aware of loose fitting or hanging garments while operating the cooktop, they present a fire hazard.

▶ Do not use the oven to heat the room.

▶ Make certain that the power cords of small appliances do not come in contact with or get caught in the oven door.

▶ Use only dry, heat resistant potholders. Moist or damp potholders used on hot surfaces may result in steam burns. Do not let potholders come in contact with oils. Do not substitute towels or other bulky items for potholders.

▶ It is recommended to cover all cooked food that is left in the oven to be kept warm. This will prevent moisture from condensing on the interior of the oven.

▶ Be careful when using alcoholic beverages like rum, whiskey, wine etc. for baking or roasting. The alcohol evaporates at high temperatures but may in rare circumstances combust on the hot heating elements.

SAVE THESE INSTRUCTIONS AND REVIEW THEM PERIODICALLY

Guide to the oven

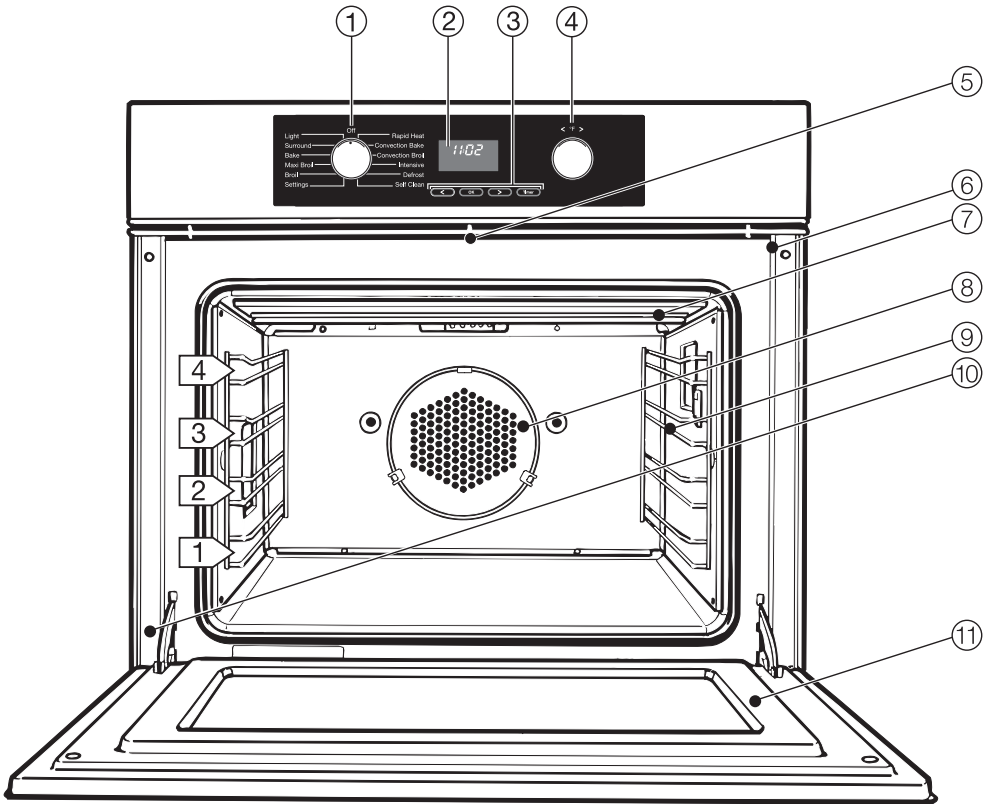

- ① Function selector
- ② Display
- ③ Touch controls "<", "OK", ">", "Timer"
- ④ Temperature selector
- ⑤ Self Clean door lock
- ⑥ Door contact switch *
- ⑦ Upper heating element
- ⑧ Convection fan
- ⑨ Non-tip, four level runners
- ⑩ Data plate
- ⑪ Oven door

* This switch shuts off the heating element and convection fan when the door is opened during use.

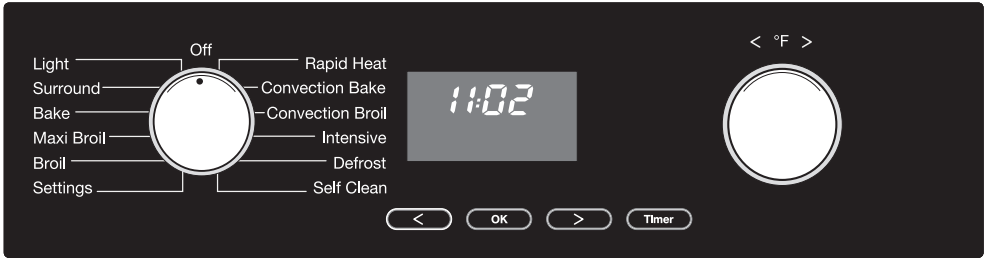

Function selector

The left-hand selector is used to select the function.

It can be turned clockwise or counter clockwise.

- Rapid Heat
- Convection Bake
- Convection Broil
- Intensive
- Defrost
- Surround
- Bake
- Maxi Broil
- Broil
- Self Clean
For cleaning the appliance automatically.
- Light
For switching on the oven light independently. This can be useful when cleaning the oven.
- Settings
For altering the settings of the appliance.

Temperature selector

The right-hand selector < °F > is used to

- select the temperature.
- enter times (as an alternative to using the < or > touch controls).

It can be turned clockwise to increase the value or counter clockwise to reduce the value.

The temperature can be displayed in °F or °C, see "Settings - P 7".

Guide to the display

Touch controls

The oven is operated by electronic touch controls. Every touch of the controls is confirmed by a tone.

The tone can be turned off.

See "Settings - P 4".

	Use
OK	<ul style="list-style-type: none">– For calling up the functions in the display. Triangle ▲ will appear in the display.– For confirming an entry.
>	<ul style="list-style-type: none">– For moving triangle ▲ in the display to the right.– For increasing time entries.
<	<ul style="list-style-type: none">– For moving triangle ▲ in the display to the left.– For decreasing time entries.
Timer	<ul style="list-style-type: none">– For setting a timer independent of an oven function, e.g. for boiling eggs.







The following will change each time "<" or ">" is touched

- Duration "☺" and End time "☺" in increments of a minute,
- the Timer "⏰" at first in increments of 5 seconds and then in increments of a minute.

Touching the control for longer, speeds up the change in the display.

Display

Depending on the position of the function selector and/or touching of a control, the following symbols appear:

-  Temperature
-  Time of day
-  Duration
-  End time
-  System lock
-  Temperature indicator
-  Timer
- h Hours
- min Minutes



Triangle ▲ in the display

When a control is touched, the **symbols of functions** which can be altered will light up in the display. These will vary depending on program.

Touch the "<" or ">" control repeatedly until triangle ▲ is underneath the symbol of the required function.



Then select the function using the "OK" control.

Triangle ▲ will flash for approx. 15 seconds.

You can only make entries with the "<" or ">" controls while the triangle ▲ is flashing. If the triangle has stopped flashing, you will need to select the function again with the "OK" control.

Oven accessories

Roasting pan, wire rack

The oven comes equipped with a roasting pan and wire racks. These pieces are to be slid into the runners on either side of the oven.

The roasting pan is ideal for catching drippings from meat or poultry roasted or broiled directly on the rack. It can also be used as a baking tray.

Roasting pan and wire racks are coated with PerfectClean and can be easily cleaned with a sponge and dish soap.

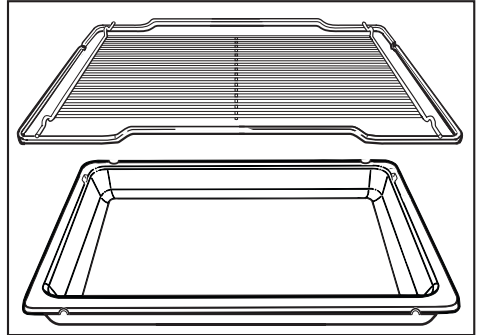

Non-tip safety notches

Wire racks and roasting pan are equipped with non-tip safety notches (see arrows) which prevent them from being pulled out completely while the oven is in use.

When inserting a rack or pan always check that the safety notches are at the rear of the oven.

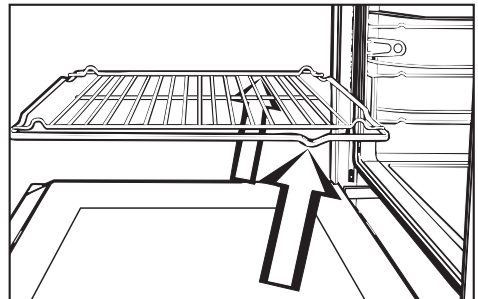

Once inserted into the oven these pieces can only be removed by raising the piece upwards and then pulling it out.

Slide opener

The slide opener is used to remove the light cover when changing a light bulb.

The flat end of the slide opener is wedged beneath the light cover to pry it off.

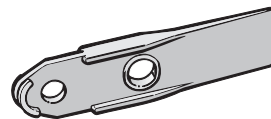

System lock

The oven is supplied with this setting deactivated as standard.
To use it you first have to activate it.

The system lock can be activated to prevent children from operating the oven or to conserve standby power when the oven will not be used for some time (e.g. vacation).

- Turn the function selector to "Off".
- Continue touching the ">" control until the triangle ▲ is below the "🔒" symbol.
- Touch the "OK" control.
- As long as the triangle ▲ below the "🔒" symbol is flashing, you can use the "<" or ">" control to toggle between "0" and "1".
 - "0" The system lock is deactivated.
 - "1" The system lock is activated.
- Touch the "OK" control to confirm.

The symbol "🔒" acts as a reminder that the lock is activated.

The oven will remain locked after a power failure.

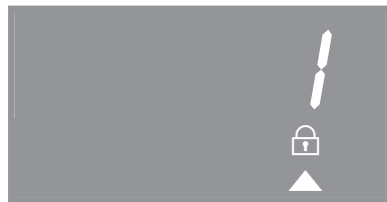
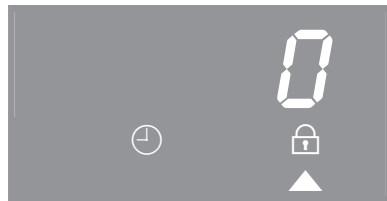

Settings

The default oven settings can be changed in the function "Settings". In this function you can customize the oven to suit your preferences.

Setting	Status (* Factory setting)	
<i>P 1</i> Time display	<i>5 0</i> <i>5 1*</i>	The time display is turned off . The display is dark when the function selector is in the "Off" position. The time runs in the background. The time display is turned on and visible.
<i>P 2</i> Duration signal tone	<i>5 0</i> <i>5 1*</i> (long) <i>5 2</i> (short)	When a set duration time expires, no signal sounds . When a set duration time expires, a signal sounds . You can choose between two signal sounds.
<i>P 3</i> Timer signal tone	<i>5 0</i> <i>5 1*</i> (long) <i>5 2</i> (short)	When the timed period ends, no signal sounds . When the timed period ends, a signal sounds . You can choose between two signal sounds.
<i>P 4</i> Key tone	<i>5 0</i> <i>5 1*</i>	The key tone is turned off . The key tone is turned on .
<i>P 5</i> Volume signal tones	<i>5 0* - 5 30</i>	If the settings " <i>P 2 - 5 2</i> " and " <i>P 3 - 5 2</i> " are selected the volume of the short signal tones can be adjusted using <i>5 0* - 5 30</i> . If the settings " <i>P 2 - 5 1</i> " and " <i>P 3 - 5 1</i> " are selected the volume of the long signal tone cannot be changed.
<i>P 6</i> Time format	<i>12*</i> <i>24</i>	The current time appears as a 12 hour display . The current time appears as a 24 hour display .
<i>P 7</i> Temperature unit	<i>°F*</i> <i>°C</i>	Temperature is displayed in °F . Temperature is displayed in °C .

Changing the status of a setting

- Select "Settings".

"P 1" appears in the display.

The settings "P 1" to "P 7" can be changed individually (see table).



- Continue touching the "<" or ">" control until the desired setting number appears in the display.

- Touch the "OK" control.

The current status of the setting "5" (example) appears in the display.

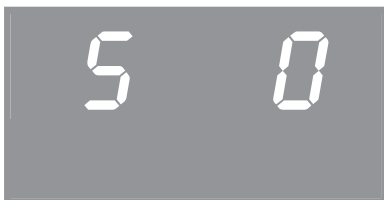

- Use the "<" or ">" control to change the setting status (see table).

- Touch the "OK" control to confirm.

The status change is stored in memory.

"P" and the number of the setting appear again in the display.

Other settings can also be changed at this time as long as the function selector is not turned to "Off".

The settings will remain saved in the case of a power failure.

Before using the oven

To set the time of day for the first time

Before the oven can be used, you will need to set the time of day.

The time can only be entered when the function selector is at "Off".

In the display:

- the clock symbol "⌚" will light up,
- the time and the triangle ▲ underneath the "⌚" symbol will start flashing.

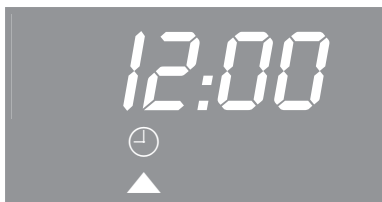

- Use the temperature selector or the "<" or ">" controls to enter the hour first.
- Touch the "OK" control to confirm the hour.

Next the minutes will begin to flash.

- Now use the temperature selector or the "<" or ">" controls to enter the minutes.
- Touch the "OK" control to confirm the minutes.

The time of day you have selected has now been entered.

Heat the oven

New ovens may have a slight odor during the first few uses. To eliminate the odor quickly, the oven should be operated at a high temperature for 2 hours.

Before heating the oven for the first time remove (if present)

- any stickers from the baking tray, roasting pan or interior floor.
- foil from the appliance front.

Make sure the room is well ventilated during this process.

- Remove all accessories from the oven.
- Turn the function selector to "Convection Bake".

The recommended temperature of 325 °F (160 °C) will appear.

- Use the temperature selector to set the highest temperature (500 °F/250 °C).

The oven will start heating up as soon as this entry has been accepted.

- Heat the empty oven for 2 hours.

The timer can be used to set the duration, see "Operation - Duration".

- **Once the oven has cooled**, wipe out the oven with hot water and a mild detergent and then dry it thoroughly with a soft clean cloth.

Leave the oven door open until the oven interior is completely dry.





Operation

Selecting a function

- Place the food in the oven.
- Select the function you want (e.g. Convection Bake) with function selector.

The following will appear in the display:

- "325" ("160") - the recommended temperature,
- the temperature indicator ,
- the triangle  under the  symbol.

At the same time the oven compartment heating, lighting and cooling fan will switch on.

You can follow the temperature rising in the display. A buzzer will sound when the set temperature is reached for the first time.

- At the end of the program turn the function selector to "Off" and remove the food from the oven.



Cooling system

The cooling fan will continue to run for a while after the oven has been switched off to prevent any humidity from building up in the oven, on the control panel or on the oven housing unit.

When the temperature in the oven has fallen sufficiently the cooling fan will switch off automatically.

Adjusting the oven temperature

As soon as a cooking function is selected, the **recommended temperature** will appear in the display.

If your recipe requires a temperature which is different from the recommended temperature you can use the temperature selector to change it within the given range. The temperature can be changed in increments of 5 °.

Function	°F		°C	
	default	range	default	range
Rapid Heat	325 °F	125-500 °F	160 °C	50-260 °C
Convection Bake	325 °F	125-500 °F	160 °C	50-260 °C
Intensive	325 °F	200-500 °F	160 °C	100-260 °C
Surround	375 °F	125-550 °F	190 °C	50-290 °C
Bake	375 °F	200-500 °F	190 °C	100-260 °C
Broil	500 °F	400-575 °F	260 °C	200-300 °C
Maxi Broil	500 °F	400-575 °F	260 °C	200-300 °C
Convection Broil	400 °F	200-500 °F	200 °C	100-260 °C
Defrost	Time of day	—	Time of day	—

Temperature indicator

The **temperature indicator**  will appear next to the temperature in the display. The indicator light is always on when the heating is on.

When the set temperature is reached,

- the temperature indicator light goes out.
- a buzzer will sound.

However, if the temperature falls below the set temperature, the oven heating and the temperature indicator light will switch on again.

Operation

Pre-heating, "Rapid Heat" function

For proper cooking results, most recipes call for a preheated oven.

After a temperature has been selected, the rising temperature can be viewed in the display.

To pre-heat the oven:

- Select "Rapid Heat" and set a temperature.
- When the temperature indicator  goes out for the first time, set the oven function you require for continued cooking or baking, and place the food in the oven.

Do not use "Rapid Heat" to pre-heat the oven when baking pizzas or biscuits and small cakes. They will brown too quickly.

Delay Start /

This option allows you to turn cooking processes automatically off or on and off.

The maximum duration which can be set is 12 hours.

Duration

- Place the food in the oven.
- Select the required function and set the temperature.

The oven heating, lighting and cooling fan will switch on.

- Touch the ">" control repeatedly until triangle ▲ is underneath the "" (Duration) symbol.

"0:00" appears in the display.

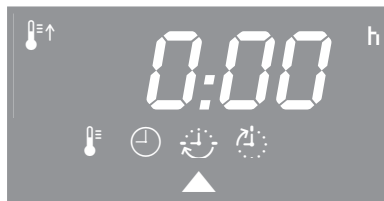

- Touch the "OK" control.
- Whilst triangle ▲ is flashing, enter the required duration in hours and minutes with the temperature selector or the ">" control.

If no other symbol is selected, the cooking duration will be seen counting down in the display.

Operation

End time

The desired end time allows you to set the actual time you would like cooking to complete.

For example:

The time now is 10:45;
you want a dish with a cooking duration of 90 minutes to be ready at 1:30.

- Place the food in the oven.
- Select the required function and set the temperature.

The oven heating, lighting and cooling fan will switch on.

First **enter the cooking duration**:

- Touch the ">" control repeatedly until triangle ▲ is underneath the "⌚" (Duration) symbol.

"0:00" appears in the display.

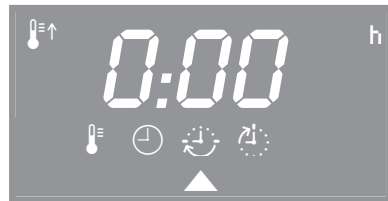

- Touch the "OK" control.
- Whilst triangle ▲ is flashing, enter the required duration in hours and minutes (1:30) with the temperature selector or the ">" control.

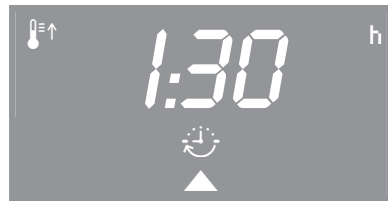

Now set the **end time**:

- Touch the ">" control repeatedly until triangle ▲ is underneath the "⌚" (End time) symbol.

The time of day plus the cooking duration entered appear in the display (10:45 + 1:30 = 12:15).

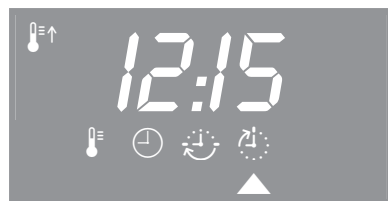

The oven heating, lighting and cooling fan will switch off.

The End time will now show in the display as long as the triangle is not moved to under another symbol.

- Use the temperature selector or the ">" control to set the end time to 1:30.

As soon as the start time (1:30 - 1:30 = 12:00) is reached, the oven heating, lighting and cooling fan will switch on.



At the end of cooking

- the oven heating switches off automatically.
- the cooling fan will continue to run for a while.
- the "🕒:" symbol (End time) will start flashing.
- a buzzer will sound, if the buzzer is switched on (see "Settings - P 2"). The tone will sound again twice at 5 second intervals.

- Turn the function selector to "Off".

The buzzer will stop and the symbols in the display will go out.

- Remove the food from the oven.

Operation

To check and change an entered time

It is possible to check or change times entered for a cooking program at any time by calling up the relevant symbol with the "<" or ">" controls.

To change the time, touch the "OK" control and whilst triangle ▲ is flashing, change the entry with the temperature selector or the "<" or ">" control.

To delete an entered time

- Set the duration to "0:00" or turn the function selector to "Off".

If there is a power failure, all data entered will be deleted.

Setting the timer

The timer can be used to time any activity in the kitchen and can be set independently of a cooking function.

A maximum time of 99 minutes and 59 seconds can be selected.

To set a timer:

- Touch the "Timer" control.

"0:00" appears in the display and the "🔔" symbol flashes.

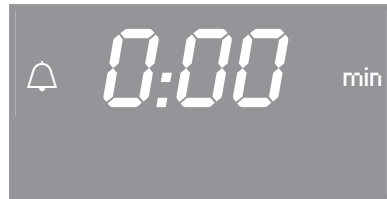

- Use the temperature selector or the ">" control to enter the desired time in minutes and seconds.
- Confirm with the "OK" control.

The count down of the timer is shown in the display, as long as no other function is chosen.

At the end of the timed period

- the "🔔" symbol will flash.
- a buzzer will sound, if the buzzer is switched on (see "Settings - P 3"). The buzzer will sound again two more times at 5 second intervals.
- at the end of the timed period, the display will show the timer counting upwards.

- Touch the "OK" control.

To cancel the timer

- Touch the "Timer" control.
- Use the temperature selector or the "<" control to set the timer to "0:00".

Setting the clock

- Turn the function selector to "Off".
- Touch the "OK" control twice.
- Use the temperature selector or the "<" or ">" control to enter the hour first of all.
- Touch the "OK" control.
- Now use the temperature selector or the "<" or ">" control to enter the minutes.
- Touch the "OK" control.

The time of day has been changed.

If there is a power cut, the current time of day will reappear flashing once power has been restored. Touch the "OK" control to confirm.

The appliance will store this data for approx. 24 hours. After 24 hours it will show "12:00" and will need to be re-set.



Guide to the functions

Baking

Baking functions

For baking you can use:

- Surround
- Bake
- Convention Bake
- Intensive

Baking tips

The roasting pan does not need to be greased or covered with parchment paper. The PerfectClean enamel finish prevents spillovers from baking onto and into the surface. Baked food can be easily removed.

Use baking parchment only for dough with a high egg white content, i.e. for biscuit, meringue or macaroons.

Do not use "Rapid Heat" to pre-heat the oven when baking pizzas or biscuits and small cakes. They will brown too quickly.

Surround

Default temperature . . . 375 °F (190 °C)

The "Surround" function is a premium conventional baking mode. The oven heats with both the upper and lower heating elements without the convection fan.

Use this function for:

- souffles, meringues,
- angel food cakes,
- cream puffs,
- cookies, cakes,
- cheesecakes,
- pies, quiche,
- baked potatoes.

The recommended positions are the 1st or 2nd runners from the bottom.

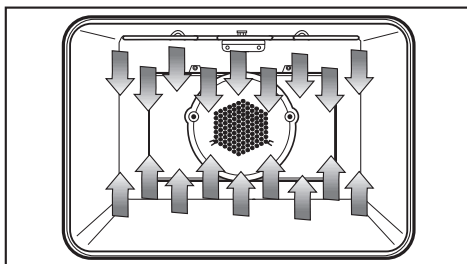

Baking

Bake

Default temperature . . . 375 °F (190 °C)

The "Bake" function works by heating food from below. This is similar to the "bake mode" of a conventional oven.

Use this function for:

- boxed cake mixes,
- baked apples,
- frozen dinners.

The recommended positions are the 1st or 2nd runners from the bottom.

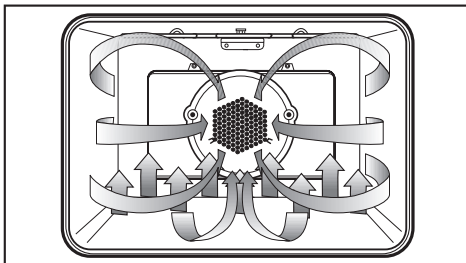

Convection Bake

Default temperature . . . 325 °F (160 °C)

This function actively circulates heated air throughout the oven cavity for a consistent baking temperature.

Use this function for:

- cookies, cakes,
- quick breads,
- yeast breads,
- cheesecakes,
- pies, quiche,
- baked potatoes,
- casseroles.

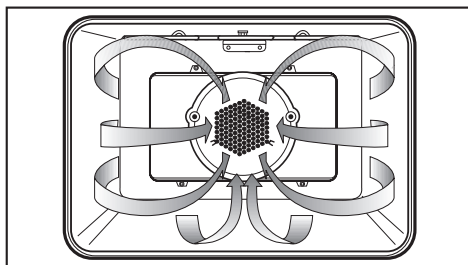

When using the convection function, several runner levels can be used at the same time.

The recommended positions are:

1 tray = 1st runner from the bottom

2 trays = 1st and 3rd runners
from the bottom

3 trays = 1st, 2nd and 4th runners
from the bottom

When baking 3 trays of cookies or small cakes at the same time, remove the respective tray when the desired browning is reached.

As a general rule, the temperature of a recipe not designed for baking in a convection oven should be lowered by 25 °F (15 °C.)

Baking

Intensive

Default temperature . . . 325 °F (160 °C)

The "Intensive" function generates heat from the lower heating element. The oven's fan gently circulates the heated air to create a brick oven (convection) environment.

Use this function for:

- pizza,
- focaccia,
- stromboli.

Use the 1st runner from the bottom.
Should the bottom of the food burn,
raise the rack to a higher runner.

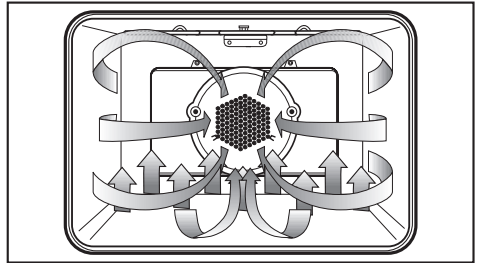

When using "Intensive", recipe temperatures should be lowered by 25 °F (15 °C).

Intensive is not recommended for roasting or shallow baking.

Do not bake on the oven floor.

Roasting functions

For baking you can use:

- Convention Bake
- Surround

Roasting tips

- The larger the cut of meat to be roasted, the lower the temperature should be.
The roasting process will take a little longer, but the meat will be cooked evenly and the outside will become crisp.

Roasting in a covered pot

When roasting in a covered pot, increase the recipe temperature by 70 °F (20 °C).

Season the meat and place it in the pot. Add some butter, margarine or a little oil and about ½ cup of water when roasting a large piece of meat or roasting poultry with a high fat content.

Roasting on the rack

Use the rack with the roasting pan inserted below. Add a little oil to very lean meat or place a few strips of bacon on top to help retain moisture. Place a little water in the roasting pan below the meat to catch drippings.

Roasting poultry

For crispy skin, baste the poultry ten minutes before the end of cooking with salt water.

Roasting

Convection Bake

Default temperature . . . 325 °F (160 °C)

This function can also be used for roasting.

It actively circulates heated air throughout the oven cavity for a consistent baking temperature.

Use this function for:

- poultry (whole birds),
- roasts, e.g. prime rib, pork loin, beef tenderloin, leg of lamb, etc.
- chicken pieces,
- small cuts of meat,
- fish,
- salmon, lobster tails,
- meat loaf.

The recommended position is the 1st runner from the bottom.

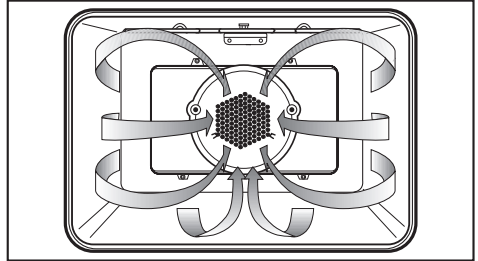

Surround

Default temperature . . . 375 °F (190 °C)

"Surround" is a conventional roasting program for traditional recipes.

Use this function for:

- pot roast,
- brisket,
- stew.

The recommended position is the 2nd runner from the bottom.

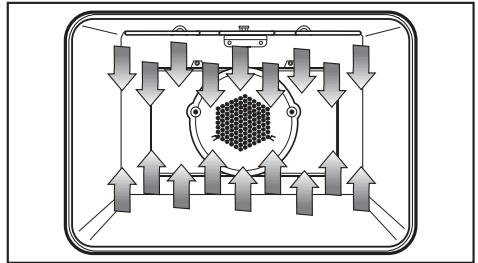

Broiling

Broiling functions

For broiling you can use:

- Broil
- Maxi Broil
- Convection Broil

Broiling tips

- To ensure even cooking, it is best to broil foods of a similar thickness at the same time. Most items should be turned halfway through broiling.
- To determine how far through a thick piece of meat has been cooked, press down on its surface with a spoon.

If the surface presses down easily and with little resistance to the spoon, it is "rare".

If there is some resistance, it is "medium".

If there is great resistance, it is "well done".

Broil

Default temperature . . . 500 °F (260 °C)

Only the inner part of the upper heating element is used for a smaller area of intense heat from above. This function is excellent for broiling or searing small quantities.

Use this function for:

- chops, ribs,
- small quantities of meat,
- browning small dishes.

The recommended position is the 3^d runner from the bottom.

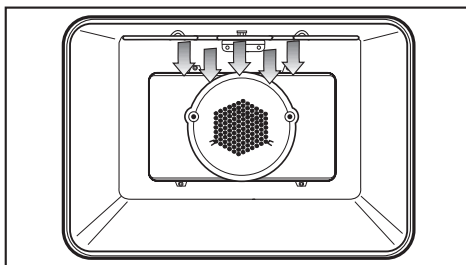

Broiling

Maxi Broil

Default temperature . . . 500 °F (260 °C)

The entire upper heating element is used for intense heating from above. This function gives excellent browning and searing results.

Use this function for:

- chops, ribs,
- large quantities of meat,
- browning large dishes.

The recommended position is the 3rd runner from the bottom.

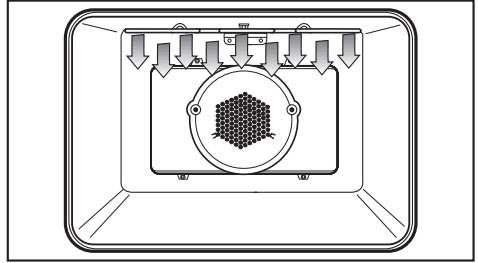

Convection Broil

Default temperature . . . 400 °F (200 °C)

Hot air from the upper heating element is distributed over the food by the fan. This enables a lower temperature than conventional broiling to be used.

Use this function for:

- thick pieces of meat,
- London broil.

The recommended position is the 1st runner from the bottom.

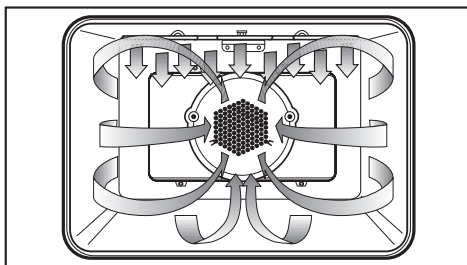

Dehydrate

You can use "Convection Bake" with a temperature of 175 °F (80 °C) for dehydrating fruits, vegetables and herbs.

A consistent low temperature and the fan maintain the ideal conditions for the long dehydration process.

For best results, blot food with a paper towel before dehydrating.

Foods to be dehydrated should be placed directly on the oven racks or on a drying screen (not supplied with oven).

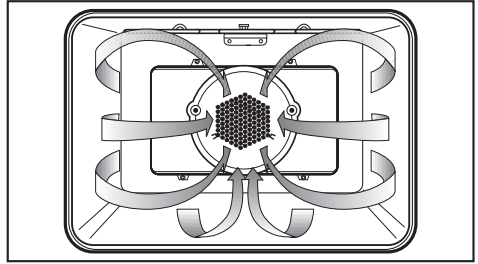

You can use "Convection Bake" with a temperature of 125 °F (50 °C)

The warm environment will allow you to effectively proof dough. The low temperature is perfect for yeast to rise.

Place the dough in a large bowl on the oven rack positioned at the lowest runner level. Keep the oven door closed during this process.

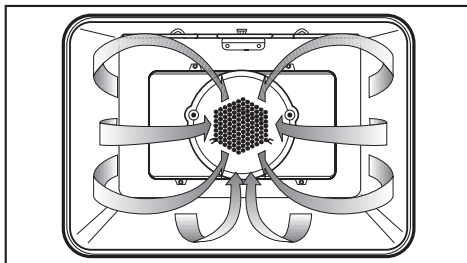

Defrost

You can use this function to defrost food at room temperature.

With selecting this function, the time of day appears in the display.

Defrosting times depend on the type and weight of the food, and at what temperature it was deep-frozen.

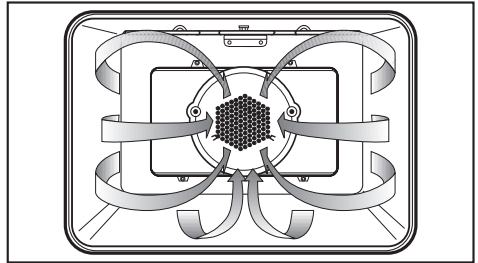

Defrosting tips

- Remove the frozen food from the packaging and place it in the roasting pan or into an appropriate dish.
- Meat and poultry should be fully thawed before cooking. Do not use the liquids from defrosting.
- Fish does not need to be fully defrosted before cooking. Defrost so that the surface is soft enough to absorb herbs and seasoning.
- Cook all food immediately after defrosting.

Front of appliance

It is best to clean spills from the front of the appliance immediately. Spills that remain longer may cause the surface to become discolored or changed.

Clean the exterior with a solution of warm water and liquid soap applied with a soft sponge. Dry with a soft cloth.

All surfaces are vulnerable to scratching. Scratches can lead to shattering of the glass surface. All surfaces can become discolored or changed if they come into contact with unsuitable cleaning agents.

Glass cleaners may be used to clean the exterior. However **do not** allow them to sit or "puddle", this can cause damage to the surface.

Remove the cleaner promptly.

To better maintain your appliance avoid the following:

- cleaners containing soda, ammonia, thinners, or chlorides
- cleaners containing descaling agents or lime removers,
- abrasive cleaners,
- stainless steel cleaners,
- dishwasher soap (powder),
- caustic (oven) cleaners,
- scouring pads, steel wool, hard brushes,
- metal scrapers.

Cleaning

PerfectClean

The revolutionary PerfectClean enamel is a smooth, nonstick surface that cleans easily with a sponge.

The following have been treated with "PerfectClean":

- roasting pan,
- wire rack.

- Do not clean items with PerfectClean in a dishwasher. Dishwasher detergents may damage the enamel.

- Clean after each use with a sponge and a solution of hot water and liquid dish soap.

- Do not use abrasive cleaners, ceramic cleaners, metal scourers, or oven cleaners on PerfectClean surfaces.

- After cleaning, rinse thoroughly with water. The water should run off the surface easily, any residue will hinder this effect.

- Stubborn baked on grease may need to be soaked first to loosen deposits.

- Clean up spills on PerfectClean surfaces as soon as possible to prevent stains.

- Spilled fruit juices may permanently discolor surfaces. This discoloration is permanent but will not affect the efficiency of the enamel.

Cleaning the oven cavity by hand

 Danger of burns! Allow the oven to cool before cleaning.

To make cleaning easier

- remove the oven door,
 - remove the runners,
 - lower the upper heating element.
- Clean the oven surfaces with a solution of hot water, liquid dish soap and a sponge or soft nylon brush.

Do not use abrasive cleaning agents, hard brushes, metal scouring pads, steel wool, knives or other abrasive materials.

Avoid cleaning the gasket around the interior (sealing the door glass pane).
It is made from glass fiber and will get damaged if rubbed or scrubbed.

Do not use oven sprays on any part of this oven.

- Dry surfaces before reassembly.

Cleaning

Removing the oven door

Please note: The oven door is quite heavy. It should be gripped firmly at the sides when being removed or refitted.

- Open the door fully.
- Flip up the locking clamps on each door hinge.

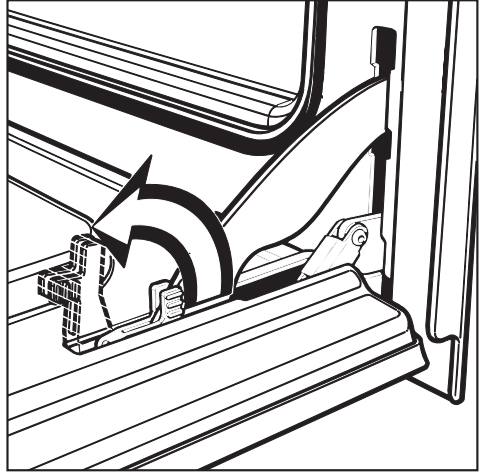

- Slowly shut the door until the protruding clamps stop the movement. Pull the door upward. See illustration.



Refitting the oven door

- Insert the door onto the hinges and open the door completely.

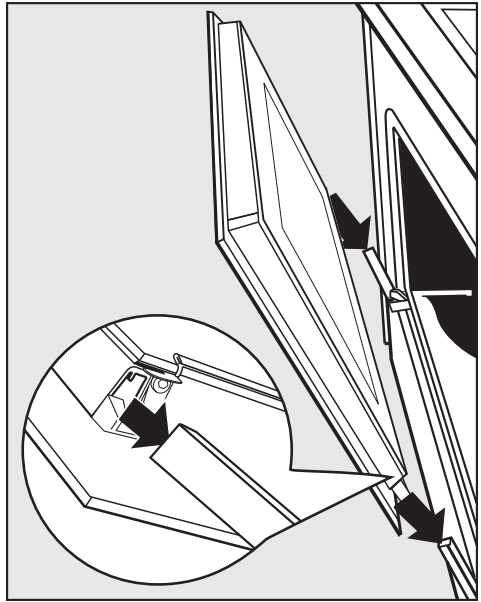

- Open the door fully.
- Flip the locking clamps down.

Be sure that the locking clamps are flipped down when the door is reinstalled. Otherwise, on closing the door, the hinges could work loose from the guide holes and cause damage.

Cleaning

Removing the runners

- Pull the runner out of the front fixing to release it.

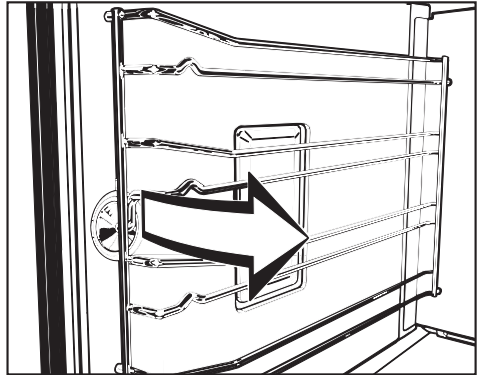

- Remove the runners by pulling them out of the rear of the oven.

Reassemble in the reverse order, ensuring all parts are correctly in place.

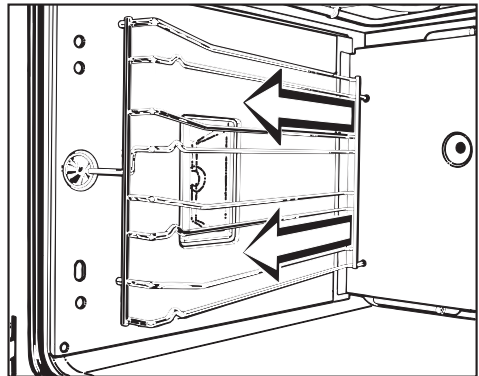

Lowering the upper heating element

- First remove the runners.
- Loosen the wing nut.
- **Gently** lower the upper heating element.

Do not use force to lower it, as this could cause damage.

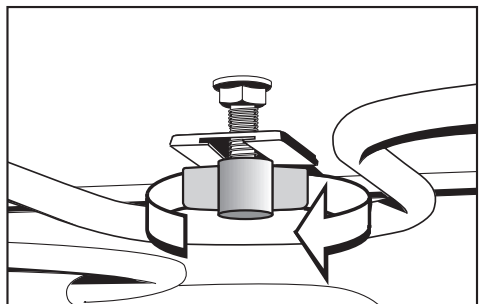

Reassemble in the reverse order, ensuring all parts are correctly in place.

"Self Clean" function

In the self cleaning function, the oven is heated to very high temperatures burning off any residue on the oven interior.

The duration of the "Self Clean" function will depend on the amount of soiling in the oven.

Depending on soiling levels you can choose between three cleaning programs:

- *P4 1* (duration 2:00 hours)
- *P4 2* (duration 2:15 hours)
- *P4 3* (duration 2:30 hours)

After the cleaning process, any burnt off debris (e.g. ash) can be easily wiped out with a damp sponge.

If the oven is not cleaned regularly, debris may become extremely difficult to remove even with the "Self Clean" function.

Spilled fruit juices may permanently discolor surfaces. This discoloration is permanent but will not affect the efficiency of the enamel.

Automatic door lock

Due to the extremely high temperatures reached in the self cleaning function, the door will lock automatically after the first minute of the function.

The lock releases once cleaning has ended and the oven temperature has dropped below 535 °F (280 °C).

If "Self Clean" is accidentally selected, shut off the oven and wait for the oven temperature to drop and for the door lock to release.

Self Cleaning

Before starting the "Self Clean" function:

- Remove large pieces of debris and any puddles of grease from the oven interior. Debris and grease can ignite at high temperatures.
- Remove all accessories, but the side runners, from the oven. The high temperatures of this function will damage the accessories.

- Select the "Self Clean" function.

PY 1 will appear in the display. The number will start flashing.

- Use the "<" or ">" control to scroll between *PY 1*, *2* and *3*.

- Start the "Self Clean" function with the "OK" control.

The door will lock and the heating will switch on.

The duration of the cleaning program can be seen in the display by calling up the  symbol.

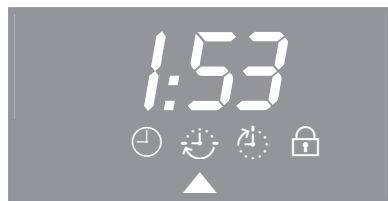
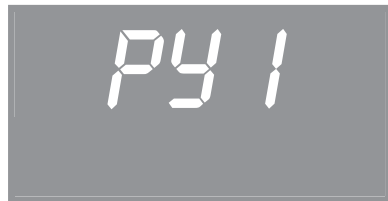

If desired, you can **set a finish time for the "Self Clean" process** during the first five minutes after starting the program. To do this:

- Call up the "🕒" symbol and use the temperature selector or the ">" control to change the end time.

You can change the end time if you wish at any time up until the program starts.

At the end of the "Self Cleaning" process

- "PYE" will appear in the display.
- the "🕒" symbol will start flashing.
- a buzzer will sound, if it is switched on (see "Settings").
- Turn the function selector to "Off".

The buzzer will stop and the symbols in the display will go out.

- **Once the oven has cooled**, remove the ash with a damp sponge.

Avoid cleaning the gasket around the interior (sealing the door glass pane).
It is made from glass fiber and will get damaged if rubbed or scrubbed.

A film may build up on the oven door. This can be removed with a shielded blade scraper or a non-abrasive sponge and a mild solution of warm water and dish soap.

The "SELF CLEAN" function will stop,

- if the function selector is turned to "Off".
- if another function is selected during the "Self Cleaning" process "PY" and "🔒" will appear in the display.
- if there is a power failure. "PY" and "🔒" will appear in the display.

Turn the function selector to "Off"
The oven door will remain locked until the oven temperature has fallen below 535 °F (280 °C).

Changing the light bulb

 To reduce the risk of electric shock, disconnect this appliance from the power supply by shutting off the power main or tripping the circuit breaker.

Changing the light bulb

- Remove the runners.
- Spread a dishtowel on the oven floor to protect the enamel, in case the light cover falls.
- Remove the lamp cover. Use the supplied slide opener to pry the lamp out of the side panel.

- Replace the halogen bulb.

Only use the following light bulb: 12 V, 10 W, 572 °F (300 °C) heat resistant, socket G4, type 64418 made by Osram.

Do not touch the new light bulb with your fingers; touching the bulb will reduce its life. Follow the bulb manufacturer's instructions.

- Press the lamp back into the sidewall of the oven and reinsert the cover.

Reassemble in the reverse order, making sure that all the parts are in place.

- Reassemble the runners.

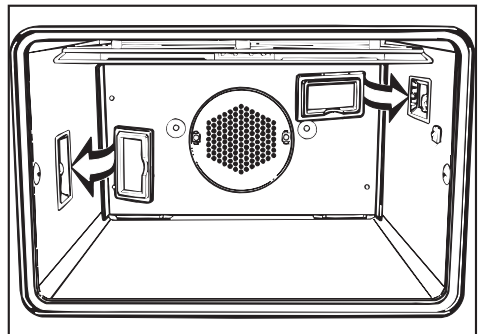
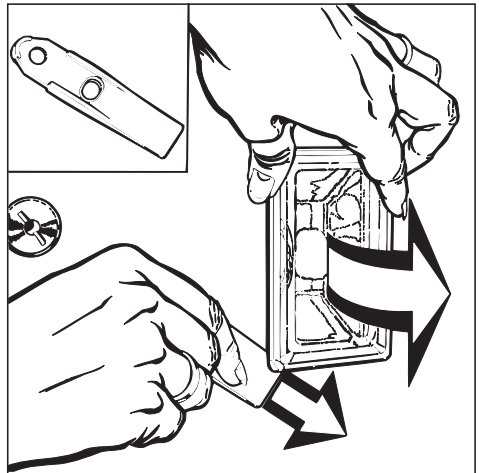

Frequently asked questions

Repairs should only be carried out by a qualified and trained person in accordance with local and national safety regulations. Unauthorized repairs could cause personal injury or machine damage.

What if the oven does not heat?

Possible fault	Solution
The system lock is activated.	Deactivate the system lock.
The circuit breaker has tripped.	Check the breaker.
The delay start has been set.	Cancel the delay start.
The door is not fully closed.	Close the door firmly.

Why is there no noise when the oven door is opened during operation?

This is normal. If the door is opened during operation, a safety contact switch causes the heating elements and the fan to shut off.

Why is a noise heard after turning the oven off?

This is normal. The fan will continue to run for a short time to cool the oven. When the oven has cooled sufficiently, the fan will turn off automatically.

Why is the display dark when the oven is first turned on?

Possible fault	Solution
The clock display has been turned off.	Turn the display on: Select "Settings" - "P I" - "S I".

What if the time of day cannot be entered after a power failure?

Possible fault	Solution
The system lock is activated.	Deactivate the system lock.

Why is there uneven browning?

Possible fault	Solution
Oven not preheated.	Allow the oven to preheat.
Oven temperature too high.	Lower the oven temperature.
Shiny or thin pans were used.	Use dark, matte finish pans.

What if "Fault" followed by two numbers appears in the display?

Possible fault	Solution
An electronic fault has occurred.	Call Technical Service for assistance.
"Fault 55": the oven has shut down.	Turn off the oven to reset it to normal operation.

Technical Service

In the event of a fault which you cannot easily fix yourself, please contact the Miele Technical Service Department:

USA 1-800-999-1360
techserv@mieleusa.com

CDN 1-800-565-6435
service@miele.ca

When contacting Technical Service please quote the serial number and model of your oven. This information is visible on the silver data plate.

MieleCare

(USA only)

MieleCare, our Extended Service Contract program, gives you the assurance of knowing that your appliance investment is covered by 5 years of worry free ownership. *MieleCare* is the only Extended Service Contract in the industry that guarantees repairs by a Miele Authorized Service Provider using genuine Miele parts. Only genuine Miele parts installed by factory trained professionals can guarantee the safety, reliability, and longevity of your Miele appliance.

Please note that unless expressly approved in writing by Miele's Service department, Extended Service Contracts offered by other providers for Miele products will not be recognized by Miele. Our goal here is to prevent unauthorized (and untrained) service personnel from working on your Miele products, possibly doing further damage to them, you and/or your home.

To learn more about *MieleCare* Extended Service Contracts, please contact your appliance dealer or visit us online at:

<http://mieleusa.com/mielecare>

The following accessories are available for purchase from your Local Miele Dealer or from Miele.

Gourmet Pizza form

This circular form is suitable for cooking fresh or frozen pizzas, flat cakes, tarts, and baked desserts.



Gourmet Baking stone

The Baking stone is ideal for baking dishes with a crisp bottom like pizza and bread.

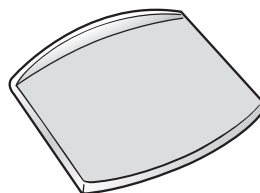

Gourmet Casserole Dish

The Gourmet Casserole can be set on the wire rack.

The casserole has a special non-stick coating and is available in two sizes (large: HUB 61-35, small HUB 61-22).

A lid is also available separately.

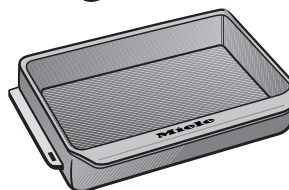
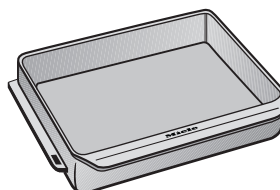

Optional accessories

Gourmet Casserole Dish Lid

The lid is available in two sizes (large: HBD 60-35, small HBD 60-22).

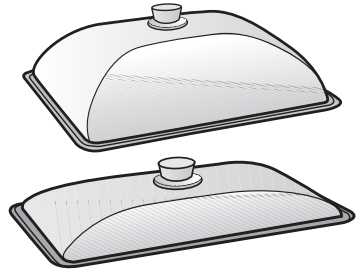

Anti-splash insert

The anti-splash insert may be placed in the roasting pan to reduce splattering of drippings from meat or poultry.

The anti-splash insert is coated with PerfectClean enamel and can be easily cleaned with a sponge and dish soap.

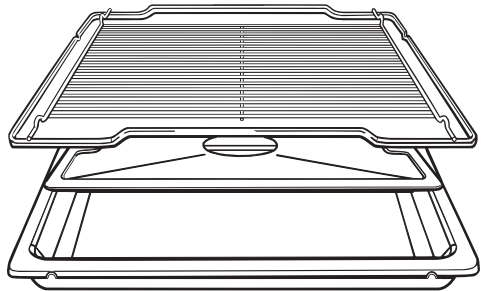

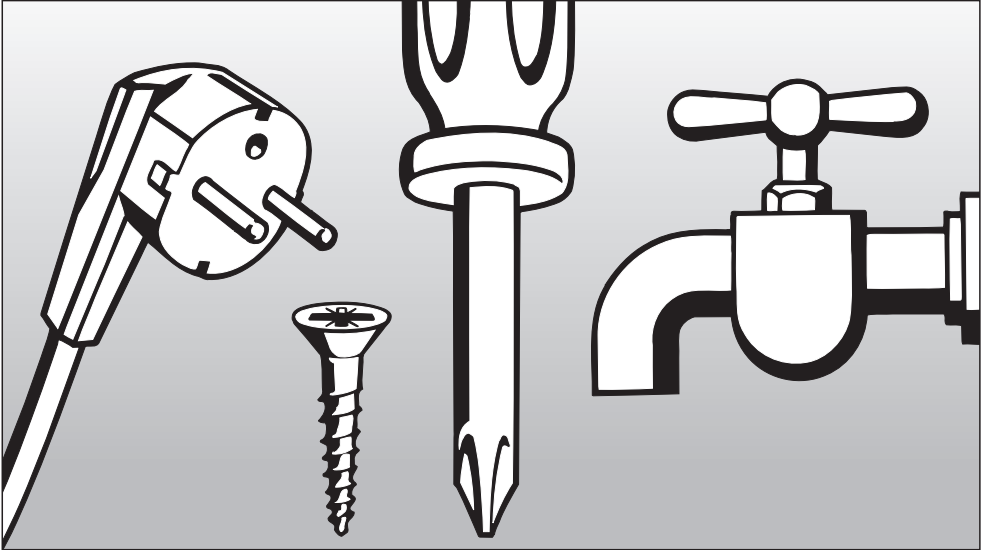

Installation Instructions

Information is subject to change. Please refer to our website to obtain the most current product specification, technical & warranty information.

Caring for the environment

Disposal of the packing materials

The cardboard box and packing materials protect the appliance during shipping. They have been designed to be biodegradable and recyclable.

Ensure that any plastic wrappings, bags, etc. are disposed of safely and kept out of the reach of children.
Danger of suffocation!

Disposal of an old appliance

Old appliances may contain materials that can be recycled. Please contact your local recycling authority about the possibility of recycling these materials.

Ensure the appliance presents no danger to children while being stored for disposal. Before discarding an old appliance, unplug it from the outlet and cut off its power cord. Remove any doors to prevent trapping hazards.

⚠ CAUTION: Before servicing, disconnect the power supply by either removing the fuse, shutting off the power main or manually "tripping" the circuit breaker.

Installation work and repairs should only be performed by a qualified technician in accordance with all applicable codes and standards. Repairs and service by unqualified persons could be dangerous.

Before connecting the appliance to the power supply, make sure that the voltage and frequency listed on the data plate correspond with the household electrical supply. This data must correspond to prevent machine damage. Consult an electrician if in doubt.

Only operate the appliance after it has been installed into cabinetry.

The plug must be plugged into an appropriate outlet that is installed and grounded in accordance with all local codes and ordinances.

Data plate

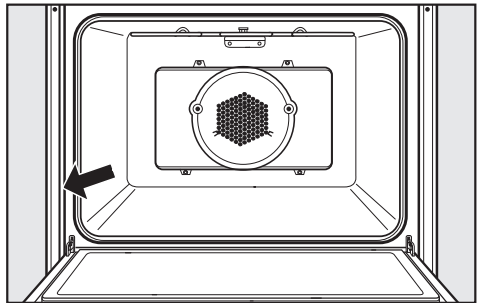

The silver data plate is located along the front side of the oven (door open).

Power supply

The oven comes equipped with a 7.2 ft. (2.2 m) power cord with a NEMA 14-30 P molded plug ready for connection to a:

120/240 V, 20 A, 60 Hz power supply.

or

120/208 V, 20 A, 60 Hz power supply.

WARNING: THIS APPLIANCE MUST BE GROUNDED

Installer:

Please leave these instructions with the consumer.

Appliance and Cut-out Dimensions

Miele appliances can be installed flush or proud. Discuss your installation requirements with your architect, designer and installer.

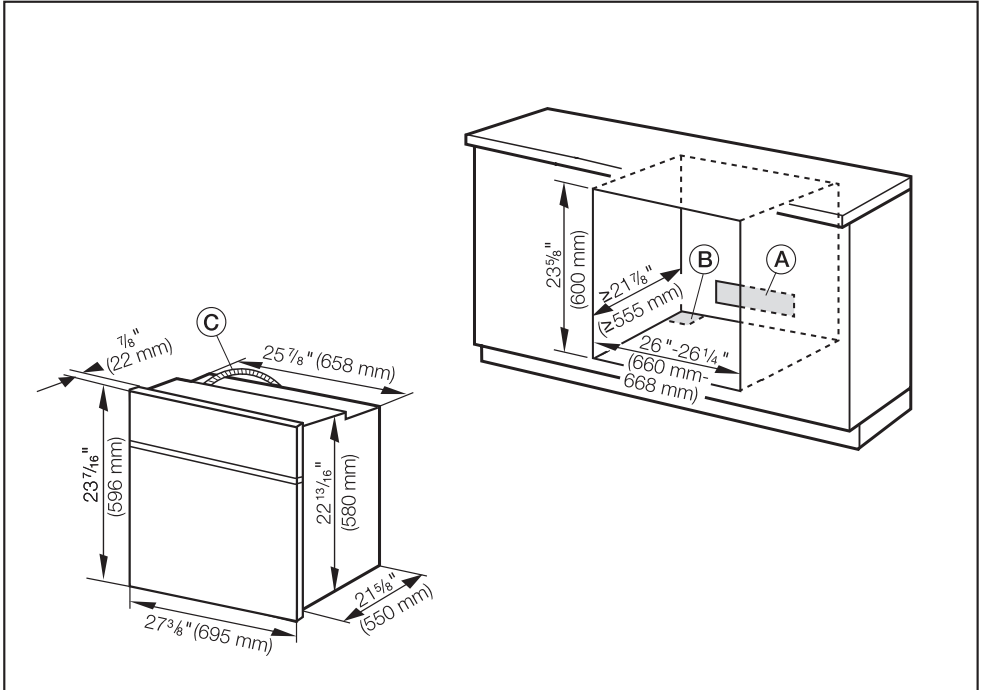

Appliance and Cut-out Dimensions

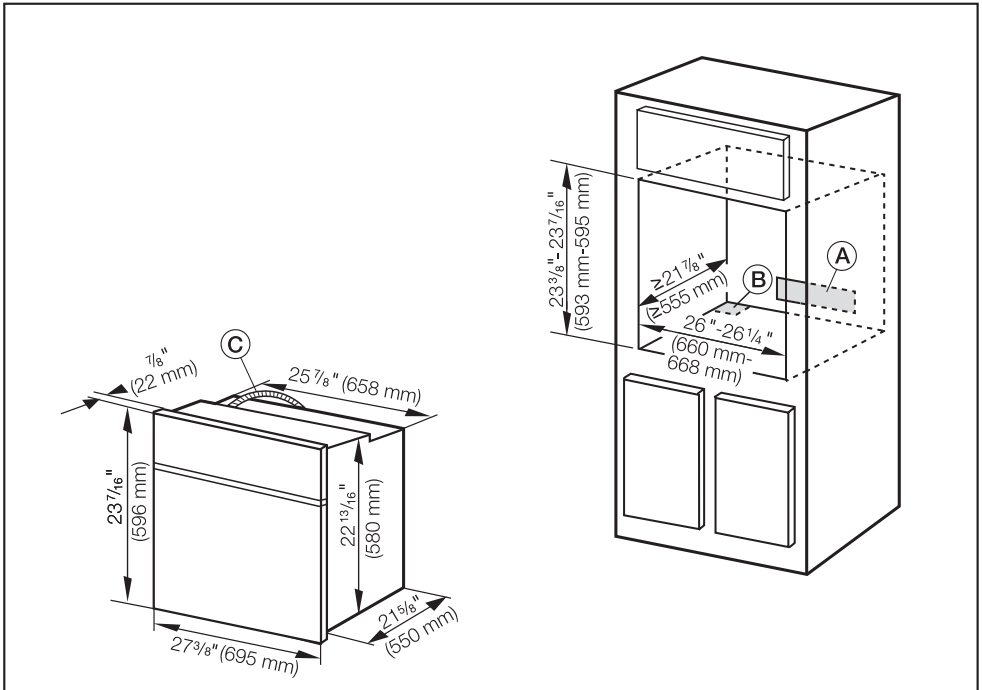

- Ⓐ Vent cut-out (min. $24" \times 150 \text{ cm}^2$) possible at rear of cabinet
- Ⓑ Cut-out for power cord (min. $4" \times 10 \text{ cm}^2$)
- Ⓒ Power cord

For the most current specifications see the Miele web site.

Installing the oven

The oven must be installed into cabinetry before use.

Do not insulate the cabinet. This will prevent proper ventilation.

IMPORTANT INFORMATION

Certain cabinet materials and finishes are very sensitive to high temperatures. To eliminate the risk of damage to surrounding cabinets, a 24 square inch (2"x12") [150 cm²] minimum opening must exist in the cabinet to allow air to flow into and around the appliance. In addition, the oven vent at the bottom of the door must not be obstructed.

- Connect the oven to the electrical supply.

The oven must be supported from underneath.

- Place the oven into the cabinet as far as the oven trim and align.
- Open the oven door and locate the two mounting screw holes in the oven frame. Mark and drill 6 mm pilot holes. Secure the oven to the cabinetry by inserting screws through the frame and into the cabinetry.

Only operate the appliance after it has been installed into the cabinetry.

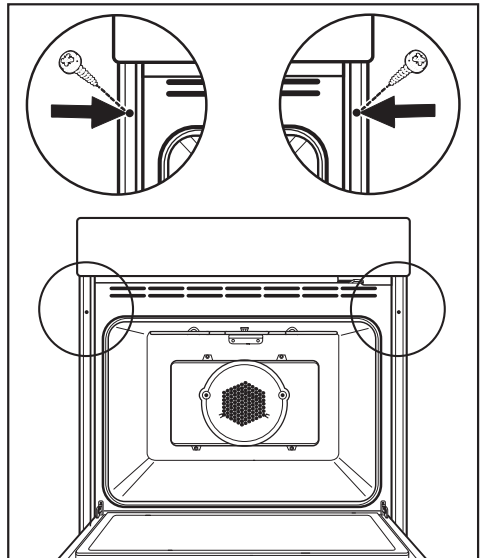

Set the time

Before the oven can be used, you will need to set the time of day.

The time can only be entered when the function selector is at "Off".

In the display:

- the clock symbol "⌚" will light up,
- and the time and the triangle ▲ underneath the "⌚" symbol will start flashing.
- Use the temperature selector or the "<" or ">" control to enter the hour first.
- Touch the "OK" control to confirm the hour.

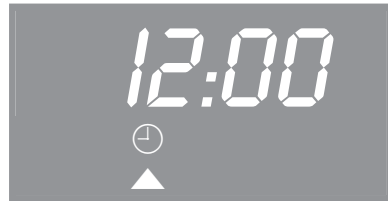

Next the minutes will begin to flash.

- Now use the temperature selector or the "<" or ">" control to enter the minutes.
- Touch the "OK" control to confirm the minutes.

The time of day you have selected has now been entered.

Please have the model and serial number of your appliance available before contacting Technical Service.



U.S.A. Miele, Inc.

National Headquarters

9 Independence Way
Princeton, NJ 08540
Phone: 800-843-7231
609-419-9898
Fax: 609-419-4298
www.mieleusa.com

Technical Service & Support Nationwide

Phone: 800-999-1360
Fax: 888-586-8056

TechnicalService@mieleusa.com

Canada Miele Limited

Headquarters and Showroom

161 Four Valley Drive
Vaughan, ON L4K 4V8
Phone: 800-643-5381
905-660-9936
Fax: 905-532-2290
www.miele.ca
professional@miele.ca
(commercial enquiries)

MieleCare National Service

Phone: 800-565-6435
905-532-2272
Fax: 905-532-2292
customercare@miele.ca
(general and technical enquiries)

Germany

Miele & Cie. KG
Carl-Miele-Straße 29
33332 Gütersloh

Alteration rights reserved / 0212
(H 4744 BP; H 4746 BP)

M.-Nr. 07 964 080 / 01

INFORMATION IS SUBJECT TO CHANGE. PLEASE REFER TO OUR WEBSITE TO OBTAIN THE MOST CURRENT PRODUCT SPECIFICATIONS, TECHNICAL & WARRANTY INFORMATION.

Download from Www.Somanuals.com. All Manuals Search And Download.

Free Manuals Download Website

<http://myh66.com>

<http://usermanuals.us>

<http://www.somanuals.com>

<http://www.4manuals.cc>

<http://www.manual-lib.com>

<http://www.404manual.com>

<http://www.luxmanual.com>

<http://aubethermostatmanual.com>

Golf course search by state

<http://golfingnear.com>

Email search by domain

<http://emailbydomain.com>

Auto manuals search

<http://auto.somanuals.com>

TV manuals search

<http://tv.somanuals.com>