

Miele

Operating and installation instructions



Compact oven H 5081 BP



To avoid the risk of accidents or damage to the appliance it is **essential** to read these instructions before it is installed and used for the first time.



en - GB

M.-Nr. 09 270 260

Warning and Safety instructions	7
Caring for the environment	12
Guide to the machine	13
Features	14
Oven controls	14
Auto sensor	14
Safety features	14
System lock	14
Safety switch-off	14
Cooling system	14
Vented oven door	14
Door lock for pyrolytic operation	14
Energy saving features	15
User instructions	16
Moisture plus	16
"Moisture plus" recipe booklet	16
PerfectClean treated surfaces	16
Pyrolytic cleaning	16
Energy efficiency rating according to EN 50304	17
Accessories	17
Baking tray, universal tray and rack with non-tip notches	17
FlexiClip telescopic runners	18
Fitting the FlexiClip telescopic runners	18
Changing the position of the FlexiClip telescopic runners	19
Food probe	19
Opener	19
Descaling tablets, plastic tube with clip	19
Anti-splash insert (depending on model)	20
Handle (depending on model)	20
Miele@home	21
Information is displayed via:	21
Optional accessories	21
The home of the future	21
Further information	21

Contents

Controls	22
Sensors	22
Display	23
Main menu	23
Symbols	24
Functions	26
Before using for the first time	28
To enter basic settings	28
Cleaning and heating up for the first time	29
Operation	30
Automatic programmes	30
Manual operation	31
More about manual operation	32
To select a function	32
To change the temperature	32
Entering the Duration, a Start time or Finish time	33
To use Automatic switch-off	33
Delaying the start with Automatic switch-off	34
Sequence of the cooking programme when using Automatic switch-off	34
Changing or deleting an entered cooking time	35
Changing the heating-up phase	35
Pre-heating the oven	36
Activating moisture reduction	37
Change function	37
User programmes	38
The User programmes menu	38
To create a User programme	39
To call up an existing User programme	39
Moisture plus	40
Automatic programmes	41
Night baking	41
Moisture plus 	42
Number of bursts of steam and when they are injected	42
Using Moisture plus 	43

To evaporate residual moisture	44
The residual moisture evaporation process	44
To start the residual moisture evaporation process	44
To cancel the residual moisture evaporation process	45
Descaling	45
Minute minder (egg timer) 	46
Settings	47
Language 	47
Time	48
Display	48
Clock format	48
To set the time of day	48
Lighting	48
Main menu	49
Catalyser	49
Cooling fan run-on	50
Pyrolytic	50
Heating-up phase	50
Start	51
Recommended temperatures	51
Display	51
Contrast	51
Brightness	51
Volume	52
Buzzer tones	52
Frequency	52
Keypad tone	52
Safety	53
System lock 	53
In operation lock	53
Units	54
Temperature	54
Showroom programme	54
Factory default	54

Contents

Cleaning and care	55
Appliance front	55
Accessories	56
Baking tray, universal tray, anti-splash insert (if applicable)	56
Rack, runners	56
Food probe	56
FlexiClip telescopic runners	56
Lubricating the FlexiClip telescopic runners	57
PerfectClean	58
Oven interior	60
To remove the oven door.	63
To dismantle the oven door	64
To refit the door	67
To remove the FlexiClip telescopic runners	68
To remove the side runners	69
To lower the top heat/grill element.	69
Descaling.	70
When to run the descaling programme	70
Descaling process (overview)	70
Preparation	71
Start the descaling process.	71
Problem solving guide	73
After Sales / Guarantee	76
Optional accessories	77
Electrical connection	79
Building-in diagrams	80
Appliance dimensions and unit cut-out.	80
Front dimensions	81
Installing the oven	82

Warning and Safety instructions

This appliance conforms to current safety requirements. Inappropriate use can, however, lead to personal injury and damage to property.

To avoid the risk of accidents and damage to the appliance, please read these instructions carefully before using it for the first time. They contain important notes on installation, safety, use and maintenance.

Keep these instructions in a safe place and ensure that new users are familiar with the contents. Pass them on to any future owner.

Correct application

▶ This oven is not designed for commercial use. It is intended for use in domestic households and for use in similar working and residential environments such as:

- Shops
- Offices and showrooms

and by residents in establishments such as:

- Hostels and guest houses

▶ It is intended for domestic use only to cook food, and in particular to bake, roast, grill, defrost and dry food. Any other use is not supported by the manufacturer and could be dangerous. Miele cannot be held liable for damage resulting from incorrect or improper use or operation of the appliance.

▶ This appliance is not intended for use by persons (including children) with reduced physical, sensory or mental capabilities, or lack of experience and knowledge, unless they are supervised whilst using it, or have been shown how to use it correctly by a person responsible for their safety.

Safety with children

▶ This appliance is not a toy! To prevent the risk of injury or damage do not let children play with the appliance or its controls.

▶ Older children may only use the oven when its operation has been clearly explained to them and they are able to use it safely, recognising the dangers of misuse.

▶ Great care should be taken to ensure that children do not touch the appliance when it is being used. Children's skin is far more sensitive to high temperatures than that of adults. External parts of the oven such as the door glass, control panel and the vent become quite hot.

▶ The oven door gets much hotter during pyrolytic operation than during normal use.

Make sure children cannot touch the oven whilst a pyrolytic programme is running. Danger of burning.

Warning and Safety instructions

Technical safety

► Installation, maintenance and repairs may only be carried out by a suitably qualified and competent person in strict accordance with current national and local safety regulations. Repairs and other work by unqualified persons could be dangerous. The manufacturer cannot be held liable for unauthorised work.

► Before installation, check the appliance for visible signs of damage. Do not install and use a damaged appliance. A damaged appliance could be dangerous.

► The electrical safety of this appliance can only be guaranteed when continuity is complete between it and an effective earthing system. It is most important that this basic safety requirement is present and tested regularly, and where there is any doubt the household wiring system should be inspected by a qualified electrician. The manufacturer cannot be held liable for the consequences of an inadequate earthing system (e.g. electric shock).

► Before connecting the appliance, make sure that the connection data on the data plate (voltage and connected load) match the mains electricity supply. This data must correspond in order to avoid the risk of damage to the appliance. Consult a competent person if in doubt.

► Do not connect the appliance to the mains electricity supply by a multi-socket unit or an extension lead. These do not guarantee the required safety of the appliance (e.g. danger of overheating).

► For safety reasons, this appliance may only be used when it has been built in.

► Never open the housing of the appliance. Tampering with electrical connections or components and mechanical parts is highly dangerous to the user and can cause operational faults.

► While the appliance is under guarantee, repairs should only be undertaken by a service technician authorised by the manufacturer. Otherwise the guarantee will be invalidated.

Warning and Safety instructions

► During installation, maintenance and repair work, the appliance must be disconnected from the mains electricity supply. It is only completely isolated from the electricity supply when:

- the mains fuse is disconnected,
- the screw-out fuse is removed (in countries where this is applicable),
- it is switched off at the isolator.

Ensure that current is not supplied to the appliance until after maintenance or repair work has been carried out.

► Faulty components must only be replaced by genuine Miele original spare parts. The manufacturer can only guarantee the safety of the appliance when Miele replacement parts are used.

► If the supply cord is damaged, it must be replaced by a Miele approved service technician to avoid a hazard.

► This appliance may only be used in mobile installations such as ships, caravans, aircraft etc. if a risk assessment of the installation has been carried out by a suitably qualified engineer.

► In countries where there are areas which may be subject to infestation by cockroaches or other vermin, pay particular attention to keeping the appliance and its surroundings in a clean condition at all times. Any damage which may be caused by cockroaches or other vermin will not be covered by the guarantee.

Correct use

Caution. Danger of burning.
High temperatures are produced by the oven.

► Use oven gloves when placing food in the oven, turning or removing it and when adjusting oven shelves etc. in a hot oven. Be very careful that you do not burn yourself on the top heating / grill element.

► Never leave the appliance unattended when cooking with oil or fats, as these are a fire hazard if allowed to overheat.

► Do not exceed the recommended grilling times when using the "Full grill", "Economy grill" and "Fan grill" functions. Excessively long grilling times can lead to food drying out and burning, or could even cause it to catch fire.

► Do not use the "Full grill", "Economy grill" or "Fan grill" to finish baking par-cooked rolls or bread or to dry flowers or herbs. Fire hazard. Use "Fan plus" or "Conventional heat" instead.

Warning and Safety instructions

▶ If using alcohol in your recipes, high temperatures can cause the alcohol to vaporise and even to ignite on the hot heating elements.

Alcohol should be burnt off before the dish is placed in the oven to avoid this danger.

▶ Cover any food which is left in the oven to be kept hot. Any moisture in the food could lead to corrosion damage in the oven. This also prevents the food from drying out.

▶ If you wish to complete a cooking process using the residual heat in the oven, leave the oven at the function selected and select the lowest temperature for that function. Do not switch the appliance off until the food has been removed. Increased moisture in the oven could cause condensation to form which could lead to

- corrosion in the oven compartment.
- damage to the control panel, worktop and surrounding kitchen furniture.

▶ Do not line the floor of the oven with aluminium foil when using "Conventional"/ "Bottom heat" / "Intensive bake".

This would cause a build-up of heat which could cause damage to the floor of the oven.

For this reason do not place a dish, tin or baking tray directly on the oven floor.

If using a tray made by a different manufacturer, make sure that there is a gap of at least 6 cm between the bottom of the tray and the floor of the oven.

▶ Never add cold water to food on a hot universal tray, baking tray or directly onto food in a hot oven. The steam created could cause serious burns or scalding and the sudden change in temperature can damage the enamel.

▶ Always ensure that food is suitably cooked or reheated.

Some foods may contain micro-organisms which are only destroyed by thorough cooking at temperatures over 70 °C for a minimum of 10 minutes. Therefore when cooking or reheating foods, e.g. poultry, it is particularly important that food is fully cooked through. If in doubt select a longer cooking or reheating time. It is important that the heat is allowed to spread evenly throughout the food being cooked. This can be achieved by stirring and/or turning the food during cooking.

▶ If using plastic containers for cooking, they must be declared by the manufacturer as being suitable for use in an oven. Other types of plastic containers melt at high temperatures, and could damage the oven.

Warning and Safety instructions

- ▶ Do not heat up unopened tins or jars of food in the oven. Pressure can build up and they may explode, resulting in injury or damage.
- ▶ Do not push pots and pans around on the oven floor, as this could damage the surface.
- ▶ Do not lean or sit on an open oven door, or place heavy items on it. Make sure that nothing gets trapped between the door and the oven compartment. This could damage the oven. The oven door can support a maximum load of 15 kg.
- ▶ Do not use the appliance to heat up the room. Due to the high temperatures radiated, objects near the appliance could catch fire.
- ▶ Remove all accessories as well as the runners and any extra accessories such as Flexi-Clip runners from the oven interior before starting the pyrolytic cleaning process. The high temperatures needed for pyrolysis will damage the accessories.
- ▶ Only use the Miele food probe supplied with this oven. If a replacement is necessary it can be obtained from the Miele Spare Parts Department or your Miele dealer.

The manufacturer cannot be held liable for damage caused by non-compliance with these Warning and safety instructions.

Accessories

- ▶ Only use genuine Miele spare parts and accessories with this appliance. If spare parts or accessories from other manufacturers are used, this will invalidate the guarantee, and Miele cannot accept liability.

Caring for the environment

Disposal of the packing material

The transport and protective packing has been selected from materials which are environmentally friendly for disposal, and should be recycled.

Ensure that any plastic wrappings, bags, etc. are disposed of safely and kept out of the reach of babies and young children. Danger of suffocation.

Disposing of your old appliance

Electrical and electronic appliances often contain materials which, if handled or disposed of incorrectly, could be potentially hazardous to human health and to the environment. They are, however, essential for the correct functioning of your appliance. Please do not dispose of it with your household waste.

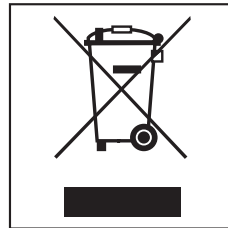

Please dispose of it at your local community waste collection / recycling centre or contact your dealer for advice. Ensure that it presents no danger to children while being stored for disposal.

H 5081 BP

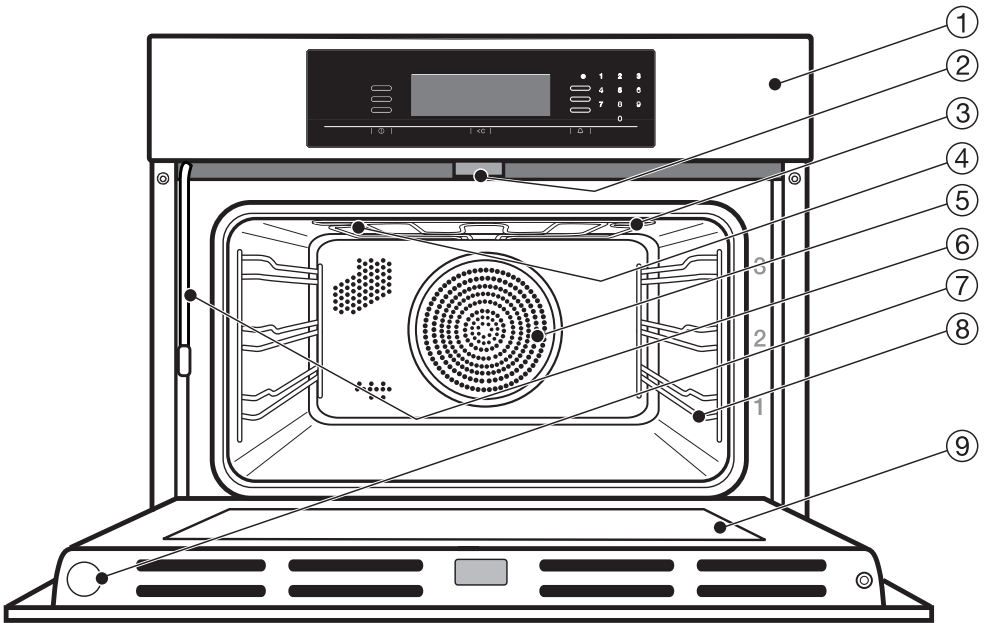

- ① Control panel
- ② Door lock for pyrolytic operation
- ③ Top heat / grill element with receiver for the wireless food probe
- ④ Steam inlets for Moisture plus
- ⑤ Back panel with air inlet for the fan
- ⑥ Water intake tube for the steam injection system
- ⑦ Wireless food probe holder
- ⑧ Side runners with three shelf levels
- ⑨ Door

Features

Oven controls

In addition to operating the various cooking programmes to bake, roast and grill, the controls also offer the following:

- a time of day display,
- a minute minder,
- a timer for programming cooking durations,
- user programmes,
- automatic programmes,
- settings that can be customised.

Auto sensor

This sensor controls

- the cooking duration of the automatic programmes. This will be indicated in the display.
- the cooling fan run-on time.
- the duration of the pyrolytic cleaning process.

Safety features

System lock

The system lock  prevents the oven from being used unintentionally by children, for example. See "Settings - Safety".

Safety switch-off

Safety switch-off is triggered automatically if the oven is operated for an unusually long period of time. The period of time will depend on the oven function selected.

Cooling system

A cooling fan will come on automatically when a cooking programme is started. The cooling fan mixes hot air from the oven cavity with cool room air before venting it out into the kitchen through vents located between the appliance door and the control panel.

The cooling fan will continue to run for a while after the oven has been switched off to prevent any humidity building up in the oven, on the control panel or on the oven housing unit.

Vented oven door

The oven door is an open system and some of the door panes have a heat-reflecting coating. During operation, cool air is passed through the oven door to keep the outer pane cool.

If necessary, the oven door can be dismantled for cleaning.

Door lock for pyrolytic operation

For safety reasons the door locks as soon as the pyrolytic cleaning programme starts. After the pyrolytic programme has finished, the door will remain locked until the temperature in the oven has dropped below 280°C.

Energy saving features

Lighting

The oven lighting is set to switch off 15 seconds after the start of a cooking programme (default setting). See "Settings - Lighting".

Door contact switch

If the oven door is opened during operation, the door contact switch automatically switches off the heating elements and the fan, if a "Fan" setting is being used. This helps reduce the amount of heat lost from the oven interior, e.g. when basting roast meat. At the same time, the oven lighting is switched on.

Using residual heat

The oven heating switches off automatically shortly before the end of a cooking programme where the cooking duration has been programmed or the food probe is being used.

The residual heat in the oven is sufficient to complete the cooking process.
"Energy save" will appear in the display.

The cooling fan continues to run, as does the hot air fan if a "Fan" setting has been chosen.

Energy save mode

The oven switches off automatically to save energy if, at the end of an Automatic programme or a cooking programme with Automatic switch-off, no other cooking function is selected within a certain time period.

This time period depends on the settings selected (cooking function, temperature, cooking duration).

Either the time of day is displayed or the display is dark: see "Settings - Time - Display".

Features

User instructions

The User instructions supplied with your appliance in addition to these Operating and installation instructions contains detailed information about the following:

- Automatic programmes
- Food probe
- Baking
- Roasting
- Slow cooking
- Grilling
- Defrosting
- Cooking ready meals
- Automatic programme recipes

Moisture plus

This function injects moisture during the cooking process, giving excellent results when cooking various types of food, such as bread or meat.

Moisture plus is activated during some Automatic programmes, and can also be used as a separate function for manually injecting bursts of steam.

"Moisture plus" recipe booklet

This separate booklet supplied with your oven in addition to these Operating and installation instructions contains recipes and information on using Automatic programmes with Moisture plus and the Moisture plus function.

PerfectClean treated surfaces

The following surfaces are all treated with a special PerfectClean finish:

- Side runners,
- Baking tray,
- Universal tray,
- Rack

PerfectClean surfaces have very good anti-stick properties and are much easier to keep clean than conventional enamel, if cleaned regularly.

The **FlexiClip telescopic runners** also have a PerfectClean finish. PerfectClean surfaces have an iridescent appearance.

See "Cleaning and care" for more information.

Pyrolytic cleaning

The oven interior can be kept clean by using the Pyrolytic function.

During the pyrolytic process the oven is heated to over 400 °C. Any residual soiling is broken down and reduced to ash by the high temperatures.

See "Cleaning and care" for more information.

Energy efficiency rating according to EN 50304

This appliance is rated energy efficiency class **A** in accordance with EN 50304.

Tests were carried out using "Fan plus " with the FlexiClip telescopic runners removed. The catalyser should be switched off during testing, see "Settings - Catalyser - Off next programme only".

Accessories

The following accessories are supplied with this oven.

These and other accessories are also available to order from the Miele Spare Parts Department, your Dealer or via the internet at www.miele-shop.com.

Baking tray, universal tray and rack with non-tip notches

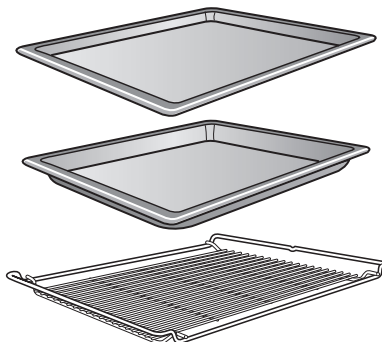

The baking tray, universal tray and rack are inserted into the oven between the two rails of a shelf runner.

The trays and rack have non-tip safety notches in the middle which prevent them being pulled right out when they only need to be partially pulled out. The trays and rack can then only be taken out of the oven by raising them upwards and then pulling them out.



If you are using a tray with the rack on top, insert the tray between the rails of a shelf runner and the rack will sit on top of it.

Features

FlexiClip telescopic runners

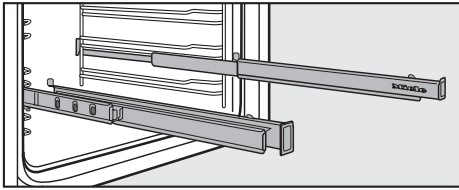

The FlexiClip telescopic runners can be clipped into any of the existing shelf runners and pulled out of the oven to their fullest extent.

Push the telescopic runners right in before placing a tray or rack on them.

To prevent the risk of a rack or tray sliding off the runners, make sure that they are sitting securely on their runners in between the stoppers at either end of each runner.

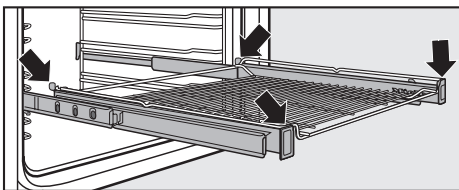
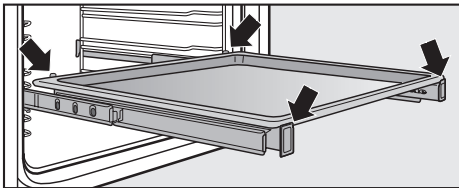

The Flexi-clip runners can support a maximum load of 15 kg.

Fitting the FlexiClip telescopic runners

Make sure that the oven has cooled down before moving the FlexiClip runners. Take care not to burn yourself on them.

The FlexiClip runners are fitted in between the two rails that make up a shelf level. The telescopic runner with the Miele logo is fitted on the right.

When fitting the FlexiClip runners **do not** extend them.

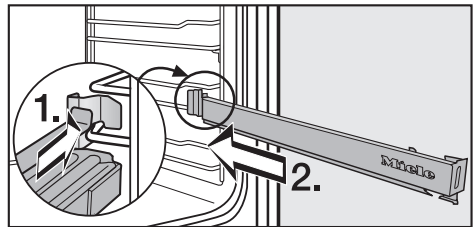

- Fit the FlexiClip runner in between the two rails at the front (1) and then push it into the oven compartment (2).

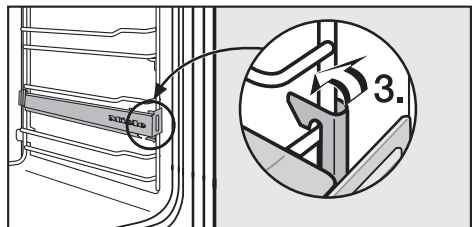

- Then secure the FlexiClip runner to the bottom of the two rails as illustrated (3).

If the FlexiClip runners are difficult to pull out after fitting, you may need to pull firmly on them once to release them.

Changing the position of the FlexiClip telescopic runners

Make sure that the oven has cooled down before moving the FlexiClip runners. Take care not to burn yourself on them.

To change the position of the FlexiClip runners:

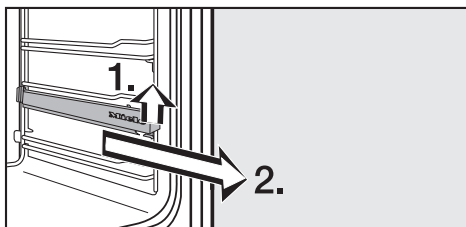

- Remove the FlexiClip runners from their original position by raising them at the front, then pulling them forwards and out.
- Refit them on the required shelf level; see "Fitting the FlexiClip telescopic runners".

Food probe

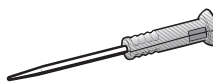

This appliance is supplied with a wireless food probe.

The food probe is stored in a holder in the door when not in use.

Replace the probe in its holder after each use. Make sure that it is inserted into the holder correctly as otherwise it could be damaged when the door is closed.

Please refer to the separate "User instructions" booklet supplied with the oven for information on how to use the food probe.

Opener

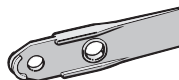

This opener is used to remove the lamp covers in the sides of the oven.

Descaling tablets, plastic tube with clip



These are required for descaling the appliance.

Features

Anti-splash insert (depending on model)

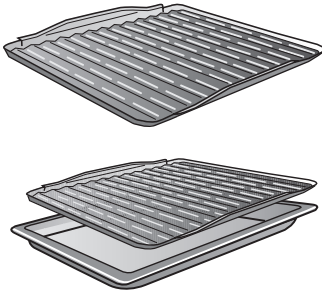

The anti-splash insert should be placed in the universal tray when grilling or roasting.

The juices from the food being cooked collect under the anti-splash insert. This prevents them from spitting and making the oven dirty. The juices can then be used for making gravy and sauces.

Handle (depending on model)

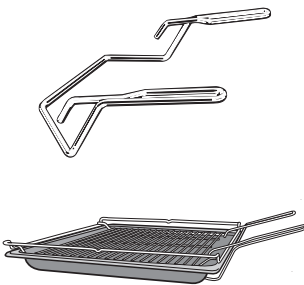

The handle makes it easier to take the universal tray, baking tray and rack out of the oven, or to put them into it. The two prongs at the top go inside the tray or above the rack, and the U-shaped supports underneath.

Miele@home communication enabled appliances use the household electrical network ③ to communicate information about their operational status and the progress of the programme to a master appliance ④ / ⑤.

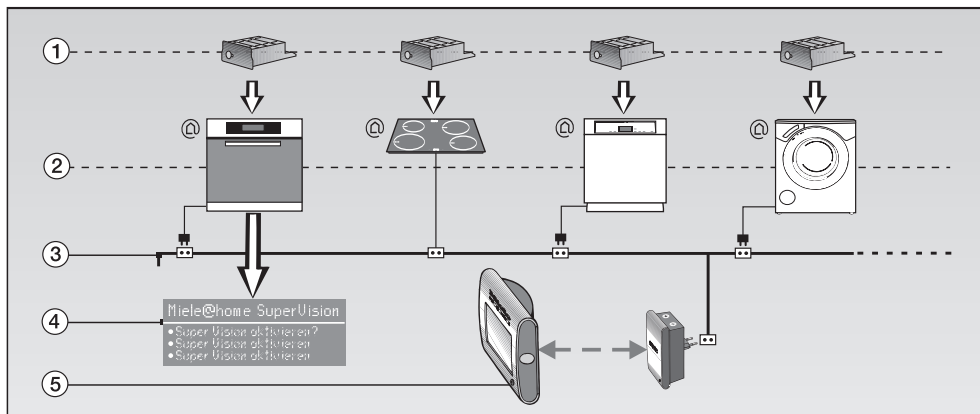

These instructions are for a communication enabled oven ② that can be linked into the Miele@home system via a communication module ① (optional accessory).

Information is displayed via:

- SuperVision appliance ④
The status of other communication enabled appliances in the system can be shown in the display of the SuperVision appliance.
- InfoControl XIC 2100 ⑤
Information transmitted from communication enabled appliances can be received acoustically and optically by a mobile InfoControl unit in the vicinity of the house.

You can use both the SuperVision appliance and the InfoControl unit at the same time.

Optional accessories

- Required: Communication module XKM 2000 SV ①
- Optional: Mobile InfoControl XIC 2100 ⑤ unit

Both of these are supplied with their own installation and operating instructions.

The home of the future

The Miele@home system is capable of expansion. In the future, communication enabled appliances ② will be able to be operated via a PC or a mobile phone.

Further information

For further information about Miele@home, SuperVision and other options planned for the future please contact your Miele dealer.

Controls

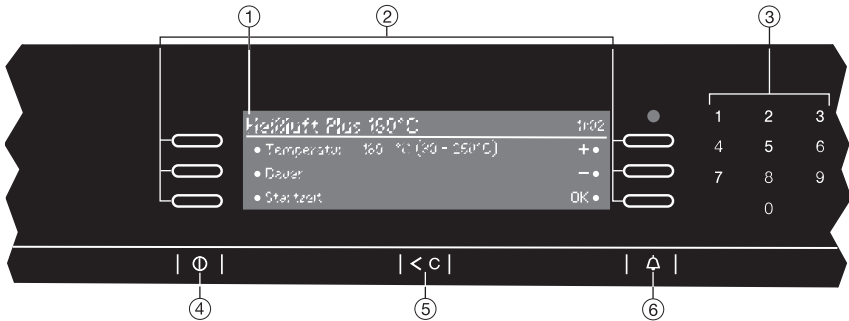

The appliance is operated via the display ① and the electronic sensors next to and below the display. These react to finger contact. A keypad tone will sound each time a sensor is touched. The volume of the keypad tone can be adjusted or switched off altogether (see "Settings - Volume - Keypad tone").



Sensors

		Meaning
②	○	Sensors When the appliance is switched on, the allocations for these sensors appear in the display. Sensors which can be used in a programme are lit up.
③	0-9	Numerical keypad This lights up if there is the option to enter a temperature or cooking duration.
④	①	ON/OFF sensor For switching the appliance on and off.
⑤	<C>	Clear sensor To delete the latest entry.
⑥	🔔	Minute minder (egg timer) sensor For entering a time for the minute minder, e.g. for boiling eggs.

Display

All information about functions, temperature, cooking durations, Automatic programmes and settings is shown in the display.

After the appliance has been switched on by touching the  sensor, the **Main menu** appears in the display with a list of options available:

An option  is selected by touching the illuminated sensor  next to the option required.











Main menu

- Fan plus
- Conventional heat
- Full grill
- Pyrolytic
- Defrost
- Lighting
- Economy grill
- Fan heat
- Moisture plus
- Intensive bake
- Top heat
- Auto roast
- Fan grill
- Bottom heat
- Descaling
- Automatic
- Slow cooking
- User programmes
- Settings 





















Controls

Symbols

The following symbols will appear in the display in addition to the text:

Symbol	Meaning
•	Appears beside an option and is allocated to a sensor  . You select the option you want by touching the sensor beside the dot.
	A maximum of 3 options can be shown in the display. These arrows indicate if more than three options are available. You can scroll up  or down  the list by touching the appropriate sensor.
.....	The end of a list is indicated by a dotted line. By scrolling down further, you reach the beginning of the list again.
+ / -	For increasing or decreasing the time or temperature shown in the display. These can also be entered using the numerical keypad.
Back 	Selecting this option and confirming with OK returns you to the previous list of options.
	A tick will appear beside the option which is currently selected. A "•" will not appear in front of this symbol.
	This indicates additional information that is available. This information window can be cleared by selecting OK.
 	The system lock is "Permitted". See "Settings - Safety". On = Operation not possible. Off = Operation possible.
	A minute minder time has been set.

When a function is selected, the following symbols may appear in the display, depending on setting:

Symbol	Meaning
	Duration
	Finish
	Start time
	Programme finished
	Rapid heat-up phase, Rapid searing phase
	Heating-up phase, Searing phase
	Core temperature when using the food probe
	Fan plus, Fan heat
	Intensive bake
	Moisture plus
	Auto roast
	Conventional heat
	Top heat
	Bottom heat
	Defrost
	Full grill
	Economy grill
	Fan grill
	Automatic programme, Slow cooking
	Lighting
	Pyrolytic

Functions

Your oven has a range of oven functions for preparing a wide variety of recipes.

These include:

- Ⓐ Top heat/grill element (under the roof of the oven)
- Ⓑ Bottom heating element (under the floor of the oven)
- Ⓒ Ring heating element (behind the intake vent for the fan)
- Ⓓ Fan (behind the intake vent for the fan)
- Ⓔ Steam injection system

These components are combined in various ways, depending on the oven function selected. See the letters given in brackets for each function.

Function	Notes
Fan plus [Ⓒ + Ⓓ]	<ul style="list-style-type: none">– For baking and roasting.– You can bake and roast on different levels at the same time.– Lower temperatures can be used than with "Conventional heat" as the Fan plus system distributes the heated air around the food.
Fan heat [Ⓐ + Ⓑ + Ⓓ]	<ul style="list-style-type: none">– For baking and roasting on one level.
Intensive bake [Ⓑ + Ⓒ + Ⓓ]	<ul style="list-style-type: none">– For cooking dishes which require a moist topping and a crisp base such as pizza and quiche lorraine.– Intensive bake is not suitable for baking thin biscuits etc. or for roasting as the juices will become too dark.
Moisture plus [Ⓒ + Ⓓ + Ⓔ]	<ul style="list-style-type: none">– For baking and roasting with moisture injection.
Auto roast [Ⓒ + Ⓓ]	<ul style="list-style-type: none">– For roasting. During the searing phase, the oven is heated up to a high temperature (230 °C) to sear the meat. Once this temperature is reached, the temperature of the oven is automatically lowered to the set cooking temperature (continued roasting temperature).
Defrost [Ⓒ + Ⓓ]	<ul style="list-style-type: none">– For the gentle defrosting of frozen food.

Function	Notes
Conventional heat [A + B]	<ul style="list-style-type: none"> – For baking traditional recipes, e.g. fruit cake, casseroles. – Also ideal for soufflés. – If using an older recipe or cookbook, set the oven temperature for Conventional heat 10°C lower than that recommended. – The cooking duration does not need to be changed.
Top heat [A]	<ul style="list-style-type: none"> – Use this setting towards the end of baking, to brown the top of a cake, quiche or pizza.
Bottom heat [B]	<ul style="list-style-type: none"> – Use this setting towards the end of baking, to brown the base of a cake, quiche or pizza.
Full grill [A]	<ul style="list-style-type: none"> – The whole grill element is switched on and glows red in order to create the heat required. – For grilling larger quantities of thin cuts (e.g. steaks). – For browning food in larger dishes.
Economy grill [A]	<ul style="list-style-type: none"> – The inner part of the grill element is switched on and glows red in order to create the heat required. – For grilling smaller quantities of thin cuts (e.g. steaks). – For browning food in smaller dishes.
Fan grill [A + D]	<ul style="list-style-type: none"> – For grilling larger items, e.g. rolled meat, poultry. – The hot air from the grill is distributed around the food by the fan. This enables a lower temperature to be selected than when using "Full grill"/"Economy grill".
Automatic [depending on programme]	<ul style="list-style-type: none"> – The list of Automatic programmes available will appear in the display.
Slow cooking [A + B]	<ul style="list-style-type: none"> – For cooking meat or poultry over a long period of time.

Before using for the first time

To enter basic settings

The oven will switch on automatically when it is connected to the electricity supply.



Welcome screen

A welcome screen will appear in the display, and you will then be requested to select some basic settings which are needed before the appliance can be used.

Follow the instructions in the display.

Setting the language

First select the language you want:

- Scroll through the list using one of the sensors to the right of the arrows  /  until the language you require appears in the display.
- Touch the sensor to the left of the language you want.
A tick ✓ will appear beside the language you have selected.
- Confirm your choice by touching the sensor next to "OK".

If you have selected the wrong language by mistake, proceed as described in "Settings - Language " to get back to the correct language.

Clock format

The request to select the Clock format will appear. The default setting for the clock is 24 h.

- Touch the sensor to the left of the clock format required.

A tick ✓ will appear beside the clock format you have selected.

- Confirm with "OK".

Setting the time of day

You will then be asked to enter the time of day. The hour is highlighted.

- Using the numerical keypad, enter the hour, confirm with "OK" and then enter the minutes in the same way.

Time of day display

Finally you will be asked when you want the time of day to show in the display when the appliance is switched off; see "Settings - Time - Display".

- On
The time is always visible in the display.
- On for 60 seconds
The time is only ever visible for 60 seconds.
- Do not display:
The display remains dark.
- Touch the sensor to the left of the setting you want.

After you have confirmed your selection with "OK", the display will show a message to tell you that:

- your appliance is equipped for the Miele@home system.
- your appliance has been successfully set up to use it for the first time.

As soon as you confirm this last message with "OK", your appliance is ready for use.

Before using for the first time

Cleaning and heating up for the first time

- Before use, please remove
- any stickers from the oven and from any accessories.
 - any protective foil from the oven front.

See "Cleaning and care" for more information.

Before using the oven for the first time

- take **all accessories** out of the oven and wash them.
 - then **heat the oven up once with nothing in it**. New ovens have a slight smell on first use and this will dissipate the smells before you use it to cook food.
- Before heating the oven up it is a good idea to wipe the interior out with a damp cloth. This way any dust or bits of packaging that may have accumulated in the oven cavity during storage and unpacking will be removed.

- Touch the ① sensor.

The appliance will switch on and the main menu will appear in the display.

- Touch the sensor next to "Fan plus".

The recommended temperature of 160 °C will appear highlighted.

- Increase the temperature to 250 °C (the highest temperature). To do this, you can either use the sensor next to + or the numerical keypad.
- Touch the sensor next to "OK".

- Heat the empty oven for at least an hour.

Please ensure the kitchen is well ventilated during this operation. Close doors to other rooms to prevent the smell spreading throughout the house.

This procedure can be set to switch itself off automatically. See "To use Automatic switch-off".

- Leave the appliance to cool down to room temperature.
- Then wipe the oven interior out with a solution of hot water and a mild detergent, and dry it thoroughly with a soft clean cloth.

Leave the oven door open until the oven interior is completely dry.

Operation

Automatic programmes

Your appliance has a wide range of Automatic programmes to enable you to achieve excellent results with ease.
Simply select the programme for your food, and follow the instructions in the display.

You can call up the Automatic programmes by selecting the "Automatic" option from the main menu.

- Switch the oven on with the ① sensor.
- Select "Automatic".

A list will appear in the display.

- Cakes
- Baked goods
- Bread
- Bread mixes
- Bread rolls
- Pizza
- Meat
- Game
- Poultry
- Fish
- Bakes/gratins
- Frozen food
- Reheat
(Reheating plated meals)
- Dessert
- Slow cooking
- Sabbath programme

- Select the option you require.

Each Automatic programme has a sub-menu with further options which will now show in the display.

Each step you need to take before starting the Automatic programme will appear in the display.

Depending on the programme you have selected, further information or prompts will appear regarding

- the roasting or baking dish,
- the shelf level,
- the use of the food probe,
- the amount of water required for programmes with Moisture plus,
- the cooking duration.

For further information about the Automatic programmes, including a selection of recipes, please refer to the "User instructions" and the "Moisture plus" recipe book.

To operate the oven manually, switch the appliance on, select the oven function and temperature, then switch it off again once you have finished cooking.

- Place the food in the oven.
- Switch the oven on with the ① sensor.

The Main menu will appear in the display.

- Select the required function.

The sub-menu for the oven function you require will show in the display, and the recommended temperature will light up.

- Change the temperature in the display if necessary.

The oven heating and the cooling fan will switch on.

You can follow the progress of the programme in the display.

In addition to the cooking function and temperature, the words "Heating-up phase" or "Rapid heat-up phase" will show in the display until the oven has reached the set temperature.

Once the set temperature is reached, a signal will sound (provided this is activated - see "Settings - Volume - Buzzer tones").

Then "Programme in progress" will appear.

Selecting "Change" brings up all the options which can be changed during the current programme, e.g. the selected temperature.

- At the end of the cooking programme, switch the appliance off using the ① sensor, and take the food out of the oven.

The cooling fan will continue to run for a while after the oven has been switched off to prevent any humidity building up in the oven, on the control panel or in the oven housing unit.

The fan is sensor-controlled and will switch off automatically.

You can change the default setting for this (see "Settings - Cooling fan").

More about manual operation

Automatic switch-off can be selected when operating the oven manually. You can also adjust the heat-up phase and the humidity level inside the oven.

To select a function

- Switch the oven on.
- Select the required function.

After selecting an oven function, options which can be entered or changed for the cooking programme will appear in the display, e.g.:

- Temperature
- Core temp. - - °C
(This only appears when the food probe is being used; see "Food probe" in the User instructions).
- Duration
- Start time
- Finish
- Heating-up phase
(Only with Fan plus, Auto roast and Conventional heat).
- Moisture reduction
- Change function

To change the temperature

As soon as you have selected a function, the recommended temperature with the temperature range which can be set in brackets beside it will appear in the display.

The following recommended temperatures are set at the factory:

Fan plus	160 °C
Fan heat	160 °C
Auto roast*	160 °C
Moisture plus	160 °C
Intensive bake	170 °C
Conventional heat.	180 °C
Top heat	190 °C
Bottom heat	190 °C
Fan grill.	200 °C
Economy grill	240 °C
Full grill	240 °C
Defrost	25 °C

* Initial searing phase temperature approx. 230 °C, then drops to 160 °C for continued roasting

If the recommended temperature is suitable for your recipe, confirm it with "OK".

If it is not suitable, you can change it for this particular cooking programme.

You can also change the recommended temperature permanently to suit your personal cooking practices. See "Settings - Recommended temperatures".

Entering the Duration, a Start time or Finish time

By entering the Duration, Start time or Finish time, the cooking process can be programmed to switch off, or on and off, automatically.

- **Duration**

When entering the Duration, you are entering the time that the food takes to cook.

Once this time has elapsed, the oven heating switches off automatically.

The maximum duration that can be entered is 12 hours.

The Duration cannot be entered if the food probe is being used as in this case the length of the cooking programme depends on the core temperature being reached.

- **Start time**

By entering the Start time, you specify the time you want cooking to start. The oven will switch on automatically at the time you have set.

The Start time can only be used in conjunction with Duration or Finish, except when using the food probe.

- **Finish**

By entering the Finish time, you specify the time you want cooking to finish. The oven will switch off automatically at the time you have set.

A Finish time cannot be entered if the food probe is being used as in this case the end of the cooking programme depends on the core temperature being reached.

To use Automatic switch-off

To **switch a programme off automatically** select Duration or Finish and enter the time required.

Example:

The time is 11:45. Your dish will take 30 minutes to cook, and needs to be ready at 12:15.

Select Duration, and enter 0:30 h, or select Finish and enter 12:15.

The oven will switch off automatically at the time set.

More about manual operation

Delaying the start with Automatic switch-off

We recommend using automatic switching on and off when roasting. However, do not delay the start for too long when baking as the cake mixture or dough will dry out, and the raising agents will lose their effectiveness.

To **switch a programme on and off automatically** you have various options:

- Enter the Duration and Finish time.
- Enter the Start time and the Duration.
- Enter the Start time and the Finish.

Example:

The time is 11:30. Your dish will take 30 minutes to cook, and needs to be ready at 12:30.

Select Duration and enter 0:30 h.

Then select Finish and enter 12:30 h.

The Start time will be calculated automatically. "Start at 12:00" will appear in the display.

The cooking programme will start at this time.

Sequence of the cooking programme when using Automatic switch-off

The following will appear in the display:

Before the programme starts

- The cooking function and selected temperature
- "Start at" and the start time

After the programme has started

- The heating-up phase until the set temperature is reached
- Once this temperature is reached, a tone will sound (provided this is activated - see "Settings - Volume - Buzzer tones").

After the heating-up phase

- The "Time left" counting down

Shortly before the end of the programme

- The oven heating switches off.
- The cooking programme continues using residual heat. The residual heat in the oven is sufficient to complete the cooking process.
- Energy save phase will appear in the display.
- The cooling fan continues to run, as does the hot air fan if a "Fan" setting has been chosen.

At the end of the cooking programme

- The hot air fan switches off, depending on the cooking function being used.
- The message "Programme finished" and the  symbol appear in the display.
- A tone will sound (provided this is activated - see "Settings - Volume - Buzzer tones").

After the cooking programme has finished

- The cooling fan will continue to run for a while after the oven has been switched off to prevent any humidity building up in the oven, on the control panel or in the oven housing unit.

The fan is sensor-controlled and will switch off automatically. You can change the default setting for this (see "Settings - Cooling fan run-on").

- To save energy, the oven will switch off automatically if it is not used again within a certain time.

The timing depends on the settings selected (cooking function, temperature, duration).

Changing or deleting an entered cooking time

Selecting "Change" brings up all the options which can be changed.

- Select the option you want and change it.

Use the <C sensor to delete the entered times.

If there is a power cut, all data entered will be deleted.

Changing the heating-up phase

With the Fan plus, Auto roast and Conventional heat functions, the Heating-up phase will appear with the following options:

● Rapid

(Factory default)

The top heating/grill elements, the ring element and the fan are switched on at the same time so that the oven reaches the desired temperature as quickly as possible.

 shows in the display.

● Normal

Only the heating elements required for the cooking function selected are switched on; see "Functions".

 shows in the display.

The Rapid heat-up phase should not be used for some items such as pizza, biscuits and small cakes because they will brown too quickly from the top.

To switch off Rapid heat-up

- For one cooking programme: Select "Heating-up phase", then "Normal".

Rapid heat-up is also switched off if a temperature of less than 100 °C is set.

- In general: See "Settings - Heating-up phase".

More about manual operation

Pre-heating the oven

Most dishes can be placed in a cold oven. They will then make use of the heat produced during the heating phase.

It is only necessary to pre-heat the oven in a few instances:

With **Fan plus**

- pre-heating may be necessary for foods which cook in less than 20 minutes and for foods such as puff pastry and yeast mixtures where instant heat is required to make them rise quickly.
- roasting beef/fillet.

With **Conventional heat**

- It is usually necessary to pre-heat the oven.
- baking pastry and cheesecake/flan bases,
- pre-heating may be necessary for foods which cook in less than 30 minutes and for foods such as puff pastry and yeast mixtures where instant heat is required to make them rise quickly.
- roasting beef/fillet.

The Rapid heat-up phase should be switched off when baking pizza, biscuits and small cakes. Otherwise they will brown too quickly from the top.

To pre-heat the oven:

- Select the required function and set the temperature.
- Wait for the oven to reach the set temperature.
Once the set temperature is reached, a signal will sound (provided this is activated - see "Settings - Volume - Buzzer tones").
- Then place the food in the oven.

Activating moisture reduction

It is a good idea to use this function when cooking items which are moist on the inside but which should be crispy on the outside, e.g. frozen chips, croquettes or pork with crackling.

It is also suitable for deep filled fresh fruit cakes, such as plum or apple cake.

You can activate Moisture reduction with any function.

For best results, activate it at the beginning of the cooking programme.

- Place the food in the oven.
- Switch the oven on with the ① sensor.
- Select the required function and set the temperature.
- Touch the OK sensor.

The list of options will show in the display.

- Select Moisture reduction and touch the On sensor to confirm.

Change function

You can change the function selected via this option.

The times already entered will be kept.

User programmes

Up to 25 frequently used recipes can be saved under a user-defined name, and then called up again as required.

Either

- Select the **Save as** option at the end of running an Automatic programme and give the programme a name of your choice, or
- select the **User programmes menu**. You can combine up to four cooking steps and save them under a name of your choice.

The User programmes menu

If user programmes have already been created and saved, the following will appear:



- **Select**
For calling up and starting an existing User programme. You choose whether the programme should "Start now" or "Start later".
- **Create**
This is used to create a new User programme.
- **Change**
For altering an existing programme.
- **Delete**
Existing programmes can be deleted individually. You can also delete all User programmes at the same time - see "Settings - Factory default - User programmes".
- **Use in main menu**
You can place up to three user programmes in the Main menu. Changes to the Main menu can be reset via "Settings - Default settings - Main menu".

To create a User programme

If programmes already exist under User programmes, the "Create" option has to be selected in order to save additional programme stages to memory.
Then continue following the instructions below.

- Select the "User programme" menu.
- Select and confirm the cooking function you want.
- Alter and confirm the pre-set recommended temperature if required.
- Select a duration, or a core temperature if using the food probe, and confirm your selection.
- Do a final check of all of the settings and confirm them with "Continue".
- You can add more cooking stages, for example, if you want to add another cooking function to follow on from the first.
Proceed as described above.
- Finally set the shelf level to be used.

After confirming with "Continue", select the name given in the display, or **enter your own name**. To do this:

- Use the sensors next to arrows   to select a character.
- When the letter or number you want is highlighted, confirm it with "Select character". The letter or number you have selected will appear in the top line of the display after "Name".
- Select the rest of the letters or numbers for your programme name.

You can use the "Delete character" option to correct any wrong entries.

Select "Space" where a space is required.

- Confirm the programme name with "OK".

To call up an existing User programme

- Select "User Programmes" from the main menu, and then the "Select" option. Programmes saved under User programmes will then appear in the display.

Moisture plus

The "Moisture plus" function uses a steam injection system.

Water is taken into the steam injection system via the tube underneath the control panel on the left. The water is then injected as bursts of steam into the oven compartment during the cooking process.

The steam inlets are located at the rear left corner of the roof of the oven.

 Only use water with this function.

Other liquids will damage the appliance.

Baking, roasting or cooking with Moisture plus uses just the right amount of steam and optimum air flow for very even cooking and baking results: delicious fresh bread with a glossy crust; rolls and croissants as good as the baker makes; tender, succulent meat with a well browned finish; perfectly finished oven bakes; delicious soufflés and much more.

Please refer to the "Moisture plus" booklet supplied with your oven for further information and a selection of recipes.

Moisture plus is not suitable for mixtures which already contain a lot of moisture, such as choux pastry and meringues, as the addition of steam does not allow them to dry out sufficiently.

Moisture plus is activated with Automatic programmes or you can select the special "Moisture plus" function.

 The steam injection system should be rinsed through before you use an Automatic programme with Moisture plus or the Moisture plus function for the first time. To do this, run the oven using "Moisture plus - 160 °C - Automatic burst of steam" for about 30 minutes.

Automatic programmes

Automatic programmes with Moisture plus set the optimum temperature, the degree of moisture and also the duration automatically.

At the beginning of the programme you will be prompted to allow a specified amount of water to be drawn into the oven.

The amount of water specified will be more than the amount which is actually needed which means that some of the water will remain in the container as not all of it will be drawn up into the oven. The programme will control how many bursts of steam are required and at what point they are injected.

Night baking

Some of the Automatic programmes for bread and rolls have the option of baking during the night, so that you can enjoy freshly baked bread for breakfast the next morning.

The "Finish" option will appear when you have selected the programme.

When "Finish" is selected, a finish time will appear which is the cooking duration for the programme plus five or six hours, depending on programme. You can change this to the time you want the bread to be ready at the next morning.

Follow the instructions which then appear in the display.

Moisture plus

Moisture plus

When using the Moisture plus function you will need to enter

- the temperature (at least 130 °C), and
- the number of bursts of steam.

You can also enter the cooking duration or you can use the food probe.

Number of bursts of steam and when they are injected

The number of bursts of steam and when they are injected will depend on the type of food being cooked:

- **Dough mixtures** will rise better if steam is injected at the beginning of the programme.
- **Bread and rolls** also rise better if exposed to steam at the start. Injecting a burst of steam at the end of the programme will give the bread and rolls a glistening crust.
- When **roasting meat with a high fat content** injecting steam at the beginning of roasting will draw out the fat.

Please refer to the sample recipes in the "Moisture plus" booklet.

After selecting Moisture plus you need to set the number of bursts of steam. The options are:

- Automatic
This requires enough water for one burst of steam. The burst of steam will be injected into the oven automatically after the heating-up phase.
Steam is injected for about 5 minutes.
- 1 burst of steam
- 2 bursts of steam
- 3 bursts of steam
The quantity of water required will depend on the number of bursts of steam.
The earliest point at which steam can be injected is after the heating-up phase has been completed.
One burst of steam takes approx. 5 minutes to be injected into the oven.
It is a good idea to set the minute minder to remind you when to inject the bursts of steam required.

It is quite normal for condensation to form on the inside of the door during steam injection. This will dissipate during the course of the cooking programme.

Using Moisture plus

- Place the food in the oven.
- Select Moisture plus .
- Select a temperature.
- Select Automatic burst of steam or select the number of bursts of steam.
- Fill a suitable container with the quantity of water specified.
Automatic/
1 burst of steam: approx. 100 ml
2 bursts of steam: approx. 150 ml
3 bursts of steam: approx. 250 ml
- Pull the fill tube forwards (located below the control panel on the left).

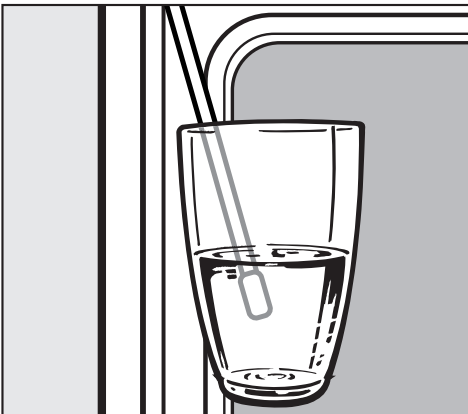

- Hold a container with the quantity of water specified under the tube as shown. Start the water intake process with "OK".

The amount of water required will be drawn up into the oven. As the water is taken in, bars will appear in the display. The amount of water specified will be more than the amount which is actually needed which means that some of the water will remain in the container as not all of it will be drawn up into the oven.

When you close the oven door you will hear the noise of the pump briefly.

Automatic burst of steam

- Once the heating-up phase has been completed, the automatic burst of steam is injected and the water will vaporise in the oven compartment.

Once the steam has been injected successfully, the programme will continue to the end.

Injecting bursts of steam manually

Once the heating-up phase has finished, the bursts of steam can be injected at the intervals given in the recipe.

Set the minute minder  as a reminder.

When it is time to inject steam:

- Select "Release steam".

The water will vaporise in the oven compartment.

If more bursts of steam are required, proceed as described above.

Once the steam has been injected successfully, the programme will continue to the end.

Moisture plus

To evaporate residual moisture

If there is still water in the steam injection system at the end of a programme or if the programme is cancelled, you will be prompted to evaporate the residual moisture.

This prompt will appear

- when the appliance is switched on,
- when selecting "Moisture plus", or
- when selecting an automatic programme that uses Moisture plus.

Select "Cancel" to cancel the process or "OK" to start it.

It is best to start the evaporation process straight away so that only fresh water can be used during the next cooking programme.

The residual moisture evaporation process

The oven will heat up to approx. 150 °C, and the residual water in the oven cavity will evaporate. How long this takes will depend on the amount of water in the system.

Steam will condense on the door and the oven cavity, and the moisture will then need to be wiped off after the oven has cooled down.

To start the residual moisture evaporation process

Confirm the prompt "Evaporate residual moisture" with OK.

The evaporation process will start immediately. The display will show the approximate time remaining.

To cancel the residual moisture evaporation process

After the appliance has been switched on, the prompt to evaporate residual moisture will appear in the display. Touch the sensor next to "Cancel". You will only be able to run functions and Automatic programmes without Moisture plus.

If you select "Moisture plus" or one of the Automatic programmes with Moisture plus, the prompt to evaporate residual moisture will appear immediately.

If you do not want to start the residual moisture evaporation process, you will need to press the Cancel sensor for at least 3 seconds.

You can now start the cooking programme.

 Do not cancel the prompt for residual moisture evaporation too often, as this might cause the steam injection system to overflow when taking in more water.

Descaling

The oven will need to be descaled depending on the number of cooking programmes using Moisture plus which have been run and the amount of water taken into the oven for these. This will be indicated in the display.

The steam injection system should be descaled regularly. How often this needs to be done will depend on the water hardness level in your area.

You can start the descaling process at any time by selecting "Descale" in the main menu.

If you do not carry out the descaling process when the prompt to descale the oven appears, you will only be able to run functions and Automatic programmes without Moisture plus.

See "Cleaning and care" for more information about descaling.

Minute minder (egg timer)

The minute minder can be used to time any activity in the kitchen, e.g. boiling eggs.

You can enter a time of up to a maximum of 9 hours, 59 minutes and 59 seconds.

You can set the minute minder at the same time as another timed programme, e.g. as a reminder to stir a dish or add seasoning etc.

With "Moisture plus ":
It is a good idea to use the minute minder to remind you when to release the bursts of steam manually.



To set the minute minder

- Touch the  sensor.
- "0 : 00 : 00" will appear in the display.
- Enter the minute minder time using the numerical keypad:
first enter the hours, then the minutes followed by the seconds.
(For example: for 6 minutes 20 seconds
enter: 0 06 20).
 - Confirm your entry with the OK sensor.

If you use the + or - to enter the time you must confirm each part of the entry with the OK sensor.

The time counts down in the display.

At the end of the time set for the minute minder

- the  symbol will flash.
- A tone will sound (provided this is activated - see "Settings - Volume - Buzzer tones").
- the display will show the time counting upwards.
- Touch the  sensor.

To alter the time set for the minute minder:

- Touch the  sensor.
- Use the <C sensor to set the time to "0 : 00 : 00" and then enter a new minute minder time.
- Confirm your entry with the OK sensor.

To cancel the time set for the minute minder

- Touch the  sensor twice.

Your appliance is supplied with a number of standard default settings.

To change a setting:

- Select the "Settings " option.

The list of options will show in the display.

- Language 
- Time
- Lighting
- Main menu
- Catalyser
- Cooling fan run-on
- Pyrolytic
- Heating-up phase
- Start
- Recommended temperatures
- Display
- Volume
- Safety
- Units
- Showroom programme
- Factory default

- Select and confirm the one you want to change.

If a setting is not confirmed within a certain time, the display will revert to the "Settings" list.



Currently selected settings are indicated by a "✓" and without a "+" next to them.

Settings cannot be altered while a cooking programme is in progress.

Language

You can set the language you want the display to appear in.

After selecting and confirming "Language", the language you have selected will appear in the display.

If you have selected the wrong language by mistake, you can follow the flag symbol  to get back to the Language  menu.

Settings

Time

The options are:

- Display
- Clock format
- Set

If there is a power cut, the current time of day will reappear once power has been restored. The appliance will store this data for approx. 200 hours. After 200 hours it will show "12:00" and will need to be re-set.

Display

Select how you want the time to appear in the display when the oven is switched off:

- On
The time of day will always show in the display.
- On for 60 seconds
The time is only ever visible for 60 seconds when the oven is switched on and when it is switched off.
- Do not display
The time will only show in the display when the oven is being operated.

Clock format

The time of day can be altered from a 24-hour display to a 12-hour display:

- 12 h: 12 hour clock display
- 24 h: 24 hour clock display
(Factory default)

To set the time of day

The time of day is set using either the numerical keypad or the + and - sensors:

First enter the hours and confirm with "OK". Then enter the minutes and confirm with "OK".

Lighting

- On
The oven interior lighting remains on during the entire cooking programme.
- On for 15 seconds
(Factory default)
The oven interior lighting will switch off 15 seconds after the start of a cooking programme. Pressing one of the illuminated sensors next to the display will switch the lighting on for another 15 seconds.
With Automatic programmes you will need to touch the  sensor twice because the sensors next to the display are not illuminated.

Main menu

You can change the order in which options appear in the main menu. Up to three options can be placed at the beginning of the main menu (excluding Settings).

When you select this option you will be prompted to set positions 1, 2 and 3.

You will be given the choice of selecting a standard oven function or an Automatic or a User defined programme for each position. After selecting and confirming one position you will be prompted to set the next one.

Once you have set all three the list will appear in the display.

If you have already set a programme of your choice at the beginning of the main menu (see "User programmes - Use in main menu"), the next one will be added to the list.

Catalyser

- On
(Factory default)
The catalyser is always switched on.
- Off next prog. only
The catalyser will be switched off for the next programme only.

Settings

Cooling fan run-on

The cooling fan will continue to run for a while after the oven has been switched off to prevent any humidity building up in the oven, on the control panel or in the oven housing unit.

- Sensor controlled (Factory default)
The auto sensor will switch off the cooling fan.
- Temperature controlled
The cooling fan will switch off when the temperature in the oven compartment drops below approx. 70 °C.
- Time controlled
The cooling fan will switch off after approx. 25 minutes.

Do not leave food in the oven to keep it warm if you have set the cooling fan to timed operation. Moisture levels in the oven could increase, leading to condensation forming on the control panel and surrounding kitchen furniture and drops of moisture collecting under the worktop.

Condensate can



- damage the housing unit/worktop.
- lead to corrosion in the oven.

Pyrolytic

- With reminder
- A reminder to carry out the pyrolytic cleaning process will appear in the display.
- Without reminder (Factory default)
You will not be reminded to carry out the pyrolytic cleaning process.

Heating-up phase

The heating-up phase works as follows with the Fan plus, Conventional heat and Auto roast functions:

- Rapid (Factory default)
All the heating elements are switched on together in order to heat the oven up as quickly as possible to the required temperature.
 and "Rapid heat-up phase" or "Rapid searing phase" will appear in the display.
- Normal
Only the heating elements for the cooking function selected are switched on.
 and "Heating-up phase" or "Searing phase" will appear in the display.

Start

- Automatic
(Factory default setting)
A programme will start automatically approx. 20 seconds after making your last entry without having to select Start.
- Manual
If "Manual" has been selected, "Start" will appear at the beginning of each programme and must be confirmed before the programme will start.

Recommended temperatures

If you frequently change a recommended temperature it may be a good idea to change it permanently.

The recommended temperature can be changed for the following functions:

- Defrosting
- Auto roast
- Full grill
- Economy grill
- Fan heat
- Fan plus
- Intensive bake
- Moisture plus
- Conventional heat
- Top heat
- Fan grill
- Bottom heat

The currently selected recommended temperatures will be displayed.

When you select a function the recommended temperature is highlighted.

The setting range available will also appear.

Display

Contrast

The contrast is represented by a bar with seven segments.



Factory default: Four blocked segments.

To change the contrast touch the "lower" or "higher" sensor.

Brightness

The brightness is represented by a bar with seven segments.



Factory default: Six blocked segments.

To change the brightness touch the "darker" or "lighter" sensor.

Settings

Volume

Buzzer tones

The volume is represented by a bar with seven segments.



Factory default: Three blocked segments.

To change the volume touch the "quieter" or "louder" sensor.

If all segments are blocked out the volume is on maximum.

If none of the segments are blocked out the volume has been turned off.

Frequency

The frequency of the buzzer can be changed. Changing the frequency may be necessary to optimise the volume in different installation environments.

The frequency range is represented by a bar with 15 segments. Each segment represents a different frequency.



To change the frequency touch the sensor next to the "-" or "+" symbols.

If the segment on the far left is the only one blocked out (factory default) a brief signal will sound after a short while four times at 15 second intervals.

If more than one segment is blocked out a continual signal will sound after a short while for approx. 8 minutes on the frequency set.

Keypad tone

The volume of the keypad tone, which beeps when touched, can be changed or the sound switched off completely.



Factory default: Three blocked segments.

To change the volume touch the "quieter" or "louder" sensor.

If all segments are blocked out the volume is on maximum.

If none of the segments are blocked out the volume has been turned off.

Safety

System lock

The system lock prevents the appliance being switched on unintentionally, by children for example.



The system lock has to be set to "Permitted" (activated) in order to use it.

- Permitted
The system lock is active.
The  symbol appears in the display, as soon as the appliance is switched off. The system lock can now be used.
- Not permitted
(Factory default)
The system lock is deactivated.

To switch the system lock on or off

- Touch the sensor next to the  symbol.

You can choose between:

- On
The appliance is locked and cannot be operated.
 appears in the display.
- Off
The appliance is unlocked and can be operated.
 appears in the display.

The minute minder can still be used.

The system lock remains active even after a power cut.

In operation lock

(depending on model)

The In operation lock prevents the appliance from being switched off inadvertently and cooking programmes from being altered.

When the In operation lock has been activated, the appliance will be locked a few seconds after a cooking programme has started.

- To activate the In operation lock, select "On".
- On
During a cooking programme, you must touch a sensor for at least 5 seconds before it will react.
- Off
(Factory default)
The sensors will react immediately they are touched.

Settings

Units

Temperature

- °C
(Factory default)
- °F

Showroom programme

- Off
(Factory default)
- Demo programme
- Continuous loop
- Demo mode

This programme is for dealers who want to demonstrate the appliance without the heater elements working.

Do not activate this setting for domestic use!

If you select and activate this option by mistake, you can deactivate it as follows:

- Demo programme
Select the "Off" option and follow the instructions in the display.
- Continuous loop
- Demo mode
Touch one of the sensors next to the display and follow the instructions.

Factory default

● All settings

Any settings that you have altered will be reset to the factory default setting.

● User programmes

All saved user programmes will be deleted.

● Main menu

The main menu will be reset to the factory default setting.

● Recommended temperatures

Only those recommended temperatures which have been changed will be reset to the factory default settings.

Miele branded cleaning and conditioning products are available from the Miele Spare Parts Department or via the internet on www.miele-shop.com.

 Do not use a steam cleaner to clean the appliance. The steam could reach electrical components and cause a short circuit.

Appliance front

Remove any soiling immediately. If this is not done, it might become impossible to remove and could cause the surface to alter or discolour.

Clean the front using a damp Miele microfibre E-cloth or with a clean sponge and a solution of hot water and washing-up liquid. Wipe dry using a soft cloth.

All external surfaces are susceptible to scratching. Scratches on glass surfaces could even cause a breakage in certain circumstances. Contact with unsuitable cleaning agents can alter or discolour the external surfaces.

To prevent damage to your appliance when cleaning do not use:

- cleaning agents containing soda, ammonia, acids or chlorides,
- cleaning agents containing descaling agents,
- abrasive cleaning agents, e.g. powder cleaners and cream cleaners,
- solvent-based cleaning agents,
- stainless steel cleaning agents,
- dishwasher cleaner,
- oven sprays,
- glass cleaning agents,
- hard, abrasive sponges and brushes, e.g. pot scourers,
- eraser blocks,
- sharp metal scrapers.

Cleaning and care

Accessories

Remove all accessories as well as the runners and any extra accessories such as FlexiClip runners from the oven interior before starting the pyrolytic cleaning process. This also applies to shelf runners and any optional accessories.

The high temperatures needed for pyrolysis will damage the accessories.

Baking tray, universal tray, anti-splash insert (if applicable)

The surface has been treated with **PerfectClean enamel**.

Please refer to the section on "PerfectClean" for information on cleaning and care.

Rack, runners

The surface has been treated with **PerfectClean enamel**.

Treat in the same way as other surfaces coated with PerfectClean. See "PerfectClean".

Food probe

The food probe is dishwasher-safe.

FlexiClip telescopic runners

Do not clean FlexiClip telescopic runners in a dishwasher. This would remove the special lubricant.

When cleaning do not use:

- abrasive cleaning agents, e.g. powder cleaners and cream cleaners,
- stainless steel cleaning agents,
- hard, abrasive sponges and brushes, e.g. pot scourers.

When cleaning the runners be very careful not to wash out the special lubricant in them.

Avoid frequent:

- soaking in hot soapy water,
- use of oven spray,
- cleaning of the bearings.

FlexiClip telescopic runners are best cleaned after each use. This prevents soiling drying on or being burnt on when the oven is used again.

If the runners are used frequently without being cleaned, it may become very difficult or even impossible to clean them.

Normal soiling

Clean the surfaces using a damp Miele microfibre E-cloth or with a clean sponge and a solution of hot water and washing-up liquid. Wipe dry using a soft cloth.

Remove any cleaning agent residues as these could reduce the anti-stick effect.

Heavy soiling

If necessary, the scouring pad on the reverse of a non-stick washing-up sponge can be used to clean the runners. Cleaning is easier if a little washing-up liquid is applied to the soiling and left to soak in for a few minutes before cleaning.

For very heavy soiling the telescopic runners can be soaked in a solution of hot water and washing-up liquid for a maximum of 10 minutes.

After cleaning there may be some discolouration or lightening to the telescopic runners. This will not affect the functioning of the runners in any way.

Please note:

When baking cakes with moist toppings or fillings e.g. fruit crumble, be careful not to let them spill over. Should this happen there is a danger of sticky fruit juices adhering to the runners and hindering or even preventing their movement in and out of the oven. Clean the runners as described above and very carefully use a soft nylon brush to clean the bearings inside the runners.

Lubricating the FlexiClip telescopic runners

If the lubrication on the telescopic runners dries out, they can be relubricated as necessary to ensure they continue to run smoothly.

A special lubricant is available from Miele.

Only use this special lubricant, as it is designed to withstand high temperatures in the oven. Other lubricants can harden and stick to the telescopic runners when they are heated.

Cleaning and care

PerfectClean

The following have been treated with a special finish called PerfectClean:

- baking tray
- universal tray
- anti-splash insert (if applicable)

PerfectClean surfaces have very good **anti-stick properties** and are **much easier to keep clean** than conventional oven enamel, if cleaned regularly.

Food can be lifted off more easily, and soiling from baking and roasting is easier to remove.

The following notes on cleaning and care should ensure that the anti-stick and easy clean properties of PerfectClean last for many years.

PerfectClean surfaces can be treated as you would treat glass.

Food can be sliced or cut up on the PerfectClean surface in the same way as on a baking tray with conventional enamel.

Do not use ceramic knives on PerfectClean treated surfaces, as these can cause scratches.

 Allow the oven and any accessories to cool down before cleaning by hand. Danger of burning.

For the optimum performance of PerfectClean, it is important to clean the oven and accessories after each use.

The surfaces will become harder to clean and the anti-stick properties will deteriorate if soiling is not removed after each use and allowed to build up. In extreme cases cleaning may become impossible.

To avoid damaging the surface structure, the following must not be used on PerfectClean surfaces:

- abrasive cleaning agents, e.g. powder cleaners and cream cleaners,
- cleaning agents for ceramic hobs,
- wire wool or metal scourers,
- abrasive sponges, e.g. pot scourers or sponges which have been previously used with abrasive cleaning agents,
- oven spray must not be used on PerfectClean surfaces which are hot or left on for too long,
- PerfectClean enamelled items must not be washed in a dishwasher,
- spot cleaning.

After cleaning, rinse thoroughly with clean water to remove any residual cleaning agents as these can diminish the anti-stick properties.

Normal soiling should be cleaned as soon as possible after each use with a soft sponge and a solution of hot water and a little washing up liquid. The longer soiling is left, the harder it may become to remove.

If necessary, the scouring pad on the back of a non-scratch washing-up sponge or a soft nylon brush can be used.

You may find it easier to clean the oven trays if you soak any deposits in a solution of hot water with a little washing-up liquid for a few minutes.

Stubborn soiling can be more difficult to clean and may require an oven cleaning spray.

Allow the PerfectClean surfaces to cool down to room temperature before applying the spray. Apply a proprietary oven cleaning spray and leave to take effect for up to ten minutes only.

Miele oven cleaning spray can be left on for longer. Always follow the instructions on the packaging.

If necessary, the pad on the back of a non-scratch washing-up sponge can also be used.

Repeat the process, if necessary.

After using oven spray, rinse thoroughly with clean water and then dry thoroughly.

For **extremely stubborn soiling** a glass scraper or a non-abrasive stainless steel pad can be used.

The steps described above should enable you to clean the surfaces thoroughly.

Should the PerfectClean surface be damaged by any of the above measures not being heeded, it will still retain the anti-stick qualities of standard enamel and be as easy to keep clean as standard enamel.

Please note:

- Soiling such as spilt juices and cake mixtures are best removed whilst the oven or tray is still warm. Exercise caution and make sure the oven is not too hot - danger of burning.
- Soiling such as spilt juices and roasting deposits may cause lasting discolouration or matt areas to appear. Discolouration or matt areas will not affect the efficiency of the surface. Follow the cleaning instructions given above and do not use force to remove them.

Cleaning and care

Oven interior

The oven interior is coated with dark **pyrolytic enamel** which facilitates cleaning.

This is a particularly hard enamel with an extremely smooth surface and very good anti-stick properties.

Manual cleaning of the oven interior

Allow the oven to cool down before cleaning by hand.
Danger of burning!

The oven interior and the inside of the door should be cleaned after each use. If this is not done subsequent soiling from baking and roasting will become worse and make cleaning harder. In extreme cases, heavy soiling could even damage the surface.

There is a fibre-glass door seal around the oven cavity. This seal is particularly sensitive and should not be cleaned unless absolutely necessary. Rubbing it can damage it.

Most cooking residues can be removed with a damp cloth and a mild solution of hot water and washing-up liquid.

Never use hard brushes, hard sponges, wire wool pads*, knives or any other abrasive materials or cleaning agents. They can damage the enamel.

If using an oven spray, the manufacturer's instructions must be followed.

* Non-abrasive stainless steel spiral pads can, however, be used.

To make cleaning easier

- remove the oven door,
- dismantle the door,
- remove the FlexiClip telescopic runners,
- take out the shelf runners,
- lower the top heating/grill element.

Instructions for doing so are given further on in this section.

Pyrolytic cleaning of the oven interior

Before starting a pyrolytic cleaning process please note the following:

Remove any coarse soiling from the oven before you start.

Clean the inside of the door (glass).

There is a fibre-glass door seal around the oven cavity.

This seal is particularly sensitive and should not be cleaned unless absolutely necessary. Rubbing can damage it.

Remove all accessories from the oven interior before starting the pyrolytic cleaning process. This also applies to the FlexiClip runners, shelf runners and any optional accessories. The high temperatures needed for pyrolysis will damage the accessories.

The oven door gets much hotter during pyrolytic operation than during normal use.

Make sure children cannot touch the oven whilst a pyrolytic programme is running. Danger of burning.

During the pyrolytic process the oven is heated to over 400 °C. Any residual soiling is broken down and reduced to ash by the high temperatures.

The pyrolytic programme duration will vary depending on the level of soiling.

For safety reasons the **oven door** is **automatically locked** at the beginning of the pyrolytic programme.

At the end of the programme it will not be unlocked until the temperature inside the oven has dropped to below 280 °C.

If the pyrolytic cleaning programme has been started by mistake or if the process is interrupted, the door lock will be released:

- immediately if the temperature is below 280 °C.
- not until the oven interior temperature is below 280 °C if the temperature inside the oven is higher than 280 °C.

Starting a pyrolytic process

- Take all accessories out of the oven.
- Select the "Pyrolytic" function.
- Start the pyrolytic cleaning process.

The door will lock.

You can **delay the start of the pyrolytic process** for example, to take advantage of cheaper night electricity tariffs. To do this:

- Select "Start time" and select a time to start the programme at.

You can change the start time if you wish at any time up until the delay period has elapsed.

At the end of the programme a buzzer will sound and the message "Programme finished" will appear in the display.

- Switch off the oven.

Cleaning and care

After the pyrolytic process, any debris (e.g. ash) can easily be wiped away.

Remember to wait until the oven has cooled down before doing so!
Danger of burning.

Try not to wipe over the fibre-glass seal when cleaning the oven cavity. It is particularly sensitive and should not be cleaned unless absolutely necessary. Rubbing it can damage it.

Most residues are easily wiped away with a damp cloth.

Depending on soiling levels in the oven there may be visible deposits on the door and below the trim under the oven cavity. This is best removed using a non-abrasive sponge or non-abrasive stainless steel spiral pad and a mild solution of warm water and washing-up liquid.

Spilt fruit juices may cause lasting discolouration to the surfaces. This discolouration is permanent but will not affect the efficiency of the enamel. Do not attempt to remove these marks.

The **pyrolytic process will be cancelled**,

- if the oven is switched off.
- if another function is selected during the pyrolytic process.
- in the event of a power cut.

In the last two instances above, switch the oven off.

If the oven interior temperature is below 280 °C, the door lock will be released after a short while. It can then be opened.

Start the pyrolytic cleaning process again if necessary.

To remove the oven door

The oven door is connected to the oven by hinges.

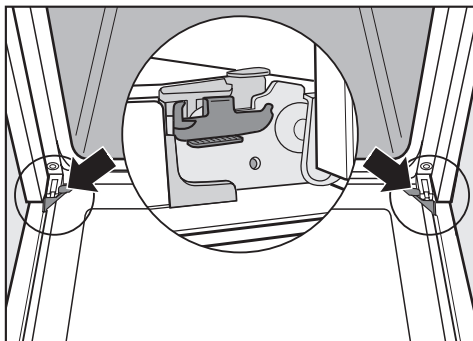

Before removing the door, the locking clamps on both hinges have to be released.

- Open the door fully.

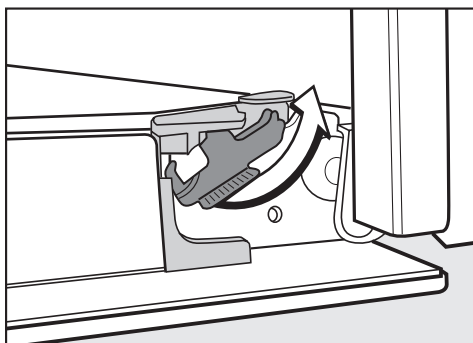

- To release the locking clamps on the hinges turn them upwards as far as they will go until they are at an angle. See illustration.

- Then lift the door upwards as far as it will go.

Do not attempt to take the door off the hinge guides when it is in a horizontal position. The hinge guides will close, and damage the appliance. Danger of injury.



- Hold the door securely at both sides and lift upwards off the hinge guides.

Do not lift the door off by the handle. The handle could break and damage the door.

Make sure that you lift the door off equally on both sides.

Cleaning and care

To dismantle the oven door

The oven door is made up of four panes of glass and has vents at the top and bottom.

When the oven is operating, air is circulated through the door to keep the outer pane cool.

If condensate has worked its way in between the glass panes, the door can be dismantled in order to clean in between the panes.

When cleaning the glass panes please follow the same instructions given for cleaning the appliance front.

Do not use abrasive cleaning agents, sponges or brushes, as these can scratch the surface. Scratches can also cause the glass to break.

Do not use an oven spray. This will damage the surface of the aluminium surrounds.

Ensure that the glass panes are inserted the correct way round after cleaning, as each side of the pane has a different coating. Those facing the oven interior reflect the heat.

To avoid the risk of breakage, it is advisable to place the panes on a table protected by a soft cloth (e.g. a thick table cloth or a towel).

Always remove the oven door before dismantling it.

- Place the door on a protective surface (e.g. on a table cloth) to prevent it getting scratched. The door handle should just overhang along the edge of the table so that the glass lies flat to prevent it from getting broken during cleaning.

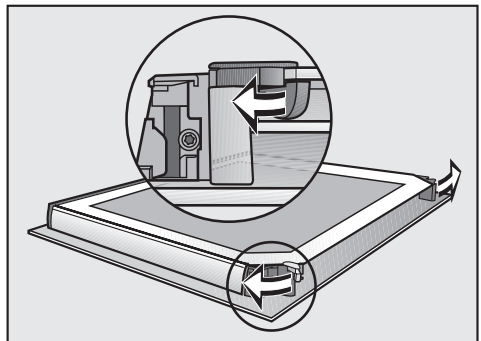

- Flip the glass pane retainers outwards to open them.

You can now remove the inner and the two middle panes.

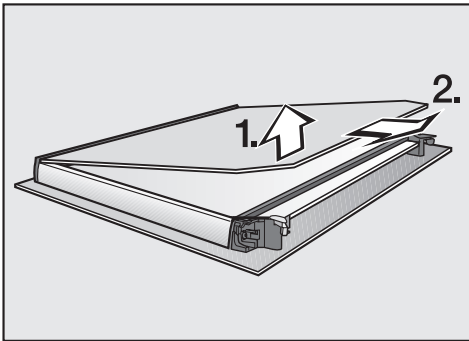

- **Gently** lift the inner pane up and pull out of the cover strip.

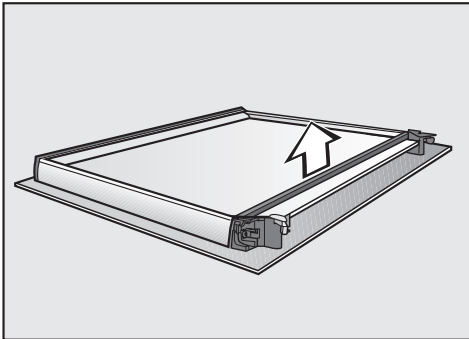

- Remove the seal.

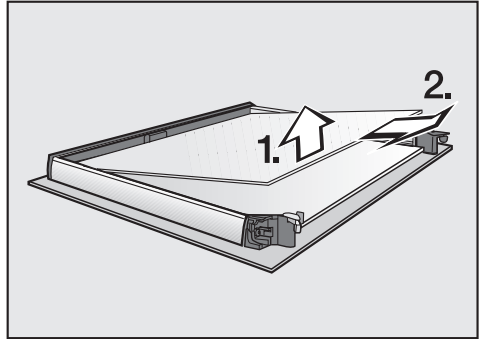

- Now gently lift up the upper of the two middle panes and remove it.

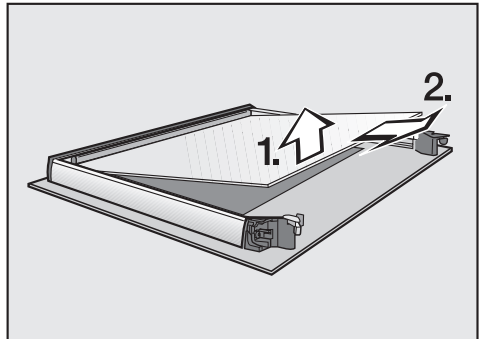

- Gently lift up the lower of the two middle panes and remove it.
- Clean the glass panes and other parts with a damp Miele E-cloth or a clean sponge and a solution of hot water with a little washing-up liquid. Wipe dry using a soft cloth.

Cleaning and care

- To reassemble the door:

The two middle panes are identical. The seven-digit material number is printed on the panes to help you reassemble them correctly.

- Place the lower of the two middle panes in so that the material number is legible (i.e. so that it is not reversed).

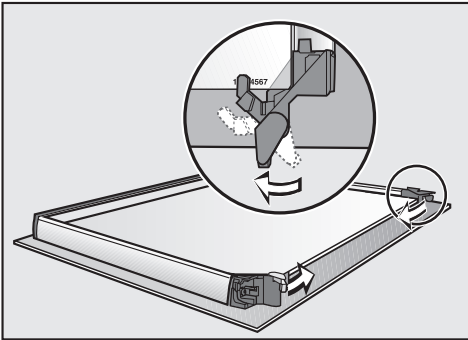

- Flip the glass pane retainers inwards so that they rest on the lower middle pane.
- Place the upper of the two middle panes in so that the material number is legible (i.e. so that it is not reversed). The pane must rest on the retainers.

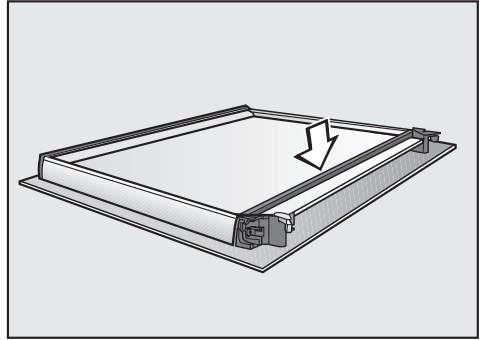

- Replace the seal.

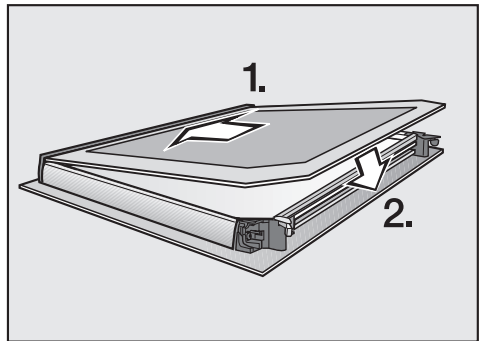

- Push the inner pane into the plastic strip and place it in between the retainers.

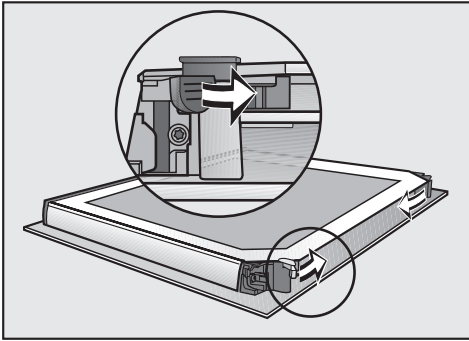

- Flip the glass pane retainers inwards to close them.

To refit the door

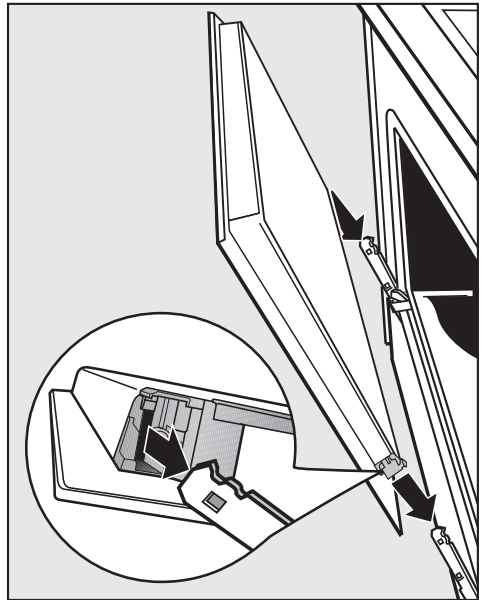

- Hold the door securely at both sides and carefully fit it back onto the hinge guides.

Make sure that the door goes back on straight.

Cleaning and care

- Open the door fully.

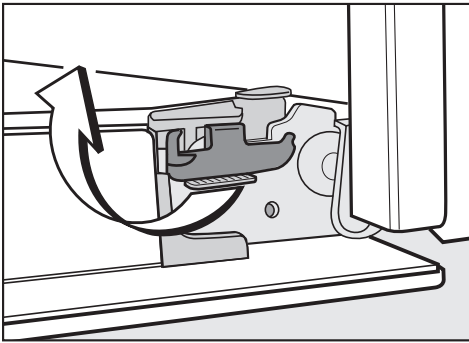

- Flip both locking clamps back up as far as they will go into a horizontal position. Turn them as far as they will go into a horizontal position.

It is essential that the clamps are locked after refitting the door. Otherwise the hinges could work loose, resulting in damage to the door.

To remove the FlexiClip telescopic runners

Make sure the oven heating elements are switched off and cool. Take care not to burn yourself on them.

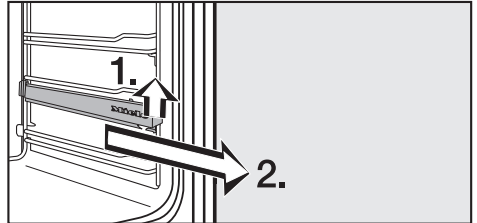

- Lift the FlexiClip runner up at the front and pull it out along the rail.

Refit the runners carefully as described in "Features".

To remove the side runners

Make sure the oven heating elements are switched off and cool. Take care not to burn yourself on them.

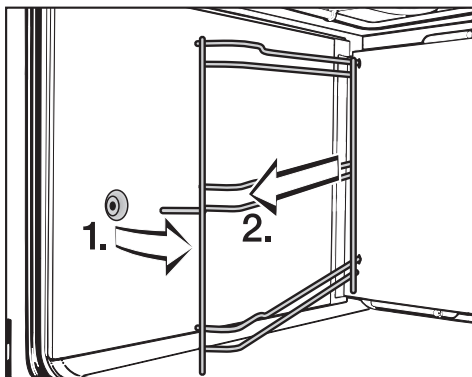

- Pull the runners forwards out of the holder and remove.

Reassemble them in the reverse order, making sure all parts are correctly fitted.

To lower the top heat/grill element

Make sure the oven heating elements are switched off and cool. Take care not to burn yourself on them.

- Remove the shelf runners from the oven.

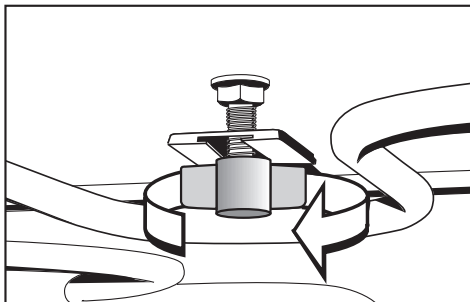

- Unscrew the wing nut and lower the top heating element.

Do not use force to pull it down as this can cause the element to break.

Take care when cleaning the ceiling of the oven that you do not damage the receiver for the food probe located in the middle of the heating element.

Reassemble them in the reverse order, making sure all parts are correctly fitted.

Make sure that the wing nut is screwed back on properly.

Cleaning and care

Descaling

Only use the descaling tablets supplied with the appliance. These have been specially formulated and are available from the Miele Spare Parts Department or via the internet on www.miele-shop.com.

Other types of descaling agents will damage the oven.

Follow the instructions on the package carefully to avoid damaging the oven.

Clean the oven interior after descaling to ensure that all traces of descaling agent have been removed.

When to run the descaling programme

The descaling programme can be run at any time.

However, to ensure the oven functions correctly you will be automatically prompted to run the descaling programme after a certain number of oven uses.

Descaling process (overview)

The descaling process takes approx. 90 minutes and includes a number of stages:

- ① Preparing the descaling solution
- ② Drawing in the descaling solution
- ③ Activation phase
- ④ Rinse 1
- ⑤ Rinse 2
- ⑥ Rinse 3
- ⑦ Evaporating the residual moisture

Preparation

- Dissolve one descaling tablet in approx. 600 ml of cold tap water.
- Place the universal tray on the top shelf level to collect the descaling solution after it has been used.

A plastic tube (with clip) is supplied with your oven so that you do not have to hold the container with the descaling agent underneath the water intake tube.

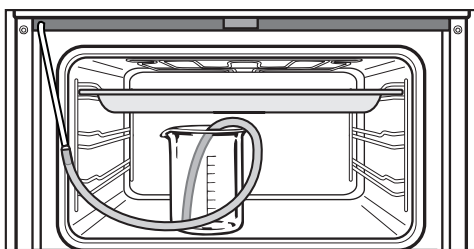

- Attach the plastic tube to the end of the water intake tube. Place the other end in the bottom of the descaling solution container and secure it to the container with the clip.
- Close the door.

Start the descaling process.

- Select the "Descale" option.
- Press the OK sensor to start the suction process.

The segment display shows how the descaling process is progressing. You can hear the pump during the descaling process.

The amount of solution specified can be more than the amount which is actually taken in which means that some of the solution will be left in the container at the end of descaling. Top the container up with approx. 300 ml of water to the container, as the system will need to draw in some more liquid during the activation phase.

Once the descaling solution has been drawn into the appliance

- "Activation phase" will appear in the display.
The activation phase takes approx. 60 minutes.
- the time left for the activation phase will be shown counting down in the display.

The system will take in more liquid at approximately five minute intervals. You will hear the noise of the pump for a moment or so.

The oven lighting and the cooling fan will remain on during descaling.

Cleaning and care

The steam injection system will need to be cleaned **at the end of the descaling process** to remove all traces of descaling solution.

Prompts to do this will appear in the display.

Cleaning is carried out by flushing approx. 1 litre of mains tap water through the system. The water is collected in the universal tray. This process is repeated three times.

- Take the universal tray out of the oven and empty it. Place the tray back in the oven again at the top shelf level.
- Unclip the plastic tube from the container. Rinse the container and fill with approx. one litre of tap water. Place the container in the oven, insert the plastic tube and secure it to the container with the clip.
- Start the first rinse.
- Repeat twice.

Empty the universal tray before the second and third rinse.

After the third rinse, residual water will need to be evaporated from the steam injection system.

Before proceeding, remove the plastic tube and the container from the oven.

The oven will heat up to "Evaporate residual moisture". The time counts down in the display.

Allow the oven to cool down before cleaning by hand. Danger of burning.

- Remove the universal tray and empty it. Clean the oven interior to remove any condensation and descaling agent residue.

Leave the oven door open until the oven interior is completely dry.

Problem solving guide



With the aid of the following guide, minor problems can be easily corrected without contacting Miele.

If you cannot resolve a problem following these instructions please contact Miele Service.

 Do not attempt to open the appliance casing yourself! Installation, maintenance and repairs may only be carried out by a suitably qualified and competent person in strict accordance with current national and local safety regulations. Repairs and other work by unqualified persons could be dangerous. The manufacturer cannot be held liable for unauthorised work.

Problem	Possible cause and remedy
The display is dark.	<ul style="list-style-type: none">– Check whether the time display is set so that it does not show in the display (see "Settings - Time (of day) display").– Check whether the mains fuse has tripped. If it has not tripped, contact a qualified electrician or the Miele Service Department.
The oven does not heat up.	<ul style="list-style-type: none">– Check if the system lock  has been activated.– Check whether the demo programme mode has been activated (see "Settings - Showroom programme").– Check whether the mains fuse has tripped. If it has not tripped, contact a qualified electrician or the Miele Service Department.
A noise can be heard after a cooking programme.	The cooling fans remain switched on after the end of a cooking programme (see "Settings - Cooling fan run-on").
The door cannot be opened at the end of a pyrolytic cleaning programme.	Switch the appliance off. If the door lock will still not open please contact the Miele Service Department.

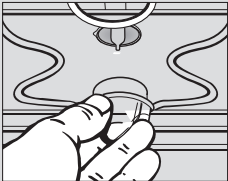
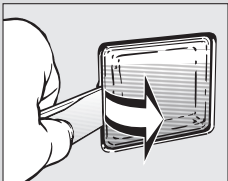
Problem solving guide

Problem	Possible cause and remedy
<p>The top lighting is not working.</p> 	<ul style="list-style-type: none"> ■ Disconnect the appliance from the electricity supply: Switch off and unplug at the socket, or disconnect the fuse, or switch off at the isolator as appropriate. ■ Turn the lamp cover a quarter turn anti-clockwise to release it and then pull it downwards to take it out. ■ Replace it with a new halogen lamp (Osram 66725 AM/A, 230 V, 25 W, G9). ■ Refit the lamp cover and turn it clockwise to secure it. ■ Reconnect the appliance to the mains electricity supply.
<p>The side lighting is not working.</p> 	<ul style="list-style-type: none"> ■ Disconnect the appliance from the electricity supply: Switch off and unplug at the socket, or disconnect the fuse, or switch off at the isolator as appropriate. ■ Remove the shelf runners. ■ Use the lever supplied to release the lamp cover from its frame. ■ Replace it with a new halogen lamp (Osram 66725 AM/A, 230 V, 25 W, G9). ■ Push the lamp cover back into its retainers, and replace the shelf runners. ■ Reconnect the appliance to the mains electricity supply.
<p>Cakes and biscuits are not cooked properly after following the times given in the chart.</p>	<ul style="list-style-type: none"> – Check that the correct temperature has been set. – Check whether there has been a change to the recipe. The addition of more liquid or more eggs makes a moister mix which would need longer to cook.
<p>Cakes and biscuits are browning unevenly.</p>	<p>There will always be a slight unevenness. If browning is very uneven check that the correct temperature was set and that the correct shelf level was used.</p> <p>With conventional heat  the material and colour of the tin used plays an important role. Light coloured, shiny tins are less suitable.</p>

Problem solving guide

Problem	Possible cause and remedy
"Maximum operating duration reached" appears in the display.	Safety switch-off has been activated. The appliance will be ready for use again after it has been switched off and then back on again.
The oven has automatically switched itself off after a cooking programme.	The oven switches off automatically to save energy if, at the end of an Automatic programme or a cooking programme with Automatic switch-off, no other cooking function is selected within a certain time period. The oven is ready for use again when you switch it on.
A fault code appears in the display: F + a number	You can rectify the faults with the following codes yourself: <ul style="list-style-type: none"><li data-bbox="325 528 1050 783">– Fault 23: The temperature required for pyrolytic cleaning was not reached. This could have been caused by too much soiling in the oven to start with. Remove all coarse soiling before starting the pyrolytic cleaning programme again. If the fault message appears again please contact the Miele Service Department.<li data-bbox="325 788 1050 979">– Fault 32: The door has not locked for the pyrolytic cleaning process. Switch the oven off and start the pyrolytic cleaning process again. If the fault code appears again call the Miele Service Department.<li data-bbox="325 984 1050 1150">– Fault 33: The door lock for the pyrolytic cleaning process will not open. Interrupt the pyrolytic cleaning programme by switching the oven off. If the door will still not open please contact the Miele Service Department. For all other fault codes please contact the Miele Service Department.

After Sales / Guarantee

After sales service

In the event of a fault which you cannot correct yourself, or if the appliance is under guarantee, please contact

– your Miele Dealer

or

– Miele (see back cover for contact details).

A call-out charge will be applied for service visits where the problem could have been resolved as described in these instructions.

When contacting your Dealer or Miele, please quote the model and serial number of your appliance.

This information is given on the data plate, visible on the front frame of the oven, with the door fully open.

Please note that telephone calls may be monitored and recorded for training purposes.

Guarantee

For information on the appliance guarantee specific to your country please contact Miele. See back cover for contact details.

In the UK, your appliance is guaranteed for 2 years from the date of purchase. However, you must activate your cover by calling 0845 365 6640 or registering online at www.miele.co.uk.

Optional accessories

A range of additional accessories as well as cleaning and care products are available for your Miele oven. Depending on product they are available to order from your Miele Dealer, the Miele Spare Parts Department or via the internet on www.miele-shop.com.

FlexiClip telescopic runners

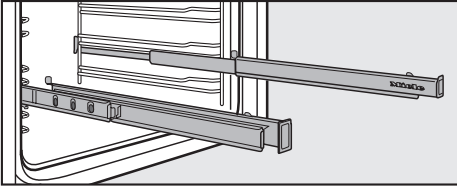

More FlexiClip telescopic runners can be installed in the oven in addition to those supplied.

Baking tray, universal tray and rack

These items, supplied with your oven, are also available to order.

When ordering, please quote the model number of your appliance.

Pizza stone

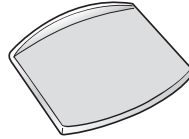

The pizza stone is ideal for items which need a well baked base such as pizza, quiche, bread, bread rolls and savoury snacks.

The pizza stone is made from heat retaining fire brick and is glazed.

Place it directly on the rack.

A paddle made of untreated wood is supplied with it for placing food on the pizza stone and taking it off.

Flan/Pizza dish

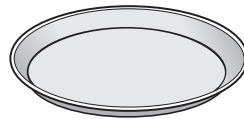

This circular pan is suitable for cooking pizzas, flat cakes made with yeast or whisked mixtures, sweet and savoury tarts, baked desserts, and can also be used for frozen cakes and pizzas.

The surface has been treated with PerfectClean enamel.

Optional accessories

Gourmet oven dish

The gourmet oven dish can be placed in the oven directly on the runners. It has non-tip safety notches like the universal tray to prevent it being pulled out too far.

It has an anti-stick coating.

It is available in two sizes:

- HUB 5000-M (internal dimensions: approx. 38 x 22 x 8 cm)

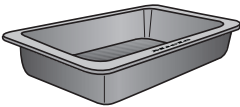

- HUB 5000-XL (internal dimensions: approx. 38 x 35 x 8 cm)

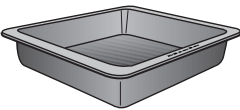

Gourmet oven dish lid

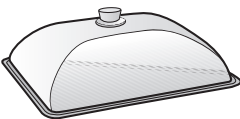
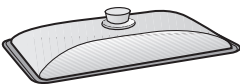

When ordering a lid, please specify the gourmet oven dish it is to be used with (HUB 5000 M or XL).

Please note:

The HUB 5000-XL gourmet oven dish will not fit in this compact oven with the lid on as it will be too high.

Miele E-cloth

Removes grease and stains and leaves no smearing. Suitable for cleaning surfaces such as stainless steel, glass, plastic and chrome without the use of chemicals.

Oven cleaner

Suitable for removing stubborn soiling. It is not necessary to pre-heat the oven beforehand.

All electrical work should be undertaken by a suitably qualified and competent person in strict accordance with current national and local safety regulations (BS 7671 in the UK).

Installation, repairs and other work by unqualified persons could be dangerous. The manufacturer cannot be held liable for unauthorised work.

Ensure power is not supplied to the appliance until after installation or repair work has been carried out.

The **voltage and connected load** are given on the data plate, visible below the oven interior, with the door open. Ensure that these match the household mains supply. Please quote these data, and the model and serial number when contacting Miele.

Connection of this appliance should be made via a fused connection unit or a suitable isolator, which complies with national and local safety regulations, and the on/off switch should be easily accessible after the appliance has been built in.

If the switch is not accessible after installation (depending on country) an additional means of disconnection must be provided for all poles.

For extra safety it is advisable to protect the appliance with a residual current device (RCD). Please contact a qualified electrician for advice.

When switched off there must be an all-pole contact gap of 3 mm in the

isolator switch (including switch, fuses and relays acc. to EN 60 335).

Important U.K.

The appliance is supplied for connection to a 230-240 V, 50 Hz supply with a 3-core cable.

The wires in the mains lead are coloured in accordance with the following code:

Green/yellow = earth

Blue = neutral

Brown = live

WARNING THIS APPLIANCE MUST BE EARTHED

When replacing the cable supplied with another cable or changing the connection, only cable type H 05 VV-F or H 05 RR-F with a suitable cross-sectional area (CSA) may be used (available from the Miele Customer Contact Centre).

Building-in diagrams

Dimensions are give in "mm".

Appliance dimensions and unit cut-out

Installation in a base unit

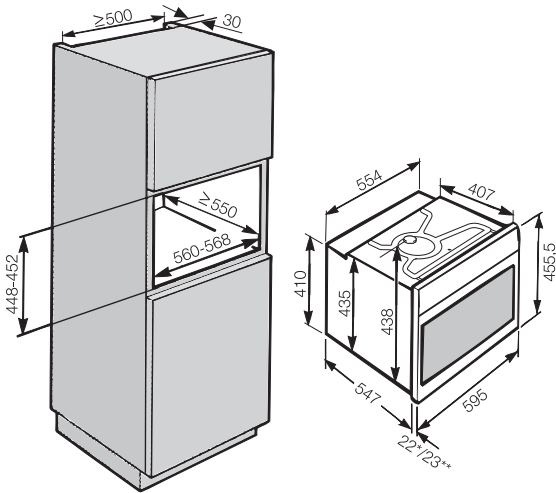

Installation in a tall unit

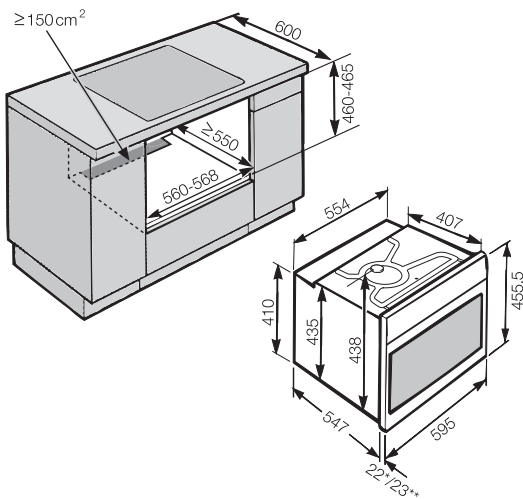

* Appliances with glass front

** Appliances with metal front

Front dimensions

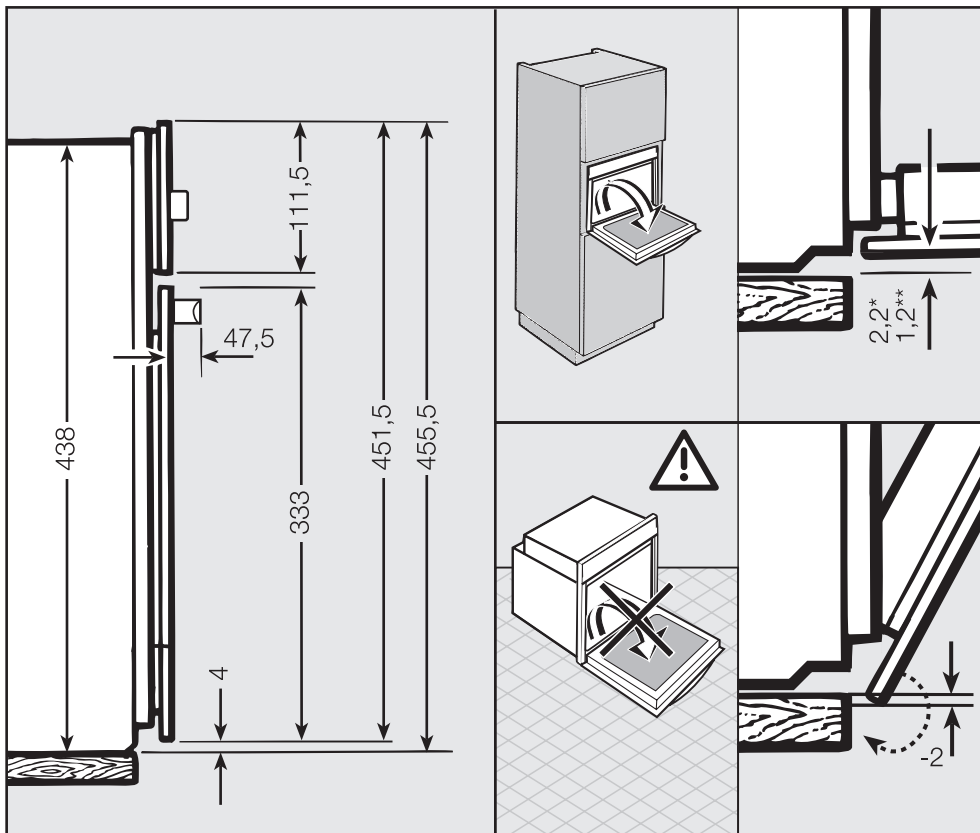

* Appliances with glass front

** Appliances with metal front

Installing the oven

 The appliance must not be operated until it has been correctly installed in its housing unit. Otherwise it poses an electric shock hazard.

To ensure adequate ventilation to the oven once installed:

- do not fit a rear panel into the housing unit.
- make sure that the shelf on which the appliance is placed does not touch the wall.
- do not fit insulation material inside the housing unit.

When installing the appliance do not lift it up by the door handle as this can damage the door.

 Turn off the mains electricity supply to the isolator.

- Connect the mains cable from the oven to the isolator.

It is a good idea to remove the door before installing the appliance. The oven will then be lighter to lift when you are positioning it the housing unit and also it will not be possible to use the handle to lift it by mistake.

- Push the appliance back into the housing unit and align it.
- Open the door (if you have not removed it previously).

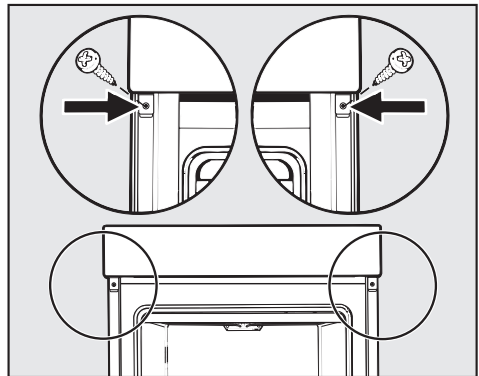

- Use the screws supplied to secure the appliance to the side walls of the housing unit through the holes in the oven trim.
- Replace the door (if you removed it before installing the appliance). See "Cleaning and care - To refit the door").

United Kingdom

Miele Co. Ltd.
Fairacres, Marcham Road
Abingdon, Oxon, OX14 1TW
Tel: 0845 365 0555
Fax: 0845 365 0777
Customer Contact Centre Tel: 0845 365 6600
E-mail: info@miele.co.uk
Internet: www.miele.co.uk

Australia

Miele Australia Pty. Ltd.
ABN 96 005 635 398
1 Gilbert Park Drive, Knoxfield, VIC 3180
Tel: 1300 464 353, Fax: (03) 9764 7149
Internet: www.miele.com.au

China

Miele (Shanghai) Trading Ltd.
1-3 Floor, No. 82 Shi Men Yi Road
Jing' an District
200040 Shanghai, PRC
Tel: +86 21 6157 3500
Fax: +86 21 6157 3511
E-mail: mieleshanghai@cn.miele.com
Internet: www.miele.cn

Miele (Hong Kong) Limited

41/F - 4101, Manhattan Place
23 Wang Tai Road
Kowloon Bay
Hong Kong
Tel: (852) 2610 1331
Fax: (852) 2610 1013
Email: mielehk@miele.com.hk

India

Miele India Pvt. Ltd.
Ground Floor, Copia Corporate Suites
Plot No. 9, Jasola
New Delhi - 110025
Tel: 011-46 900 000, Fax: 011-46 900 001
E-mail: customercare@miele.in
Internet: www.miele.in

Manufacturer: Germany - Miele & Cie. KG
Carl-Miele-Straße 29, 33332 Gütersloh



Ireland

Miele Ireland Ltd.
2024 Bianconi Avenue
Citywest Business Campus, Dublin 24
Tel: (01) 461 07 10, Fax: (01) 461 07 97
E-Mail: info@miele.ie, Internet: www.miele.ie

New Zealand

Miele New Zealand Limited
Unit L, 10-20 Sylvia Park Road
Mt. Wellington, 1060, Auckland, NZ
Tel: 0800 264 353, Fax: 0800 463 453
Internet: www.miele.co.nz

Singapore

Miele Southeast Asia
Miele Pte. Ltd.
163 Penang Road
04 - 02/03 Winsland House II
Singapore 238463
Tel: +65 6735 1191, Fax: +65 6735 1161
E-Mail: infosea@miele.com.sg
Internet: www.miele.sg

South Africa

Miele (Pty) Ltd
63 Peter Place, Bryanston 2194
P.O. Box 69434, Bryanston 2021
Tel: +27 (0) 11 548-1900
Fax: +27 (0) 11 548-1935
E-mail: info@miele.co.za
Internet: www.miele.co.za

United Arab Emirates

Miele Appliances Ltd.
P.O. Box 11 47 82
Gold & Diamond Park
Sheikh Zayed Road
Building 6 / Offices Nos. 6-214 to 6-220
Dubai
Tel: +971-4-341 84 44
Fax: +971-4-341 88 52
E-Mail: info@miele.ae
Internet: www.miele.ae



Free Manuals Download Website

<http://myh66.com>

<http://usermanuals.us>

<http://www.somanuals.com>

<http://www.4manuals.cc>

<http://www.manual-lib.com>

<http://www.404manual.com>

<http://www.luxmanual.com>

<http://aubethermostatmanual.com>

Golf course search by state

<http://golfingnear.com>

Email search by domain

<http://emailbydomain.com>

Auto manuals search

<http://auto.somanuals.com>

TV manuals search

<http://tv.somanuals.com>