

Miele

Operating and installation instructions



Oven H 5961 B



To avoid the risk of accidents or damage to the appliance it is **essential** to read these instructions before it is installed and used for the first time.

en - GB



M.-Nr. 07 649 830

Contents

Warning and Safety instructions	6
Caring for the environment	11
Guide to the appliance	12
Features	13
Oven controls	13
Safety features	13
System lock	13
In operation lock	13
Safety switch-off	13
Cooling fans	13
Vented oven door	13
Energy saving features	14
User instructions	15
Moisture plus	15
"Moisture plus" recipe booklet	15
PerfectClean treated surfaces	15
Catalytic enamelled surfaces	15
Energy efficiency rating according to EN 50304	15
Accessories	16
Universal tray and rack with anti-tip safety notches	16
FlexiClip telescopic runners	17
Fitting the FlexiClip telescopic runners	17
Changing the position of the FlexiClip telescopic runners	18
Anti-splash insert	18
Food probe	18
Opener	18
Descaling tablets, Plastic tube with clip	18
Miele@home	19
Optional accessories	19
Controls	20
Sensors	20
Display	21
Main menu	21
Symbols	22
Functions	24
Before using for the first time	26
To enter basic settings	26

Cleaning and heating up for the first time	27
Operation	28
Automatic programmes	28
Manual operation	29
Selecting a function	29
Recommended temperature, Selecting the temperature	30
Entering the Duration, a Start time or Finish time	30
To use Automatic switch-off	31
Delaying the start with Automatic switch-off	31
Sequence of the cooking programme when using Automatic switch-off	32
The following will appear in the display:	32
Changing or deleting an entered cooking time	32
Changing the heating-up phase	33
Pre-heating the oven	33
Activating moisture reduction	34
Change function	34
User programmes	34
The User programmes menu	34
To create a User programme	35
To call up an existing User programme	35
Food probe	36
How it works	36
When to use it	36
Important notes about using the food probe	36
To use the food probe	37
Time left display	38
Making use of residual heat	38
Moisture plus	39
Automatic programmes	40
Night baking	40
Moisture plus 	41
Number of bursts of steam and when they are injected	41
Using Moisture plus 	42
To evaporate residual moisture	43
The residual moisture evaporation process	43
To start the residual moisture evaporation process	43
To cancel the residual moisture evaporation process	44
Descaling	44

Contents

Minute minder (egg timer) 	45
Settings	46
Language 	46
Time	47
Time (of day) display	47
Clock format	47
To set the time	47
Lighting	47
Main menu	48
Catalyser	48
Cooling fan run-on	48
Heating-up phase	49
Start	49
Recommended temperatures	49
Display	49
Contrast	49
Brightness	49
Volume	50
Buzzer tones	50
Frequency	50
Keypad tone	50
Safety	51
System lock 	51
In operation lock	51
Units	52
Temperature	52
Showroom programme	52
Factory default	52
Cleaning and care	53
Appliance front	53
Accessories	54
Universal tray	54
Rack, runners	54
Food probe	54
FlexiClip telescopic runners	54
Oven interior	56
Seal and inside of the oven door	56

PerfectClean	57
Catalytic enamel surfaces	59
To remove the oven door.	60
To dismantle the oven door	61
To refit the door	64
To remove the FlexiClip telescopic runners	65
To remove the side runners.	65
To remove the back panel.	66
To lower the top heat/grill element.	66
Descaling.	67
When to run the descaling programme	67
Descaling process (overview)	67
Preparation	68
Start the descaling process.	68
Problem solving guide	70
After sales service	73
Optional accessories	74
Electrical connection.	76
Building-in diagrams	78
Installing the oven	81

Warning and Safety instructions

This appliance conforms to current safety requirements. Inappropriate use can, however, lead to personal injury and damage to property.

To avoid the risk of accidents and damage to the appliance, please read these instructions carefully before using it for the first time. They contain important notes on installation, safety, use and maintenance.

Keep these instructions in a safe place and ensure that new users are familiar with the contents. Pass them on to any future owner.

Correct application

► This oven is not designed for commercial use. It is intended for use in domestic households and for use in similar working and residential environments such as:

- Shops
- Offices and showrooms

and by residents in establishments such as:

- Hostels and guest houses

It is intended for domestic use only to cook food, and in particular to bake, roast, grill, defrost and dry food.

Any other use is not supported by the manufacturer and could be dangerous. Miele cannot be held liable for damage resulting from incorrect or improper use or operation of the appliance.

► This appliance is not intended for use by persons (including children) with reduced physical, sensory or mental capabilities, or lack of experience and knowledge, unless they are supervised whilst using it, or have been shown how to use it correctly by a person responsible for their safety.

Safety with children

► This appliance is not a toy! To prevent the risk of injury or damage do not let children play with the appliance or its controls.

► Older children may only use the oven when its operation has been clearly explained to them and they are able to use it safely, recognising the dangers of misuse.

► Great care should be taken to ensure that children do not touch the appliance when it is being used. Children's skin is far more sensitive to high temperatures than that of adults. External parts of the oven such as the door glass, control panel and the vent become quite hot.

Warning and Safety instructions

Technical safety

► Installation, maintenance and repairs may only be carried out by a suitably qualified and competent person in strict accordance with current national and local safety regulations. Repairs and other work by unqualified persons could be dangerous. The manufacturer cannot be held liable for unauthorised work.

► Before installation, check the appliance for visible signs of damage. Do not install and use a damaged appliance. A damaged appliance could be dangerous.

► The electrical safety of this appliance can only be guaranteed when continuity is complete between it and an effective earthing system. It is most important that this basic safety requirement is present and tested regularly, and where there is any doubt the household wiring system should be inspected by a qualified electrician. The manufacturer cannot be held liable for the consequences of an inadequate earthing system (e.g. electric shock).

► Before connecting the appliance, make sure that the connection data on the data plate (voltage and connected load) match the mains electricity supply. This data must correspond in order to avoid the risk of damage to the appliance. Consult a competent person if in doubt.

► Do not connect the appliance to the mains electricity supply by a multi-socket unit or an extension lead. These do not guarantee the required safety of the appliance (e.g. danger of overheating).

► For safety reasons, this appliance may only be used when it has been built in.

► Never open the housing of the appliance. Tampering with electrical connections or components and mechanical parts is highly dangerous to the user and can cause operational faults.

► While the appliance is under guarantee, repairs should only be undertaken by a service technician authorised by the manufacturer. Otherwise the guarantee will be invalidated.

► In countries where there are areas which may be subject to infestation by cockroaches or other vermin, pay particular attention to keeping the appliance and its surroundings in a clean condition at all times. Any damage which may be caused by cockroaches or other vermin will not be covered by the guarantee.

Warning and Safety instructions

► During installation, maintenance and repair work, the appliance must be disconnected from the mains electricity supply. It is only completely isolated from the electricity supply when:

- the mains fuse is disconnected,
- the screw-out fuse is removed (in countries where this is applicable),
- it is switched off at the isolator.

Ensure that current is not supplied to the appliance until after maintenance or repair work has been carried out.

► Faulty components must only be replaced by genuine Miele original spare parts. The manufacturer can only guarantee the safety of the appliance when Miele replacement parts are used.

► If the supply cord is damaged, it must be replaced by a Miele approved service technician to avoid a hazard.

► This appliance may only be used in mobile installations such as ships, caravans, aircraft etc. if a risk assessment of the installation has been carried out by a suitably qualified engineer.

Correct use

Caution. Danger of burning.
High temperatures are produced by the oven.

► Use oven gloves when placing food in the oven, turning or removing it and when adjusting oven shelves etc. in a hot oven. Be very careful that you do not burn yourself on the top heating/grill element.

► Never leave the appliance unattended when cooking with oil or fats, as these are a fire hazard if allowed to overheat.

► Do not exceed the recommended grilling times when using the Full grill, Economy grill and Fan grill functions. Excessively long grilling times can lead to food drying out and burning, or could even cause it to catch fire.

► Do not use the Full grill, Economy grill or Fan grill to finish baking par-cooked rolls or bread or to dry flowers or herbs. Fire hazard.
Use Fan plus or Conventional heat instead.

Warning and Safety instructions

▶ If using alcohol in your recipes, high temperatures can cause the alcohol to vaporise and even to ignite on the hot heating elements.

Alcohol should be burnt off before the dish is placed in the oven to avoid this danger.

▶ Cover any food which is left in the oven to be kept hot. Any moisture in the food could lead to corrosion damage in the oven. This also prevents the food from drying out.

▶ If you wish to complete a cooking process using the residual heat in the oven, leave the oven at the function selected and select the lowest temperature for that function. Do not switch the appliance off until the food has been removed. Increased moisture in the oven could cause condensation to form which could lead to

- corrosion inside the oven compartment.
- damage to the control panel, worktop and surrounding kitchen furniture.

▶ Do not line the floor of the oven with aluminium foil when using Conventional heat, Bottom heat or Intensive bake. This would cause a build-up of heat which could cause damage to the floor of the oven.

For this reason do not place a dish, tin or baking tray directly on the oven floor.

If using a tray made by a different manufacturer, make sure that there is a gap of at least 6 cm between the bottom of the tray and the floor of the oven.

▶ Never pour cold water onto a hot universal tray or add directly onto food in a hot oven. The steam created could cause serious burns or scalding and the sudden change in temperature can damage the enamel.

▶ Always ensure that food is suitably cooked or reheated. Some foods may contain micro-organisms which are only destroyed by thorough cooking at temperatures over 70°C for a minimum of 10 minutes. Therefore when cooking or reheating foods, e.g. poultry, it is particularly important that food is fully cooked through. If in doubt select a longer cooking or reheating time.

It is important that the heat is allowed to spread evenly throughout the food being cooked. This can be achieved by stirring and/or turning the food during cooking.

▶ If using plastic containers for cooking, they must be declared by the manufacturer as being suitable for use in an oven. Other types of plastic containers melt at high temperatures, and could damage the oven.

Warning and Safety instructions

▶ Do not heat up unopened tins or jars of food in the oven. Pressure can build up and they may explode, resulting in injury or damage.

▶ Do not push pots and pans around on the oven floor, as this could damage the surface.

▶ Do not lean or sit on an open oven door, or place heavy items on it. Make sure that nothing gets trapped between the door and the oven compartment. This could damage the oven. The oven door can support a maximum load of 15 kg.

▶ Do not use the appliance to heat up the room. Due to the high temperatures radiated, objects near the appliance could catch fire.

Accessories

▶ Only use genuine Miele spare parts and accessories with this appliance. If spare parts or accessories from other manufacturers are used, this will invalidate the guarantee, and Miele cannot accept liability.

▶ Only use the Miele food probe supplied with this oven. If a replacement is necessary it can be obtained from the Miele Spare Parts Department or your Miele dealer.

The manufacturer cannot be held liable for damage caused by non-compliance with these Warning and safety instructions.

Disposal of the packing material

The transport and protective packing has been selected from materials which are environmentally friendly for disposal, and should be recycled.

Ensure that any plastic wrappings, bags, etc. are disposed of safely and kept out of the reach of babies and young children. Danger of suffocation.

Disposal of your old appliance

Electrical and electronic appliances often contain materials which, if handled or disposed of incorrectly, could be potentially hazardous to human health and to the environment. They are, however, essential for the correct functioning of your appliance. Please do not therefore dispose of it with your household waste.

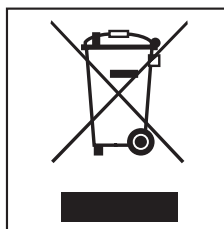

Please dispose of it at your local community waste collection / recycling centre or contact your dealer for advice. Ensure that it presents no danger to children while being stored for disposal.

Guide to the appliance

H 5961 B

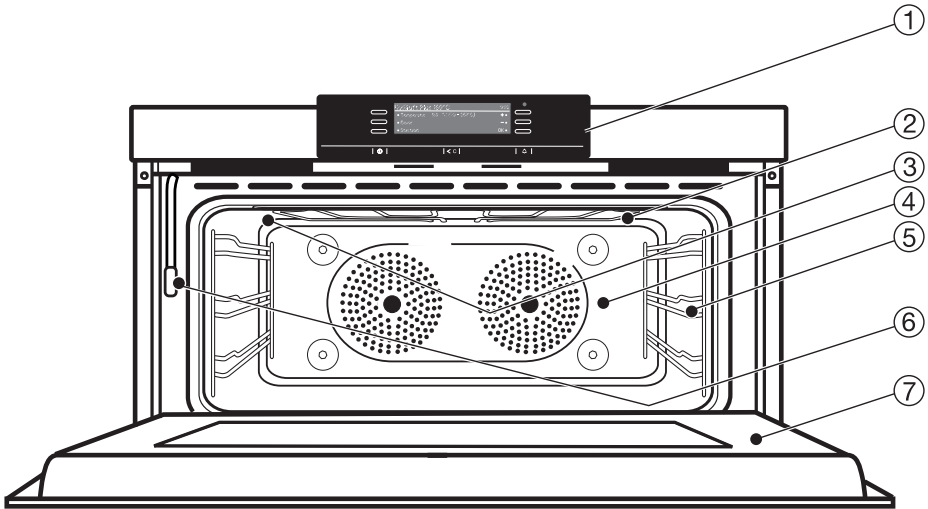

- ① Control panel
- ② Top heat/grill element
- ③ Steam inlet openings for Moisture plus
- ④ Back panel with air inlets for the fan
- ⑤ Side runners with three shelf levels
- ⑥ Water intake tube for the steam injection system
- ⑦ Door

Oven controls

In addition to operating the various cooking programmes to bake, roast and grill, the controls also offer the following:

- a time of day display,
- a minute minder,
- a timer for programming cooking durations,
- user programmes,
- automatic programmes,
- settings that can be customised.

Safety features

System lock

The system lock  prevents the oven from being used unintentionally by children, for example. See "Settings - Safety".

In operation lock

The reaction time when the sensors are touched can be extended in order, for example, to prevent the appliance being switched off unintentionally. See "Settings – Safety".

Safety switch-off

Safety switch-off is triggered automatically if the oven is operated for an unusually long period of time. The period of time will depend on the oven function selected.

Cooling fans

The cooling fans will come on automatically when a cooking programme is started. The cooling fans mix hot air from the oven cavity with cool room air before venting it out into the kitchen through vents located between the appliance door and the control panel.

The cooling fans will continue to run for a while after the oven has been switched off to prevent any humidity building up in the oven, on the control panel or on the oven housing unit.

Vented oven door

The oven door is an open system and some of the door panes have a heat-reflecting coating. During operation, cool air is passed through the oven door to keep the outer pane cool.

If necessary, the oven door can be dismantled for cleaning.

Features

Energy saving features

Lighting

The oven lighting is set to switch off 15 seconds after the start of a cooking programme (default setting). See "Settings - Lighting".

Door contact switch

If the oven door is opened during operation, the door contact switch automatically switches off the heating elements and the fan, if a "Fan" setting is being used. This helps reduce the amount of heat lost from the oven interior, e.g. when basting roast meat. At the same time, the oven lighting is switched on.

Using residual heat

The oven heating switches off automatically shortly before the end of a cooking programme where the cooking duration has been programmed or the food probe is being used. The residual heat in the oven is sufficient to complete the cooking process.

"Energy save" will appear in the display.

The cooling fans continue to run, as does the hot air fan if a "Fan" setting has been chosen.

Energy save mode

The oven switches off automatically to save energy if, at the end of an Automatic programme or a cooking programme with Automatic switch-off, no other cooking function is selected within a certain time period.

This time period depends on the settings selected (cooking function, temperature, cooking duration).

Either the time of day is displayed or the display is dark: see "Settings - Time - Display".

User instructions

The User instructions supplied with your appliance in addition to these Operating and installation instructions contain detailed information about the following:

- Automatic programmes
- Baking
- Roasting
- Slow cooking
- Grilling
- Defrosting
- Cooking ready meals
- Automatic programme recipes

Moisture plus

This function injects moisture during the cooking process, giving excellent results when cooking various types of food, such as bread or meat.

Moisture plus is activated during some Automatic programmes, and can also be used as a separate function for manually injecting bursts of steam.

"Moisture plus" recipe booklet

This separate booklet supplied with your oven in addition to these Operating and installation instructions contains recipes and information on using Automatic programmes with Moisture plus and the Moisture plus function.

PerfectClean treated surfaces

The following surfaces are all treated with a special PerfectClean finish:

- Oven interior,
- Runners,
- Universal tray,
- Rack

PerfectClean surfaces have very good anti-stick properties and are much easier to keep clean than conventional enamel, if cleaned regularly.

The **FlexiClip telescopic runners** also have a PerfectClean finish. PerfectClean surfaces have an iridescent appearance.

See "Cleaning and care" for more information.

Catalytic enamelled surfaces

The back panel is coated with dark grey catalytic enamel. Soiling from oil and fat is burnt off these surfaces when very high temperatures are used in the oven.

See "Cleaning and care" for more information.

Energy efficiency rating according to EN 50304

This appliance is rated energy efficiency class **B** in accordance with EN 50304.

Tests were carried out using "Fan plus  with the FlexiClip telescopic runners removed. The catalyser should be switched off during testing, see "Settings - Catalyser - Off next programme only".

Features

Accessories

The following accessories are supplied with this oven.

These and other accessories are also available to order from the Miele Spare Parts Department, your Dealer or via the internet on www.miele-shop.com.

Universal tray and rack with anti-tip safety notches

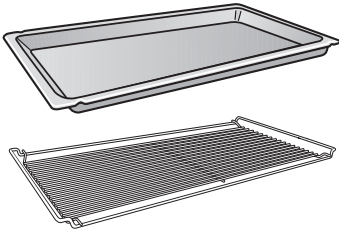

The universal tray and rack are inserted into the oven between the two rails of a shelf runner.

The universal tray and rack have non-tip safety notches which prevent them being pulled right out when they only need to be partially pulled out.

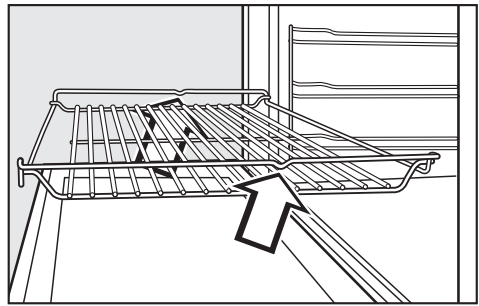
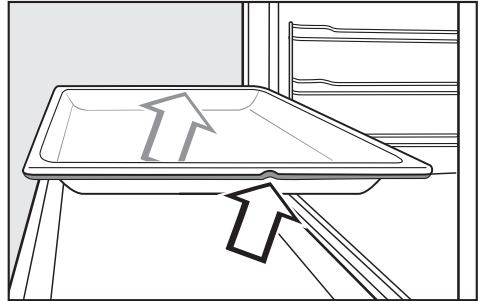

When pushing the rack back in, always ensure that the safety notches are at the rear of the oven (see illustration).

They can then only be taken out of the oven by raising them upwards and then pulling them out.

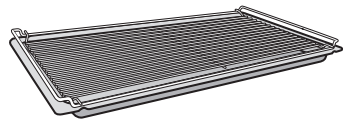

If you are using a tray with the rack on top, insert the tray between the rails of a shelf runner and the rack will sit on top of it.

FlexiClip telescopic runners

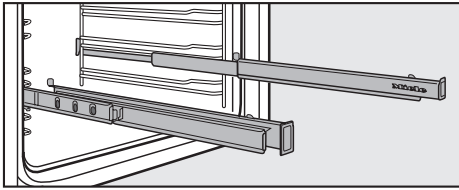

The FlexiClip telescopic runners can be clipped into any of the existing shelf runners and pulled out of the oven to their fullest extent.

Push the telescopic runners right in before placing a tray or rack on them.

To prevent the risk of a rack or tray sliding off the runners, make sure that they are sitting securely on their runners in between the stoppers at either end of each runner.

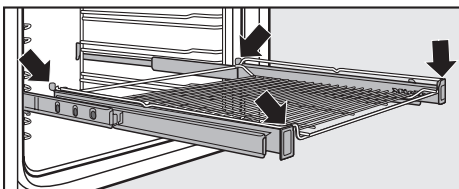
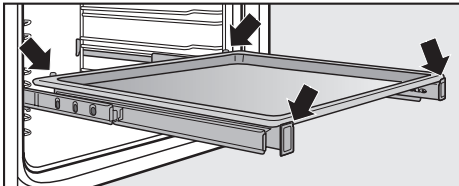

The FlexiClip runners can support a maximum load of 15 kg.

Fitting the FlexiClip telescopic runners

Make sure that the oven has cooled down before moving the FlexiClip runners.
Take care not to burn yourself on them.

The FlexiClip runners are fitted in between the two rails that make up a shelf level.

The telescopic runner with the Miele logo is fitted on the right.

When fitting the FlexiClip runners **do not** extend them.

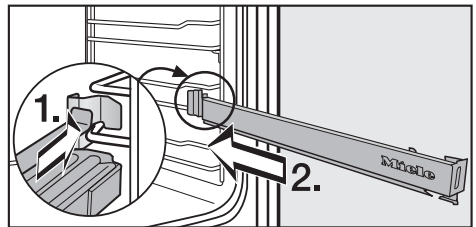

- Fit the FlexiClip runner in between the two rails at the front (1) and then push it into the oven compartment (2).

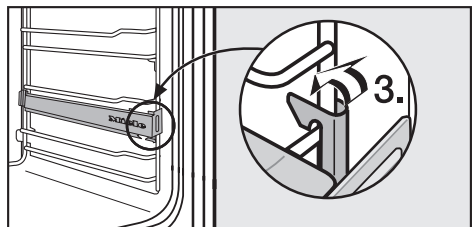

- Then secure the FlexiClip runner to the bottom of the two rails as illustrated (3).

If the FlexiClip runners are difficult to pull out after fitting, you may need to pull firmly on them once to release them.

Features

Changing the position of the FlexiClip telescopic runners

Make sure that the oven has cooled down before moving the FlexiClip runners. Take care not to burn yourself on them.

To change the position of the FlexiClip runners:

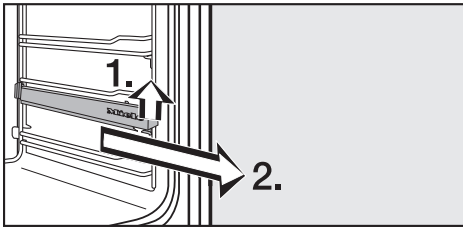

- Remove the FlexiClip runners from their original position by raising them at the front, then pulling them forwards and out.
- Insert them at the required shelf level; see "Features - Fitting the FlexiClip telescopic runners".

Anti-splash insert

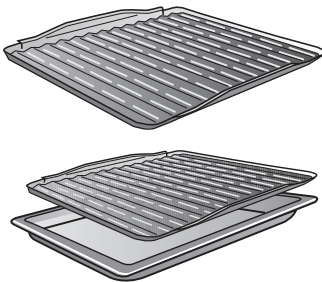

The anti-splash insert should be placed in the universal tray when grilling or roasting.

The juices from the food being cooked collect under the anti-splash tray. This prevents them from spitting and making

the oven dirty. The juices can then be used for making gravy and sauces.

Food probe

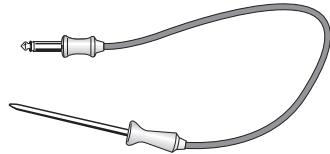

The food probe enables the roasting process to be monitored simply and reliably.

See "Food probe" for detailed information on how to use it.

Opener

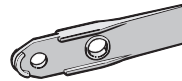

This opener is used to remove the cover of the lighting in the sides of the oven.

Descaling tablets, Plastic tube with clip

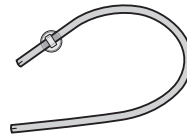

These are required for descaling the appliance.

Miele@home enabled appliances send information via the household wiring network ③ to the master appliance ④ / ⑤ about the operational status of the appliances, as well as information about the progress of the programme.

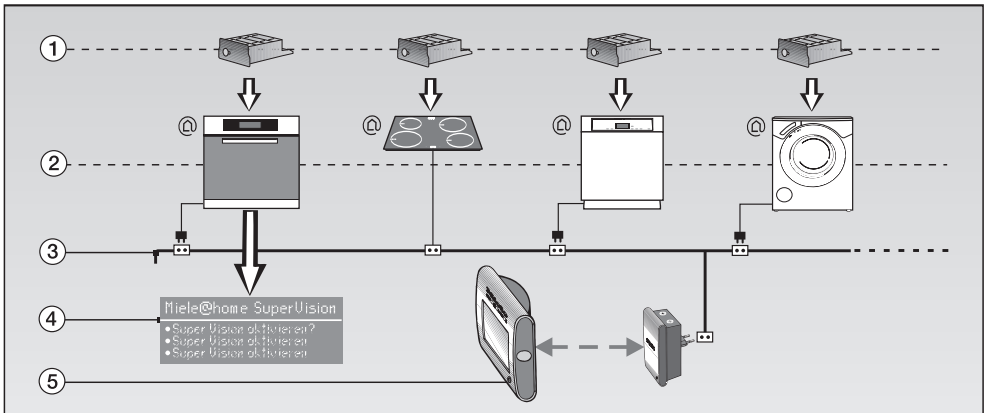

These instructions are for a communication enabled oven ② that can be linked into the Miele@home system via a Miele@home installation kit and a communication module ① (optional accessories).

The Miele@home installation kit has to be fitted by a Miele service technician.

Optional accessories

- Required:
Miele@home installation kit + communication module XKM 2000 SV ①
- Optional: Mobile master unit InfoControl XIC 2100 ⑤

Both of these are supplied with their own installation and operating instructions.

Information is displayed via:

- SuperVision appliance ④
The status of other appliances in the system can be shown in the display of the SuperVision appliance.
- InfoControl XIC 2100 ⑤
Information transmitted from the appliances can be displayed audibly and visually in a mobile master unit in the vicinity of the house.

You can use both of these at the same time.

The home of the future

The Miele@home system is capable of expansion. In the future, communication enabled appliances ② will be able to be operated via a PC or a mobile phone.

Controls

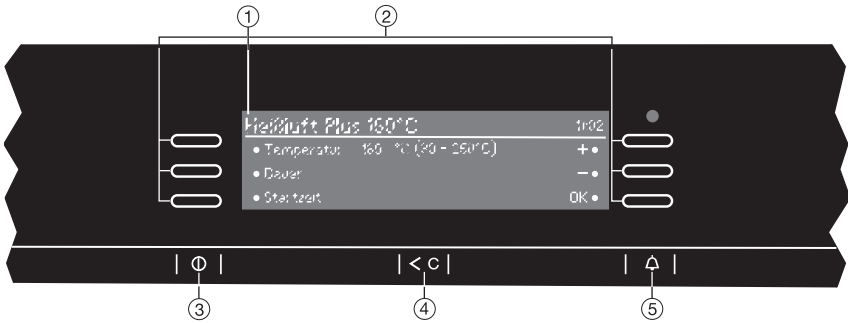

The appliance is operated via the display ① and the electronic sensors next to and below the display. These react to finger contact. A keypad tone will sound each time a sensor is touched. The volume of the keypad tone can be adjusted or switched off altogether (see "Settings - Volume - Keypad tone").



Sensors

		Meaning
②	○	Sensors When the appliance is switched on, the allocations for these sensors appear in the display. Sensors which can be used in a programme are lit up.
③	①	ON/OFF sensor For switching the appliance on and off.
④	<C	Clear sensor To delete the latest entry.
⑤	🔔	Minute minder (egg timer) sensor For entering a time for the minute minder, e.g. for boiling eggs.

Display

All information about functions, temperature, cooking durations, Automatic programmes and settings is shown in the display.

After the appliance has been switched on by touching the  sensor, the **Main menu** appears in the display with a list of options available.

An option  is selected by touching the illuminated sensor  next to the option required.









Main menu

- Fan plus
- Conventional heat
- Full grill
- Auto roast
- Defrost
- Lighting
- Economy grill
- Fan heat
- Moisture plus
- Intensive bake
- Top heat
- Fan grill
- Bottom heat
- Descale
- Automatic
- Slow cooking
- User programmes
- Settings 





















Controls

Symbols

The following symbols will appear in the display in addition to the text:

Symbol	Meaning
•	Appears beside an option and is allocated to a sensor  . You select the option you want by touching the sensor beside the dot.
	A maximum of 3 options can be shown in the display. These arrows indicate if more than three options are available. You can scroll up  or down  the list by touching the appropriate sensor.
.....	The end of a list is indicated by a dotted line. By scrolling down further, you reach the beginning of the list again.
+ / -	For increasing or decreasing the time or temperature shown in the display.
Back 	Selecting this option and confirming with OK returns you to the previous list of options.
	A tick will appear beside the option which is currently selected. A "•" will not appear in front of this symbol.
	This indicates additional information that is available. This information window can be cleared by selecting OK.
	The system lock is "Permitted". See "Settings - Safety". On = Operation not possible. Off = Operation possible.
	A minute minder time has been set.

When a function is selected, the following symbols may appear in the display, depending on setting:

Symbol	Meaning
	Duration
	Finish
	Start time
	Programme finished
	Rapid heat-up phase, Rapid searing phase
	Heating-up phase, Searing phase
	Core temperature when using the food probe
	Fan plus, Fan heat
	Intensive bake
	Moisture plus
	Auto roast
	Conventional heat
	Top heat
	Bottom heat
	Defrost
	Full grill
	Economy grill
	Fan grill
	Automatic programme, Slow cooking
	Lighting

Functions

Your oven has a range of oven functions for preparing a wide variety of recipes.

These include:

- Ⓐ Top heat/grill element (under the roof of the oven)
- Ⓑ Bottom heating element (under the floor of the oven)
- Ⓒ Ring heating element (behind the intake vent for the fan)
- Ⓓ Fan (behind the intake vent for the fan)
- Ⓔ Steam injection system

These components are combined in various ways, depending on the oven function selected. See the letters given in brackets for each function.

Function	Notes
Fan plus [Ⓒ + Ⓓ]	<ul style="list-style-type: none">– For baking and roasting.– You can bake and roast on different levels at the same time.– Lower temperatures can be used than with "Conventional heat" as the Fan plus system distributes the heated air around the food.
Fan heat [Ⓐ + Ⓑ + Ⓓ]	<ul style="list-style-type: none">– For baking and roasting on one level.
Intensive bake [Ⓑ + Ⓒ + Ⓓ]	<ul style="list-style-type: none">– For cooking dishes which require a moist topping and a crisp base such as pizza and quiche lorraine.– Intensive bake is not suitable for baking thin biscuits etc. or for roasting as the juices will become too dark.
Moisture plus [Ⓒ + Ⓓ + Ⓔ]	<ul style="list-style-type: none">– For baking and roasting with moisture injection.
Auto roast [Ⓒ + Ⓓ]	<ul style="list-style-type: none">– For roasting. During the searing phase, the oven is heated up to a high temperature (230 °C) to sear the meat. Once this temperature is reached, the temperature of the oven is automatically lowered to the set cooking temperature (continued roasting temperature).
Defrost [Ⓒ + Ⓓ]	<ul style="list-style-type: none">– For the gentle defrosting of frozen food.

Function	Notes
Conventional heat [A + B]	<ul style="list-style-type: none"> – For baking traditional recipes, e.g. fruit cake, casseroles. – Also ideal for soufflés. – If using an older recipe or cookbook, set the oven temperature for Conventional heat 10°C lower than that recommended. – The cooking duration does not need to be changed.
Top heat [A]	<ul style="list-style-type: none"> – Use this setting towards the end of baking, to brown the top of a cake, quiche or pizza.
Bottom heat [B]	<ul style="list-style-type: none"> – Use this setting towards the end of baking, to brown the base of a cake, quiche or pizza.
Full grill [A]	<ul style="list-style-type: none"> – The whole grill element is switched on and glows red in order to create the heat required. – For grilling larger quantities of thin cuts (e.g. steaks). – For browning food in larger dishes.
Economy grill [A]	<ul style="list-style-type: none"> – The inner part of the grill element is switched on and glows red in order to create the heat required. – For grilling smaller quantities of thin cuts (e.g. steaks). – For browning food in smaller dishes.
Fan grill [A + D]	<ul style="list-style-type: none"> – For grilling larger items, e.g. rolled meat, poultry. – The hot air from the grill is distributed around the food by the fan. This enables a lower temperature to be selected than when using "Full grill"/"Economy grill".
Automatic [depending on programme]	<ul style="list-style-type: none"> – The list of Automatic programmes available will appear in the display.
Slow cooking [A + B]	<ul style="list-style-type: none"> – For cooking meat or poultry over a long period of time.

Before using for the first time

To enter basic settings

The appliance will switch on automatically when it is connected to the electricity supply.



Welcome screen

A welcome screen will appear in the display, and you will then be requested to select some basic settings which are needed before the appliance can be used.

Follow the instructions in the display.

Setting the language

First select the language you want:

- Scroll through the list using one of the sensors to the right of the arrows  /  until the language you require appears in the display.
- Touch the sensor to the left of the language you want.
A tick ✓ will appear beside the language you have selected.
- Confirm your choice by touching the sensor next to "OK".

Clock format

The request to select the Clock format will appear. The default setting for the clock is 24 h.

- Touch the sensor to the left of the clock format required.
A tick ✓ will appear beside the clock format you have selected.
- Confirm with "OK".

Setting the time of day

You will then be asked to enter the time of day. The hour is highlighted.

- Use the sensor next to + to enter the hour, confirm with "OK" and then set the minutes in the same way.

Time of day display

You will then be asked when you want the time of day to show in the display when the appliance is switched off:

- On
The time is always visible in the display.
- On for 60 seconds
The time is only ever visible for 60 seconds.
- Do not display
The time only shows in the display when the oven is being operated.
- Touch the sensor to the left of the setting you want.

After you have confirmed your selection with "OK", the display will show a message to tell you that:

- your appliance is equipped for the Miele@home system.
- your appliance has been successfully set up to use it for the first time.

As soon as you confirm this last message with "OK", your appliance is ready for use.

If you have selected the wrong language by mistake, proceed as described in "Settings - Language" to get back to the correct language.

Cleaning and heating up for the first time

- Before use, please remove
- any stickers from the oven and from any accessories.
 - any protective foil from the oven front.

See "Cleaning and care" for more information.

Before using the oven for the first time

- take **all accessories** out of the oven and wash them.
- then **heat the oven up once with nothing in it**. New ovens have a slight smell on first use and this will dissipate the smells before you use it to cook food.

- Before heating the oven up it is a good idea to wipe the interior out with a damp cloth. This way any dust or bits of packaging that may have accumulated in the oven cavity during storage and unpacking will be removed.

- Touch the ① sensor.

The appliance will switch on and the main menu will appear in the display.

- Touch the sensor next to "Fan plus".

The recommended temperature of 160 °C will appear highlighted.

- Increase the temperature to 250 °C (the highest temperature) by touching the sensor next to +.
- Touch the sensor next to "OK".

- Heat the empty oven for at least an hour.

Please ensure the kitchen is well ventilated during this operation. Close doors to other rooms to prevent the smell spreading throughout the house.

The timer can also be used to set the finish time. See "To use Automatic switch-off".

- Leave the appliance to cool down to room temperature.
- Then wipe the oven interior out with a solution of hot water and a mild detergent, and dry it thoroughly with a soft clean cloth.

Leave the oven door open until the oven interior is completely dry.

Operation

Automatic programmes

Your appliance has a wide range of Automatic programmes to enable you to achieve excellent results with ease.
Simply select the programme for your food, and follow the instructions in the display.

You can call up the Automatic programmes by selecting the "Automatic" option from the main menu.

- Switch the oven on with the ① sensor.
- Select "Automatic".

A list will appear in the display.

- Cakes
- Baked goods
- Bread
- Bread mixes
- Bread rolls
- Pizza
- Meat
- Game
- Poultry
- Fish
- Bakes/gratins
- Frozen food
- Reheat
(Reheating plated meals)
- Dessert
- Slow cooking
- Sabbath programme

- Select the option you require.

Each Automatic programme has a sub-menu with further options which will now show in the display.

Each step you need to take before starting the Automatic programme will appear in the display.

Depending on the programme you have selected, further information or prompts will appear regarding

- the roasting or baking dish,
- the shelf level,
- the use of the food probe,
- the amount of water required for programmes with Moisture plus,
- the cooking duration.

For further information about the Automatic programmes, including a selection of recipes, please refer to the "User instructions" and the "Moisture plus" recipe book.

Manual operation

If you do not want to use an Automatic programme you can enter the settings for a cooking programme manually.

- Place the food in the oven.
- Switch the oven on with the ① sensor.
- Select the required function and set the temperature.

The oven will start heating, and the cooling fans will switch on.

At the end of the cooking programme:

- Switch the oven off and remove the food.

Cooling fans

The cooling fans will continue to run for a while after the oven has been switched off to prevent any humidity building up in the oven, on the control panel or in the oven housing unit.

The fans are temperature controlled, and will switch off automatically.

You can change this standard default setting, see "Settings - Cooling fan run-on".

Change

Selecting "Change" brings up all the options which can be changed, e.g. the selected temperature.

Selecting a function

- Switch the oven on.
- Select the function required.

After selecting an oven function, options which can be entered or changed for the cooking programme will appear in the display, e.g.:

- Temperature
- Duration
- Start time
- Finish
- Heating-up phase (only with Fan plus, Auto roast and Conventional heat)
- Moisture reduction
- Change function

Operation

Recommended temperature, Selecting the temperature

As soon as you have selected a function, the **recommended temperature** with the **temperature range** which can be set in brackets beside it will appear in the display.

The following recommended temperatures are set at the factory:

Fan plus	160 °C
Fan heat	160 °C
Auto roast*	160 °C
Intensive bake	170 °C
Conventional heat.	180 °C
Top heat	190 °C
Bottom heat	190 °C
Fan grill	200 °C
Economy grill	240 °C
Full grill	240 °C
Defrosting	25 °C
Moisture plus	160 °C

* Initial searing phase temperature approx. 230 °C, then drops to 160 °C for continued roasting

If the recommended temperature is suitable for your recipe, confirm it with "OK".

If it is not suitable, you can change it for this particular cooking programme.

You can also change the recommended temperature for a function permanently if you wish, see "Settings - Recommended temperature".

Entering the Duration, a Start time or Finish time

By entering the Duration, Start time or Finish time, the cooking process can be programmed to switch off, or on and off, automatically.

● Duration

When entering the Duration, you are entering the time that the food takes to cook.

Once this time has elapsed, the oven heating switches off automatically.

The maximum duration that can be entered is 12 hours.

The Duration cannot be entered if the food probe is being used as in this case the length of the cooking programme depends on the core temperature being reached.

● Start time

By entering the Start time, you specify the time you want cooking to start. The oven will switch on automatically at the time you have set.

The Start time can only be used in conjunction with Duration or Finish, except when using the food probe.

● Finish

By entering the Finish time, you specify the time you want cooking to finish. The oven will switch off automatically at the time you have set.

A Finish time cannot be entered if the food probe is being used as in this case the end of the cooking programme depends on the core temperature being reached.

To use Automatic switch-off

To **switch a programme off automatically** select Duration or Finish and enter the time required.

Example:

The time is 11:45. Your dish will take 30 minutes to cook, and needs to be ready at 12:15:00.

Select Duration, and enter 0:30 h, or select Finish and enter 12:15.

The oven will switch off automatically at the time set.

Delaying the start with Automatic switch-off

We recommend using automatic switching on and off when roasting. However, do not delay the start for too long when baking as the cake mixture or dough will dry out, and the raising agents will lose their effectiveness.

To **switch a programme on and off automatically** you have various options:

- Enter the Duration and Finish time.
- Enter the Start time and the Duration.
- Enter the Start time and the Finish.

Example:

The time is 11:30. Your dish will take 30 minutes to cook, and needs to be ready at 12:30.

Select Duration and enter 0:30 h.

Then select Finish and enter 12:30 h.

The Start time will be calculated automatically. "Start at 12:00" will appear in the display.

The cooking programme will start at this time.

Operation

Sequence of the cooking programme when using Automatic switch-off

The following will appear in the display:

Before the programme starts

- The cooking function and selected temperature
- "Start at" and the start time

After the programme has started

- the heating-up phase until the set temperature is reached

After the heating-up phase

- The "Time left" counting down
- can be followed in the display,

Shortly before the end of the programme

- The oven heating switches off.
- The cooking programme continues using residual heat. The residual heat in the oven is sufficient to complete the cooking process.
- "Energy save" will appear in the display.
- The cooling fans continue to run, as do the hot air fans if a "Fan" setting has been chosen.

At the end of the cooking programme

- The hot air fans switch off, depending on the cooking function being used.
- The message "Programme finished" and the  symbol appear in the display.
- A signal will sound (provided this is activated - see "Settings - Volume - Buzzer tones").

After the programme has finished

- The cooling fans will continue to run for a while after the oven has been switched off to prevent any humidity building up in the oven, on the control panel or in the oven housing unit.
The fans are temperature controlled and will switch off automatically. You can change the default setting for these (see "Settings - Cooling fan run-on").
- To save energy, the oven will switch off automatically if it is not used again within a certain time.
The timing depends on the settings selected (cooking function, temperature, duration).

Changing or deleting an entered cooking time

Selecting "Change" brings up all the options which can be changed.

- Select the option you want and change it.

Use the <C sensor to delete the entered times.

If there is a power cut, all data entered will be deleted.

Changing the heating-up phase

With the Fan plus, Auto roast and Conventional heat functions, the Heating-up phase will appear with the following options:

● **Rapid**

(Factory default)

The top heating/grill elements, the ring element and the fan are switched on at the same time so that the oven reaches the desired temperature as quickly as possible.

⏻⏮ shows in the display.

● **Normal**

Only the heating elements required for the cooking function selected are switched on; see "Functions".

⏻⏮ shows in the display.

The Rapid heat-up phase should not be used for some items such as pizza, biscuits and small cakes because they will brown too quickly from the top.

To switch off Rapid heat-up

- For one cooking programme:
Select "Heating-up phase", then "Normal".

Rapid heat-up is also switched off if a temperature of less than 100 °C is set.

- In general:
See "Settings - Heating-up phase".

Pre-heating the oven

Most dishes can be placed in a cold oven. They will then make use of the heat produced during the heating phase.

It is only necessary to pre-heat the oven in a few instances:

With Fan plus **pre-heat the oven:**

- pre-heating may be necessary for foods which cook in less than 20 minutes and for foods such as puff pastry and yeast mixtures where instant heat is required to make them rise quickly.
- for roasting beef/fillet.

With **Conventional heat** pre-heat the oven:

- It is usually necessary to pre-heat the oven.

The Rapid heat-up phase should be switched off when baking pizza, biscuits and small cakes. Otherwise they will brown too quickly from the top.

To pre-heat the oven:

- Select the required function and set the temperature.
- Wait for the oven to reach the set temperature.
Once the set temperature is reached, an audible tone will sound (provided this is activated - see "Settings - Volume - Buzzer tones").
- Then place the food in the oven.

Operation

Activating moisture reduction

It is a good idea to use this function when cooking items which are moist on the inside but which should be crispy on the outside, e.g. frozen chips, croquettes or pork with crackling.

It is also suitable for deep filled fresh fruit cakes, such as plum or apple cake.

You can activate Moisture reduction with any function.

Moisture reduction must be activated for each cooking programme individually.

For best results, activate it at the beginning of the cooking programme.

- Place the food in the oven.
- Switch the oven on with the ① sensor.
- Select the required function and set the temperature.
- Touch the OK sensor.

The list of options will show in the display.

- Select Moisture reduction and touch the On sensor to confirm.

Change function

You can change the function selected via this option.

The times already entered will be kept.

User programmes

Up to 25 frequently used recipes can be saved under a user-defined name, and then called up again as required.

Either

- Select the **Save as** option at the end of running an Automatic programme and give the programme a name of your choice, or
- select the **User programmes menu**. You can combine up to four cooking steps and save them under a name of your choice.

The User programmes menu

If user programmes have already been created and saved, the following will appear:

- **Select**
For calling up and starting an existing User programme. You choose whether the programme should "Start now" or "Start later".
- **Create**
This is used to create a new User programme.
- **Change**
For altering an existing programme.
- **Delete**
Individual user programmes can be deleted. You can also delete all User programmes at the same time - see "Settings - Factory default - User programmes".

● Use in main menu

You can place up to three user programmes in the Main menu. Changes to the Main menu can be reset via "Settings - Factory default - Main menu".



To create a User programme

If programmes already exist under User programmes, the "Create" option has to be selected in order to save additional programme stages to memory.

Then continue following the instructions below.

- Select the "User programme" menu.
- Select and confirm the cooking function you want.
- Alter and confirm the pre-set recommended temperature if required.
- Select a duration, or a core temperature if using the food probe, and confirm your selection.
- Check the settings and confirm them with "Continue".
- You can add more cooking stages, for example, if you want to add another cooking function to follow on from the first. Proceed as described above.
- Finally set the shelf level to be used.

After confirming with "Continue", select the name given in the display, or **enter your own name**. To do this:

- Use the sensors next to arrows   to select a character.
- When the letter or number you want is highlighted, confirm it with "Select character". The letter or number you have selected will appear in the top line of the display after "Name".
- Select the rest of the letters or numbers for your programme name.

You can use the "Delete character" option to correct any wrong entries.

Select "Space" where a space is required.

- Confirm the programme name with "OK".

To call up an existing User programme

- Select "User Programmes" from the main menu, and then the "Select" option. Programmes saved under User programmes will then appear in the display.

Food probe

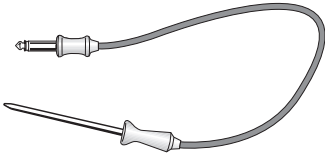

Using the food probe enables the cooking process to be monitored simply and reliably.

How it works

The metal tip of the food probe is inserted into the food. There is a **temperature sensor** in the metal tip which measures the **core temperature** of the food during cooking. The rise in the core temperature reflects the extent to which the food is cooked.

You can programme the core temperature to be lower or higher, depending on whether you want your meat to be medium or well done.

The core temperature can be set within a range of 30 to 99 °C. Refer to the Roasting chart in the User instruction booklet for the core temperature range applicable for different types of meat.

The duration of a cooking programme is approx. the same, whether or not the food probe is being used.

When to use it

The food probe can be used in Automatic programmes and also with the following functions:

- Auto roast
- Fan plus
- Moisture plus
- Conventional heat
- Fan grill
- Slow cooking

Important notes about using the food probe

Please note:

Do not use the food probe to lift or carry the food. Danger of breaking.

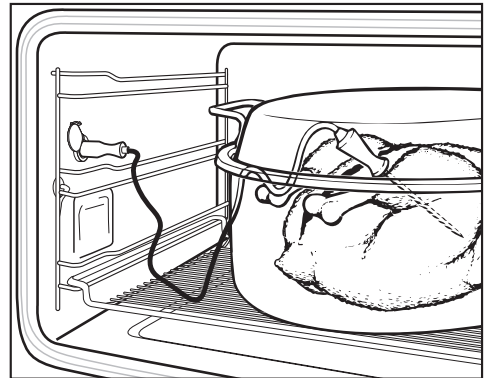

- You can place the meat in a pot or on the rack in the universal tray with the anti-splash insert (if present).

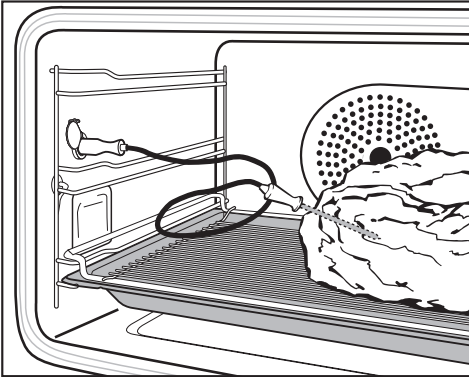

To use the food probe

- Prepare the food in the usual way.
- Insert the metal tip fully into the food.
- Place the food in the oven.

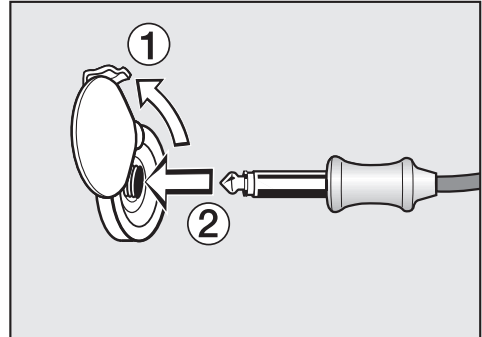

- The metal tip of the food probe must be fully inserted into the centre of the food.
- When cooking poultry, insert the metal tip into the thickest part of the breast.
- Do not let the metal tip touch any bones or insert it into a particularly fatty area of the meat. If fat or bone come into contact with the probe, this can lead to the oven being switched off too early.
- If the meat is very heavily marbled with fat, select the highest core temperature given in the roasting chart.
- When using roasting bags or aluminium foil, insert the probe through the bag or foil into the centre of the meat. You can also place the meat, with the food probe inserted, inside the foil. Follow the roasting bag / aluminium foil manufacturer's instructions.

- Insert the plug of the food probe into the socket until you feel it engage.
- Close the door.
- Select the oven function or Automatic programme.
- Alter the recommended temperature if necessary.
- Alter the recommended core temperature of 60°C, if required.

The core temperature is pre-programmed into the automatic programmes.

You can also delay the start of the cooking programme to a later time. Select the "Start time" option or if using an Automatic programme, the "Start later" option.

Food probe

Time left display

After a certain time, the estimated **time remaining** (i.e. the time left to run), appears in the oven display.

The actual core temperature is no longer displayed and cannot be called up.

The time remaining is calculated from the oven temperature selected, the required core temperature and the pattern of the increasing core temperature.

The time remaining first shown is an estimate. As the cooking process continues the time remaining is revised continuously, and a more accurate revised figure shown.

If, while the time remaining is showing in the display:

- the oven or core temperature is altered,
- or a different oven function is chosen,
- or the door is left open for a particular length of time

all the time remaining information will be cancelled and the actual core temperature will re-appear in the display. The time left display will reappear after a while.

If the door is opened during an automatic programme the time remaining will continue to show in the display.

Making use of residual heat

The heating in the oven switches off shortly before the end of the cooking programme. The residual heat in the oven is sufficient to complete the cooking process.

Using the residual heat in the oven saves energy.

"Energy save phase" will appear in the display to show that the oven is in Energy save mode. The time remaining will continue to be visible in the display.

The cooling fans continue to run, as do the hot air fans if a "fan" setting has been chosen.

When the core temperature selected has been reached,

- the oven switches off automatically.
- the message "Programme finished" and the  symbol appear in the display.
- a buzzer will sound.

If the food is not yet cooked sufficiently, insert the food probe into another place and repeat the programme.

The "Moisture plus" function uses a steam injection system.

Water is taken into the steam injection system via the tube underneath the control panel on the left. The water is then injected as bursts of steam into the oven compartment during the cooking process.

The steam inlets are located at the rear left corner of the roof of the oven.

 Only use water with this function.

Other liquids will damage the appliance.

Baking, roasting or cooking with Moisture plus uses just the right amount of steam and optimum air flow for very even cooking and baking results: delicious fresh bread with a glossy crust; rolls and croissants as good as the baker makes; tender, succulent meat with a well browned finish; perfectly finished oven bakes; delicious soufflés and much more.

Please refer to the "Moisture plus" booklet supplied with your oven for further information and a selection of recipes.

Moisture plus is not suitable for mixtures which already contain a lot of moisture, such as choux pastry and meringues, as the addition of steam does not allow them to dry out sufficiently.

Moisture plus is activated with Automatic programmes or you can select the special "Moisture plus" function.

 The steam injection system should be rinsed through before you use an Automatic programme with Moisture plus or the Moisture plus function for the first time. To do this, run the oven using "Moisture plus - 160 °C - Automatic burst of steam" for about 30 minutes.

Moisture plus

Automatic programmes

Automatic programmes with Moisture plus set the optimum temperature, the degree of moisture and also the duration automatically.

At the beginning of the programme you will be prompted to allow a specified amount of water to be drawn into the oven.

The amount of water specified will be more than the amount which is actually needed which means that some of the water will remain in the container as not all of it will be drawn up into the oven. The programme will control how many bursts of steam are required and at what point they are injected.

Night baking

Some of the Automatic programmes for bread and rolls have the option of baking during the night, so that you can enjoy freshly baked bread for breakfast the next morning.

The "Finish" option will appear when you have selected the programme.

When "Finish" is selected, a finish time will appear which is the cooking duration for the programme plus five or six hours, depending on programme. You can change this to the time you want the bread to be ready at the next morning.

Follow the instructions which then appear in the display.

Moisture plus

When using the Moisture plus function you will need to enter

- the temperature (at least 130 °C), and
- the number of bursts of steam.

You can also enter the cooking duration or you can use the food probe.

Number of bursts of steam and when they are injected

The number of bursts of steam and when they are injected will depend on the type of food being cooked:

- **Dough mixtures** will rise better if steam is injected at the beginning of the programme.
- **Bread and rolls** also rise better if exposed to steam at the start. Injecting a burst of steam at the end of the programme will give the bread and rolls a glistening crust.
- When **roasting meat with a high fat content** injecting steam at the beginning of roasting will draw out the fat.

Please refer to the sample recipes in the "Moisture plus" booklet.

After selecting Moisture plus you need to set the number of bursts of steam. The options are:

- Automatic
This requires enough water for one burst of steam. The burst of steam will be injected into the oven automatically after the heating-up phase.
Steam is injected for about 5 minutes.
- 1 burst of steam
- 2 bursts of steam
- 3 bursts of steam
The quantity of water required will depend on the number of bursts of steam.
The earliest point at which steam can be injected is after the heating-up phase has been completed.
One burst of steam takes approx. 5 minutes to be injected into the oven.
It is a good idea to set the minute minder to remind you when to inject the bursts of steam required.

It is quite normal for condensation to form on the inside of the door during steam injection. This will dissipate during the course of the cooking programme.

Moisture plus

Using Moisture plus

- Place the food in the oven.
- Select Moisture plus .
- Select a temperature.
- Select Automatic burst of steam or select the number of bursts of steam.
- Fill a suitable container with the quantity of water specified.
Automatic/
1 burst of steam: approx. 100 ml
2 bursts of steam: approx. 150 ml
3 bursts of steam: approx. 250 ml
- Pull the fill tube forwards (located below the control panel on the left).

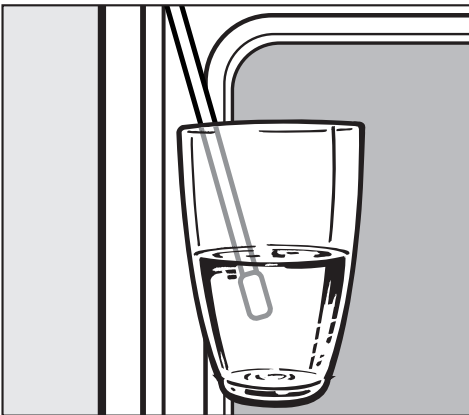

- Hold a container with the quantity of water specified under the tube as shown. Start the water intake process with "OK".

The amount of water required will be drawn up into the oven. As the water is taken in, bars will appear in the display. The amount of water specified will be more than the amount which is actually needed which means that some of the water will remain in the container as not all of it will be drawn up into the oven.

When you close the oven door you will hear the noise of the pump briefly.

– Automatic burst of steam

- Once the heating-up phase has been completed, the automatic burst of steam is injected and the water will vaporise in the oven compartment.

Once the steam has been injected successfully, the programme will continue to the end.

– Injecting bursts of steam manually

Once the heating-up phase has finished, the bursts of steam can be injected at the intervals given in the recipe.

Set the minute minder  as a reminder.

When it is time to inject steam:

- Select "Release steam".

The water will vaporise in the oven compartment.

If more bursts of steam are required, proceed as described above.

Once the steam has been injected successfully, the programme will continue to the end.

To evaporate residual moisture

If there is still water in the steam injection system at the end of a programme or if the programme is cancelled, you will be prompted to evaporate the residual moisture.

This prompt will appear

- when the appliance is switched on,
- when selecting "Moisture plus", or
- when selecting an automatic programme that uses Moisture plus.

Select "Cancel" to cancel the process or "OK" to start it.

It is best to start the evaporation process straight away so that only fresh water can be used during the next cooking programme.

The residual moisture evaporation process

The oven will heat up to approx. 150 °C, and the residual water in the oven cavity will evaporate. How long this takes will depend on the amount of water in the system.

Steam will condense on the door and the oven cavity, and the moisture will then need to be wiped off after the oven has cooled down.

To start the residual moisture evaporation process

Confirm the prompt "Evaporate residual moisture" with OK.

The evaporation process will start immediately. The display will show the approximate time remaining.

Moisture plus

To cancel the residual moisture evaporation process

After the appliance has been switched on, the prompt to evaporate residual moisture will appear in the display. Touch the sensor next to "Cancel". You will only be able to run functions and Automatic programmes without Moisture plus.

If you select "Moisture plus" or one of the Automatic programmes with Moisture plus, the prompt to evaporate residual moisture will appear immediately.

If you do not want to start the residual moisture evaporation process, you will need to press the Cancel sensor for at least 3 seconds.

You can now start the cooking programme.

 Do not cancel the prompt for residual moisture evaporation too often, as this might cause the steam injection system to overflow when taking in more water.

Descaling

The oven will need to be descaled depending on the number of cooking programmes using Moisture plus which have been run and the amount of water taken into the oven for these. This will be indicated in the display.

The steam injection system should be descaled regularly. How often this needs to be done will depend on the water hardness level in your area.

You can start the descaling process at any time by selecting "Descale" in the main menu.

If you do not carry out the descaling process when the prompt to descale the oven appears, you will only be able to run functions and Automatic programmes without Moisture plus.

See "Cleaning and care" for more information about descaling.

Minute minder (egg timer)

The minute minder can be used to time any activity in the kitchen, e.g. boiling eggs.

You can enter a time of up to a maximum of 9 hours, 59 minutes and 59 seconds.

You can set the minute minder at the same time as another timed programme, e.g. as a reminder to stir a dish or add seasoning etc.

With "Moisture plus )", it is a good idea to use the minute minder to remind you when to release the bursts of steam manually.

To set the minute minder



- Touch the  sensor.

"0 : 00 : 00" will appear in the display.

- Enter the minute minder time using the **+** or **-** sensors:
first enter the hours, then the minutes and finally the seconds.
Confirm each hour/minute/second entry by touching the OK sensor.

The time counts down in the display.

At the end of the time set for the minute minder

- the  symbol will flash.
- a tone will sound (provided this is activated - see "Settings - Volume - Buzzer tones").
- the display will show the time counting upwards.
- Touch the  sensor.

To alter the time set for the minute minder:

- Touch the  sensor.
- Use the <C sensor to set the time to "0 : 00 : 00" and then enter a new minute minder time.
- Confirm your entry with the OK sensor.

To cancel the time set for the minute minder

- Touch the  sensor twice.

Settings

Your appliance is supplied with a number of standard default settings.

To change a setting:

- Select the "Settings 

The list of options will show in the display.

- Language 
- Time
- Lighting
- Main menu
- Catalyser
- Cooling fan run-on
- Heating-up phase
- Start
- Recommended temperatures
- Display
- Volume
- Safety
- Units
- Showroom programme
- Factory default

- Select and confirm the one you want to change.

If a setting is not confirmed within a certain time, the display will revert to the "Settings" list.



Currently selected settings are indicated by a "✓" and without a "✚" next to them.

Settings cannot be altered while a cooking programme is in progress.

Language

You can set the language you want the display to appear in.

After selecting and confirming "Language", the language you have selected will appear in the display.

If you have selected the wrong language by mistake, you can follow the flag symbol  to get back to the Language  menu.

Time

The options are:

- Display
- Clock format
- Set

If there is a power cut, the current time of day will reappear once power has been restored. The appliance will store this data for approx. 200 hours. After 200 hours it will show "12:00" and will need to be re-set.

Time (of day) display

Select how you want the time to appear in the display when the oven is switched off:

- On
(Factory default)
The time will always show in the display.
- On for 60 seconds
The time is only ever visible for 60 seconds when the oven is switched on and when it is switched off.
- Do not display
The time will only show in the display when the oven is being operated.

Clock format

The time can be altered from a 24-hour display to a 12-hour display:

- 12 h: 12 hour clock display
- 24 h: 24 hour clock display
(Factory default)

To set the time

The time is set using the + and - sensors:

First enter the hours and confirm with "OK". Then enter the minutes and confirm with "OK".

Lighting

- On
The oven interior lighting remains on during the entire cooking programme.
- On for 15 seconds
(Factory default)
The oven interior lighting will switch off 15 seconds after the start of a cooking programme.
Touching one of the illuminated sensors next to the display will switch the lighting on for another 15 seconds.
With Automatic programmes you will need to touch the  sensor twice because the sensors next to the display are not illuminated.

Settings

Main menu

You can change the order in which options appear in the Main menu. Up to three options can be placed at the beginning of the Main menu (excluding Settings).

When you select this option you will be prompted to set positions 1, 2 and 3. You will be given the choice of selecting a standard oven function or an Automatic programme or a User programme for each position. After selecting and confirming one position you will be prompted to set the next one.

Once you have set all three the list will appear in the display.

If you have already placed a User programme at the beginning of the Main menu (see "User programmes - Use in main menu"), the next one will be added to the list.

Catalyser

- On
(Factory default)
The catalyser is always switched on.
- Off next programme only
The catalyser will be switched off for the next programme only.

Cooling fan run-on

The cooling fans will continue to run for a while after the oven has been switched off to prevent any humidity building up in the oven, on the control panel or in the oven housing unit.

- Temperature controlled
(Factory default)
The cooling fans will switch off when the temperature in the oven compartment drops below approx. 70 °C.
- Time controlled
The cooling fans will switch off after approx. 25 minutes.



Do not leave food in the oven to keep it warm if you have set the cooling fans to timed operation. Moisture levels in the oven could increase, leading to condensation forming on the control panel and surrounding kitchen furniture and drops of moisture collecting under the worktop.

Condensate can

- damage the housing unit/
worktop.
- lead to corrosion in the oven.

Heating-up phase

The heating-up phase works as follows with the Fan plus, Conventional heat and Auto roast functions:

- **Rapid**
(Factory default)
All the heating elements are switched on together in order to heat the oven up as quickly as possible to the required temperature.
 and "Rapid heat-up phase" or "Rapid searing phase" will appear in the display.
- **Normal**
Only the heating elements for the cooking function selected are switched on.
 and "Heating-up phase" or "Searing phase" will appear in the display.

Start

- **Automatic**
(Factory default setting)
A programme will start automatically approx. 20 seconds after making your last entry without having to select Start.
- **Manual**
If "Manual" has been selected, "Start" will appear at the beginning of each programme and must be confirmed before the programme will start.

Recommended temperatures

If you frequently change a recommended temperature it may be a good idea to change it permanently.

The recommended temperatures is displayed next to the function.

When you select a function the recommended temperature is highlighted.

The setting range available will also appear.

Display

Contrast

The contrast is represented by a bar with seven segments.



Factory default: Four illuminated segments.

To change the contrast touch the sensor next to "Lower" or "Higher".

Brightness

The brightness is represented by a bar with seven segments.



Factory default: Six illuminated segments.

To change the brightness touch the sensor next to "Darker" or "Lighter".

Settings

Volume

Buzzer tones

The volume is represented by a bar with seven segments.



Factory default: Three blocked segments.

To change the volume touch the "quieter" or "louder" sensor.

If all segments are blocked out the volume is on maximum.

If none of the segments are blocked out the volume has been turned off.

Frequency

The frequency of the buzzer can be changed. Changing the frequency may be necessary to optimise the volume in different installation environments.

The frequency range is represented by a bar with 15 segments. Each segment represents a different frequency.



To change the frequency touch the sensor next to the "-" or "+" symbols.

If the segment on the far left is the only one blocked out (factory default) a brief signal will sound after a short while four times at 15 second intervals.

If more than one segment is blocked out a continual signal will sound after a short while for approx. 8 minutes on the frequency set.

Keypad tone

The volume of the keypad tone, which beeps when touched, can be changed or the sound switched off completely.



Factory default: Three blocked segments.

To change the volume touch the "quieter" or "louder" sensor.

If all segments are blocked out the volume is on maximum.

If none of the segments are blocked out the volume has been turned off.

Safety

The options are:

- System lock 
- In operation lock

System lock

The lock prevents the oven being switched on unintentionally, by children for example.

The system lock has to be set to "Permitted" (activated) in order to use it.

- **Permitted**

The system lock is active.

The  symbol appears in the display as soon as the appliance is switched off. The system lock can now be used.

- **Not permitted**

(Factory default)

The system lock is deactivated.

To switch the system lock on or off

- Touch the sensor next to the  symbol.

You can choose between:

- **On**

The appliance is locked and cannot be operated.

 appears in the display.

- **Off**

The appliance is unlocked and can be operated.

 appears in the display.

The minute minder can still be used.

The system lock remains active even after a power cut.

In operation lock

- **On**

When the oven is switched on, a sensor must be touched for at least 5 seconds before it reacts.

This prevents the oven being switched off inadvertently, or any alteration to the cooking programme.

- **Off**

(Factory default)

When the oven is switched on, the sensors react straight away.

Settings

Units

Temperature

- °C
(Factory default)
- °F

Showroom programme

- **Off**
(Factory default)
- **Demo programme**
- **Continuous loop**
- **Demo mode**

This programme is for dealers who want to demonstrate the appliance without the heater elements working.

Do not activate this setting for domestic use!

If you select and activate this option by mistake, you can deactivate it as follows:

- Demo programme
Select the "Off" option and follow the instructions in the display.
- Continuous loop
- Demo mode
Touch one of the sensors next to the display and follow the instructions.

Factory default

- **All settings**
Any settings that you have altered will be reset to the factory default setting.
- **User programmes**
All saved user programmes will be deleted.
- **Main menu**
Only the main menu will be reset to the factory default setting.
- **Recommended temperatures**
Only those recommended temperatures which have been changed will be reset to the factory default settings.

Miele branded cleaning and conditioning products are available from the Miele Spare Parts Department or via the internet on www.miele-shop.com.

 Do not use a steam cleaner to clean the appliance. The steam could reach electrical components and cause a short circuit.

Appliance front

Remove any soiling immediately. If this is not done, it might become impossible to remove and could cause the surface to alter or discolour.

Clean the front using a damp Miele microfibre E-cloth or with a clean sponge and a solution of hot water and washing-up liquid. Wipe dry using a soft cloth.

All external surfaces are susceptible to scratching. Scratches on glass surfaces could even cause a breakage in certain circumstances. Contact with unsuitable cleaning agents can alter or discolour the external surfaces.

To prevent damage to your appliance when cleaning do not use:

- cleaning agents containing soda, ammonia, acids or chlorides,
- cleaning agents containing descaling agents,
- abrasive cleaning agents, e.g. powder cleaners and cream cleaners,
- solvent-based cleaning agents,
- stainless steel cleaning agents,
- dishwasher cleaner,
- oven sprays,
- glass cleaning agents,
- hard, abrasive sponges and brushes, e.g. pot scourers,
- dirt erasers,
- sharp metal scrapers.

Cleaning and care

Accessories

Universal tray

The surface has been treated with **PerfectClean enamel**.

Please refer to the section on "PerfectClean" for information on cleaning and care.

Rack, runners

The surface has been treated with **PerfectClean enamel**.

Treat in the same way as other surfaces coated with PerfectClean. See "PerfectClean".

Food probe

Clean the food probe with a damp cloth only.

Do not put the food probe into water or clean it in the dishwasher as this will damage it.

FlexiClip telescopic runners

Do not clean FlexiClip telescopic runners in a dishwasher. This would remove the special lubricant.

When cleaning the runners do not use:

- abrasive cleaning agents, e.g. powder cleaners and cream cleaners,
- stainless steel cleaning agents,
- hard, abrasive sponges and brushes, e.g. pot scourers,

When cleaning the runners be very careful not to wash out the special lubricant in them.

Avoid frequent:

- soaking in hot soapy water,
- use of oven spray,
- cleaning of the bearings.

FlexiClip telescopic runners are best cleaned after each use. This prevents soiling drying on or being burnt on when the oven is used again.

If the runners are used frequently without being cleaned, it may become very difficult or even impossible to clean them.

Normal soiling

Clean the surfaces of the runners using a damp Miele microfibre E-Cloth or with a clean sponge and a solution of hot water and washing-up liquid. Wipe dry using a soft cloth.

Remove any cleaning agent residues thoroughly.

Heavy soiling

If necessary, the scouring pad on the reverse of a washing-up sponge can be used to clean the runners. Cleaning may be easier if the soiling is first dampened with a solution of hot water and washing-up liquid for a few minutes. If necessary, a non-abrasive stainless steel spiral pad can be used.

For very heavy soiling the telescopic runners can be soaked in a solution of hot water and washing-up liquid for a maximum of 10 minutes.

The runners may appear discoloured or a lighter colour in places after they have been cleaned. This will not affect the functioning of the runners in any way.

Note:

When baking cakes with moist toppings or fillings e.g. fruit crumble, be careful not to let them spill over. Should this happen there is a danger of sticky fruit juices adhering to the runners and hindering or even preventing their movement in and out of the oven. Clean the runners as described above and very carefully use a soft nylon brush to clean the bearings inside the runners.

Lubricating the FlexiClip telescopic runners

If the lubrication on the telescopic runners dries out, they can be relubricated to ensure they continue to run smoothly.

A special lubricant is available from Miele.

Only use this special lubricant, as it is designed to withstand high temperatures in the oven. Other lubricants can harden and stick to the telescopic runners when they are heated.

Cleaning and care

Oven interior

Allow the oven to cool down before cleaning.

Danger of burning.

The oven interior should be cleaned after each use. If this is not done subsequent soiling from baking and roasting will become worse and make cleaning harder. In extreme cases soiling will be impossible to remove or even cause damage to the surface material.

The surface of the oven interior has been treated with **PerfectClean enamel**.

Please refer to the section on "PerfectClean" for information on cleaning and care.

When baking items with a high salt content (e.g. continental pretzels) place them on baking parchment in the universal tray. Sodium deposits can cause lasting discolouration to PerfectClean surfaces.

The removable **back panel** is coated with a dark grey **catalytic enamel**. See the cleaning instructions for "Catalytic enamelled surfaces".

To make cleaning easier

- remove the oven door,
- dismantle the door,
- remove the FlexiClip telescopic runners,
- take out the side runners,
- remove the catalytic enamelled back panel,
- lower the top heating/grill element.

Instructions for doing this are given further on in this section.

Seal and inside of the oven door

Grease desposits on the seal between the inside of the oven door and the oven interior can cause it to become brittle and cracked.

It is best to clean the seal and the inside of the door after each with a Miele E-cloth or a clean sponge and a solution of hot water with a little washing up liquid. Wipe dry using a soft cloth.

PerfectClean

Before using for the first time remove any stickers from PerfectClean surfaces.

The **enamelled surfaces** of the oven interior and universal tray have been treated with a special type of enamelling called "**PerfectClean**". This surface has very good anti-stick properties and is much easier to keep clean than conventional oven enamel, if cleaned regularly.

Food can be taken off it more easily, and soiling from baking and roasting is easier to remove.

The following notes on cleaning and care should ensure that the anti-stick and easy clean properties of PerfectClean last for many years.

PerfectClean surfaces can be treated as you would treat glass. Food can be sliced or cut up on the PerfectClean surface in the same way as on a baking tray with conventional enamel.

Allow the oven and any accessories to cool down before cleaning.
Danger of burning.

Normal soiling

Clean as soon as possible after each use with a dishcloth, soft sponge or a soft nylon brush, and a solution of hot water and a little washing-up liquid. The longer soiling is left, the harder it may become to remove.

Stubborn soiling

Stubborn soiling, e.g. from roasting, may need to be soaked first with a damp sponge to loosen it and if necessary a non-abrasive stainless steel spiral pad or a scraper suitable for glass can be used to remove it.

After cleaning, rinse thoroughly with clean water. The water must run off the surface easily. Any residual cleaning agents will hinder this effect.

Using oven sprays on very stubborn soiling

Some oven cleaners contain strong alkalines and / or abrasive materials. Because PerfectClean enamel is designed to be easily cleaned, the use of these cleaners is not recommended. However, if you still cannot get the surface clean, an oven cleaner can be used, but for a couple of minutes only.

Do not attempt to use on a hot oven or accessories. Allow the PerfectClean surfaces to cool down to room temperature before applying an oven spray.

Cleaning and care

Remove the catalytic back panel before using oven spray. The chemicals used in oven sprays will damage catalytic enamel, rendering it ineffective.

Apply a spray oven cleaner to the soiled areas. Leave to take effect for **a couple of minutes only!**

If necessary use a soft sponge, soft nylon brush or a scraper suitable for glass surfaces to loosen the soiling. Repeat the process if necessary.

After cleaning, rinse thoroughly with clean water and then dry thoroughly.

For optimum performance of PerfectClean enamel it is important to clean the oven and accessories after each use.

The surfaces will become harder to clean and the anti-stick properties will deteriorate if soiling is not removed after each use and allowed to build up. In extreme cases cleaning may become impossible.

The following cause lasting damage to the surface structure and reduce the anti-stick effect and must not be used on PerfectClean surfaces:

- abrasive cleaning agents, e.g. powder cleaners and cream cleaners,
- cleaning agents for ceramic hobs,
- wire wool or metal scourers,

- abrasive sponges, e.g. pot scourers or sponges which have been previously used with abrasive cleaning agents,
- oven spray must not be used in a hot oven or left on for too long,
- PerfectClean enamelled items must not be washed in a dishwasher.

Should the PerfectClean surface be damaged by any of the above measures not being heeded, it will still retain the anti-stick qualities of standard enamel and be as easy to keep clean as standard enamel.

Note:

- Soiling such as spilt juices and cake mixtures are best removed whilst the oven or tray is still warm. Exercise caution, make sure the oven is not too hot - danger of burning.
- Spilt fruit juices may cause lasting discolouration to the surfaces and roasting can cause matt areas to appear. Clean these following the instructions given above and do not use force to remove them. This discolouration is permanent but will not affect the efficiency of the enamel.

Catalytic enamel surfaces

The back panel **is coated with dark grey catalytic enamel.**

Soiling from oil and fat is burnt off this surface when very high temperatures are used in the oven. The higher the temperature, the more effective the process.

The catalytic coating becomes ineffective through using

- abrasive cleaning agents,
- hard brushes or abrasive sponges,
- oven sprays.

Remove the catalytic back panel from the oven before cleaning the PerfectClean oven surfaces with oven spray.

Note that deposits of **spices, syrups and similar substances** are not removed from the catalytic coating by this process. These should be removed by hand whilst still fresh, using a mild solution of hot water and washing-up liquid applied with a soft sponge or brush. Remove the panels from the oven to do this.

Soiling caused by **oil and grease splashes** are removed from catalytic coated surfaces when the oven is heated to a high temperature. To do this:

- Take all accessories out of the oven.
- Wipe large deposits of soiling from the oven interior and the inside of the door before starting the cleaning process to avoid them baking onto PerfectClean surfaces and becoming impossible to remove.

- Select Fan plus .

- Set the highest temperature setting.

Run the oven for approx. 1 hour. The length of time will depend on the level of soiling.

The timer can also be used to set the finish time. See "Entering the duration, start time or finish".

If the catalytic coated panel is very heavily soiled with oil and grease, a film will develop on the oven surface during the cleaning process which can be wiped off with warm water and a little washing-up liquid once cool.

- Finally, clean the PerfectClean surfaces and the inside of the door.

Any remaining soiling will gradually disappear with each subsequent use of the oven at high temperatures.

Should the catalytic coating on the back panel become ineffective through improper use or heavy soiling, a replacement can be obtained from your Miele dealer or the Miele Spare Parts Department.

Cleaning and care

To remove the oven door

Take care when removing the door - it weighs approx. 13.5 kg.

The oven door is connected to the oven by hinges.

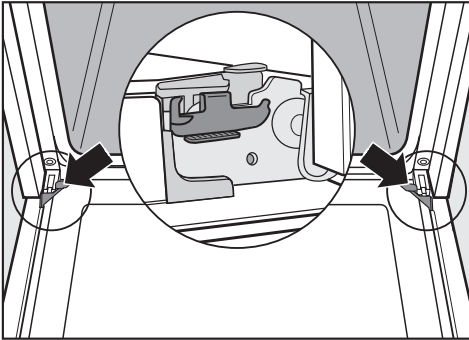

Before removing the door, the locking clamps on both hinges have to be released.

- Open the door fully.

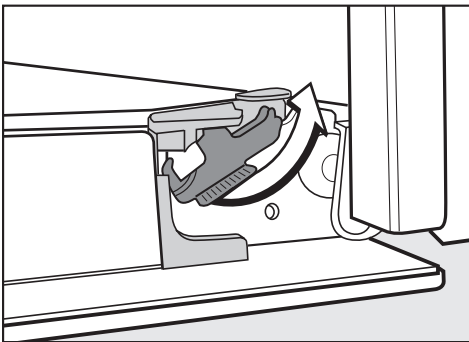

- To release the locking clamps on the hinges turn them upwards as far as they will go until they are at an angle. See illustration.
- Then lift the door upwards as far as it will go.

Do not attempt to take the door off the hinge guides when it is in a horizontal position. The guides will close, and damage the appliance. Danger of injury.



- Hold the door securely at both sides and lift upwards off the hinge guides.

Do not lift the door off by the handle. The handle could break and damage the door.

Make sure that you lift the door off equally on both sides.

To dismantle the oven door

The oven door is made up of four panes of glass and has vents at the top and bottom.

When the oven is operating, air is circulated through the door to keep the outer pane cool.

If condensate has worked its way in between the glass panes, the door can be dismantled in order to clean in between the panes.

When cleaning the glass panes please follow the same instructions given for cleaning the appliance front.

Do not use abrasive cleaning agents, sponges or brushes, as these can scratch the surface. Scratches can also cause the glass to break.

Do not use an oven spray. This will damage the surface of the aluminium surrounds.

Ensure that the glass panes are inserted the correct way round after cleaning, as each side of the pane has a different coating. Those facing the oven interior reflect the heat.

To avoid the risk of breakage, it is advisable to place the panes on a table protected by a soft cloth (e.g. a towel).

Always remove the oven door before dismantling it.

- Place the door on a protective surface (e.g. on a table cloth) to prevent it getting scratched. The door handle should line up with the edge of the table. Make sure the glass lies flat and does not get broken during cleaning.

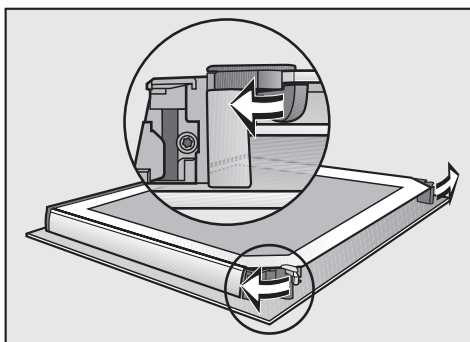

- Flip the glass pane retainers outwards to open them.

Cleaning and care

You can now remove the inner and the two middle panes.

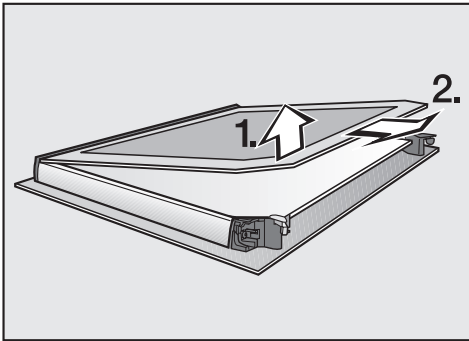

- **Gently** lift the inner pane up and pull out of the cover strip.

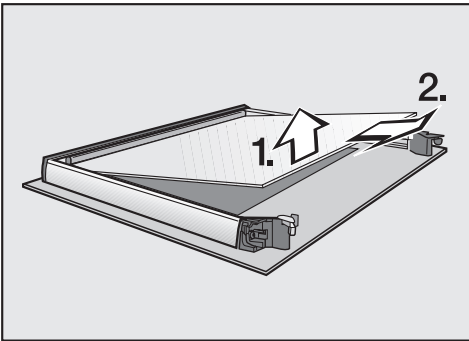

- Now gently lift up the upper of the two middle panes together with the seal and remove it.
- Remove the seal from the pane.

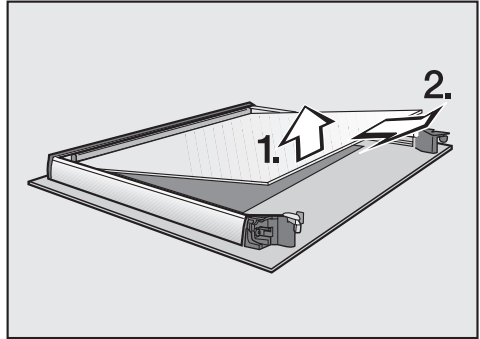

- Gently lift up the lower of the two middle panes and remove it.
- Clean the glass panes and other components with a Miele E-cloth or a clean sponge and a solution of hot water and washing-up liquid. Wipe dry using a soft cloth.
- To reassemble the door:

The two middle panes are identical. To ensure they are refitted correctly, one of the corners is more angled than the others.

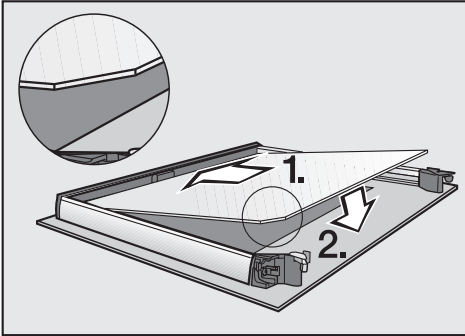

- Replace the first of the middle panes. The more angled corner must be at the bottom left.

When refitting the upper pane, the more angled corner must be inserted at the top left.

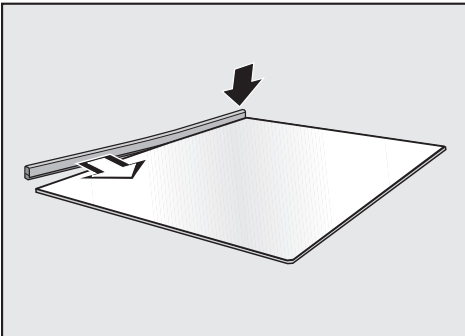

- Secure the seal to the second of the middle panes.

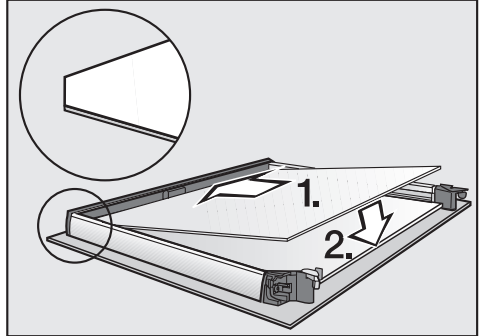

- Replace the upper of the two middle panes together with the seal. The more angled corner must be at the top left.

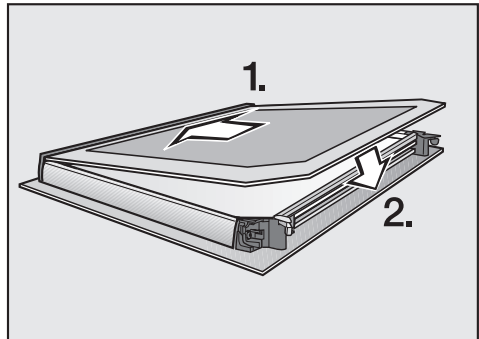

- Push the inner pane into the plastic strip and insert it in the retainers.

Cleaning and care

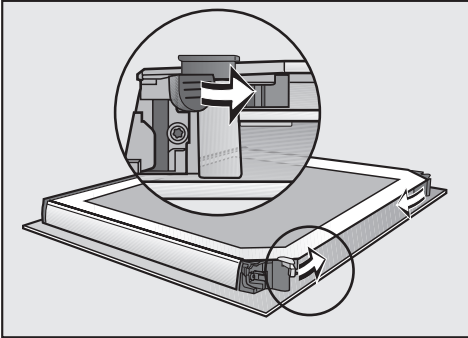

- Flip the glass pane retainers inwards to close them.

To refit the door

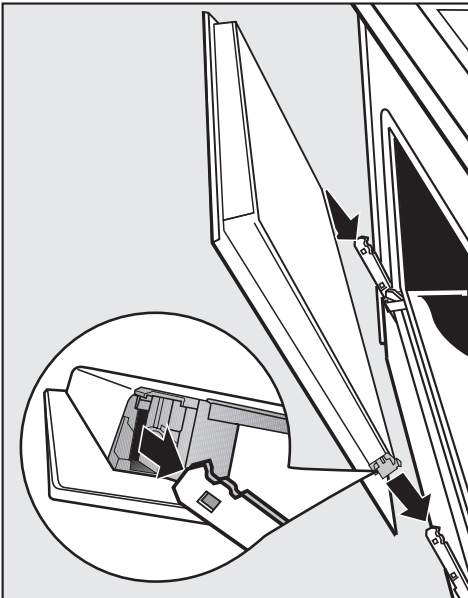

- Hold the door securely at both sides and carefully fit it back onto the hinge guides.

Make sure that the door goes back on straight.

- Open the door fully.

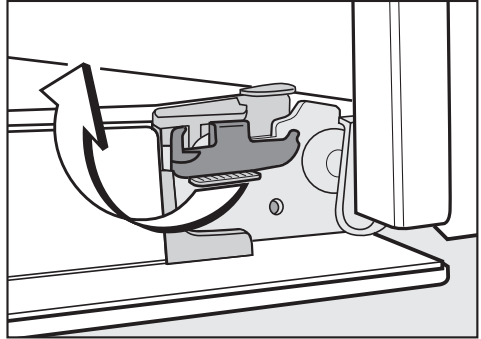

- Flip both locking clamps back up as far as they will go into a horizontal position.

It is essential that the clamps are locked after refitting the door. Otherwise the hinges could work loose, resulting in damage to the door.

To remove the FlexiClip telescopic runners

Make sure the oven heating elements are switched off and cool. Danger of burning.

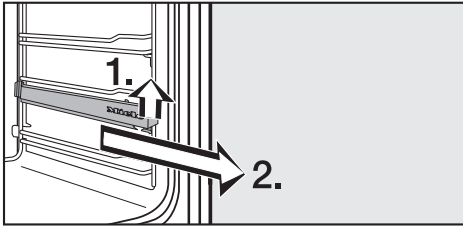

- Lift the FlexiClip runner up at the front and pull it out along the rail.

Refit the runners carefully as described in "Features".

To remove the side runners

Make sure the oven heating elements are switched off and cool. Danger of burning.

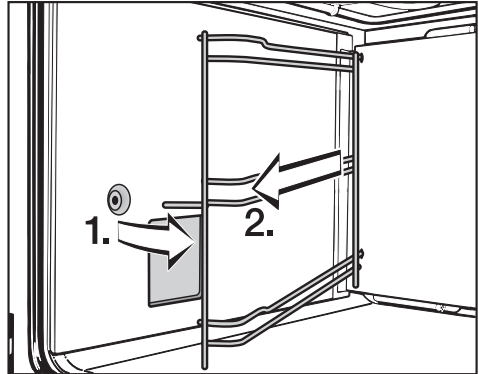

- Pull the runners forwards out of the holder and remove.

Reassemble in the reverse order, carefully ensuring all parts are correctly in place.

Cleaning and care

To remove the back panel

Make sure the oven heating elements are switched off and cool.
Danger of burning.

The back panel can be removed for cleaning if necessary.

See "Cleaning and care" for information on cleaning catalytic enamelled panels.

- Remove the runners.
- Loosen the screws in the back panel and take it out.

The oven must not be used without the back panel fitted. This could cause considerable injury.

Reassemble in the reverse order, carefully ensuring all parts are correctly in place.

To lower the top heat/grill element

Make sure the oven heating elements are switched off and cool.
Danger of burning.

- Remove the runners.

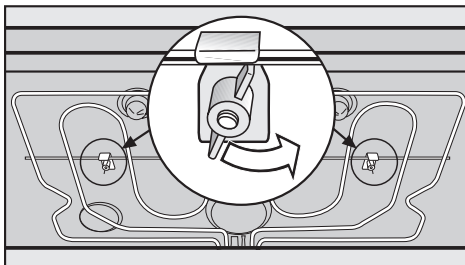

- Unscrew the wing nuts and lower the top heating element.

Do not use force to pull it down as this can cause the element to break.

Reassemble in the reverse order, carefully ensuring all parts are correctly in place.

Make sure that the wing nuts are tightened back up properly.

Descaling

Only use the descaling tablets supplied with the appliance. These have been specially formulated and are available from the Miele Spare Parts Department or via the internet on www.miele-shop.com.

Other types of descaling agents will damage the oven.

Follow the instructions on the package carefully to avoid damaging the oven.

Clean the oven interior after descaling to ensure that all traces of descaling agent have been removed.

When to run the descaling programme

The descaling programme can be run at any time.

However, to ensure the oven functions correctly you will be automatically prompted to run the descaling programme after a certain number of oven uses.

Descaling process (overview)

The descaling process takes approx. 90 minutes and includes a number of stages:

- ① Preparing the descaling solution
- ② Drawing in the descaling solution
- ③ Activation phase
- ④ Rinse 1
- ⑤ Rinse 2
- ⑥ Rinse 3
- ⑦ Evaporating the residual moisture

Cleaning and care

Preparation

- Dissolve one descaling tablet in approx. 600 ml of cold tap water.
- Place the universal tray on the top shelf level to collect the descaling solution after it has been used.

A plastic tube (with clip) is supplied with your oven so that you do not have to hold the container with the descaling agent underneath the water intake tube.

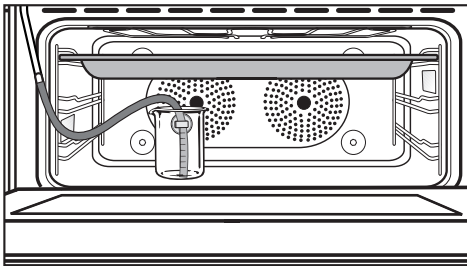

- Attach the plastic tube to the end of the water intake tube. Place the other end in the bottom of the descaling solution container and secure it to the container with the clip.
- Close the door.

Start the descaling process.

- Select the "Descale" option.
- Press the OK sensor to start the suction process.

The segment display shows how the descaling process is progressing. You can hear the pump during the descaling process.

The amount of solution specified can be more than the amount which is actually taken in which means that some of the solution will be left in the container at the end of descaling. Top the container up with approx. 300 ml of water to the container, as the system will need to draw in some more liquid during the activation phase.

Once the descaling solution has been drawn into the appliance

- "Activation phase" will appear in the display.
The activation phase takes approx. 60 minutes.
- the time left for the activation phase will be shown counting down in the display.

The system will take in more liquid at approximately five minute intervals. You will hear the noise of the pump for a moment or so.

The oven lighting and the cooling fan will remain on during descaling.

The steam injection system will need to be cleaned **at the end of the descaling process** to remove all traces of descaling solution.

Prompts to do this will appear in the display.

Cleaning is carried out by flushing approx. 1 litre of mains tap water through the system. The water is collected in the universal tray. This process is repeated three times.

- Take the universal tray out of the oven and empty it. Place the tray back in the oven again at the top shelf level.
- Unclip the plastic tube from the container. Rinse the container and fill with approx. one litre of tap water. Place the container in the oven, insert the plastic tube and secure it to the container with the clip.
- Start the first rinse.
- Repeat twice.

Empty the universal tray before the second and third rinse.

After the third rinse, residual water will need to be evaporated from the steam injection system.

Before proceeding, remove the plastic tube and the container from the oven.

The oven will heat up to "Evaporate residual moisture". The time counts down in the display.

Allow the oven to cool down before cleaning by hand. Danger of burning.

- Remove the universal tray and empty it. Clean the oven interior to remove any condensation and descaling agent residue.

Leave the oven door open until the oven interior is completely dry.

Problem solving guide

With the aid of the following guide, minor problems can be easily corrected without contacting Miele.

If you cannot resolve a problem following these instructions please contact Miele Service.





Do not attempt to open the appliance casing yourself!

Installation, maintenance and repairs may only be carried out by a suitably qualified and competent person in strict accordance with current national and local safety regulations.

Repairs and other work by unqualified persons could be dangerous. The manufacturer cannot be held liable for unauthorised work.

Problem	Possible cause and remedy
The display is dark.	<ul style="list-style-type: none">– Check whether the time display is set so that it does not show in the display (see "Settings - Time (of day) display").– Check whether the mains fuse has tripped. If it has not tripped, contact a qualified electrician or the Miele Service Department.
The oven does not heat up.	<ul style="list-style-type: none">– Check if the system lock  has been activated.– Check whether the demo programme mode has been activated (see "Settings - Showroom programme").– Check whether the mains fuse has tripped. If it has not tripped, contact a qualified electrician or the Miele Service Department.
A noise can be heard after a cooking programme.	The cooling fans remain switched on after the end of a cooking programme (see "Settings - Cooling fan run-on").

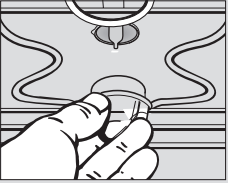
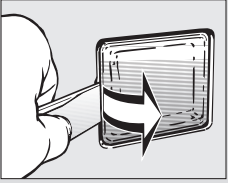
Problem solving guide

Problem	Possible cause and remedy
<p>The top lighting is not working.</p> 	<ul style="list-style-type: none"> ■ Disconnect the appliance from the electricity supply: Switch off and unplug at the socket, or disconnect the fuse, or switch off at the isolator as appropriate. ■ Turn the lamp cover a quarter turn anti-clockwise to release it and then pull it downwards to take it out. ■ Replace it with a new halogen lamp (Osram 66725 AM/A, 230 V, 25 W, G9). ■ Refit the lamp cover and turn it clockwise to secure it. ■ Reconnect the appliance to the mains electricity supply.
<p>The side lighting is not working.</p> 	<ul style="list-style-type: none"> ■ Disconnect the appliance from the electricity supply: Switch off and unplug at the socket, or disconnect the fuse, or switch off at the isolator as appropriate. ■ Remove the shelf runners. ■ Use the lever supplied to release the lamp cover from its frame. ■ Replace it with a new halogen lamp (Osram 66725 AM/A, 230 V, 25 W, G9). ■ Push the lamp cover back into its retainers, and replace the shelf runners. ■ Reconnect the appliance to the mains electricity supply.
<p>Cakes and biscuits are not cooked properly after following the times given in the chart.</p>	<ul style="list-style-type: none"> – Check that the correct temperature has been set. – Check whether there has been a change to the recipe. The addition of more liquid or more eggs makes a moister mix which would need longer to cook.
<p>Cakes and biscuits are browning unevenly.</p>	<p>There will always be a slight unevenness. If browning is very uneven check that the correct temperature was set and that the correct shelf level was used. With conventional heat  the material and colour of the tin used plays an important role. Light coloured, shiny tins are less suitable.</p>

Problem solving guide

Problem	Possible cause and remedy
There are spots like rust on the catalytic surfaces.	When roasting on the rack, the circulating air sometimes picks up spices, which are then deposited on the oven interior walls. These residues are not removed by catalytic cleaning, and should be removed while fresh with a mild solution of hot water and washing-up liquid applied with a soft brush.
"Maximum operating duration reached" appears in the display.	Safety switch-off has been activated. The appliance will be ready for use again after it has been switched off and then back on again.
The oven has automatically switched itself off after a cooking programme.	The oven switches off automatically to save energy if, at the end of an Automatic programme or a cooking programme with Automatic switch-off, no other cooking function is selected within a certain time period. The oven is ready for use again when you switch it on.
A fault code appears in the display: F + a number	You can rectify the faults with the following codes yourself: – Fault 54: The food probe is faulty. The message will go out as soon as the food probe is removed from the oven. A replacement can be ordered from your Miele Dealer or the Miele Spare Parts Department. For all other fault codes please contact the Miele Service Department.

In the event of any faults which you cannot remedy yourself, or if the appliance is under guarantee, please contact

– your Miele Dealer

or

– Miele (see back cover for address).

A call-out charge will be applied for service visits where the problem could have been resolved as described in these instructions.

When contacting Miele, please quote the model and serial number of your appliance.

These are shown on the data plate, visible on the front frame of the oven, with the door fully open.

Please note that telephone calls may be monitored and recorded to improve our service.

Optional accessories

The following accessories may come as standard with some models. They are also available to order at extra cost via the internet on www.miele-shop.com, your Miele Dealer or the Miele Spare Parts Department.

FlexiClip telescopic runners

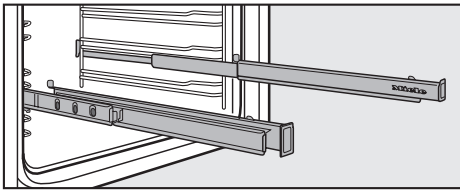

More FlexiClip telescopic runners can be fitted in the oven in addition to those supplied.

Univeral tray, Rack

These items, supplied with your oven, are also available to order.

When ordering, please quote the model number of your oven.

Anti-splash insert

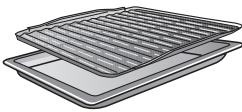

The anti-splash insert should be placed in the Univeral tray when grilling or roasting.

The juices from the food being cooked collect under the anti-splash insert. This prevents them from spitting and making the oven dirty. The juices can then be used for making gravy and sauces.

The surface has been treated with PerfectClean enamel.

Pizza stone

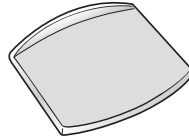

The pizza stone is ideal for items which need a well baked base such as pizza, quiche, bread, bread rolls and savoury snacks.

The pizza stone is made from heat retaining fire brick and is glazed.

Place it directly on the rack.

A paddle made of untreated wood is supplied with it for placing food on the pizza stone and taking it off.

Flan/Pizza dish

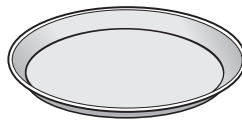

This circular pan is suitable for cooking pizzas, flat cakes made with yeast or whisked mixtures, sweet and savoury tarts, baked desserts, and can also be used for frozen cakes and pizzas.

The surface has been treated with PerfectClean enamel.

Gourmet oven dish

The gourmet oven dish can be placed in the oven directly on the rack. It has an anti-stick coating and is available in two sizes:

- HUB 61-22 (internal dimensions 38 x 22 x 8 cm)

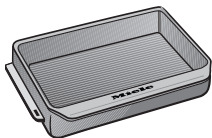

- HUB 61-35 (internal dimensions approx. 38 x 35 x 8 cm)

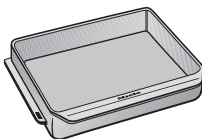

Gourmet oven dish lid

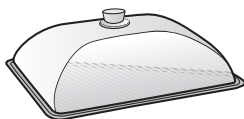
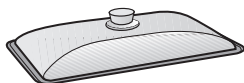

When ordering a lid, please specify the gourmet oven dish it is to be used with (HUB 61-22 or -35).

Child safety lock

The lock is fitted beneath the control panel on the left to prevent the door from being opened. The door can only then be opened by pressing the lever.

Miele E-cloth

Removes grease and stains and leaves no smearing. Suitable for cleaning surfaces such as stainless steel, glass, plastic and chrome without the use of chemicals.

Oven cleaner

Suitable for removing stubborn soiling. It is not necessary to pre-heat the oven beforehand.

Electrical connection

All electrical work should be undertaken by a suitably qualified and competent person in strict accordance with current national and local safety regulations (BS 7671 in the UK).

Installation, repairs and other work by unqualified persons could be dangerous. The manufacturer cannot be held liable for unauthorised work.

Ensure power is not supplied to the appliance until after installation or repair work has been carried out.

The **voltage and connected load** are given on the data plate, visible below the oven interior, with the door open. Ensure that these match the household mains supply. Please quote these data, and the model and serial number when contacting Miele.

Connection of this appliance should be made via a fused connection unit or a suitable isolator, which complies with national and local safety regulations, and the on/off switch should be easily accessible after the appliance has been built in.

If the switch is not accessible after installation (depending on country) an additional means of disconnection must be provided for all poles.

For extra safety it is advisable to install a residual current device (RCD). Please contact a qualified electrician for advice.

When switched off there must be an all-pole contact gap of 3 mm in the isolator switch (including switch, fuses and relays acc. to EN 60 335).

Important U.K.

The appliance is supplied for connection to a single-phase 230-240 V, 50 Hz supply with a 1.7 m long 3-core cable.

The wires in the mains lead are coloured in accordance with the following code:

Green/yellow = earth

Blue = neutral

Brown = live

WARNING

THIS APPLIANCE MUST BE EARTHED

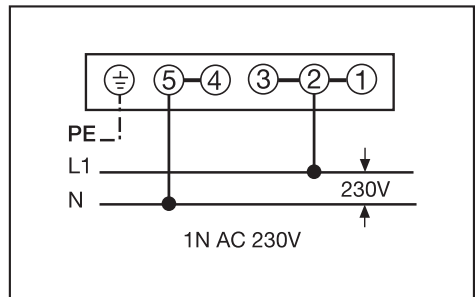

When replacing the cable supplied with another cable or changing the connection, only cable type H 05 VV-F with a suitable cross-sectional area (CSA) may be used (available from Miele Spare Parts).

Electrical connection - Country variants

Please refer to your electrical distributor.

Single phase AC 230 V - country variant

This device is intended for connection to a power supply system where the maximum value of external phase neutral loop impedance Z_{max} of 0.35 Ohms at the point of distributor supply connection is not exceeded. If in doubt, please ask your electrical distributor for actual Z_{max} value. The user has to ensure that this device is connected only to a power supply system which fulfils the requirement above.

Wiring diagram – country variant

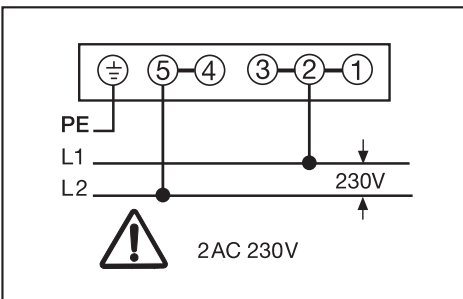
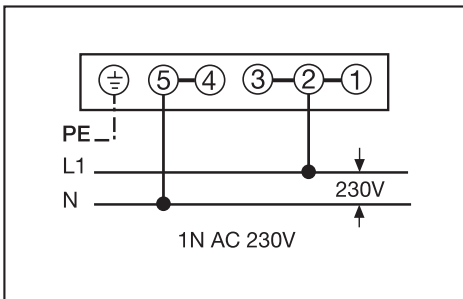

Three phase 3 N AC 230 V

Wiring diagram – country variant

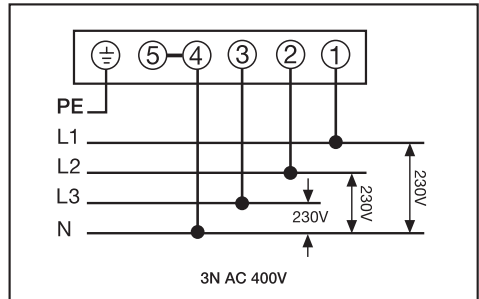

Building-in diagrams

Dimensions are give in "mm".

Appliance dimensions and unit cut-out

Installation in a base unit

HAL 5900 trim, available as an optional accessory, is only required when building the oven into a base unit.

- Fix the HAL 5900 trim into the unit cut-out under the worktop (see lower section of diagram).

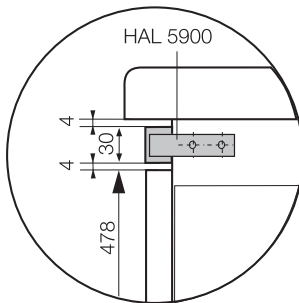
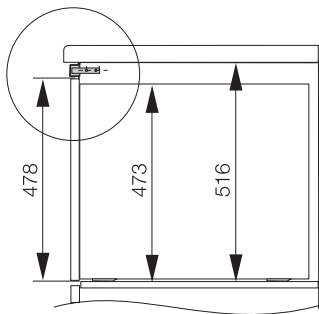
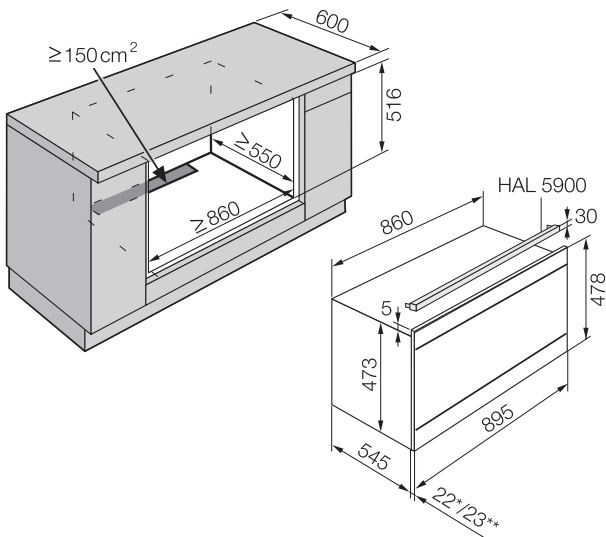

* Appliances with glass front

** Appliances with metal front

Installation in a tall unit

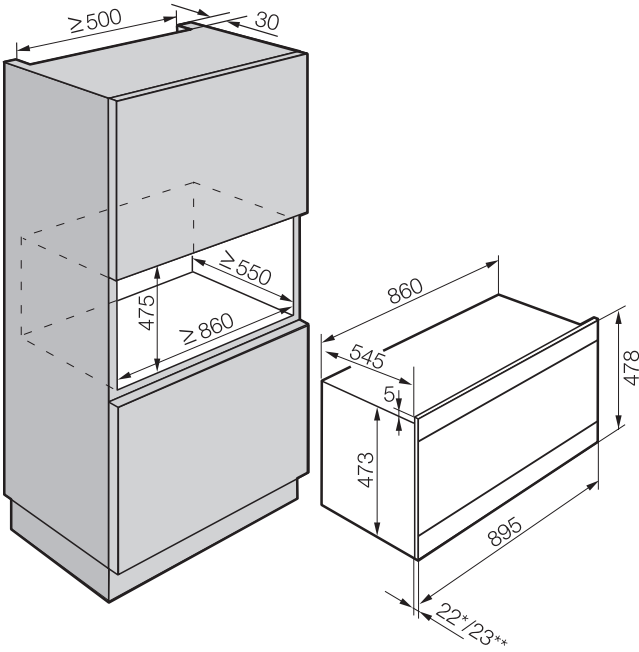

Building-in diagrams

Front dimensions

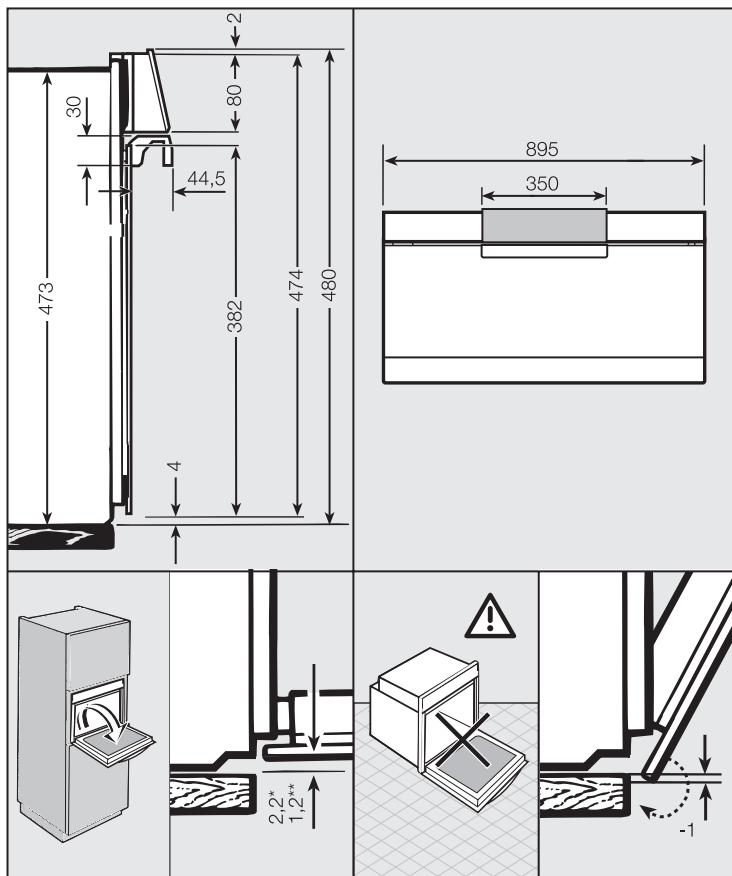

* Appliances with glass front

** Appliances with metal front

Installing the oven

 The oven must not be operated until it has been correctly installed in its housing unit. Otherwise it poses an electric shock hazard.

To ensure adequate ventilation to the oven once installed:

- do not fit a rear panel into the housing unit.
- make sure that the shelf on which the appliance is placed does not touch the wall.
- do not fit insulation material inside the housing unit.

When installing the appliance, do not lift it up by the door handle as this can damage the door.

Turn off the mains electricity supply to the isolator.

Remove the handles at the sides.

- Connect the mains cable from the oven to the isolator.
- Push the appliance into the oven housing unit and align it.

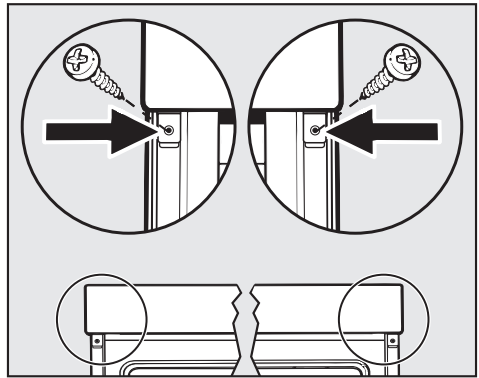

- Open the oven door and using two screws secure it to the side walls of the housing unit through the holes in the oven trim.

United Kingdom

Miele Co. Ltd.
Fairacres, Marcham Road
Abingdon, Oxon, OX14 1TW
Tel: 0845 365 0555
Fax: 0845 365 0777
Customer Contact Centre Tel: 0845 365 6600
E-mail: info@miele.co.uk
Internet: www.miele.co.uk

Australia

Miele Australia Pty. Ltd.
ABN 96 005 635 398
1 Gilbert Park Drive, Knoxfield, VIC 3180
Tel: (03) 9764 7130, Fax: (03) 9764 7149
Internet: www.miele.com.au

China

Miele Shanghai
Suite 4105-06, Plaza 66
1266 Nanjing Road West
Jing An District
Shanghai 200040, PRC
Tel: +86 21 6288 4200, Fax: +86 21 6288 4100
E-mail: mieleshanghai@cn.miele.com
Internet: www.miele.cn

Miele (Hong Kong) Limited

41/F - 4101, Manhattan Place
23 Wang Tai Road
Kowloon Bay
Hong Kong
Tel: (852) 2610 1331
Fax: (852) 2610 1013
Email: mielehk@miele.com.hk

India

Miele India Pvt. Ltd.
Ground Floor, Copia Corporate Suites
Plot No. 9, Jasola
New Delhi - 110025
Tel: 011-46 900 000, Fax: 011-46 900 001
E-mail: customercare@miele.in
Internet: www.miele.in

Germany - Miele & Cie. KG
Carl-Miele-Straße 29, 33332 Gütersloh

Miele

Ireland

Miele Ireland Ltd.
2024 Bianconi Avenue
Citywest Business Campus, Dublin 24
Tel: (01) 461 07 10, Fax: (01) 461 07 97
E-Mail: info@miele.ie, Internet: www.miele.ie

New Zealand

Miele New Zealand Limited
Unit L, 10-20 Sylvia Park Road
Mt. Wellington, 1060, Auckland, NZ
Tel: 0800 264 353, Fax: 0800 463 453
Internet: www.miele.co.nz

Singapore

Miele Southeast Asia
Miele Pte. Ltd.
163 Penang Road
04 - 02/03 Winsland House II
Singapore 238463
Tel: +65 6735 1191, Fax: +65 6735 1161
E-Mail: infosea@miele.com.sg
Internet: www.miele.sg

South Africa

Miele (Pty) Ltd
63 Peter Place, Bryanston 2194
P.O. Box 69434, Bryanston 2021
Tel: +27 (0) 11 548-1900
Fax: +27 (0) 11 548-1935
E-mail: info@miele.co.za
Internet: www.miele.co.za

United Arab Emirates

Miele Appliances Ltd.
P.O. Box 11 47 82
Gold & Diamond Park
Sheikh Zayed Road
Building 6 / Offices Nos. 6-214 to 6-220
Dubai
Tel: +971-4-341 84 44
Fax: +971-4-341 88 52
E-Mail: info@miele.ae
Internet: www.miele.ae

Free Manuals Download Website

<http://myh66.com>

<http://usermanuals.us>

<http://www.somanuals.com>

<http://www.4manuals.cc>

<http://www.manual-lib.com>

<http://www.404manual.com>

<http://www.luxmanual.com>

<http://aubethermostatmanual.com>

Golf course search by state

<http://golfingnear.com>

Email search by domain

<http://emailbydomain.com>

Auto manuals search

<http://auto.somanuals.com>

TV manuals search

<http://tv.somanuals.com>