

# Miele

## Operating and installation instructions



## Ceramic hobs with induction KM 5987 / KM 5993 / KM 5997

To avoid the risk of accidents or damage to the appliance it is **essential** to read these instructions before it is installed and used for the first time.

en - GB

M.-Nr. 07 257 460

# Contents

---

<b>Guide to the appliance</b> .....	4
Hob .....	4
Control panel .....	5
Cooking zone display .....	6
Timer/Memory display .....	6
Cooking zones .....	7
Special feature .....	7
<b>Warning and safety instructions</b> .....	8
<b>Caring for the environment</b> .....	14
<b>Before using for the first time</b> .....	15
Cleaning for the first time .....	15
Before using for the first time .....	15
Calibrating the sensors .....	16
<b>Induction</b> .....	17
The induction principle .....	17
Noises .....	18
Pans .....	19
<b>Use</b> .....	20
Sensor switches .....	20
Switching on .....	20
Settings .....	21
Auto heat-up .....	22
Cooking without Auto heat-up .....	23
Booster function .....	24
Keeping warm .....	26
Switching off and residual heat indicators .....	27
<b>Timer and Memory function</b> .....	28
Timer .....	28
Memory function .....	30
Using the Timer and Memory function at the same time .....	32

<b>Safety features</b> . . . . .	33
Safety lock/System lock . . . . .	33
Stop and Go . . . . .	34
Safety switch-off. . . . .	35
Overheating protection . . . . .	36
<b>Cleaning and care</b> . . . . .	37
<b>Programming</b> . . . . .	39
<b>Problem solving guide</b> . . . . .	42
<b>Optional accessories</b> . . . . .	44
<b>Safety instructions for installation</b> . . . . .	45
<b>Hob with frame or bevelled edge</b> . . . . .	50
Building-in dimensions . . . . .	50
Installation . . . . .	51
General installation tips . . . . .	52
<b>Flush-fitted hobs</b> . . . . .	53
Building-in dimensions . . . . .	53
Installation . . . . .	55
<b>Electrical connection</b> . . . . .	58
Wiring diagram . . . . .	60
<b>After sales service, data plate</b> . . . . .	61

# Guide to the appliance

## Hob

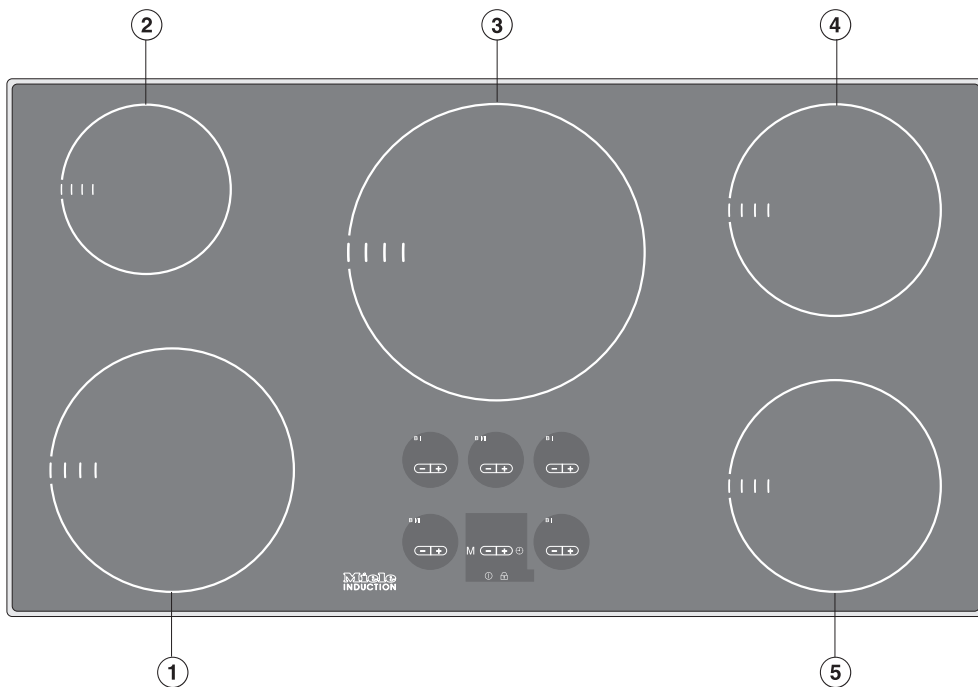

①③ Cooking zones with Twin Booster

②④⑤ Cooking zones with Single Booster

## Control panel

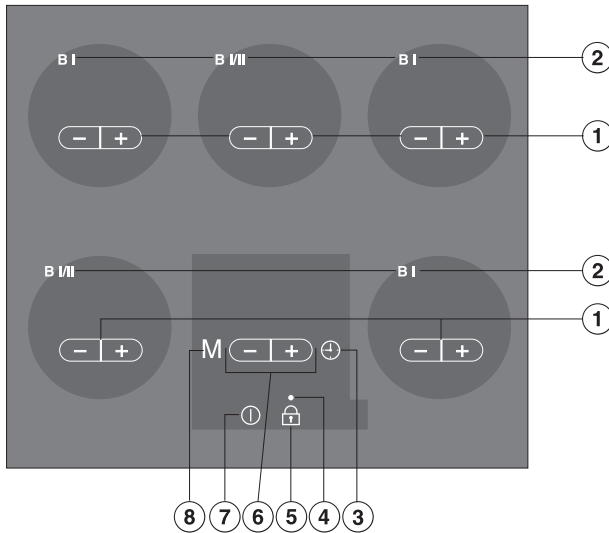

### Sensor switches

- ① For setting the power level
- ② Booster
- ③ For setting the timer, changing between functions, and selecting a cooking zone
- ⑤ Safety lock
- ⑥ For setting the time/selecting a memory programme
- ⑦ Hob ON/OFF
- ⑧ Memory function

### Indicator lamp for

- ④ Safety lock

# Guide to the appliance

## Cooking zone display

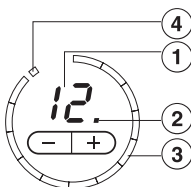

### ① Displays:

- 0* = Cooking zone ready for use
- h* = Keeping warm function
- 1* to *12* = Power levels
- I* = Single Booster I
- II* = Twin Booster II
- ≡* = Residual heat
- ∪* = No pan on cooking zone or pan unsuitable (see "Induction")
- F* = Fault (see "Safety switch-off")
- R* = Auto heat-up when the power setting range has been extended
- P0* etc. = Programme (see "Programming")
- S0* etc. = Status (see "Programming")



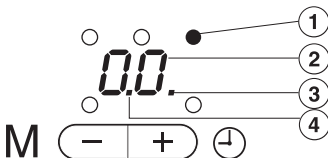

- ② Indicator lamp for extending the power setting range (see "Programming")
- ③ Light ring: The number of curved lines lit up equates to the power setting chosen (exception: during the "Auto heat-up" phase - See "Auto heat-up").
- ④ This segment lights up when a booster is activated.

## Timer/Memory display



- ① Indicator lamp for relevant zone, e.g. the rear right cooking zone
- ② Display for Time/Memory programme
  - 00* to *99* = Time
  - P1* to *P5* = Memory programme
- ③ Memory programme indicator lamp
- ④ Indicator lamp for half hours with a minute minder time of more than 99 minutes

## Cooking zones

Cooking zone	KM 5987 / KM 5993 / KM 5997	
	Minimum to maximum Ø in cm*	Rating in watts for 230 V**
	16 - 23	Normal: 2300 With Single Booster I: 3000 With Twin Booster II: 3700
	10 - 16	Normal: 1400 With Booster: 1800
	18 - 28	Normal: 2400 With Single Booster I: 3000 with Twin Booster II: 3700
	14 - 20	Normal: 1850 With Booster: 2900
	14 - 20	Normal: 1850 With Booster: 2900
		Total: 11100

\* Pans of any diameter within the given range may be used.

\*\* The wattage quoted may vary depending on the size and material of the pans used.

## Special feature

Hobs bearing the @ symbol in the top left-hand corner are suitable for connecting to the Miele@home system (see "Optional accessories").

# Warning and Safety instructions

---

This appliance complies with all relevant local and national safety requirements. Improper use of the appliance can, however, present a risk of both personal injury and material damage.

To avoid the risk of accidents and damage to the appliance, please read these instructions carefully before installation and before using it for the first time.

They contain important notes on the installation, safety, operation and care of the appliance.

Keep these instructions in a safe place and ensure that new users are familiar with the content. Pass them on to any future owner.

## Correct application

► This hob is not designed for commercial use. It is intended for use in domestic households and for use in similar working and residential environments such as:

- Shops
- Offices and showrooms and by residents in establishments such as:
  - hostels and guest houses.

It must only be used as a domestic appliance to cook and keep food warm. Any other usage is not supported by the manufacturer and could be dangerous. Miele cannot be held liable for damage resulting from incorrect or improper use or operation of the appliance.

► This appliance is not intended for use by persons (including children) with reduced physical, sensory or mental capabilities, or lack of experience or knowledge, unless they are supervised whilst using it, or have been shown how to use it correctly by a person responsible for their safety.



## Safety with children

▶ Use the safety lock to prevent children operating the appliance or altering the settings.

▶ Keep children away from the appliance at all times. It is not a toy! To avoid the risk of injury, do not allow them to play with it or use the controls. They will not understand the potential dangers posed by it. They should be supervised whenever you are working in the kitchen.

▶ Older children may use the appliance only when its operation has been clearly explained to them and they are able to use it safely, recognising the dangers of misuse.

▶ The appliance gets hot when in use and remains hot for quite a while after being switched off. To safeguard against burning, keep children well away from the appliance at all times.

▶ Do not store anything which might arouse a child's interest in storage areas above or next to the appliance. Otherwise they could be tempted into climbing onto the appliance with the risk of burning themselves.

▶ Keep all pans out of reach of children. Turn pan handles inwards away from the edge of the hob. Danger of burning or scalding. Special hob guards are available from good retail outlets.

▶ Packaging, e.g. cling film, polystyrene and plastic wrappings, must be kept out of the reach of babies and young children. Danger of suffocation. Dispose of or recycle all packaging safely as soon as possible.

# Warning and Safety instructions

---

## Technical safety

► Before installation, check the appliance for visible signs of damage. Do not install and use a damaged appliance, it could be dangerous.

► The electrical safety of this appliance can only be guaranteed when continuity is complete between it and an effective earthing system which complies with local and national safety regulations. It is most important that this basic safety requirement is present and regularly tested, and where there is any doubt, the household wiring system should be inspected by a qualified electrician. The manufacturer cannot be held liable for the consequences of an inadequate earthing system (e.g. electric shock).

► Before connecting the appliance, make sure that the connection data on the data plate (voltage and connected load) match the mains electricity supply. This data must correspond in order to avoid the risk of damage to the appliance. Consult a qualified electrician if in any doubt.

► For safety reasons, this appliance may only be used after it has been built in.

► Never open the housing of the appliance. Tampering with electrical connections or components and mechanical parts is highly dangerous to the user and can cause operational faults.

► Installation, maintenance and repairs may only be carried out by a Miele authorised person in strict accordance with current national and local safety regulations. Repairs and other work by unqualified persons could be dangerous. The manufacturer cannot be held liable for unauthorised work.

► During installation, maintenance and repair work, the appliance must be disconnected from the mains electricity supply. It is only completely isolated from the electricity supply when:

- the mains fuse is disconnected, or
- the screw-out fuse is removed (in countries where this is applicable), or
- it is switched off at the wall socket and the plug is withdrawn from the socket, or it is switched off at the isolator.

► If the hob is fitted with a communication module this must be disconnected from the electricity supply during installation and maintenance work and during any repair work to the hob.

► While the appliance is under guarantee, repairs should only be undertaken by a service technician authorised by the manufacturer. Otherwise the guarantee is invalidated.

# Warning and Safety instructions

---

▶ Faulty components must only be replaced by genuine Miele original spare parts. The manufacturer can only guarantee the safety of the appliance when Miele replacement parts are used.

▶ If the connection cable is damaged, it must be replaced by a suitably qualified electrician with a specialist connection cable of type H 05 VV-F (pvc insulated), available from the Miele Spare Parts Department.

▶ Do not connect the appliance to the mains electricity supply by a multi-socket unit or an extension lead. These do not guarantee the required safety of the appliance (e.g. danger of overheating).

▶ Do not use the hob if it is faulty, or if the ceramic surface is cracked, chipped or damaged in any way. Switch it off immediately, and disconnect it from the mains electricity supply. Danger of electric shock.

▶ In countries where there are areas which may be subject to infestation by cockroaches or other vermin, pay particular attention to keeping the appliance and its surroundings in a clean condition at all times. Any damage caused by cockroaches or other vermin will not be covered by the guarantee.

## Correct use

▶ For people fitted with a heart pacemaker:

Please note that the area immediately surrounding the hob is electromagnetically charged. It is unlikely to affect a pacemaker. However, if in any doubt, consult the manufacturer of the pacemaker or your doctor.

▶ To prevent damage to items which are susceptible to magnetic fields, e.g. credit cards, diskettes, pocket calculators etc, do not leave them in the immediate vicinity of the hob.

▶ The appliance gets hot when in use and remains hot for quite a while after being switched off. There is a danger of burning until the residual heat indicators go out.

▶ Do not leave the appliance unattended whilst it is in use. Pans that have boiled dry can cause damage to the ceramic surface for which the manufacturer cannot be held liable. Boiling fat or oil could ignite and cause a fire.

▶ If, despite this, oil or fat does catch fire, do not attempt to put out the flames with water. Use a suitable fire blanket, saucepan lid, damp towel or similar to smother the flames.

# Warning and Safety instructions

---

- ▶ For added protection, it is advisable to use heat-resistant pot holders or gloves when using the appliance. Do not let them get damp or wet, as this causes heat to transfer through the material more quickly with the risk of scalding or burning yourself.
- ▶ Do not flambé under a cooker hood. The flames could set the cooker hood on fire.
- ▶ Do not use the appliance as a resting place for anything else. Take particular care never to place cutlery or other metal objects on the appliance. When the appliance is switched on either deliberately or by mistake, or when there is residual heat present, there is the risk of metal objects heating up, with a danger of burning. Depending on the material, other objects left on the hob could also melt or catch fire. Damp pan lids might adhere to the ceramic surface and be difficult to dislodge. Switch the cooking zones off after use.
- ▶ Do not cover the appliance, e.g. with a cloth, kitchen foil, etc. This could be a fire hazard if the appliance is switched on by mistake.
- ▶ Do not use plastic or aluminium foil containers. These melt at high temperatures, and could catch fire.
- ▶ Do not heat up unopened tins of food on the hob, as pressure will build up in the tin, causing it to explode. This could result in injury and scalding or damage.
- ▶ Do not use pots and pans on the ceramic hob with bases with pronounced edges or ridges, e.g. cast iron pans. These could scratch or scour the hob surface permanently.
- ▶ Never heat an empty pan unless the manufacturer of the pan expressly states that you can do so. Because induction heating works extremely quickly the base of the pan could heat up to the temperature at which oil or fat self-ignites within a very short time.
- ▶ Keep the hob clean. Grains of salt, sugar and sand (e.g. from cleaning vegetables) can cause scratches.
- ▶ Never place hot pans on the area around the controls. This could damage the electronic unit underneath.
- ▶ Do not drop anything on the ceramic surface. Even a light object could cause damage in certain circumstances.

# Warning and Safety instructions

---

▶ Do not allow either solid or liquid sugar, or pieces of plastic or aluminium foil to get onto the cooking zones when they are hot. If this should occur, switch off the appliance, and carefully scrape off all the sugar, plastic or aluminium residues from the hob whilst they are still hot, using a shielded scaper blade. Take care not to burn yourself. If residues are allowed to cool before being removed, the ceramic surface will be susceptible to pitting or even cracking. Once the residues have been removed, allow the appliance to cool down, and then clean with a suitable proprietary ceramic hob cleaner.

▶ When using an electric socket near the hob, care should be taken that the cable of the electrical appliance does not come into contact with a hot cooking zone. The insulation on the cable could become damaged, giving rise to an electric shock hazard.

▶ This appliance is fitted with a cooling fan. If a drawer is fitted directly underneath the hob, ensure that there is sufficient space between the drawer and its contents and the underside of the appliance in order to ensure sufficient ventilation for the hob. Do not store pointed or small items or paper in the drawer. They could get in through the ventilation slots or be sucked into the housing by the fan and damage the fan or impair cooling.

▶ Spray canisters, aerosols and other inflammable substances must not be stored in a drawer under the hob. Cutlery inserts must be heat-resistant.

▶ Metal utensils stored in a drawer under the hob can become hot if the induction hob is used intensively for a long time.

▶ Always ensure that food is sufficiently cooked or reheated. Some foods may contain micro-organisms which are only destroyed by thorough cooking at a sufficiently high temperature for long enough. Therefore, when cooking or reheating food such as poultry, it is particularly important that the food is completely cooked through. If in doubt, select a longer cooking or reheating time.

▶ Do not use two pans on a cooking/extended zone at the same time.

▶ If the hob is installed behind a furniture door it may only be operated with the door open. Do not close the door whilst the hob is in use or whilst there is any residual heat left in the appliance.

▶ If the hob is built in over a pyrolytic oven, the hob should not be used whilst the pyrolytic process is being carried out, as this could trigger the overheating protection mechanism on the hob (see relevant section).

The manufacturer cannot be held liable for damage caused by non-compliance with these Warning and Safety instructions.

# Caring for the environment

---

## Disposal of the packing material

The transport and protective packing has been selected from materials which are environmentally friendly for disposal, and can normally be recycled.

Ensure that any plastic wrappings, bags, etc. are disposed of safely and kept out of the reach of babies and young children. Danger of suffocation.

Rather than just throwing these materials away, please ensure they are offered for recycling.

## Disposal of your old appliance

Electrical and electronic appliances often contain materials which, if handled or disposed of incorrectly could be potentially hazardous to human health and to the environment. They are, however, essential for the correct functioning of your appliance. Please do not therefore dispose of it with your household waste.

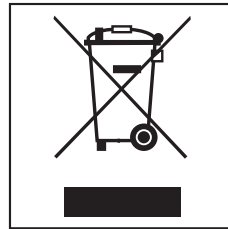

Please dispose of it at your local community waste collection/recycling centre or contact your dealer for advice. Ensure that it presents no danger to children while being stored for disposal.

It should be unplugged or disconnected from the mains electricity supply by a competent person.

## Before using for the first time

---

Please stick the extra data plate for the appliance supplied with this documentation in the space provided in the "After sales service, data plate" section of this booklet.

### Cleaning for the first time

Remove any protective wrapping and adhesive labels.

Before using for the first time, clean the appliance with a damp cloth only and then wipe dry.

Do not use washing-up liquid to clean the ceramic surface as it can leave a blue sheen which may be difficult to remove.

### Before using for the first time

On hobs with bevelled glass edges, a small gap may be visible between the hob and the worktop during the first few days after installation. This gap will reduce with time as the appliance is used and will not affect the electrical safety of your appliance.

When the appliance is used for the first time, it may give off a slight smell. The smell and any vapours will dissipate after a short time. They are not harmful and do not indicate a faulty connection or appliance.

# Before using for the first time

---

## Calibrating the sensors

### Automatic calibration

To ensure trouble free operation, the sensors

- need to be recalibrated after installation and each time the electricity supply fails, e.g. after a power cut.  
The safety lock indicator lamp lights up during automatic calibration, and the hob cannot be switched on.
- adjust themselves constantly whilst the hob is in use.

If automatic calibration is unsuccessful, an **R** lights up in the cooking zone display on the left and right at the front, and an **F** lights up on the left at the back. Numbers light up in the cooking zone display on the right at the back and in the Timer/Memory display.

If this is the case, recalibration will have to be carried out manually.

### Manual calibration

- Make sure that there is no direct light (from the sun or from an artificial source) falling onto the hob. The area surrounding the hob must not be too dark, nor should the relationship between light and shade be constantly changing.
- Make sure that there is nothing covering the sensors or the hob. Take any pans off the hob and wipe away any food deposits.
- Interrupt the power supply to the hob for approx. 1 minute.

Reconnect the hob to the electricity supply. The electronic unit will reset the sensitivity levels of the sensors.

If this does not solve the problem, please call the Miele Service department.



## The induction principle

An induction coil is located under each cooking zone. When a cooking zone is switched on, this coil creates a magnetic field which impacts directly on the base of the pan and heats it up. The cooking zone itself is heated up indirectly by the heat given off by the pan.

An induction cooking zone only works when a ferromagnetic pan is placed on it (see "Pans").

Induction automatically recognises the size of the pan, i.e. heat is only generated in the area covered by the base of the pan.

The cooking zone will not work:

- if it is switched on without a pan in place, or if the pan is unsuitable (non-magnetic base).
- if the diameter of the base of the pan is too small.
- if the pan is taken off the cooking zone when it is switched on.

If this happens,  $\text{E}$  will flash in the relevant cooking zone display alternating with  $\text{E}$  or the power setting selected .

If a suitable pan is placed on the cooking zone within 3 minutes, the  $\text{E}$  will go out and you can continue as normal.

If no pan or an unsuitable pan is placed on the cooking zone, the cooking zone and the hob will switch off automatically after 3 minutes.

Take particular care never to place cutlery or other metal objects on the hob. When the appliance is switched on either deliberately or by mistake, or when there is residual heat present, there is the risk of metal items heating up with the danger of burning. Switch the cooking zones off after use.

# Induction

---

## Noises

When using an induction cooking zone, the following noises can occur in the pan, depending on what it is made of and how it has been constructed.

- On the higher power settings, it might buzz. This will decrease or cease altogether when the power setting is reduced.
- If the pan base is made of layers of different materials (e.g. in a sandwiched base), it might emit a cracking sound.
- Whistling might occur if linked zones (see "Booster function") are being used at the same time, and the pans also have bases made of layers of different materials.
- You might hear a clicking sound from the electronic switches, especially on lower settings.

The appliance has a cooling fan to help extend the life of the electronics. When the hob is being used intensively, this will come on and you will hear a whirring sound. The fan may continue to run after the appliance has been switched off.

## Pans

### Suitable pans include:

- stainless steel pans with a magnetic base
- enamelled steel pans
- cast iron pans

### Unsuitable pans:

- stainless steel pans without a magnetic base
- aluminium and copper pans
- glass, ceramic or earthenware pots and pans

To test whether a pot or pan is suitable for use on an induction hob, hold a magnet to the base of the pan. If the magnet sticks, the pan is suitable.

Please be aware that the properties of the pan base can affect the evenness with which food heats up in the pan.

To make optimum use of the cooking zones, choose pans with base diameters larger than the innermost markings but smaller than the outermost markings. If the base diameter of the pan is smaller than the innermost marking, the induction heating will not work. The zone will behave as if it had no pan on it.

Please note that the maximum diameter quoted by manufacturers often refers to the diameter of the top rim of the pot or pan. The diameter of the base (generally smaller) is more important.

Make sure that you always place the pan in the middle of the cooking zone. If the pan only partially covers the zone, the handle could become very hot.

### Tips on saving energy

Use a lid whenever possible to minimise heat loss.

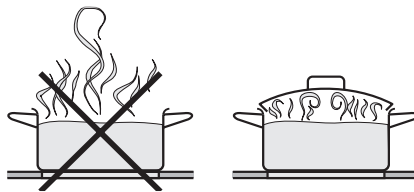

Uncovered

Covered

# Use

## Sensor switches

This hob is equipped with electronic sensor switches which react to finger contact.

To operate a cooking zone, touch the relevant sensor. Each time you touch a sensor switch, an audible tone sounds.

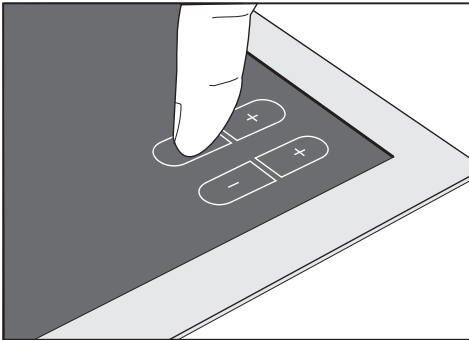

Take care only to touch the middle of the sensor required. Keep the control panel clean, and do not place anything on top of it. The sensors may fail to react or they could mistake the article or any dirt for a fingertip contact, thereby activating a function or even causing the hob to switch off automatically (see Safety switch-off.) Never place hot pans on the sensor switches. The electronic unit underneath could get damaged.



## Switching on

The hob must be switched on before any of the zones can be used.

Do not leave the appliance unattended whilst it is being used.

### To switch the hob on



- Touch the ON/OFF sensor .

 appears in each of the cooking zone displays.  appears in the Timer/Memory display. If no further entry is made, the hob will switch itself off after a few seconds for safety reasons.

### To switch a cooking zone on

- Select a power setting between 1 and 12 or the keeping warm function by touching the - or + sensor.

To select cooking **with** Auto heat-up, press the - sensor first (see "Auto heat-up"). To select cooking **without** Auto heat-up, press the + sensor first.

If you wish to switch on **another** cooking zone, and the  for that zone has already gone out, simply press the - or + briefly. The  will reappear and you can select a power setting (with or without Auto heat-up).

## Settings

	Settings*	
	Standard factory settings (12 settings)	Extended settings** (23 settings)
Keeping warm	h	h
Melting butter Dissolving gelatine	1 - 2	1 - 2.
Warming small quantities of liquid Cooking rice Defrosting frozen vegetables	3	3 - 3.
Warming liquid and semi-solid foods Thickening sauces, e.g. Hollandaise Making porridge Preparing omelettes, lightly fried eggs Steaming fruit	4 - 5	4 - 5
Defrosting deep frozen food Steaming vegetables, fish Cooking broths, pulse soups	6	5. - 6.
Bringing large quantities of food to the boil Cooking dumplings	7 - 8	7 - 8
Gentle braising (without overheating the fat) of meat, fish, vegetables, fried eggs	9 - 10	8. - 10.
Frying pancakes etc.	11	11 - 11.
Boiling large quantities of water Bringing to the boil	12	12

\* These settings, which envisage approx. 4 servings, should only be taken as a guide. With deep pans, larger quantities or when cooking without a lid, a higher setting is required. For smaller quantities, select a lower setting.

\*\* If you wish to fine-tune a setting, you can extend the power setting range (see "Programming"). The intermediate setting will be represented by an illuminated dot next to the number.

# Use

## Auto heat-up

When Auto heat-up has been activated, the cooking zone switches on automatically at the highest setting and then switches to the continued cooking setting which you have previously selected. The heat-up time depends on which continued cooking setting has been chosen (see chart).

Taking a pan off the zone whilst Auto heat-up is in operation interrupts the Auto heat-up. It will resume if a pan is placed back on the zone within 3 minutes.

Continued cooking setting*	Heat-up time in minutes and seconds (approx.)
1	0 : 15
1.	0 : 15
2	0 : 15
2.	0 : 15
3	0 : 25
3.	0 : 25
4	0 : 50
4.	0 : 50
5	0 : 50
5.	2 : 00
6	2 : 00
6.	2 : 00
7	5 : 50
7.	5 : 50
8	5 : 50
8.	2 : 50
9	2 : 50
9.	2 : 50
10	2 : 50
10.	2 : 50
11	2 : 50
11.	2 : 50
12	-

\* The continued cooking settings with a dot after the number are only available if the power level range has been extended (see "Programming").

## To activate Auto heat-up

- Switch the cooking zone on by touching the **-** sensor switch until the continued cooking setting you require appears in the in the display, e.g. **3**.

The **12 curved lines** show in the light-ring during the Auto heat-up time. After the Auto heat-up time has finished, **only the number of curved lines**, for the relevant **continued cooking setting** which has been chosen, show in the light-ring.

Example:

during the Auto heat-up time:

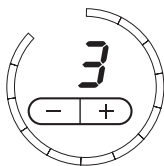

during the continued cooking time:

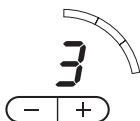

At any point during the Auto heat-up time you can use **-** or **+** to lower or increase the continued cooking setting. The Auto heat-up time will alter accordingly.

## Cooking without Auto heat-up

- Switch the cooking zone on by touching the **+** sensor until the continued cooking setting you require appears in the in the display, e.g. **4**.

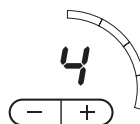

The same number of curved lines will show in the light-ring, i.e. if setting **4** is selected, four segments will light up.

# Use

---

## Booster function

The cooking zones are equipped with Single (I) or Twin Boosters (I/II) (see "Guide to the appliance").

When activated, the power is boosted so that large quantities can be heated quickly, e.g. when boiling water for cooking pasta. The cooking zones will operate with extra power for 10 minutes when Booster I is activated, and for 15 minutes when Booster II is activated.

The Booster function can only be used on two cooking zones at the same time, one on the left and one on the right.

If the Booster function is switched on when

- no setting has been selected, the cooking zone will revert automatically to setting 12 at the end of the Booster time or if the Booster function is switched off before this.
- a setting has been selected, the cooking zone will revert automatically to the setting selected at the end of the Booster time or if the Booster function is switched off before this.

Taking a pan off the zone whilst the Booster is in operation interrupts the Booster function. It will resume if the pan is placed back on the zone within 3 minutes.

The extra boost of energy is only available by taking a proportion of energy away from another cooking zone. For this reason, the cooking zones are networked in pairs as shown.

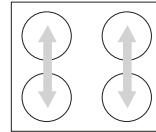

When the Booster is switched on, the following happens:

- if Auto heat-up is activated on either zone in the same network, this will be switched off.
- the power level on the other linked cooking zone will sometimes decrease.
- When Booster II is switched on, the linked cooking zone is switched off.



## To activate Booster I

- If necessary, switch on the required cooking zone.
- Touch the **B** sensor for the relevant cooking zone.

*I* will show in the cooking zone display, and the indicator lamp for the Booster function will also light up.

## To activate Booster II

- If necessary, switch on the required cooking zone.
- Touch the **B** sensor for the relevant cooking zone.

*I* will show in the cooking zone display, and the indicator lamp for the Booster function will also light up.

- Touch the **B** sensor again for the relevant cooking zone.

*II* will appear in the display for the cooking zone.

## To deactivate the Booster function

The Booster function can be switched off early.

- Touch the **B** sensor for the relevant cooking zone repeatedly until the indicator lamp for the Booster function goes out in the display, and a setting appears instead; or touch the **-** sensor for the relevant cooking zone.

# Use

---

## Keeping warm

Each cooking zone has a keeping warm function ("h"). The "h" function is in between the "0" setting and the "1" setting.

If the keeping warm function has been activated, the cooking zone will switch off automatically after a maximum of 2 hours.

This function is for keeping food that has just been cooked warm, i.e. food that is still hot. It is not for reheating food that has gone cold.

## Useful tips

Only use pans for keeping food warm. Cover the pan with a lid.

You do not have to stir food while it is being kept warm.

Nutrients are lost when food is cooked, and continue to diminish when food is kept warm. The longer food is kept warm for, the greater the loss of nutrients. Try to ensure that food is kept warm for as short a time as possible.

## Switching off and residual heat indicators

### To switch off a cooking zone

- Touch the - and + sensors for the zone you want to switch off **at the same time**.

A  will light up in the display for that zone for a few seconds. If the cooking zone is still hot, residual heat will then be indicated in the display.

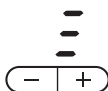

### To switch off the hob

- Touch the ON/OFF sensor .

This switches off all cooking zones. The residual heat indicator will appear in the display of any cooking zone which is still hot.

The lines of the residual heat indicator go out one after another as the cooking zones cool down. The last horizontal line only goes out when the cooking zone is safe to touch.

The residual heat indicators also react to hot dishes and plates being placed on a cooking zone that is not switched on.

Do not touch any zone or place any heat sensitive items on a zone where the residual heat indicators are lit up. Danger of burning!

Please note that the residual heat indicators do not light up if there is a fault message, even if the cooking zones are still hot.

# Timer and Memory function

---

## Timer

The timer can be used for two different functions:

- To set the minute minder
- To set a cooking zone to switch off automatically.

You can select a time from 1 minute (01) to 9<sup>1</sup>/<sub>2</sub> hours (9.h). The half hours are indicated by a dot after the number. Times of more than 99 minutes (99) are set in half-hour steps.

Use the - sensor to reduce the time from 9.h to 00, and the + sensor to increase the time from 00 to 9.h. The display stops at 2h and at 99. To continue entering the setting, briefly remove your finger from the sensor, and then touch it again.

On all functions, 00 will appear in the display for a few seconds at the end of the time, and an audible tone will sound at the same time. To turn the audible tone off before it has finished, touch the ⊖ sensor.

## Minute minder

The minute minder can be used with the hob switched on or off.

- Touch the ⊖, - or + sensor.

00 will show in the Timer/Memory display.

- Touch the - or + sensor until the time you require appears in the display, e.g. 15 minutes.

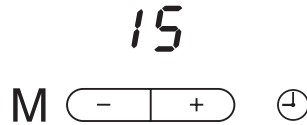

The time then counts down in minutes. The time remaining can be seen in the display and changed at any time by touching - or +.

## To cancel the time set for the minute minder

- Touch the - and + sensors at the same time.

## To switch a cooking zone off automatically

You can set a time at the end of which a given cooking zone will switch off automatically. It is only possible to programme a cooking zone to switch off automatically if a power setting has already been selected for that zone. All of the cooking zones can be programmed at the same time.

If the time programmed is longer than the maximum operational time allowed, the cooking zone will switch off after the maximum time allowed (see "Safety switch off").

- Select a power setting for the zone you require, e.g. back right, in the usual way.
- Touch the ⊖ sensor until the indicator lamp for the selected zone flashes.

If more than one cooking zone is switched on, the indicator lamps will light up clockwise beginning with the front left zone.

- Touch the - or + sensor until the time you require appears in the display, e.g. 15 minutes.

15 ☀

M [ - | + ] ⊖

The time then counts down in minutes. The time remaining can be seen in the Timer/Memory display and changed at any time by touching - or +.

If you want to set another cooking zone to switch off automatically, follow the same steps as described above.

If more than one switch-off time is programmed, the shortest time remaining will show in the display, and the indicator lamp for that particular cooking zone will flash. All the other indicator lamps will light up constantly. If you want to check the remaining time for another zone, touch the ⊖ sensor until the indicator lamp for the zone you require flashes.

# Timer and Memory function

---

## Memory function

The settings used on a particular cooking zone from switching on right through to switching off can be recorded as a Memory programme. Up to 5 of your favourite cooking processes can be saved as Memory programmes. However, only one programme can be recorded or used at any one time.

Memory programmes can be recorded on any of the cooking zones.

Each cooking zone can have more than one programme recorded on it.

Programme slots that have settings memorised to them are indicated by a dot after the number, for example:

*P 1* Nothing saved in memory

*P 1.* Programme settings are saved in memory.

If all 5 programme slots are occupied and you want to save a new cooking process, you will first have to delete one of the existing programmes.

## Recording a Memory programme

First select a Memory programme, then the cooking zone in the usual way.

The maximum time that can be recorded is 99 minutes with a maximum of 10 changes in power level.

■ Switch the hob on.

■ Touch the **M** sensor.

*P 1* will show in the Timer/Memory display.

■ Touch the **+** sensor until the programme number you require shows in the display.

■ Touch the **M** sensor until a long audible tone sounds.

■ Within 10 seconds of this, switch on the cooking zone required.

The recording process now begins.

During recording, the indicator lamp for the cooking zone being used flashes in the Timer/Memory display, and the programme number lights up.

The process will be saved automatically when the cooking zone is switched off, or if you touch **M** until a long audible tone sounds. After being saved, the programme steps show in the display.

Times are displayed rounded up to the nearest full minute, but when the programme is running the steps are timed to the second.

## Using a Memory programme

The same pan must be used in order to obtain the same cooking result as when the programme was recorded. The quantity and size of individual ingredients must also be the same.

- Switch the hob on.
- Touch the **M** sensor.

*P 7* will show in the Timer/Memory display.

- Touch the **+** sensor until the programme number you require shows in the display.
- Touch the **M** sensor until a long audible tone sounds.

The relevant cooking zone switches on automatically, and switches off once the programme has run. Whilst the programme is running, the indicator lamp for the cooking zone flashes in the Timer/Memory display, and the programme number shows alternately with the remaining time.

## Checking the steps of a Memory programme

- Switch the hob on.
- Touch the **M** sensor.
- Touch the **+** sensor until the programme number you require shows in the display.

The applicable power level appears in the appropriate cooking zone display; the indicator lamp for the cooking zone flashes in the Timer/Memory display, and the time programmed for the power level appears. Times are displayed rounded up to the nearest full minute, but when the programme is running the steps are timed to the second.

## Deleting a Memory programme

- Switch the hob on.
- Touch the **M** sensor.
- Touch the **-** or **+** sensor until the programme number you require shows in the display.

Touch the **-** and **+** sensors **at the same time** until a long audible tone sounds, and the dot after the number is deleted.

# Timer and Memory function

---

## Using the Timer and Memory function at the same time

### If you wish to use the **minute minder at the same time as another function:**

Touch the ⊖ sensor until the indicator lamps for the programmed cooking zones light up constantly, and 00 appears in the Timer/Memory display.

### If you want to programme in **one or more switch-off times at the same time as another function:**

Touch the ⊖ sensor until the indicator lamp for the required cooking zone flashes.

### If you want to use the **memory function at the same time as another function:**

Follow the steps described in "Memory function".

Shortly after the last entry, the Timer/Memory display switches to the function with the shortest remaining time. Exception: When a Memory programme is being recorded, all programmed times (minute minder, automatic switch-off) count down in the background. They only show in the display as 00 once they have completely finished running.

You can check the functions and remaining times which are counting down in the background by touching the ⊖ sensor until the indicator lamp required flashes (Memory function or automatic switch-off).

- the indicator lamps light up constantly (minute minder).

Starting with the shortest remaining time which is showing in the display, all cooking zones that are in use and the minute minder are selected clockwise. Exception: Recording a Memory programme.



## Safety lock / System lock

Keep children away from the hob for their own safety.

Your appliance is equipped with a Safety lock to prevent the hob and the cooking zones being switched on or any settings being altered.

The **Safety lock** is activated when the hob is switched on. If the Safety lock is activated:

- The cooking zone power levels and the timer settings cannot be changed.
- The cooking zones and hob can be switched off, but once switched off cannot be switched on again.

The **System lock** is activated when the hob is switched off. If the System lock is activated, the hob cannot be switched on and the timer cannot be used.

The appliance is programmed so that the System lock must be activated manually.

The System lock can be programmed to be activated automatically 5 minutes after the hob has been switched off, providing the Safety lock is not manually activated first (see "Programming").

If a sensor switch is touched when the Safety lock or the System lock is activated, the indicator lamp comes on.

If there is an interruption to the power supply, the Safety lock and the System lock will be deactivated.

### To activate the locks

- Touch the  sensor until the relevant indicator lamp comes on.

The indicator lamp will go out after a short while.

You can alter the setting from one-finger to three-finger operation (see "Programming") to make it harder for children to operate the appliance.

### To deactivate the locks

- Touch the  sensor until the indicator lamp goes out.

# Safety features

---

## Stop and Go



Your appliance has a Stop and Go feature which, when activated, reduces the power of all switched-on cooking zones to setting 7. When Stop and Go is deactivated, the cooking zones resume at the power level which was last set. If Stop and Go is not deactivated, the hob switches off after 1 hour.

If you wish to use this feature, you will need to alter the factory setting (see "Programming").

When Stop and Go is activated

- the countdown of a time programmed in for Automatic switch-off will be interrupted. When deactivated, the time will continue to run.
- the minute minder will continue without interruption.
- the recording of a Memory programme will be cancelled.

## To activate Stop and Go

- Touch the  sensor until you hear two consecutive beeps. Be careful not to continue touching the  sensor for too long, as this will activate the safety lock.

The indicator lamp for the safety lock will start to flash. The power of the cooking zones in use will be reduced to setting 1, and a 7 will appear in the corresponding cooking zone displays.

## To deactivate Stop and Go

- Touch the  sensor until the indicator lamp goes out.

The cooking zones will now run at the level that was previously set.

## Safety switch-off

Your hob is fitted with a safety switch-off feature in case you forget to switch it off yourself.

## Safety switch-off with an over-long cooking time

If one of the cooking zones is heated for an unusually long period of time (see chart), and the power settings are not altered, the hob will switch itself off automatically and the corresponding residual heat indicator will appear.

To use the cooking zone again, switch it back on in the usual way.

Power setting*	Maximum operating time in hours
h	2
1 / 1.	10
2 / 2.	5
3 / 3.	5
4 / 4.	4
5 / 5.	4
6	4
6.	3
7 / 7.	3
8 / 8.	3
9 / 9.	2
10 / 10.	2
11 / 11.	2
12	1

\* The continued cooking settings with a dot after the number are only available if the power level has been increased (see "Programming").

## Safety switch-off if the sensors are covered

Your hob will switch off automatically if one or several of the sensors remain covered for longer than 10 seconds, for example, by finger contact, food boiling over or by an object such as an oven glove or tea towel.

An audible tone will sound every 30 seconds (for a maximum of ten minutes) and an *F* will flash in the display for the sensor switch which is covered.



- Clean the control area or remove the obstruction.

This will turn off the tone and the *F* will go out.

- Switch the hob back on again with the ON/OFF sensor ①. The cooking zones can now be used again as normal.

# Safety features

---

## Overheating protection

All the induction coils and the cooling elements for the electronics are fitted with an overheating protection mechanism. To prevent the induction coils and cooling elements from overheating, the overheating protection mechanism works on the affected cooking zone or on the entire hob in the following ways:

- If the Booster function is being used, it will be switched off.
- If the power level has been set between **10** and **12** it will be reduced. The power level set and the reduced power level will alternate in the display. The reduced power level is also indicated by the number of lines in the light-ring.
- If an induction coil is affected, the relevant cooking zone switches itself off automatically. The display first shows a **U** and then the residual heat indicator.

The cooking zone can only be used again when the it has cooled down sufficiently.

- If the cooling element is affected, all of the cooking zones will switch off automatically and a **U** will alternate in the display with the power level set.

As soon as the cooling elements have cooled down sufficiently, the cooking zones will automatically continue to operate at the power setting previously selected.

Overheating can be caused by:

- Heating up an empty pan
- Fats or oils being heated up on the highest power setting.
- There being insufficient ventilation to the underside of the appliance.

If the overheating protection mechanism triggers again, contact the Service department.

A range of Miele branded cleaning products is available from Miele. See "Optional accessories" for details.

 Do not use a steam cleaning appliance to clean this appliance. The steam could reach the electrical components and cause a short circuit.

The appliance should be cleaned regularly, preferably after each use. Allow it to cool down to room temperature before cleaning. To avoid water marks and limescale deposits, use a soft cloth to dry surfaces that have been cleaned with water.

### **To avoid damaging the outer surfaces of your appliance, do not use:**

- cleaning agents containing soda, alkalines, ammonia, acids or chlorides,
- cleaning agents containing descaling agents,
- stain or rust removers,
- abrasive cleaning agents, e.g. powder cleaners and cream cleaners,
- solvent-based cleaning agents,
- dishwasher cleaner,
- grill and oven cleaners,
- glass cleaning agents,
- hard, abrasive brushes or sponges, e.g. pot scourers, brushes or sponges which have been previously used with abrasive cleaning agents,
- sharp, pointed objects which could damage the seal between the ceramic surface and the surrounding frame, and between the frame and the worktop.

# Cleaning and care

---

## Ceramic surface

Wipe all coarse soiling off using a damp cloth. Stubborn soiling may need to be removed with a shielded scraper blade.

Then clean the hob with a suitable proprietary ceramic and stainless steel hob cleaner (see "Optional accessories") applied with kitchen paper or a clean cloth. Do not apply cleaner whilst the hob is still hot, as this could result in marking. Please follow the manufacturer's instructions.

Finally, wipe the hob with a damp cloth, then polish with a soft, dry cloth. Ensure that all cleaner residues are removed. Residues can burn onto the appliance the next time it is used, and cause damage to the ceramic surface.

**Marks** caused by limescale, water and aluminium residues (shimmering, metallic appearance) can be removed using the ceramic and stainless steel hob cleaner.

Should any **sugar, plastic or aluminium foil** spill or fall onto a hot cooking zone while it is in use, first switch off the appliance. Then carefully scrape off all the sugar, plastic or aluminium residues from the hob whilst they are still hot, using a shielded scraper blade. Take care not to burn yourself.

Allow the appliance to cool down, and then clean as described above with a suitable proprietary ceramic and stainless steel hob cleaner.

You can change the default settings of the programme options (see chart).

- With the hob switched off, touch the hob ON/OFF sensor ① and the safety lock sensor  **at the same time** until the indicator lamp for the safety lock flashes.

A *P* (Programme) and an *S* (Status) will appear in the cooking zone display with a number which shows the current setting (see chart).

- First select the **programme** you want by touching the **+** or **-** sensor for the **front left** cooking zone, then select the required **status** by touching the **+** or **-** sensor for the **front right** cooking zone (see chart). You can alter several programmes one after the other in this manner.

To store the new settings in **memory**, touch the hob ON/OFF sensor ① until the displays go out.

If you **do not** wish to store the settings in memory, touch the safety lock sensor  until the displays go out.



# Programming

Programme*	Status**	Setting
<b>P 0</b> Demonstration mode and factory default settings	S 0	Demonstration mode on
	<b>S 1</b>	Demonstration mode off
	S 9	Factory default settings reinstated
<b>P 1</b> Stop and Go	<b>S 0</b>	Off
	S 1	On
<b>P 2</b> Power setting range	<b>S 0</b>	12 power settings (1, 2, 3 ... to 12)
	S 1	23 power settings (1, 1., 2, 2., 3 ... to 12) If the Auto heat-up setting is selected, an $\#$ will flash alternately with the continued cooking setting in the display.
<b>P 3</b> Induction warning tone when there is no pan or the pan is unsuitable	S 0	Off
	S 1	Quiet
	<b>S 2</b>	Medium
	S 3	Loud
<b>P 4</b> Keypad tone when a sensor is touched	S 0	Off
	S 1	Quiet
	<b>S 2</b>	Medium
	S 3	Loud
<b>P 5</b> Audible tone for the Timer	S 0	Off
	S 1	Quiet audible tone on for 10 seconds
	<b>S 2</b>	Medium pitched audible tone on for 10 seconds
	S 3	Loud audible tone on for 10 seconds

\* Programmes/Statuses not shown here have no allocation.

\*\* The factory default settings are shown in bold.



Programme*	Status**	Setting
<b>P 6</b> Lock	<b>S 0</b>	One-finger locking using 
	S 1	Three-finger locking using  and <b>+</b> on the two right-hand cooking zones
<b>P 7</b> System lock	<b>S 0</b>	Activating the system lock manually
	S 1	Activating the system lock automatically
<b>P 8</b> Auto heat-up	S 0	Off
	<b>S 1</b>	On
<b>P 10</b> Miele@home - only on communication-enabled appliances fitted with a communication module.	<b>S 0</b>	Feature not fitted
	S 1	Signed off
	S 2	Signed on
		Signing on / Signing off (indicator light)
<b>P 16</b> Sensor switch reaction speed	S 0	Slow
	<b>S 1</b>	Normal
	S 2	Rapid

\* Programmes not shown here have no allocation.

\*\* The factory default settings are shown in bold.

# Problem solving guide

---

Installation work and repairs to electrical appliances must only be carried out by a suitably qualified and competent person in strict accordance with current local and national safety regulations (BS 7671 in the UK). Repairs and other work by unqualified persons could be dangerous. The manufacturer cannot be held liable for unauthorised work. Ensure that current is not supplied to the appliance until after maintenance or repair work has been carried out.

## What to do if...

### ... the hob or cooking zones cannot be switched on

Check whether

- the pans being used are suitable.
- the safety lock is activated.  
If necessary, deactivate it (see "Safety lock").
- the mains fuse has tripped.

If none of the above is the case, then disconnect the appliance from the electricity supply for approx. 1 minute. To do this:

- switch off at the wall socket, or switch off at the isolator, or
- disconnect the mains fuse.

Reset the trip switch in the mains fuse box, and switch the appliance back on. If it still will not switch on, contact a qualified electrician or the Miele Service Department.

### ... there is a strange smell or vapours when a new appliance is being used.

The smell and any vapours given off do not indicate a faulty connection or appliance, and neither are they hazardous to health.

### ... the hob can be switched on and settings selected, but the cooking zones do not heat up

Check whether you set the demo-mode setting by mistake (see "Programming - P0").

### ... $\cup$ appears in the display for a cooking zone.

Check whether

- the zone was switched on by mistake without a pan on it.
- the pan being used is suitable for use on an induction zone, and that it is large enough (see "Pans").

### ... an individual cooking zone or the whole hob has switched itself off automatically

The safety switch-off feature or the overheating protection mechanism has been triggered (see "Safety switch-off" and "Overheating protection").

### **... one of the following has occurred:**

- The Booster has deactivated early automatically.
- The set power level *10*, *11* or *12* is alternating in the display with a lower power level. The reduced power level is also indicated by the number of lines in the light-ring.

The overheating protection mechanism has been triggered (see "Overheating protection").

### **... the food in the pan hardly heats up or does not heat up at all when the Auto heat-up function is switched on**

This could be because:

- there is too much food in the pan.
- the pan not conducting heat properly.

Select a higher continued cooking setting next time, or start cooking at the highest setting and then turn down to a lower setting manually later on.

### **... The cooling fan continues to run after the appliance has been switched off.**

This is not a fault. The fan will continue running until the appliance has cooled down. It will then switch itself off automatically.

### **... numbers light up in the Timer display, and *R*, *F* and numbers light up in the cooking zone display, when the hob is switched off.**

The sensitivity level of the sensors has altered and they are unable to recalibrate automatically. The sensors must be recalibrated manually (see "Calibrating the sensor switches").

If this does not solve the problem, please call the Miele Service department.

### **... an *F* appears in the display for the left hand cooking zones, an *E* appears in the display for the right hand cooking zones and numbers appear in the timer display.**

Interrupt the power supply to the hob for approx. 1 minute.

If the problem persists after reconnecting the appliance to the power supply, please contact the Miele Service department.

## Optional accessories

---

Miele appliances are designed to give the best possible results and many years of satisfaction. To help you get the most from your appliance, Miele has put together a comprehensive range of accessories and cleaning products.

These can be ordered via the internet at:



or from Miele (see back cover for contact details).

## Miele@home system

Miele@home enabled appliances use the existing household power supply (Powerline technology) to transfer data to the Miele@home master appliance (SuperVision appliance, or InfoControl unit). You can use the master appliance to call up information about Miele@home appliances, such as the operational status or fault messages at any time.

The Miele@ system allows certain hobs to be linked to certain cooker hoods (**Con@ctivity**).

The cooker hood responds automatically to the hob setting, controlling the power level and lighting accordingly.

To enjoy the benefits of this feature, your appliance will have to be fitted with a communication module.

## XKM 2100 KM

Communication module, including building-in kit

## InfoControl

Master appliance with base station and mobile receiver.

## Safety instructions for installation

---

The appliance must only be installed and connected to the electricity supply by a suitably qualified and competent person in strict accordance with current national and local safety regulations (BS 7671 in the UK).

Fit the wall units and extractor hood before fitting the hob to avoid damaging the appliance.

- ▶ The veneer or laminate coatings of worktops (or adjacent kitchen units) must be treated with 100 °C heat-resistant adhesive which will not dissolve or distort. Any backmoulds must be of heat-resistant material.
- ▶ This equipment may only be used in mobile installations such as ships, if a risk assessment has been carried out by a suitably qualified engineer.
- ▶ The hob may not be built in over a fridge, fridge freezer, freezer, dishwasher, washing machine or tumble dryer.
- ▶ This hob must not be installed above an oven or cooker unless this has built-in cooling down fan.

- ▶ After installing the hob, ensure that the connection cable cannot come into contact with the underside of the appliance. Make sure that there is no mechanical obstruction, such as a drawer, which could damage it.
- ▶ Observe carefully the safety distances given on the following pages.

All dimensions in this instruction booklet are given in mm.

# Safety instructions for installation

---

## Safety distance above the appliance

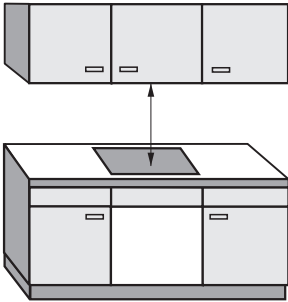

When two or more appliances are installed together below a cooker hood, e.g. a gas wok and a ceramic hob, which have different safety distances given in the installation instructions, you should select the greater distance of the two.

A minimum safety distance must be maintained between the appliance and the cooker hood above it. See the cooker hood manufacturer's operating and installation instructions for details.

If the manufacturer's instructions are not available for the cooker hood, a minimum safety distance of at least 760 mm must be maintained. For any flammable objects, e.g. utensil rails, wall units etc. a minimum distance of at least 760 mm must be maintained between them and the appliance below.

# Safety instructions for installation

## Safety distances to the sides and back of the hob

Ideally the hob should be installed with plenty of space on either side. There may be a wall at the rear and a tall unit or wall at one side. On the other side, however, no unit or divider should stand higher than the hob (see illustrations).

The following minimum distances should be adhered to for safety reasons:

- 50 mm to the right or left of the worktop cut-out to the nearest piece of furniture (e.g. tall unit).
- 50 mm from the worktop cut-out to the rear wall.

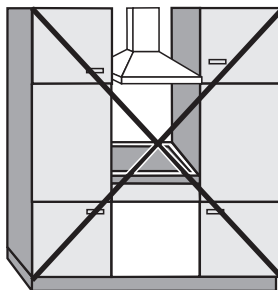

Not allowed

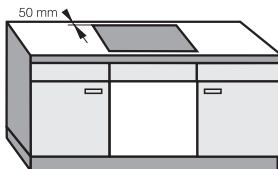
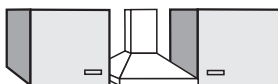

Recommended

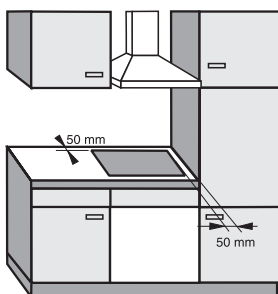

Not recommended

# Safety instructions for installation

---

## Safety distances underneath the hob

To ensure sufficient ventilation to the hob, a certain gap must be left between the underside of the hob and any oven, interim shelf or drawer.

The minimum gap between the underside of the hob and

- the top of an **oven** is **15 mm**.
- the top of an **interim shelf** is **15 mm**.  
A space of at least 10 mm must also be left at the back to accommodate the cable.
- the base of a **drawer** must be **75 mm**.



# Safety instructions for installation

## Safety distance when installing the appliance near a wall with additional niche cladding

A minimum safety distance must be maintained between the worktop cut-out and any niche cladding to protect it from heat damage.

If the niche cladding is made from a **combustible material** (e. g. wood) a minimum safety distance ⑤ of 50 mm must be maintained between the cut-out and the cladding.

If the niche cladding is made from a **non-combustible material** (e. g. metal, natural stone, ceramic tiles) a minimum safety distance ⑤ of 50 mm less the thickness of the cladding must be maintained between the cut-out and the cladding.

Example: 15 mm niche cladding

$50 \text{ mm} - 15 \text{ mm} =$  minimum safety distance of 35 mm

### Flush-fitted hobs

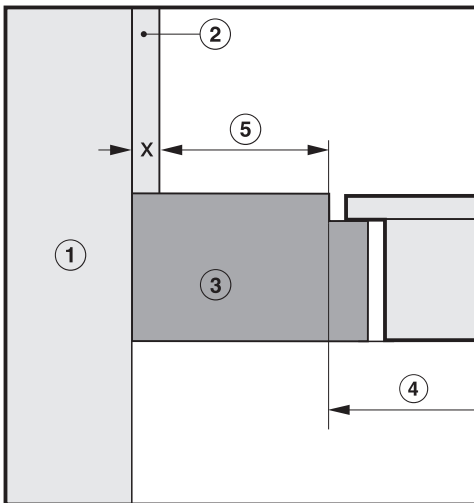

### Hob with frame or bevelled edges

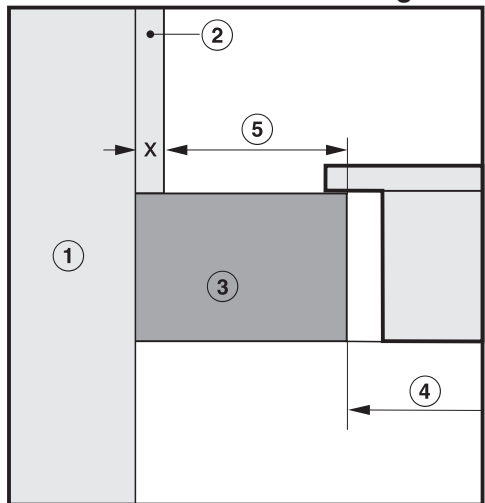

① Masonry

② Niche cladding

Dimension x = thickness of niche cladding material

③ Worktop

④ Worktop cut-out

⑤ Minimum safety distance

for **combustible** materials is 50 mm

for **non-combustible** materials is 50 mm less dimension x

# Hob with frame or bevelled edge

## Building-in dimensions

KM 5993

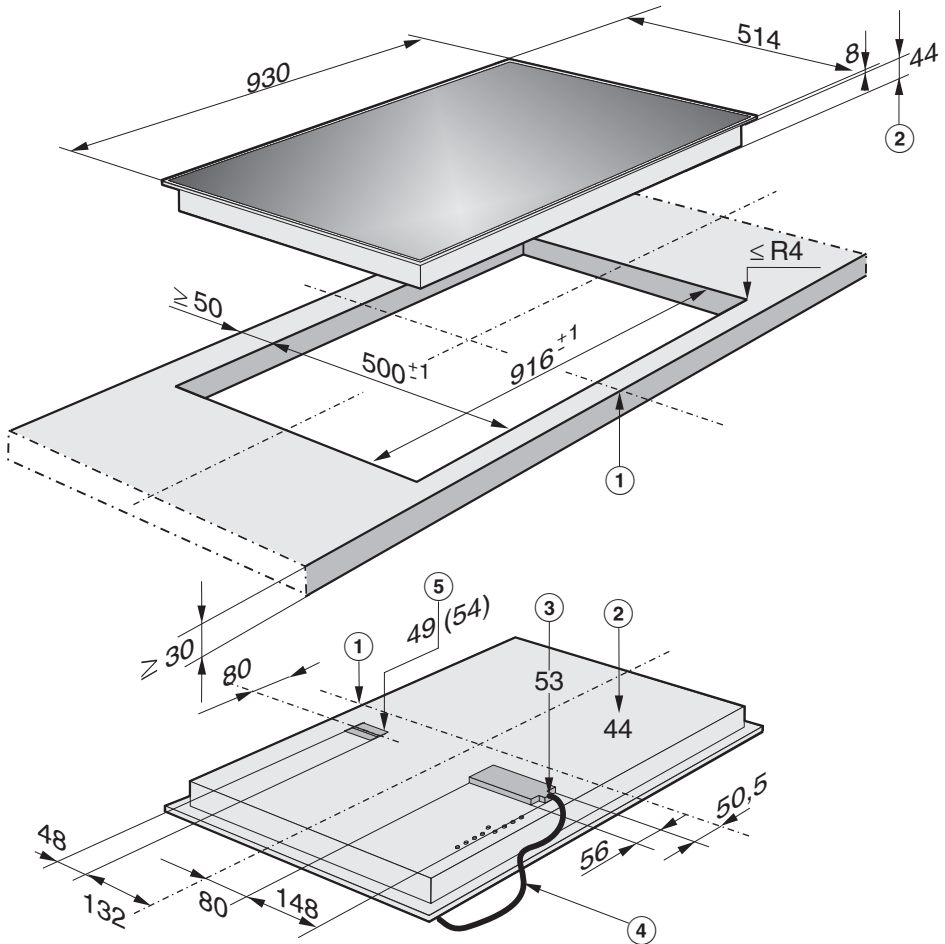

- ① Front
- ② Building-in depth
- ③ Building-in depth, including mains connection cable
- ④ Mains connection cable, L = 1440 mm
- ⑤ Connection for Miele@home  
(Building in depth including Miele@home connection cable = 54 mm)

# Hob with frame or bevelled edge

## Installation

### Preparing the worktop

- Make the worktop cut-out according to the dimensions given in the building-in diagram. Remember to maintain the **minimum safety distances** (see "Safety instructions for installation").
- Seal the cut surfaces on wood/laminated worktops with a suitable heat-resistant sealant to avoid swelling caused by moisture.

Make sure that the sealant does not come into contact with the top of the worktop.

These hobs have a seal underneath them to keep the hob securely in position. Clamps are not required. Any gap between the frame and worktop will reduce with time.

### Installing the hob

- Feed the hob connection cable down through the cut-out.
- Place the hob centrally in the cut-out. When doing this make sure that the seal under the hob sits flush with the worktop on all sides. This is important to ensure an effective seal all round. Do not use sealant (e.g. silicone).

If the corners of the frame are not flush with the worktop surface, the corner radius ( $\leq R4$ ) can be carefully scribed to fit.

- Connect the hob to the mains.
- Check that the hob works.

# Hob with frame or bevelled edge

## General installation tips

### Sealant

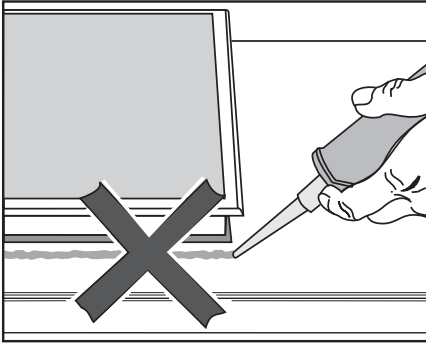

Do not use any sealant unless expressly instructed to do so. The sealing strip under the edge of the top part of the appliance provides a sufficient seal for the worktop.

Do not use sealant between the frame of the top part of the appliance and the worktop. This could cause difficulties if the appliance ever needs to be taken out for servicing and possibly result in damage to the frame or the worktop.

### Tiled worktop

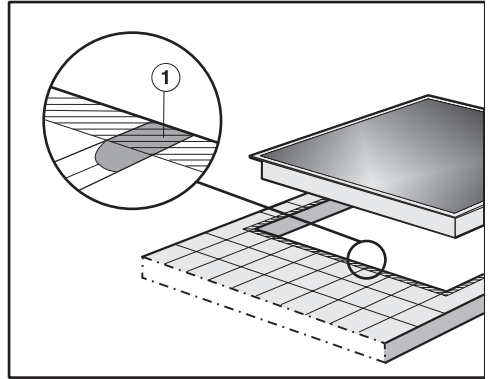

Grout lines ① and the hatched area underneath the hob frame must be smooth and even. If they are not, the hob will not sit flush with the worktop and the sealing strip underneath the hob will not provide a good seal between the hob and the worktop.

## Building-in dimensions

KM 5987

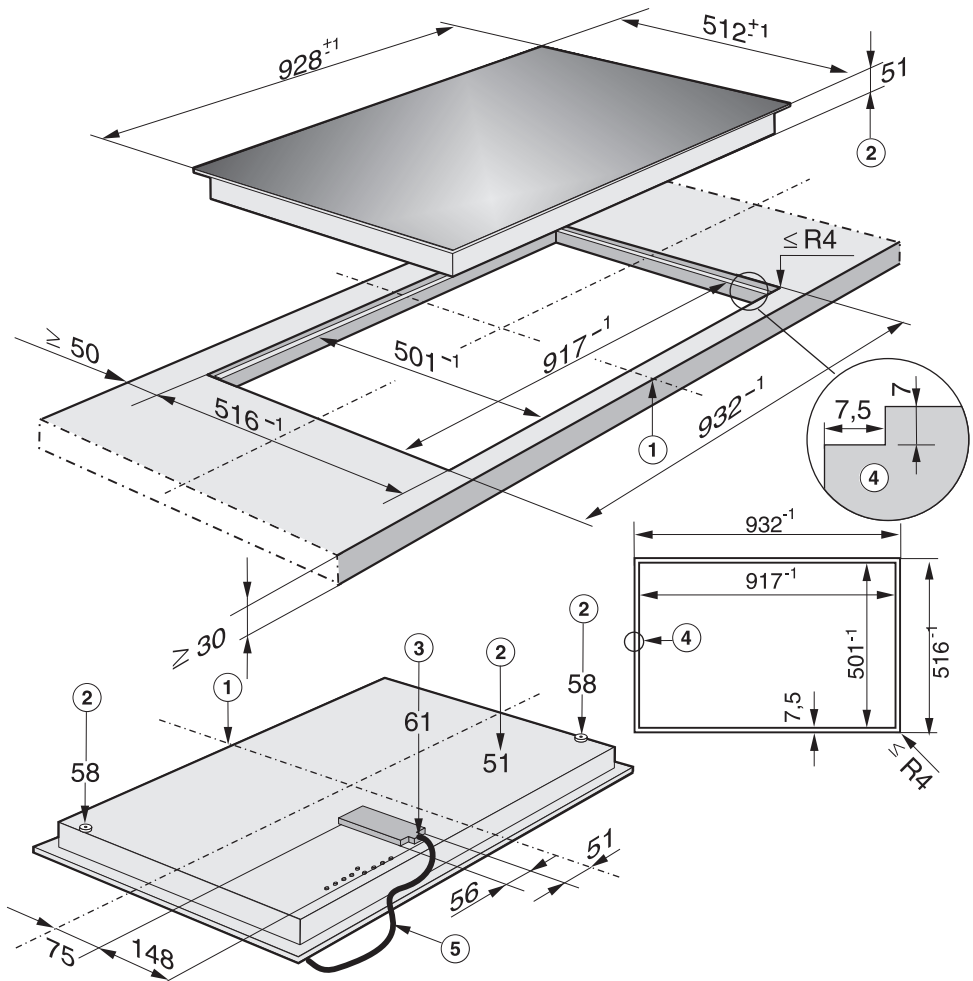

- ① Front
- ② Building-in depth
- ③ Building-in depth, including mains connection cable
- ④ Stepped cut-out for granite or marble worktops
- ⑤ Mains connection cable,  $L = 1440$  mm

**Cut-out dimensions for granite or marble worktops.**  
**Please take careful note of the inset diagram.**

# Flush-fitted hobs

KM 5997

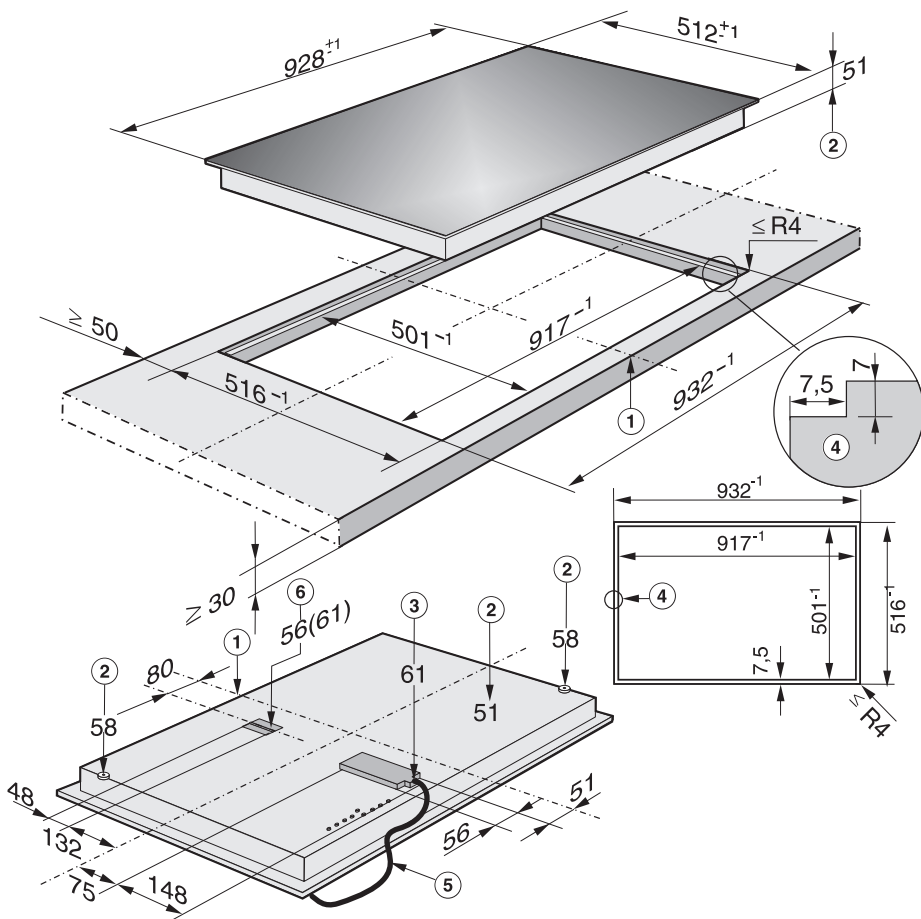

- ① Front
- ② Building-in depth
- ③ Building-in depth, including mains connection cable
- ④ Stepped cut-out for granite or marble worktops
- ⑤ Mains connection cable, L = 1440 mm
- ⑥ Connection for Miele@home (Building-in depth, including Miele@home connection cable = 61 mm)

**Cut-out dimensions for granite or marble worktops.**  
**Please take careful note of the inset diagram.**

## Installation

Flush fit hobs are only suitable for installation in granite, marble, tiled or solid wood worktops. Other materials such as Corian and Askilan are not suitable. When using a worktop made from any other material, please check first with the worktop manufacturer that it is suitable for installing a flush fit hob. Certain models are suitable for building into glass worktops - please see advice under "Building-in dimensions".

This appliance requires a 1000 mm wide base unit for installation. This is to ensure that the underside of the hob is accessible after installation and that the casing can be easily removed for maintenance. If the underside of the hob is not freely accessible after installation the seal underneath the hob must be removed to enable the hob to be lifted out of the cut-out should this ever be necessary.

The hob can be installed

- in a suitable cut-out in a granite or marble worktop.
- in a suitable cut-out in a tiled or solid wood worktop with a wooden support frame. The frame must be provided on site, and is not supplied with the appliance.

# Flush-fitted hobs

## Making the worktop cut-out and building in the hob

### Granite and marble worktops

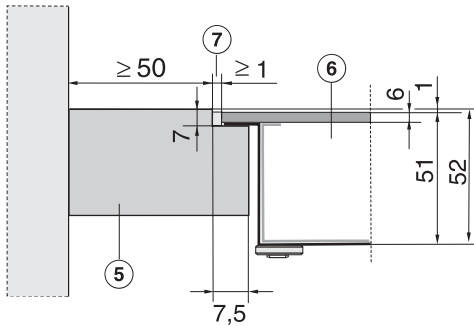

⑤ Worktop

⑥ Hob

⑦ Gap

- Make the worktop cut-out as shown in "Building-in dimensions".
- Feed the hob connection cable down through the cut-out.
- Centre the hob ⑥ in the cut-out.
- Connect the hob to the mains.
- Check that the hob works.
- Seal the remaining gap ⑦ with a silicone sealant that is heat-resistant to at least 160 °C.

For granite and marble worktops, only use silicone sealant that is especially formulated for granite and marble, and observe the sealant manufacturer's instructions.

As the ceramic glass and the worktop cut-out have a certain dimensional tolerance, gap ⑦ can vary (min. 1 mm).



## Solid wood and tiled worktops

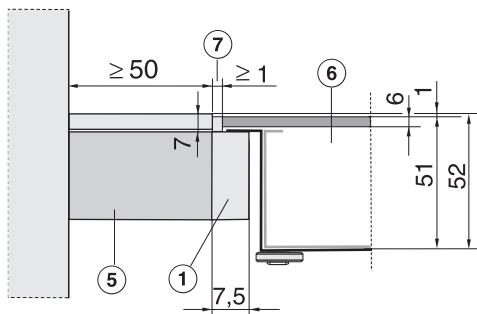

① Wooden frame 7,5 mm  
(to be provided on site)

⑤ Worktop

⑥ Hob

⑦ Gap

As the ceramic glass and the worktop cut-out have a certain dimensional tolerance, gap ⑦ can vary (min. 1 mm).

- Make the worktop cut-out as shown in "Building-in dimensions".
- Fix the wooden frame ① 7 mm below the top edge of the worktop (see diagram).
- Feed the hob connection cable down through the cut-out.
- Centre the hob ⑥ in the cut-out.
- Connect the hob to the mains.
- Check that the hob works.
- Seal the remaining gap ⑦ with a silicone sealant that is heat-resistant to at least 160 °C.

Observe the silicone sealant manufacturer's instructions.

For **granite and marble tiled worktops**, only use silicone sealant that has been especially formulated for granite and marble.

## Electrical connection

---

All electrical work should be carried out by a suitably qualified and competent person, in strict accordance with current local and national safety regulations (BS 7671 in the UK).

Installation, repairs and other work by unqualified persons could be dangerous. The manufacturer cannot be held liable for unauthorised work.

A damaged cable must be replaced by a suitably qualified electrician with a special connection cable of type H 05 VV-F, available from Miele.

Ensure power is not supplied to the appliance until after installation or repair work has been carried out.

The appliance must only be operated when built-in. This is to ensure that all electrical parts are shielded. Live parts must not be exposed.

Do not connect the appliance to the mains electricity supply by an extension lead. These do not guarantee the required safety of the appliance.

Connection should be made via a suitable isolator which complies with national and local safety regulations, and the On/Off switch should be easily accessible after the appliance has been built in.

If the switch is not accessible after installation (depending on country) an additional means of disconnection must be provided for all poles.

For extra safety it is advisable to protect the appliance with a residual current device (RCD). Please contact a qualified electrician for advice.

When switched off there must be an all-pole contact gap of at least 3 mm in the isolator switch (including switch, fuses and relays).

### Important U.K.

The appliance is supplied for connection to a 230-240 V, 50 Hz supply with a 3-core cable.

The wires in the mains lead are coloured in accordance with the following code:

Green/yellow = earth

Blue = neutral

Brown = live

**WARNING**  
**THIS APPLIANCE MUST BE**  
**EARTHED**

Please make sure that the connection data quoted on the data plate match the household mains supply.

The electrical safety of this appliance can only be guaranteed when continuity is complete between it and an effective earthing system, which complies with current local and national safety regulations. It is most important that this basic safety requirement is present and regularly tested and where there is any doubt, the electrical wiring in the home should be inspected by a qualified electrician. The manufacturer cannot be held liable for the consequences of an inadequate earthing system such as an electric shock.

The manufacturer cannot be held liable for damage which is the direct or indirect result of incorrect installation or connection.

# Electrical connection

## Wiring diagram

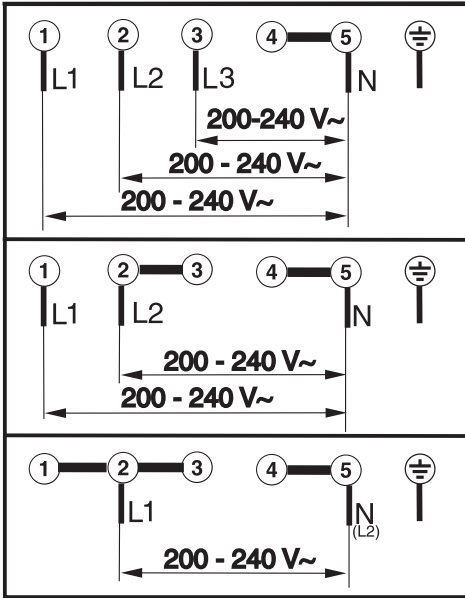

**N.B. This appliance is supplied single phase only in the U.K. / AUS / NZ**

## After sales service, data plate

---

In the event of any faults which you cannot remedy yourself, or if the appliance is under guarantee, please contact:

- Your Miele dealer, or
- the Miele Service Department (see back cover for address).

Please note that telephone calls may be monitored and recorded to improve our service.

When contacting Miele, please quote the model and serial number of your appliance. These are given on the data plate.

N.B. A call-out charge will be applied for service visits where the problem could have been resolved as described in these instructions.

Space in which to stick the extra data plate supplied with the appliance. Ensure that the model number is the same as the one on the front of these instructions.

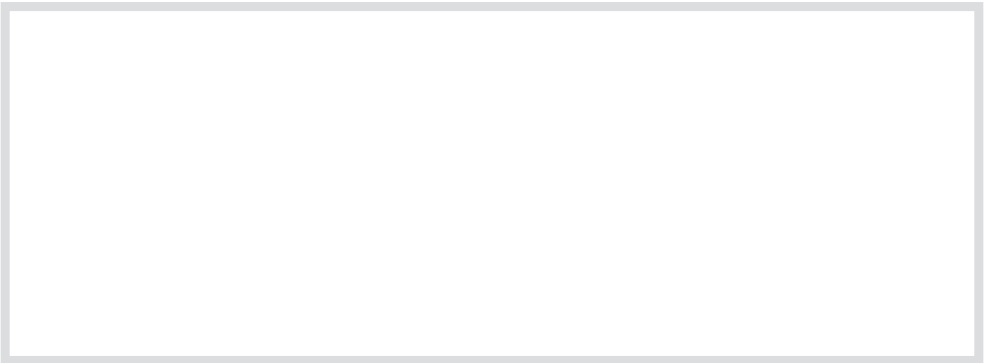





## United Kingdom

Miele Co. Ltd.  
Fairacres, Marcham Road  
Abingdon, Oxon, OX14 1TW  
Tel: 0845 365 0555  
Fax: 0845 365 0777  
Customer Contact Centre Tel: 0845 365 6600  
E-mail: [info@miele.co.uk](mailto:info@miele.co.uk)  
Internet: [www.miele.co.uk](http://www.miele.co.uk)

## Australia

Miele Australia Pty. Ltd.  
ABN 96 005 635 398  
1 Gilbert Park Drive, Knoxfield, VIC 3180  
Tel: (03) 9764 7130, Fax: (03) 9764 7149  
Internet: [www.miele.com.au](http://www.miele.com.au)

## China

Miele Shanghai  
Suite 4105-06, Plaza 66  
1266 Nanjing Road West  
Jing An District  
Shanghai 200040, PRC  
Tel: +86 21 6288 4200, Fax: +86 21 6288 4100  
E-mail: [mieleshanghai@cn.miele.com](mailto:mieleshanghai@cn.miele.com)  
Internet: [www.miele.cn](http://www.miele.cn)

## Miele (Hong Kong) Limited

41/F - 4101, Manhattan Place  
23 Wang Tai Road  
Kowloon Bay  
Hong Kong  
Tel: (852) 2610 1331  
Fax: (852) 2610 1013  
Email: [mielehk@miele.com.hk](mailto:mielehk@miele.com.hk)

## India

Miele Appliances India Pvt. Ltd.  
Ground Floor, Copia Corporate Suites  
Plot No. 9, Jasola  
New Delhi - 110025  
Tel: 011-46 900 000, Fax: 011-46 900 001  
E-mail: [customercare@miele.in](mailto:customercare@miele.in)  
Internet: [www.miele.in](http://www.miele.in)

**Germany** - Miele & Cie. KG  
Carl-Miele-Straße 29, 33332 Gütersloh



## Ireland

Miele Ireland Ltd.  
2024 Bianconi Avenue  
Citywest Business Campus, Dublin 24  
Tel: (01) 461 07 10, Fax: (01) 461 07 97  
E-Mail: [info@miele.ie](mailto:info@miele.ie), Internet: [www.miele.ie](http://www.miele.ie)

## New Zealand

Miele New Zealand Limited  
Unit L, 10-20 Sylvia Park Road  
Mt. Wellington, 1060, Auckland, NZ  
Tel: 0800 264 353, Fax: 0800 463 453  
Internet: [www.miele.co.nz](http://www.miele.co.nz)

## Singapore

Miele Southeast Asia  
Miele Pte. Ltd.  
163 Penang Road  
# 04 - 02/03 Winsland House II  
Singapore 238463  
Tel: +65 6735 1191, Fax: +65 6735 1161  
E-Mail: [infosea@miele.com.sg](mailto:infosea@miele.com.sg)  
Internet: [www.miele.sg](http://www.miele.sg)

## South Africa

Miele (Pty) Ltd  
63 Peter Place, Bryanston 2194  
P.O. Box 69434, Bryanston 2021  
Tel: +27 (0) 11 548-1900  
Fax: +27 (0) 11 548-1935  
E-mail: [info@miele.co.za](mailto:info@miele.co.za)  
Internet: [www.miele.co.za](http://www.miele.co.za)

## United Arab Emirates

Miele Appliances Ltd.  
P.O. Box 11 47 82  
Gold & Diamond Park  
Sheikh Zayed Road  
Building 6 / Offices Nos. 6-214 to 6-220  
Dubai  
Tel: +971-4-341 84 44  
Fax: +971-4-341 88 52  
E-Mail: [info@miele.ae](mailto:info@miele.ae)  
Internet: [www.miele.ae](http://www.miele.ae)





## Free Manuals Download Website

<http://myh66.com>

<http://usermanuals.us>

<http://www.somanuals.com>

<http://www.4manuals.cc>

<http://www.manual-lib.com>

<http://www.404manual.com>

<http://www.luxmanual.com>

<http://aubethermostatmanual.com>

Golf course search by state

<http://golfingnear.com>

Email search by domain

<http://emailbydomain.com>

Auto manuals search

<http://auto.somanuals.com>

TV manuals search

<http://tv.somanuals.com>