

Miele

NOVOTRONIC SUPER

Operating instructions for Washing machine W 937 WPS



It is **essential** to read these operating instructions before installing or using the machine, to avoid the risk of accident, or damage to the machine.



M.-Nr. 04 610 490

Contents

Guide to the machine	3
Warning and Safety Instructions	5

Preparation for use

Help to protect our environment	8
Installation	36
Plumbing	42
Electrical connection	46

Operation

Washing environmentally and economically	9
How to wash correctly	10
To change a programme	14
Adding or removing washing after programme start	15
Adding detergent	16
Fabric conditioners/starch formulations	17
Programme selection	18
Programme sequence	20
Care symbols	22
Additional options	23
Delay start/time left display	24

Maintenance

Cleaning and care	25
Problem solving guide	29
After sales service	35

Programmable functions

Programmable functions	47
----------------------------------	----

Consumption data	49
-----------------------------------	----

Technical Data	50
---------------------------------	----

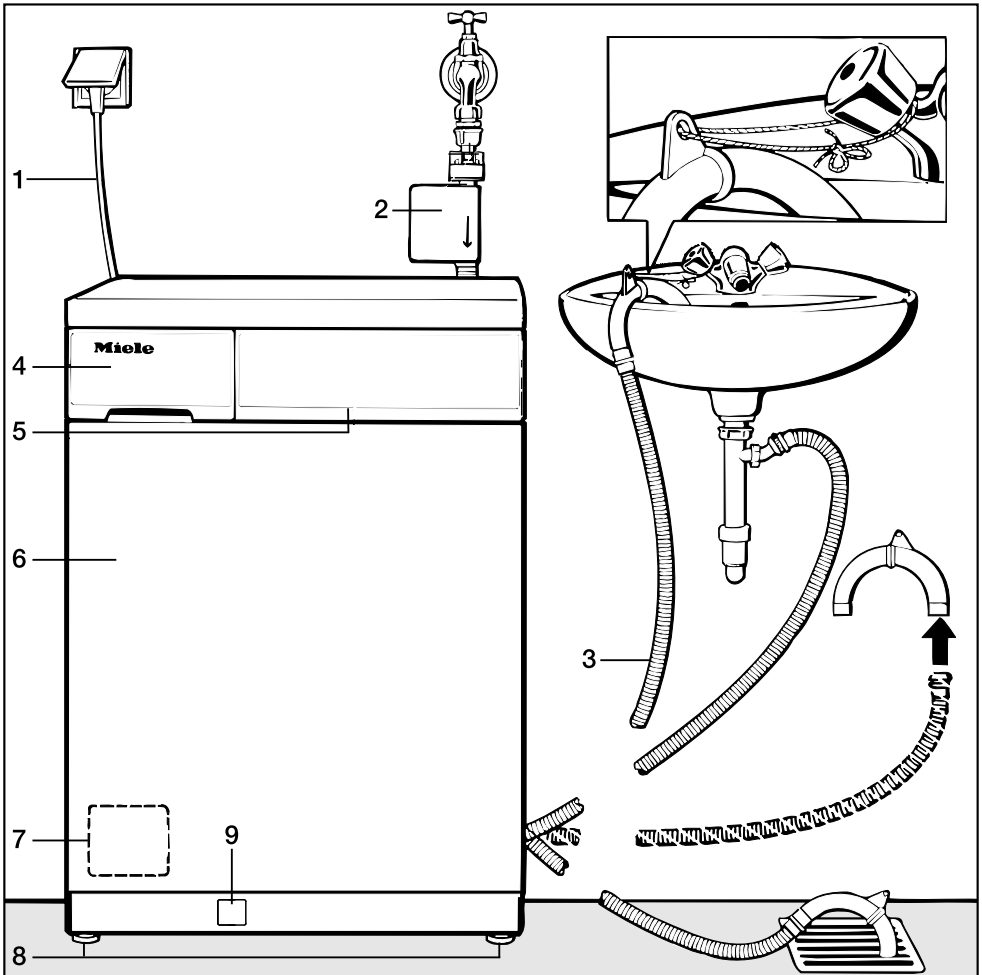

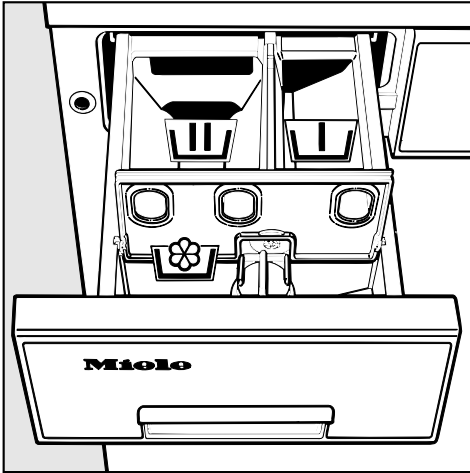

- | | |
|--|--|
| 1 Electric supply cable | 6 Drum door |
| 2 Inlet hose with "Waterproof" system | 7 Access panel for drain pump and filter |
| 3 Flexible drain hose (with detachable swivel elbow) | 8 Four height adjustable feet |
| 4 Detergent dispenser drawer | 9 Access panel for emergency door release and emptying |
| 5 Facia panel with controls | |

Guide to the machine



Detergent dispenser drawer

- Compartment  Pre-wash
- Compartment  main wash
- Compartment  (with extra lid)
for fabric conditioner or
liquid starch formulation

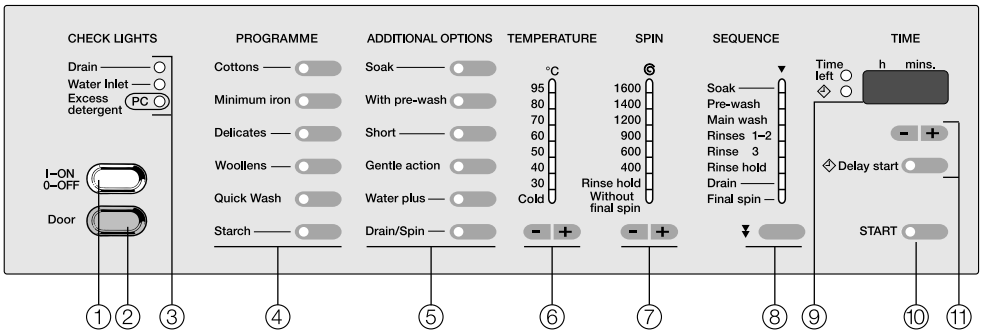

① "I-On/O-Off" button

② "Door" button

③ CHECK LIGHTS

④ Touch pads for PROGRAMMES

⑤ Touch pads for ADDITIONAL OPTIONS

⑥ TEMPERATURE DISPLAY and "−" and "+" touch pads.

⑦ SPIN SPEED display with "−" and "+" touch pads

⑧ PROGRAMME SEQUENCE display with "▼" touch pad.

⑨ "TIME" display

⑩ "START" touch pad

⑪ Delay start  touch pad with "−" and "+" touch pads

Read the operating instructions before using this machine for the first time. They contain important information about the safety, use and maintenance of the machine. This will avoid the risk of accidents and damage to the machine.

Keep these operating instructions in a safe place and ensure that new users are familiar with the content. Pass them on to any future owner of the machine.

Correct usage

Only use the washing machine to wash items which are declared by the manufacturer to be machine-washable on the wash-care label.

Any other applications may be dangerous. The manufacturer is not liable for damage resulting from improper use or operation.

This appliance should not be operated by children. Supervise its use by the elderly or infirm.

Technical safety

Before setting up the machine, check it for any externally visible damage.

Before connecting the machine, ensure that the connection data on the data plate (fusing, voltage and frequency) matches the mains electricity supply. If in any doubt, consult a qualified electrician.

The electrical safety of this machine can only be guaranteed when continuity is complete between the machine and an effective earthing system which complies with local and national regulations. It is most important that this basic safety requirement is regularly tested by a qualified electrician.

The manufacturer cannot be held responsible for the consequences of an inadequate earthing system.

For safety reasons do not operate this appliance on an extension cable. Danger of overheating.

The machine is built in accordance with current safety requirements. Unauthorised repairs could result in unforeseen dangers for the user, for which the manufacturer cannot accept responsibility. Repairs should only be undertaken by a Miele approved engineer.

The machine is only completely isolated from the electricity supply when:

- it is switched off at the wall socket and the plug is withdrawn, or
- it is switched off at the mains, or
- the mains fuse is withdrawn.

Warning and Safety Instructions

■ The Miele "Waterproof system" protects from water damage provided the following conditions have been met:

- the machine is correctly plumbed in and connected to the electricity supply.
- if a fault has been identified, the machine must be examined by a competent person before further use and repaired if necessary.

■ Faulty components must only be exchanged for Miele original spare parts. Only when these parts are fitted can the safety standards of the machine be guaranteed.

■ If the connection cable is damaged it must be replaced by a special Miele cable.

Use

■ Do not install your washing machine in rooms where temperatures below freezing may occur. Frozen hoses may burst under pressure. The reliability of the electronic control system may be impaired at temperatures below freezing point.

■ In countries where there are areas which may be subject to infestation by cockroaches or other vermin, pay particular attention to keeping the appliance and its surroundings in a clean condition at all times. Any damage which may be caused by cockroaches or other vermin will not be covered by the appliance guarantee.

■ Before using the machine for the first time, check that the transit fitting at the rear of the machine has been removed (see section on "Installation"). During spinning, a transit fitting which is still in place may result in damage to both the machine and adjacent furniture or appliances.

■ Turn off the stopcock if the machine will be left for any length of time (e.g. holiday), especially if there is no floor drain (gully) in the immediate vicinity.

■ **Flooding danger.**
If hooking the drain hose into a wash basin, check that the water can drain off quickly enough to prevent the sink from overflowing. Make sure the drain hose is secure, so that the force of the water flowing out of the hose does not dislodge it. Otherwise this will result in flooding.

■ Take care to ensure that foreign objects (e.g. nails, needles, coins, paper clips, etc.) do not find their way into the machine with the washing (e.g. in pockets). Foreign objects can damage components of the machine, which in turn can result in damage to the washing.

Warning and Safety Instructions

■ If the correct amount of detergent is dispensed, the machine should not need to be descaled. If, however, you do wish to descale the machine only use proprietary non-corrosive descaling agents and strictly observe the instructions. Consult the Miele Customer Service Department.

■ Textiles which have been pre-treated in solvent based cleaning agents must be thoroughly rinsed in clean water before being washed in the machine.

■ Never use solvent based cleaning agents in this machine, as this may result in damage to component parts and create toxic fumes. Such detergents also pose a fire and explosion hazard.

■ Only use dyes specified by the manufacturer as being suitable for use in a washing machine. Always observe the manufacturer's instructions carefully.

■ Dye removers may contain sulphur compounds which cause damage such as corrosion to the machines. Do not use dye removers in this machine.

■ For machines with a 'porthole' door, remember that the porthole glass will be hot when washing at very high temperatures. Do not let children touch it during a hot wash programme.

■ Always make sure the drum is stationary before reaching in to remove washing. Reaching into a moving drum is extremely dangerous.

■ This machine is intended for domestic use, and the guarantee is on this understanding. If the machine is used in a commercial environment, the user is responsible for ensuring conformity to all relevant regulations.

Accessories

■ Accessory parts may only be fitted when expressly approved by Miele. If other parts are used, guarantee, performance and product liability claims may be invalidated.

Disposal of your old machine

■ Before discarding an old machine unplug it. Render the plug useless. Cut off the cable directly behind the appliance to prevent misuse.

Help to protect our environment

Disposal of the packing material

The transport and protective packing is mostly manufactured from the following recycled or re-useable materials:

- corrugated paper/card
- polystyrene - CFC-free
- untreated surplus wood
- chipboard, contains no phenolic resins
- polyethylene foil (PE)
- packaging straps: polypropylene (PP)

Rather than just throwing these materials away, please take them to the nearest local authority collection point for specific waste.

Disposal of your old machine

Old machines may contain material which can be reclaimed or recycled. Please contact your dealer, your local waste collection centre or scrap merchant about potential recycling schemes.

Ensure that the machine presents no danger to children while being stored for disposal.

See the appropriate section in the Warning and Safety instructions.

Washing environmentally and economically

Caring for the environment means saving water, energy and detergent when washing but without compromising on results.

The key to a good wash result is finding the best combination of amount of detergent, temperature, length of programme and the machine's technology.

If necessary, some programmes take longer to achieve this effect. With the "Hydromatic" system, the drum can revolve at different speeds. Longer and slower action together with pauses for steeping, work towards a good result.

The automatic load control facility ensures the correct water level for the type of fabric and laundry load being washed. Sometimes it even appears that there is no water in the drum.

Normally, main wash is sufficient for a clean result, so a pre-wash is not automatically included in the programmes. If it is wanted, a simple press on the pre-wash selector includes it.

Economy tips

To help you wash most economically, remember the following tips:

- The automatic load control facility allows you to wash individual loads of between 1 and 5 kg. Ideally wash with the maximum load specified for each programme. This uses the energy to the best advantage.
- Only use the correct amount of detergent required for the water hardness level in your area, according to the detergent manufacturer's recommendations.
- If washing is not heavily stained, select a lower temperature setting than indicated on the wash care label but do not additionally select "Short".
- Use the "Short wash" option for washing that is only very lightly soiled, but do not additionally reduce the temperature.
- Using the additional "Soak" option allows you to reduce the temperature used in the main wash.

How to wash correctly

The headings numbered (1, 2, 3,...) show the operating sequence and can be used as a brief guide.

Before washing

1 Prepare the wash load

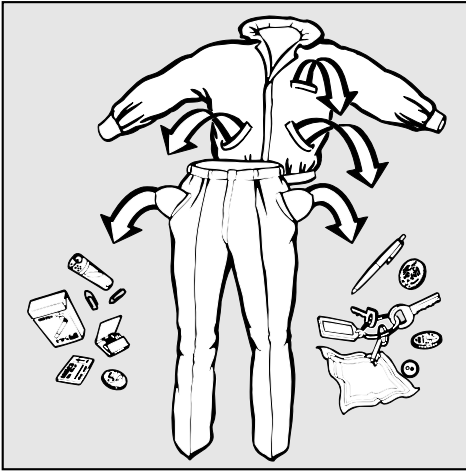

- Empty all pockets.

Foreign objects (e.g. nails, coins, paper clips etc) can cause damage to textiles and components in the machine.

- Sort the washing

Most garments have a textile care label in the collar or side seam. Sort the washing by care label symbols. (See the Section on these symbols for their explanation).

Only wash items in this machine which are declared by the manufacturer as being machine washable on the textile care label.

Dark textiles often contain excess dye and should be washed separately several times before being included in a mixed load.

Delicate textiles should be washed separately in a delicates programme.

Any loose wiring in bras etc., should be removed or sewn in.

Only wash textiles made from wool or wool mixtures if the textile care label states that they are suitable for machine washing.

- Pre-treating the washing

Badly soiled areas, e.g. collars and cuffs, and water soluble stains can be pre-treated with bar soap, liquid detergent or detergent mixed into a solution or paste.

With particularly stubborn stains ask your Dry Cleaner for advice.

Do not use solvent based cleaning agents in this machine.

- 2 **Open the door by pressing on the "Door" button.**

3 Load the drum.

Unfold washing and load loosely in the drum. To achieve best results it is advisable to make up mixed loads consisting of both large and small items.

This improves the washing effect and helps distribute the load evenly to keep the machine stable and reduce the noise level during spinning.

Overloading reduces the wash result and causes more creasing.

Maximum load weights are noted below:

COTTONS 5.0 kg

MINIMUM IRON 2.5 kg

DELICATES/SYNTHETICS 1.0 kg

WOOL 1.0 kg

QUICK WASH 2.5 kg

Curtains:

Remove lead weights and strips or place in a laundry bag.

Any loose wiring in bras etc., should be removed or swen in.

Woollens, knitted garments and jeans:

Turn inside out, if the manufacturer recommends it.

3 Close the drum door.

Make sure that there is no obstruction between the drum door and seal.

4 Open the stopcock.

5 Add detergent.

See Section on Detergent for details.

To start a programme

1 Press the I-ON/0-OFF button.

2 Select the required basic programme.

See page 13 for details of the Memory function.

3 Select an additional option if required.

For a delayed start, see Section on the "Delay start" and "time left display" for details.

4 Select the temperature by pressing the "C" or "D" touch pad beneath the temperature display.

5 Select the spin speed by pressing the "C" or "D" touch pad beneath the spin display.

6 Press the START button.

How to wash correctly

After washing

1 Press the “Door” button.

2 Remove the washing.

Only remove washing from the machine once the drum has stopped turning, otherwise you may seriously injure yourself.

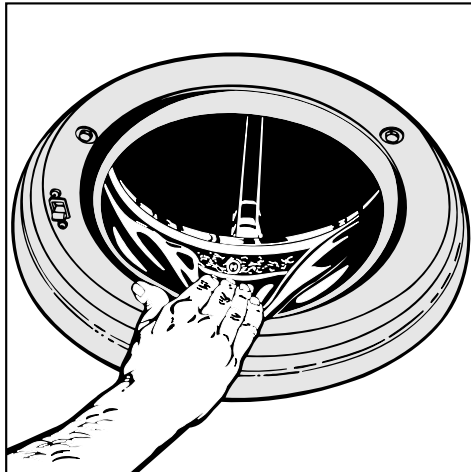

3 Check the folds in the door seal for any small articles e.g. buttons which might be lodged there.

Make sure the drum is empty, items left behind could shrink, or discolour other items in the next wash.

4 Close the drum door.

Otherwise there is a danger of objects being placed inadvertently in the drum. If these remained unnoticed and were washed in the next load, they could damage the washing.

5 Press the I-ON/O-OFF button.





Memory-Function

As soon as the basic programme has been selected, the indicator lights for the ADDITIONAL OPTIONS, TEMPERATURE and SPIN SPEED set the last time this programme was used automatically illuminate.

To run the programme with the selections already shown:

- Press the START button.

To cancel or change any of the selections retained in the memory and displayed:

- ADDITIONAL OPTIONS - to cancel, press on the illuminated touch pad; to change, press on the touch pad for the option required.
- SPIN - press the spin “” or “” touch pad .
- TEMPERATURE - press the temperature “” or “” touch pad.

The additional options, temperature and spin speed can only be selected within the permitted range of the basic programme chosen.

Note:

If a touch pad is pressed which is not accepted by the basic programme, the indicator light will go out when the touch pad is released (if selecting an additional option), or the command will be completely ignored (if selecting a temperature and spin speed).

To change a programme

Changing a programme once started:

Changing a basic programme once started:

This is only possible by starting again completely.

- Switch the machine off and then on again and select a new programme.

Changing additional options, temperature and spin speed:

This can be done if the change is compatible with the basic programme.

Exception: If the programme locking child safety feature has been set, changes are only possible by starting again.

To skip a programme stage:

- Press the “▼” touch pad when the programme reaches the stage you want to skip:

The programme will then continue in the next programme stage. The corresponding segment in the programme sequence display illuminates.

To repeat a programme stage:

- Switch the machine off and on again.
- Select the programme.
- Press the “START” button.
- Keep pressing the “▼” touch pad until the programme stage to be repeated has been reached.

Adding or removing washing after programme start

Washing can be added or removed after the programme has already started, when using the following programmes:

- COTTONS
- MINIMUM IRON
- QUICK WASH 40°C
- Press the "Door" button in and hold it until the door springs open.
- In the SEQUENCE display the segment for the relevant programme is illuminated.
- Add or remove items.
- Shut the door.
- The programme continues.

COTTONS and QUICK WASH 40°C

The door can be opened in the following programme stages:

- Soak
- Pre-wash
- Main wash, but only if the suds temperature is less than **55°C**.

Please note that the door can only be opened when the suds temperature is less than **55°C**.

QUICK WASH

The door can be opened during the following programme stage:

- Main wash

Washing cannot be added later if using the following additional options or programmable functions:

- "Water plus" (the water level is increased)
- Programme lock (e.g. to prevent children from opening the door during the wash process).

Adding detergent

All modern detergents produced for automatic washing machines are suitable, including liquid, compact (concentrated) and special application detergents. Use dispensing aids, e.g. balls, if these are supplied with the detergent. Woollens and knitwear containing wool mixtures should be washed using a detergent specifically designed for washing woollens. Amounts of detergent are recommended on the packaging. The right amount to dispense will depend on the following:

- The quantity of the washing.
- The water hardness level (check with your local water supplier).
- The level of soiling.

Water Hardness

Hardness range	Type of water (hardness)	Total hardness (mg/l)	°dH (German)
I	soft	0 - 130	0° - 7°
II	medium	130 - 250	7° - 14°
III	hard	250 - 380	14° - 21°
IV	very hard	over 380	over 21°

It is important to dispense the correct amount, because...

...too little has the following results:

- The washing will not be properly clean and will in time become grey and hard to the touch.
- Greasy particles cling to the washing.
- Lime deposits on the heater elements.

...too much results in the following:

- Excessive foam.
- Low level of agitation.
- Poor washing and rinsing results.

Water is taken in through compartment **U** in the pre-wash.

Water is taken in through compartment **W** in the main wash. If the capacity of compartment **W** is insufficient for the amount of detergent needed (e.g. in very hard water areas), the Customer Service Engineer can adjust the machine so that water and detergent can also be taken into the main wash through compartment **U**.

Water Softeners

A water softener can be used to cut down on the use of detergents in water hardness ranges II-IV. Dispense according to the amount specified on the packaging. First add detergent and then the water softener.

Use a quantity of detergent as for soft water.

If you wash using several components (e.g. special application detergents), we recommend dispensing the agents into compartment **W** in the following order:

1. Detergent
2. Water softener
3. Stain salts

This way the agents are distributed more efficiently.

Fabric conditioners/starch formulations

Fabric conditioners/Texturisers

Fabric conditioners make garments soft and fluffy to handle and help prevent static cling when tumble drying. Dispense according to the manufacturer's instructions.

Texturisers are synthetic starch formulations and give body to items e.g. shirts, tablecloths and bed linen.

- Open the lid of compartment .

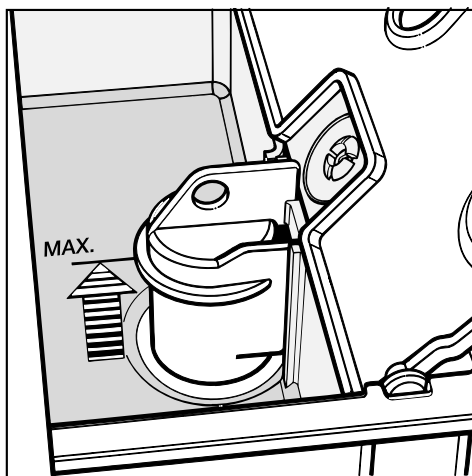

- Add fabric conditioner, but do not exceed the max. level mark.
- Close the compartment lid and push the drawer back in.
- The conditioner or retexturizer is automatically dispensed in the last rinse. At the end of the programme a small amount of water remains in the fabric conditioner compartment .

- If preferred, select "Rinse hold" to allow the load to steep in the fabric conditioner / retexturiser.

Starch / liquid starch

- Prepare and dispense the starch solution in accordance with the manufacturer's instructions.

- Add to compartment .

- Select the spin speed.

- Select "Starch".

- The "Soak / Prewash" indicator will light up.

- If the washing is not to be spun at the end of the programme after starching, select "Without final spin". Water will be drained away at the end of the starch stage.

- If the washing is to be steeped in the starch solution after the starch stage (to lessen creasing), select "Rinse hold".

To continue:

select a spin speed.

Programme selection

Programme	Fabric	Temperature range
COTTONS 	Cottons and linen fabrics, eg bedlinen, table linen, towelling, jeans, T-shirts, nappies	95°C to cold
MINIMUM IRON 	(60°C) white nylon, white polyester fabrics, (50°C) coloured nylon, polyester, cotton and viscose fabrics with special finishes, acrylic cotton fabrics, coloured polyester / cotton fabrics. (40°/30°C) minimum iron fabrics not washable at higher temperatures	60°C to cold
DELICATES 	Acrylics, acetate and triacetate, socks and stockings in man-made fibres(not wool or wool blends).	60°C to cold
	Curtains declared machine-washable by the manufacturer, (pre-wash probably advisable)	30°C to cold
WOOL	Programme for machine-washable wool fabrics, bearing the machine-washable care label, (see Care Symbols). There is not a pre-wash option.	40°C to cold
QUICK WASH	Very lightly soiled fabrics.	40°C to cold
Starch	Table cloths, napkins, overalls, uniforms	cold
Spin	Articles which can be spun, eg handwashed items, max. weight according to fabric.	
Drain	For use when the cycle stops at "Rinse hold" and the washing is not to be spun.	

Cold:

If "Cold" is selected for the temperature, the water is warmed to 24°C. This helps the effect of the detergent.

Programme selection

max. load	Additional options	Notes
5 kg	<ul style="list-style-type: none"> – Soak – Pre-wash – Short – Gentle action – Water plus 	with heavily soiled items select "Soak" or "Pre-wash" for lightly soiled items select "Short wash"
2,5 kg	<ul style="list-style-type: none"> – Soak – Pre-wash – Short wash, – Gentle action – Water plus 	with heavily soiled items select "Soak" or "Pre-wash" For lightly soiled items select "Short wash"
1 kg	<ul style="list-style-type: none"> – Soak – Pre-wash – Short 	Use the Wool programme for textiles with wool content.
Fill the drum loosely 1/2 to 3/4 full	<ul style="list-style-type: none"> – Soak – Pre-wash – Short 	Dust in curtains usually makes pre-wash advisable.
1 kg		
2.5 kg	<ul style="list-style-type: none"> – Gentle action – Water plus 	Add less detergent (half load)
5 kg	<ul style="list-style-type: none"> – Gentle action 	The washing should be washed but not treated with fabric conditioner.
5 kg		

See Section on Additional options for more details.

Programme sequence

	COTTONS	MINIMUM IRON	DELICATES
Soak	optional	optional	optional
Pre-wash	optional	optional	optional
Main wash	●	●	●
Top-up rinse	from 70°C	–	–
Graduated rinsing	–	from 50°C	from 50°C
No. of rinses – normal	3 or 4 ¹⁾	3	3
–Part load	2	3	3
–Short wash	2	2	3
Rinse and interim spin (rpm)	max. 1000	max. 500	–
Final spin (rpm)	max. 1600	max. 900	max. 600
Anti-crease spin and loosen	max. 30 mins	max. 30 mins	max. 30 mins
Rinse hold	optional	optional	optional
Without final spin	optional	optional	optional
Wash rhythm	normal	normal	gentle action
Water level – Wash	low ²⁾	low ²⁾	high
– Rinse	low ²⁾	medium ²⁾	high

Explanations:

- Function included
- Function not included

1) A 4th rinse automatically switches in if there is too much foam in the drum, or if a spin speed lower than 800 rpm has been selected.

2) Increasing the water level:

The water level can be increased from a low level to a higher level by pressing the “Water plus” button.

Top-up rinse:

Additional water flows into the drum, and the suds are cooled slightly. Hot water might damage plastic drain pipes.

Graduated rinsing:

The suds are cooled at the end of the wash cycle by water flowing in and being pumped away at intervals. This minimises the danger of creasing, by avoiding sudden temperature changes.

WOOL:

Wool is susceptible to damage from movement when it is wet. Drum movement times during the programme are shorter, and the drum rotates more slowly.

Programme sequence

QUICK WASH 40°C	WOOL	Starch	Spin/Drain
–	–	–	–
–	–	●	–
●	●	–	–
–	–	–	–
–	–	–	–
2	3	–	–
2	3	–	–
–	–	–	–
max. 500	–	–	–
max. 1600	max. 900	max. 1600	max. 1600
max. 30 mins	–	max. 30 mins	max. 30 mins
optional	optional	optional	–
optional	optional	optional	–
normal	Wool	normal	–
low ²⁾	medium	low	–
medium ²⁾	high	–	–

Rinse and interim spin:

There is a spin between the rinses.

Final spin:

The maximum spin speed according to the programme can be selected with the SPIN “+” or “–” touch pads. In the programmes MINIMUM IRON, and WOOL the spin speed is automatically limited to 900 rpm and in the DELICATES programme to 600 rpm. A lower speed can be selected.

Anti-crease, spin and loosen:

The anti-crease action guards against the tendency for creases to set in when fabrics have been left in water for a long time. There is drum movement twice a minute. The anti-crease phase can be cancelled by pressing in the “Door” button.

Rinse hold:

Interim rinse and spin is carried out in the relevant programmes.









At the end of the final rinse the washing remains suspended in water, if “Rinse hold” was selected under the SPIN options. This helps to reduce the possibility of creasing, if the washing is left for some time before being taken out of the machine.

Without final spin:

Interim rinse and spin is carried out in the relevant programmes. Washing is not spun after the final rinse, but the water is drained away, and the machine goes straight into the anti-crease stage.

Care symbols

Washing







-  Cottons 95°C
-  Cottons 60°C
-  Cottons 40°C
-  Minimum iron 60°C
-  Minimum iron 40°C
-  Minimum iron 30°C
-  Delicates 40°C
-  Delicates 30°C

Machine washable woollens



Use the special 'Wool' programme, and only wash textiles bearing the label shown here:







This symbol is registered by the IWS (International Wool Secretariat)

-  Hand wash
-  do not wash
-  dry clean
-  do not dry clean
-  suitable for chlorine bleach
-  do not use chlorine bleach











Tumble dry

-  at normal temperature
-  at low temperature
-  do not tumble dry

Ironing

-  hot iron
-  medium hot iron
-  cool iron
-  do not iron

N.B. If you have any textiles with the older wash care labels, select a programme according to the label below.

- Cottons    
- Minimum iron   
- Delicates  
- Woollens 

The following options are additionally available for certain wash programmes:

“Soak”

- For heavily soiled and stained items with dried on stains, or ones which cannot be bleached out, (e.g. blood, fats and oils, cocoa).
- Soak duration: 2 hours.

Adding detergent for "Soak"

The amount of detergent recommended by the detergent manufacturers should be distributed according to the wash programme which is to be run after the "Soak" process.

– Programmes without pre-wash:

Add the total amount of detergent to compartment **III** or directly into the drum on top of the laundry.

– Programmes with pre-wash:

1/4 of the detergent should be added to compartment **I** for the soak and pre-wash, and 3/4 added to compartment **III** for the main wash.

“With pre-wash”

- For heavily soiled and stained items.

“Short wash”

- Shorter main wash time.
- For lightly soiled items. An additional reduction in temperature is not recommended as this may lead to poorer wash results.
- In the COTTONS and MINIMUM IRON programmes only two rinse cycles are carried out at high water level.

“Gentle action”

- Drum action is reduced.
- For gentle washing of slightly soiled items.
- The programmes Delicates and Wool have reduced drum action programmed in automatically.

“Water plus”

- the water level increases in all sections of the programmes COTTONS, MINIMUM IRON and QUICK WASH 40°C.
- This is recommended for particularly delicate fabrics, and
- if more water is required for dispensing the detergent.

Delay start/time left display

Display field "TIME" (hours mins)

The display field to the right of the programme sequence display has a dual function:

1. Time left display
2.  Delay start

The indicator lights to the left of the TIME display field show which function is active.

Time left display

The programme duration is shown in hours and minutes once

- a basic programme has been selected
- the delay start period has elapsed.

After the programme has started the time left counts down in one minute intervals .

At the beginning of a programme, the duration of the programme for a full load will be displayed.

In the COTTONS programme, the type and volume of the wash will be monitored during the first water inlet phase. With a part load the time display shows a shorter time of up to 45 minutes.



Delay start

A programme start time can be delayed by a maximum of 9 hours 30 minutes.



❶ Programme selection

First carry out steps ❶ to ❺ described on page 11. Then for a delayed start:

❷ Press the delay start touch pad. The " Delay start " indicator light comes on.

Set the delay start period by pressing the " " or " " touch pads under the TIME display field as many times as is required.

1 x press = 30 mins

Each press lengthens (" ") or shortens (" ") the delay time by 30 minutes

❸ Press the "START" touch pad.

The delay start time counts down at minute intervals.

Once the delay start period is completed the programme begins and the actual programme duration shows in the display. The "Time left" indicator lights up.

The delay start can be changed again after pressing the "START" touch pad.

To cancel the delay start option:

- Press the Delay start touch pad. The programme begins immediately.

Cleaning the washing machine

- Clean the casing with a mild non-abrasive detergent or soap and water. Wipe dry with a soft cloth.
- Clean the facia panel with a damp cloth and dry with a soft cloth.
- The drum can be cleaned using a suitable proprietary stainless steel cleaner.

Do not use abrasive cleaners, or glass or all purpose cleaners. These might cause damage to the plastic surfaces because of the chemicals they contain.

Detergent dispenser drawer

- Pull out the detergent dispenser drawer until a resistance is felt.



- Press down the red release knob and at the same time pull the drawer right out of the machine.

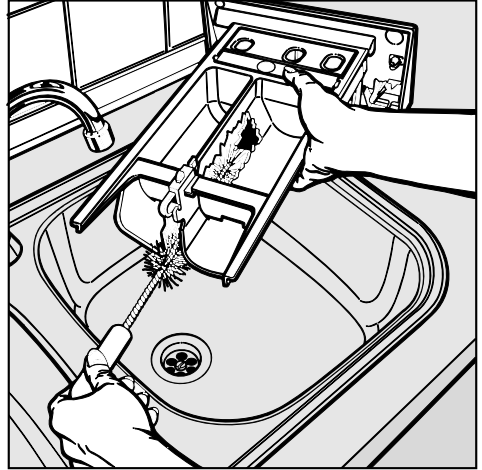

- Clean the detergent dispenser and conditioner dispenser compartments. Regularly remove any detergent residues.

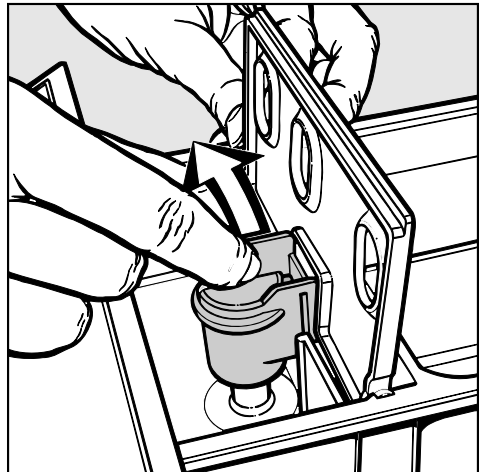

- Remove the suction tube from compartment , wash under running warm water and put back.

Cleaning and care

Cleaning the fluff filter and pump

Check the fluff filter initially after 3 - 4 washes to ascertain how often it is likely to require cleaning.

With normal cleaning approx. 2 litres of water run out.

If the drain outlet is clogged, more water will be retained in the machine (**up to 25 litres**).

Caution: if laundry has been washed at a high temperature, water draining out of the machine will still be hot!

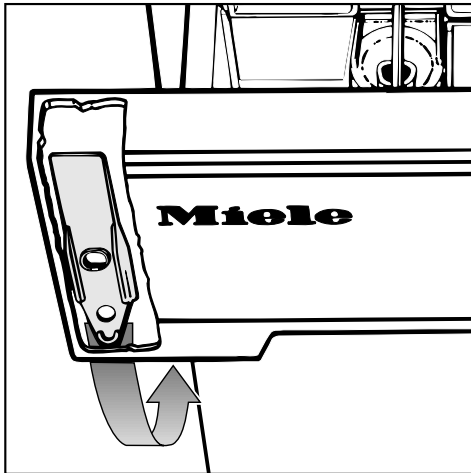

Take the (yellow) filter flap opener from behind the detergent drawer facia panel, (see illustration above).

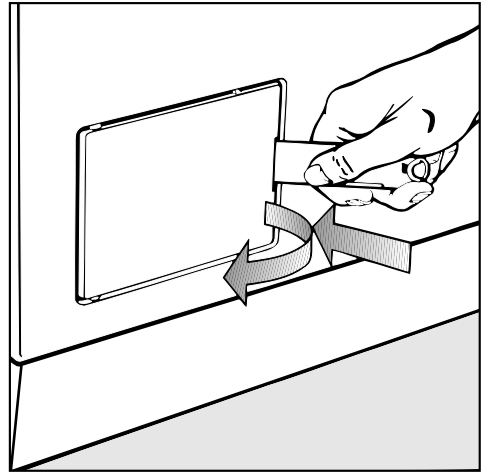

- Open the flap
- Place a dish under the drain fixture.

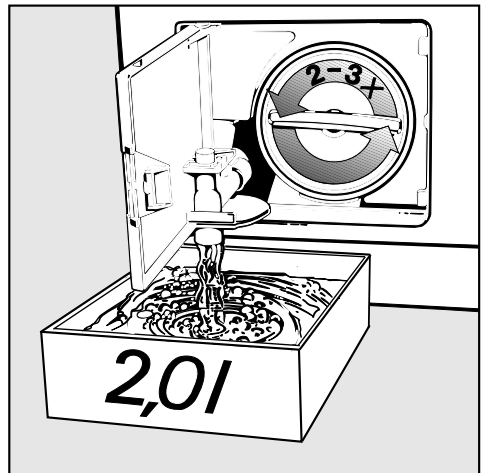

- Turn the fluff filter lid round 2 - 3 times. Do not take it right out.

With large volumes of water when the dish is full, screw the fluff filter back into position and empty the dish before repeating the procedure.

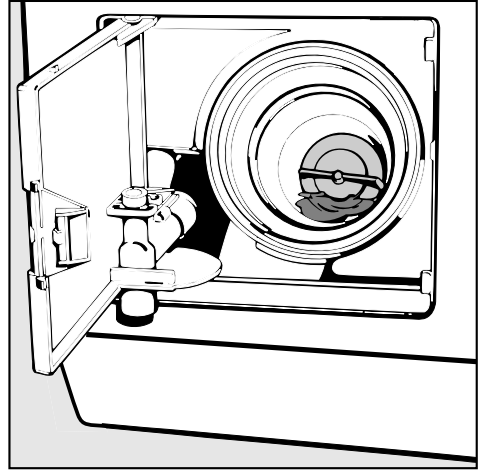
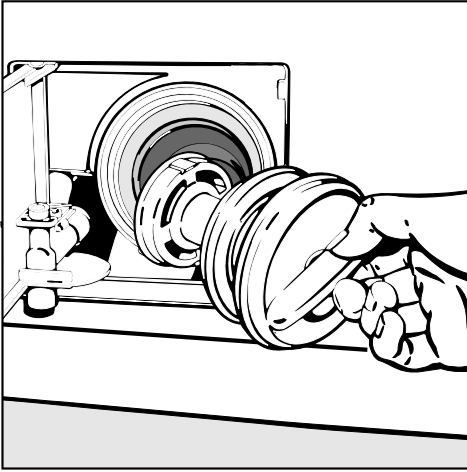

- Once the flow of water ceases, remove the fluff filter completely and clean it.
 - Remove any foreign bodies (e.g. buttons, coins, etc.) and fluff.
 - Turn the impeller by hand to check that it is free to rotate. Any foreign objects causing an obstruction should be removed.
 - Clean the inside of the fluff filter housing.
- Remove any deposits of lime scale and detergent or foreign bodies from the thread of the filter housing and filter unit (as these objects can cause a leakage of water).
- Put the fluff filter back and screw it in firmly.

Cleaning and care

Cleaning the filter in the water inlet

The washing machine has two filters to protect the water inlet valves.

The accessible filter in the union in the open end of the inlet hose should be cleaned about every six months, or after an interruption to the external water supply.

- First turn off the stopcock.
- Unscrew the threaded union connecting the free end of the inlet hose to the stopcock.



- Remove the rubber seal from the recess.
- Using pointed pliers, take hold of the plastic filter bar, remove the filter and clean.
- Put the filter and seal back in the reverse order and reconnect the hose.

Turn on the stopcock and check the connection is water tight. If water drips out, tighten the connection.

Never forget to put the filter back in place after cleaning it.

Repair work to electrical appliances should only be carried out by a suitably qualified person in accordance with local and national regulations. Unauthorised repairs could be dangerous.

What to do if, . . .	Cause . . .	Remedy . . .
. . . No lights come on in the PROGRAMME column when the machine is switched on	There is no power.	Check that: <ul style="list-style-type: none"> – the door is properly closed. – the mains plug is plugged in. – the fuse or circuit breaker has not tripped.
. . . There is an '0' in the "Time left" display, and a new programme cannot be started.	The machine was not switched off at the end of the previous programme.	Switch off and then on again (I-0) switch
. . . The "Check lights" are flashing	The water inlet is blocked. The "Check water inlet" LED is flashing.	<ul style="list-style-type: none"> – The stopcock is not opened far enough. – The inlet hose is kinked. – The water pressure is too low. Call the Service Dept.
	The water inlet system is blocked. The "Check water inlet" LED is flashing.	<ul style="list-style-type: none"> – Switch the machine off. – Open the stopcock. – Select a programme and start again.
	The water outlet is blocked. The "Drain"(check water outlet) LED is flashing.	<ul style="list-style-type: none"> – Clean the drain pump and fluff filter. – Has the drain pump been fixed too high? (max drain head 1 metre).
	The Waterproof system has reacted to a leak. The "Check water inlet" and "Drain" LEDs" are flashing.	Call the Service Dept.

Problem solving guide

What to do if, . . .	Cause . . .	Remedy . . .
<p>. . . The “Check lights” are flashing</p>	<p>Too much foam has built up. The “Excess detergent” light is flashing.</p>	<ul style="list-style-type: none"> – Use less detergent next time, and follow the recommendation on the packet. – Take the water hardness level into account. – Use a different suitable low-lather detergent
<p>. . . in the “SEQUENCE” display one of the following light blocks is flashing:</p> <ul style="list-style-type: none"> – “Soak / Pre-wash” – “Main wash” – “Rinses 1 - 2 – “Rinse 3 	<p>There is a fault.</p>	<p>Start the programme again. If the light block starts flashing again, call the Service dept.</p>
<p>. . . The wash programme finishes prematurely and three horizontal dashes “- - -” appear in the display</p>	<p>There is a fault.</p>	<p>Restart the programme. If the horizontal dashes reappear call the Service Dept.</p>
<p>. . . In the SEQUENCE column the “Final spin” light is flashing</p>	<p>The final spin has not taken place. The machine detected an imbalance.</p>	<ul style="list-style-type: none"> – Loosen the laundry load. – Press the Drain/Spin touch pad in the ADDITIONAL OPTIONS column. – Select the spin speed required. – Press the START touch pad.
<p>. . . The washing has not been spun satisfactorily</p>	<p>The spin speed selected was too low.</p>	<p>Select a higher spin speed next time.</p>
	<p>The load was not distributed sufficiently evenly in the drum. To protect the machine laundry was only spun at a reduced speed.</p>	<p>Always mix large and small items in the load.</p>
	<p>The fluff filter is clogged.</p>	<p>Clean the fluff filter.</p>

Problem solving guide

What to do if	Cause . . .	Remedy . . .
. . . the drum door cannot be opened.	The appliance is not plugged in to the electricity supply.	– Put the plug in the socket.
	Power cut	– See “What to do if” - (1st Section) on how to open the door.
	The door was not correctly engaged.	– Please press hard against the lock side of the drum door and then press the “Door” button.
	There is still water in the drum.	– Select the “Drain” programme for the water to be pumped out. – Open the drum door
	The suds temperature is higher than 55°C.	
. . . The machine shakes during the spin cycle	The four feet are not resting evenly on the floor.	Level the machine (see Installation Section).
. . . In spite of adequate water supply the water flows slowly into the machine	The filter in the water inlet system is blocked.	– Clean the water inlet filter.
. . . Large residues of detergent remain in the dispenser drawer	The water supply pressure is too low.	– Clean the filter in the water inlet system. – It may be useful to select “Water plus”.
	Washing powder used with water softener tends to become sticky.	– Pour washing powder into the dispenser before adding any water softener.
. . Fabric conditioner is not completely dispensed or water remains in the  compartment	The dispenser drawer was not pushed right in when the fabric conditioner was being flushed in.	
	The siphon tube is either incorrectly positioned or clogged.	Clean the siphon tube.

Problem solving guide

What to do if, . . .	Cause . . .	Remedy . . .
. . . Lime deposits appear on the drum surface	Not enough detergent has been used.	<ul style="list-style-type: none"> – Use a descaling agent which must be stated by the manufacturer to be suitable for use in washing machines. – Use the correct amount of detergent to cope with the water hardness.
. . . Grey, greasy particles cling to washed laundry	Insufficient amounts of detergent were used to break down the particles of grease in heavily soiled laundry.	<ul style="list-style-type: none"> – Either add more detergent, or use liquid detergent. – Before washing the next load run a COTTONS 60°C programme with liquid detergent but without a load to clean the machine.
. . . there are white residues which look like powder detergent on the washing:	The detergent contained compounds (zeolites) to aid water softening which are not soluble in water. These have ended up on the textiles.	<ul style="list-style-type: none"> – Use detergents containing no zeolites to re-wash the load, and in the future. – Liquid detergents usually contain no zeolites. – Try and brush off the residues with a soft brush.
. . . Liquid detergent does not give the required result	Liquid detergents do not contain bleaching agents. They do not remove stains eg fruit coffee and tea stains.	<ul style="list-style-type: none"> – Use a general purpose washing machine powder containing a bleaching agent. – Pour stain remover (salts) into the dispenser drawer compartment  – Never put stain salts and liquid detergent together in the dispenser drawer.
. . . The pump makes strange noises.	These noises occur at the end of a pump sequence as a normal part of the operation. They are not a fault.	

Opening the drum door in the event of a power failure

- Switch off the washing machine.

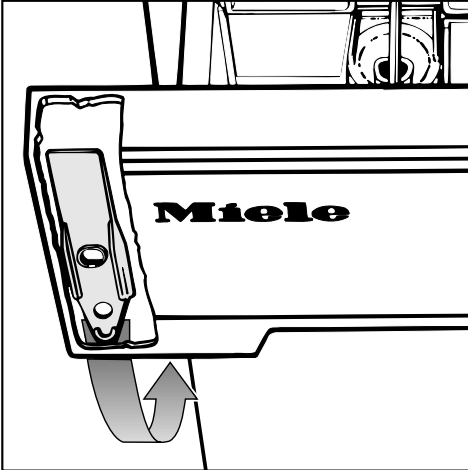

- Remove the flap opener from behind the detergent drawer fascia panel.

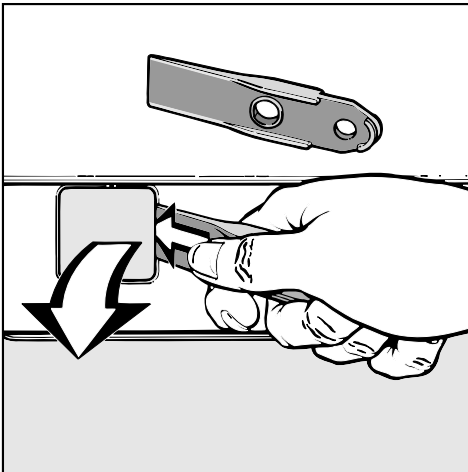

- Open the flap (in the machine plinth).

- Place a dish or bowl under the spout.
- Point the drain hose into the container.

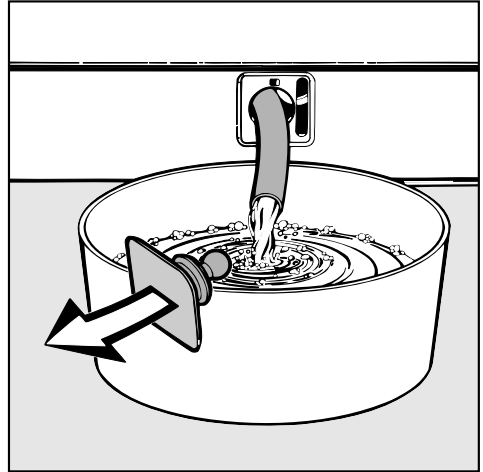

- Remove the stopper.

Caution: if laundry has been washed at a high temperature water draining out of the machine will still be hot!

The amount of water discharged depends on the drainage height. A delivery head (e.g. 1 m) will mean there is more water to drain. The container will need to be emptied several times.

- When no more water drains out place the stopper back in the hose.

Problem solving guide

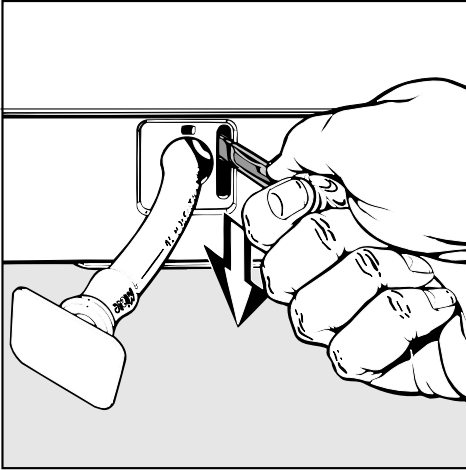

- Pull the emergency door latch downwards using a spoon handle (see illustration). The machine door will then open.

Please note that: on machines with left hand hingeing the emergency door latch is located behind a second access flap in the centre of the plinth.

Always make sure the drum is stationary before reaching in to the machine to remove washing. Reaching into a moving drum is extremely dangerous.

To check water pressure

- Place a bucket under the stopcock.
- Turn on the stopcock.

If 5 litres of water flow into the bucket in 15 seconds the water pressure is correct.

Electric socket

If there is any doubt about the electricity supply socket, consult a qualified electrician.

In the event of any faults which you can not remedy yourself, please contact:

- Your Miele Dealer or
- Your nearest Miele Service department.

(see back cover for the address).

When contacting the Service Department, please quote the Model and Serial nos. of your appliance, both of which are shown on the data plate visible when the door front is opened above the porthole glass.

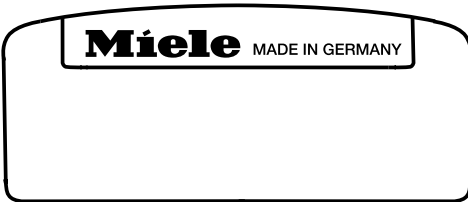

Future updates

The indicator light marked PC is reserved for the service engineer, for updates in future years to your machine.

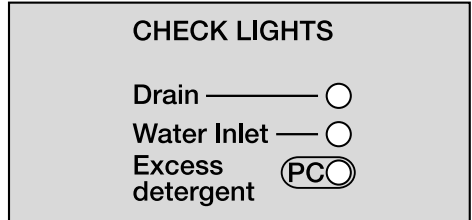

When for example technological developments offer advanced modifications to your existing programme cycles, a service engineer will be able to input these into your machine controls.

Miele will provide information when such possibilities become available.

Installation

Installation surface

A concrete floor is the most suitable installation surface for a washing machine, being far less prone to vibration during the spin cycle than wooden floorboards or a surface with "soft" properties.

Please note the following points:

- The machine must be level and securely positioned.
- To avoid vibrations during spinning, the machine should not be installed on soft floor coverings.
- If installing on a wooden joist floor, we recommend a plywood base at least 30 mm thick, 590 x 520 mm wide. The base should span several joists and be bolted to the joists, not only to the floorboards. Check for the presence of pipes and cables first.

The most stable part of a floor is usually in the corner.

- If the machine is installed on a raised plinth, it **must** be secured against slippage during spin using retaining clips (available from the Miele Spare Parts Dept).

Installation

Lift the machine from its packaging base and move it to its site. Please note:

- Do not lift the machine by the drum door.
- Ensure that the machine feet and the floor are dry to prevent the machine from slipping during the spin cycle.

Removing the transit fitting

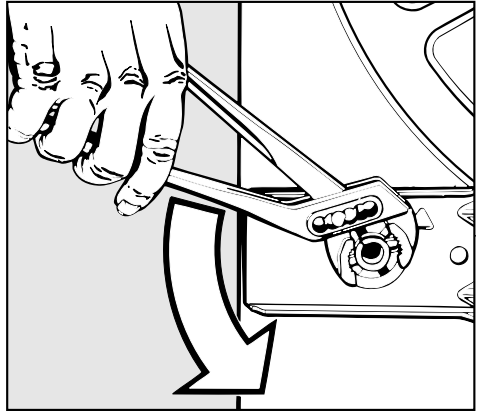

- Turn the left-hand transit bar 90°.

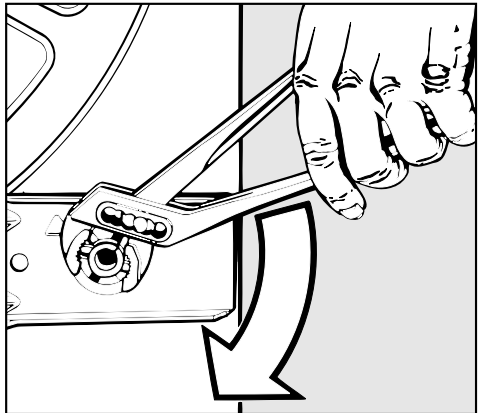

- Turn the right-hand transit bar 90°.

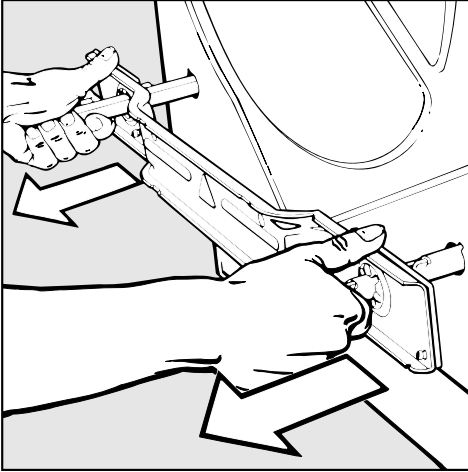

- Withdraw the two bars together with the support plate.

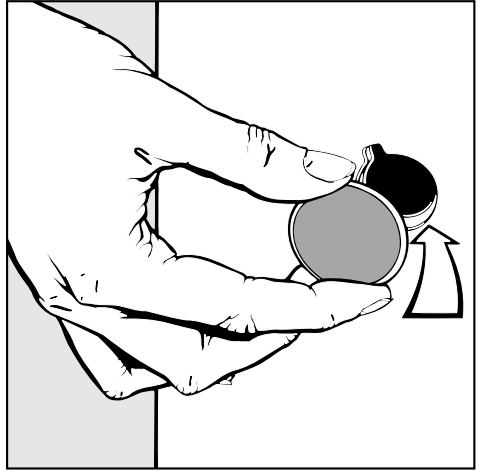

- Plug the two holes with the plastic caps supplied.

The machine should not be moved without the transit fitting in place.

The transit fitting should be stored in a safe place for future use. It must be re-fitted if the machine is to be moved again. Re-fitting is carried out by reversing the procedure.

Installation

Levelling the machine

The machine must be perfectly level to

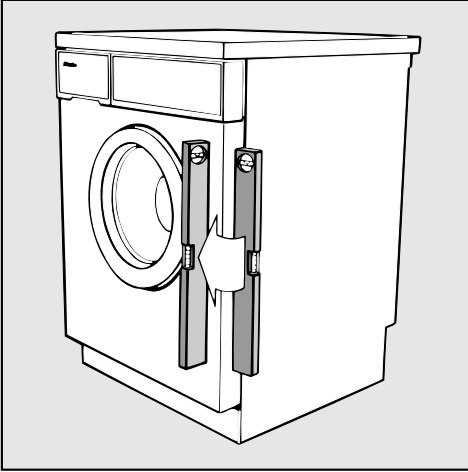

ensure safe and proper operation.

Incorrect installation may increase water and electricity consumption.

The screw feet can be adjusted to level the machine.

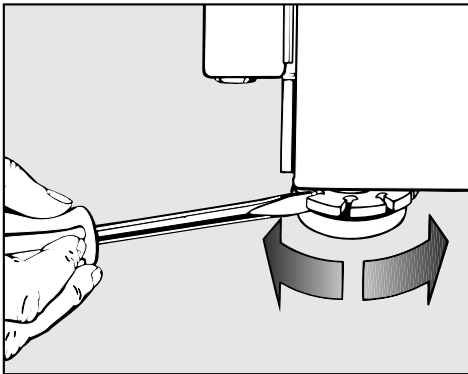

- Unscrew the foot or feet until the machine stands level.
- Hold the foot tight using a pipe wrench.

- Tighten the counternut using a screwdriver as indicated.

Building under

To install this appliance under a (continuous) worktop:

- A special building under conversion kit* is required. The machine lid must be replaced by a cover plate. To ensure electrical safety the cover plate must be fitted by a suitably competent person exactly according to the fitting instructions included with the kit.
- Fitting instructions are supplied with the conversion kit.
- For installation under a work surface 900/910 mm from the floor, a raising kit* is required.
- Connections for electricity, water and drainage should be installed in such a way that they remain accessible when the machine is in place.

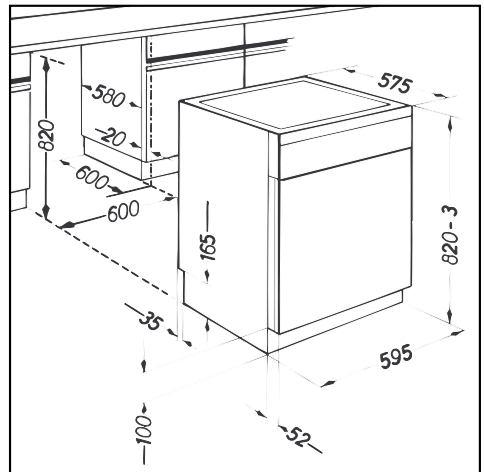

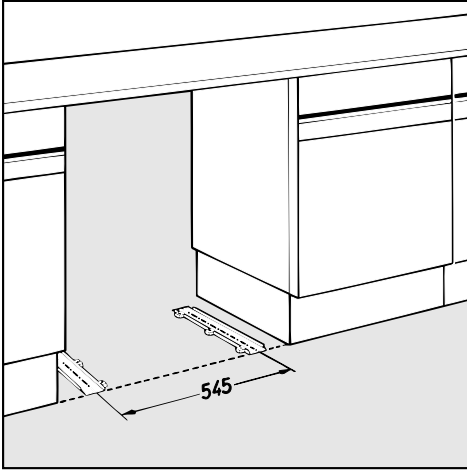

The skids provided with the building under kit * are intended to prevent damage to floor coverings when manoeuvring the washing machine into position.

Washer-Dryer stack

A Miele tumble dryer can be stacked with the washing machine. A stacking kit* is necessary and can be purchased from the Miele Spare Parts Department.

All parts marked * are available from the Miele Spare Parts or Sales Department.

Fitting or changing the decor panel

Note: The door should be shut for fitting or changing the decor panel.

- Remove the 4 screws from the decor strip on the door catch side of the door and remove the decor strip.

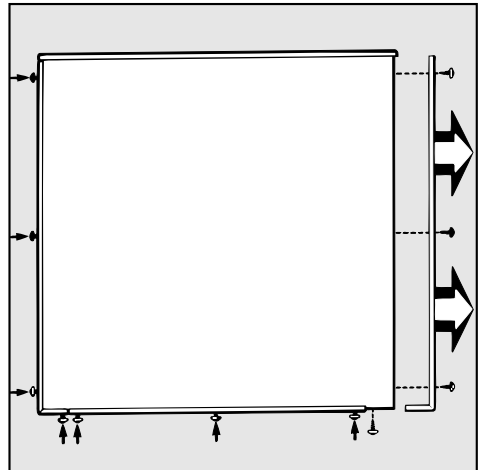

- Unscrew the remaining 7 screws from lower and side decor strips until the decor panel bows slightly and can then be taken out or put in place.
- Re-assemble in the reverse order and tighten the screws.

Installation

Decor panel dimensions

(The figures given in brackets indicate the tolerance level in mm.)

Width: 587 (-1) mm
Height: 602 (-1.5) mm
Thickness: 1 (+0.5) mm

Panels more than 1.5 mm thick require an “adapter strip for a 4 mm thick decor panel”. This is available from your Miele Dealer or the Spare Parts Department.

Note: The decor panel height required for the adapter strip must not exceed 596.5 (- 1.5) mm.

Fitting a plinth fascia

The appliance plinth below the door can be concealed using a plinth fascia.

The height and return of the appliance cannot be altered.

A taller plinth fascia can only be installed if the overall niche height is greater.

Plinth height 100 mm (standard)

Niche height 820 mm:

Plinth height 150 mm

Niche height 870 mm: a raising kit is required.

Plinth height 200 mm

Niche height 920 mm: two raising kits are required.

A plinth fascia (60 cm long) can be ordered from your kitchen Dealer or manufacturer. For Miele kitchens please quote the model number when ordering. Before installing the plinth fascia:

The flap(s) in the appliance plinth must on no account be covered over.

Installation:

- Stick the velcro fastener provided to the appliance plinth.

For this the following procedure is recommended:

- Match up the hooked side and the looped side of the velcro fastener lengthwise.
- Cut into 2 or 3 pieces.
- Peel off the protective backing from one of the velcro fastener pieces.
- Position the cut pieces along the appliance plinth, at the left and right hand edge, and in the middle. Press firmly into place.
- Now peel the protective backing off the other velcro fastener piece.
- Address the plinth fascia to the adhesive backing on the velcro and press firmly into place.

Residual test water

Flush out any residual test water still in the machine as follows:

- Do not load the machine.
- Add a little detergent to compartment **III**.
- Switch on the machine.
- Select the "COTTONS 60°C" programme.
- Select the "Short" option.
- This operation will flush out any residues.

Water hardness reminder

The amount of detergent will depend on various factors including the water hardness level in your area. Set the water hardness dial located in the detergent dispenser box as a reminder.

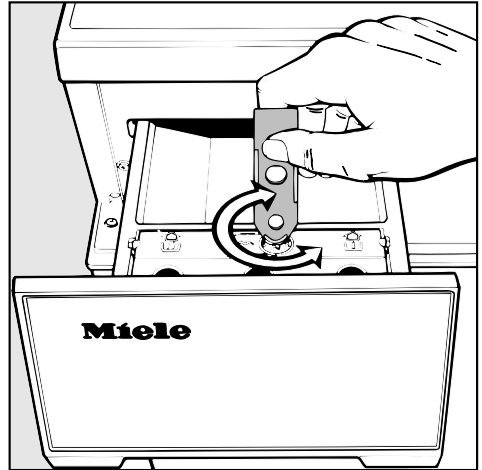

- Turn the dial to the relevant setting.

(I = soft, IV = very hard).

Use the spatula supplied with the machine. It is located at the rear of the dispenser drawer.

If you do not know how hard the water is in your catchment area, please contact your local water authority.

Plumbing

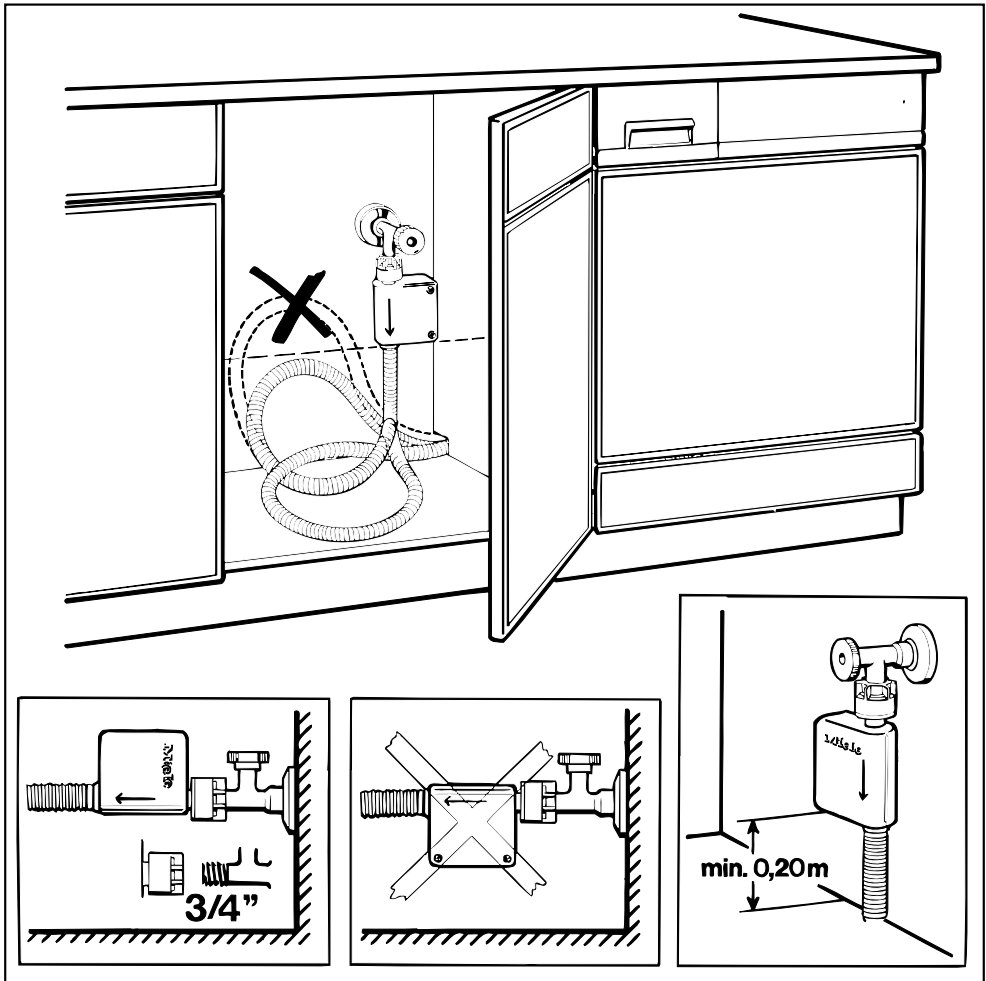

Connection to water supply

Fitting

The machine should be connected to a mains water supply in accordance with standard regulations. In Germany the washing machine is not required to have a non-return valve as it has been designed to comply with DVGW regulations.

The machine is designed to operate with a minimum water pressure of 1 bar. There is a minimum flow pressure of 1 bar if 5 litres of water flow into a suitable container in 15 seconds. The static water pressure must not exceed 10 bar. If it is higher than 10 bar it is essential to fit a reducer valve.

The **Miele “Waterproof system”** connected between the stopcock and the machine offers the safest protection against water leaks.

For the “Waterproof system” to function correctly, it may only be fitted in the positions shown (see illustrations).

Connection to the mains water supply should incorporate a mains stopcock with 3/4" thread. The stopcock should be fitted by a qualified plumber.

The connection point is subject to mains water pressure. Turn on the stopcock slowly and check for leaks. Correct the position of the washer and union if appropriate.

The “Waterproof system” is **NOT** suitable for connection to a hot water supply.

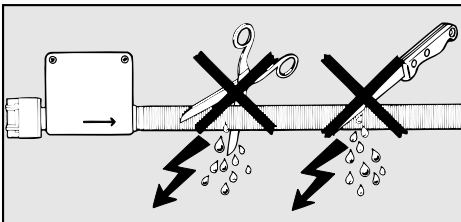

The protective sleeve of the hose **must not be damaged** (see illustration).

The “Waterproof system” with a hose length of approx. 4.5 metres is available as an optional extra.

Function

At the heart of this leak protection system there is an **electric safety valve**, which works like an automatic stopcock. The **Miele “Waterproof system”** protects from water damage in the following cases:

Protection in the event of a leaking machine

Any leaking water is collected in a sump in the base of the appliance. A float switch switches the safety valve off electrically, no more water will flow in.

Protection in the event of a leaking water inlet hose

Leaking water is fed into the sump through the protective covering which surrounds the inlet hose as a “second skin”. The float switch switches off the water supply.

Maintenance

NB. If you intend to unscrew the “Waterproof system” unit from the mains water supply it is essential that the machine is first disconnected from the electricity supply.

Only use a genuine Miele “Waterproof system” able to withstand pressure of up to 70 bar, should you ever need a replacement.

The two dirt filters - one at the inlet point - one in the solenoid valve inlet, must not be removed.

Plumbing

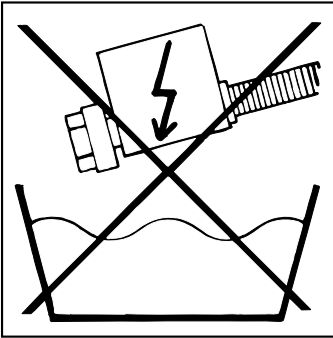
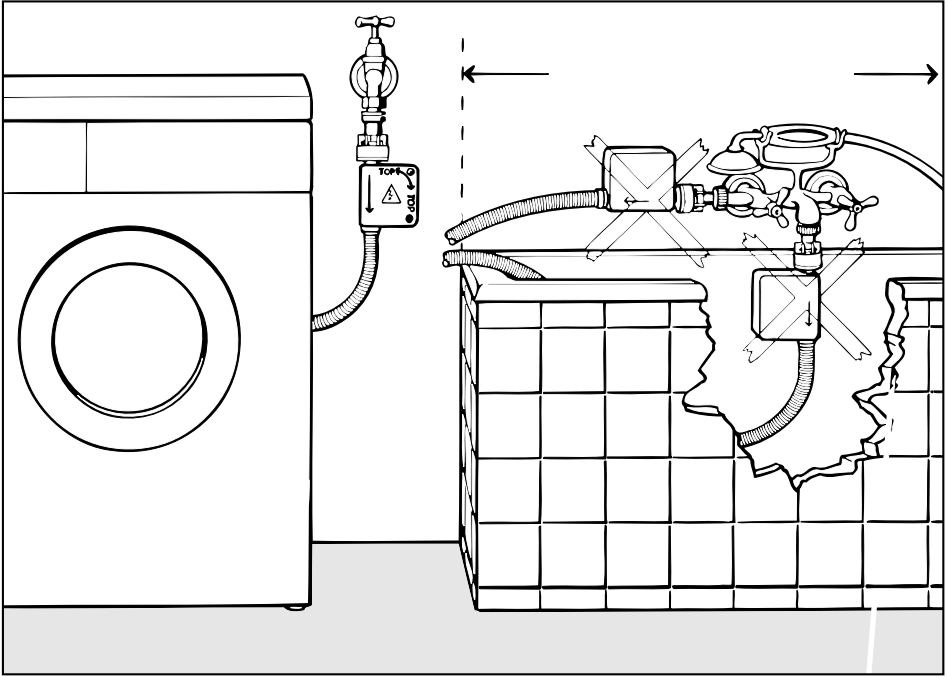

The "Waterproof system" must only be connected to its own stopcock. It must not be connected to mixer taps or similar.

Important!

The plastic casing of the water connection contains an electric component.

Do not dip into any liquid!

Connection to the drainage system

The machine drains via a drain pump with a delivery head of 1 metre.

The drain hose is 1.5 m long. It must not be kinked as this restricts drainage. The Swivel elbow at the end of the hose can be turned in either direction, or can be detached if required with a sharp twist and pull.

Drain hose connection:

- Direct into a sink: Hook the hose over the edge and secure. Make sure that the water can flow freely to avoid flooding and to prevent water from being sucked back into the machine.
- Connected to a standpipe.
- Connected to a plastic drain pipe with a rubber nipple. There is no need to use a non-return valve.
- Allow the water to drain off into a floor drain.

If required, the drain hose can be extended to a length of 5 m. The necessary parts can be purchased from the Miele Spareparts department.

For a delivery head of more than 1 m (up to a maximum of 1.8 m) a second Duo drain pump is available with the corresponding conversion kit from the Miele Spare Parts Department.

Electrical connection

This machine is supplied ready for connection to an a.c. single phase 230 - 240 V, 50 Hz supply. The machine is supplied with a 2 m long mains cable with moulded plug. The voltage, rated load and fuse rating are given on the data plate. Please ensure that these match the household mains supply.

All electrical work should only be carried out by a suitably competent person, in accordance with national and local safety regulations.

Connection should be made via a fused plug and a suitable switched socket which is easily accessible. For extra safety it is advisable to install a residual current device (RCD) with a trip current of 30 mA.

Important

The wires in the mains lead are coloured in accordance with the following code:

Green/yellow = earth

Blue = neutral

Brown = live

As the colours of the wires in the mains lead of this appliance may not correspond with the coloured markings identifying the terminals in your plug, proceed as follows:

The wire which is coloured green and yellow must be connected to the terminal in the plug which is marked with the letter E or by the earth symbol \perp or coloured green or green and yellow.

The wire which is coloured blue must be connected to the terminal which is marked with the letter N or coloured black.

The wire which is coloured brown must be connected to the terminal which is marked with the letter L or coloured red.

WARNING

THIS APPLIANCE MUST BE EARTHED

Non-rewireable plugs BS 1363

If this machine or appliance is fitted with a non-rewireable plug, the following information applies:

If the socket outlets are not suitable for the plug supplied with this product, it must be cut off and an appropriate plug fitted.

The plug cut from the flexible cord should be disposed of and on no account be inserted into any socket elsewhere in the house (electric shock hazard).

The fuse cover must be refitted when changing the fuse, and if the fuse cover is lost, the plug must not be used until a suitable replacement is obtained. The colour of the correct replacement is that of the coloured insert in the base of the plug, or the colour that is embossed in words in the base of the plug (as applicable to the design of plug fitted). The correct fuse rating of the replacement fuses that are ASTA approved to BS 1362 should be fitted. Replacement fuse covers may be purchased from your local electrical suppliers, or Miele Service Agent.

The following programmable functions can be activated by the user.

A function stays programmed in memory until it is cancelled.

High water level (P1)

Where rinse results are particularly important.

Effective for the rinses in programmes:

- COTTONS
- MINIMUM IRON
- QUICK WASH 40°C

Extra rinse for Cottons programmes (P2)

For soft water areas (water hardness range I).

Where rinse results are particularly important in soft water areas an extra rinse can be selected as well as high water level.

Programme Lock (P5) (Child safety feature)

Programme lock prevents the additional options, the temperature and spin speed from being altered, e.g. by children playing.

It prevents unplanned opening of the door.

The programme can only be changed by a completely fresh start.

Buzzer at the end of a programme (P18)

(this is programmed as standard, but can be deactivated)

The buzzer sounds,

- when a wash programme has finished,
- when "Rinse hold" or "Without final spin (Drain)" has been selected.

Programmable functions

The machine must first be switched off and the door closed.

To select, activate or deactivate a programme function:

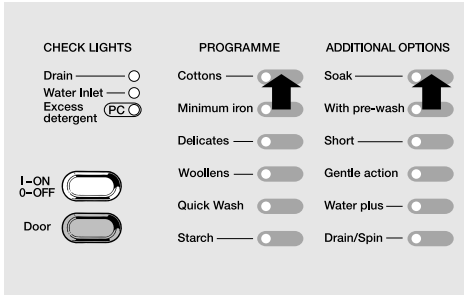

- 1 Press the Cottons and Soak pads at the same time and hold them in.
- 2 at the same time press the I-On/0-Off button.
 - The machine is switched on.
- 3 “P”. appears on the left of the time display.
- 4 Press the “-” or “+” touch pads under the time display.

“P” and a number flash alternately in the display:

- P1 high water level,
- P2 extra rinse, Cottons
- P5 child safety
- P18 buzzer (on or off).

- 5 Keep pressing the “-” or “+” touch pads under the time display until the required programme function number is displayed alternating with the P.

- 6 On the right of the time display there appears:

- “0” = Programming function is deactivated.
- “1” = Programming function is activated.

- 7 Press the “Start”-touch pad to change from “0” to “1” (the programmable function is activated) or from “1” to “0” (the programming function is deactivated).

To store a programmable function:

- Press the I-On/0-Off button.
 - The machine is switched off.

Consumption data

Normal Programmes (without any additional options or programmable functions)	Load	Consumption data
COTTONS 95°C	5 kg	Electricity: 1.70 KWh Water: 59 l Time: 1 h 52 mins
COTTONS 60°C *	5 kg	Electricity: 0.96 KWh Water: 56 l Time: 1 h 50 mins
COTTONS 40°C	5 kg	Electricity: 0.50 KWh Water: 56 l Time: 1 h 35 mins
MINIMUM IRON 40°C	2,5 kg	Electricity: 0.40 KWh Water: 65 l Time: 1 h 20 mins
DELICATES-SYNTHETICS 30°C	1 kg	Electricity: 0.40 KWh Water: 75 l Time: 59 min
WOOL 30°C	1 kg	Electricity: 0.20 KWh Water: 58 l Time: 46 mins

* Acc. to DIN EN 60456

Consumption data can vary from the nominal values given as a result of water pressure, water hardness, water inlet temperature, room temperature, type of load, volume, fluctuations in the electricity supply and any additional functions selected.

Technical Data

Height	85 cm
Width	59.5 cm
Depth	60 cm
Depth with door open	118 cm
Weight	102 kg
Max. floor load	1600 Newton (approx. 160 kg)
Capacity	5 kg dry laundry
Voltage	} s. Data plate
Rated load	
Fuse rating	
Water flow pressure min.	1 bar
Static water pressure max.	10 bar
Drain pump head max.	1 m
Drain pump length max.	5 m
Test certificates awarded	Radio/tv suppression, VDE
Electrically suppressed according to	DIN EN 60555/VDE 0838

Miele

United Kingdom

Miele Co. Ltd., Fairacres, Marcham Road, Abingdon, Oxon, OX14 1TW

tel. Abingdon (01235) 554455 - fax (01235) 554477

Service Office, tel. Abingdon (01235) 554466

Free Manuals Download Website

<http://myh66.com>

<http://usermanuals.us>

<http://www.somanuals.com>

<http://www.4manuals.cc>

<http://www.manual-lib.com>

<http://www.404manual.com>

<http://www.luxmanual.com>

<http://aubethermostatmanual.com>

Golf course search by state

<http://golfingnear.com>

Email search by domain

<http://emailbydomain.com>

Auto manuals search

<http://auto.somanuals.com>

TV manuals search

<http://tv.somanuals.com>