

Operating instructions

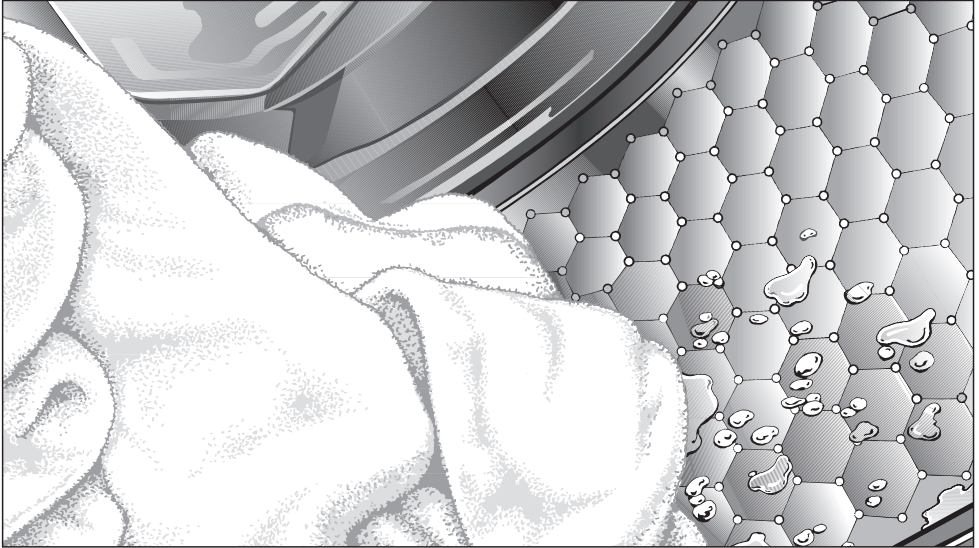

for Washing machine W 5872 Edition 111

To avoid the risk of accidents or damage to the machine it is **essential** to read these instructions before it is installed and used for the first time.

en - GB

M.-Nr. 09 495 130

Caring for our environment

Disposal of the packing material

The transport and protective packing has been selected from materials which are environmentally friendly for disposal and should be recycled.



Ensure that any plastic wrappings, bags etc. are disposed of safely and kept out of the reach of babies and young children. Danger of suffocation!

Disposal of your old machine

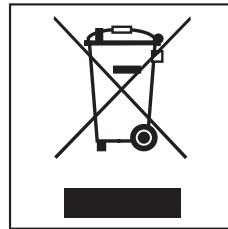
Electrical and electronic machines often contain materials which, if handled or disposed of incorrectly, could be potentially hazardous to human health and to the environment. They are, however, essential for the correct functioning of your machine. Please do not therefore dispose of it with your household waste.



Please dispose of it at your local community waste collection / recycling centre or contact your Dealer for advice. Ensure that it presents no danger to children while being stored for disposal.

Caring for our environment	2
Warning and Safety instructions	6
Operating the washing machine	13
Control panel	13
Optional programme packages	15
Before using for the first time	16
Washing environmentally and economically	17
Energy and water consumption	17
Detergent	17
Eco feedback	18
How to wash correctly	19
Spinning	24
Final spin speed	24
Delay start	25
Programme chart	26
Extra options	30
Short	30
Stains 	30
Further extras 	30
Pre-wash	31
Soak	31
Garment care label symbols	33
Programme sequence	34
Changing the programme sequence	36
Cancelling a programme	36
Interrupting a programme	36
Making changes to a programme	36
Adding or removing laundry after a programme has started	37
Safety lock	37

Contents

Detergent	38
The correct detergent	38
Water softener	40
Washing with several components	40
Fabric conditioners and liquid starch	41
Colour run and dye removers/dyes	41
Cleaning and care	42
Cleaning the drum (Hygiene info)	42
External casing and fascia panel	42
Cleaning the detergent dispenser drawer	42
Cleaning the water inlet filters	44
Problem solving guide	45
The programme does not start	45
The following fault messages appear in the display and the programme stops.	46
The following fault messages appear in the display	47
General problems	48
An unsatisfactory wash result	49
The drum door does not open when you press the Door button.	50
Opening the drum door in the event of a blocked drain outlet and/or power failure	51
Blocked drain outlet	51
After sales service	53
Future updates (PC)	53
Guarantee	53
Optional spare parts and accessories	53
Installation and connection	54
Front view	54
Rear view	55
Installation surface	56
Transporting the washing machine to its installation site	56
Removing the transit bars	56
Re-fitting the transit bars	58

Levelling the machine	59
Screwing out and adjusting the feet	59
Building under a continuous worktop/in a kitchen run	60
Washer and Dryer stack	60
The Miele water protection system	61
Connection to the water supply	62
Connection to the drainage system	63
Electrical connection U.K.	64
Technical data	65
Consumption data	66
Notes for test institutes:	67
Settings	68
To access Settings	68
To select a Setting	68
To alter a Setting	68
To come out of Settings	68
Language 	68
Total usage	69
Water plus	69
Soak	69
Gentle action	70
Suds cooling	70
Code	70
Temperature unit	71
Buzzer	71
Keypad tone	71
Brightness	71
Standby display	72
Memory	72
Anti-crease	72
Optional accessories	73
CareCollection	73

Warning and Safety instructions

This washing machine conforms to current safety requirements. Inappropriate use can, however, lead to personal injury and damage to property.

To avoid the risk of accidents and damage to the washing machine, please read these instructions carefully before using it for the first time. They contain important information on its installation, safety, use and maintenance.

Keep these instructions in a safe place and ensure that new users are familiar with the content. Pass them on to any future owner.

Correct application

▶ This washing machine is not designed for commercial use. It is intended for use in domestic households and in similar working and residential environments.

▶ The washing machine is not intended for outdoor use.

▶ It must only be used as a domestic appliance to wash items which are specified by the manufacturer as being washable on the care label.

Any other usage is not supported by the manufacturer and could be dangerous. Miele cannot be held liable for damage resulting from incorrect or improper use or operation of the washing machine.

▶ The washing machine can only be used by people with reduced physical, sensory or mental capabilities, or lack of experience and knowledge, if they are supervised whilst using it or have been shown how to use it in a safe way and understand the hazards involved.

Safety with children

- ▶ Children 8 years and older may use, clean or maintain the washing machine without supervision only if they have been shown how to do so in a safe way and understand the hazards involved.
- ▶ Children under 8 years of age must be kept away from the machine unless they are constantly supervised.
- ▶ The washing machine is not a toy! To prevent the risk of injury, do not allow children to play with it or near it, or to play with the controls.
- ▶ For machines with a 'porthole' door, remember that the porthole glass will be hot when washing at high temperatures
Do not let children touch it.

Warning and Safety instructions

Technical safety

▶ Before setting up the washing machine, check it for any externally visible damage.

Do not install or use a damaged washing machine.

▶ Before connecting the washing machine, ensure that the connection data on the data plate (voltage and frequency) match the mains electricity supply. If in any doubt, consult a qualified electrician.

▶ The electrical safety of this washing machine can only be guaranteed when correctly earthed. It is most important that this basic safety requirement is observed and regularly tested, and where there is any doubt the household wiring system should be inspected by a qualified electrician. The manufacturer cannot be held liable for the consequences of an inadequate earthing system (e.g. electric shock).

▶ Do not connect the washing machine to the mains electricity supply by an extension lead. Extension leads do not guarantee the required safety of the machine (e.g. danger of overheating).

▶ Faulty components must only be replaced by genuine Miele original spare parts. Only when these parts are fitted can the safety standards of the machine be guaranteed.

Warning and Safety instructions

- ▶ Unauthorised repairs could result in unforeseen dangers for the user, for which Miele cannot accept liability. Repairs should only be undertaken by a Miele approved service technician.
- ▶ If the connection cable is faulty it must only be replaced by a Miele approved service technician to protect the user from danger.
- ▶ The machine must be isolated from the electricity supply in the event of a fault and during installation, maintenance and repair work.
- ▶ This washing machine must only be connected to the on-site water supply using a new hose kit. Old hoses must not be re-used.
- ▶ In areas which may be subject to infestation by cockroaches or other vermin, pay particular attention to keeping the machine and its surroundings in a clean condition at all times. Any damage which may be caused by cockroaches or other vermin will not be covered by the guarantee.
- ▶ This machine must not be used in a non-stationary location (e.g. on a ship).
- ▶ Do not make any alterations to the washing machine, unless authorised to do so by Miele.

Warning and Safety instructions

Correct use

- ▶ Do not install your washing machine in rooms where temperatures below freezing may occur. Frozen hoses may burst or split. The reliability of the electronic control unit may be impaired at temperatures below freezing point.
- ▶ Before using the washing machine for the first time, check that the transit bars at the rear of the machine have been removed (see section on "Installation and connection"). During spinning, a transit bar which is still in place may result in damage to both the machine and adjacent furniture or appliances.
- ▶ Turn off the stopcock if the machine is to be left for any length of time (e.g. holiday), especially if there is no floor drain (gully) in the immediate vicinity.
- ▶ Flooding danger.
If hooking the drain hose into a wash basin, check that the water can drain off quickly enough to prevent the sink from overflowing. Make sure the drain hose is secure, so that the force of the water flowing out of the hose does not dislodge it.
- ▶ Take care to ensure that foreign objects (e.g. nails, pins, coins, paper clips) do not find their way into the machine with the laundry. These may damage components of the machine (e.g. suds container, drum), which in turn can result in damage to the laundry.

Warning and Safety instructions

- ▶ If the correct amount of detergent is dispensed, the machine should not need to be descaled. If, however, you do wish to descale the machine only use proprietary non-corrosive descaling agents and strictly observe the instructions on the packaging. A special descaling agent is available to order from the Miele Spare Parts Department or via the internet on www.miele-shop.com.
- ▶ Textiles which have been pre-treated in solvent based cleaning agents must be thoroughly rinsed in clean water before being washed in the machine.
- ▶ Do not use solvent based cleaning agents, e.g. those containing benzene, in this machine, as this may result in damage to component parts and create toxic fumes. Such agents also pose a fire and explosion hazard.
- ▶ Do not use solvent based cleaning agents, e.g. those containing benzene, to clean the outside surfaces of this machine. They can cause damage to plastic surfaces.
- ▶ Only use dyes specified by the manufacturer as being suitable for use in a domestic washing machine. Always observe the manufacturer's instructions carefully.
- ▶ Colour run and dye removers contain sulphur compounds which can cause damage such as corrosion. Do not use these products in this machine.
- ▶ If detergent comes into contact with the eyes, rinse them thoroughly with lukewarm water immediately. If swallowed, seek medical assistance immediately and retain the packaging or label for reference. Those with skin problems or sensitive skin should avoid their skin coming into contact with detergent.

Warning and Safety instructions

Accessories

▶ Accessory parts may only be fitted when expressly approved by Miele. If other parts are used, guarantee, performance and product liability claims will be invalidated.

Miele cannot be held liable for damage caused by non-compliance with these Warning and Safety instructions.

Operating the washing machine

Control panel

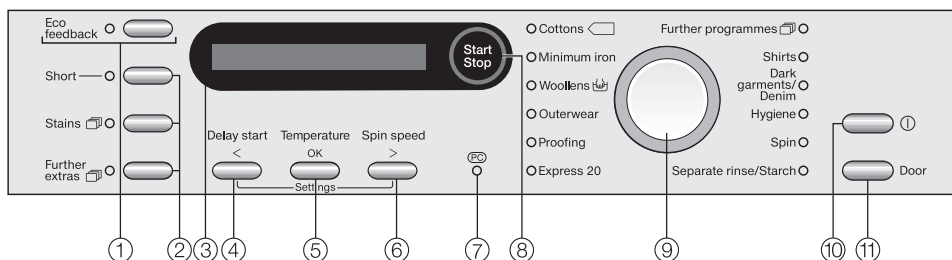

① Eco feedback button

See "Eco feedback" in "Washing environmentally and economically" for more details about this function.

② Extra option buttons

Various Extra options can be added to the washing programmes.

③ Display

See the following page for more information.

④ Delay start button (<)*

For delaying the start time of a programme.

⑤ Temperature button (OK)*

For selecting a temperature.

⑥ Spin speed button (>)*

For selecting the final spin speed or *Rinse hold* (👉) or *No spin* (🛑) (No spin).

* (</OK/>) = These have a second function, please see the following page

⑦ PC/Optical interface

This is used by service technicians to run diagnostic checks on your machine and can also be used to update programming data in the future.

⑧ Start/Stop button

For starting the programme selected and cancelling a programme once it has started.

⑨ Programme selector

For selecting a programme. The indicator light next to the selected programme will come on. The programme selector can be turned clockwise or anti-clockwise.

⑩ ① Button

For switching the washing machine on and off.

To save energy, the washing machine will switch itself off automatically 15 minutes after the end of the programme/anti-crease phase or after being switched on, if no other selection is made.

⑪ Door button

Opens the machine door.

Operating the washing machine

Second function of the Delay start (<), Temperature (OK) and Spin speed (>) buttons

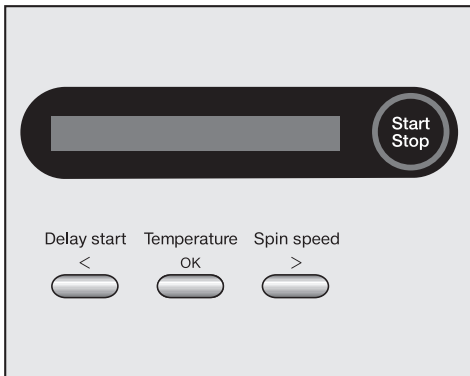

These buttons have a second function when *Further programmes*  is selected and also in the Settings. The second function is represented by symbols in the display.

- The *Delay start* (<) button scrolls through the list of options to the right or decreases values.
- The *Spin speed* (>) button scrolls through the list of options to the left or increases values.
- The *Temperature* (OK) button confirms the programme selected, the value set or opens the sub menu of the Setting selected.

Programme duration

After the start of a programme, the estimated programme duration will appear in the display in hours and minutes.

When delay start is being used, the programme duration will appear after the delay start time has elapsed.

During the first 8 minutes the washing machine measures how much water is being absorbed by the laundry and uses this to calculate the load. The programme duration may be longer or shorter depending on this absorbency rate.

Delay start

The delay start time selected will appear in the display.

After the machine has started, the delay start time counts down. If the delay start time is more than 10 hours, it will count down by the hour. If it is less than 9 hours and 59 minutes it will count down minute by minute.

Once the delay start time has elapsed, the programme will begin and the estimated programme duration will appear in the display.

Settings

The Settings can be used to tailor machine to suit your personal preferences.

Operating the washing machine

Optional programme packages

You can have additional programme packages (containing a number of individual programmes) loaded into your machine.

These have to be downloaded by a Miele service engineer.

The following programme packages can be downloaded into your machine if they were not supplied with your machine ex-works (depending on model):

Eco

- Cottons Eco
- Cottons Eco plus
- Minimum iron Eco

Home

- Curtains
- Down filled items
- Pillows
- Silks/lingerie

Home XL

- Bathrobes
- Curtains
- Down filled items
- Pillows

Hygiene & kids

- Kids' quick wash
- Minimum iron hygiene
- Toy building blocks

Medic

- First wash
- Minimum iron hygiene
- Nappies
- Pillows

Nursery

- Baby towelling
- Baby Wear
- Kids' sleeping bags
- Nappies
- Soft toys

Sport & leisure

- Bathrobes
- Sportswear
- Trainers

The new programmes can then be selected by turning the programme selector to *Further programmes* .

Before using for the first time

Before using the machine for the first time ensure that it is correctly installed and connected. Also check that the drain filter is securely tightened to prevent the risk of leaks during use. See "Installation and connection".

This washing machine has undergone a complete functional test at the factory and there will be some residual water in the drum from this process.

For safety reasons, spinning is not possible until the machine has been prepared for using for the first time. To activate the spinning function you must run a wash programme without laundry and without detergent.

Using detergent could result in an excessive build-up of foam.

This also activates the ball valve. The ball valve prevents detergent escaping from the suds container into the sump during a wash programme, thus making maximum use of the detergent.

- Press the  button.

If the washing machine is being switched on for the first time, the welcome screen will appear.

The welcome screen will appear in the display every time the washing machine is switched on until a programme lasting longer than 1 hour has been completed.

Setting the language

You will be asked to select the language you require for the display. It is possible to change the language at any time via the Settings.

 deutsch

- If the language shown is not the one you want, select the language you do want by turning the programme selector. Confirm your selection by pressing the *Start/Stop* button.

Reminder to remove transport bars

To avoid the risk of damage, the transport bars must be removed before the machine is used for the first time. See "Installation and connection" for instructions on how to do this.

- After removing the transport bars (if this has not already been done by your fitter), press the *Start/Stop* button.

Running your first programme

Cottons  will be selected automatically. Run this programme without any laundry and without detergent.

- Open the stopcock.
- Press the *Start/Stop* button.
- At the end of the programme switch the machine off.

The washing machine is now ready for use.

Washing environmentally and economically

Energy and water consumption

- Water consumption and energy usage are determined by the size of the load.
To make the most out of your machine, load the maximum dry load for the programme you are using.
- When smaller amounts of laundry are washed, the automatic load recognition system will reduce the amount of water, time and energy used. This may mean that the time left shown in the display is adjusted during the course of the wash programme.
- Use the *Express 20* programme for small loads.
- Modern detergents make it possible to wash at lower temperatures (e.g. 20°C). Washing using lower temperature settings will save energy.
- To maintain the hygiene of the washing machine, carry out a hot wash (60°C or above) using powder detergent at regular intervals. The **Hygiene Info** message will appear in the display to remind you to carry out a hot wash.

Detergent

- Do not exceed the amounts of detergent recommended by the manufacturer on the packaging.
- Adjust the dosage to the degree of soiling of the laundry.
- Reduce the amount of detergent with smaller loads (approx. $\frac{1}{3}$ less than the amount recommended can be used when washing a half load).

Choosing the correct Extra option (Short, Pre-wash and Soak)

Select:

- A wash programme together with the *Short* extra option for light soiling where there are no obvious marks.
- A wash programme without any extra options for normal to heavy soiling with visible staining.
- A wash programme together with the *Soak* extra option for very heavily soiled laundry.
- The *Pre-wash* extra option for laundry with large amounts of dirt (e.g. dust, sand).

When drying with a tumble dryer

Selecting the highest possible spin speed for the wash programme will save energy when drying in a tumble dryer afterwards.

Washing environmentally and economically

Eco feedback

The *Eco feedback* button is used for calling up information about the machine's energy and water consumption.

The *Eco feedback* button must be held in to display this information.

Pressing the *Eco feedback* button gives two different types of information:

- Before and during the programme an estimate is shown.
- At the end of the programme it shows actual water and energy consumption.

1. Estimate

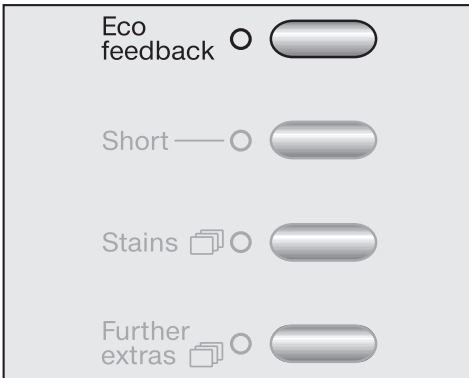

- Press and hold the *Eco feedback* button after selecting the programme.

The probable consumption levels will then be displayed by a bar chart.

Energy IIII Water II

The more bars (I) in the display, the more energy or water will be used.

The estimate is influenced by the programme selected, the temperature and any Extra options selected.

2. Actual usage

The actual amount of energy and water used can be shown in the display before opening the door at the end of a programme.

- Press and hold the *Eco feedback* button.

1.5 kWh 55 l

Opening the door or automatic switching off at the end of the programme resets the data to the estimated values.

Total usage

The *Total usage* Setting gives details of energy and water consumption over a period of time.

Energy consumption is always given in whole numbers, rounded up or down.

For more information see "Settings".

Brief instructions

The headings numbered ①, ②, ③, . . . show the operating sequence and can be used as brief instructions.

① Sort the laundry

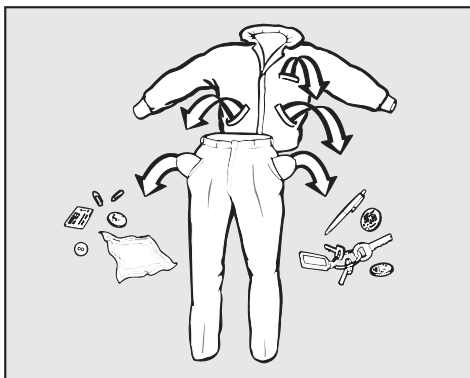

- Empty all pockets.

⚠ Foreign objects (e.g. nails, coins, paper clips, etc.) can cause damage to garments and components in the machine.

- Badly soiled areas, stains etc. should be cleaned as soon as possible, preferably whilst still fresh. Spillages should be carefully dabbed off using a soft colourfast cloth. Do not rub!

Badly soiled areas can be pre-treated with liquid detergent, stain removers etc. first, following the manufacturer's instructions. With particularly stubborn stains ask your dry cleaner for advice.

⚠ If you use a solvent-based cleaning agent (e.g. one containing benzene) to pre-treat a stain, make sure that any plastic parts (e.g. buttons) are protected, and that the cleaning agent is rinsed off before washing the garment in the machine.

⚠ Do not use solvent-based cleaning agents in or on this machine.

- Sort the laundry by colour and by care label. Most garments have a textile care label in the collar or side seam.

Dark textiles often contain excess dye and should be washed separately several times before being included in a mixed load. Always wash whites and coloureds separately.

- Curtains: Remove lead weights first or place in a laundry bag.
- Underwiring and collar stiffeners: Any loose wiring in bras, shirt collar stiffeners, etc. should be removed or sewn in.
- Knitted garments, trousers and jeans, T-shirts and sweat shirts: Turn inside out, if recommended by the manufacturer.
- Close any zips, fasten hooks and eyes etc before washing.
- Fasten duvet covers etc. to prevent small items from being rolled up inside them.

Do not wash any items in this machine which are specified by the manufacturer as **not washable** on the care label. (☒ symbol)

How to wash correctly

2 Switch on the washing machine

3 Load the drum

- Press the *Door* button to open the drum door.
- Unfold the laundry and load loosely into the drum. Mixing both large and small items gives better wash results and also helps distribute the load evenly during spinning.

The most efficient use of energy and water is achieved when a full load is washed. However, do not overload as this causes creases and reduces cleaning efficiency.

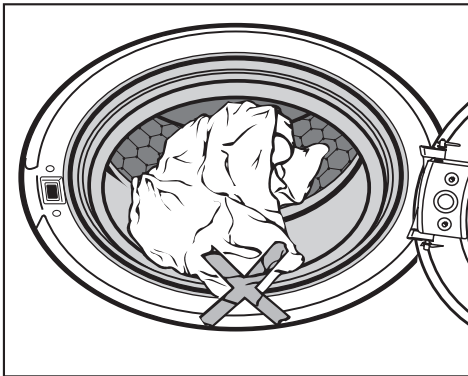

- Shut the door with a gentle swing.

Make sure that items do not get caught between the drum door and the seal.

4 Select a programme

A. Selecting programmes using the programme selector

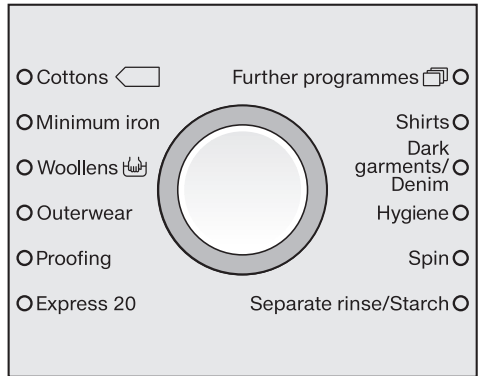

- Turn the programme selector clockwise or anti-clockwise to the required programme. The programme indicator light for the programme selected will come on.

Further programmes are available under the programme setting *Further programmes*.

How to wash correctly

B. Selecting programmes using the programme selector at the *Further programmes* position and the display

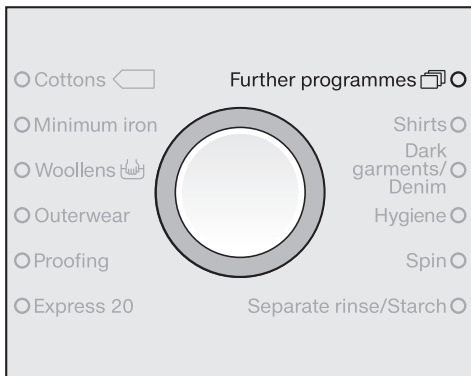

- Turn the programme selector clockwise until the indicator light for *Further programmes* comes on.
- The following will appear in the display:

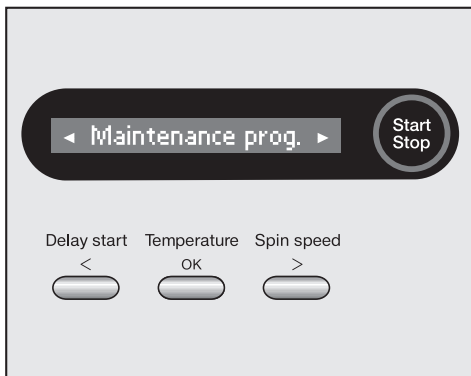

- Scroll through the list using the *Delay start* (<) and *Spin speed* (>) buttons.
- When the programme you want shows in the display, confirm your selection by pressing the *Temperature* (OK) button.

5 Select a temperature / spin speed

The suggested temperature and/or spin speed can be changed.



- Press the *Temperature* button to alter the temperature and press the *Spin speed* button to alter the spin speed.

6 Select any Extra option(s)

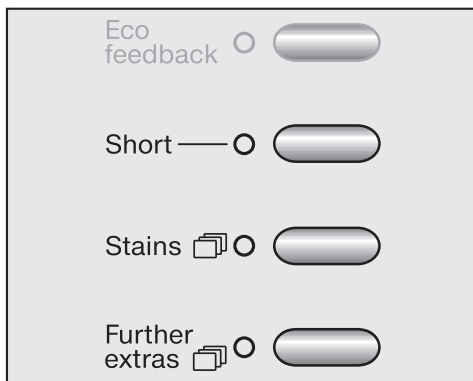

- Select any Extra options by pressing the appropriate button. The relevant indicator light will come on to show which Extra option has been selected.

Not all Extra options are suitable for use with every programme.

You can only select Extra options which are compatible with the programme being used.

See "Extra options" for more information.

How to wash correctly

7 Select Delay start (if required)

The start of a programme can be delayed from 15 minutes up to 24 hours, allowing you to make use of night-time economy electricity rates, for example.

See "Delay start" for more information.

8 Add detergent

It is important to dispense the correct amount, because... .

... too little detergent results in:

- Laundry not getting properly clean and with time it may become grey and hard to the touch.
- Greasy particles clinging to the laundry.
- Limescale deposits on the heater elements.

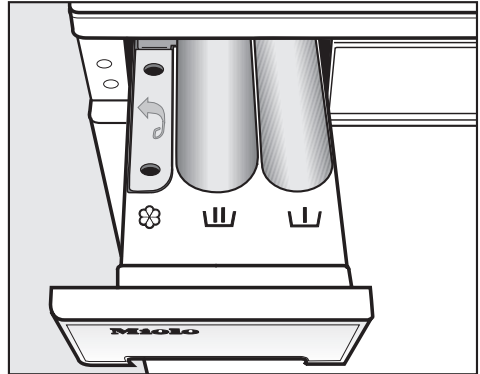

... too much detergent results in:

- Excessive foam which causes a low level of agitation and poor wash, rinse and spin results.
- Higher water consumption (an additional rinse cycle will automatically switch in).
- A burden to the environment.



- Pull out the detergent drawer and add detergent to the compartments as follows:



Detergent for the pre-wash. Divide the total recommended amount as follows: add $\frac{1}{3}$ to compartment  and $\frac{2}{3}$ to compartment 



Detergent for the main wash, including Soak if selected



Fabric conditioner and liquid starch

- Close the detergent drawer.

See "Detergent" for further information on detergent dispensing.

9 Start the programme

- Press the flashing *Start/Stop* button.

If a delay start time has been selected, then this will count down in the display. At the end of the delay start time or immediately after the programme has started (if no delay start time has been selected) the estimated programme duration will appear in the display. During the first 8 minutes the machine measures how much water is being absorbed by the laundry. The programme duration may be longer or shorter depending on this absorbency rate.

The programme sequence is also shown in the display. The washing machine shows you when each section of the programme is reached.

10 Remove the laundry when the programme has finished

In the anti-crease phase after the programme has finished, the following will appear alternately in the display:

0:00 Anti-crease

and

0:00 Finish

- Press the *Door* button to open the drum door.

The washing machine will switch off automatically 15 minutes after the end of the anti-crease phase. You will need to press the **⏻** button to switch it back on again.

- Remove the laundry.

Check that all items have been removed from the drum. Items left in the drum could discolour other items in the next wash or become discoloured themselves.

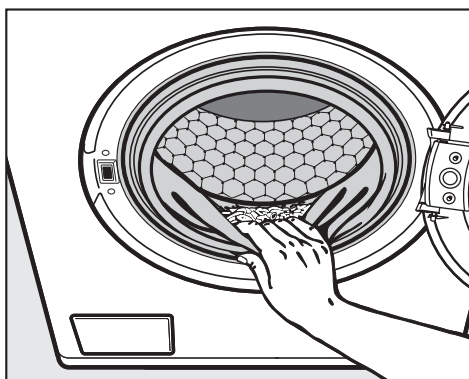

- Check the folds in the door seal for any small articles, e.g. buttons, which might be lodged there.
- Switch the machine off with the **⏻** button.
- Close the drum door. Otherwise there is the danger of objects being placed inadvertently in the drum. If these remained unnoticed and were washed in the next load, they could damage the laundry.

Spinning

Final spin speed

Programme	rpm
Cottons	1600
Minimum iron	1200
Woolens 	1200
Outerwear	800
Proofing	1000
Express 20	1600
Maintenance prog.	–
Down duvets	1200
Delicates	600
Automatic plus	1200
Shirts	600
Dark garments / Denim	1200
Hygiene	1600
Spin	1600
Separate rinse/Starch	1200

You can reduce the final spin speed. However, you cannot select a final spin speed higher than that shown in the chart above.

Rinse and interim spin

There is a spin after the main wash and between the rinses. A reduction in the final spin speed will also reduce the interim spin speed. If a spin speed of less than 700 rpm is selected for a *Cottons* programme, an additional rinse is introduced.

To omit the final spin (Rinse hold)

■ Select the Rinse hold () setting using the *Spin speed* button. The laundry will not be spun and will remain suspended in the final rinse water. This reduces creasing if the laundry is not going to be removed from the drum immediately after the end of the programme.

– To start the final spin:

The washing machine will display the maximum spin speed possible. You can select a spin speed lower than this. Start the final spin by pressing the *Start/Stop* button.

– To end the programme:

Press the *Door* button. The water will drain away. Press the *Door* button again to open the door.

To omit rinse and interim spin and the final spin (No)

■ Select the *No * setting using the *Spin speed* button.

The laundry is not spun after the final rinse. The water will drain away and the machine will go straight into the anti-crease stage.

With some programmes an additional rinse is introduced if this setting is selected.

Delay start allows you to choose when you want the programme to start. The start of a programme can be delayed from 15 minutes up to a maximum of 24 hours, allowing you to make use of night-time economy electricity rates, for example.

Selecting delay start

- Press the *Delay start* button. The following will appear in the display:



0:15 ◊ 60° 1600

- Each press on the *Delay start* button increases the start time:
 - in 15 minute steps up to 1 hour,
 - in 30 minute steps up to 10 hours,
 - in 1 hour steps from 10 hours upwards.

If you keep the *Delay start* button pressed in, the time will continue to count up to 24 hours.

Activating delay start

- Press the *Start/Stop* button to activate delay start. The following will appear in the display:



4:30 ◊ until start

After the delay start time has elapsed, the washing programme will start and the estimated programme duration and the programme sequence will show in the display.

Altering delay start

You can change the delay start time at any time by pressing the *Delay start* button.





















Cancelling delay start before delay start has been activated

- Press the *Delay start* button until **24 h** is showing in the display. Then press the *Delay start* button again briefly to cancel delay start.

If you cancel delay start after the *Start/Stop* has been pressed, the washing programme will start immediately.

Programme chart











Please refer to the separate booklet for information on programmes available as additional programme packages.

Cottons     *		cold to 90°C	Max. load 8.0 kg
Use for	Cotton, linen or cotton mix fabric, e.g. table linen, towelling, underwear, T-shirts etc.		
Note	<p>The 60°/40°C programmes differ from the /  programmes as follows:</p> <ul style="list-style-type: none"> - Shorter programme duration - Longer temperature holding times - Higher energy consumption <p>Where particularly high levels of hygiene are required please select a temperature of 60°C or higher.</p>		
Cottons		 / 	Max. load 8.0 kg
Use for	Normally soiled cotton garments		
Notes	<ul style="list-style-type: none"> - These settings are the most efficient in terms of energy and water consumption for washing cottons. - With  the actual wash temperature reached will be lower than 60°C although the wash performance is the same as with the standard Cottons 60°C programme. 		
Note for test institutes:			
The test programme conforms to EN 60456 and the energy label with Directive 1061/2010.			
Minimum iron		cold to 60°C	Max. load 3.5 kg
        *			
Use for	Synthetic, mixed fibre and easy care cotton. If fabrics have a high proportion of man-made fibres it is advisable to programme the machine for "Gentle action".		
Note	Reduce the spin speed for fabric which creases easily.		
Woolens    *		cold to 40°C	Max. load 2.0 kg
Use for	Machine-washable or hand-washable wool or wool blend fabrics. If the care label does not specify a temperature, wash using the cold setting.		
Note	Reduce the spin speed for items which crease easily.		

Programme chart

Outerwear		cold to 40°C	Max. load 2.5 kg
Use for	Outerwear made from membrane fabric such as Gore-Tex®, SYMPATEX®, WINDSTOPPER® etc.		
Notes	<ul style="list-style-type: none"> – Zip up jackets before washing. – Do not use fabric conditioner. – If wished these garments can also be re-proofed using the <i>Proofing</i> programme. Proofing should not be done every time the garment is washed. 		
Proofing		40°C	Max. load 2.5 kg
Use for	Treating microfibre fabric, skiwear, and table linen made from mainly synthetic fibres to provide a water and stain resistant finish.		
Notes	<ul style="list-style-type: none"> – The items should be freshly laundered and spun or dried before proofing. – For best results, the items should be heat-treated afterwards, either in a tumble dryer or by ironing. 		
Express 20  *		cold to 40°C	Max. load 3.5 kg
Use for	Cotton and minimum iron garments that have hardly been worn or are only very lightly soiled.		
Note	The Short extra option will be activated automatically.		
Maintenance prog.		75°C	Empty
<p>With frequent washing at low temperatures, there is the danger of a build-up of bacteria in the washing machine.</p> <p>Cleaning the washing machine will significantly reduce bacteria, fungus and biofilm and help prevent the build-up of unpleasant odours.</p>			
Notes	<ul style="list-style-type: none"> – Optimum results can be achieved by using Miele machine cleaner. Alternatively a universal powder detergent can be used. – Dispense the machine cleaner or universal powder via the detergent compartment. – Do not load any laundry. The drum must be empty for the maintenance programme. 		

Programme chart

Down duvets		cold to 60°C	Max. load 2.5 kg 1 down duvet 2.20m x 2.00m
Use for	Down filled duvets.		
Note	Please observe the manufacturer's care label.		
Delicates       *		cold to 60°C	Max. load 2.5 kg
Use for	Delicate garments made from synthetic fibre, mixed fibre, rayon and easy care cotton. Curtains, including net curtains, specified as machine-washable by the manufacturer.		
Notes	<ul style="list-style-type: none"> – Dust in curtains usually makes using a programme with pre-wash advisable. – Select <i>No</i>  (No spin) for items which crease easily. 		
Automatic plus     *		cold to 40°C	Max. load 5.0 kg
Use for	Mixed loads of garments suitable for the <i>Cottons</i> and <i>Minimum iron</i> programmes. Sort according to colour.		
Note	The wash parameters (e.g. water level, wash rhythm and spin speed) are adjusted automatically in this programme to ensure the best possible care and wash result for each item.		
Shirts		cold to 60°C	Max. load 2.0 kg
Notes	<ul style="list-style-type: none"> – Pre-treat collars and cuffs if necessary. – Wash silk shirts and blouses in the <i>Delicates</i> programme. 		
Dark garments / Denim		cold to 60°C	Max. load 3.0 kg
Use for	Black and dark garments made from cotton, mixed fibre or denim.		
Notes	<ul style="list-style-type: none"> – Wash inside out. – Denim often contains excess dye and may run during the first few washes. Wash light and dark coloured items separately. 		

* Please note that the "buckets" represent garment care label symbols. See "Garment care label symbols".

Programme chart

Hygiene		30°C to 90°C	Max. load 7.0 kg
Use for	Cotton and linen fabric which have been in direct contact with the skin, e.g. underwear, nappies, towelling, bed linen, pillow and mattress covers or where high standards of hygiene are required.		
Notes	<ul style="list-style-type: none"> – For optimum hygiene results select a temperature of 60°C or above. – Observe the manufacturer's care label. 		
Spin			
Notes	<ul style="list-style-type: none"> – To drain only: Select <i>No</i> Ⓞ (No spin). – Make sure you select the appropriate spin speed. 		
Separate rinse/Starch		Max. load 7.0 kg	
Use for	<ul style="list-style-type: none"> – Rinsing hand-washed items. – Starching table cloths, serviettes and workwear 		
Notes	<ul style="list-style-type: none"> – Reduce the spin speed for fabrics which crease easily. – Items for starching should be freshly laundered but not treated with fabric conditioner. – You can achieve a particularly good rinse result with two rinses by activating the <i>Water plus</i> extra option. For this, the <i>Extra rinse</i> option of the <i>Water plus</i> Setting must be activated (see "Settings" at the end of this booklet). 		

Extra options

Extra options are selected or deselected by pressing the appropriate button and via the display.

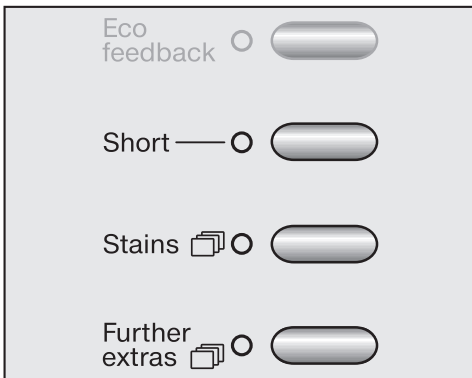

- Press the *Short* button or the *Stains* button and/or the *Further extra options* button.

Short

For light to normal soiling with no visible staining.

This shortens the programme running time.

Stains

There is a choice of various types of stains for achieving the optimum wash result with stain removal. The wash programme is optimised for the type of stain. One stain type can be selected per wash programme.

If the "Short" extra option was selected previously, it will be deselected automatically.

Press the *Stains* button again to come out of the *Stains* sub-menu.

Further extras

The Further extras sub-menu will open in the display.

Extra options available for that programme are shown in the display.



- Scroll through the list using the *Delay start* (<) and *Spin speed* (>) buttons. Press the *Temperature* (OK) button to select the Extra option displayed.

Only one further Extra option may be selected.

The Extra option can be deselected by pressing the *Further extras* button again.

Water plus

The water level in the main wash and the rinses will be increased.

You can select other settings for *Water plus*. These are described in "Settings".

Pre-wash

For laundry with large amounts of dirt
e.g. dust, sand.

Soak

For heavily soiled items with protein
stains.

You can select a soak time of between
30 minutes and 2 hours in 30 minute
steps. This is described in "Settings".

The default setting is 2 hours.

Extra quiet

If using your washing machine during
quiet periods, you can reduce the noise
levels even more.

If the *Extra quiet* Extra option is
selected, the machine will activate the
Rinse hold option and not spin. The
programme duration is longer.

To deactivate Rinse hold

- Use the Spin button to select the spin
speed you want.

By using Delay start you can make sure
the final spin occurs outside quiet
periods in the home.

Extra options





The following Extra options can be selected in addition to the programme:

	Short	Stains	Water plus	Pre-wash	Soak	Extra quiet
Cottons	+	+	+	+	+	+
Minimum iron	+	+	+	+	+	+
Woollens handcare 						+
Outerwear	+	+	+	+	+	+
Proofing						+
Express 20		+ ¹⁾		+		+
Maintenance prog.						
Down duvets				+		
Delicates	+	+			+	+
Automatic plus			+			+
Shirts	+	+	+	+	+	+
Dark garments/Denim	+	+			+	+
Hygiene			+	+	+	+
Spin						
Separate rinse/Starch				+		+

Garment care label symbols



Washing

The figure quoted in the bucket is the maximum temperature the garment can be washed at. The number of bars under the symbol indicates the level of agitation permitted.

	No bar under the symbol: = normal agitation
	One bar under the symbol: = reduced agitation
	Two bars under the symbol: = much reduced agitation
	Hand wash (if no temperature is specified use the lowest temperature or cold)
	Do not wash





Drying

The number of dots indicates the drying temperature





	Normal temperature
	Low temperature
	Do not tumble dry

Ironing



The number of dots indicates the ironing temperature

	Hot iron (max sole plate temp. approx. 200°C)
	Medium hot iron (max sole plate temp. approx. 150°C)
	Cool iron (max sole plate temp. approx. 110°C). Do not steam iron garments carrying this symbol.
	Do not iron



























Professional cleaning

	Dry clean only. The letters indicate the type of cleaning agent required.
	
	Professional Wet Clean only
	Do not dry clean

Bleaching

	Any oxidising bleaching agent can be used
	Only use an oxygen based bleach or a non-chlorine bleach
	Do not bleach

Programme sequence

	Main wash		Rinses		Spinning	
	Water level	Wash rhythm	Water level	Rinses	Interim spin	Final spin
Cottons		Ⓐ		2-4 ¹⁾²⁾	✓	✓
Minimum iron		Ⓒ		2-3 ³⁾	✓	✓
Woolens 		Ⓕ		2	✓	✓
Outerwear		Ⓓ		3	✓ ⁴⁾	✓
Proofing		Ⓓ	–	–	–	✓
Express 20		Ⓑ		1-3 ³⁾	✓	✓
Maintenance prog.		Ⓐ		2	–	–
Down duvets ⁵⁾		Ⓓ		3	–	✓
Minimum iron		Ⓒ		2-3 ³⁾	✓	✓
Automatic plus		Ⓐ Ⓑ Ⓒ		2-3 ³⁾	✓	✓
Shirts		Ⓒ		2	–	✓
Dark garments / Denim		Ⓑ		3	–	✓
Hygiene		Ⓑ		3-4 ²⁾	✓	✓
Spin	–	–	–	–	–	✓
Separate rinse/ Starch	–	–		1	–	✓
Please see next page for description of the symbols						

 = Low water level

 = Medium water level

 = High water level

(A) = Intensive rhythm

(B) = Normal rhythm

(C) = Gentle rhythm

(D) = Sensitive rhythm

(E) = Ultra sensitive rhythm

(F) = Handwash rhythm

This machine has fully electronic controls with automatic load recognition. It takes in the right amount of water required for the programme depending on the amount of laundry and its absorbency rate. This means that programme cycles and durations can vary.

The programme sequences outlined in the chart are based on the basic programme with a full load. Extra options which can be selected have not been taken into account.

The display shows the stage the programme has reached.

Special features in the programme sequences:

Anti-crease:

At the end of every programme, with the exception of the Woollens programme, the drum continues to turn at intervals for up to 30 minutes to help prevent creasing.

The door can be opened and laundry removed at any time during the anti-crease phase.

- 1) A second rinse is carried out when a temperature between 60°C and 90°C has been selected. A third rinse is carried out when a temperature below 60°C is selected.
- 2) A third or fourth rinse is carried out if:
 - there is too much foam in the drum
 - a spin speed lower than 700 rpm has been selected
 - The spin speed has been deselected.
- 3) A third rinse is carried out if:
 - The spin has been deselected.
- 4) In the *Outerwear* programme, laundry is only spun after the main wash.
- 5) Run-up to spin: A run-up to spin is carried out before the wash process begins, to deflate down-filled items. Subsequent water intake for the main wash is through compartment .
- 6) Pre-rinse: A pre-rinse without detergent is carried out automatically to remove dust.

Changing the programme sequence

Cancelling a programme

You can cancel a programme at any time after it has started.

- Press the *Start/Stop* button.

Cancel programme

- Press the flashing *Start/Stop* button again.

The suds will be pumped away.

If you want to remove the laundry:

- Press the *Door* button.

If you want to select a different programme:

- Switch the machine off with the ① button.
- Switch the washing machine back on again.
- Check that there is still detergent in the detergent drawer. Add detergent, if necessary.
- Select a new programme.

Interrupting a programme

- Switch the machine off with the ① button.

To continue with the same programme:

- Switch the machine back on again with the ① button.

Making changes to a programme

After the start of a programme it is no longer possible to select a different programme.

Temperature

It is possible to select a different temperature up to 5 minutes after the programme has started, except with the *Cottons* programme.

- Press the *Temperature* button.

Spin speed

It is possible to change the spin speed up until the final spin begins.

- Press the *Spin speed* button.

Extra options

It is possible to select or deselect the *Short*, *Water plus* and *Extra Quiet* Extra options up to five minutes after the programme has started.

A programme cannot be cancelled or changed if the safety lock has been activated.

Changing the programme sequence

Adding or removing laundry after a programme has started

- Press the *Door* button to open the drum door.
- Add or remove items.
- Close the drum door.

The programme will continue automatically.

Please note:

Once a programme has started the machine cannot recognise any adjustment to the load.

For this reason, if laundry is added or removed after the start of a programme, the machine will always complete the programme cycle assuming a full load which can lead to an increase in the programme duration shown in the display.

The door cannot be opened, if:

- the suds temperature is above **55°C**.
- the water is above a certain level.
- the programme has reached the *Final spin* stage.

If you press the *Door* button when the above conditions are present, the following will appear in the display:

 Door locked

Safety lock

The safety lock prevents the machine from being opened and programmes from being cancelled during a wash programme.

To activate the safety lock

- Press and hold in the *Start/Stop* button after the programme has started.

Stop or in 3 secs 

- Keep the *Start/Stop* button pressed in until the time has elapsed and the following appears in the display:

Locked 

The safety lock is now activated. It is deactivated automatically at the end of the programme.

To deactivate the safety lock

- Press and hold in the *Start/Stop* button after the programme has started.

Unlock in 3 secs 

- Keep the *Start/Stop* button pressed in until the time has elapsed and the following appears in the display:

Unlocked 

Detergent

The correct detergent



All modern detergents produced for automatic washing machines are suitable. Use dispensing aids, e.g. balls, if these are supplied with the detergent. Tablets are suitable for full loads, but note that it may be impractical to reduce tablets for smaller loads. Some tablets do not dissolve as rapidly as others, and may not be suitable for programmes with short durations.

Do not use biological detergents on silk as the enzymes may damage the silk! Instructions for use and recommended dosage amounts are given on the detergent packaging.

See "Optional accessories" at the end of this booklet for details of Miele branded care products including detergents and fabric conditioner.

	Universal detergent	Detergent for coloureds	Detergent for delicates	Specialist detergent*	Proofing agent**	Fabric conditioner
Cottons	X	X	–	–	–	X
Minimum iron	X	X	–	–	–	X
Woolens 	–	–	–	X	–	X
Outerwear ¹⁾	–	–	X	X	–	–
Proofing	–	–	–	–	X	–
Express 20 ¹⁾	X	X	–	–	–	X
Maintenance programme	X	–	–	X	–	–
Delicates	X	X	X	–	–	X
Down duvets ¹⁾	–	X	X	X	–	–
Automatic plus	X	X	–	–	–	X
Shirts	X	X	–	–	–	X
Dark garments / Denim ¹⁾	X	X	X	–	–	X
Hygiene ²⁾	X	–	–	–	–	X
Separate rinse/ Starch	–	–	–	X	–	X

¹⁾ Liquid detergent

For programmes with a pre-wash you will need to purchase a special container from the Miele Spare Parts Department which sits in the main wash compartment . Add liquid detergent to this container for the main wash and to compartment  for the pre-wash

²⁾ Use powder detergent

* Specialist detergent

Detergent designed specifically for the wash programme or type of fabric.

** Only use proofing agents containing fluorochemical compounds which are stated by the manufacturer as being "suitable for use on membrane textiles".

Do not use proofing agents which contain paraffin. Add proofing agents to compartment .

Detergent

The right amount to dispense will depend on the following:

- The quantity of laundry
- The soiling level of the laundry

Lightly soiled

No visible dirt or stains. Possibly slight body odour.

Normally soiled

Visibly dirty and/or just a few slight stains.

Heavily soiled

Visible dirt and stains and/or dried on soiling.

- The water hardness level.
Check with your local water supplier if you do not know the hardness level in your area.

Water hardness levels

Hardness scale	Hardness level mmol/l	German °d
I (soft)	0 - 1.5	0 - 8.4
II (medium)	1.5 - 2.5	8.4 - 14
III (hard)	Above 2.5	Above 14

Refill packs of detergent

When purchasing detergent buy refill packs wherever possible. This helps reduce the amount of waste packaging.

Water softener

A water softener can be used to cut down on the use of detergents in hard water areas. Dispense according to the amount specified on the packaging. First add detergent and then the water softener.

Miele branded water softening tablets are available from the Miele Spare Parts Department or via the internet on www.miele-shop.com.

Use a quantity of detergent as for soft water.

Washing with several components

If you wash using several components (e.g. special application detergents), we recommend always dispensing the agents into compartment  in the following order:

1. Detergent
2. Water softeners
3. Stain remover

This way the agents are distributed more evenly.

Fabric conditioners and liquid starch

Starch

Stiffens and gives body to items of laundry, e.g. shirts, tablecloths and bed linen.

Fabric conditioners

Make garments soft to handle and help prevent static cling when tumble drying.

Automatic dispensing of fabric conditioner or liquid starch to laundry at the end of a programme

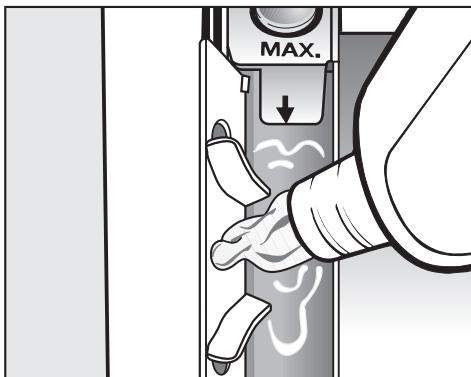

- Add the fabric conditioner or liquid starch to compartment ☼. **Do not exceed the maximum level mark.**

It will be dispensed automatically in the last rinse. At the end of the programme a small amount of water remains in the fabric conditioner compartment ☼.

If starching frequently, thoroughly clean the dispenser compartment, especially the siphon tube and fabric conditioner channel, regularly. See "Cleaning the detergent dispenser drawer". Do not use powder starch formulations or viscous liquid starch in the ☼ compartment as it will clog up.

Adding fabric conditioner or starch separately

- Dispense in accordance with manufacturer's instructions on the packaging.
- Dispense liquids into the ☼ compartment and powder or viscous formulations into the ▮ compartment.
- Turn the programme selector to *Separate rinse/Starch*.
- Select a spin speed.
- Press the *Start/Stop* button.

Colour run and dye removers/dyes

- Do not use colour run or dye removers in this machine.
- Dyes suitable for use in domestic washing machines can be used. However, please note that the salt used in the dyeing process can cause corrosion to stainless steel components in the machine if you dye frequently. Follow the manufacturer's instructions carefully.

Cleaning and care

A range of Miele branded cleaning and conditioning products is available to order from Miele or the internet at www.miele-shop.com.

Cleaning the drum (Hygiene info)

Washing at low temperatures and/or using liquid detergent can cause bacteria and unpleasant odours to build up in the machine. The washing machine can be cleaned using the *Maintenance programme*. This should be done regularly, at the latest when the **Hygiene Info** message appears in the display.

⚠️ Disconnect the machine from the mains electricity supply and withdraw the plug from the socket before cleaning the machine.

⚠️ The machine must not be hosed down.

External casing and fascia panel

- Clean the casing using a Miele E-cloth or with a mild non-abrasive cleaning agent or soap and water using a well wrung-out cloth. Wipe dry with a soft cloth.
- The drum can be cleaned with a proprietary stainless steel cleaning agent, following the manufacturer's instructions on the packaging.

⚠️ Do not use solvents, abrasive cleaners, glass cleaners or multi-purpose cleaning agents. These could damage plastic surfaces and other parts.

Cleaning the detergent dispenser drawer

The pre-wash and main wash compartments of the detergent dispensing drawer are self-cleaning. For hygiene reasons, clean the entire drawer at regular intervals.

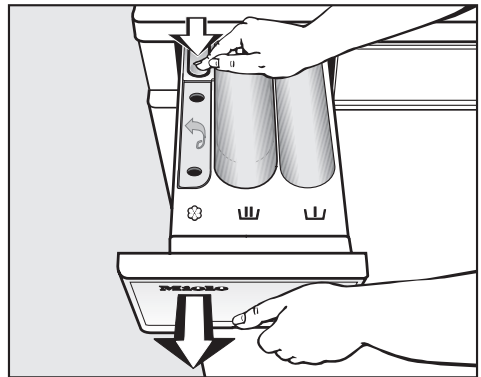

- Pull out the detergent dispenser drawer until a resistance is felt. Press down the release catch and at the same time pull the drawer right out of the machine.
- Clean the drawer with hot water.

- Clean the siphon.

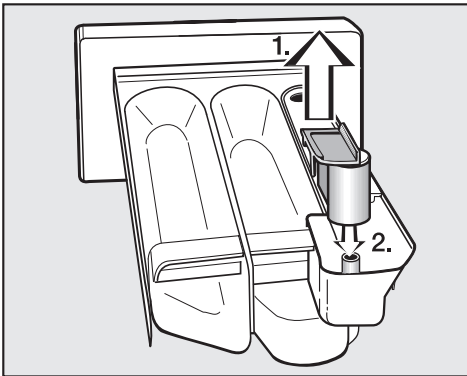

1. Remove the siphon from compartment  and rinse under hot running water. Clean the siphon tube in the same way.
2. Replace the siphon.

If starching frequently, thoroughly clean the siphon and siphon tube regularly. A build-up of liquid starch will cause them to get clogged.

- **Cleaning the detergent dispenser drawer housing**

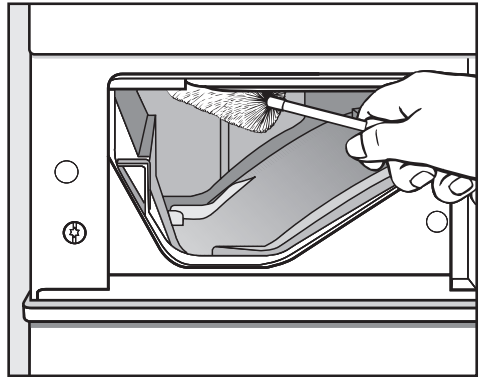

- Use a bottle brush to remove detergent residues and limescale from the jets inside the detergent dispenser drawer housing.

Cleaning and care

Cleaning the water inlet filters

The washing machine has two filters to protect the inlet valves.

These filters should be checked every six months or so, or more often if there are frequent interruptions to the water supply.

To clean the filter in the union in the open end of the inlet hose:

- First turn off the stopcock.
- Unscrew the inlet hose from the stopcock.

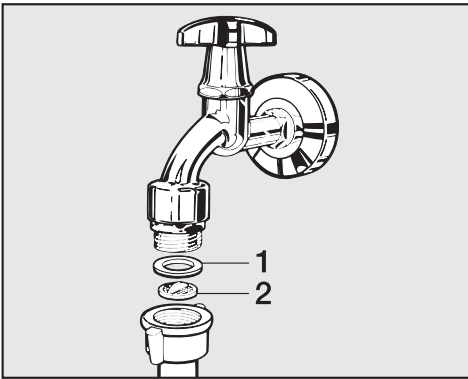

- Remove rubber seal **1** from the recess.
- Using pointed pliers, take hold of plastic filter bar **2**, remove the filter and clean it.
- Put the filter and seal back in the reverse order and reconnect the hose.
- Turn on the stopcock and check the connection is watertight. If it leaks, tighten the connection.

To clean the filter in the water inlet valve:

- Using pliers, carefully loosen the ribbed plastic nut on the inlet valve and unscrew.

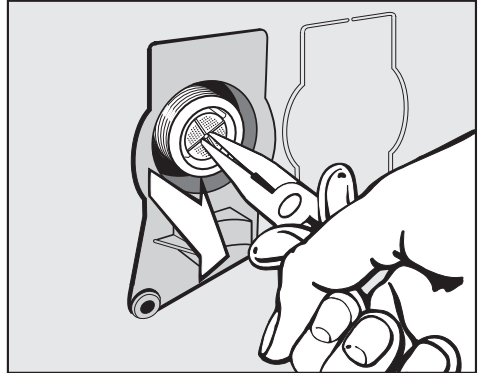

- Use pointed nose pliers to withdraw the plastic filter by the bar (see illustration). Clean, put back and secure.

The two filters **must** be put back in place after cleaning.

With the help of the following notes, minor faults in the performance of the machine, some of which may result from incorrect operation, can be put right without contacting the Service Department.





 Repair work to electrical appliances should only be carried out by a suitably qualified person in strict accordance with current local and national safety regulations. Repairs and other work by unqualified persons could be dangerous. The manufacturer cannot be held liable for unauthorised work.

The programme does not start

Problem	Possible cause	Remedy
The display remains dark, and the <i>Start/Stop</i> button indicator light does not come on.	There is no power to the machine.	Check whether <ul style="list-style-type: none"> – the mains plug is plugged in and switched on. – the fuse or circuit breaker has tripped.
	The washing machine has turned itself off automatically to save energy.	Switch the machine back on again with the  button.
You are asked to enter a code.	Access via a code has been activated.	Enter the code and confirm the entry. Deactivate the code if you do not wish this message to appear in the display the next time the machine is switched on.
The display is dark.	The display has switched off automatically to save energy (Standby mode).	Press a button. The machine will come out of standby mode.

Problem solving guide

The following fault messages appear in the display and the programme stops

Fault message	Possible cause	Remedy ①
 Drain fault	<ul style="list-style-type: none"> – The water outlet is blocked or restricted. – The drain hose has been fixed too high. 	<ul style="list-style-type: none"> – Clean the drain filter and the drain pump. – The maximum delivery head is 1 m.
 Water inlet fault	The water inlet is blocked or restricted.	Check whether <ul style="list-style-type: none"> – the stopcock is opened properly. – the inlet hose is kinked. – the water pressure is too low.
	The filter in the water inlet hose is dirty.	Clean the filter.
 Waterproof fault	The water protection system has reacted.	<ul style="list-style-type: none"> – Close the stopcock. – Call the Service Department.
 Technical fault	There is a fault.	Start the programme again. If the fault message appears again, contact the Service Department.



① To switch off the fault message: Switch the machine off with the Ⓚ button.

The following fault messages appear in the display

Fault message	Possible cause	Remedy
Heating fault	The washing machine is not heating up the water.	Start the programme again. If the fault message appears again, contact the Service Department.
Chk detergent	Excessive foam has built up during washing.	Use less detergent next time and follow the manufacturer's instructions on dosage given on the packaging.
Hygiene info	A programme using a temperature above 60°C has not been run for a long time.	In order to prevent bacteria and unpleasant odours building up in the machine, run the <i>Maintenance programme</i> using Miele machine cleaner or a universal powder detergent.

The messages are displayed at the end of the programme and when the washing machine is switched on.

Problem solving guide

General problems		
Problem	Possible cause	Remedy
The machine shakes during the spin cycle.	The machine feet are not level.	Level the machine (see "Installation and connection").
The laundry has not been spun properly and is still wet.	The machine detected an imbalance during the final spin and reduced the spin speed automatically.	Include both large and small items in the load as this will give better distribution during spinning.
The laundry has not spun satisfactorily.	The spin speed selected was too low.	Select a higher spin speed next time.
The pump makes strange noises.	This is not a fault. These noises occur at the end of a pump sequence as a normal part of the operation.	
Large amounts of detergent residue remain in the detergent dispenser drawer.	The water pressure is too low.	<ul style="list-style-type: none"> – Clean the filter in the water inlet. – Select Water plus.
	Powder detergent used with water softeners can become sticky.	Clean the drawer. Add washing powder and then add the water softener.
Fabric conditioner is not completely dispensed or too much water remains in the  compartment.	The siphon tube is not correctly positioned or is clogged up.	Clean the siphon (see "Cleaning and care - Cleaning the detergent dispenser drawer").
The display is in a different language.	A different language has been selected via the "Language  .	Set the language you want. The flag symbol will guide you.
When laundry is dry, it feels hard to the touch.	Too vigorous wash action.	Programme in gentle action and more water.
	Not enough detergent used.	Increase detergent dose to prevent limescale build-up in laundry.
	No fabric conditioner used.	Use fabric conditioner in the last rinse.

An unsatisfactory wash result		
Problem	Possible cause	Remedy
Liquid detergent does not give the required result.	Liquid detergents usually contain no bleaching agents. They do not remove fruit, coffee and tea stains.	<ul style="list-style-type: none"> – Use a general purpose detergent containing a bleaching agent. – Add stain removers into compartment  of the detergent dispenser drawer and liquid detergent into a dispenser ball. – Never put stain removers and liquid detergent together in the dispenser drawer.
Grey, greasy particles cling to washed laundry.	Insufficient amounts of detergent were used to break down the particles of grease in heavily soiled laundry.	<ul style="list-style-type: none"> – Use more detergent. – Before the next wash, run the <i>Maintenance programme</i> using Miele machine cleaner or a universal powder detergent.
White residues which look like powder detergent are seen on dark textiles after washing.	The detergent contained compounds (zeolites) to aid water softening which are not soluble in water. They have ended up on the laundry.	<ul style="list-style-type: none"> – Try and brush off the residues with a soft brush once the laundry is dry. – Wash dark textiles using a detergent which contains no zeolites. Liquid detergents usually contain no zeolites. – Use the <i>Dark garments / Denim</i> programme for dark coloured laundry.

Problem solving guide

The drum door does not open when you press the Door button	
Possible cause	Remedy
The washing machine is not connected to the electricity supply and/or is not switched on.	Insert the plug in the socket and switch on and / or switch the machine on with the  button.
The safety lock has been activated.	Deactivate the safety lock as described in "Changing the programme sequence - Safety lock".
Access via a code has been activated.	Deactivate the code as described in "Settings - Code".
Power cut.	Open the drum door as described in the next section.
The door was not correctly engaged.	Press hard against the lock side of the drum door and then press the <i>Door</i> button.
There is still water in the drum and the machine is unable to drain.	Clean the drain filter and drain pump as described in the next section.
For safety reasons the drum door cannot be opened if the suds temperature is higher than 55°C.	

Opening the drum door in the event of a blocked drain outlet and/or power failure

- Switch the washing machine off.

There is a lever behind the detergent drawer fascia panel.

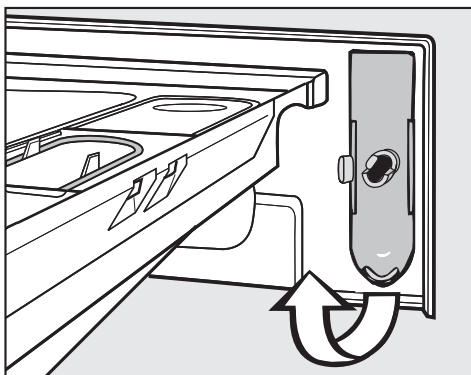

- Remove the lever.

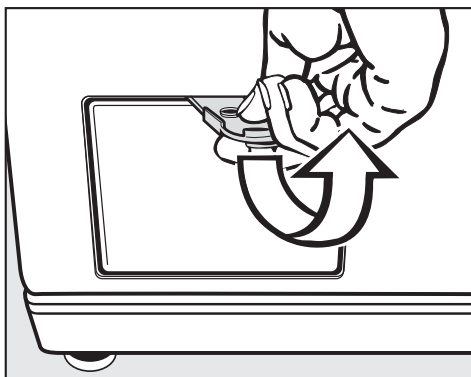

- Use it to open the access flap.

Blocked drain outlet

If the drain outlet is blocked, up to 25 litres of water will be retained in the machine.

 **Caution:** if laundry has been washed at a high temperature, water draining out of the machine will still be hot. Danger of scalding!

Procedure for draining the machine

Be careful not to release too much water at once. If the flow of water is too strong, some water can seep into the washing machine base and activate the water protection system float switch. This will prevent the washing machine from functioning.

- Place a suitable container under the access flap.

When draining water from the machine, do **not** unscrew the drain filter completely or take it right out.



- Slowly and carefully unscrew the drain filter to let the water out.

If you need to interrupt the flow of water:

- Tighten the drain filter back up again.

Problem solving guide

Once the flow of water ceases:

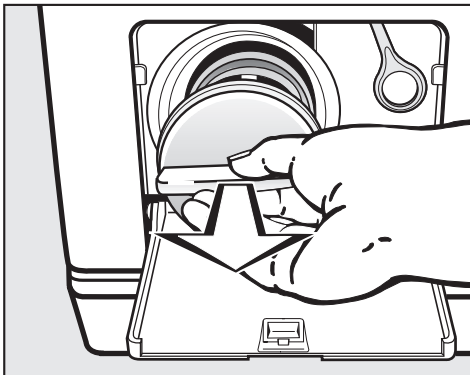

- Remove the drain filter completely.
- Clean it thoroughly.

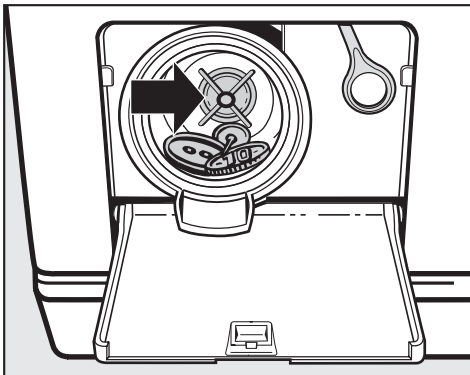

- Remove any foreign objects (e.g. buttons, coins, etc.) and fluff from the filter housing. Turn the impeller by hand to check that it rotates freely. Any foreign object causing an obstruction should be removed.
- Put the drain filter back in place and secure.

 Make sure the drain filter is securely tightened. Otherwise there is a risk of water leakage during use.

To avoid loss of detergent, pour approx. 2 litres of water into the detergent dispenser drawer after cleaning the drain filter. Excess water will be pumped out automatically before the next wash programme.

Opening the drum door

 Always make sure that the drum is stationary before reaching into the machine to remove laundry. Reaching into a moving drum is extremely dangerous.

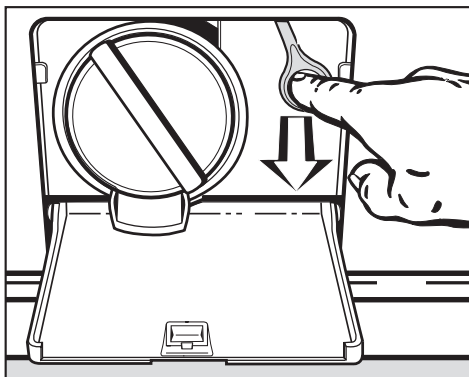

- Pull the emergency release downwards (see illustration). The drum door will open.

In the event of any faults which you cannot remedy yourself, please contact:

- your Miele Dealer or
- Miele (see back cover for contact details).

When contacting your Dealer or Miele, please quote the model and serial number of your machine, both of which are shown on the data plate visible above the porthole glass when the door is open.

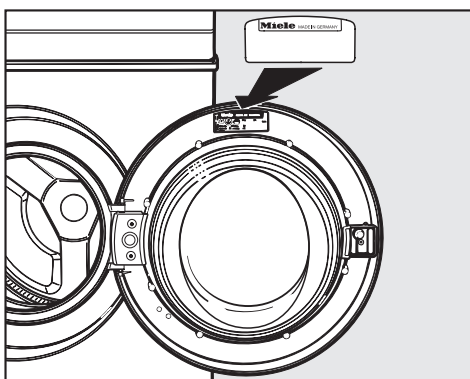

N.B. A call-out charge will be applied for service visits where the problem could have been resolved as described in these instructions.

Future updates (PC)

The indicator light marked PC is the interface used by Miele service technicians during servicing work for testing purposes and for updating the machine's programme data.

Guarantee

For information on the appliance guarantee specific to your country please contact Miele. See back cover for contact details.

In the U.K. your appliance is guaranteed for 2 years from the date of purchase. However, you must activate your cover by calling 0845 365 6640 or registering online at www.miele.co.uk.

Optional spare parts and accessories

Optional spare parts and accessories for this washing machine are available from your Miele Dealer, the Miele Spare Parts Department or via the internet at www.miele-shop.com.

Please note that telephone calls may be monitored and recorded for training purposes.

Installation and connection

Front view

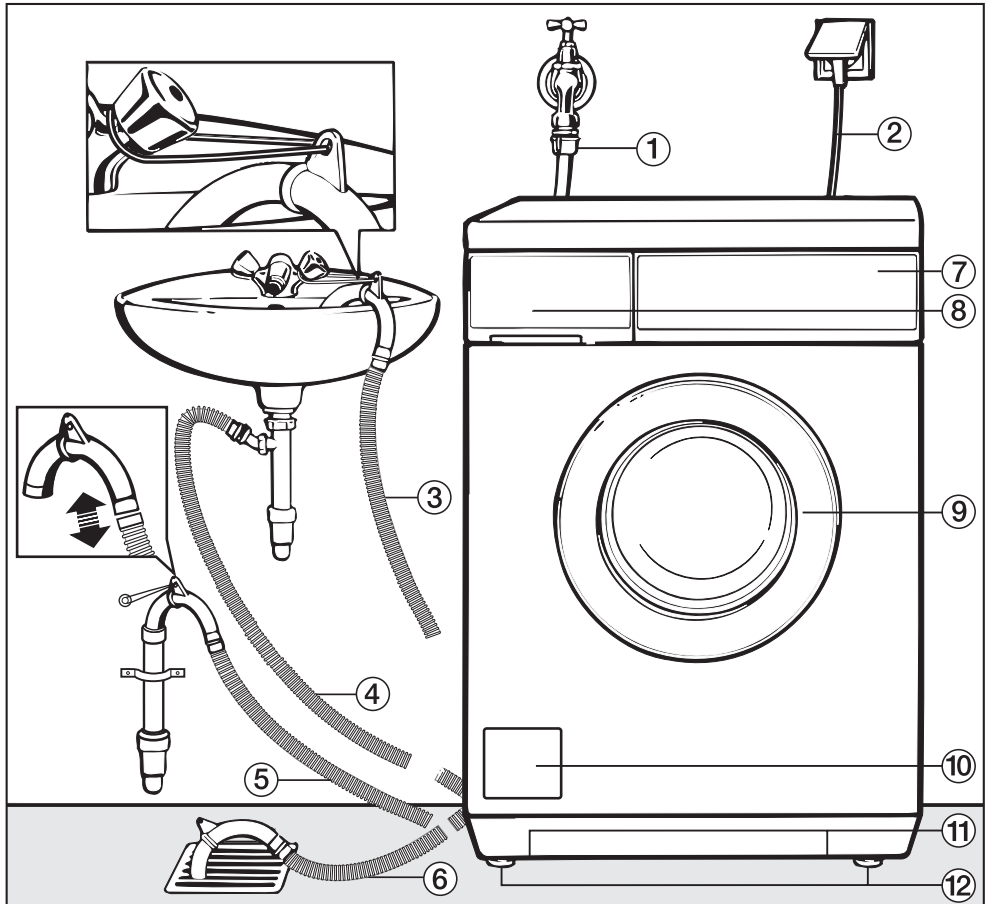

① Inlet hose (tested to withstand pressure of at least 7,000 kPa)

② Electricity supply cable

③ - ⑥ Flexible drain hose (with detachable swivel elbow)

⑦ Control panel

⑧ Detergent dispenser drawer

⑨ Drum door

⑩ Access to drain filter, drain pump and emergency release

⑪ Handle recesses for moving the machine

⑫ Four height adjustable feet

Rear view

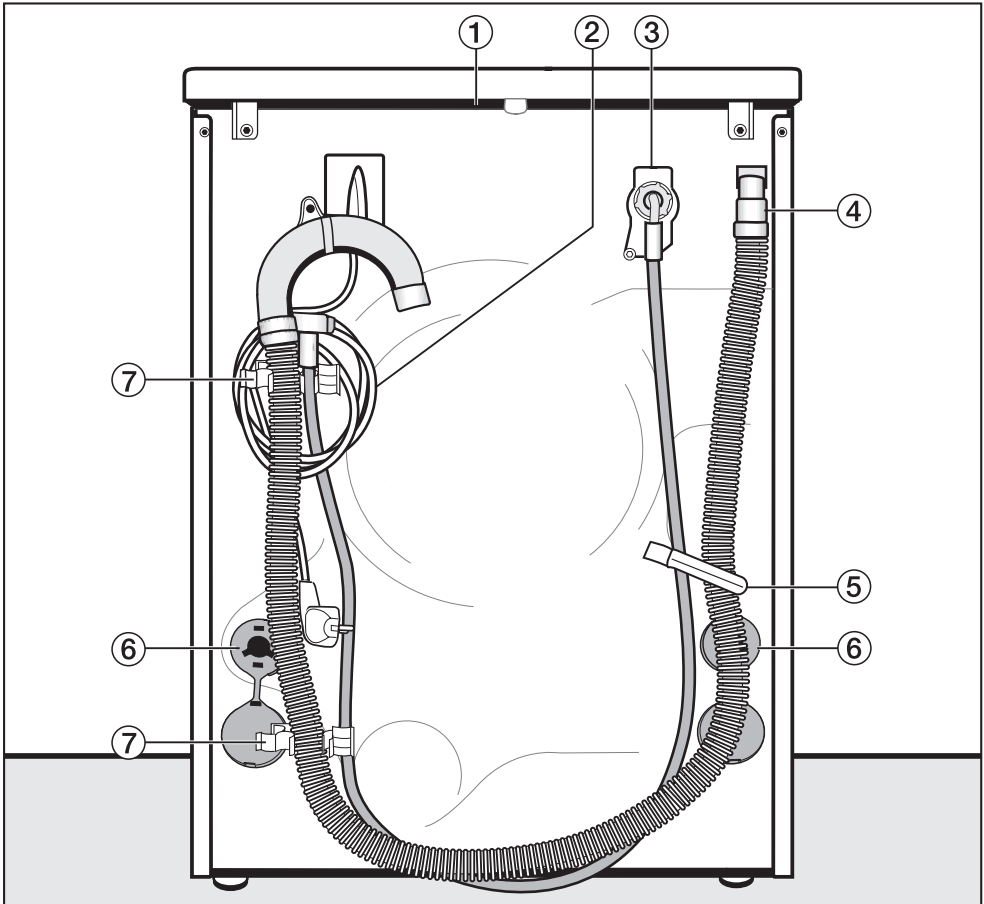

- ① Protruding lid for holding when moving the machine
- ② Electricity supply cable
- ③ Inlet hose (tested to withstand pressure of at least 7,000 kPa)
- ④ Drain hose

- ⑤ Transport clip for inlet and drain hoses
- ⑥ Safety cap for transit bars
- ⑦ Transport clip for inlet and drain hoses and for storing transit bars when not in use.

Installation and connection

Installation surface

A concrete floor is the most suitable installation surface for a washing machine, being far less prone to vibration during the spin cycle than wooden floorboards or a carpeted surface.

Please note:

- The machine must be level and securely positioned.
- To avoid vibrations during spinning, the machine should not be installed on soft floor coverings.

If installing on a wooden joist floor:

- We recommend a plywood base (at least 59x52x3 cm). The base should span several joists and be bolted to the joists and not only to the floorboards. Check for the presence of pipes and cables first.

If possible, install the machine in a corner, as this is usually the most stable part of the floor.

⚠ If the machine is installed on a raised plinth, it **has to be secured** against slippage during spin using retaining clips (available from the Miele Spare Parts Dept). Otherwise there is the danger of the machine moving and falling off the plinth.

Transporting the washing machine to its installation site

To manoeuvre the machine out of its packing case to its installation site, hold it by the edge of the lid where it protrudes to the rear of the machine as well as by the handle recesses at the front.

⚠ Ensure that the machine feet and the floor are dry to prevent the machine from slipping during the spin cycle.

Removing the transit bars

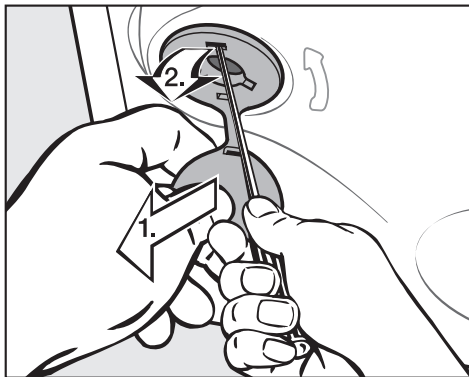

- To remove the left and right covers
 1. Pull on the attached stopper,
 2. then use a screwdriver to release the catch at the top.

Installation and connection

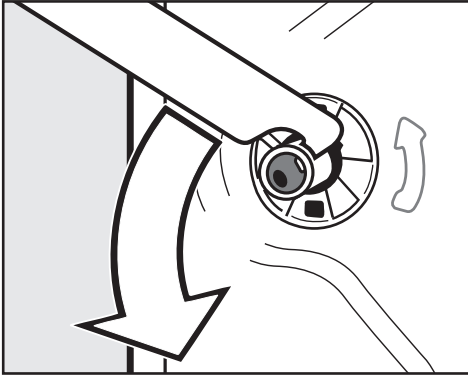

- Using the spanner supplied, turn the left-hand transit bar 90°, then

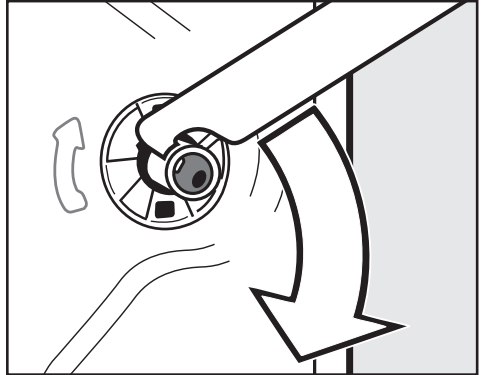

- Turn the right-hand transit bar 90°, then

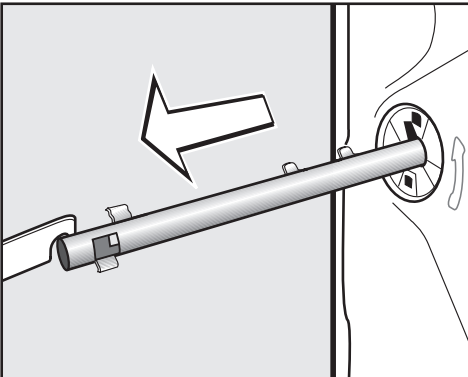

- withdraw the transit bar.

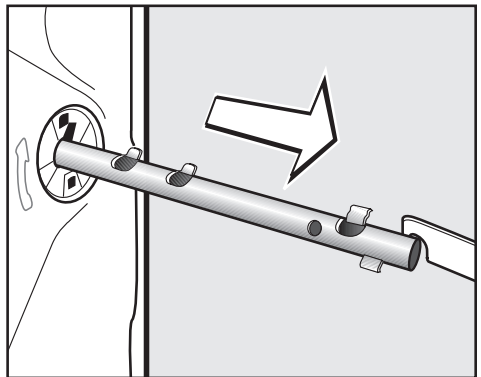

- withdraw the transit bar.

Installation and connection

 To avoid the risk of injury the holes for the transit bars must be covered after the transit bars have been removed.

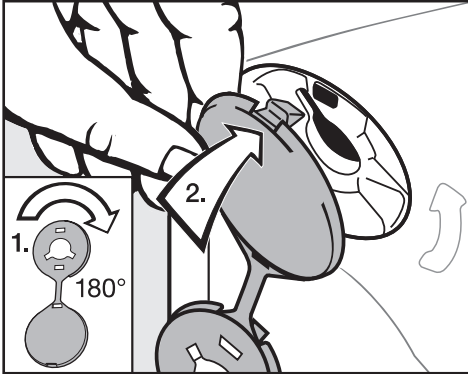

- Plug the holes with the plastic caps as illustrated.

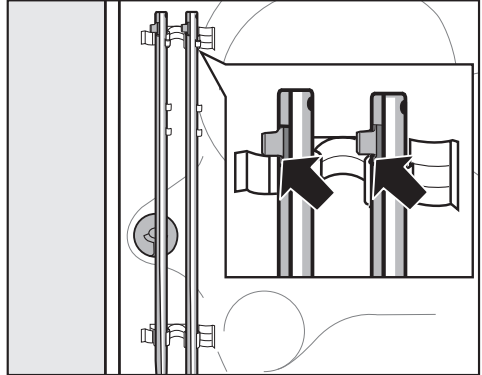

- Secure the transit bars to the back of the washing machine. Make sure that the top catch is located above the holder.

 The machine must not be moved without the transit bars in place. Store them as shown or keep them in a safe place for future use. They must be re-fitted if the machine is to be moved again (e.g. when moving house).

Re-fitting the transit bars

Re-fitting is carried out by reversing the procedure.

Levelling the machine

The machine must stand perfectly level on all four feet to ensure safe and proper operation.

Incorrect installation may increase electricity and water consumption and may cause the machine to move about.

Screwing out and adjusting the feet

The four adjustable screw feet are used to level the machine. All four feet are screwed in when the machine is delivered.

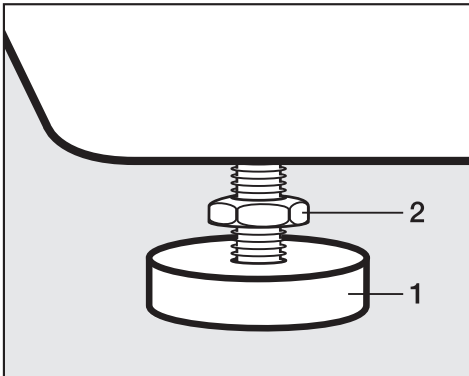

- Using the spanner supplied turn counter nut **2** in a clockwise direction. Then turn counter nut **2** together with foot **1** to unscrew.

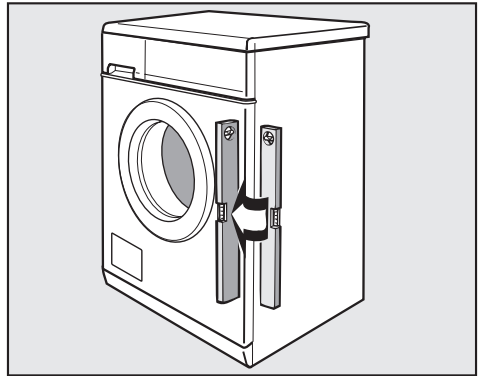

- Use a spirit level to check the machine is standing level.
- Hold foot **1** securely with a pipe wrench. Turn counter nut **2** again using the spanner supplied until it sits firmly up against the housing.

 All four counter nuts must be firmly up against the housing. Please also check this for the feet which did not need adjustment. Otherwise there is the danger of the machine moving about.

Installation and connection

The fitting of building-under kits* and stacking kits* must only be undertaken by qualified and competent persons, in accordance with the instructions supplied with the kit.

Building under a continuous worktop/in a kitchen run

If you wish to push your machine under a worktop and there is space to do this **without removing the lid**, the conversion kit is not necessary. Otherwise the conversion kit is essential.

- A special building-under conversion kit* is required.
To ensure electrical safety, the washing machine lid must be replaced by the cover plate supplied with the conversion kit.
- For installation under a work surface 900/910 mm from the floor, a raising kit* is required.
- Connections for electricity, water and drainage should be installed in such a way that they remain accessible when the machine is in place.

Fitting instructions are supplied with the conversion kit.

All parts marked* are available from your Dealer, the Miele Spare Parts Department or via the internet at www.miele-shop.com.

Washer and Dryer stack

A Miele tumble dryer can be stacked with the washing machine. A "WTV" stacking kit* is necessary.

Please note:

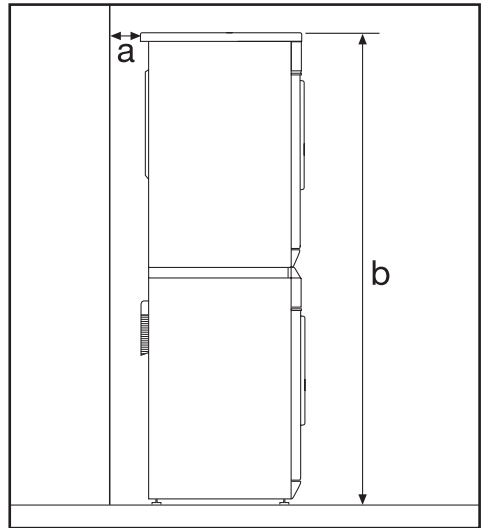

a Safety distance to wall:
at least 2 cm

b Height:
Stacking kit with pull-out shelf:
approx. 169 cm
Stacking kit without pull-out shelf:
approx. 170 cm

The Miele water protection system

The Miele water protection system protects the washing machine from water damage.

The system consists of three main components:

- 1) the inlet hose
- 2) the electronic unit and the washing machine housing
- 3) the drain hose

1) Inlet hose

The inlet hose is tested to withstand pressure of more than 7,000 kPa.

2) Electronic unit and washing machine housing

- Sump

Any leaking water is collected in a sump in the base of the machine. A float switches off the safety valves, preventing any more water flowing into the machine and water in the suds container is pumped away.

- Overflow protection

This prevents the washing machine taking in too much water. If the water level exceeds a certain level, the drain pump switches in and pumps the excess water away.

3) Drain hose

The drain hose is protected by a ventilation system which prevents the washing machine from being emptied completely.

Installation and connection

Connection to the water supply

The machine should be connected to a mains water supply in accordance with local and national safety regulations. The German authorities do not require it to have a non-return valve as the washing machine has been designed to comply with DIN regulations.

The machine is designed to operate with a flow pressure of between 100 kPa and 1,000 kPa. If it is higher than 1,000 kPa it is essential to fit a pressure reducing valve.

Connection to the mains water supply should incorporate a mains stopcock with $\frac{3}{4}$ " thread. The stopcock should be fitted by a qualified plumber.

In order to protect the water inlet valve, the two dirt filters - one in the open end of the inlet hose, one at the inlet point in the machine - must not be removed.

Extension hose

- Longer hoses 2.5 or 4.0 m in length are available from your Miele dealer or the Miele Spare Parts Department as optional extras.

 The connection point is subject to mains water pressure. Turn on the stopcock slowly and check for leaks. Correct the position of the washer and union if appropriate.

The washing machine is **not** suitable for connection to a hot water supply.

Maintenance and care

Only use a genuine Miele hose should you ever need a replacement or extension. These are tested to withstand pressure of at least 7,000 kPa.

Connection to the drainage system

The machine drains via a drain pump with a delivery head of 1 metre*. The drain hose must not be kinked as this restricts drainage. The swivel elbow at the end of the hose can be turned in either direction, or can be detached if required, with a sharp twist and pull.

If required, the drain hose can be extended to a length of 5 m. The necessary parts can be purchased from the Miele Spare Parts Department or your Miele dealer.

* For a delivery head of more than 1 m (up to a max. of 1.8 m) a replacement drain pump will need to be fitted. Please contact the Miele Spare Parts Department or your Miele Dealer.

Drain hose connection:

1. Direct into a sink or basin:

Please note the following:

- Hook the hose over the edge and secure.
 - Make sure that the water can drain away freely without hindrance. Otherwise there is a risk of water overflowing or of some of the drained water being sucked back into the machine.
2. Connected securely to a plastic drain pipe with a rubber nipple. There is no need to use a non-return valve.
 3. Connected securely to a standpipe.
 4. Connected securely to a floor gully.

Please note:

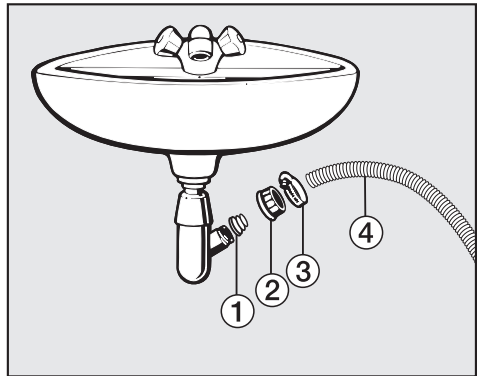

① Adapter

② Nut

③ Hose clip

④ End of the hose

- Fit adapter ① to the sink drain outlet using nut ②.
- Attach the end of the hose ④ to adapter ①.
- Use a screwdriver to tighten hose clip ③ up close to the nut.

Installation and connection

Electrical connection U.K.

All electrical work should be carried out by a suitably qualified and competent person, in strict accordance with current national and local safety regulations (BS 7671 in the UK).

Ensure power is not supplied to the appliance until after installation work has been carried out.

The appliance is supplied with a mains cable with moulded plug ready for connection to a 230-240V mains supply.

Please ensure the connection data quoted on the data plate match the household mains supply.

Connection should be made via a suitable switched socket which is easily accessible after installation.

For extra safety it is advisable to protect the machine with a suitable residual current device (RCD). Contact a qualified electrician for advice.

Do not connect via an extension lead. Extension leads do not guarantee the required safety of the appliance (e.g. danger of overheating).

Non-rewireable plugs BS 1363

The fuse cover must be refitted when changing the fuse, and if the fuse cover is lost, the plug must not be used until a suitable replacement is obtained. The colour of the correct replacement cover is that of the coloured insert in the base of the plug, or the colour that is embossed in words on the base of the plug (as applicable to the design of plug fitted).

Replacement fuses should be ASTA approved to BS 1362 and have the correct rating. Replacement fuses and fuse covers may be purchased from your local electrical supplier.

WARNING: THIS APPLIANCE MUST BE EARTHED

Technical data

Height	850 mm
Width	595 mm
Depth	615 mm
Depth with door open	993 mm
Height for building under	820 mm
Width for building under	600 mm
Depth for building under	600 mm
Weight	98 kg
Capacity	8 kg dry laundry
Voltage	See data plate
Connected load	See data plate / plug
Fuse rating	See data plate
Consumption data	See "Consumption data"
Water flow pressure minimum	100 kPa (1 bar)
Water flow pressure maximum	1000 kPa (10 bar)
Inlet hose length	1.60 m
Drain hose length	1.50 m
Mains connection cable length	1.60 m
Delivery head max.	1.00 m
Maximum drainage length	5.00 m
LEDs	Class 1
Test certificates awarded	See data plate
Power consumption when switched off	0.1 W
Power consumption when not switched off	2.5 W

Consumption data

		Load	Consumption data			
			Energy in kWh	Water in litres	Duration	Residual moisture
Cottons	90°C	8.0 kg	2.30	64	2 h 29 min	50%
	60°C	8.0 kg	1.52	55	1 h 59 min	50%
	60°C	4.0 kg	1.15	47	1 h 59 min	50%
	<60°C*	8.0 kg	0.94	55	2 h 59 min	44%
	<60°C*	4.0 kg	0.94	47	2 h 59 min	44%
	40°C	8.0 kg	0.96	72	2 h 29 min	44%
	40°C	4.0 kg	0.83	47	2 h 29 min	44%
	<40°C	8.0 kg	0.80	55	2 h 59 min	44%
	<40°C*	4.0 kg	0.66	47	2 h 59 min	44%
Minimum iron	40°C	3.5 kg	0.56	52	1 h 52 min	30%
Woolens 	30°C	2.0 kg	0.23	39	39 min	–
Outerwear	40°C	2.5 kg	0.45	55	1 h 02 min	–
Proofing	40°C	2.5 kg	0.35	12	40 min	–
Express 20	40°C	3.5 kg	0.32	30	20 min	–
Maintenance prog.	75°C	0 kg	0.80	42	43 min	–
Down duvets	40°C	2.5 kg	0.70	43	1 h 24 min	–
Delicates	30°C	2.0 kg	0.38	69	59 min	–
Automatic plus	40°C	5.0 kg	0.52	62	1 h 29 min	–
Shirts	60°C	2.0 kg	0.95	59	1 h 11 min	–
Dark garments / Denim	40°C	3.0 kg	0.60	52	1 h 12 min	–
Hygiene	60°C	7.0 kg	1.70	80	2 h 35 min	–

Notes for test institutes:

- * The test programme conforms to EN 60456 and the energy label with Directive 1061/2010.

Consumption data can vary from the nominal values given depending on water pressure, water hardness, water inlet temperature, room temperature, type and volume of load, fluctuations in the electricity supply and any extra options selected.

The consumption data displayed using the Eco feedback function may differ from the values shown above. The deviation relates to the manner in which data is captured on the machine. For example, water consumption is calculated according to how long the water inlet valve is opened for. Fluctuations in the water supply, or a water pressure under 170 kPa can cause values to differ.

Settings

The Settings are used to alter the machine's electronics to suit changing requirements. Settings can be altered at any time.

To access Settings

Before you begin, ensure that:

- The washing machine is switched on.
- The machine door is closed properly.
- Press the *Delay start* (<) and *Spin speed* (>) buttons at the same time until:



appears in the display. You are now in Settings.

To select a Setting

- Press the *Spin speed* (>) or *Delay start* (<) button until the Setting you want appears in the display.
 - Use the *Delay start* (<) button to scroll through the list of options to the left.
 - Use the *Spin speed* (>) button to scroll through the list of options to the right.
- Press the *Temperature* (OK) button to confirm your selection.

To alter a Setting

- You can see the different options available for a Setting by pressing the *Spin speed* (>) button.

The option which is currently set will have a tick ✓ beside it.

- When the option you want appears in the display, press the *Temperature* (OK) button to activate this option.

To come out of Settings

- Press the *Spin speed* (>) or *Delay start* (<) button repeatedly until *Back* appears in the display.
- Press the *Temperature* (OK) button.

Language 🚩

The display can be set to appear in one of several different languages.

The flag 🚩 after the word *Language* acts as a guide to prevent a language which will not be understood from being set.

The language selected is saved to memory.

Total usage

This gives the sum total of all energy and water consumption.

Energy

This gives the sum total of all energy consumption.

Water

This gives the sum total of all water consumption.

Reset function

This resets the total consumption data figure back to zero.

Water plus

You can increase the amount of water used in the wash programmes.

There are three different options:

Water +

(The machine is delivered with this option selected.)

The water level is increased in the wash and rinse stages.

Extra rinse

An extra rinse is introduced.

Water+ & Extra rinse

The water intake is increased in the wash and rinse stages and an extra rinse is carried out.

Soak

The soak time can be set between 30 minutes and 2 hours 30 minutes.

The washing machine is delivered with a two hour soak time set as standard.

Settings

Gentle action

Activating Gentle action reduces the drum action and is suitable for washing slightly soiled items more gently. It should be activated for garments with a single bar under the "bucket" in the care label and for articles which feel too hard after they have been dried.

Gentle action can be activated for the *Cottons* and the *Minimum iron* programmes.

The machine is delivered with this option deactivated.

Suds cooling

When this is activated, additional water flows into the drum at the end of the main wash to cool the suds down. Hot suds can damage plastic drainage pipes.

Suds cooling takes place when temperatures of 90°C and 75°C are selected.

Suds cooling should be activated:

- to prevent the danger of scalding if the drain hose is hooked over the edge of a sink or basin.
- where the drainage pipes do not comply with DIN 1986.

The machine is delivered with this option deactivated.

Code

The code prevents the washing machine being used without your knowledge.

To activate the code

- Select activate and confirm this by pressing the *Temperature* (OK) button.
- You will be prompted to enter a code. The code is **125** and cannot be altered.
- Press the *Spin speed* (>) button until the first number appears in the display.
 - Confirm your selection of the number by pressing the *Temperature* (OK) button.
 - Repeat the process until all three numbers have been entered.
 - Press the *Temperature* (OK) button.

To use the washing machine when the code is activated

When the washing machine is switched on again, the display will request the code.

- Enter code 125 as described above and confirm the entry.

The washing machine is now unlocked and ready for use.

To deactivate the code

Proceed as for activating the code.

Temperature unit

You can choose for the temperature to be displayed in °C/*Celsius* or °F/*Fahrenheit*.

The machine is delivered with °C/*Celsius* as the default setting.

Buzzer

When the buzzer function has been activated, an audible tone sounds at the end of a programme or when Rinse hold is reached.

There are two volumes:

Off

(The machine is delivered with this option selected.)

The buzzer is switched off.

Normal

The buzzer sounds at *normal* volume at the end of a programme or when Rinse hold is reached.

Loud

The buzzer sounds at maximum volume (*Loud*) at the end of a programme or when Rinse hold is reached.

Keypad tone

An audible tone sounds each time a button is pressed.

The machine is delivered with the keypad tone deactivated.

Brightness

There are ten different display brightness settings.

The bar chart shows you the setting.

The washing machine is delivered with the display brightness on setting 5.

The brightness will change as soon as a different setting is chosen.

Settings

Standby display

To save energy, the display goes out and the indicator light for the *Start/Stop* button will start flashing slowly.

The display will always go out,

- if a programme is not selected within 10 minutes of the machine being switched on.
- 10 minutes after the end of a programme.

Pressing one of the buttons switches the display back on again.

You can also choose whether you want the display to go out 10 minutes after a programme has started or to remain visible throughout the programme.

On

The standby function is switched on. When this option is selected, the display will go out 10 minutes after a programme has started.

Not in current prog.

(the machine is delivered with this option selected)

The standby function is switched off. The display will remain visible during a programme.

Memory

The washing machine will store the most recently selected settings (programme, temperature, spin speed and any extra options) in memory once the programme has started.

These settings will appear in the display the next time the machine is switched on.

The machine is delivered with the memory function deactivated.

Anti-crease

Anti-crease helps prevent creasing if laundry is not normally removed immediately after the end of a programme.

The drum will turn at intervals for up to 30 minutes after the programme has finished.

The door can be opened and laundry removed at any time during the anti-crease phase.

On

(the machine is delivered with this option selected)

Anti-crease is activated.

Off

Anti-crease is deactivated.

Miele washing machines offer perfect care for your laundry and feature a wide range of special programmes designed to suit the fabric being washed. Miele have also developed a range of specialist CareCollection detergents and conditioning products to offer you a complete package for cleaning and caring for your laundry.

The Miele CareCollection detergents and conditioning products are listed below. You can order these and many other useful products via the internet at:



All the products can also be ordered via the Miele Customer Contact Centre (see back cover for contact details).

CareCollection

Miele specialist detergents

"Outdoor wear"

This specialist detergent will clean your water-repellent outerwear with care.

"Sportswear"

The Miele Sportswear detergent is designed to clean sportswear and remove odours whilst taking care of the special microfibres used in these garments.

"Down Items"

This special-purpose detergent contains a mild tenside and has been specially formulated to keep down-filled items supple and to give them bounce.

Miele proofing agent

This special finishing agent reproofs garments against wind and water and provides a dirt-repellent finish whilst retaining elasticity and breathability.

Optional accessories

"UltraWhite" detergent

This multi-purpose powder detergent has excellent stain removal properties and is suitable for white and light coloured laundry as well as heavily soiled coloured items.

"UltraColor" detergent for coloured garments

This liquid detergent is particularly suitable for cleaning coloured and dark garments. The special formulation offers effective stain removal, even at low temperatures, while helping to prevent colours fading.

Liquid detergent "For Delicates"

This liquid detergent is ideal for the gentle treatment of delicate fabrics, such as wool and silk. Its special formulation cleans effectively at temperatures as low as 20°C, while protecting the colour of your delicate garments.

Fabric conditioner

The Miele fabric conditioner will give your laundry a fresh, natural fragrance. It makes garments soft to handle and prevents static build-up during tumble drying.

United Kingdom

Miele Co. Ltd.
Fairacres, Marcham Road
Abingdon, Oxon, OX14 1TW
Tel: 0845 365 0555, Fax: 0845 365 0777
Customer Contact Centre Tel: 0845 365 6600
E-mail: info@miele.co.uk
Internet: www.miele.co.uk

Australia

Miele Australia Pty. Ltd.
ABN 96 005 635 398
1 Gilbert Park Drive, Knoxfield, VIC 3180
Tel: 1300 464 353, Fax: (03) 9764 7149
Internet: www.miele.com.au

China

Miele (Shanghai) Trading Ltd.
1-3 Floor, No. 82 Shi Men Yi Road
Jing' an District
200040 Shanghai, PRC
Tel: +86 21 6157 3500, Fax: +86 21 6157 3511
E-mail: mieleshanghai@cn.miele.com
Internet: www.miele.cn

Miele (Hong Kong) Limited

41/F - 4101, Manhattan Place
23 Wang Tai Road
Kowloon Bay
Hong Kong
Tel: (852) 2610 1331, Fax: (852) 2610 1013
Email: mielehk@miele.com.hk

India

Miele India Pvt. Ltd.
Ground Floor, Copia Corporate Suites
Plot No. 9, Jasola
New Delhi - 110025
Tel: 011-46 900 000, Fax: 011-46 900 001
E-mail: customercare@miele.in, Internet: www.miele.in

Ireland

Miele Ireland Ltd.
2024 Bianconi Avenue
Citywest Business Campus, Dublin 24
Tel: (01) 461 07 10, Fax: (01) 461 07 97
E-Mail: info@miele.ie, Internet: www.miele.ie

Manufacturer: Miele & Cie. KG

Carl-Miele-Straße 29, 33332 Gütersloh, Germany

Miele

Malaysia

Miele Sdn Bhd
Suite 12-2, Level 12
Menara SapuraKencana Petroleum
Solaris Dutamas No. 1, Jalan Dutamas 1
50480 Kuala Lumpur, Malaysia
Phone: +603-6209-0288
Fax: +603-6205-3768

New Zealand

Miele New Zealand Limited
Unit L, 10-20 Sylvia Park Road
Mt. Wellington, 1060, Auckland, NZ
Tel: 0800 264 353, Fax: 0800 463 453
Internet: www.miele.co.nz

Singapore

Miele Southeast Asia
Miele Pte. Ltd.
163 Penang Road
04 - 02/03 Winsland House II
Singapore 238463
Tel: +65 6735 1191, Fax: +65 6735 1161
E-Mail: infosea@miele.com.sg
Internet: www.miele.sg

South Africa

Miele (Pty) Ltd
63 Peter Place, Bryanston 2194
P.O. Box 69434, Bryanston 2021
Tel: (011) 875 9000, Fax: (011) 875 9035
E-mail: info@miele.co.za
Internet: www.miele.co.za

United Arab Emirates

Miele Appliances Ltd.
P.O. Box 11 47 82
Gold & Diamond Park
Sheikh Zayed Road
Building 6 / Offices Nos. 6-214 to 6-220
Dubai
Tel: +971-4-341 84 44
Fax: +971-4-341 88 52
E-Mail: info@miele.ae, Internet: www.miele.ae

Free Manuals Download Website

<http://myh66.com>

<http://usermanuals.us>

<http://www.somanuals.com>

<http://www.4manuals.cc>

<http://www.manual-lib.com>

<http://www.404manual.com>

<http://www.luxmanual.com>

<http://aubethermostatmanual.com>

Golf course search by state

<http://golfingnear.com>

Email search by domain

<http://emailbydomain.com>

Auto manuals search

<http://auto.somanuals.com>

TV manuals search

<http://tv.somanuals.com>