

Operating instructions for Washing machine W 853

It is **essential** to read these operating instructions before installing or using the machine, to avoid the risk of accident, or damage to the machine.



M.-Nr. 04 947 060

Caring for our environment

Disposal of the packing material

The transport and protective packing has been selected from materials which are environmentally friendly for disposal and can normally be recycled. Rather than just throwing these materials away, please ensure they are offered for recycling.

Disposal of your old appliance

Old appliances contain materials which can be recycled. Please contact your dealer, your local waste collection centre or scrap merchant about potential recycling schemes. Ensure that the appliance presents no danger to children while being stored for disposal. See the appropriate advice in the "Warning and safety instructions".

Caring for our environment

Disposal of the packing material	2
Disposal of your old machine/appliance	2

Guide to the machine

General view	6
Control panel	7

Warning and Safety Instructions 8

Washing environmentally and economically 11

Before using for the first time

Flushing out the wash cabinet.	12
Water hardness reminder.	12

How to wash correctly

Brief guide	13
Before washing	13
To start a programme	14
After washing	16
Adding or removing washing after programme start	17
Programme	18
. . . interruption	18
. . . alteration	18
. . . Skipping a programme stage	18

Adding detergent

It is important to dispense the correct amount, because	19
Adding detergent.	20
Water softeners	20
Fabric conditioners, Texturisers, Liquid starch	20
Automatic fabric conditioners, texturisers, or liquid starch.	21
Separate fabric conditioner or texturiser	21
Starching separately.	21

Contents

Programmes

Programme selection	22
Sequence	24
Care symbols	26

Additional options

Soak	27
Pre-wash	27
Short	27
Water plus	28
Spin	28
"Without final spin"	28
"Rinse hold"	28
Electronic programme locking	29

Programmable functions

Maximum water level	30
Water plus system	31
Activating the  compartment	33
Soak time	34
Gentle action	35
Top-up rinse for Cottons	36
Memory function	37

Cleaning and care

Cleaning the washing machine	38
Extra cleaning	38
Cleaning the detergent dispenser drawer	39
Cleaning the fluff (drain) filter and pump	40
To clean the water inlet filters	42
To clean the filter in the union in the open end of the inlet hose:	42
To clean the filter in the water inlet valve:	42

Problem solving guide

What to do, if	43
Opening the drum door in the event of a power failure	47

After sales service

Customer contact	48
Future updates (PC).	48

Installation

Installation surface	49
Installation	49
Removing the transit fitting.	49
Levelling the machine	51
Screwing out and adjusting the feet	51
Washer and Dryer stack	52
Connection to water supply	53
Connection to the drainage system	54
Electrical connection U.K.	55

Consumption data	56
-----------------------------------	----

Technical Data	57
---------------------------------	----

Guide to the machine

General view

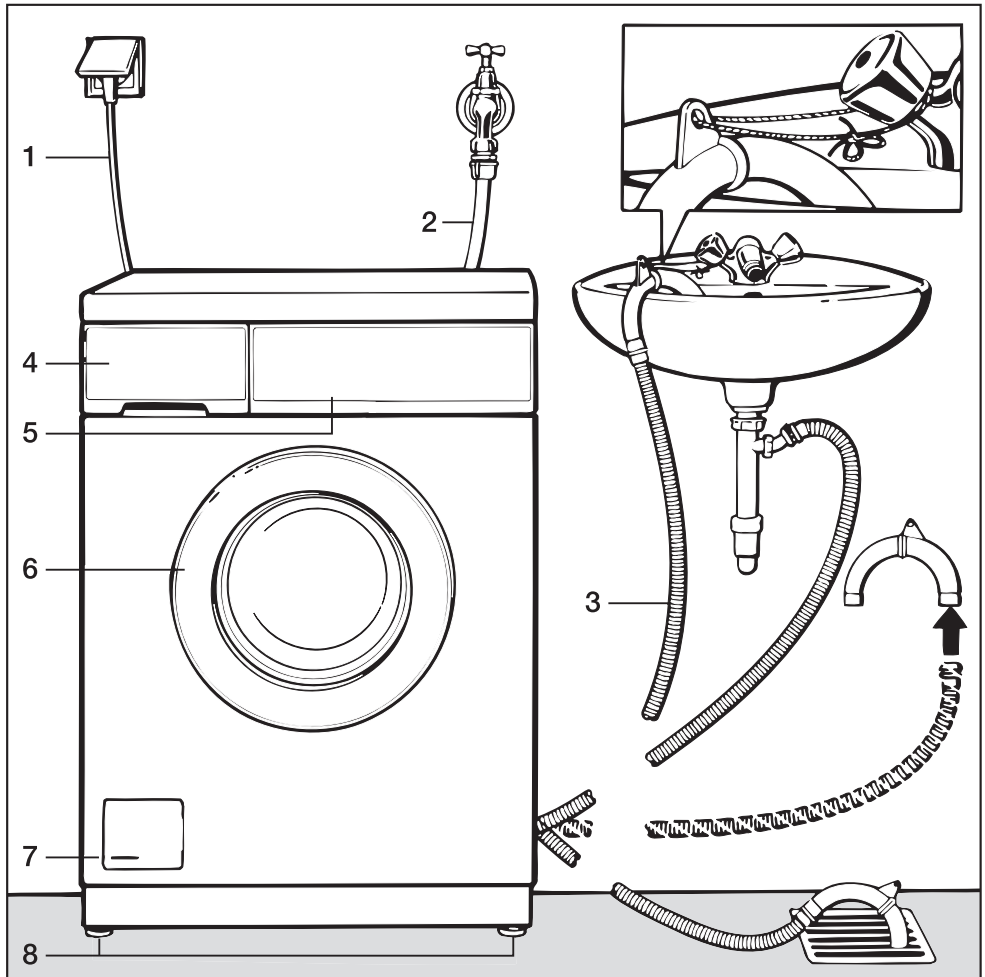

- | | |
|--|---|
| 1 Electric supply cable | 5 Facia panel with controls |
| 2 Inlet hose (able to withstand pressures up to 70 bar) | 6 Door |
| 3 Flexible drain hose (with detachable swivel elbow) | 7 Access panel for drain pump, drain filter and emergency door release |
| 4 Detergent dispenser drawer | 8 Four height adjustable feet |

Control panel

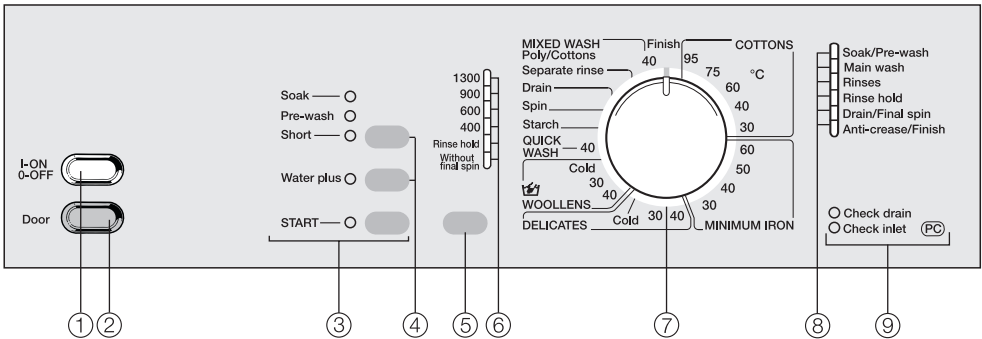

- ① **“I-ON / 0-OFF”** button
To switch the machine ON or OFF or to interrupt a programme.
- ② **“Door”** button
opens the machine door.
- ③ **“START”** button
starts the wash programme
- ④ **Buttons for additional functions**
The upper button is used to select either the "Soak", "pre-wash" or "Short wash" additional option.
The lower button is used to select the additional option "Water plus".
- ⑤ **“Spin”** button
for spin speed, Rinse hold and Without final spin
- ⑥ **Indicator lights**
showing the selected spin speed.
- ⑦ **Programme selector**
Can be turned clockwise and anti-clockwise.
- ⑧ **Programme sequence indicator lights**
- ⑨ **Check lights**

Indicator light on = selected
Indicator light off = not selected

Warning and safety instructions

Read the operating instructions before using this machine for the first time. They contain important information about the safety, use and maintenance of the machine. This way you will avoid the risk of accidents and damage to the machine. Keep these operating instructions in a safe place and ensure that new users are familiar with the content. Pass them on to any future owner of the machine.

Correct usage

Only use the washing machine to wash items which are specified by the manufacturer to be machine-washable on the wash-care label, and textiles composed of hand-washable wool or wool blend fabrics as well as satin, lace, silk and other hand-washable garments.

Any other applications may be dangerous. The manufacturer is not liable for damage resulting from improper use or operation.

This appliance should not be operated by children. Supervise its use by the elderly or infirm.

Technical safety

Before setting up the machine, check it for any externally visible damage. Do not install and use a damaged machine.

Before connecting the machine, ensure that the connection data on the data plate (fusing, voltage and frequency) match the mains electricity

supply. If in any doubt, consult a qualified electrician.

The electrical safety of this appliance can only be guaranteed when continuity is complete between the machine and an effective earthing system which complies with local and national regulations. It is most important that this basic safety requirement is regularly tested by a qualified electrician.

The manufacturer cannot be held responsible for the consequences of an inadequate earthing system.

Do not connect the appliance to the mains electricity supply by an extension lead. Extension leads do not guarantee the required safety of the appliance (e.g. danger of overheating).

The machine is built in accordance with current safety requirements. Unauthorised repairs could result in unforeseen dangers for the user, for which the manufacturer cannot accept responsibility. Repairs should only be undertaken by a Miele approved engineer.

Ensure current is not supplied to the appliance while maintenance or repair work is being carried out.

The machine is only completely isolated from the electricity supply when:

- it is switched off at the wall socket and the plug is withdrawn, or
- it is switched off at the mains, or
- the mains fuse is withdrawn.

Warning and safety instructions

■ The best materials are used in the manufacture of this machine, and every care is taken to check all parts. However, with time, deterioration of parts can occur, especially with such components as hoses, giving rise to leaks. Check the hose regularly for signs of wear, and change in good time, to avoid leaks and subsequent damage.

■ Faulty components must only be exchanged for Miele original spare parts. Only when these parts are fitted can the safety standards of the machine be guaranteed.

Use

■ Do not install your washing machine in rooms where temperatures below freezing may occur. Frozen hoses may burst under pressure. The reliability of the electronic control system may be impaired at temperatures below freezing point.

■ In countries where there are areas which may be subject to infestation by cockroaches or other vermin, pay particular attention to keeping the appliance and its surroundings in a clean condition at all times. Any damage which may be caused by cockroaches or other vermin will not be covered by the appliance guarantee.

■ Before using the machine for the first time, check that the transit fitting at the rear of the machine has been removed (see section on "Installation"). During spinning, a transit fitting which is still in place may result in damage to both the machine and adjacent furniture or appliances.

■ Turn off the stopcock if the machine is to be left for any length of time (e.g. holiday), especially if there is no floor drain (gully) in the immediate vicinity.

■ **Flooding danger.**
If hooking the drain hose into a wash basin, check that the water can drain off quickly enough to prevent the sink from overflowing. Make sure the drain hose is secure, so that the force of the water flowing out of the hose does not dislodge it. Otherwise this will result in flooding.

■ Take care to ensure that foreign objects (e.g. nails, needles, coins, paper clips, etc.) do not find their way into the machine with the washing (e.g. in pockets). Foreign objects can damage components of the machine, which in turn can result in damage to the washing.

Warning and safety instructions

■ If the correct amount of detergent is dispensed, the machine should not need to be descaled. If, however, you do wish to descale the machine only use proprietary non-corrosive descaling agents and strictly observe the instructions. Consult the Miele Customer Service Department.

■ Textiles which have been pre-treated in solvent based cleaning agents must be thoroughly rinsed in clean water before being washed in the machine.

■ Never use solvent based cleaning agents in this machine, as this may result in damage to component parts and create toxic fumes. Such detergents also pose a fire and explosion hazard.

■ Only use dyes specified by the manufacturer as being suitable for use in a washing machine. Always observe the manufacturer's instructions carefully.

■ Dye removers may contain sulphur compounds which cause damage such as corrosion. Do not use dye removers in this machine.

■ For machines with a 'porthole' door, remember that the porthole glass will be hot when washing at very high temperatures. Do not let children touch it.

■ Always make sure the drum is stationary before reaching in to remove washing. Reaching into a moving drum is extremely dangerous.

Accessories

■ Accessory parts may only be fitted when expressly approved by Miele. If other parts are used, guarantee, performance and product liability claims may be invalidated.

Disposal of your old machine

■ Before discarding an old machine unplug it. Render the plug useless. Cut off the cable directly behind the appliance to prevent misuse.

Washing environmentally and economically

- Water consumption and energy usage are determined by the size of the load. Load to the maximum recommended for the programme selected.
- The washing times can vary considerably due to the automatic load adjustment feature. Depending on the amount of the load, the main wash may be shortened and one rinse omitted.
- Use the Mixed Wash poly/cottons programme or the Quick Wash programme for smaller amounts of laundry.
- To save energy wash normally and lightly soiled laundry at lower temperatures. The 95°C Cottons programme is probably only needed in exceptional circumstances, e.g. for oil based stains or where a very hot wash is required.
- A main wash (programme without pre-wash) is sufficient to clean normally soiled laundry.
- By using the additional option "Soak" you can select a lower temperature in the main wash.
- Use the additional option "Soak" instead of "Pre-wash" with heavily soiled laundry.
If "Soak" is followed immediately by a main wash the same suds are used.
- Use the "Short" wash option for normally or very lightly soiled laundry.
- Do not exceed the amounts of detergent which may be recommended by the manufacturer on the packaging.
- Reduce the amounts of detergent with smaller loads, (e.g. with a half load, approx. one third less detergent).
- Select the highest suitable spin speed in the wash programme when tumble drying afterwards.

Before using for the first time

Before using the machine for the first time ensure that it is correctly installed and connected. See the relevant section under "Installation". Also check that the fluff filter is securely tightened. Otherwise there is a risk of water leakage during use.

For safety reasons spinning is not possible until the machine has been prepared for using for the first time. To activate the spinning function you must run a wash programme without any laundry).

This also activates the ball valve. The ball valve prevents detergent escaping from the suds container into the sump during a wash programme, thus making maximum use of the detergent.

The wash programme must be run without detergent.

Using detergent could result in an excessive build-up of foam.

- Turn on the stopcock.
- Press the "I-ON/O-OFF" button in.
- Turn the programme selector to "COTTONS 40°C".
- Press the "START" button.

When this programme has finished your washing machine is ready for using for the first time.

Brief guide

The headings numbered (1, 2, 3, ...) show the operating sequence and can be used as a brief guide.

Before washing

1 Prepare the wash load.

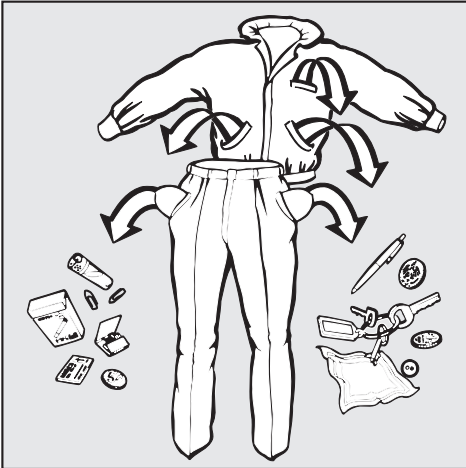

- Empty all pockets.

Foreign objects (e.g. nails, coins, paper clips, etc.) can cause damage to textiles and components in the machine.

- Sort the laundry

Most garments have a textile care label in the collar or side seam. Sort the washing by care label symbols. (See the section on these symbols for their explanation).

Dark textiles often contain excess dye and should be washed separately several times before being included in a mixed load.

Delicate textiles should be washed separately in a delicates programme (use a washing bag where appropriate).

Do not wash any items in this machine which are specified by the manufacturer as **non-machine washable** on the care label. (☒ symbol)

- Pre-treat the laundry

Badly soiled areas, e.g. collars and cuffs, and water soluble stains can be pre-treated with bar soap, liquid detergent or detergent mixed into a solution or paste.

With particularly stubborn stains ask your dry cleaner for advice. Do not use solvent-based cleaning agents in this machine.

- **Curtains:**
Remove lead weights and strips or place in a laundry bag.
- **Underwiring and collar stiffeners:**
Any loose wiring in bras, shirt collar stiffeners, etc. should be removed or sewn in.
- **Knitted garments, trousers and jeans, T-shirts and sweat shirts:**
Turn inside out, if recommended by the manufacturer.

How to wash correctly

2 Press the “Door” button.

3 Load the drum.

Unfold washing and load loosely in the drum. To achieve best results it is advisable to make up mixed loads consisting of both large and small items. This improves the washing effect and helps distribute the load evenly to keep the machine stable and reduce the noise level during spinning.

Overloading reduces the wash result and causes more creasing.

Maximum load weights are noted below:

COTTONS	5.0 kg
MINIMUM IRON	2.5 kg
DELICATES/SYNTHETICS	1.0 kg
WOOLLENS 	1.0 kg
QUICK WASH.	2.5 kg
MIXED WASH (Poly/Cottons)	3.0 kg

4 Shut the door with a light swing but do not slam it. Do not push on the door to shut it.

Make sure that there is no obstruction between the drum door and seal.

5 Open the stopcock.

6 Add detergent.

See section on “detergent” for details.

To start a programme

7 Press in the “I-ON/0-OFF” button.

- The programme selector should be pointing to Finish, the indicator light "Anti crease/Finish" is lit up in the sequence display.

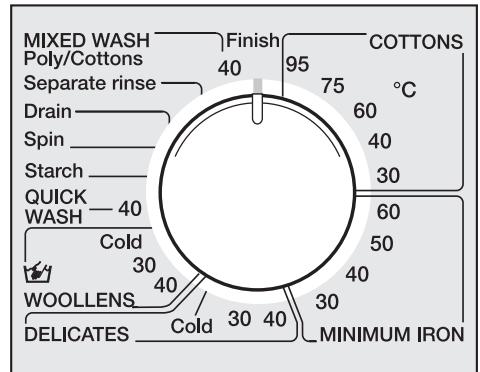

8 Turn the programme selector to the programme required

See section “Programmes, Programme survey”.

How to wash correctly

9 Select any additional option required.

A maximum of two additional options can be chosen, provided they are compatible with the programme selected, (see the Programme survey in the Section on programmes). Only one option out of "Soak", "Pre-wash" and "Short wash" can be selected.

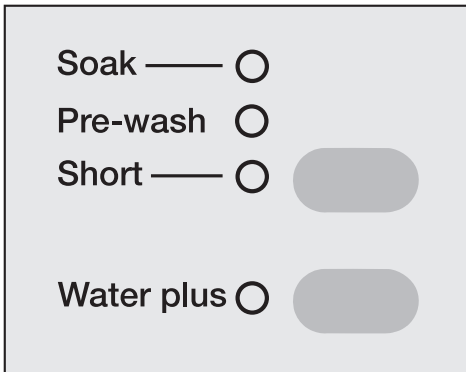

- Press the button for the "Soak", "Pre-wash" or "Short wash" additional options, until the indicator for the chosen option lights up.
- Press the button for the "Water plus" option, if required.

An additional option that has been selected can be de-selected by pressing the button.

10 Select a spin speed.

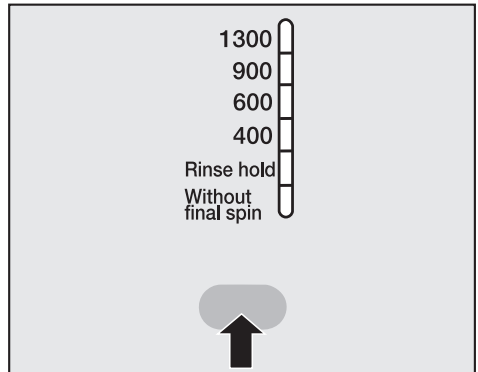

- Press the "Spin" button enough times until the indicator for the required final spin speed lights up.

In some programmes the maximum spin speed is limited. The machine will not allow a higher spin speed to be selected. (see section on "programmes").

Memory-Function

If the last time a programme was run an additional option or different spin speed was selected, the machine will have stored this information in its memory.

The next time that programme is selected the machine offers the additional option and / or spin already stored in memory. (see "Programmable functions")

11 Press the "Start" button.

The programme now starts.

How to wash correctly

After washing

- 12** Press the “Door” button.
- 13** Press and release the “I-On/0-Off” button.
- 14** Remove the washing.

Only remove washing from the machine once the drum has stopped turning, otherwise you may seriously injure yourself.

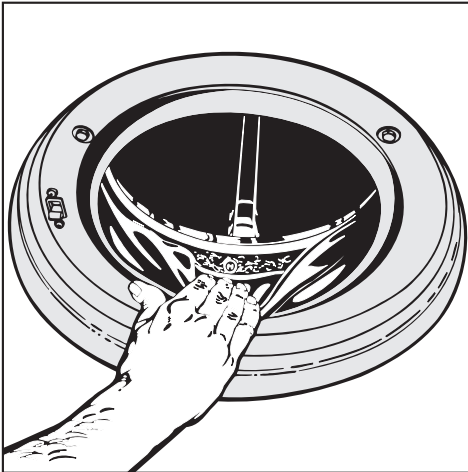

- 15** Check the folds in the door seal for any small articles e.g. buttons which might be lodged there.
- 16** Close the stopcock.
- 17** Close the drum door.

Otherwise there is a danger of objects being placed inadvertently in the drum. If these remained unnoticed and were washed in the next load, they could damage the washing.

Adding or removing washing after programme start

Washing can be added or removed after the programme has already started, when using the following programmes.

- COTTONS
- MINIMUM IRON
- WOOLLENS 
- QUICK WASH
- Starch
- MIXED WASH
- Press the "Door" button and hold it until the door springs open.
- Add or remove items
- Shut the door.

The programme will automatically continue.

- Apart from some exceptional cases the door can be opened during all sections of **COTTONS, WOOLLENS, QUICK WASH, Starch** and **MIXED WASH - Poly/Cottons** (high cotton percentage) programmes.
- With **MINIMUM IRON** and **MIXED WASH - Poly/Cottons** (high polyester percentage) the door can be opened during the main wash with some exceptions.

General exceptions:

The door **cannot be** opened when:

- the suds temperature is above **55°C**.
- the additional option "Water plus" has been selected,
- programme locking is switched on,
- the programme has reached the "Final spin" stage.

How to wash correctly

Programme . . .

. . . interruption

- Press the "I-ON/0-OFF" button.
- To continue with the same programme press the "I-ON/0-OFF" button again.

. . . alteration

The machine will accept the following changes after the "Start" button has been pressed,

- selection of a different temperature, extra selection or de-selection of the "Water plus" option can be carried out up to 6 minutes after start.
- the spin speed for final spin can be changed if the programme permits.

After start it is no longer possible to select a different programme.

If a different programme or 6 minutes after start another temperature is selected the indicator light "Anti-crease/Finish" flashes. This does not affect the programme sequence. The indicator light goes out when the programme selector is set back to the programme or temperature previously chosen.

To select a different programme proceed as follows:

- With the "I-On/0-Off" button switch off the appliance.
- Turn the programme selector to "Finish".
- Switch the machine on with the "I-On/0-Off" button.
- Select a new programme.
- Press the "START" button.

. . . Skipping a programme stage

- Turn the programme selector to "Finish".

As soon as the programme sequence light for the stage at which the programme should continue starts flashing:

- Turn the programme selector switch to the appropriate programme **within 4 seconds**.

When programme locking has been activated the programme cannot be changed nor can a programme stage be repeated or left out.

All modern detergents produced for automatic washing machines are suitable, including liquid, compact (concentrated) and special application detergents. Use dispensing aids, e.g. balls, if these are supplied with the detergent.

Woollens and knitwear containing wool mixtures and hand-washable garments should be washed using a detergent specifically designed for washing woollens.

Add detergent according to the amount recommended on the packaging. The right amount to dispense will depend on the following:

- The quantity of laundry.
- The soiling level of the laundry.

Lightly soiled

No visible dirt or stains. Possibly slight body odour.

Normally soiled

Visibly dirty and/or just a few slight stains.

Heavily soiled

Stains and soiling clearly visible.

- The water hardness level
Check with your local water supplier if you do not know the water hardness level.

Water Hardness

Hardness range	Type of water (hardness)	Hardness level in mmol / l	°dH German
I	soft	0 - 1.3	0 - 7
II	medium	1.3 - 2.5	7 - 14
III	hard	2.5 - 3.8	14 - 21
IV	very hard	over 3.8	over 21

It is important to dispense the correct amount, because . . .

. . . too little has the following results:

- Laundry will not be properly clean and will in time become grey and hard to the touch.
- Greasy particles cling to the laundry.
- Lime deposits on the heater elements.

. . . too much results in the following:

- Excessive foam.
- Low level of agitation.
- Poor washing, rinsing and spinning results.
- High water consumption (an additional rinse cycle will automatically switch in).
- Burdening the environment.

Adding detergent

Adding detergent

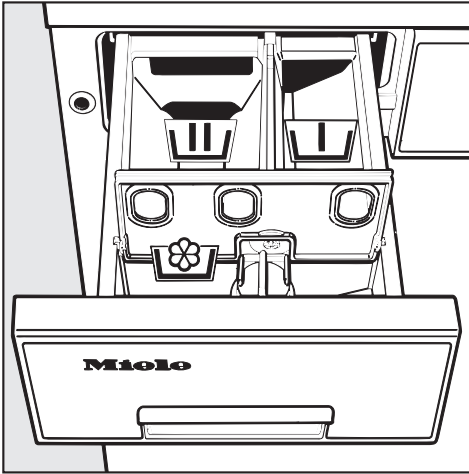

☐ = Compartment soak/pre-wash

☐ = Compartment main wash

☐ = Compartment fabric conditioner

Water is taken in through compartment ☐ in the pre-wash.

Water is taken in through compartment ☐ in the main wash. If the capacity of compartment ☐ is insufficient for the amount of detergent needed (e.g. in very hard water areas), the machine can be programmed so that water and detergent can also be taken into the main wash through compartment ☐, see “Programmable functions”, “Activating compartment ☐”.

Water softeners

A water softener can be used to cut down on the use of detergents in water hardness ranges II-IV. Dispense according to the amount specified on the packaging. First add detergent and then the water softener.

Use a quantity of detergent as for soft water.

If you wash using several components (e.g. special application detergents), we recommend always dispensing the agents into compartment ☐ in the following order:

1. Detergent
2. Water softener
3. Stain salts

This way the agents are distributed more efficiently.

Fabric conditioners, texturisers, liquid starch

Fabric conditioners make garments soft and fluffy to handle and help prevent static cling when tumble drying.

Texturisers are synthetic starch formulations and give body to items e.g. shirts, tablecloths and bed linen.

Starch gives body to items of washing.

- Dispense according to the amount specified on the packaging.

Automatic fabric conditioners, texturisers, or liquid starch

- Open the lid of compartment .

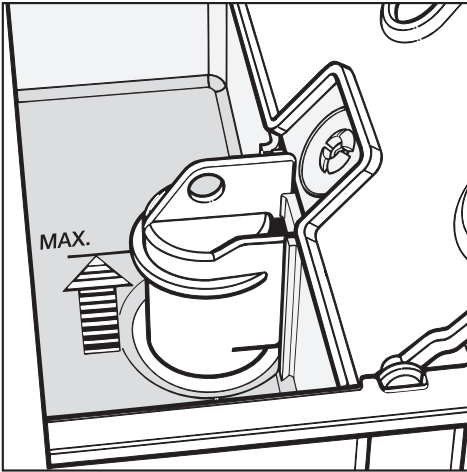

- Add the fabric conditioner, texturiser or liquid starch. **Do not exceed the maximum level mark.**
- Close the compartment lid.
- Push the drawer back in.

The conditioner, texturiser or liquid starch is automatically dispensed in the last rinse. At the end of the programme a small amount of water remains in the fabric conditioner compartment .

If starching frequently, clean the dispenser compartment and especially the siphon tube and conditioner channel. (See section on the detergent dispenser drawer in "Cleaning and Care").

Separate fabric conditioner or texturiser

- Add fabric conditioner or texturiser to the compartment .
- Turn the programme selector to "Starch".
- Select a spin speed.
- Press the "Start" button.

Starching separately

- Measure and prepare starch in accordance with the manufacturer's instructions.
- Add the starch to compartment .
- Turn the programme selector to "Starch".
- Select a spin speed.
- Press the "Start" button.

Programmes

Programme selection

Programme	Fabric	Temperature	max. spin speed
COTTONS	Cottons and linen fabrics, eg bed linen, table linen, towelling, jeans, underwear, T-shirts, nappies.	95°C to 30°C	1300
COTTONS	Wash load as for standard tests	60°C	1300
MINIMUM IRON	(60°C) white nylon, white polyester fabrics (50°C), coloured nylon, polyester, cotton and viscose fabrics with special finishes, acrylic, cotton fabrics, coloured polyester / cotton fabrics, (40°/30°C) minimum iron fabrics not washable at higher temperatures	60°C to 30°C	900
DELICATES	Acrylics, acetate and triacetate, socks and stockings in man-made fibres, (not wool or wool blends)	40°C to cold	600
	Curtains, specified machine-washable by the manufacturer (pre-wash probably advisable).	30°C to cold	600
WOOLLENS 	Programme for machine-washable or hand-washable wool or wool blend fabrics	40°C to cold	900
	Also suitable for satin, lace, silk and other hand washable garments.		*
QUICK WASH	very lightly soiled fabrics, which can be washed in the Cottons programme.	40°C	1300
Starch	Table cloths, napkins, overalls, uniforms.	cold	1300
Spin	Articles which can be spun, eg handwashed items, max. weight according to fabric.		1300
Drain			
Separate rinse	Articles which should be washed by hand and only rinsed and spun in the machine.	cold	900
MIXED WASH Poly/Cottons	Suitable for small loads of garments made from man-made fibres and cotton garments which can be washed together. Sort according to colour.	40°C	900

cold:

If "Cold" is selected for the temperature, the water is warmed to 24°C. This uniform temperature helps the effect of the detergent.

max. load	Additional options	Notes
5 kg	<ul style="list-style-type: none"> - Soak - Pre-wash - Short - Water plus (Option 1,2,3,4) 	With heavily soiled items select "Soak" or "Pre-wash". Wash dark colours in liquid detergent. For normally soiled items select "Short".
5 kg		For test institutes: Programme setting for tests according to EN 60456 Standard Programme
2.5 kg	<ul style="list-style-type: none"> - Soak - Pre-wash - Short - Water plus (Option 1,2,4) 	With heavily soiled items select "Soak" or "Pre-wash" For normally soiled items select "Short"
1 kg	<ul style="list-style-type: none"> - Soak - Pre-wash - Short 	Use the Wool programme for textiles with wool content
Fill the drum loosely 1/2 to 3/4 full	<ul style="list-style-type: none"> - Soak - Pre-wash - Short 	Dust in curtains usually makes pre-wash advisable.
1 kg Do not overload		Use liquid wool detergent.
		Hand washable garments will not shrink, stretch, matt or felt beyond the accepted tolerance. *For satin, lace, silk and other hand washable garments manually reduce the spin speed or select without final spin.
2.5 kg	<ul style="list-style-type: none"> - Water plus (Option 1,2,4) 	Add less detergent (half load)
5 kg		The washing should be washed, but not treated with fabric conditioner.
5 kg		
5 kg		
3 kg	<ul style="list-style-type: none"> - Soak - Pre-wash - Short - Water plus (Option 1,2,3*,4*) 	The water level, number of rinses and programme time are set automatically in relation to composition of the washing (see "Programmes" Sequence). *Option is only carried out with a high proportion of cotton.

See Section on Additional options for more details.

Programmes

Sequence

	COTTONS ¹⁾	MINIMUM IRON ¹⁾	DELICATES	WOOLLENS 
Soak	optional	optional	optional	–
Pre-wash	optional	optional	optional	–
Main wash	●	●	●	●
Top-up rinse from 75°C	programmable	–	–	–
Graduated rinsing	–	from 40°C	–	–
No. of rinses				
– normal	3 or 4 ²⁾	3	3	2
– part load	2	2	3	2
– short	2	2	3	–
Rinse and interim spin (rpm)	max. 1000	max. 500	–	max. 600
Final spin (rpm)	max. 1300	max. 900	max. 600	max. 900
Anti-crease, loosen	max. 30 mins	max. 30 mins	max. 30 mins	–
Rinse hold	optional	optional	optional	optional
without final spin	optional	optional	optional	optional
Wash rhythm	normal	normal	gentle action	Wool
Water level – Wash	low	low	high	medium
– Rinse	low	medium	high	medium

Explanations:

- Programme section included
- Programme section not included

1) Load recognition:

The programme sequence is modified in these programmes according to the absorbency of the load.

2) **A 4th rinse** automatically switches in if there is too much foam in the drum, or if a spin speed lower than 700 rpm has been selected.

Wool:

Wool is susceptible to damage from movement when it is wet. The wash action during the course of the programme is low.

Quick Wash	Starch	Spin	Separate rinse	MIXED WASH ¹⁾	
				high cotton content	high polyester content
–	–	–	–	optional	optional
–	●	–	–	optional	optional
●	–	–	–	●	●
–	–	–	–	–	–
–	–	–	–	–	●
2	–	–	2	3 or 4 ²⁾	3
2	–	–	–	2	2
–	–	–	–	2	2
max. 500	–	–	–	max. 900	max. 500
max. 1300	max. 1300	max. 1300	max. 900	max. 900	max. 900
max. 30 mins	max. 30 mins	max. 30 mins	–	max. 30 mins	max. 30 mins
optional	optional	–	optional	optional	optional
optional	optional	–	optional	optional	optional
normal	normal	–	–	normal	normal
low medium	low –	– –	high	low low	low medium

Top-up rinse (programmable):

At the end of the main wash additional water flows into the drum, and the suds are cooled slightly. Hot water might damage plastic drain pipes.

Graduated rinsing:

The suds are cooled at the end of the wash cycle by water flowing in and being pumped away at intervals thereby minimising crease formation.

Rinse and interim spin:

There is a spin between the rinses.

Final spin:

The maximum spin speed according to the programme can be selected with the Spin button. In the programmes MINIMUM IRON, DELICATES, WOOLLENS, SEPARATE RINSE and MIXED WASH the spin speed is automatically limited to the above stated maximum spin speed.









Anti-crease, spin and loosen:







The anti-crease action guards against the tendency for creases to set in when fabrics have been left in the drum for a long time. There is drum movement twice a minute.

Programmes



Care symbols

Washing





-  Cottons 95°C, 75°C
-  Cottons 60°C
-  Cottons 40°C
-  Cottons 30°C
-  Minimum iron 60°C, 50°C
-  Minimum iron 40°C
-  Minimum iron 30°C
-  Delicates 40°C
-  Delicates 30°C

-  hand wash
-  do not wash
-  dry clean
-  do not dry clean
-  suitable for chlorine bleach
-  do not use chlorine bleach











Tumble dry

-  at normal temperature
-  at low temperature
-  do not tumble dry

Ironing

-  hot iron
-  medium hot iron
-  cool iron
-  do not iron

N.B. If you have any textiles with the older wash care labels, select a programme according to the label below.

- Cottons    
- Minimum iron   
- Delicates  
- Woolens 

To select an additional option to the basic programme press the button for that option. The indicator light for the option comes on.

If an additional option is chosen which is incompatible with the basic programme, (see Programme selection chart), the indicator light goes out when the button is released.

If a spin speed is chosen which is unsuitable for the programme (see Programme selection chart), pressing the button has no effect.

Soak

For heavily soiled and stained items with dried-on stains, or ones which cannot be bleached out, (e.g. blood, fats and oils, cocoa).

- A length of time of between 30 minutes and 2 hours can be chosen, in 30 minute periods, for the "Soak" process.
- The machine is set as standard to two hours soak time.
See the section "Programmable functions" for reprogramming to a different time.

Adding detergent for the Soak option:

Add the total amount into compartment **II** or directly on to the laundry in the drum.

Pre-wash

For heavily soiled and stained items

Short

This shortens the programme running time. For normally soiled items.

In the Cottons, Minimum Iron and Mixed Wash Poly/Cottons programmes only two rinse cycles are carried out with a higher water level.

Additional options

Water plus

The water level increases in "soak", pre-wash, "main wash" and / or "rinses", and / or an extra rinse can be carried out.

You can choose between four options for the "Water plus" button.

The options can be called up through one of the programmable functions, (see Water plus system in the Section on programmable functions).

Switching off the additional options

If an additional option is switched on (and the indicator light in the button is lit up), the option can be switched off by pressing the button. The indicator light goes out.

Spin

A final spin is carried at the end of each of the basic programmes, if a spin speed had been selected.

"Without final spin"

Interim rinse and spin is carried out in the relevant programmes.

Washing is not spun after the final rinse, but the water is drained away, and the machine goes straight into the anti-crease stage.

"Rinse hold"

Interim rinse and spin is carried out during the programme cycle.

The washing remains suspended in water after the final rinse.

This helps to reduce the possibility of creasing if the washing is left for some time before being taken out of the machine.

To continue the programme:

Select the required spin speed with the Spin button.

The maximum spin speed is automatically limited according to the basic wash programme chosen, (See Programme Survey section).

Electronic programme locking

Programme locking prevents the machine from being opened or the programme cancelled during a wash programme.

Switching on programme locking

- 1 Select a programme, (see Brief guide to washing correctly).
- 2 Press the "START" button for at least 5 seconds.

Programme locking is now activated.

The machine will now not accept any changes, and the wash programme proceeds through to the end.

At the end of the wash programme, the programme locking is discontinued, so that a new wash programme can be chosen.

Switching off programme locking early

- 1 Press the "Start" button for at least 5 seconds.

Exception:

The indicator light "Anti-crease/Finish" in the Sequence display flashes.

- 1 Turn the programme selector to the programme previously chosen. The "Anti-crease/Finish" light goes out.
- 2 Press the START button for at least 5 seconds.

To check if programme locking is switched on

- - Press the 'Spin' button.
- If the selected spin speed does not change:

Programme locking is activated.

- If the spin speed changes:

Programme locking is not activated.

Programmable functions

Maximum water level

The water level for rinsing is automatically raised to the maximum level where rinse results are particularly important.

It is effective for the rinses in the following programmes:

- Cottons
- Minimum iron
- Quick wash
- Mixed wash - Poly/Cottons

Before the "Maximum water level" programmable function can be selected you must first select programming mode.

Selecting programming mode

- ❶ The machine must be switched off and the drum door closed. The programme selector must point to "Finish".
- ❷ Press the additional option buttons "Short" and "Water plus" at the same time and hold pressed in and:
- ❸ . . . switch the machine on with the "I-ON/0-OFF"-button.
- ❹ Let go of all these buttons.

The indicator light "Main wash" flashes in the sequence display.

Selecting the programmable function

To select the "Maximum water level" programmable function: turn the programme selector to – **MIXED WASH Poly/Cottons*****.

Activating

To activate "Maximum water level" press the "START" button once. The "Rinses" light comes on in the sequence display.

Storing in memory

To store the "Maximum water level" programmable function in the memory SWITCH the machine OFF with the "I-On/0-OFF" button.

The "Maximum water level" programmable function is now stored in the machine's memory and is effective in the programmes described above until such time as you may wish to deactivate it.

Deactivating

To deactivate the use of a maximum water level in the rinses repeat the procedure given above from point ❶ as far as the *** shown above. Press the START button and the "Rinses" indicator light will go out. The function is now deactivated. Store in memory by pressing the I-On/0-Off button.

Water plus system

The "Water plus" button offers four options, increasing water level and / or bringing in an extra rinse cycle. To activate the option press the "Water plus" button when selecting your wash programme before pressing the START button.

Option 1

Increase in the rinse water level in the Cottons, Minimum iron, Quick Wash and Mixed wash - Poly/Cottons programmes, where for example rinse results are particularly important.

Option 2

Increase in the water level in main wash and rinses for Cottons, Minimum iron, Delicates, Quick wash, and Mixed wash particularly for fabrics that need special care, or where extra attention must be given to dissolving detergent. This option is already set when the machine is delivered from the factory.

Option 3

An extra rinse cycle is introduced to the Cottons programme, e.g. when rinse results are particularly important.

Option 4

Is Option 2 plus Option 3, where this quality of rinse is required.

Before the "Water plus system" programmable function can be selected you must first select programming mode.

Selecting programming mode

- 1 The machine must be switched off and the drum door closed. The programme selector must point to "Finish".
- 2 Press the additional option buttons "Short" and "Water plus" at the same time and hold pressed in and:
- 3 . . . switch the machine on with the "I-ON/O-OFF"-button.
- 4 Let go of all these buttons.

The indicator light "Main wash" flashes in the sequence display.

Selecting the programmable function

To select the "Water plus system" programmable function turn the programme selector to – **Separate rinse**. The indicator lights in the sequence display correspond to the four options available. As Option 2 has been set at the factory, when the programme selector is turned "Separate rinse", the indicator light for Option 2 "Rinse hold" will come on.

Programmable functions

Selecting the Options

By pressing the "START" button you can select the other options. To confirm a new selection another indicator light comes on and the previous one goes out.

Each time "START" is pressed a different indicator light comes on. The indicator lights correspond to the four options as follows:

Option 1 = "Rinse"

Option 2 = "Rinse hold"

Option 3 = "Drain / Spin"

Option 4 = "Anti crease / Finish"

Storing in memory

When you have selected the Option you require, SWITCH the machine OFF with the "1-On/0-OFF" button. The Option is stored in the machine's memory.

Activating the **U** compartment

This function should be activated if traditional "big box" detergents are used. For the first 10 seconds of the main wash cycle water flows in through compartment **U**.

Compartment **U** may sometimes not be able to hold the total amount of detergent required when:

- the water is very hard (over 3.8 mmol/l, water hardness level IV) and
- the washing is heavily soiled.

In this case compartment **U** can be used to flush in the extra detergent for the main wash.

Before the "Activating the **U** compartment" programmable function can be selected you must first select programming mode.

Selecting programming mode

- 1 The machine must be switched off and the drum door closed. The programme selector must point to "Finish".
- 2 Press the additional option buttons "Short" and "Water plus" at the same time and hold pressed in and:
- 3 . . . switch the machine on with the "I-ON/0-OFF"-button.
- 4 Let go of all these buttons.

The indicator light "Main wash" flashes in the sequence display.

Selecting the programmable function

To select the "Activating the **U** compartment" programmable function turn the programme selector to – **Spin *****.

Activating

To activate "Activating the **U** compartment" press the "START" button once. The "Rinses" light comes on in the sequence display.

Storing in memory

To store the "Activating the **U** compartment" programmable function in the memory SWITCH the machine OFF with the "I-On/0-OFF" button.

The "Activating the **U** compartment" programmable function is now stored in the machine's memory.

Deactivating

To deactivate the use of Compartment **U** repeat the procedure given above from point 1 as far as the *** shown above. Press the START button and the "Rinses" indicator light will go out. The function is deactivated. Store in memory by pressing the I-On/0-Off button.

Programmable functions

Soak time

This is accessed for a programme by pressing the SOAK button on the fascia.

You can programme a soak time of:

- 2 hours (factory setting) or
- 1 hour 30 mins or
- 1 hour or
- 30 mins.

A "Soak time" of 2 hours is set at the factory. If you wish to change this standard setting to one of the times listed above, you must first select programming mode.

Selecting programming mode

- 1 The machine must be switched off and the drum door closed. The programme selector must point to "Finish".
- 2 Press the additional option buttons "Short" and "Water plus" at the same time and hold pressed in and:
- 3 . . . switch the machine on with the "I-ON/O-OFF"-button.
- 4 Let go of all these buttons.

The indicator light "Main wash" flashes in the sequence display.

Selecting the programmable function

To select the "Soak time" programmable function turn the programme selector to – **WOOLLENS Cold**.

The "Rinse" indicator light comes on in the sequence display. This shows that a "Soak time" of 2 hours is currently selected (factory setting).

Selecting a different "Soak time"

By pressing the "START" button a various number of times you can select different soak times. To confirm that a different soak time has been selected, the previous indicator light goes out and a new indicator light comes on.

Each time "START" is pressed a different indicator light will come on. The indicator lights correspond to the 4 soak times available as follows:

2 hours =	"Rinse"
1 hour 30 mins =	"Rinse hold"
1 hour =	"Drain \ Spin"
30 mins =	"Anti crease \ Finish"

Storing in memory

When you have selected the soak time you require, SWITCH the machine OFF with the "I-On/O-OFF" button.

The "Soak time" you have selected is now stored in the machine's memory.

Gentle action

For gentle washing of slightly soiled items. Drum action is reduced.

Gentle action can be used with the Cottons, Minimum iron, Quick Wash, Mixed wash and Starch programmes.

If "Gentle action" has been programmed, every wash cycle in these programmes is carried out with gentle action rhythm.

Before the "Gentle action" programmable function can be selected you must first select programming mode.

Selecting programming mode

- 1 The machine must be switched off and the drum door closed. The programme selector must point to "Finish".
- 2 Press the additional option buttons "Short" and "Water plus" at the same time and hold pressed in and:
- 3 . . . switch the machine on with the "I-ON/0-OFF"-button.
- 4 Let go of all these buttons.

The indicator light "Main wash" flashes in the sequence display.

Selecting the programmable function

To select the "Gentle action" programmable function turn the programme selector to –

WOOLLENS 40 °C *.**

Activating

To activate "Gentle action" press the "START" button once.

The "Rinses" light comes on in the sequence display.

Storing the programmable function in memory

To store the "Gentle action" programmable function in the memory SWITCH the machine OFF with the "I-On/0-OFF" button.

The "Gentle action" programmable function is now stored in the machine's memory.

Deactivating

If the "Gentle action" programmable function is no longer required it can be deactivated. To do so repeat the procedure given above from point 1 as far as the *** shown above. Press the START button and the "Rinses" indicator light will go out. The function is now deactivated. Store in memory by pressing the I-On/0-Off button.

Programmable functions

Top-up rinse for Cottons

At the end of the main wash additional water flows into the drum and the suds are cooled down.

Hot suds can damage plastic drainage pipes.

Top-up rinse takes place when temperatures of 95°C and 75°C are selected.

Before the "Top-up rinse for Cottons" programmable function can be selected you must first select programming mode.

Selecting programming mode

- ❶ The machine must be switched off and the drum door closed. The programme selector must point to "Finish".
- ❷ Press the additional option buttons "Short" and "Water plus" at the same time and hold pressed in and:
- ❸ . . . switch the machine on with the "I-ON/0-OFF"-button.
- ❹ Let go of all these buttons.

The indicator light "Main wash" flashes in the sequence display.

Selecting the programmable function

To select the "Top-up rinse for Cottons" programmable function turn the programme selector to –
DELICATES cold *.**

Activating

To activate "Top-up rinse for Cottons" press the "START" button once. The "Rinses" light comes on in the sequence display.

Storing in memory

To store the "Top-up rinse for Cottons" programmable function in the memory SWITCH the machine OFF with the "I-On/0-OFF" button.

The "Top-up rinse for Cottons" programmable function is now stored in the machine's memory.

Deactivating

If the "Top-up rinse for Cottons" programmable function is no longer required it can be deactivated. To do so repeat the procedure given above from point ❶ as far as the *** shown above. Press the START button and the "Rinses" indicator light will go out. The function is now deactivated. Store in memory by pressing the I-On/0-Off button.

Memory function

If an additional option is selected for a programme, and / or the spin speed is altered, the machine stores these changes in memory at the start of a programme.

The memory function is active when the machine is first delivered but can be programmed to be switched off.

Deactivating

First select programming mode.

Selecting programming mode

- ❶ The machine must be switched off and the drum door closed. The programme selector must point to "Finish".
- ❷ Press the additional option buttons "Short" and "Water plus" at the same time and hold pressed in and:
- ❸ . . . switch the machine on with the "I-ON/0-OFF"-button.
- ❹ Let go of all these buttons.

The indicator light "Main wash" flashes in the sequence display.

Deactivating the programmable function

To de-select the "Memory" programmable function turn the programme selector to

DELICATES 30°C *.**

As this programmable function is active when the machine is first delivered, the "Rinses" indicator light will come on in the sequence display as soon as the programme selector is turned to DELICATES 30°C.

To deactivate the "Memory" function press the START button and the light will go out. The memory function is now deactivated.

Storing in memory

To store this setting in memory SWITCH the machine OFF with the I-On/0-OFF" button.

Reactivating

To reactivate the memory function repeat the procedure given above from point ❶ as far as the *** shown above. Pressing the "START" button again will reactivate the "Memory" function and the "Rinses" indicator light will come on again. The function is now reactivated. Store in memory by pressing the I-On/0-Off button.

Cleaning and care

Cleaning the washing machine

- Clean the casing with a mild non-abrasive detergent or soap and water. Wipe dry with a soft cloth.
- Clean the facia panel and flap with a damp cloth and dry with a soft cloth.
- The drum can be cleaned using a suitable proprietary stainless steel cleaner.

Do not use abrasive cleaners, glass cleaners or all-purpose cleaners. These might cause damage to the plastic surfaces because of the chemicals they contain.

Extra cleaning

Carrying out a hot wash (70°C or above) with powder detergent approx. once every six weeks will help to ensure that no deposits build up in the machine. These can occur when washing is mainly done at low temperatures, and also lead to unpleasant smells. If you have no reason to wash laundry occasionally at this high temperature, then carry out a 95°C Cottons programme as a cleaning cycle with powder detergent and no washing, at regular intervals.

Cleaning the detergent dispenser drawer

- Pull out the detergent dispenser drawer until a resistance is felt.

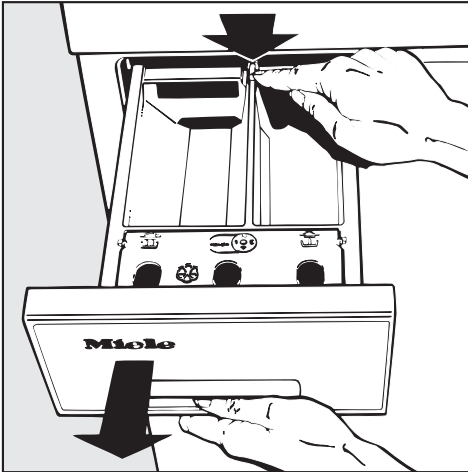

- Press down the red release catch and at the same time pull the drawer right out of the machine.

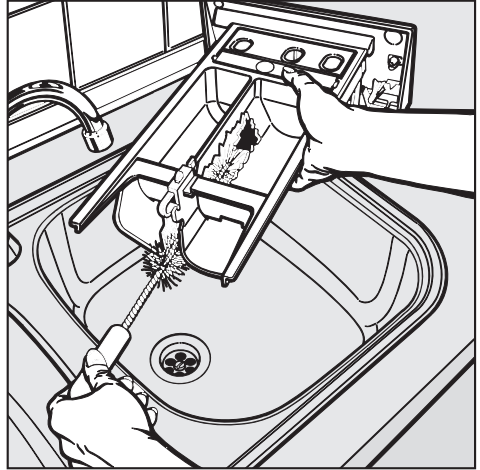

- Clean the dispenser compartments and conditioner channel. Regularly remove any detergent residues.

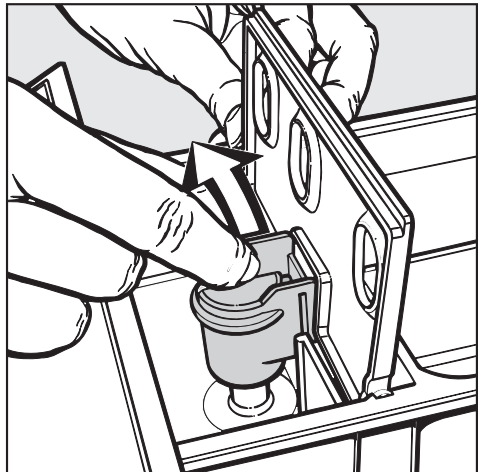

- Remove the siphon tube from compartment . Wash under running warm water and put back.

Cleaning and care

Cleaning the fluff (drain) filter and pump

Check the fluff (drain) filter initially after 3-4 washes to ascertain how often it is likely to require cleaning.

With normal cleaning approx. 2 litres of water run out.

If the drain outlet is clogged, more water will be retained in the machine (**up to 25 litres**).

Caution: If laundry has been washed at a high temperature, water draining out of the machine will still be hot.

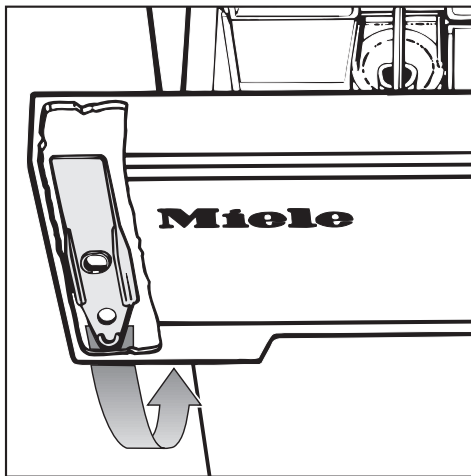

Take the (yellow) filter flap opener from behind the detergent drawer facia panel, (see illustration above).

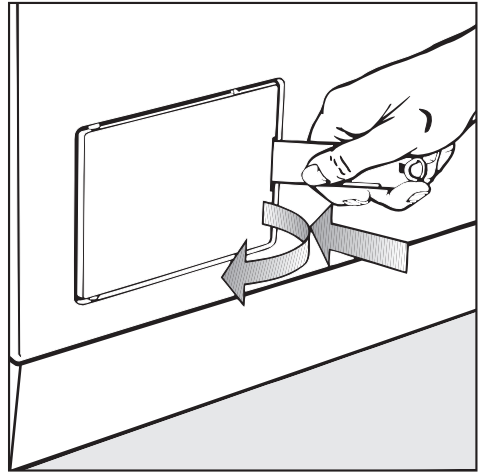

- Open the flap.
- Place a dish under the drain fixture.

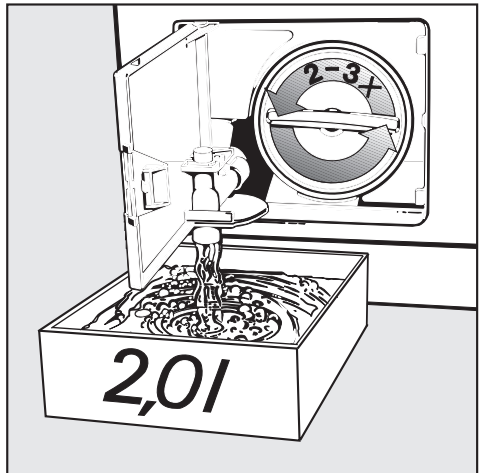

- Turn the fluff filter lid round 2-3 times. **Do not** take it right out.

With large volumes of water, when the dish is full screw the fluff filter back into position, and empty the dish before repeating the procedure.

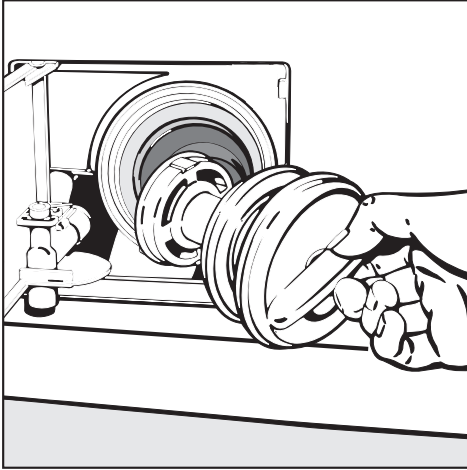

- Clean the inside of the fluff filter housing.

Remove any deposits of lime scale and detergent or foreign objects from the thread of the filter housing and filter unit (as these objects can cause a leakage of water). Deposits of lime scale are often a sign of underdosage of powder.

- Put the fluff filter back in place and secure.

If the fluff filter is not put back properly and secured in place, water will run out of the machine.

- Once the flow of water ceases, remove the fluff filter completely.
- Clean the fluff filter thoroughly.

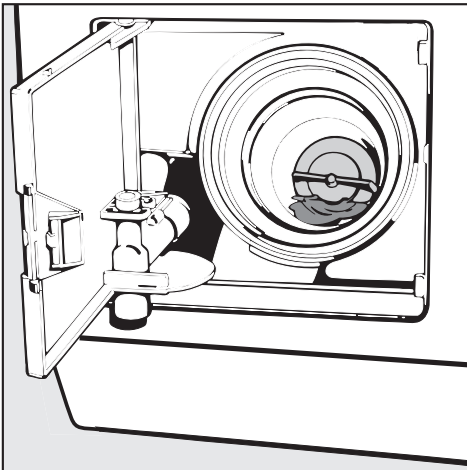

After cleaning

- Pour approx. 2 litres of water into the detergent dispenser compartment **III** to reactivate the ball valve which keeps detergent in circulation in the suds.

- Remove any foreign objects (e.g. buttons, coins, etc.) and fluff.
- Turn the impeller by hand to check that it is free to rotate. Any foreign objects causing an obstruction should be removed.

Cleaning and care

To clean the water inlet filters

The washing machine has two filters to protect the inlet valves. These filters should be checked every 6 months or so, or more often if there are frequent interruptions to the water supply.

To clean the filter in the union in the open end of the inlet hose:

- First turn off the stopcock.
- Unscrew the threaded union connecting the free end of the inlet hose to the stopcock.
- Remove the rubber seal from the recess.

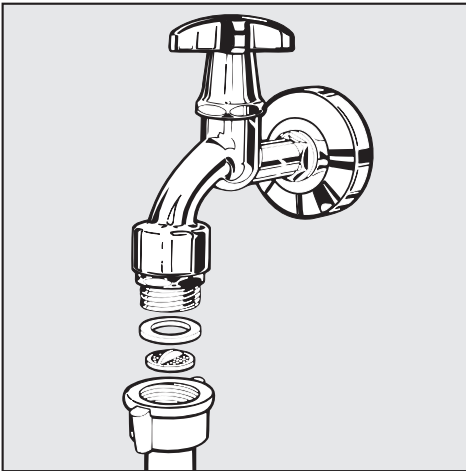

- Using pointed pliers, take hold of the plastic filter bar, remove the filter and clean
- Put the filter and seal back in the reverse order and reconnect the hose.

Turn on the stopcock and check the connection is watertight.

Inspect the inlet hose which is subjected to high pressure while the machine is in operation. The hose should be replaced if there are small cracks in the surface, or if it has been otherwise damaged.

If replacing the inlet hose only use a hose able to withstand pressure up to 70 bar. Miele's own hoses meet this requirement.

To clean the filter in the water inlet valve:

- Using pliers, carefully loosen the ribbed plastic nut on the inlet valve, and unscrew.

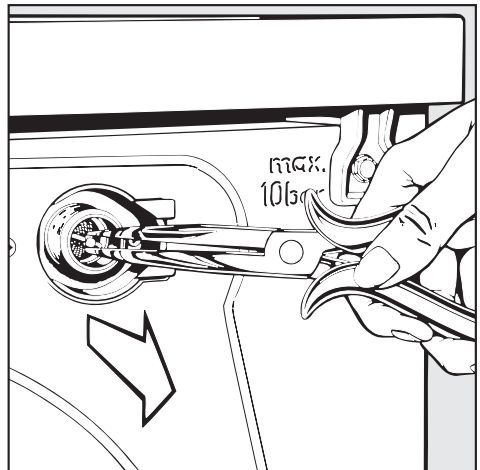

- Use water pump pliers to withdraw the plastic filter by the bar (see illustration). Clean, put back and secure.

The two filters **must** be put back in place after cleaning.

Repair work to electrical appliances should only be carried out by a suitably qualified person in accordance with local and national regulations. Unauthorised repairs could be dangerous.

What to do, if . . .	Cause . . .	Remedy . . .
. . . The programme does not begin	There is no power. The "Anti-crease-Finish" light is not on.	Check whether: <ul style="list-style-type: none"> – the door is properly closed. – the mains plug is plugged in. – the fuse or circuit breaker has not tripped.
. . . the "Check drain" light flashes during the programme, but the programme is running normally	The water outlet is restricted.	<ul style="list-style-type: none"> – Clean the fluff (drain) filter and drain pump. – Has the drain pump been fixed too high? (Max. drain height 1m).
. . . the "Check drain" light flashes during the programme, but the programme is not running normally.	The water outlet is blocked.	<ul style="list-style-type: none"> – Clean the fluff (drain) filter and drain pump. – Has the drain pump been fixed too high? (Max. drain height 1m).

Problem solving guide

What to do, if . . .	Cause . . .	Remedy . . .
<p>. . . the “Check (water) inlet” indicator flashes during the programme but the programme is running normally.</p>	<p>The water inlet is restricted.</p>	<ul style="list-style-type: none"> – The stopcock is not opened far enough. – The inlet hose is kinked. – The water pressure is too low – The filter in the inlet hose is dirty. Clean it.
<p>. . . the “Check (water) inlet” indicator flashes and the laundry was not washed.</p>	<p>The water inlet is closed.</p>	<ul style="list-style-type: none"> – Open the stopcock. – Start the programme again.
<p>. . . one of the following indicator lights is flashing</p> <ul style="list-style-type: none"> – “Soak/Pre-wash” – “Main Wash” – “Rinses” – “Rinse hold” 	<p>There is a fault.</p>	<ul style="list-style-type: none"> – Press “I-ON/O-OFF” button to release it. – Turn the programme selector to “Finish”. – Press “I-ON/O-OFF” button in. – Re-start the programme. – If the indicator light starts flashing again, call the Service Dept.

Problem solving guide

What to do, if . . .	Cause	Remedy
. . . the indicator light "Drain / Final spin" flashes.	The final spin has not taken place. The machine detected an imbalance.	<ul style="list-style-type: none"> – Loosen and re-distribute the washing. – Select the programme Spin or Drain. – Take into account the spin speed of the relevant programme.
. . . the indicator light "Anti-crease/Finish" flashes.	The position of the programme selector was altered after the start of the programme.	Turn the programme selector back to the programme previously chosen.
. . . the drum door cannot be opened.	The appliance is not plugged in to the electricity supply.	Put the plug in the socket.
	Power cut.	See "Problem solving guide", How to open the door after a power failure.
	The door was not correctly engaged.	Press hard against the lock side of the drum door and then press the "Door" button.
	There is still water in the drum.	<ul style="list-style-type: none"> – Select the "Drain" programme for the water to be pumped out. – Open the drum door.
	The suds temperature is higher than 55°C.	
. . . the machine shakes during the spin cycle.	The four feet are not resting evenly on the floor.	Level the machine. See 'Installation advice'.
. . . the washing has not been spun satisfactorily.	The spin speed selected was too low.	Select a higher spin speed next time.
	The load was not distributed sufficiently evenly in the drum. To protect the machine laundry was only spun at a reduced speed.	Always mix large and small items in the load.
. . . the pump makes strange noises.	These noises occur at the end of a pump sequence as a normal part of the operation. They are not a fault.	

Problem solving guide

What to do, if . . .	Cause	Remedy
<p>. . . large residues of detergent remain in the dispenser drawer.</p>	<p>The water supply pressure is too low.</p>	<ul style="list-style-type: none"> – Clean the filter in the water inlet system. – It may be useful to select “Water plus”.
	<p>Washing powder used with water softener tends to become sticky.</p>	<p>Pour washing powder into the dispenser before adding any water softener.</p>
<p>. . . fabric conditioner is not completely dispensed or too much water remains in the compartment.</p>	<p>The siphon tube is either incorrectly positioned or clogged.</p>	<p>Clean the siphon tube.</p>
	<p>The fabric conditioner channel is clogged.</p>	<p>Clean the fabric conditioner channel.</p>
<p>. . . grey, greasy particles cling to washed laundry.</p>	<p>Insufficient amounts of detergent were used to break down the particles of grease in heavily soiled laundry.</p>	<ul style="list-style-type: none"> – Add more detergent. – Before washing the next load run a “COTTONS 95°C” programme without a load. (See “Extra cleaning” in Cleaning and Care).
<p>. . . there are white residues which look like powder detergent on the washing.</p>	<p>The detergent contained compounds (zeolites) to aid water softening which are not soluble in water. These have ended up on the washing.</p>	<ul style="list-style-type: none"> – Use detergents containing no zeolites to re-wash the load. – Liquid detergents usually contain no zeolites. – Try and brush off the residues with a soft brush.
<p>. . . liquid detergent does not give the required result.</p>	<p>Liquid detergents do not contain bleaching agents. They do not remove fruit, coffee and tea stains.</p>	<ul style="list-style-type: none"> – Use a general purpose washing machine powder containing a bleaching agent. – Pour stain remover (salts) into the dispenser drawer compartment III, and liquid detergent into a dispenser ball. – Never put stain salts and liquid detergent together in the dispenser drawer.

Opening the drum door in the event of a power failure

- Switch off the washing machine.
- Open the fluff (drain) filter flap and drain the water as described in "Cleaning and care", (fluff (drain) filter and pump).

Caution: if laundry has been washed at a high temperature, water draining out of the machine will still be hot.

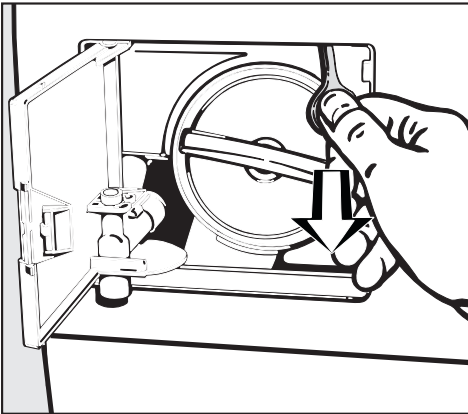

- Pull the emergency door latch downwards (see illustration). The machine door will then open.

Always make sure the drum is stationary before reaching in to the machine to remove washing. Reaching into a moving drum is extremely dangerous.

To check water pressure

- Place a bucket under the stopcock.
- Turn on the stopcock.

If 5 litres of water flow into the bucket in 15 seconds the water pressure is correct.

After sales service

Customer contact

In the event of any faults which you cannot remedy yourself please contact

- Your Miele Dealer or
- Your nearest Miele Service department (see back cover for the address).

When contacting the Service Department, please quote the Model and Serial nos. of your appliance, both of which are shown on the data plate visible above the porthole glass when the door is opened.

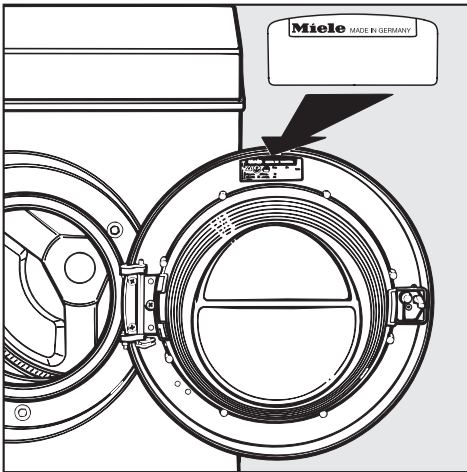

Please note that telephone calls may be monitored and recorded to improve our service.

Future updates (PC)

The indicator light or check light marked PC is reserved for the service engineer, for updates to your machine in future years.

When for example technological developments offer advanced modifications to your existing programme cycles, a service engineer will be able to input these into your machine controls.

Miele will provide information when such possibilities become available.

Installation surface

A concrete floor is the most suitable installation surface for a washing machine, being far less prone to vibration during the spin cycle than wooden floorboards or a surface with "soft" properties.

Please note the following points:

- The machine must be level and securely positioned.
- To avoid vibrations during spinning, the machine should not be installed on soft floor coverings.
- If installing on a wooden joist floor, we recommend a plywood base at least 30 mm thick, 590 x 520 mm wide. The base should span several joists and be bolted to the joists, not only to the floorboards. Check for the presence of pipes and cables first. The most stable part of the floor is usually in the corner.

If the machine is installed on a raised plinth, it **has to be** secured against slippage during spin using retaining clips (available from the Miele Spare Parts Dept).

Installation

Lift the machine from its packaging base and move it to its site. Please note:

- Do not lift the machine by the drum door.
- Ensure that the machine feet and the floor are dry to prevent the machine from slipping during the spin cycle.

Removing the transit fitting

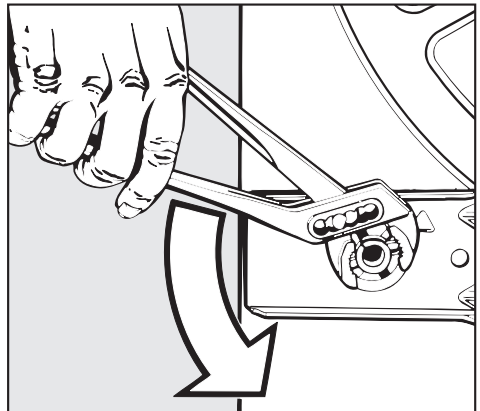

- Turn the left-hand transit bar 90°.

Installation

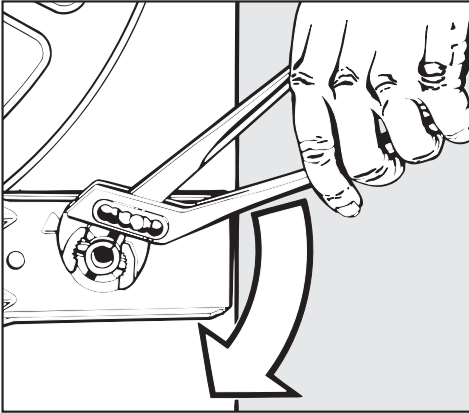

- Turn the right-hand transit bar 90°.

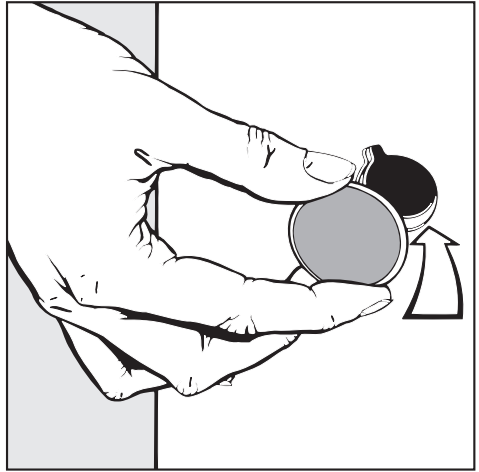

- Plug the two holes with the plastic caps supplied.

The machine should not be moved without the transit fitting in place.

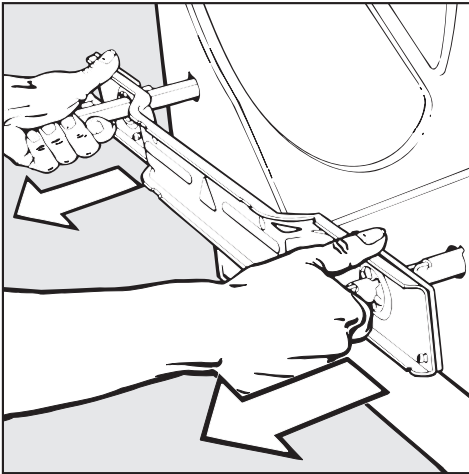

- Withdraw the two bars together with the support plate.

The transit fitting should be stored in a safe place for future use. It must be re-fitted if the machine is to be moved again. Re-fitting is carried out by reversing the procedure.

Levelling the machine

The machine must stand perfectly level on all four feet to ensure safe and proper operation.

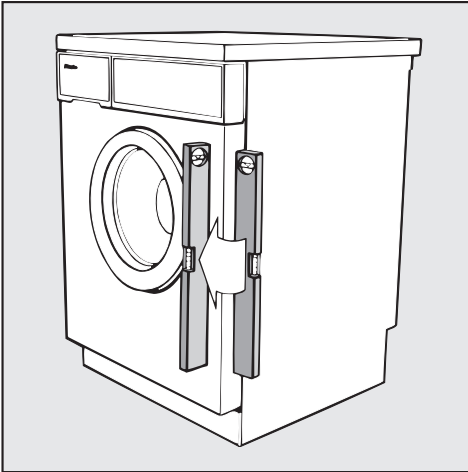

Incorrect installation may increase electricity and water consumption and may cause the machine to move about.

The four adjustable screw feet are used to level the machine. All four feet are screwed in when the machine is delivered.

Screwing out and adjusting the feet

- Gently tip the machine and prop it up using a solid wood wedge for example, to ensure stability.

Make sure the machine does not slip as this could cause injury.

- With a screwdriver loosen and turn the foot **1** together with the counter-nut **2** to the left, (see illustration below) and screw out.
- Put the machine back on all four feet.
- Use a spirit level to check the machine is standing level.

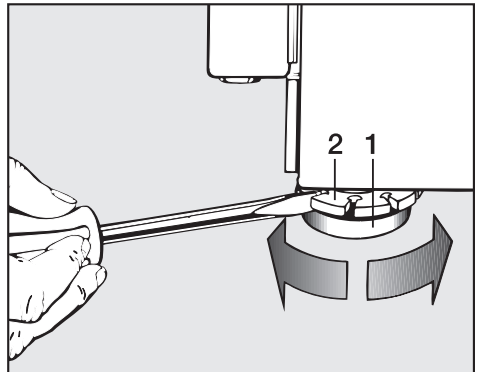

- Hold the foot **1** firm using a pipe wrench and turn the counter-nut **2** to the right firmly up against the housing with a screwdriver.

All four counter-nuts must be firmly up against the housing. Please also check this for the feet which did not need adjustment. Otherwise there is the danger of the machine moving about.

This machine is not intended for integrated installation or installation under a continuous worktop. The UBW kit cannot be used with sloping fascia machines.

Installation

N.B.

If there is enough space the machine can however be slid under a worktop **complete with its own lid which must not be removed**. The machine must be allowed to jut out sufficiently for the control panel not to be obscured.

- For installation under a work surface 900/910 mm from the floor, a raising kit* is required.

Connections for electricity, water and drainage should be installed in such a way that they remain accessible when the machine is in place.

Washer and Dryer stack

A Miele tumble dryer can be stacked with the washing machine. A stacking kit* is necessary and can be purchased from the Miele Spare Parts Department.

All parts marked* are available from the Miele Spare Parts or Sales Department, and must be fitted by a suitably competent person according to the instructions supplied with the kit.

Connection to water supply

The machine should be connected to a mains water supply in accordance with standard regulations. In Germany the washing machine is not required to have a non-return valve as it has been designed to comply with the relevant German DIN standard.

Connection to the mains water supply should incorporate a mains stopcock with 3/4" thread. The stopcock should be fitted by a qualified plumber.

The approx. 1.5 m long 3/8" pressure hose should be connected to the stopcock via the 3/4" threaded union.

This pressure hose is **not** suitable for connection to a hot water supply. Please make sure the washer sits correctly in the union.

The connection point is subject to mains water pressure. Turn on the stopcock slowly and check for leaks.

If replacing the inlet hose only use a hose able to withstand pressure of up to 70 bar. This also applies to all fixtures and fittings used. Miele original parts fulfil this condition.

Longer hoses 2.5 or 4 metres in length are available as optional extras.

The machine is designed to operate with a water flow pressure of 1 bar minimum up to 10 bar maximum. The static water pressure must not exceed 10 bar. If it is higher than 10 bar it is essential to fit a reducer valve.

There is a minimum flow pressure of 1 bar pressure if 5 litres of water flow into a suitable container in 15 seconds.

The two dirt filters - one in the open end of the inlet hose, one at the inlet point in the solenoid valve must not be removed.

Installation

Connection to the drainage system

The machine drains via a drain pump with a delivery head of 1 metre.

The drain hose is 1.5 m long. It must not be kinked as this restricts drainage. The swivel elbow at the end of the hose can be turned in either direction, or can be detached if required, with a sharp twist and pull.

Drain hose connection:

- Direct into a sink: Hook the hose over the edge and secure. Make sure that the water can flow freely to avoid flooding and to prevent water from being sucked back into the machine.
- Connected to a floor gully.
- Connected to a standpipe.
- Connected to a plastic drain pipe with a rubber nipple. There is no need to use a non-return valve.

If required, the drain hose can be extended to a length of 5 m. The necessary parts can be purchased from the Miele Spare Parts Department, or your Miele dealer.

For a delivery head of more than 1 m (up to a maximum of 1.8 m) a second Duo-drain pump is available with the corresponding conversion kit from the Miele Spare Parts Department or your Miele dealer.

Electrical connection U.K.

All electrical work should be carried out only by a suitably qualified and competent person, in strict accordance with national and local safety regulations.

The appliance is supplied with a mains cable with moulded plug for connection to a 230-240V mains supply. The voltage, rated load and fuse rating are given on the data plate. Please ensure these match the household mains supply.

Connection should be made via a fused plug and suitable switched socket which is easily accessible after installation. For extra safety it is advisable to install a residual current device (RCD), with a trip current of 30 mA. Do not connect via an extension lead.

Important

The wires in the mains lead are coloured in accordance with the following code:

Green/yellow = earth

Blue = neutral

Brown = live

Where it is necessary to change plugs, if the colours of the wires in the mains lead of this appliance do not correspond with the coloured markings identifying the terminals of your plug, proceed as follows:

The wire which is coloured green and yellow must be connected to the terminal in the plug which is marked with the letter E or by the earth symbol  or coloured green, or green and yellow.

The wire which is coloured blue must be connected to the terminal in the plug which is marked with the letter N or coloured black.

The wire which is coloured brown must be connected to the terminal in the plug which is marked with the letter L or coloured red.

WARNING: THIS APPLIANCE MUST BE EARTHED

Ensure power is not supplied to the appliance while installation work is being carried out.

Non-rewireable plugs BS 1363

If this machine is fitted with a non-rewireable plug, the following information applies:

If the socket outlets are not suitable for the plug supplied with the product, it must be cut off and an appropriate plug fitted.

The plug cut from the flexible cord should be disposed of and on no account be inserted into any socket elsewhere in the house (electric shock hazard).

The fuse cover must be refitted when changing the fuse, and if the fuse cover is lost, the plug must not be used until a suitable replacement is obtained. The colour of the correct replacement cover is that of the coloured insert in the base of the plug, or the colour that is embossed in words on the base of the plug (as applicable to the design of plug fitted).

Replacement fuses should be ASTA approved to BS 1362 and have the correct rating. Replacement fuse covers may be purchased from your local electrical supplier or Service agent.

Consumption data

Programme (without any additional options or programmable functions)	Load	Consumption data			
		Energy in kWh	Water litres	Programme time	
				normal	short
COTTONS					
95°C	5.0 kg	1.70	52	1 h 54 mins	1 h 26 mins
60°C*	5.0 kg	0.95	52	1 h 58 mins	1 h 16 mins
40°C	5.0 kg	0.55	52	1 h 58 mins	1 h 06 mins
MINIMUM IRON					
40°C	2.5 kg	0.45	58	1 h 20 mins	49 mins
DELICATES					
30°C	1.0 kg	0.40	75	58 mins	49 mins
Woolens					
30°C	1.0 kg	0.15	25	35 mins	–

* EN 60456

Consumption data can vary from the nominal values given depending on water pressure, water hardness, water inlet temperature, room temperature, type and volume of load, fluctuations in the electricity supply and any additional functions selected.

N.B.

Consumption data obtained from a machine designed for the German market.

Technical Data

Height	85 cm
Width	59.5 cm
Depth	60 cm
Depth with door open	97 cm
Weight	92 kg
Max. floor load	1600 Newton (approx. 160 kg)
Capacity	5 kg dry laundry
Voltage	} see Data plate
Rated load	
Fuse rating	
Water flow pressure min.	1 bar
Static water pressure max.	10 bar
Drain pump head max.	1 m
Drain pump length max.	5 m
Test certificates awarded	Radio/TV suppression, VDE



United Kingdom

Miele Co. Ltd., Fairacres, Marcham Road, Abingdon, Oxon, OX14 1TW

tel. Abingdon (01235) 554455 - fax (01235) 554477

Service Office, tel. Abingdon (01235) 554466

Free Manuals Download Website

<http://myh66.com>

<http://usermanuals.us>

<http://www.somanuals.com>

<http://www.4manuals.cc>

<http://www.manual-lib.com>

<http://www.404manual.com>

<http://www.luxmanual.com>

<http://aubethermostatmanual.com>

Golf course search by state

<http://golfingnear.com>

Email search by domain

<http://emailbydomain.com>

Auto manuals search

<http://auto.somanuals.com>

TV manuals search

<http://tv.somanuals.com>