



Operating instructions for washing machine W 916



It is essential to read these operating instructions before installing or using the machine to avoid the risk of accident, or damage to the machine.



M.-Nr. 04616330

Contents

	page
Guide to the machine	3
Warning and Safety instructions	5
Preparation for use	
Help to protect our environment	8
Operation	
Washing environmentally and economically	9
How to wash correctly (brief instructions)	10
Changing a programme sequence	12
Adding or removing washing after programme start	13
Adding detergent	14
Adding fabric conditioner	15
Programme chart	16
Programme sequence	18
– Wash care symbols	20
Additional options	21
Delay start/time left display	22
Maintenance	
Cleaning and Care	23
What to do if, . . . ?	27
After-sales service	32
Installation and connection	
Installation	33
Plumbing	37
Electrical connection	41
Activating the programmable functions	42
Consumption data	47
Technical data	48

Guide to the machine

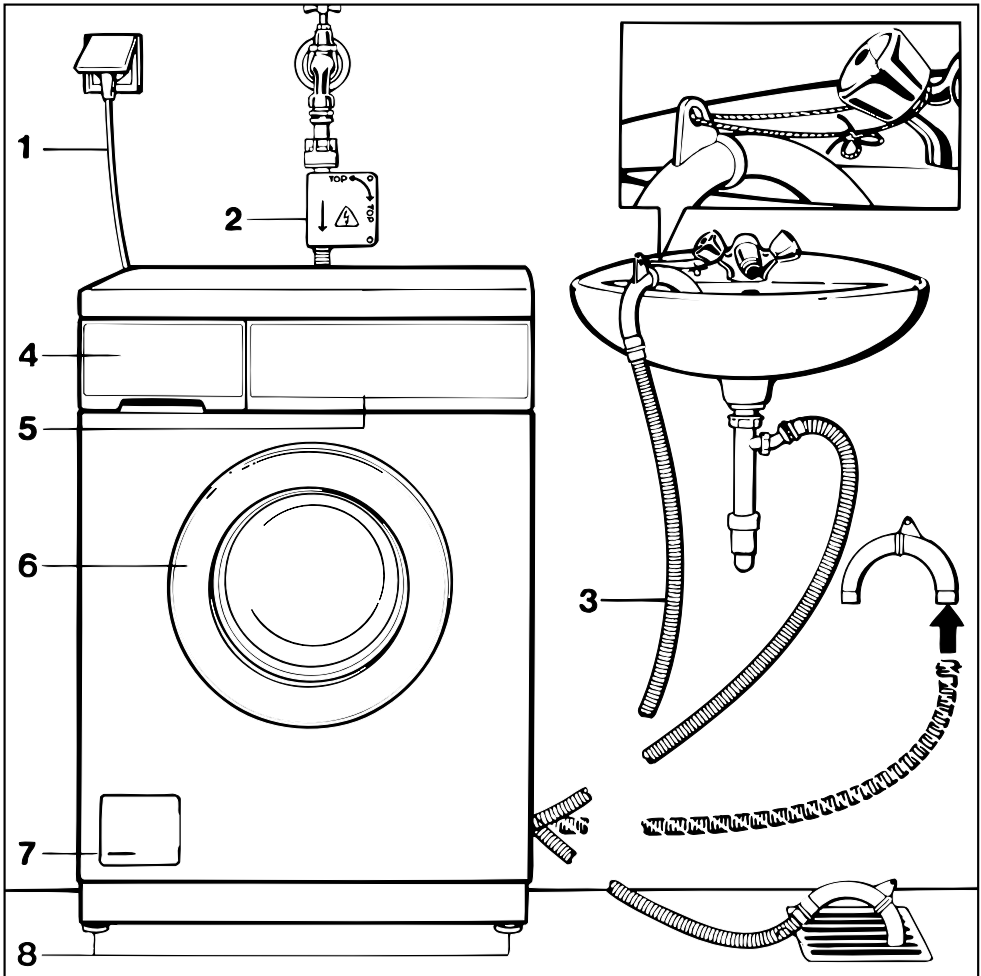

- | | |
|---|--|
| 1 Electric supply cable | 5 Facia panel with controls |
| 2 Inlet hose with "Waterproof" system | 6 Drum door |
| 3 Flexible drain hose (with detachable swivel elbow) | 7 Panel for access to fluff filter, drain pump and emergency release |
| 4 Detergent dispenser drawer | 8 front: two height-adjustable leg-levelers
rear: automatic leveller |

Guide to the machine

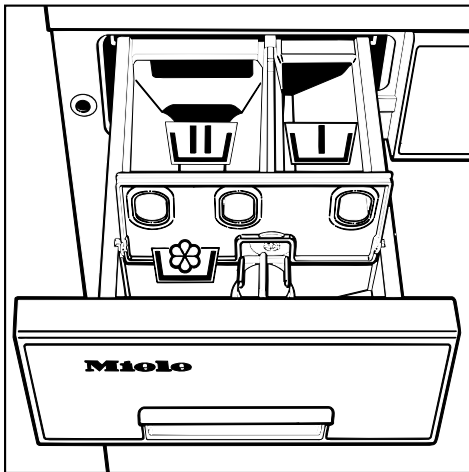

Detergent dispenser drawer

Compartment  - Pre-wash

Compartment  - Main wash

Compartment  (with lid) - Conditioner

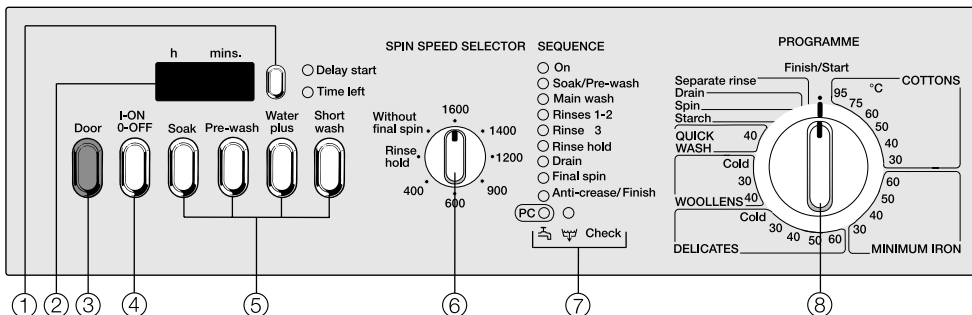

- ① "Delay start" button
- ② Time display "h mins"
- ③ "Door" pushbutton opens the drum door
- ④ "I-ON/O-OFF" switches the machine on/off or interrupts the programme
- ⑤ Pushbuttons for additional programmable options
- ⑥ Spin speed selector
- ⑦ Programme sequence indicator (LED control lights)
- ⑧ Programme selector

Warning and Safety Instructions

Read the operating instructions before using this machine for the first time. They contain important information about the safety, use and maintenance of the machine. This will avoid the risk of accidents and damage to the machine.

Keep these operating instructions in a safe place and ensure that new users are familiar with the content. Pass them on to any future owner of the machine.

Correct usage

Only use the washing machine to wash items which are declared by the manufacturer to be machine-washable on the wash-care label. Any other applications may be dangerous. The manufacturer is not liable for damage resulting from improper use or operation.

Technical safety

Before setting up the machine, check it for any externally visible damage.

Before connecting the machine, ensure that the connection data on the data plate (fusing, voltage and frequency) matches the mains electricity supply. If in any doubt, consult a qualified electrician.

The electrical safety of this machine can only be guaranteed when continuity is complete between the machine and an effective earthing system which complies with local and national regulations. It is most important that this basic safety requirement is regularly tested by a qualified electrician.

The manufacturer cannot be held responsible for the consequences of an inadequate earthing system.

The machine is built in accordance with current safety requirements. Unauthorised repairs could result in unforeseen dangers for the user, for which the manufacturer cannot accept responsibility. Repairs should only be undertaken by a Miele approved engineer.

The machine is only completely isolated from the electricity supply when:

- it is switched off at the wall socket and the plug is withdrawn, or
- it is switched off at the mains, or
- the mains fuse is withdrawn.

Warning and Safety Instructions

■ The Miele "Waterproof system" protects from water damage when:

- The machine is correctly plumbed in.

If a fault has been identified, the machine must be examined by a competent person before further use.

■ Faulty components must only be exchanged for Miele original spare parts. Only when these parts are fitted can the safety standards of the machine be guaranteed.

Use

■ Do not install your washing machine in rooms where temperatures below freezing may occur. Frozen hoses may burst under pressure. The reliability of the electronic control system may be impaired at temperatures below freezing point.

■ In countries where there are areas which may be subject to infestation by cockroaches or other vermin, pay particular attention to keeping the appliance and its surroundings in a clean condition at all times. Any damage which may be caused by cockroaches or other vermin will not be covered by the appliance guarantee.

■ Before using the machine for the first time, check that the transit fitting at the rear of the machine has been removed (see section on "Installation"). During spinning, a transit fitting which is still in place may result in damage to both the machine and adjacent furniture or appliances.

■ Turn off the stopcock if the machine will be left for any length of time (e.g. holiday), especially if there is no floor drain (gully) in the immediate vicinity.

■ Flooding danger.

■ If hooking the drain hose into a wash basin, check that the water can drain off quickly enough to prevent the sink from overflowing.

Make sure the drain hose is secure, so that the force of the water flowing out of the hose does not dislodge it. Otherwise this will result in flooding.

■ Take care to ensure that foreign objects (e.g. nails, needles, coins, paper clips, etc.) do not find their way into the machine with the washing (e.g. in pockets). Foreign objects can damage components of the machine, which in turn can result in damage to the washing.

Warning and safety instructions

■ If the correct amount of detergent is dispensed, the machine should not need to be descaled. If, however, you do wish to descale the machine only use proprietary non-corrosive descaling agents and strictly observe the instructions. Consult the Miele Customer Service Department.

■ Textiles which have been pre-treated in detergents containing solvents must be thoroughly rinsed in clean water before being washed in the machine.

■ Never use detergents containing solvents in this machine, as this may result in damage to component parts and create toxic fumes. Such detergents also pose a fire and explosion hazard.

■ Dye removers may contain sulphur compounds which may damage washing machines. Only use dyes or dye removers specified by the manufacturer as being suitable for use in a washing machine. Always observe the manufacturer's instructions carefully.

■ If washing at very high temperatures remember that the porthole glass will be hot. Do not let children touch it during a hot wash programme.

■ Always make sure the drum is stationary before reaching in to remove washing. Reaching into a moving drum is extremely dangerous.

■ This machine is intended for domestic use, and the guarantee is on this understanding. If the machine is used in a commercial environment, the user is responsible for ensuring conformity to all relevant regulations.

Accessories

■ Accessory parts may only be fitted when expressly approved by Miele. If other parts are used, guarantee, performance and product liability claims may be invalidated.

Disposal of your old machine

■ Before discarding an old machine unplug it. Render the plug useless. Cut off the cable directly behind the appliance to prevent misuse.

Help to protect our environment

Disposal of the packing material

The transport and protective packing is mostly manufactured from the following recycled or re-useable materials:

- corrugated paper/card
- polystyrene - CFC-free
- untreated surplus wood
- chipboard, contains no phenolic resins
- polyethylene foil (PE)
- packaging straps: polypropylene (PP)

Rather than just throwing these materials away, please take them to the nearest local authority collection point for specific waste.

Disposal of your old machine

Old machines may contain material which can be reclaimed or recycled. Please contact your dealer, your local waste collection centre or scrap merchant about potential recycling schemes.

Ensure that the machine presents no danger to children while being stored for disposal.

See the appropriate section in the Warning and Safety instructions.

Washing environmentally and economically

Caring for the environment means saving water, energy and detergent when washing but without compromising on results.

The key to a good wash result is finding the best combination of amount of detergent, temperature, length of programme and the machine's technology.

If necessary, some programmes are longer to achieve this effect. With the "Hydromatic" system, the drum can revolve at different speeds. Longer and slower action together with pauses for steeping, work towards a good result.

The automatic load control facility ensures the correct water level for the type of fabric and laundry load being washed. Sometimes it even appears that there is no water in the drum.

Normally, main wash is sufficient for a clean result, so a pre-wash is not automatically included in the programmes. If it is wanted, a simple press on the pre-wash selector includes it.

Economy tips

To help you wash most economically, remember the following tips:

- The automatic load control facility allows you to wash individual loads of between 1 and 5 kg. Ideally wash with the maximum load specified for each programme. This uses the energy to the best advantage.
- Only use the correct amount of detergent required for the water hardness level in your area, according to the detergent manufacturer's recommendations.
- If washing is not heavily stained, select a lower temperature setting than indicated on the wash care label but do not additionally select "Short".
- Use the "Short wash" option for washing that is only very lightly soiled, but do not additionally reduce the temperature.
- Using the additional "Soak" option allows you to reduce the temperature used in the main wash.

How to wash correctly

The headings numbered (1, 2, 3, ...) show the operating sequence and can be used as a brief guide.

Before washing

1 Prepare the wash load

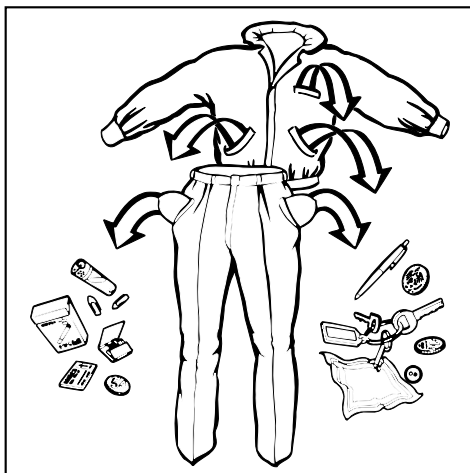

- Empty all pockets.

Foreign objects (e.g. nails, coins, paper clips etc) can cause damage to textiles and components in the machine.

- Sort the washing

Most garments have a textile care label in the collar or side seam. Sort the washing by care label symbols. The symbols are explained on page 20. Only wash items in this machine which are declared by the manufacturer as being machine washable on the textile care label.

Dark textiles often contain excess dye and should be washed separately sev-

eral times before being included in a mixed load.

Delicate textiles should be washed separately in a delicates programme.

Only wash textiles made from wool or wool mixtures if the textile care label states that they are suitable for machine washing.

- Pre-treating the washing
Badly soiled areas, e.g. collars and cuffs, and water soluble stains can be pre-treated with bar soap, liquid detergent or detergent mixed into a solution or paste.
With particularly stubborn stains ask your Dry Cleaner for advice.
Do not use solvent based cleaning agents in this machine.

2 Open the door and load the drum

Unfold washing and load loosely in the drum. To achieve best results it is advisable to make up mixed loads consisting of both large and small items.

This improves the washing effect and helps distribute the load evenly to keep the machine stable and reduce the noise level during spinning.

Overloading reduces the wash result and causes more creasing.

Maximum load weights are noted below:

COTTONS	5.0 kg
MINIMUM IRON	2.5 kg
DELICATES/SYNTHETICS	1.0 kg
WOOL	1.0 kg
QUICK WASH	2.5 kg
SEPARATE RINSE	5.0 kg

How to wash correctly

Curtains:

Remove lead weights and strips or place in a laundry bag.

Any loose wiring in bras etc., should be removed or sewn in.

Woollens and knitted garments:

Turn inside out, if the manufacturer recommends it.

3 Close the drum door

Make sure that there is no obstruction between the drum door and seal.

4 Open the stopcock.

5 Add detergent.

See Section on Detergent for details.

To start a programme

1 Turn the programme selector to Finish / Start.

2 Press the "I-ON/O-OFF" button.

3 Press additional option button where required

See Section on the "Delay start" option.

4 Select spin cycle speed

5 Position the programme selector on the the desired programme

The programme selector can be turned to the left or the right.

After washing

1 Turn the programme selector to "Finish/Start"

2 Press the "I-ON/O-OFF" button.

3 Press the "Door" button.

Only remove washing from the machine once the drum has stopped turning, otherwise you may seriously injure yourself.

4 Remove the washing

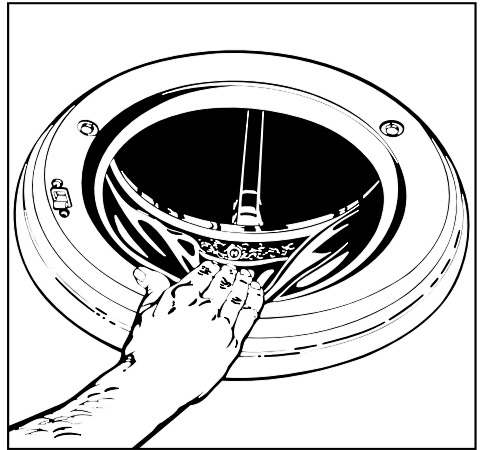

5 Check the folds in the door seal for any small articles such as buttons which might be lodged there.

Make sure the drum is empty, otherwise, when the machine is next used items may become damaged (e.g. shrink) or cause other washing to discolour.

6 Close the drum door.

Otherwise there is a danger of objects being placed inadvertently in the drum. If these remained unnoticed and were washed in the next load, they could damage the washing.

Changing the programme sequence

Stopping a programme

- Turn the programme selector to “Finish/Start”.

Interrupting a programme

- Press the “I-ON/O-OFF” button.

To continue the programme, switch the machine back on.

Changing an incorrectly selected programme:

- Turn the programme selector to “Finish/Start”.

A new programme can be selected when only the “ON” indicator light is still on.

Changing a programme which has been locked, see Section on Activating programmable functions.

To omit a programme stage.

- Turn the programme selector to “Finish/Start”

As soon as the programme sequence light for the stage at which the programme should continue starts flashing:

- turn the programme selector switch to the appropriate programme **within 3 seconds**.

Adding or removing washing after programme start

Washing can be added or removed after the programme has already started, when using the following programmes:

- COTTONS
- MINIMUM IRON
- QUICK WASH 40°C
- Press the “Door” button in and hold it until the door springs open. Add or remove items.
- Press the “Short wash” button if it had previously been selected.
- Shut the door.

COTTONS and QUICK WASH 40°C

The door can be opened in the following programme stages:

- Main wash
- Rinses

Please note that the door can only be opened when the suds temperature is less than **55°C**.

MINIMUM IRON

The door can be opened during the following programme stage:

- Main wash

Washing cannot be added later if using the following additional options or functions:

- “Water plus” (the water level is increased)
- Programme lock (e.g. to prevent children from opening the door during the wash cycles).

Adding detergent

All modern detergents produced for automatic washing machines are suitable, including liquid, compact (concentrated) and special application detergents. Use dispensing aids, e.g. balls, if these are supplied with the detergent. Woollens and knitwear containing wool mixtures should be washed using a detergent specifically designed for washing woollens. Amounts of detergent are recommended on the packaging. The right amount to dispense will depend on the following:

- the quantity of the washing
- the water hardness level (check with your local water supplier)
- the level of soiling

Water Hardness

Hardness range	Type of water (hardness)	Total hardness (mg/l)	°dH (German)
I	soft	0 - 130	0° - 7°
II	medium	130 - 250	7° - 14°
III	hard	250 - 380	14° - 21°
IV	very hard	over 380	over 21°

It is important to dispense the correct amount, because...

...too little detergent results in the following:

- The washing will not be properly clean and will in time become grey and hard to the touch.
- Greasy particles cling to the washing.
- Lime deposits on the heater elements.

...too much detergent results in the following:

- Excessive foam.
- Low level of agitation.
- Poor washing and rinsing results.

Water is taken in through compartment **U** in the main wash. If the capacity of compartment **U** is insufficient for the amount of detergent needed (e.g. in very hard water areas), the Customer Service Engineer can adjust the machine so that water and detergent can also be taken into the main wash through compartment **L**.

Water Softeners

A water softener can be used to cut down on the use of detergents in water hardness ranges II-IV. Dispense according to the amount specified on the packaging. First add detergent and then the water softener.

Use a quantity of detergent as for soft water.

We recommend: if you wash using several components (e.g. special application detergents), dispense the agents in the following order into compartment **U** :

1. Detergent
2. Water softener
3. Stain salts

This way the agents are distributed better.

Fabric conditioners/starch formulations

Fabric conditioners/Texturisers

Fabric conditioners make garments soft and fluffy to handle and help prevent static cling when tumble drying. Dispense according to the manufacturer's instructions.

Texturisers are synthetic starch formulations and give body to items e.g. shirts, tablecloths and bed linen.

- Open the lid of compartment .

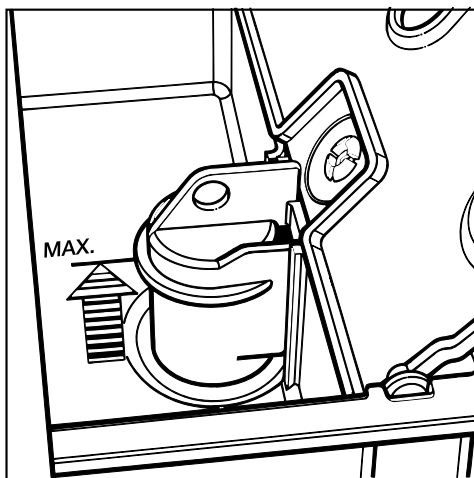

- Add fabric conditioner, but do not exceed the max. level mark..
- Close the compartment lid and push the drawer back in.
- The conditioner is automatically dispensed in the last rinse. At the end of the programme a small amount of water remains in the fabric conditioner compartment .
- If preferred, select “Rinse hold” to allow the load to steep in the fabric conditioner / retexturiser.

Starch / liquid starch

- Prepare and dispense the starch solution in accordance with the manufacturer's instructions.
- Add to compartment .
- Select the spin speed.
- Turn the programme selector to “Starch” .
- The “Soak / Pre-wash” indicator will light up.
- If the washing is not to be spun at the end of the programme after starching, turn the spin speed selector to “without final spin”. Water will be drained away at the end of the starch stage.
- If the washing is to be steeped in the starch solution after the starch stage (to lessen creasing), turn the spin speed selector to “Rinse hold”.

To continue:

select a spin speed.

Programme selection

Programme	Fabric	Temperature range
COTTONS 	Cottons and linen fabrics eg bedlinen, table linen, towelling, jeans, T-shirts and nappies.	95°C to 30°C
MINIMUM IRON 	(60°C) white nylon white polyester fabrics, (50°C) coloured nylon, polyester, cotton and viscose fabrics with special finishes, acrylic cotton fabrics, coloured polyester / cotton fabrics. (40° / 30°C) minimum iron fabrics not washable at higher temperatures, (60 - 30°C).	60°C to 30°C
DELICATES 	Acrylics acetate and triacetate, socks and stockings in man-made fibres (not wool or wool blends), (+ gentle action if needed).	60°C to cold
WOOL	Curtains declared machine-washable by the manufacturer (pre-wash probably advisable)	30°C to cold
	Programme for machine-washable wool fabrics bearing the machine-washable care label (there is not a pre-wash option)	40°C to cold
QUICK WASH 40°C 	Very lightly soiled fabrics.	40°C
Starch	Table cloths, napkins, overalls, uniforms	cold
Spin	Articles which can be spun eg handwashed items	
Drain	For use when the cycle stops at "Rinse hold" and the washing is not to be spun.	
SEPARATE RINSE	Articles which should be washed by hand and only rinsed and spun in the machine.	cold

Programme selection

max. load	Additional options	Notes
5 kg	<ul style="list-style-type: none"> – Soak – Pre-wash – Water plus – Short wash 	with heavily soiled items select “Soak” or “Pre-wash”
2.5 kg	<ul style="list-style-type: none"> – Soak – Pre-wash – Water plus – Short wash 	<p>with heavily soiled items select “Soak” or “Pre-wash”</p> <p>For lightly soiled items select “Short wash”</p>
1 kg	<ul style="list-style-type: none"> – Soak – Pre-wash – Short 	Use the Wool programme for textiles with wool content. If “cold” is selected for the temperature, the water is warmed to 24°C. This helps the effect of the detergent
Fill the drum loosely 1/2 to 3/4 full	<ul style="list-style-type: none"> – Soak – Pre-wash – Short 	Dust in curtains usually makes pre-wash advisable.
1 kg		If “cold” is selected for the temperature, the water is warmed to 24°C. This helps the effect of the detergent
2,5 kg	– Water plus	Add less detergent (half load)
5 kg		The washing should be washed but not treated with fabric conditioner.
5 kg		
5 kg		

See Section on Additional options for more details.

Programme sequence

	COTTONS	MINIMUM IRON	DELICATES
Soak	optional	optional	optional
Pre-wash	optional	optional	optional
Main wash	●	●	●
Top-up rinse	from 75°C	–	–
Graduated rinsing	–	from 50°C	from 50°C
No. of rinses – normal	3 or 4 ¹⁾	3	3
–Part load	2	3	3
–Short wash	2	2	3
Rinse and interim spin (rpm)	max. 1000	max. 500	–
Final spin (rpm)	max. 1600	max. 900	max. 600
Anti-crease spin and loosen	max. 30 mins	max. 30 mins	max. 30 mins
Rinse hold	optional	optional	optional
without final spin	optional	optional	optional
Wash rhythm	normal	normal	gentle action
Water level – Wash	low ²⁾	low ²⁾	high
– Rinse	low ²⁾	medium ²⁾	high

Explanations:

- Function included
- Function not included

¹⁾ **A 4th rinse** automatically switches in if there is too much foam in the drum, or if a spin speed lower than 800 rpm has been selected.

²⁾ Increasing the water level:

The water level can be increased from a low level to a higher level by pressing the “Water plus” button.

Top-up rinse:

Additional water flows into the drum, and the suds are cooled slightly. Hot water might damage plastic drain pipes.

Graduated rinsing:

The suds are cooled at the end of the wash cycle by water flowing in and being pumped away at intervals. This minimises the danger of creasing, by avoiding sudden temperature changes.

WOOL:

Wool is susceptible to damage from movement when it is wet. Drum movement times during the programme are shorter, and the drum rotates more slowly.

Programme sequence

QUICK WASH 40°C	WOOL	Starch	Spin	SEPARATE RINSE
–	–	–	–	–
–	–	●	–	–
●	●	–	–	–
–	–	–	–	–
–	–	–	–	–
2	3	–	–	2
2	3	–	–	–
–	–	–	–	–
max. 500	–	–	–	–
max. 1600	max. 900	max. 1600	max. 1600	max. 900
max. 30 mins	–	max. 30 mins	max. 30 mins	–
optional	optional	optional	–	optional
optional	optional	optional	–	optional
normal	Wool	normal	–	–
low ²⁾ medium	medium high	low –	– –	high

Final spin:

The maximum spin speed according to the programme is held constant for a fixed period of time. In the programmes MINIMUM IRON, WOOL and SEPARATE RINSE the spin speed is automatically limited to 900 rpm and in the DELICATES programme to 600 rpm, even if the selector has been set to a higher spin speed. A lower speed can be selected.

Anti-crease, spin and loosen:

The anti-crease action guards against the tendency for creases to set in when fabrics have been left in water for a long time. There is drum movement twice a minute. The anti-crease phase can be cancelled by pressing in the "Door" button.

Rinse hold:

Interim rinse and spin is carried out in the relevant programmes.

At the end of the final rinse the washing remains suspended in water, if the spin speed selector is set to "Rinse hold".

This helps to reduce the possibility of creasing, if the washing is left for some time before being taken out of the machine.

Without final spin:

Interim rinse and spin is carried out in the relevant programmes.

Washing is not spun after the final rinse, but the water is drained away, and the machine goes straight into the anti-crease stage.

Textile care symbols

Washing

Cottons

Minimum iron

Delicates/Synthetics

Woollens

no bar normal (maximum) agitation
eg Cottons programme

bar reduced (medium) agitation
eg Minimum iron programme
+ Gentle action, or Delicates programme

broken bar much reduced (minimum) agitation, Woollens programme

Machine washable woollens

Use the special "Wool" programme, and only wash woollens bearing the label shown here:



This symbol is registered by the IWS (International Wool Secretariat).

Hand wash

do not wash

dry clean

do not dry clean

suitable for chlorine bleaching

not suitable for chlorine bleaching

Tumble dry

at normal temperature

at a lower temperature

do not tumble dry

Ironing

hot iron

medium hot iron

cool iron

do not iron

N.B. If you have any textiles with the older wash care labels, select a programme according to the label below.

Cottons

Minimum iron

Delicates

Woollens

Each of the following buttons can be pressed in to give an additional option.

When the “Door” button is pushed in, all the other buttons spring out again, and the additional options are cancelled.

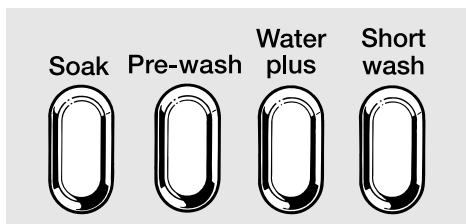

The following options are additionally available for certain wash programmes:



“Soak”

- For heavily soiled and stained items with dried on stains, or ones which can be bleached out, (e.g. blood, fats and oils, cocoa).
- Soak duration:
2 hours.
- The amount of detergent recommended by the detergent manufacturers should be distributed according to the wash programme which is to be run after the “Soak” process.

Programmes without pre-wash:

Add the total amount of detergent to compartment  or directly into the drum on top of the laundry.

Programmes with pre-wash:

1/4 of the detergent should be added to compartment  for the soak and pre-wash, and 3/4 added to compartment  for the main wash.

“With pre-wash”

- For heavily soiled and stained items.

“Water plus”

- This is recommended for particularly delicate fabrics, and
- if more water is required for dispensing the detergent.
- the water level increases in all sections of the programmes COTTONS, MINIMUM IRON and QUICK WASH 40°C.

“Short wash”

- The length of the main wash is shortened for lightly soiled items. An additional reduction in temperature is not recommended as this may lead to poorer wash results.
- In the COTTONS and MINIMUM IRON programmes only two rinse cycles are carried out at high water level.

Delay start/Time left indicators

Delay start

The start of a programme can be delayed by up to 9 hours 30 minutes.

N.B.:

The machine must be switched on and the indicator light “Delay start” flashing.

1 Select time delay.

Press the “Delay start” pushbutton until the required delay period shows in the display.

Each press of the button increases the delay by 30 minutes.

2 Select the programme.

The “Delay start” indicator light stays on constantly.

The display counts back in 1 minute steps. After the appropriate time has elapsed, the “Delay start” light will go out.

The “Time left” indicator light will come on and the time remaining in the programme selected will be shown.

Deleting “Delay start”

- Press the pushbutton when “9 h 30 mins” shows in the display.

Time left

Programme duration shows in hours and minutes, as soon as:

- the programme selector switch is set to the required programme
- the delay start period has elapsed.

After the programme has started, the time left display counts down in 1 minute intervals.

At the beginning of a programme, the duration of the programme for a full load will be displayed.

In the COTTONS programme, the type and volume of the wash will be monitored during the first water inlet phase. With a part load the time display shows a shorter time of up to 40 minutes.

Cleaning the washing machine

- Clean the casing with a mild non-abrasive detergent or soap and water. Wipe dry with a soft cloth.
- Clean the fascia panel with a damp cloth and dry with a soft cloth.
- The drum can be cleaned using a suitable proprietary stainless steel cleaner.

Do not use abrasive cleaners or solvents.

Detergent dispenser drawer

- Pull out the detergent dispenser drawer until a resistance is felt.

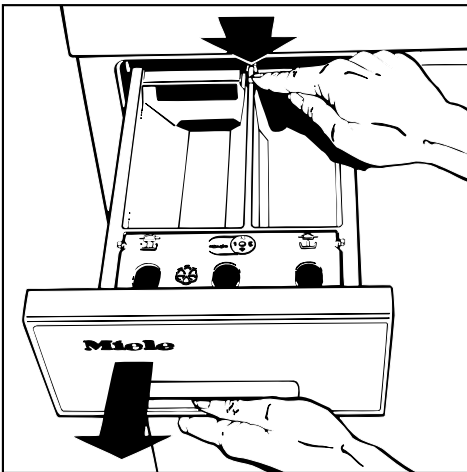

- Press down the red release knob and at the same time pull the drawer right out of the machine.

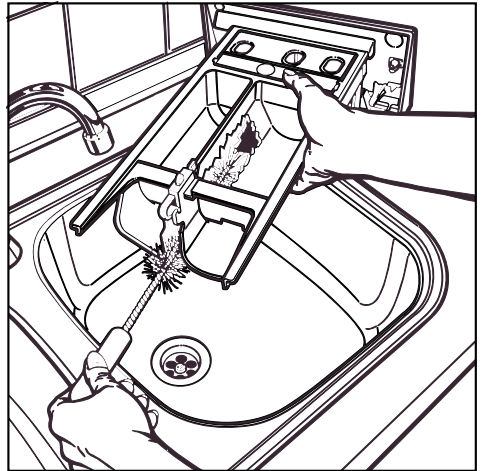

- Clean the detergent dispenser and conditioner dispenser compartments.

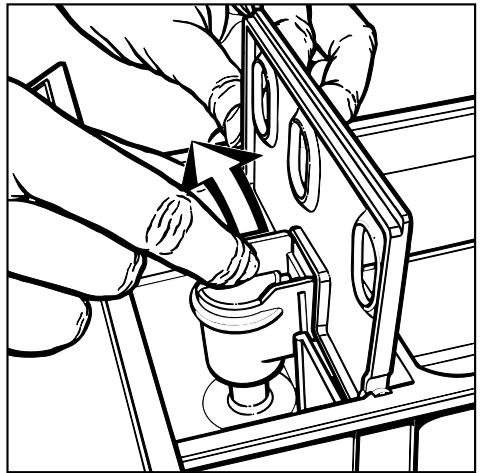

- Remove the suction tube from compartment , wash under running warm water and replace.

Cleaning and care

Cleaning the fluff filter and pump

Check the fluff filter initially after 3 - 4 washes to ascertain how often it is likely to require cleaning.

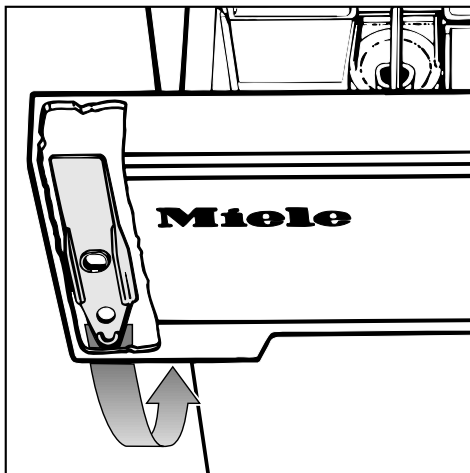

The opener for the fluff filter panel is on the side of the detergent dispenser drawer towards the rear.

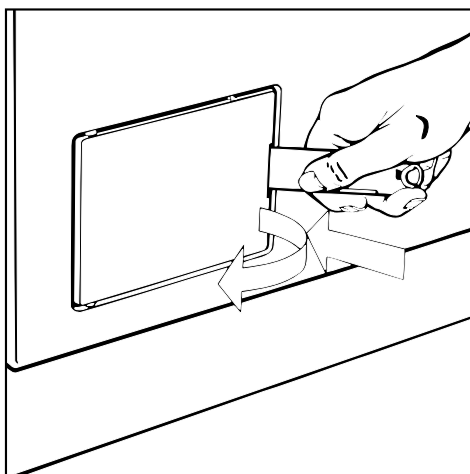

- Open the panel

- Place a dish underneath the drain fixture.

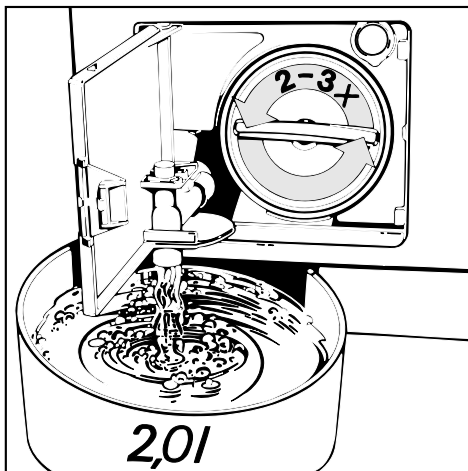

- Turn the fluff filter lid round 2 - 3 times. **Do not** take it right out. Approx. 2 litres of water will drain out of the hose.

If the drain outlet is clogged, more water will be retained in the machine (**max. 25 l**). In this case, screw the fluff filter back into position and empty the dish before repeating the procedure as often as necessary.

Caution: if laundry has been washed at a high temperature, water draining out of the machine will still be hot!

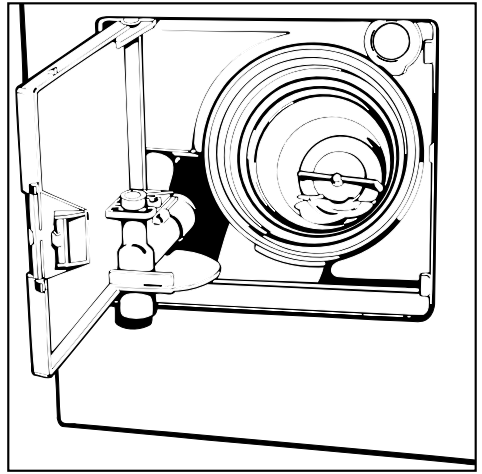
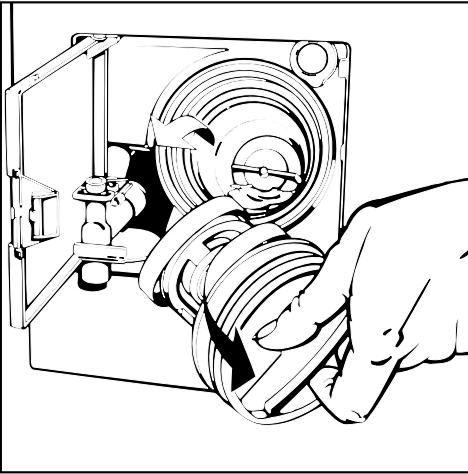

- Once the flow of water ceases, remove the fluff filter completely and clean it.
- Remove any foreign bodies (e.g. buttons, coins, etc.) and fluff.
- Turn the impeller by hand to check that it is free to rotate. Any foreign objects causing an obstruction should be removed.
- Clean the inside of the fluff filter housing.

Remove any deposits of lime scale and detergent or foreign bodies from the thread of the filter housing and filter unit (as these objects can cause a leakage of water).

Cleaning and care

Cleaning the filter in the water inlet

(First turn off the stopcock)

The washing machine has two inlet filters to protect the inlet valves.

- in the open end of the inlet hose.
- in the inlet connection between the hose and the machine, only to be cleaned by a Service engineer.

The filter in the inlet hose should be cleaned about every six months, or after an interruption to the external water supply.

To clean the filter in the inlet hose:

- Turn off the stopcock.
- Unscrew the inlet hose from the stopcock.



- Remove the rubber seal from the recess.
- Using pointed pliers, take hold of the plastic filter bar, remove the filter and clean.
- Put the filter and seal back in the reverse order and reconnect the hose.

Turn on the stopcock and check the connection is watertight. If water drips out, tighten the connection.

Never forget to put the inlet filter back in place after cleaning it.

Repair work to electrical appliances should only be carried out by a suitably qualified person in accordance with local and national regulations. Unauthorised repairs could be dangerous.

What to do if, . . .	Cause . . .	Remedy . . .
<p>. . . The programme does not begin?</p>	<p>There is no power. The "ON" LED has not lit up.</p>	<p>Check that..:</p> <ul style="list-style-type: none"> - the door is properly closed. - the mains plug is plugged in. - the fuse or circuit breaker has not tripped.
	<p>There is power and the "ON" LED is lit up, but the programme selector has not been turned to the "Finish / Start" position.</p>	<ul style="list-style-type: none"> - Turn the programme selector to the "Finish / Start" position. - Select a programme.
<p>. . . The "Check water inlet / outlet" LED's are flashing?</p>	<p>The water inlet is blocked. The "Check water inlet" LED is flashing, but the programme has run normally?</p>	<ul style="list-style-type: none"> - The stopcock is not opened far enough. - The inlet hose is kinked. - The water pressure is too low. Call the Service Dept.
	<p>The water inlet system is blocked. The "Check water inlet" LED is flashing and the "Finish" light is on in the Sequence display but the load in the machine has not been washed.</p>	<ul style="list-style-type: none"> - Turn the programme selector to the "Finish / Start" position. - Open the stopcock. - Select a programme.
	<p>The water outlet is blocked. The "Check water outlet" LED is flashing.</p>	<ul style="list-style-type: none"> - Clean the drain pump and fluff filter. - Has the drain pump been fixed too high? (max drain head 1 metre).
	<p>The Waterproof system has reacted. The "Check water inlet / outlet LEDs" are flashing.</p>	<ul style="list-style-type: none"> - Call the Service Dept.

What to do if, . . .	Cause . . .	Remedy . . .
. . . the "Soak/Pre-wash" or "Main wash" or "Rinses 1-2" LED is flashing?	There is a fault.	Start the programme again. If the LED starts flashing again call the Service Dept.
. . . The "Rinse hold" LED is flashing?	The spin speed selector has been set to "Rinse hold".	Select a spin speed setting.
. . . The "Final spin" LED is flashing?	The final spin has not taken place. The machine detected an imbalance.	<ul style="list-style-type: none"> - Loosen the laundry load. - The spin speed appropriate for the programme should be selected. - Turn the programme selector to "Spin".
. . . The "ON" LED is flashing?	Programme locking is activated. The programme selected has been changed.	Go back to the programme originally selected.
. . . The washing has not been spun satisfactorily?	The spin speed selected was too low.	Select a higher spin speed next time.
	The load was not distributed sufficiently evenly in the drum. Laundry was either only spun at a reduced speed to protect the machine	Mix large and small items in a load to avoid imbalance.
	The drain pump and fluff filter is clogged.	Clean the drain pump and fluff filter.
. . . The machine shakes during the spin cycle?	The four feet are not resting evenly on the floor.	Level the machine (see Installation Section).

What to do if	Cause . . .	Remedy . . .
. . . In spite of adequate water supply the water flows slowly into the machine?	The filter in the water inlet system is blocked.	– Clean the water inlet filter.
. . . Large residues of detergent remain in the dispenser drawer?	The water supply pressure is too low.	– Clean the filter in the water inlet system. – It may be useful to select "Water plus".
	Washing powder used with water softener tends to become sticky.	– Pour washing powder into the dispenser before adding any water softener.
. . Fabric conditioner is not completely dispensed or water remains in the  compartment?	The dispenser drawer was not pushed right in when the fabric conditioner was being flushed in.	
	The siphon tube is either incorrectly positioned or clogged.	– Clean the siphon tube.
. . . Excessive build-up of foam?	Use only a suitable low-lather detergent at the appropriate temperature.	– Follow recommendations on the packet. – Take the water hardness level into account. – Use less detergent for lightly soiled or small loads.
. . . Lime deposits appear on the drum surface?	Not enough detergent has been used.	– Use a descaling agent which must be stated by the manufacturer to be suitable for use in washing machines. – Use the correct amount of detergent to cope with the water hardness.

What to do if, . . .	Cause . . .	Remedy . . .
<p>. . . Grey greasy particles clinging to washed laundry?</p>	<p>Insufficient amounts of detergent were used to break down the particles of grease in heavily soiled laundry.</p>	<ul style="list-style-type: none"> – Either add more detergent, or use liquid detergent. – Before washing the next load run a COTTONS 60°C programme with liquid detergent but without a load to clean the machine.
<p>. . . Liquid detergent does not give the required result?</p>	<p>Liquid detergents do not contain bleaching agents. They do not remove stains eg fruit coffee and tea stains.</p>	<ul style="list-style-type: none"> – Use a general purpose washing machine powder containing a bleaching agent.. – Pour stain remover (salts) into the dispenser drawer compartment III – Never put stain salts and liquid detergent together in the dispenser drawer.
<p>. . . After washing knobbles (pilling) appear on the fabric?</p>	<p>This is normal from everyday wear with some fabrics.</p>	<p>These textiles must be handled with extreme care. Wash them in the DELICATES programme and/or select "Gentle action" in the future.</p>

Opening the drum door in the event of a power failure

- Switch off the washing machine.
- Open the drain pump/fluff filter panel and drain off any water as described in the Section on Cleaning and care.

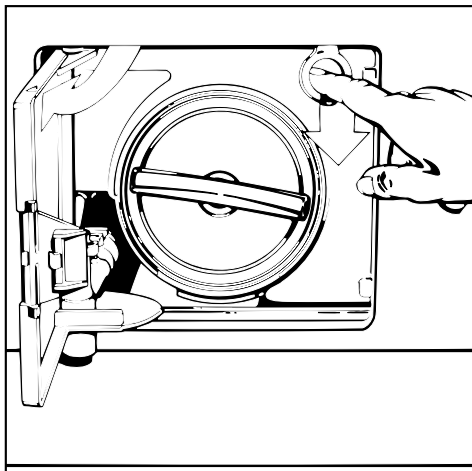

- Pull the ring of the door mechanism downwards, the door will open.

Always make sure that the drum is stationary before reaching in to remove washing. Reaching into a moving drum is extremely dangerous.

To check water pressure

- Place a bucket under the stopcock.
- Turn on the stopcock.

If 5 litres of water flow into the bucket in 15 seconds the water pressure correct.

Electric socket

- If there is any doubt about the electricity supply socket, consult a qualified electrician.

After sales service

In the event of any faults which cannot be remedied, or if the appliance is under guarantee, please contact:

- Your Miele Dealer or
- Your nearest Miele Service department.

(see back cover for the address).

When contacting the Service Department, please quote the Model and Serial nos. of your appliance, both of which are shown on the data plate visible when the door is opened above the porthole glass.

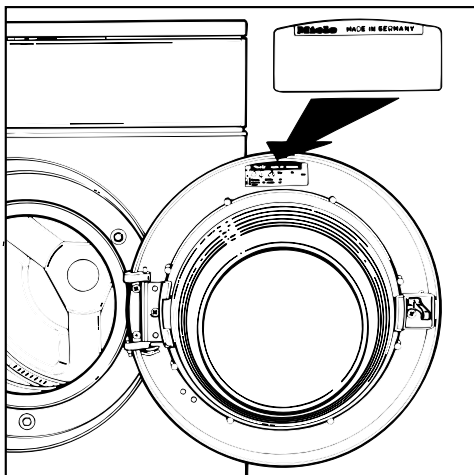

Example:



PC

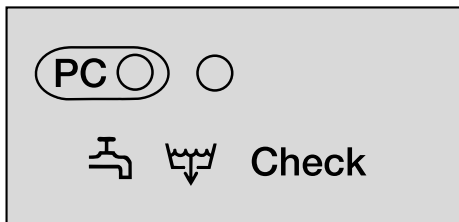

Where any LED indicator light is also marked PC, the PC function is reserved for the service engineer.

Installation surface

Experience has shown that a concrete floor is the most suitable installation surface for a washing machine. Concrete floors are far less prone to vibration during the spin cycle than wooden floorboards or a surface with "soft" properties.

Please note the following points:

- The machine must be level and securely positioned.
- To avoid vibrations during spinning, the machine should not be installed on soft floor coverings.
- If installation must be on a wooden joist floor, we recommend the use of a plywood base at least 30 mm thick and 59 x 52 cm wide. Ideally, the base should be large enough to span several joists and should be bolted to the joists and not only to the floorboards. Check for the presence of pipes and cables first.

The most stable part of a floor is usually in the corner.

If the machine is installed on a raised plinth, it **must** be secured against slippage during spin using retaining clips (available from the Miele Spare Parts Dept).

Installation

Lift the machine from its packaging base and move it to its site. Please note:

- Do not lift the machine by the drum door.

- Ensure that the machine feet and the floor are dry to prevent the machine from slipping during the spin cycle.

Removing the transit fitting

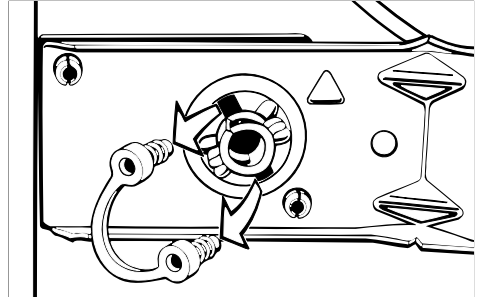

- Using combination pliers, pull out the retaining clips on the right and left of the support plate.

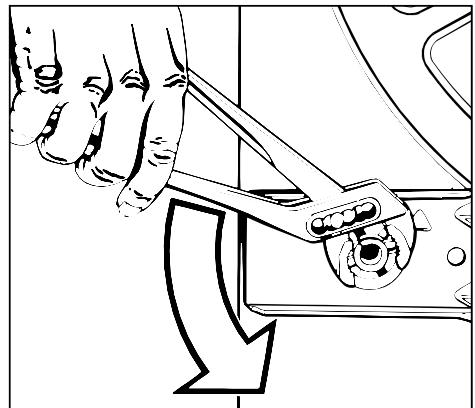

- Using a pipe wrench turn the left-hand transit bar 90° clockwise.

Installation

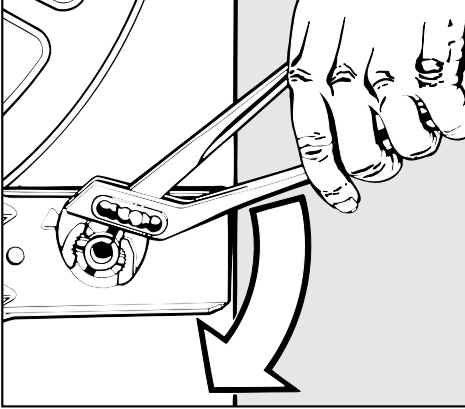

- Turn the right-hand transit bar 90° clockwise.

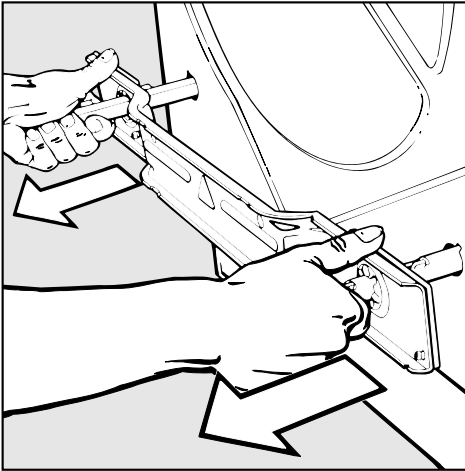

- Withdraw the two bars together with the support plate.

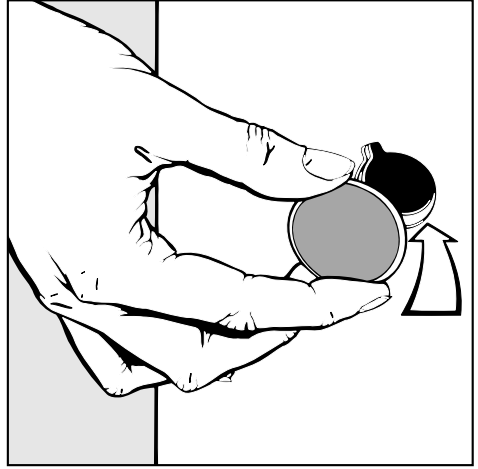

- Plug the two holes with the plastic caps supplied.

The machine should not be moved without the transit fitting in place.

The transit fitting should be stored in a safe place for future use. It must be re-fitted if the machine is to be moved again. Re-fitting is carried out by reversing the procedure.

Levelling the machine

The machine must be perfectly level to ensure safe and proper operation.

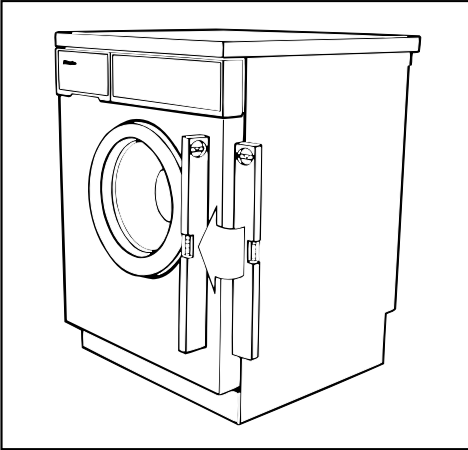

Incorrect installation may increase water and electricity consumption.

The rear machine feet are self-levelling. If necessary adjust the leg levellers on the front feet as follows:

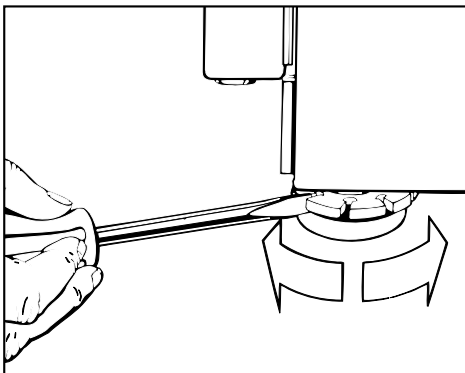

- Unscrew the foot or feet until the machine stands level.
- Hold the foot tight using a pipe wrench.

- Tighten the counternut using a screwdriver as indicated.

Building under

To install this appliance under a continuous worktop:

- A special conversion kit* is required.
- The machine lid must be replaced by a cover plate.
To ensure electrical safety the cover plate must be fitted by a suitably competent person exactly according to the fitting instructions included with the kit.
- For installation under a work surface 900/910 mm from the floor, a raising kit* is required.
- Connections for electricity, water and drainage should be installed in such a way that they remain accessible when the machine is in place.

Washer-Dryer stack

A Miele tumble dryer can be stacked with this washing machine. A stacking kit* is necessary.

All parts marked * are available from the Miele Spare parts or Sales Department, and from some Miele Dealers.

Installation

Flush out any residual test water still in the machine as follows:

- Do not load the machine.
- Add a little detergent to compartment **III**.
- Switch on the machine.
- Select the “COTTONS 60°C” programme.
- Press the “Short wash” selector.
- This operation will flush out any residues.

Water hardness reminder

The amount of detergent will depend on various factors including the water hardness level in your area. Set the water hardness dial located in the detergent dispenser box as a reminder.

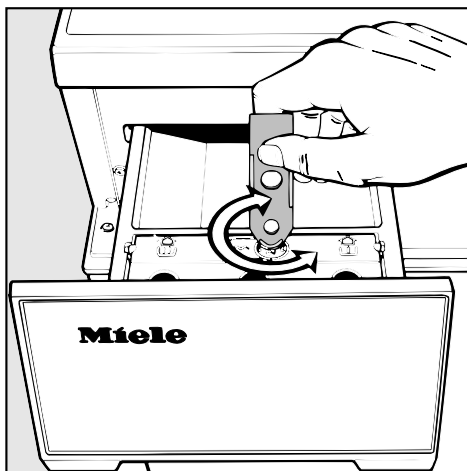

- Turn the dial to the relevant setting using.

(1 = soft, 4 = very hard).

Use the spatula supplied with the machine. It is located at the rear of the dispenser drawer.

If you do not know how hard the water is in your catchment area, please contact your local water authority.

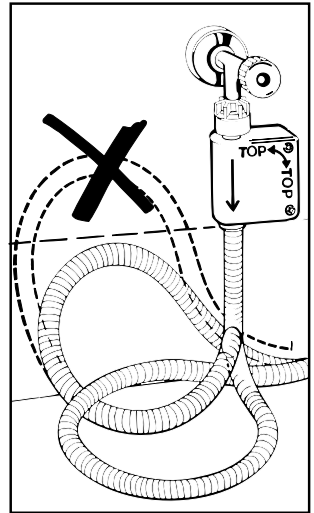
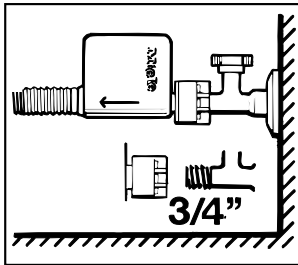
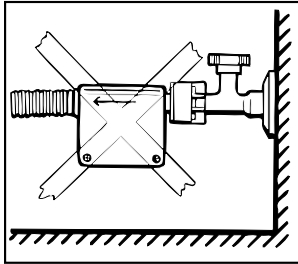
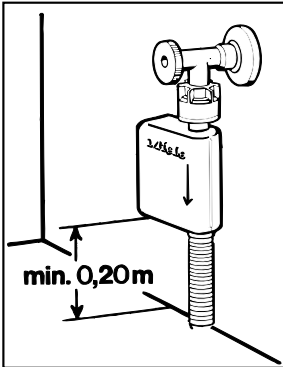

Connection to water supply

Fitting

The machine should be connected to a mains water supply in accordance with standard regulations. The German authorities do not require it to have a non-return valve as the washing machine has been designed to comply with DVGW regulations (German Association of Gas and Water Engineers, see data plate).

The machine is designed to operate with a minimum water pressure of 1 bar. There is a minimum flow pressure of 1 bar pressure if 5 litres of water flow into a suitable container in 15 seconds.

The water pressure must not exceed 10 bar.

If the water pressure is higher than 10 bar it is essential to fit a reducer valve.

The **Miele "Waterproof system"** connected between the stopcock and the machine offers the safest protection against water leaks.

For the "Waterproof system" to function correctly, it may only be fitted in the positions shown (see illustrations above).

Connection to the mains water supply should incorporate a mains stopcock with 3/4" thread. The stopcock should be fitted by a qualified plumber.

Plumbing

The connection point is subject to mains water pressure. Turn on the stopcock slowly and check for leaks. Correct the position of the washer and union if appropriate.

The "Waterproof system" is **NOT** suitable for connection to a hot water supply.

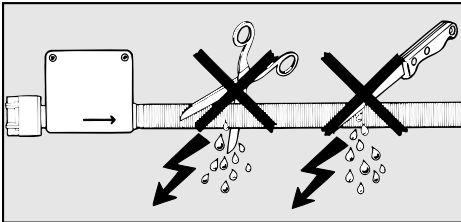

The protective sleeve of the hose **must not be damaged** (see illustration).

The "Waterproof system" with a hose length of approx. 4.5 metres is available as an optional extra.

Function

At the heart of this leak protection system there is an **electric safety valve**, which works like an automatic stopcock. The Miele "Waterproof system" protects from water damage in the following cases:

Protection in the event of a leaking machine

Any leaking water is collected in a sump in the base of the appliance. A float switch switches the safety valve off electrically, no more water will flow in.

Protection in the event of a leaking water inlet hose

Leaking water is fed into the sump through the protective covering which surrounds the inlet hose as a "second skin". The float switch switches off the water supply.

Maintenance

NB. If you intend to unscrew the "Waterproof system" unit from the mains water supply it is essential that the machine is first disconnected from the electricity supply.

Only use a genuine Miele "Waterproof system" able to withstand pressure of up to 70 bar, should you ever need a replacement.

In order to protect the water inlet valves the dirt filter in the solenoid safety valve connection must not be removed.

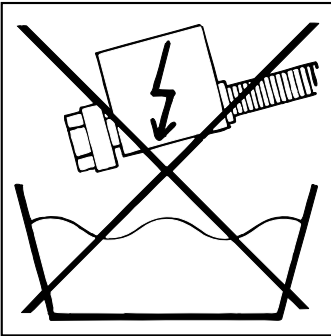
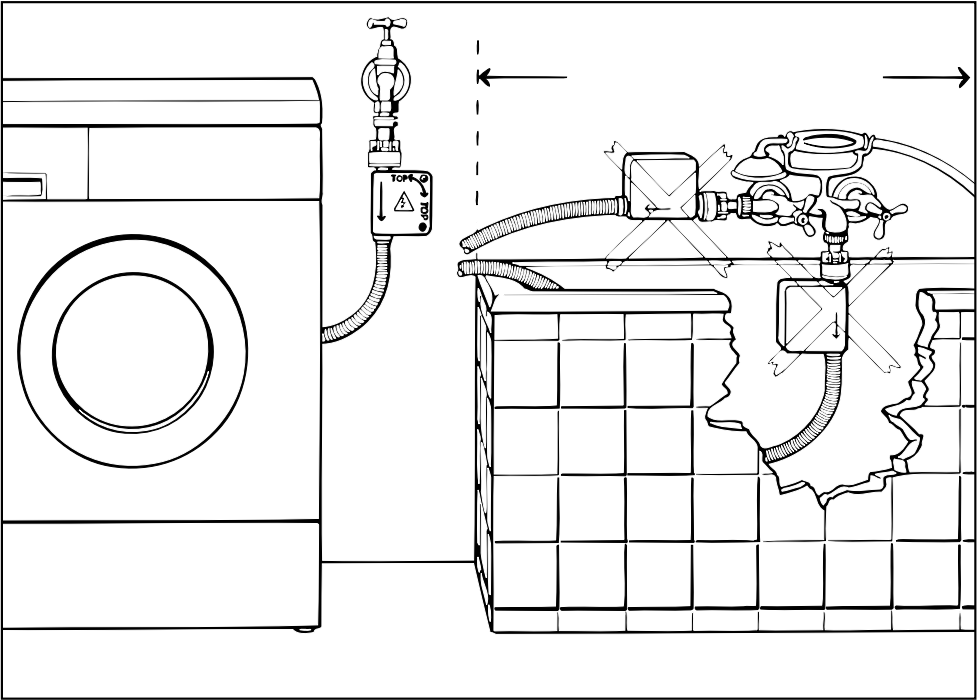

Important!

The plastic casing of the water connection contains an electric component.

Do not dip into liquids!

Plumbing

Connection to the drainage system

The machine drains via a drain pump with a delivery head of 1 metre.

The hose must not be kinked as this restricts drainage. The swivel elbow at the end of the hose can be turned in either direction, or can be detached if required with a sharp twist and pull.

Drain hose dimensions:

Length	1.5 m
Interior diameter	22 mm
Exterior diameter	30 mm
Exterior diameter of the hooked section	32 mm

Drain hose connection:

- Direct into a sink: Hook the hose over the edge and secure. Make sure that the water can flow freely to avoid flooding and to prevent water from being sucked back into the machine.
- Connected to a standpipe.
- Connected to a plastic drain pipe with a rubber nipple. There is no need to use a non-return valve.
- Allow the water to drain off into a floor drain.

If required, the hose can be extended to a length of 5 m.

For a delivery head of more than 1 m (up to a maximum of 1.8 m) a second Duo drain pump is available with the corresponding conversion kit from the Miele Spare Parts Department.

This machine is supplied ready for connection to an a.c. single phase 230 - 240 V, 50 Hz supply. The machine is supplied with a 2 m long mains cable with moulded plug. The voltage, rated load and fuse rating are given on the data plate. Please ensure that these match the household mains supply.

All electrical work should only be carried out by a suitably competent person, in accordance with national and local safety regulations.

Connection should be made via a fused plug and a suitable switched socket which is easily accessible. For extra safety it is advisable to install a residual current device (RCD) with a trip current of 30 mA.

Important

The wires in the mains lead are coloured in accordance with the following code:

Green/yellow = earth
Blue = neutral
Brown = live

As the colours of the wires in the mains lead of this appliance may not correspond with the coloured markings identifying the terminals in your plug, proceed as follows:

The wire which is coloured green and yellow must be connected to the terminal in the plug which is marked with the letter E or by the earth symbol  or coloured green or green and yellow.

The wire which is coloured blue must be connected to the terminal which is

marked with the letter N or coloured black.

The wire which is coloured brown must be connected to the terminal which is marked with the letter L or coloured red.

WARNING

THIS APPLIANCE MUST BE EARTHED

Non-rewireable plugs BS 1363

If this machine or appliance is fitted with a non-rewireable plug, the following information applies:

If the socket outlets are not suitable for the plug supplied with this product, it must be cut off and an appropriate plug fitted.

The plug cut from the flexible cord should be disposed of and on no account be inserted into any socket elsewhere in the house (electric shock hazard).

The fuse cover must be refitted when changing the fuse, and if the fuse cover is lost, the plug must not be used until a suitable replacement is obtained. The colour of the correct replacement is that of the coloured insert in the base of the plug, or the colour that is embossed in words in the base of the plug (as applicable to the design of plug fitted). The correct fuse rating of the replacement fuses that are ASTA approved to BS 1362 should be fitted. Replacement fuse covers may be purchased from your local electrical suppliers, or Miele Service Agent.

Programmable functions

The following programmable functions can be activated by the user.

A function stays programmed in memory until it is cancelled.

A High water level

Where rinse results are particularly important.

Effective for the rinses in programmes:

- COTTONS
- MINIMUM IRON
- QUICK WASH 40°C

B Extra rinse for Cottons programmes

For soft water areas (water hardness range 1).

Where rinse results are particularly important in soft water areas an extra rinse can be selected as well as high water level.

C Gentle action

For gentle washing of slightly soiled items. Drum movement is reduced.

The “Gentle action” function is available for COTTONS, MINIMUM IRON and QUICK WASH 40°C.

D Programme Lock (Child safety feature)

Programme lock prevents a wash programme being changed from another, e.g. by children playing.

This also applies to the additional option selections, and prevents unplanned opening of the door.

The washing machine ignores any changes after the first three minutes of starting the programme, i.e. if the programme selector switch is set to a different setting or an additional programme is selected.

- The “On” light starts flashing

Once the programme selector switch is turned back to its original position the “On” light stops flashing.

To change a programme:

- Turn the programme selector switch to “Finish/Start”.

The programme sequence indicator lamps start flashing in succession after approx. 30 seconds.

You can select a different programme as soon as only the “On” light lights up.

Programmable functions

To switch on the programmable functions:

N.B.:

First switch off the machine, close the door, release all pushbutton switches and set the programme selector switch to "Finish/Start".

Steps 2 to 4 must be carried out within **25 Seconds**:

Step 1:

- Press in the "Soak" and "Short wash" buttons.

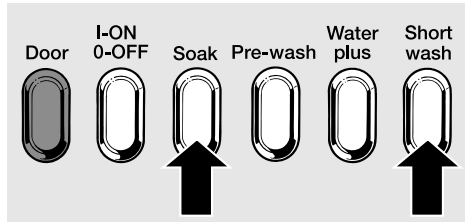

Step 2:

- Press in the "I-ON/0-Off" button.

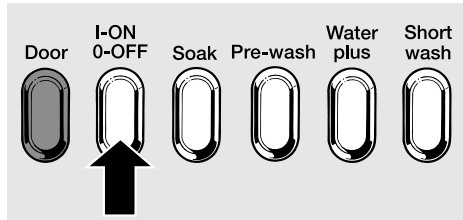

Step 3:

- Release the "Soak" button.

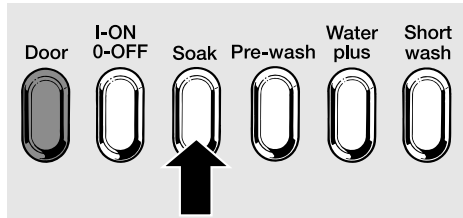

Programmable functions

Step 4:

- Release the “Short wash” button.

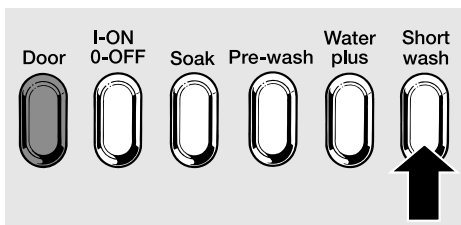

The “ON” LED will now light up and the “Main wash” light flashes.

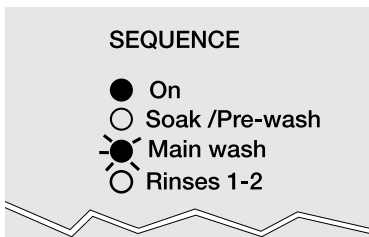

Step 5: Select the programmable function required.

Programmable function:

Ⓐ High water level

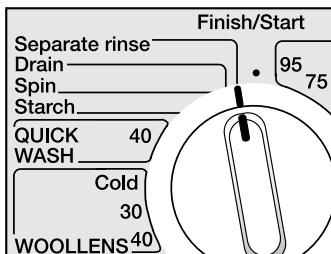

turn programme selector to:
SEPARATE RINSE

Continue with **Step 6** to activate

Programmable functions

Programmable function:

B Extra Rinse

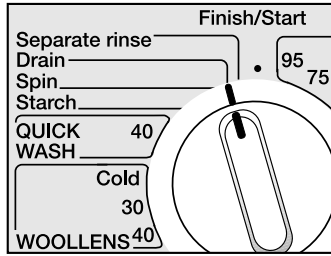

turn programme selector to :
Drain

Continue with **Step 6** to activate

Programmable function:

C Programme locking

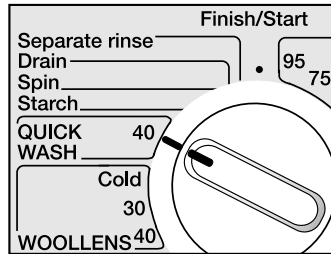

turn programme selector to:
QUICK WASH 40°C

■ Continue with **Step 6** to activate

Programmable function:

D Gentle action

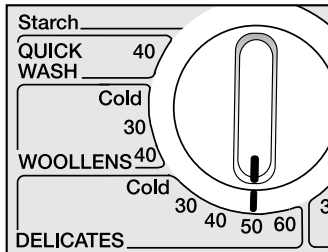

turn the programme selector to:
DELICATES 50°C

Continue with **Step 6** to activate

Step 6: activate

- Press and release the “Short wash” button 4 times (i.e. twice in and twice out)

Then:

- if activated: LED “Rinses 1-2” lights up
- if cancelled: LED “Rinses 1-2” goes out

Step 7:

- to store in memory: press in the “I-ON/O-OFF” button.

Programmable functions

To check the programmable function

- Carry out **Steps 1 to 5**.

If the LED light “Rinses 1-2” lights up, the relevant programmable function is activated.

- Press the “I-ON/O-OFF” button. This finishes the check of the programmable function.

To cancel the programmable function:

Proceed as for “Switching on a programmable function”.

- **Step 1 to Step 6** inclusive.

With step 6 the programmable function can be cancelled.

The indicator light “Rinse 1-2” goes out again.

- Press the “I-ON/O-OFF” button.

The programmable function is cancelled from memory.

Consumption data

Normal Programmes (without any additional options or programmable functions)	Load	Consumption data
COTTONS 95°C	5 kg	Electricity: 1.75 KWh Water: 61 l Time: 1 h 52 mins
COTTONS 60°C *	5 kg	Electricity: 1.00 KWh Water: 58 l Time: 1 h 46 mins
COTTONS 40°C	5 kg	Electricity: 0.50 KWh Water: 58 l Time: 1 h 36 mins
MINIMUM IRON 40°C	2,5 kg	Electricity: 0.45 KWh Water: 65 l Time: 1 h 21 mins
DELICATES-SYNTHETICS 30°C	1 kg	Electricity: 0.40 KWh Water: 75 l Zeit: 58 min
WOOL 30°C	1 kg	Electricity: 0.2 KWh Water: 60 l Time: 46 mins

* Acc. to EN 60456

Consumption data can vary from the nominal values given as a result of water pressure, water hardness, water inlet temperature, room temperature, type of load, volume, fluctuations in the electricity supply and any additional functions selected.

Technical data

Height	85 cm
Width	59.5 cm
Depth	60 cm
Depth with door open	97 cm
Weight	103 kg
Max. floor load	1600 Newton (approx. 160 kg)
Capacity	5 kg dry laundry
Connected load	} s. Data plate
Rated load	
Fuse rating	
Water flow pressure min.	1 bar
Static water pressure max.	10 bar
Drain pump head max.	1 m
Drain pump length max.	5 m
Test certificates awarded	Radio/tv suppression, VDE
Electrically suppressed according to	DIN EN 60555/VDE 0838

Miele

United Kingdom

Miele Co. Ltd.

Fairacres, Marcham Road, Abingdon, Oxon, OX14 1TW

tel. Abingdon (01235) 554455 - fax (01235) 554477

Service Office, tel. Abingdon (01235) 554466

Ireland:

Miele Ireland Ltd.

Wilton House, Naas Road, Dublin 22

Tel. (01) 4504024, Fax (01) 4504037

Free Manuals Download Website

<http://myh66.com>

<http://usermanuals.us>

<http://www.somanuals.com>

<http://www.4manuals.cc>

<http://www.manual-lib.com>

<http://www.404manual.com>

<http://www.luxmanual.com>

<http://aubethermostatmanual.com>

Golf course search by state

<http://golfingnear.com>

Email search by domain

<http://emailbydomain.com>

Auto manuals search

<http://auto.somanuals.com>

TV manuals search

<http://tv.somanuals.com>