

# Miele

## NOVOTRONIC SUPER



## Operating instructions for Washing machine W 939 WPS

To avoid the risk of accidents or damage to the appliance it is **essential** to read these operating instructions before it is installed or used for the first time.



M.-Nr. 04 973 340

# Caring for our environment

---

## **Disposal of the packing material**

The transport and protective packing has been selected from materials which are environmentally friendly for disposal and can normally be recycled.

Ensure that any plastic wrappings, bags etc. are disposed safely and kept out of the reach of babies and young children. Danger suffocation!

Rather than just throwing these materials away, please ensure they are offered for recycling.

## **Disposal of your old appliance**

Old appliances contain materials which can be recycled. Please contact your dealer, your local waste collection centre or scrap merchant about potential recycling schemes.

Ensure that the appliance presents no danger to children while being stored for disposal. See the appropriate advice in the "Warning and safety instructions".

<b>Caring for our environment</b> . . . . .	2
Disposal of the packing material . . . . .	2
Disposal of your old appliance . . . . .	2
<b>Guide to the machine</b> . . . . .	6
General view . . . . .	6
Control panel . . . . .	7
<b>Warning and safety instructions</b> . . . . .	8
<b>Washing environmentally and economically</b> . . . . .	11
<b>Before using for the first time</b> . . . . .	12
Proceed as follows: . . . . .	12
Water hardness reminder. . . . .	12
<b>How to wash correctly</b> . . . . .	13
Brief guide . . . . .	13
Before washing . . . . .	13
To start a programme . . . . .	14
Delay start. . . . .	16
After washing . . . . .	16
Load indicator lights . . . . .	17
Adding or removing laundry after a programme has started . . . . .	17
Programmes . . . . .	18
. . . cancelling a programme and selecting a different one . . . . .	18
. . . altering a programme . . . . .	18
. . . repeating a section (e.g. rinse). . . . .	18
. . . skipping a programme stage . . . . .	18
<b>Adding detergent</b> . . . . .	19
It is important to dispense the correct amount, because . . . . .	19
Adding detergent. . . . .	20
Water softeners . . . . .	20
Fabric conditioners, texturisers, liquid starch . . . . .	20
Automatic fabric conditioners, texturisers, or liquid starch . . . . .	21
Separate fabric conditioner or texturiser . . . . .	21
Starching separately. . . . .	21

# Contents

---

<b>Programmes</b> . . . . .	22
Programme selection . . . . .	22
Programme sequence . . . . .	24
Care symbols - washing . . . . .	26
<b>Additional options</b> . . . . .	28
Soak . . . . .	28
Pre-wash . . . . .	28
Short . . . . .	28
Water plus . . . . .	29
Buzzer . . . . .	29
Spin and Drain . . . . .	29
<i>Without final spin.</i> . . . . .	29
<i>Rinse hold.</i> . . . . .	29
Electronic programme locking . . . . .	30
Electronic Locking . . . . .	31
<b>Display</b> . . . . .	32
Delay start . . . . .	32
Time left display . . . . .	32
Soak . . . . .	32
<b>Programmable functions</b> . . . . .	33
<i>P1</i> = Maximum water level . . . . .	33
<i>P2</i> = Water plus system . . . . .	33
<i>P4</i> = Activating the  compartment . . . . .	33
<i>P9</i> = Gentle action . . . . .	34
<i>P10</i> = Top-up rinse for <i>Cottons</i> . . . . .	34
<i>P11</i> = Memory function . . . . .	34
Programming and storing in memory . . . . .	35
1. Selecting programming mode . . . . .	35
2. Selecting a programmable function . . . . .	35
3. To activate or deactivate a programmable function . . . . .	36
4. Saving the programmable function in memory . . . . .	36

<b>Cleaning and care</b> . . . . .	37
Cleaning the washing machine . . . . .	37
Extra cleaning . . . . .	37
Cleaning the detergent dispenser drawer . . . . .	38
Cleaning the fluff (drain) filter and pump . . . . .	39
Cleaning the filter in the water inlet . . . . .	41
<b>Problem solving guide</b> . . . . .	42
The programme does not start . . . . .	42
The wash programme stops and a fault indicator light comes on . . . . .	43
A fault indicator light comes on but the wash programme continues as normal . . . . .	44
General problems or an unsatisfactory wash result . . . . .	45
Opening the drum door in the event of a power failure . . . . .	48
<b>After sales service</b> . . . . .	50
Customer contact . . . . .	50
Future updates (PC) . . . . .	50
<b>Installation</b> . . . . .	51
Installation surface . . . . .	51
Installation . . . . .	51
Removing the transit fitting . . . . .	51
Re-fitting the transit bars . . . . .	52
Levelling the machine . . . . .	53
Unscrewing and adjusting the feet . . . . .	53
Building under: . . . . .	54
Washer - dryer stack . . . . .	54
Fitting or changing the decor panel . . . . .	55
Decor panel dimensions . . . . .	55
Fitting a plinth facing . . . . .	56
Fitting the plinth facing: . . . . .	56
Connection to water supply . . . . .	57
Connection to the drainage system . . . . .	60
Electrical connection U.K. . . . .	61
<b>Consumption data</b> . . . . .	63
<b>Technical Data</b> . . . . .	64

# Guide to the machine

## General view

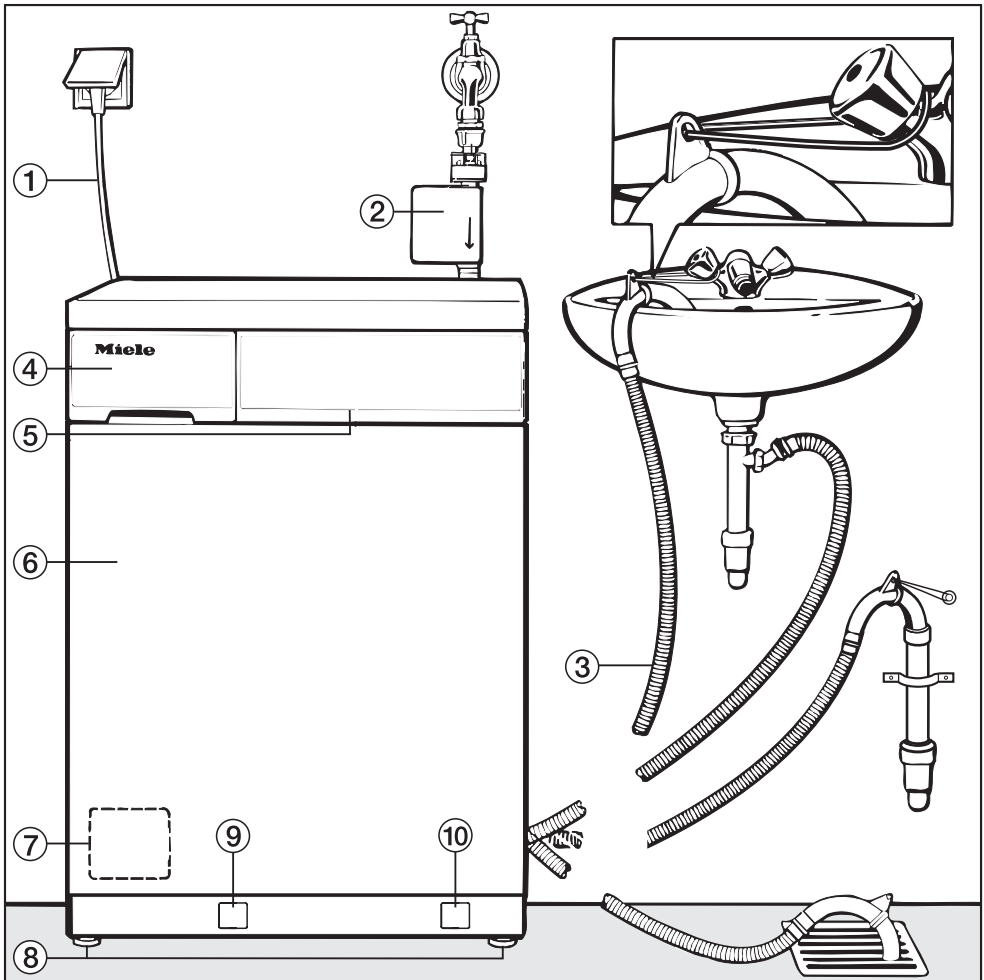

- ① Electric supply cable
- ② Inlet hose with "Waterproof" system
- ③ Flexible drain hose (with detachable swivel elbow)
- ④ Detergent dispenser drawer
- ⑤ Facia panel with controls
- ⑥ Drum door
- ⑦ Access panel for drain pump and filter
- ⑧ Four height adjustable feet
- ⑨ Panel for emergency door release (door hinged right) and for drainage (door hinged left or right)
- ⑩ Panel for emergency door release (door hinged left)

## Control panel

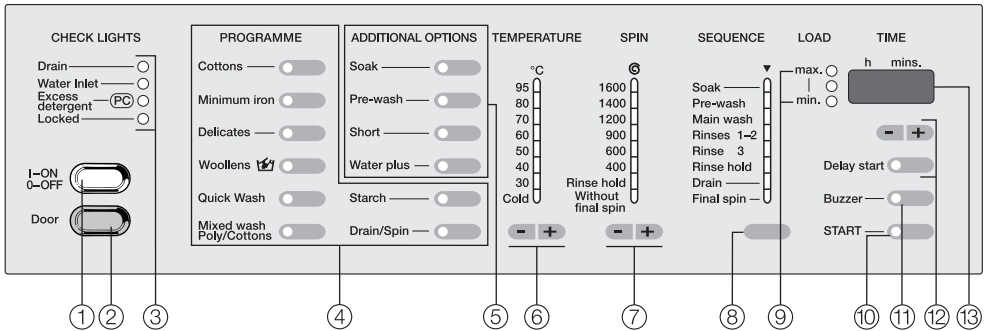

### ① I-On/0-Off button

for switching the machine on or off or interrupting a programme

### ② Door button

opens the machine door

### ③ CHECK LIGHTS

### ④ PROGRAMME touch pads

### ⑤ ADDITIONAL OPTION touch pads

Indicator light on = option selected  
Indicator light off = option not selected

### ⑥ TEMPERATURE display

with **-** **+** touch pads for setting the wash temperature

### ⑦ SPIN SPEED display

with **-** **+** touch pads for setting the final spin speed

### ⑧ SEQUENCE display

with touch pad for changing the programme sequence

### ⑨ Indicator lights for LOAD display

### ⑩ START touch pad

starts the wash programme

### ⑪ Buzzer touch pad

### ⑫ Delay start touch pad

with **-** **+** touch pads for setting the time

### ⑬ Display

The display has several functions:

- it displays the programme duration
- it displays the “Delay start” time remaining until a programme starts
- it displays programming functions when they are called up

# Warning and safety instructions

---

Read the operating instructions before using this machine for the first time. They contain important information about the safety, use and maintenance of the machine. This way you will avoid the risk of accidents and damage to the machine. Keep these operating instructions in a safe place and ensure that new users are familiar with the content. Pass them on to any future owner of the machine.

## Correct usage

Only use the washing machine to wash items which are specified by the manufacturer to be machine-washable on the wash-care label, and textiles composed of hand-washable wool or wool blend fabrics as well as satin, lace, silk and other hand-washable garments.

Any other applications may be dangerous. The manufacturer is not liable for damage resulting from improper use or operation.

This appliance should not be operated by children. Supervise its use by the elderly or infirm.

## Technical safety

Before setting up the machine, check it for any externally visible damage. Do not install and use a damaged machine.

Before connecting the machine, ensure that the connection data on the data plate (fusing, voltage and frequency) match the mains electricity

supply. If in any doubt, consult a qualified electrician.

The electrical safety of this appliance can only be guaranteed when continuity is complete between the machine and an effective earthing system which complies with local and national regulations. It is most important that this basic safety requirement is regularly tested by a qualified electrician. The manufacturer cannot be held liable for the consequences of an inadequate earthing system (e.g. electric shock).

Do not connect the appliance to the mains electricity supply by an extension lead. Extension leads do not guarantee the required safety of the appliance (e.g. danger of overheating).

The machine is built in accordance with current safety requirements. Unauthorised repairs could result in unforeseen dangers for the user, for which the manufacturer cannot accept liability. Repairs should only be undertaken by a Miele approved engineer. Ensure current is not supplied to the appliance while maintenance or repair work is being carried out.

The machine is only completely isolated from the electricity supply when:

- it is switched off at the wall socket and the plug is withdrawn, or
- it is switched off at the mains, or
- the mains fuse is withdrawn.



# Warning and safety instructions

---

■ The Miele "Waterproof system" protects from water damage provided the following conditions have been met:

- the machine is correctly plumbed in and connected to the electricity supply.
- if a fault has been identified, the machine must be examined by a competent person before further use, and repaired if necessary.

■ Faulty components must only be replaced by genuine Miele original spare parts. Only when these parts are fitted can the safety standards of the machine be guaranteed.

■ If the connection cable is damaged it must be replaced by a special Miele cable.

■ In countries where there are areas which may be subject to infestation by cockroaches or other vermin, pay particular attention to keeping the appliance and its surroundings in a clean condition at all times. Any damage which may be caused by cockroaches or other vermin will not be covered by the appliance guarantee.

## Use

■ This equipment is not designed for maritime use, or for use in mobile installations such as caravans, aircraft etc. However, it may be suitable for such usage subject to a risk assessment of the installation being carried out by a suitably qualified engineer.

■ Do not install your washing machine in rooms where temperatures below freezing may occur. Frozen hoses may burst under pressure. The reliability of the electronic control system may be impaired at temperatures below freezing point.

■ Before using the machine for the first time, check that the transit fitting at the rear of the machine has been removed (see section on "Installation"). During spinning, a transit fitting which is still in place may result in damage to both the machine and adjacent furniture or appliances.

■ Turn off the stopcock if the machine is to be left for any length of time (e.g. holiday), especially if there is no floor drain (gully) in the immediate vicinity.

■ Flooding danger.

■ If hooking the drain hose into a wash basin, check that the water can drain off quickly enough to prevent the sink from overflowing. Make sure the drain hose is secure, so that the force of the water flowing out of the hose does not dislodge it. Otherwise this will result in flooding.

■ Take care to ensure that foreign objects (e.g. nails, needles, coins, paper clips, etc.) do not find their way into the machine with the washing (e.g. in pockets). These may damage components of the machine (e.g. suds container, drum), which in turn can result in damage to the washing.

# Warning and safety instructions

---

■ If the correct amount of detergent is dispensed, the machine should not need to be descaled. If, however, you do wish to descale the machine only use proprietary non-corrosive descaling agents and strictly observe the manufacturer's instructions given on the packaging. If in doubt, contact the Miele Customer Service Dept. or your Miele Dealer.

■ Textiles which have been pre-treated in solvent-based cleaning agents must be thoroughly rinsed in clean water before being washed in the machine.

■ Never use solvent-based cleaning agents in this machine, as this may result in damage to component parts and create toxic fumes. Such detergents also pose a fire and explosion hazard.

■ Only use dyes specified by the manufacturer as being suitable for use in a domestic washing machine. Always observe the manufacturer's instructions carefully.

■ Colour run and dye removers contain sulphur compounds which can cause damage such as corrosion. Do not use these products in this machine.

■ Always make sure the drum is stationary before reaching in to remove laundry. Reaching into a moving drum is extremely dangerous.

## Accessories

■ Accessory parts may only be fitted when expressly approved by Miele. If other parts are used, guarantee, performance and product liability claims may be invalidated.

## Disposal of your old machine

■ Before discarding an old machine unplug it. Render the plug useless. Cut off the cable directly behind the appliance to prevent misuse. This should be done by a competent person.

## Washing environmentally and economically

---

- Water consumption and energy usage are determined by the size of the load. Load to the maximum recommended for the programme selected.
- Programme durations can vary considerably due to the automatic load adjustment feature. Depending on the amount of laundry, the main wash may be shortened and one rinse omitted.
- Use the *Mixed Wash* programme or the *Quick Wash* programme for smaller amounts of laundry.
- To save energy wash normally and lightly soiled laundry at lower temperatures. The 95°C Cottons programme is probably only needed in exceptional circumstances, e.g. for oil based stains or where a very hot wash is required.
- A main wash (programme without pre-wash) is sufficient to clean normally soiled laundry.
- By using the additional option *Soak* for heavily soiled laundry you can select a lower temperature in the main wash.
- Use the additional option *Soak* instead of *Pre-wash* with heavily soiled laundry.  
If *Soak* is followed immediately by a main wash the same suds are used.
- Use the *Short* wash option for normally or very lightly soiled laundry.
- Do not exceed the amounts of detergent which may be recommended by the manufacturer on the packaging.
- Reduce the amounts of detergent with smaller loads, (e.g. with a half load, approx. one third less detergent).
- Select the highest suitable spin speed in the wash programme when tumble drying afterwards.

## Before using for the first time

Before using the machine for the first time ensure that it is correctly installed and connected. See the relevant section under "Installation". Also check that the fluff filter is securely tightened to prevent the risk of water leaks during use.

For safety reasons spinning is not possible until the machine has been prepared for using for the first time. To activate the spinning function you must run a wash programme without laundry. This also activates the ball valve. The ball valve prevents detergent escaping from the suds container into the sump during a programme, thus making maximum use of the detergent.

### Proceed as follows:

- Open the stopcock
- Do not load any laundry
- Add max.  $\frac{1}{4}$  of the amount of detergent you would use for a full load to compartment **III**
- Press the I-ON/O-OFF button in
- Press the *Cottons* programme touch pad
- Use the **[-] [+]** touch pads to select a temperature of 60°C

### Important

This temperature is required to prepare the machine for operation.

- Press the *Water plus* touch pad  
The indicator light will come on
- Use the **[-] [+]** touch pads to set the spin speed selector to *Without final spin*.
- Press the START touch pad
- Any residues in the machine will be flushed out by the end of the programme and your machine is now ready for use.

## Water hardness reminder

The amount of detergent required will depend on various factors including water hardness. The dial in the detergent dispenser can be set as a water hardness reminder.

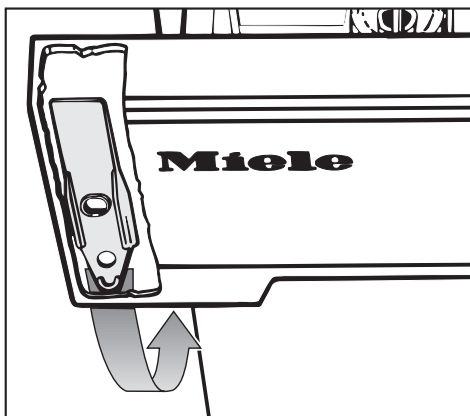

- Remove the yellow lever from behind the detergent drawer facia panel.

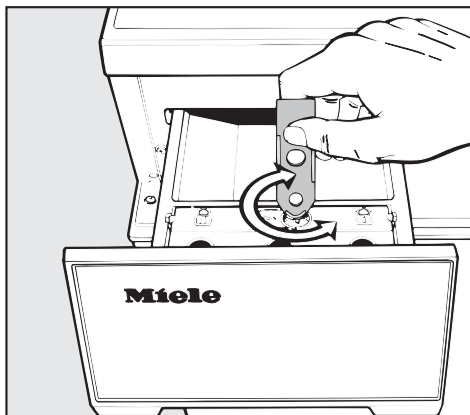

- Use it to turn the dial to the position which represents your water hardness level.

Your local water authority can advise on water hardness in your area.

## Brief guide

The headings numbered (1, 2, 3,...) show the operating sequence and can be used as a brief guide.

### Before washing

#### 1 Sort the laundry.

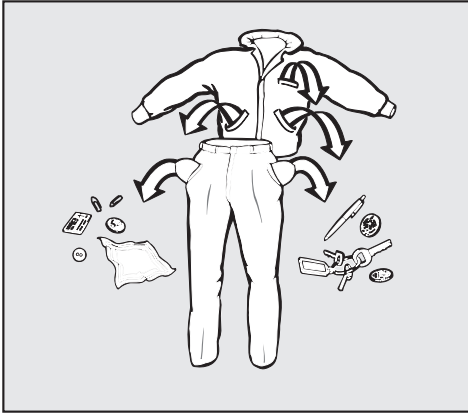

#### ■ Empty all pockets.

Foreign objects (e.g. nails, coins, paper clips, etc.) can cause damage to textiles and components in the machine.

#### ■ Badly soiled areas, e.g. collars and cuffs, and water soluble stains can be pre-treated with bar soap, liquid detergent or detergent mixed into a solution or paste.

With particularly stubborn stains ask your dry cleaner for advice.

Do not use solvent-based cleaning agents in this machine.

#### ■ Sort the washing by colour and by care label symbols. Most garments have a textile care label in the collar or side seam.

Dark textiles often contain excess dye and should be washed separately several times before being included in a mixed load. Always wash whites and coloureds separately.

Delicate textiles should be washed separately in a delicates programme (use a washing bag where appropriate).

- Curtains:  
Remove lead weights and strips or place in a laundry bag.
- Underwiring and collar stiffeners:  
Any loose wiring in bras, shirt collar stiffeners, etc. should be removed or sewn in.
- Knitted garments, trousers and jeans, T-shirts and sweat shirts:  
Turn inside out, if recommended by the manufacturer.
- Close any zips, fasten hooks and eyes etc. before washing.
- Fasten duvet covers to prevent smaller items rolling up inside them.

Do not wash any items in this machine which are specified by the manufacturer as **non-machine washable** on the care label. (☒ symbol)

# How to wash correctly

## 2 Press in the I-ON/0-OFF button.

The machine is switched on.

## 3 Press the *Door* button.

## 4 Load the drum.

Unfold laundry and load loosely in the drum. To achieve best results it is advisable to make up mixed loads consisting of both large and small items. This improves the washing effect and helps distribute the load evenly to keep the machine stable and reduce the noise level during spinning.

Overloading reduces the wash result and causes more creasing.

### Maximum load weights are noted below:

Cottons . . . . .	5.0 kg
Minimum iron . . . . .	2.5 kg
Delicates/Synthetics . . . . .	1.0 kg
Woollens  . . . . .	1.0 kg
Quick Wash . . . . .	2.5 kg
Mixed Wash/Poly Cottons . . . . .	3.0 kg

## 5 Close the drum door.

Make sure that there is no obstruction between the drum door and seal.

## 6 Open the stopcock.

## 7 Add detergent.

See section on "detergent" for details.

## To start a programme

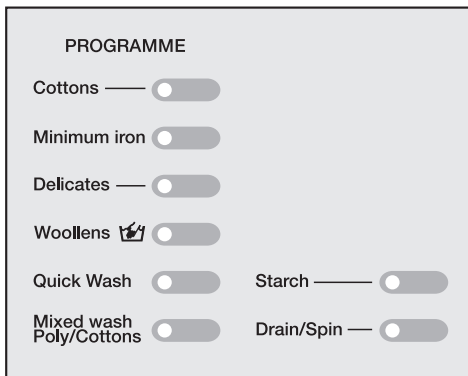

### 8 Select the basic programme

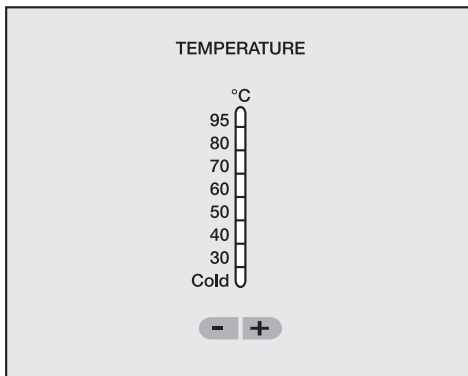

■ Press the required basic programme touch pad (see the programme chart).

### 9 Set the required temperature



■ Use the   touch pads until the indicator light for the required temperature lights up.

The maximum temperature is limited in some programmes (see the programme chart).

# How to wash correctly

## ⑩ Select any additional option required.

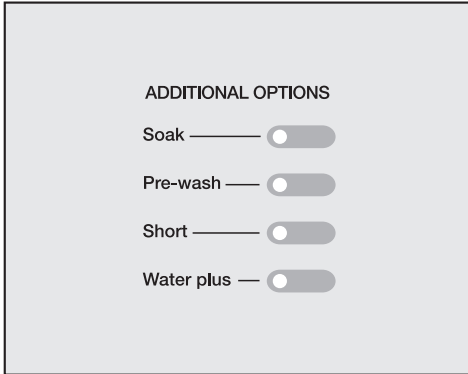

- Press the relevant touch pad.

Indicator light **on** = selected

Indicator light **off** = not selected

An additional option that has been selected can be de-selected by pressing the touch pad again.

## ⑪ Select a spin speed.

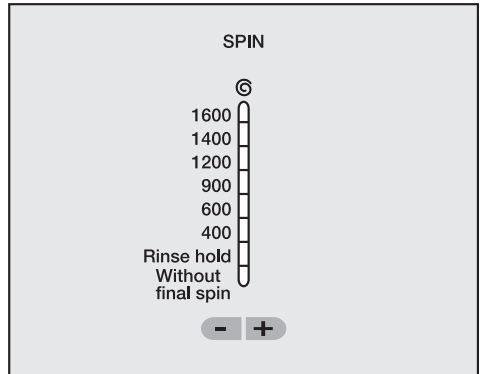

- Use the   touch pads until the indicator light for the required final spin speed lights up.

In some programmes the maximum spin speed is limited. The machine will not allow a higher spin speed to be selected (see section "programme survey").

## Memory function

If the last time a programme was run an additional option or different spin speed was selected, the machine will have stored this information in its memory.

The next time that programme is selected the machine displays the additional option, temperature and spin already stored in memory.

Exception:

Soak and Delay start.

# How to wash correctly

## Delay start

### 12 Select delay start if required.

The start of a programme can be delayed from 30 minutes up to a maximum of 24h hours.

- Press the *delay start* touch pad.



- Use the **-** **+** touch pads to set the length of delayed time.

Each press on the **+** touch pad increases the delayed time or on the **-** touch pad shortens it:

- by 30 minutes up to 10 hours.
- by one hour from 10 hours upwards.

### To delete delay start:

Press the delay start touch pad.

### 13 Press the START touch pad.

This starts the programme.

## After washing

### 14 Press the *Door* button.

### 15 Remove the laundry.

Only remove laundry from the machine once the drum has stopped turning, otherwise you may seriously injure yourself. Make sure the drum is empty. Items left behind could colour run, shrink, or be damaged in the next programme.

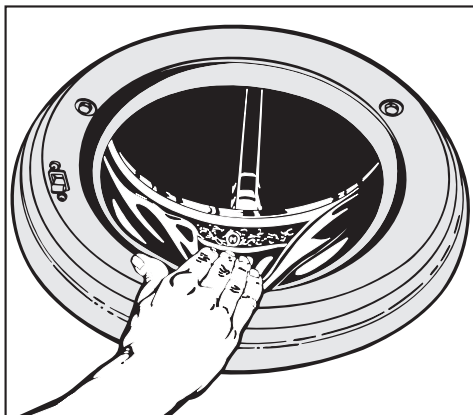

### 16 Check the folds in the door seal for any small articles e.g. buttons which might be lodged there.

### 17 Press and release the I-ON/O-OFF button.

### 18 Close the drum door.

Otherwise there is a danger of objects being placed inadvertently in the drum. If these remained unnoticed and were washed in the next load, they could damage the laundry.



## Load indicator lights

The machine can identify the size of the load or its composition from the absorbency of a wash load.

This recognition takes place within the first 10 minutes of the programme.

The indicator lights show how the load has been identified in the *Cottons* and *Minimum iron* programmes.

**1 indicator light on** = Minimum load

**2 indicator lights on** = Medium load

**3 indicator lights on** = Full load

## Adding or removing laundry after a programme has started

Laundry can be added or removed after the start of one of the following programmes:

- Cottons
- Minimum iron
- Woollens
- Quick wash
- Mixed wash
- Starch

- Press the *Door* button in and hold it until the door springs open.
- Add or remove items.
- Close the door.

The door can be opened during all stages, except the spin, of the *Cottons*, *Woollens*, *Quick wash*, *Mixed wash* (high percentage of cotton) and *Starch* programmes.

The door can be opened during the main wash of the *Minimum iron* and *Mixed wash* (high percentage of polyester) programmes.

### Exceptions:

The door **cannot be opened**, if:

- the suds temperature is above **55°C**
- the additional option *Water plus* has been selected
- programme locking is switched on.

Load recognition is switched off if extra laundry is added or taken out of the drum. The machine will wash as for a full load and the maximum load indicator will light up.

# How to wash correctly

## Programmes . .

### . . . cancelling a programme and selecting a different one

- Switch the machine off and on again.
- Start the new programme as described in "Programme start".

Load recognition is switched off if a programme is re-started. The machine will wash as for a full load and the maximum load indicator will light up.

### . . . altering a programme

The machine will accept the following changes after a programme has started:

- up to 6 minutes after the start, the *Water plus* and *Short* additional options can be selected or de-selected and a different temperature can be selected for the programme in use.
- the final spin speed can be changed within the limits for the programme.

Additional functions cannot be changed if the door has been opened.

In order to select another programme the old programme must be cancelled before the new one can be started.

### . . . repeating a section (e.g. rinse)

A programme section can be repeated or a particular section be selected on its own.

- Switch the machine on

- Select the programme
- Press the START touch pad
- Press the programme sequence touch pad repeatedly until the required position is reached.

For rinsing laundry we recommend using the *Delicates* programme.

### . . . skipping a programme stage

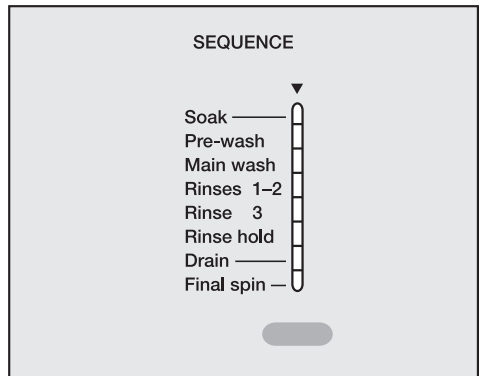

- Press the programme sequence touch pad when the light comes on next to the section you want to skip.

The programme will then continue with the next programme stage. The relevant programme sequence indicator will light up.

If programme locking has been activated the programme cannot be changed nor can a programme section be repeated or skipped.

All modern detergents produced for automatic washing machines are suitable, including liquid, compact (concentrated), tablets, liquid tablets and special application detergents. Use dispensing aids, e.g. balls, if these are supplied with the detergent. Tablets are suitable for full loads, but note that it may be impractical to reduce tablets by proportion to suit smaller loads.

Woollens and knitwear containing wool mixtures and hand-washable garments should be washed using a detergent specifically designed for washing woollens.

Silk should be washed using a liquid detergent specifically designed for washing woollens. Do not use biological detergents on silk as the enzymes may damage the silk!

Add detergent according to the amount recommended on the packaging. The right amount to dispense will depend on the following:

- The quantity of laundry.
- The soiling level of the laundry.

#### Lightly soiled

No visible dirt or stains. Possibly slight body odour.

#### Normally soiled

Visibly dirty and/or just a few slight stains.

#### Heavily soiled

Stains and soiling clearly visible.

- The water hardness level  
Check with your local water supplier if you do not know the water hardness level in your area.

## Water Hardness

Hardness range	Type of water (hardness)	Hardness level in mmol / l	°dH German
I	soft	0 - 1.3	0 - 7
II	medium	1.3 - 2.5	7 - 14
III	hard	2.5 - 3.8	14 - 21
IV	very hard	over 3.8	over 21

## It is important to dispense the correct amount, because . . .

### . . . too little has the following results:

- Laundry will not be properly clean and will in time become grey and hard to the touch.
- Greasy particles cling to the laundry.
- Limescale deposits on the heater elements.

### . . . too much results in the following:

- Excessive foam.
- Low level of agitation.
- Poor washing, rinsing and spinning results.
- High water consumption (an additional rinse cycle will automatically switch in).
- Burdening the environment.

# Adding detergent

## Adding detergent

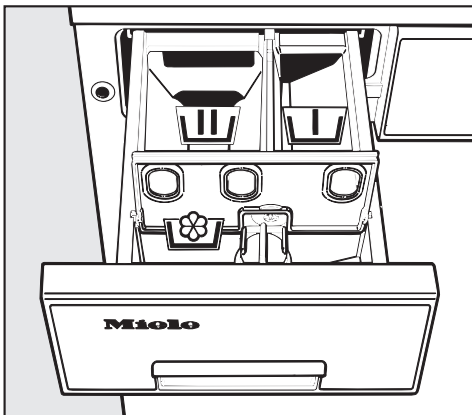





 = Compartment for pre-wash.  
This compartment is also used for starch formulations when starching separately.

 = Compartment main wash

 = Compartment fabric conditioner

Water is taken in through compartment  in the pre-wash.

Water is taken in through compartment  in the main wash. If the capacity of compartment  is insufficient for the amount of detergent needed for a COTTONS programme (e.g. in very hard water areas), the machine can be programmed so that water and detergent can also be taken into the main wash through compartment , see "Programmable functions", "Activating compartment ".

## Water softeners

A water softener can be used to cut down on the use of detergents in extremely hard water areas. Dispense according to the amount specified on the packaging. First add detergent and then the water softener.

Dispense detergent as specified for soft water areas.

Miele do not recommend connecting the machine to a household water softener.

If you wash using several components (e.g. special application detergents), we recommend always dispensing the agents into compartment  in the following order:

1. Detergent
2. Water softener
3. Stain remover

This way the agents are distributed more efficiently.

## Fabric conditioners, texturisers, liquid starch

Fabric conditioners make garments soft and fluffy to handle and help prevent static cling when tumble drying.

Texturisers are synthetic starch formulations and give body to items e.g. shirts, tablecloths and bed linen.

Starch gives body to items of washing.

- Dispense according to the amount specified on the packaging.

## Automatic fabric conditioners, texturisers, or liquid starch

- Open the lid of compartment .

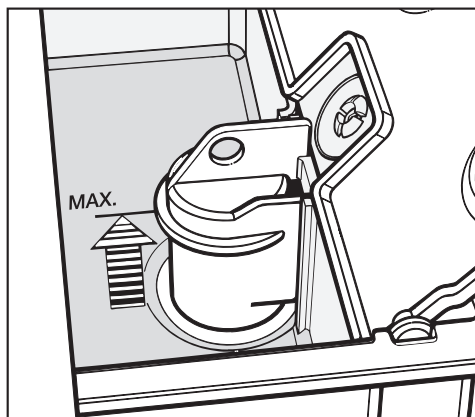

- Add the fabric conditioner, texturiser or liquid starch. **Do not exceed the maximum level mark.**
- Close the compartment lid.
- Push the drawer back in.

The conditioner, texturiser or liquid starch is automatically dispensed in the last rinse. At the end of the programme there will be a small amount of water left in the fabric conditioner compartment .

If starching frequently, clean the dispenser compartment and especially the siphon tube and conditioner channel regularly. (See section on the detergent dispenser drawer in "Cleaning and Care").

## Separate fabric conditioner or texturiser

- Add fabric conditioner or texturiser to the compartment .
- Press the *Starch* touch pad
- Select a spin speed.
- Press the START touch pad.

## Starching separately

- Measure and prepare starch in accordance with the manufacturer's instructions.
- Add the starch to compartment .
- Press the *Starch* touch pad.
- Select a spin speed.
- Press the START touch pad.

# Programmes

## Programme selection

Programme	Fabric	Temperature	max. spin speed
<b>Cottons</b> 	Cottons and linen fabrics, eg bed linen, table linen, towelling, jeans, underwear, T-shirts, nappies.	95°C to cold	1600
<b>Cottons 60°C</b>	Wash load for standard tests	60°C	1600
<b>Minimum iron</b>  	(60°C) white nylon, white polyester fabrics (50°C), coloured nylon, polyester, cotton and viscose fabrics with special finishes, acrylic, cotton fabrics, coloured polyester / cotton fabrics, (40°/30°C) minimum iron fabrics not washable at higher temperatures	60°C to cold	900
<b>Delicates</b> 	Acrylics, acetate and triacetate, socks and stockings in man-made fibres, (not wool or wool blends)	40°C to cold	600
	Curtains, specified machine-washable by the manufacturer (pre-wash probably advisable).	30°C to cold	600
<b>Woolens</b> 	Programme for machine-washable or hand-washable wool or wool blend fabrics	40°C to cold	1200
	Also suitable for satin, lace, silk and other hand washable garments.*		*
<b>Quick Wash</b>	For very lightly soiled fabrics, which can be washed in the Cottons programme.	40°C to cold	1600
<b>Mixed wash</b> 	Suitable for small loads of garments made from man-made fibres and cotton garments which can be washed together. Sort according to colour.	60°C to cold	900
<b>Starch</b>	Table cloths, napkins, overalls, uniforms.	cold	1600
<b>Spin</b>	Articles which can be spun, eg handwashed items, max weight according to fabric. N.B. do not use for woolens.		1600
<b>Drain</b>			

**Cold:** If *Cold* is selected for the temperature, the water is warmed to 24°C. This uniform temperature helps the effect of the detergent.

max. load	Additional options	Notes
5 kg	<ul style="list-style-type: none"> <li>– Soak</li> <li>– Pre-wash</li> <li>– Short</li> <li>– Water plus (Option 1,2,3,4)</li> </ul>	<p>With heavily soiled items select <i>Soak</i> or <i>Pre-wash</i>. Wash dark colours in liquid detergent.</p> <p>For normally soiled items select <i>Short</i>.</p>
5 kg		For test institutes: Programme setting for tests according to EN 60456 Standard Programme
2.5 kg	<ul style="list-style-type: none"> <li>– Soak</li> <li>– Pre-wash</li> <li>– Short</li> <li>– Water plus (Option 1,2)</li> </ul>	<p>With heavily soiled items select <i>Soak</i> or <i>Pre-wash</i></p> <p>For normally soiled items select <i>Short</i></p> <p> If fabrics have a high proportion of man-made fibres it is advisable to programme the machine for "Gentle Action". See "Programmable functions".</p>
1 kg	<ul style="list-style-type: none"> <li>– Soak</li> <li>– Pre-wash</li> <li>– Short</li> </ul>	Use the Wool programme for textiles with wool content
Fill the drum loosely $\frac{1}{2}$ to $\frac{3}{4}$ full	<ul style="list-style-type: none"> <li>– Soak</li> <li>– Pre-wash</li> <li>– Short</li> </ul>	Dust in curtains usually makes pre-wash advisable.
1 kg		Use liquid wool detergent.
Do not overload		<p>Hand washable garments will not shrink, stretch, matt or felt beyond the accepted tolerance.</p> <p>*For satin, lace silk and other hand washable garments manually reduce the spin speed or select without final spin.</p>
2.5 kg	<ul style="list-style-type: none"> <li>– Water plus (Option 1,2)</li> </ul>	Add less detergent (half load)
3.0 kg	<ul style="list-style-type: none"> <li>– Soak</li> <li>– Pre-wash</li> <li>– Short</li> <li>– Water plus (Option 1,2,3*,4*)</li> </ul>	<p>The water level, number of rinses and programme time are set automatically in relation to composition of the washing.</p> <p>*Option is only carried out with a high proportion of cotton.</p>
5.0 kg		The washing should be washed, but not treated with fabric conditioner.
5.0 kg		

See Section on Additional options for more details.

# Programmes

## Programme sequence

	Cottons <sup>1)</sup>	Minimum iron <sup>1)</sup>	Delicates
Soak	optional	optional	optional
Pre-wash	optional	optional	optional
Main wash	●	●	●
Top up rinse from 70°C	programmable	-	-
Graduated rinsing	-	from 40°C	from 50°C
No. of rinses			
– minimum load	2	-	-
– medium load	2	3	-
– full load	3 or 4 <sup>2)</sup>	3	3
– with Short touch pad	2	2	3
Rinse and interim spin (rpm)	max. 1000	max. 500	-
Final spin (rpm)	max. 1600	max. 900	max. 600
Anti-crease, loosen	max. 30 min	max. 30 min	max. 30 min
Rinse hold	optional	optional	optional
Without final spin	optional	optional	optional
Wash rhythm	normal	normal	gentle action
Water level - Wash	low <sup>3)</sup>	low <sup>3)</sup>	high
- Rinse	low <sup>3)</sup>	medium <sup>3)</sup>	high

### Explanations:

- Programme section included
- Programme section not included

### 1) Load recognition:

The programme sequence is modified in these programmes according to the absorbancy of the load. The indicator lights under *Load* on the control panel show the load identified by the machine.

2) **A 4th rinse** automatically switches in if there is too much foam in the drum, or if a spin speed lower than 700 rpm has been selected.

### 3) Increasing the water level:

The water level can be increased from a low level to a higher level by pressing the *Water plus* touch pad.

### Woollens:

Wool is susceptible to damage from movement when it is wet. The wash action during the course of the programme is low.



Woollens 	Quick wash	Mixed Wash		Starch
		high cotton content	high polyester content	
-	-	optional	optional	-
-	-	optional	optional	●
●	●	●	●	-
-	-	-	-	-
-	-	-	from 40°C	-
-	2	2	2	-
-	2	2	3	-
2	2	3 or 4 <sup>2)</sup>	3	-
-	-	2	2	-
max. 600	max. 500	max. 900	max. 500	-
max. 1200	max. 1600	max. 900	max. 900	max. 1600
-	max. 30 min	max. 30 min	max. 30 min	max. 30 min
optional	optional	optional	optional	optional
optional	optional	optional	optional	optional
Wool	normal	normal	normal	normal
medium	low <sup>3)</sup>	low <sup>3)</sup>	low <sup>3)</sup>	low
medium	medium <sup>3)</sup>	low <sup>3)</sup>	medium <sup>3)</sup>	-

### Top-up rinse (programmable):

At the end of the main wash additional water flows into the drum, and the suds are cooled slightly. Hot water might damage plastic drain pipes.

### Graduated rinsing:

The suds are cooled at the end of the wash cycle by water flowing in and being pumped away at intervals thereby minimising creasing.

### Rinse and interim spin:

There is a spin between the rinses.

### Final spin:





The maximum spin speed according to the programme can be selected with the Spin touch pad. In the programmes *Minimum Iron*, *Delicates*, *Woollens* and *Mixed Wash* the spin speed is automatically limited to the above stated maximum spin speed.

### Anti-crease, and loosen:







The anti-crease action guards against the tendency for creases to set in if laundry is not removed from the drum as soon as a programme has finished. There is drum movement twice a minute. The door can be opened and laundry removed at any time during the anti-crease phase.

# Programmes



## Care symbols - washing

<b>Care symbols</b>	<b>Fabric types</b>	<b>Description of process</b>	<b>Programme:</b> (select the appropriate temperature according to the temperature on the care label symbol)
 no bar	Cottons	Normal (maximum) machine action and normal spinning	Cottons, Minimum iron, Quick wash
 single bar	Synthetics	Reduced (medium) machine action and reduced spinning	Delicates  *If the gentle action option has been programmed into your machine via the programmable functions, garments with a single bar under the care label  can also be processed using a Cottons, Minimum Iron, Quick wash, Mixed Wash or Starch programme.
 broken bar	Woollens	Much reduced (minimum) machine action but with normal spinning	Hand Wash Woollens programmes.





## Important - other care symbols

	Hand wash (if a temperature is not specified, use the lowest temperature or cold)
	Do not wash
	Dry clean
	Do not dry clean
	Suitable for chlorine bleaching
	Do not use chlorine bleach





## Tumble dry

	At normal temperature
	At low temperature
	Do not tumble dry

## Ironing

	Hot iron
	Medium hot iron
	Cool iron
	Do not iron

N.B. If you have any textiles with the older wash care labels, select a programme according to the label below:

	Cottons
	Minimum iron
	Delicates
	Woolens

## Additional options

---

To select an additional option to the basic programme press the touch pad for that option. The indicator light for the option touch pad comes on.

If an additional option is chosen which is unsuitable for the basic programme, (see the Programme Survey):

- the indicator light goes out when the touch pad is released.

If a spin speed is chosen which is unsuitable for the programme (see the Programme survey):



- pressing the touch pad has no effect.

### Soak

For heavily soiled and stained items with protein stains (e.g. blood, fats and oils, cocoa).

A length of time of between 30 minutes and 6 hours can be chosen, in 30 minute periods, for the *Soak* process.

### Setting soak time

- 1 Select a programme.
  - 2 Press the *Soak* touch pad, the indicator light flashes and the first 30 minutes of the soak time are switched on.
  - 3 The  touch pad underneath the "time" display can be used to lengthen the soak time, and the  touch pad to shorten it.
- Important  
The soak time chosen will be added to the original programme duration in the "time" display.

- 4 Press the START touch pad, unless *Delay start* is to be selected.

### Deleting soak time



Press the *Soak* touch pad, the indicator light goes out.

### Adding detergent for the Soak programme:

- Programmes without pre-wash:

Add the total amount into compartment  or directly on to the wash-in in the drum.

- Programmes with pre-wash:

$\frac{1}{4}$  of the detergent should be added to compartment  for *soak* and *pre-wash*,  $\frac{3}{4}$  of the detergent into compartment  for the main wash.

### Pre-wash

For heavily soiled and stained items

### Short

This shortens the programme running time. For lightly soiled items.

In the *Cottons*, *Minimum Iron* and *Mixed Wash - Poly/Cottons* programmes only two rinse cycles are carried out with a higher water level.

### Water plus

The water level increases in *soak*, *pre-wash*, *main wash* and/or *rinses*, and/or an extra rinse can be carried out.

You can choose between four options with the *Water plus* touch pad.

See "Water plus system" in the "Programmable functions" section.

### Buzzer

At the end of the programme or when Rinse hold is reached an audible tone sounds repeatedly.

The buzzer sounds for one hour maximum.

### Switching off the additional options

Press the touch pad for the relevant additional option, the indicator light goes out.

### Spin and Drain

For fabrics which can be spun after having been hand-washed.

#### **Without final spin**

Washing is not spun after the final rinse. After water has been drained the machine switches automatically to the anti-crease phase.

Interim rinse and spin is carried out in the relevant programme sections.

#### **Rinse hold**

The washing remains suspended in water after the final rinse.

This helps to reduce the possibility of creasing if the washing is left for some time before being taken out of the machine.

Interim rinse and spin is carried out in the relevant programme sections.

#### **To continue the programme**

##### **with final spin:**

Select the required spin speed with the  touch pad under the Spin selection display.

##### **without final spin:**

Press the  touch pad under the spin display once. The *without final spin* indicator light comes on and the machine pumps the water away.

# Additional options

---

## Electronic programme locking

Programme locking prevents the machine from being opened or the programme cancelled using a wash programme.

## Switching off programme locking

- Press the START touch pad until the *locked* check light goes out.

## Switching on programme locking

- Select a programme, (see Brief guide to washing correctly).
- Press the START touch pad for at least 4 seconds, until the *locked* check light comes on, (upper left on the control panel).

Programme locking is now activated.

The machine will now not accept any changes, and the wash programme proceeds through to the end.

At the end of the wash programme, and in "Rinse hold" the programme locking is deactivated, so that a new wash programme can be chosen.

### Electronic Locking

The locking function prevents your machine being used without your knowledge.

When the locking function is switched on:

- the machine cannot be opened,
- a programme cannot be selected,
- the machine cannot be started.

### Switching on the locking function

- ➊ Shut the drum door.
  - ➋ Switch on the machine.
  - ➌ Press the *Pre-wash* touch pad and hold pressed in while carrying out steps ➍ and ➎:
  - ➍ Press the *Mixed Wash* touch pad once.
  - ➎ Press the *Minimum iron* touch pad once.
- The *locked* check light flashes, (upper left on the control panel).
- ➏ Release the *Pre-wash* touch pad.
  - ➐ Switch off the machine.

### To switch off the locking function

Repeat steps ➊ to ➌. The check light *locked* goes out.

# Display

---

The time left shows in the display, or the time left plus soak time or the delay start period.

In addition it serves as a display for the programmable functions.

## Delay start

A period of delay shows in the display.

After the appliance has started the delay start time counts down.

If a delay start is higher than **10** hours it will count down hourly, from **9 h 59** it will count down in minutes.

Once the delay start period is completed the programme begins and the actual programme duration shows in the display.

See the section "How to wash correctly (Programme start)".

## Time left display

At the beginning of a programme, the maximum duration of a programme is shown in hours and minutes, where delay start has not been selected.

In the *Cottons*, *Minimum Iron* and *Mixed Wash* programmes the type and volume of the wash will be monitored during the first water inlet phase. With a part load the time could be reduced by up to 60 minutes.

## Soak

If a time is selected for soaking, this is added to the prescribed running time for the programme and the total shown in the display.

Example:

The *Cottons* 60°C programme is selected:

- The display shows a programme running time of **1 h 58**.
- A soaking time of one hour is chosen.
- The display shows a total running time of **2 h 58**. For more detailed information on soaking see the section *Additional options Soak*.



The programmable functions enable the user to introduce further features as required. The programmable functions remain stored in memory until they are cancelled by the user.

### The following programmable functions can be selected:

#### **P1 = Maximum water level**

The water level for rinsing is automatically raised to the maximum level where rinse results are particularly important.

Effective for the rinses in programmes:

- Cottons
- Minimum iron
- Quick Wash
- Mixed wash

#### **P2 = Water plus system**

The *Water plus* touch pad offers four options for increasing the water level and/or bringing in an extra rinse cycle.

#### **Option 1**

Increases the rinse water level in the *Cottons*, *Minimum iron*, *Quick Wash* and *Mixed wash* programmes, where for example rinse results are particularly important.

#### **Option 2**

Increases the water level in soak, pre-wash, main wash and rinses in the *Cottons*, *Minimum iron*, *Quick wash*, and *Mixed wash* programmes and is particularly suitable for fabrics that need special care, or where extra attention must be taken in dissolving detergent. This option is already set when the machine is delivered from the factory.

#### **Option 3**

An extra rinse cycle is introduced to the *Cottons* programme, e.g. when rinse results are particularly important.

#### **Option 4**

Is Option 2 plus Option 3, where this quality of rinse is required.

#### **P4 = Activating the compartment**

For the first 10 seconds of the main wash cycle water flows in through compartment .

Compartment  may sometimes not be able to hold the total amount of detergent required:

- if the water is very hard (over 3.8 mmol/l, water hardness level IV)) and
- if laundry is heavily soiled.

Compartment  can be used to flush in the extra detergent for the main wash.

# Programmable functions

---

## **P9 = Gentle action**

For gentle washing of slightly soiled items. Drum action is reduced.

Gentle action can be used with the *Cottons*, *Minimum iron*, *Quick Wash*, *Mixed wash* and *Starch* programmes.

If "Gentle action" has been programmed, every wash cycle in these programmes is carried out with gentle action rhythm.

## **P10 = Top-up rinse for Cottons**

At the end of the main wash additional water flows into the drum to cool the suds down.  
Hot suds can damage plastic drainage pipes.

Top-up rinse takes place when temperatures of 95°C, 80°C and 70°C are selected.

Top-up rinse should be activated:

- to prevent the danger of scalding if the drain hose is hooked over the edge of a sink or basin.
- where the drainage pipes do not comply with DIN 1986."

## **P11 = Memory function**

If an additional function is selected for a programme, and/or the spin speed is altered, the machine stores these changes in memory at the start of a programme.

The memory function is active when the machine is first delivered, but can be programmed to be switched off.

**See the following pages for how to programme the programmable functions.**

## Programming and storing in memory

The programmable functions are activated to call up further features not shown on the control panel by using the additional option touch pads in combination with the programme touch pads.

Programming is carried out in four steps:

1. Select programming mode
2. Select programmable function
3. Activate or deactivate the programmable function
4. Save the programmable function in memory

### 1. Selecting programming mode

- 1 The machine must be switched off and the drum door closed.
- 2 Press the *Cottons* and the *Soak* touch pads at the same time, hold pressed in and
- 3 . . . switch the machine on with the I-ON/O-OFF button.
- 4 Let go of all these touch pads/buttons.

*P 0* will appear in the display.

### 2. Selecting a programmable function

- 5 Press the  $\oplus$  touch pad under the display. The *P* will now flash in the display alternating with the number of the programmable function e.g. *P...1...P...1*
- 6 Press the  $\ominus\oplus$  touch pads repeatedly until the the display shows the number of the programmable function required, alternating with the *P*.

*P1* = High water level

*P2* = Water plus system

*P4* = Activate compartment 

*P9* = Gentle action

*P10* = Activate top-up rinse for *Cottons*

*P11* = Memory function

In addition, one of the following will appear on the right of the display:

*P 0* = Programmable function is de-activated

*P 1* = Programmable function is activated

with *P 2* a *2* will appear on the right to show that option 2 is active.

# Programmable functions

---

## 3. To activate or deactivate a programmable function

**For programmable functions P1, P4, P9, P10, P11**

- ⑦ Pressing the START touch pad once will toggle the display message from 0 to 1 (active) or from 1 to 0 (de-activated).

## For programmable function P2

- ⑦ By pressing the START touch pad you can select different options:

- 1 on the right = Option 1
- 2 on the right = Option 2
- 3 on the right = Option 3
- 4 on the right = Option 4

## 4. Saving the programmable function in memory

- ⑧ Switch the machine off with the I-ON/O-OFF button.

You can now start the programme you want.

The programmable function is now stored in memory and will remain so until you alter it.

## Cleaning the washing machine

- Clean the casing with a mild non-abrasive detergent or soap and water. Wipe dry with a soft cloth.
- Clean the fascia panel and lid with a damp cloth and dry with a soft cloth.
- The drum can be cleaned using a suitable proprietary stainless steel cleaner.

Do not use solvents, abrasive cleaners, glass cleaners or all-purpose cleaners. These might cause damage to the plastic surfaces because of the chemicals they contain. The washing machine must not be hosed down.

## E-cloth

A microfibre "E-Cloth" is available from the Miele UK Spare Parts Department, Part Number 98013530, which is suitable for cleaning surfaces such as stainless steel, glass, plastic and chrome without the use of chemicals.

## Extra cleaning

Carrying out a hot wash (70°C or above) with powder detergent approx. once every six weeks will help prevent deposits building up in the machine. These can occur when washing is mainly done at low temperatures, and lead to unpleasant smells. If you have no reason to wash laundry occasionally at this high temperature, then carry out a 95°C COTTONS programme as a cleaning cycle with powder detergent, but not laundry, at regular intervals.

## Cleaning and care

### Cleaning the detergent dispenser drawer

- Pull out the detergent dispenser drawer until a resistance is felt.

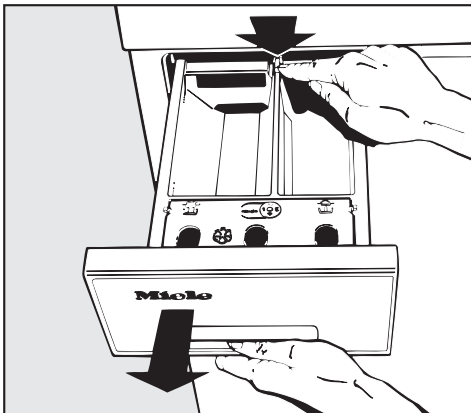

- Press down the red release catch and at the same time pull the drawer right out of the machine.

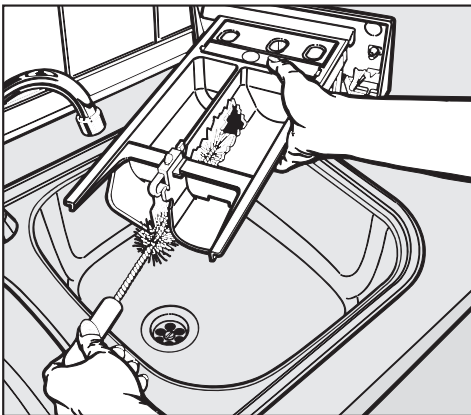

- Clean the dispenser compartments and conditioner channel. Regularly remove any detergent residues.

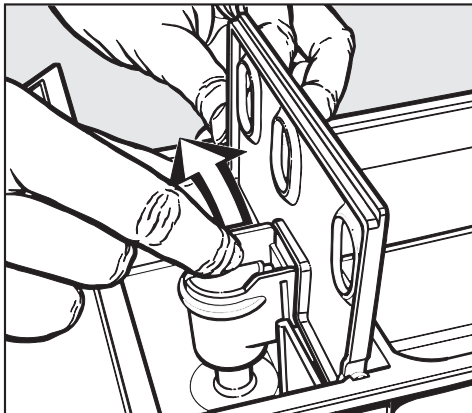

- Remove the siphon from compartment . Wash under running warm water and replace.

Over time, detergent residue can build up in the water jets in the top of the detergent drawer housing.

- Before replacing the detergent drawer, use a bottle brush or similar to clean them out.

## Cleaning the fluff (drain) filter and pump

Check the fluff (drain) filter initially after 3-4 washes to ascertain how often it is likely to require cleaning.

With normal cleaning approx. 2 litres of water run out.

If the drain outlet is clogged, more water will be retained in the machine (**up to 25 litres**).

Caution: If laundry has been washed at a high temperature, water draining out of the machine will still be hot.

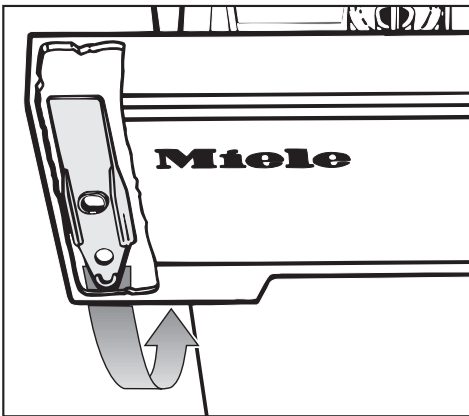

Take the (yellow) filter flap opener from behind the detergent drawer facia panel, (see illustration above).

- Open the door.

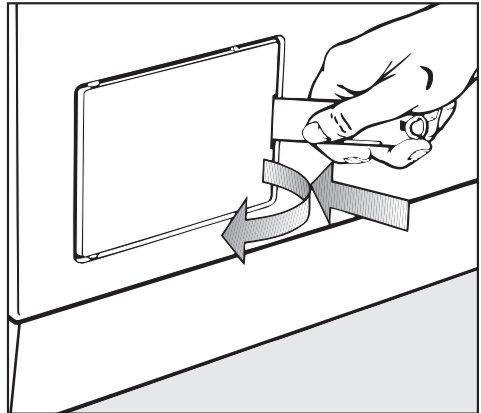

- Open the flap.
- Place a suitable container under the drain fixture.

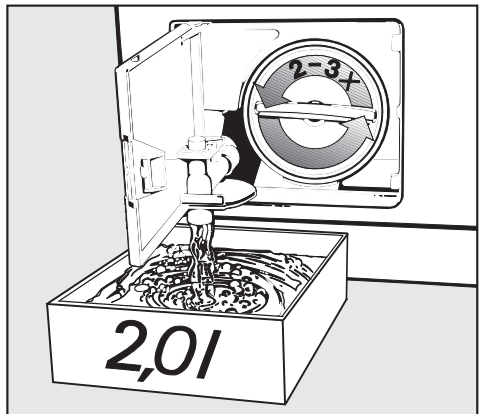

- Turn the fluff filter lid round 2-3 times. Do not take it right out.

With large volumes of water, when the container is full, screw the fluff filter back into position, and empty the dish before repeating the procedure.

## Cleaning and care

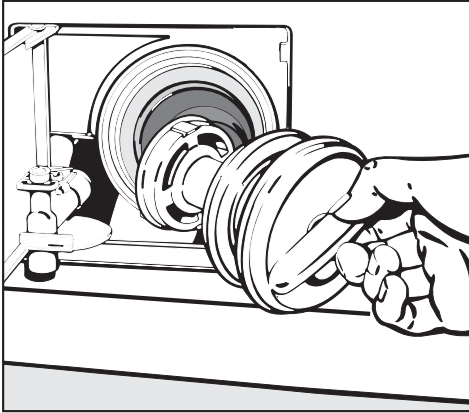

- Once the flow of water ceases, remove the fluff filter completely.

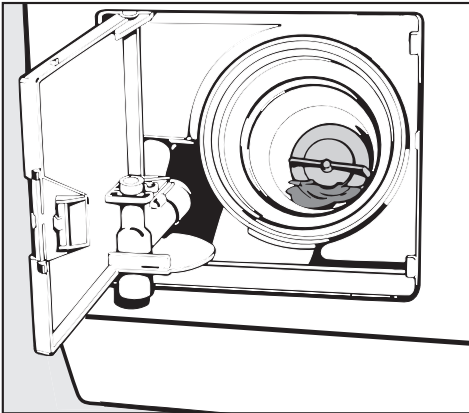

- Clean the fluff filter thoroughly.
- Remove any foreign objects (e.g. buttons, coins, etc.) and fluff.
- Turn the impeller by hand to make sure it rotates freely. Any foreign objects causing an obstruction should be removed.

- Clean the inside of the fluff filter housing.

Remove any deposits of limescale and detergent or foreign objects from the thread of the filter housing and filter unit as they can cause water to leak. Limescale deposits are often a sign of using too little detergent.

- Put the fluff filter back in place and secure it.

Make sure the fluff filter is securely tightened. Otherwise there is a risk of water leakage during use.

### After cleaning

- Pour approx. 2 litres of water into the detergent dispenser compartment  to reactivate the ball valve which keeps detergent in circulation in the suds.



### Cleaning the filter in the water inlet

The washing machine has a filter to protect the water inlet valve.

The accessible filter in the union in the open end of the inlet hose should be checked every six months, or more often if there are frequent interruptions to the external water supply.

- First turn off the stopcock.
- Unscrew the threaded union connecting the free end of the inlet hose to the stopcock.
- Remove rubber seal ① from the recess.

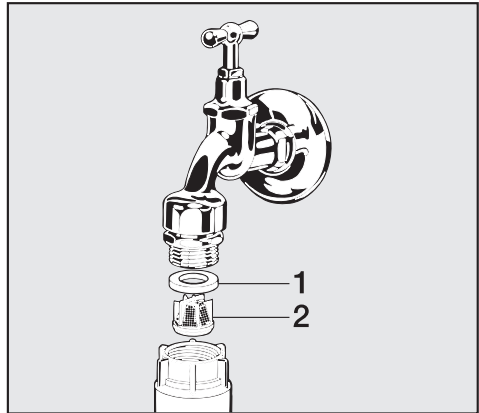

- Using pointed pliers, take hold of the plastic filter bar, remove the filter ② and clean.
- Put the filter and seal back in the reverse order and reconnect the hose.

Turn on the stopcock and check the connection is watertight. If water drips out, tighten the connection.

**Never** forget to put the filter back in place after cleaning it.

## Problem solving guide

With the help of the following notes minor faults in the performance of the appliance, some of which may result from incorrect operation, can be put right without contacting the Service Department.

 Repair work to electrical appliances should only be carried out by a suitably qualified person in accordance with local and national safety regulations. Unauthorised repairs could be dangerous.

### The chart is divided into the following sections to help you:

- The programme does not start.
- The wash programme stops and a fault indicator light comes on.
- A fault indicator light comes on but the wash programme continues as normal.
- General problems or an unsatisfactory wash result.

### The programme does not start.

What to do if . . .	Possible cause	Remedy
<b>The indicator lights for the PROGRAMME touch pads have not lit up.</b>	There is no power.	Check that <ul style="list-style-type: none"><li>– the door is properly closed.</li><li>– the mains plug is plugged in.</li><li>– the fuse or circuit breaker has not tripped.</li></ul>
<b>The CHECK LIGHT <i>Locked</i> is flashing.</b>	The lock function is switched on.	Switch the lock function off.

### The wash programme stops and a fault indicator light comes on.

What to do if . . .	Possible cause	Remedy
<b>The buzzer sounds and the CHECK LIGHT <i>Drain</i> is flashing.</b>	The water outlet is blocked.	Clean the fluff (drain) filter and drain pump.
	The drain hose has been fixed too high.	The maximum drain height is 1 m.
<b>The buzzer sounds and the CHECK LIGHT <i>Water inlet</i> is flashing.</b>	The water inlet is blocked	<ul style="list-style-type: none"> <li>– Open the stopcock.</li> <li>– Start the programme again.</li> </ul>
<b>The buzzer sounds and the CHECK LIGHT <i>Water inlet</i> and <i>Drain</i> flash.</b>	The Waterproof system has reacted.	Call the Service Department.
<b>One of the following indicator lights is flashing:</b> <ul style="list-style-type: none"> <li>– <i>Pre-wash</i> + buzzer</li> <li>– <i>Main wash</i></li> <li>– <i>Rinses 1-2</i> + buzzer</li> <li>– <i>Rinse 3</i></li> </ul>	There is a fault.	<ul style="list-style-type: none"> <li>– Press I-ON/0-OFF button to release it.</li> <li>– Re-start the programme.</li> <li>– If the fault indicators occur again, call the Service Department.</li> </ul>
<b>Three horizontal bars – – – appear in the display and the buzzer is sounding.</b>	There is a fault.	<ul style="list-style-type: none"> <li>– Press I-ON/0-OFF button to release it.</li> <li>– Re-start the programme.</li> <li>– If the three horizontal bars – – – appear again, call the Service Department.</li> </ul>

## Problem solving guide



**A fault indicator light comes on but the wash programme continues as normal.**

<b>What to do if . . .</b>	<b>Possible cause</b>	<b>Remedy</b>
<b>The CHECK LIGHT <i>Drain</i> is flashing.</b>	The drain outlet is restricted.	Clean the fluff (drain) filter and drain pump.
<b>The CHECK LIGHT <i>Water inlet</i> is flashing.</b>	The water inlet is restricted or the water pressure is too low.	<ul style="list-style-type: none"> <li>– make sure the stopcock is opened wide enough.</li> <li>– make sure the inlet hose is not kinked.</li> </ul>
	The filter in the inlet hose is dirty.	Clean the filter.
<b>The <i>Final spin</i> indicator light flashes in the programme sequence display.</b>	The final spin has not taken place. The machine detected an imbalance.	<ul style="list-style-type: none"> <li>– Loosen and re-distribute the washing.</li> <li>– Select the programme <i>Drain/Spin</i>.</li> <li>– Take into account the spin speed of the relevant programme.</li> </ul>
<b>The CHECK LIGHT <i>Locked</i> is on.</b>	Programme locking is switched on.	Switch off the programme locking.
<b>The CHECK LIGHT <i>Excess detergent</i> is flashing.</b>	Excessive foam has built up during washing.	Use less detergent next time and follow the recommendation on the packaging.

### General problems or an unsatisfactory wash result

What to do if . . .	Possible cause	Remedy
<b>The machine shakes during the spin cycle.</b>	The four feet are not resting evenly on the floor.	Level the machine. See advice on installation.
<b>The laundry has not been spun satisfactorily.</b>	The spin speed selected was too low.	Select a higher spin speed next time.
<b>The drum door cannot be opened by pressing the <i>Door</i> button.</b>	The machine is not connected to the electricity supply.	Put the plug in the socket and switch on.
	Power cut.	Open the drum door as described in the section "Opening the door in the event of a power failure".
	The door was not correctly engaged.	Press hard against the lock side of the drum door and then press the <i>Door</i> button.
	There is still water in the drum and the machine is unable to drain.	Clean the fluff (drain) filter and the drain pump.
	For safety reasons the drum door cannot be opened if the suds temperature is higher than 55°C.	

## Problem solving guide

What to do if . . .	Possible cause	Remedy
<b>The pump makes strange noises.</b>	These do not indicate a fault. They occur at the beginning and end of a pumping sequence as a normal part of the operation.	
<b>Large residues of detergent remain in the dispenser drawer.</b>	The water supply pressure is too low.	<ul style="list-style-type: none"> <li>– Clean the filter in the water inlet system.</li> <li>– It may be useful to press the Water plus button.</li> </ul>
	Washing powder used with water softener tends to become sticky.	Pour washing powder into the dispenser before adding any water softener.
<b>Fabric conditioner is not completely dispensed or too much water remains in the  compartment.</b>	The siphon is either incorrectly positioned or clogged.	Clean the siphon, see "Cleaning and care - Cleaning the detergent drawer".
	The fabric conditioner channel is clogged.	Clean the fabric conditioner channel.
<b>Liquid detergent does not give the required result.</b>	Liquid detergents do not contain bleaching agents. They do not remove fruit, coffee and tea stains.	<ul style="list-style-type: none"> <li>– Use a general purpose washing machine powder containing a bleaching agent.</li> <li>– Pour stain removers into compartment  of the dispenser drawer and liquid detergent into a dispenser ball.</li> <li>– Never put stain removers and liquid detergent together in the dispenser drawer.</li> </ul>

## Problem solving guide

What to do if . . .	Possible cause	Remedy
<b>Grey, greasy particles cling to washed laundry.</b>	Insufficient amounts of detergent were used to break down the particles of grease, e.g. from oils and lotions, in heavily soiled laundry.	<ul style="list-style-type: none"><li>– Add more detergent.</li><li>– Before washing the next load run a COTTONS programme at 70°C or above with powder detergent but without a load. (See "Extra cleaning" in Cleaning and Care).</li></ul>
<b>There are white residues which look like powder detergent on dark coloured laundry.</b>	The detergent contained compounds (zeolites) to aid water softening which are not soluble in water. These have ended up on the laundry.	<ul style="list-style-type: none"><li>– Try and brush off the residues with a soft brush once the laundry is dry.</li><li>– Use a liquid detergent to wash dark coloured textiles. Liquid detergents usually contain no zeolites.</li></ul>

## Problem solving guide

### Opening the drum door in the event of a power failure

If the drain outlet is clogged, more water will be retained in the machine (**up to 25 litres**).

Caution: If laundry has been washed at a high temperature, water draining out of the machine will still be hot.

- Switch off the washing machine.

Take the (yellow) filter flap opener from behind the detergent drawer facia panel, (see illustration below).

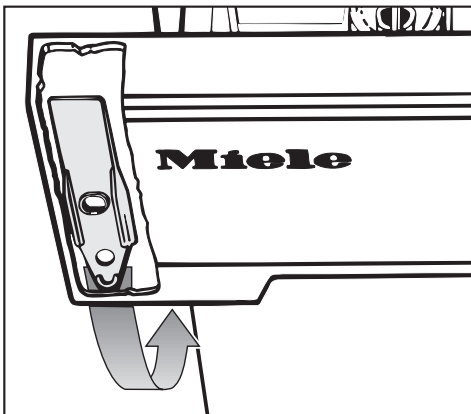

- Remove the opener.

#### Important

Left hand hinged machines have two access panels in the plinth. The left hand panel conceals the emergency drainage.

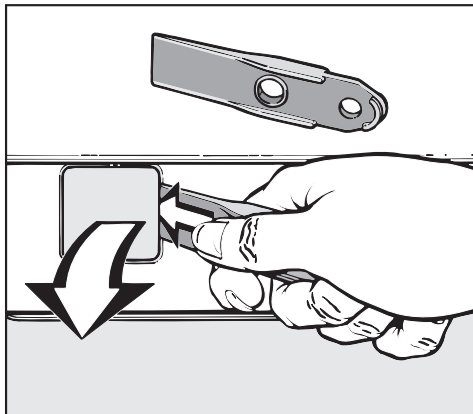

- Open the flap (in the machine plinth).
- Place a dish or bowl under the spout.
- Point the drain hose into the container.

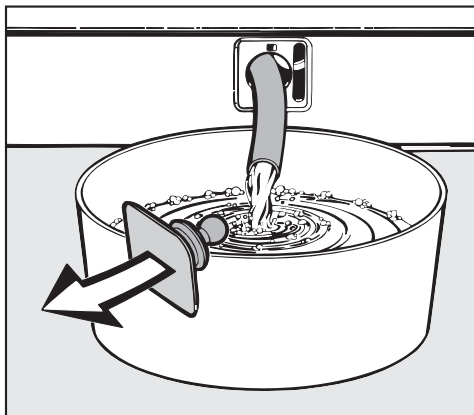

- Remove the stopper. When no more water comes out, replace the stopper in the end of the hose.
- If there is a large amount of water in the machine this procedure will have to be repeated several times.



Always make sure the drum is stationary before reaching in to the machine to remove washing. Reaching into a moving drum is extremely dangerous.

## Door hinged right

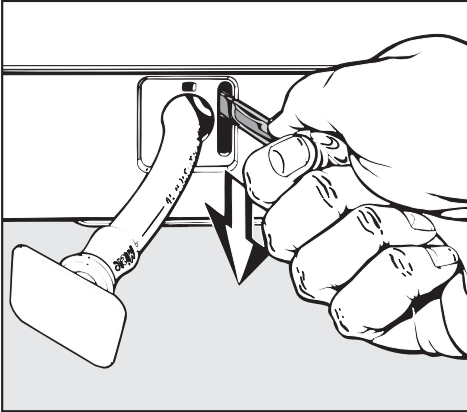

- Pull the emergency door latch downwards (see illustration). The machine door will then open.

## Door hinged left

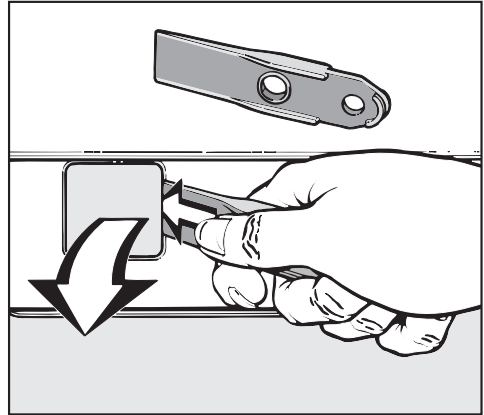

- Open the access panel on the right hand side of the plinth.

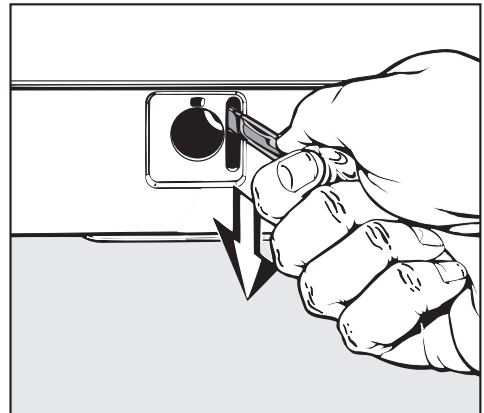

- Pull the emergency door latch downwards (see illustration). The machine door will then open.

# After sales service

---

## Customer contact

In the event of any faults which you cannot remedy yourself please contact

- Your Miele Dealer or
- Your nearest Miele Service department

(see back cover for the address).

When contacting the Service Department, please quote the Model and Serial Nos. of your appliance, both of which are shown on the data plate visible above the porthole glass when the door front is opened.

Please note that telephone calls may be monitored and recorded to improve our service.



## Future updates (PC)

The indicator light or check light marked PC is reserved for the service engineer, for updates to your machine in future years.

When for example technological developments offer advanced modifications to your existing programme cycles, a service engineer will be able to input these into your machine controls.

Miele will provide information when such possibilities become available.

## Installation surface

A concrete floor is the most suitable installation surface for a washing machine, being far less prone to vibration during the spin cycle than wooden floorboards or a carpeted surface.

Please note the following points:

- The machine must be level and securely positioned.
- To avoid vibrations during spinning, the machine should not be installed on soft floor coverings.
- If installing on a wooden joist floor, we recommend a plywood base at least 30 mm thick, 590 x 520 mm wide. The base should span several joists and be bolted to the joists, not only to the floorboards. Check for the presence of pipes and cables first. The most stable part of the floor is usually in the corner.

 If the machine is installed on a raised plinth, it **has to be** secured against slippage during spin using retaining clips (available from the Miele Spare Parts Dept).

## Installation

Lift the machine from its packaging base and move it to its site. Please note:

- Do not lift the machine by the drum door.
- Ensure that the machine feet and the floor are dry to prevent the machine from slipping during the spin cycle.

## Removing the transit fitting

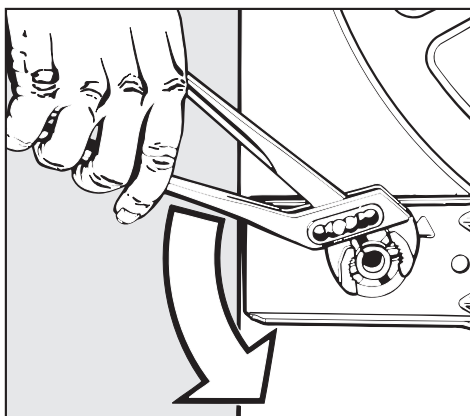

- 1 Turn the left-hand transit bar 90°.

# Installation

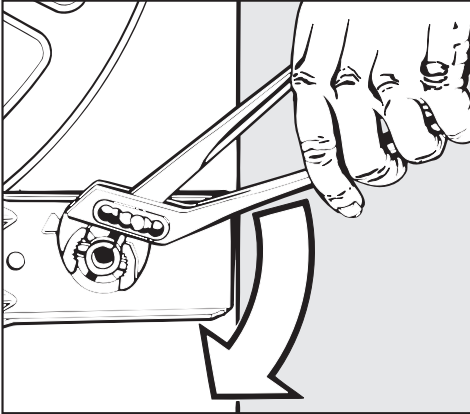

- 2 Turn the right-hand transit bar 90°.

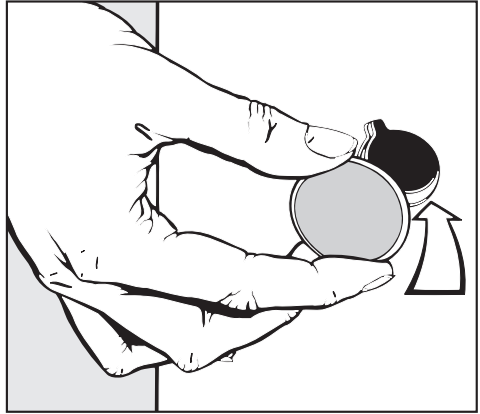

- 4 Plug the two holes with the plastic caps supplied.

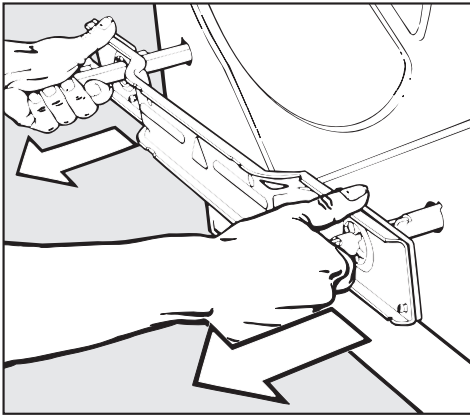

- 3 Withdraw the two bars together with the support plate.

 The washing machine must not be moved without the transit bars in place. Store the transit bars in a safe place for future use. They must be re-fitted if the machine is to be moved again (e.g. when moving house).

## Re-fitting the transit bars

Re-fitting is carried out by reversing the procedure.

## Levelling the machine

The machine must stand perfectly level on all four feet to ensure safe and proper operation.

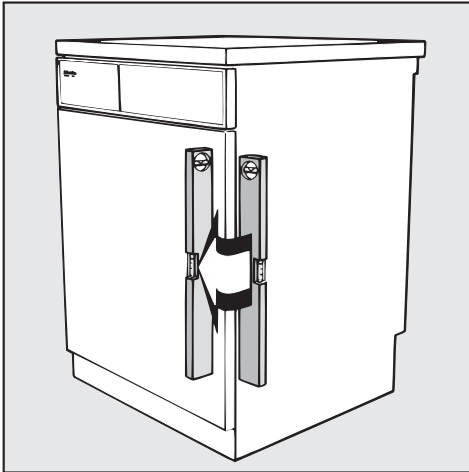

Incorrect installation may increase electricity and water consumption and may cause the machine to move about.

The four adjustable screw feet are used to level the machine. All four feet are screwed in when the machine is delivered.

### Unscrewing and adjusting the feet

- Gently tip the machine and prop it up using a solid wood wedge for example, to ensure stability.

 Make sure the machine does not slip as this could cause injury.

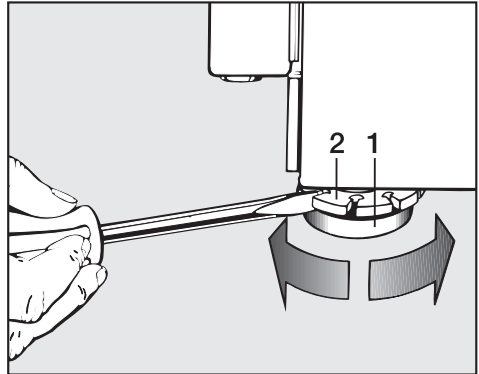

- Using a screwdriver loosen foot **1** together with counter nut **2** by turning it anti-clockwise, and unscrew to the required height.
- Put the machine back on all four feet.
- Use a spirit level to check the machine is standing level.
- Hold foot **1** securely using a pipe wrench and using a screwdriver turn the counternut **2** clockwise until it sits firmly up against the housing.

 All four counternuts must sit firmly up against the housing. Please also check this for the feet which did not need adjustment. Otherwise there is the danger of the machine moving about.

# Installation

## Building under:

Building under a continuous worktop / in a row of kitchen units

- A special building-under kit\* is required. The machine lid has to be replaced by a special cover plate\*\* and to ensure electrical safety it should be fitted by a competent person.

\*\* N.B.: If you wish to push your machine under a worktop and there is space to do this without removing the lid, the building-under kit is not necessary. Otherwise

- Fitting instructions are supplied with the building under kit.

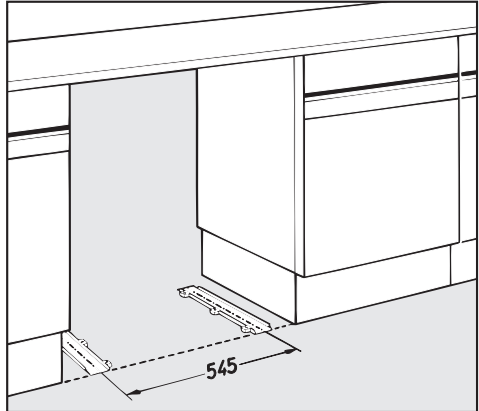

The slides supplied should be used to protect the floor from damage when the machine is pushed into position or taken out for servicing.

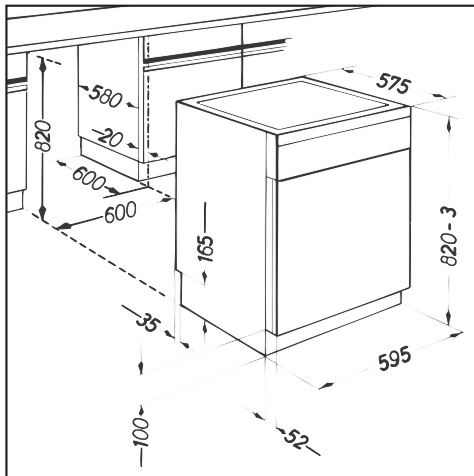

- If it is being installed under a 900/910 mm high worktop a raising kit\* is required.

Connections for electricity, water and drainage should be installed in such a way that they are accessible after the machine has been installed.

## Washer - dryer stack

A Miele tumble dryer can be stacked on top of this washing machine. To do this the appropriate stacking kit\* (WTV) to match your washing machine is required.

All items marked \* are available to order from your Miele Dealer or from the Miele Spare Parts Dept.

## Fitting or changing the decor panel

Note: The door should be kept shut for fitting or changing the decor panel.

- Unscrew 4 screws from the decor strip on the door catch side of the door and take the decor strip off.

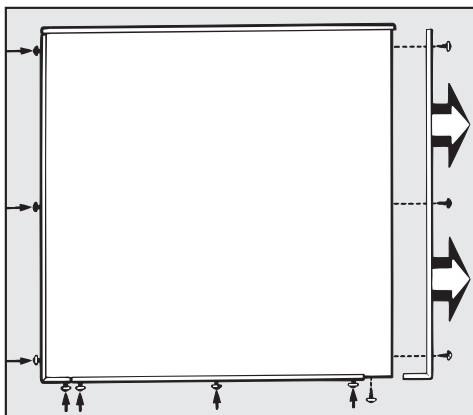

- Unscrew the remaining 7 screws from the lower and side decor strips until the decor panel bows slightly. It can then be taken off and a new one fitted.

Re-assemble in the reverse order and tighten the screws.

## Decor panel dimensions

(The figures given in brackets indicate the tolerance level in mm.)

	Panel thickness 1 mm to 1.5 mm	Panel thickness 1.6 mm to 4 mm
Width	586 (+1) mm	586 (+1) mm
Height	600 (+1.5) mm	595.0 (+1.5) mm

Panels more than 1.5 mm thick require an adapter strip for a 4 mm thick decor panel. This is available from your Miele dealer or the Miele Spare Parts Department:

# Installation

## Fitting a plinth facing

The appliance plinth below the door can be fitted with a plinth facing to match your kitchen.

The height and return of the appliance plinth cannot be altered.

Higher plinth can only be fitted if the overall niche height is higher.

Plinth height	Niche height	
100 mm (standard)	820 mm	
150 mm	870 mm	one raising kit is required
200 mm	920 mm	two raising kits are required

A plinth facing (600 mm long) can be ordered from your Kitchen Dealer or manufacturer. For Miele kitchens please quote the model number of your machine when ordering.

Before fitting the plinth facing, please note: Under no circumstances must anything be stuck over the flap(s) in the appliance plinth.

**In order to open the drum door during an emergency the plinth facing must be removable.**

## Fitting the plinth facing:

- Stick the velcro strip provided to the appliance plinth.

For this the following procedure is recommended:

- Match up the hooked side and the looped side of the velcro strip lengthwise.
- Cut it into 2 or 3 sections.
- Peel the protective backing off one side of the lengths of velcro.
- Position the velcro strips along the appliance plinth, at the left and right hand sides and in the middle and then press firmly into place.
- Carefully remove the remaining protective foil from the velcro.

Press the plinth facing onto the adhesive surface of the velcro strips and press firmly into position.



## Connection to water supply

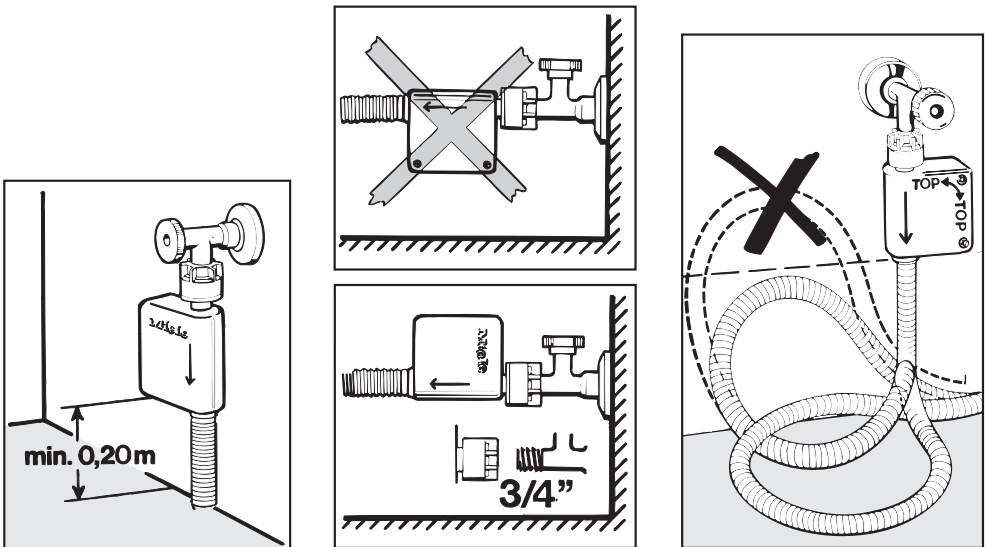

### Fitting

The machine should be connected to a mains water supply in accordance with standard regulations. In Germany the washing machine is not required to have a non-return valve as it has been designed to comply with the relevant German DIN standard.

The machine is designed to operate with a minimum water pressure of 1 bar. There is a minimum flow pressure of 1 bar if 5 litres of water flow into a suitable container in 15 seconds. The static water pressure must not exceed 10 bar. If it is higher than 10 bar it is essential to fit a reducer valve.

The **Miele Waterproof-System** connected between the stopcock and the machine offers the safest protection against water leaks.

For the Waterproof system to function correctly, it may only be fitted in the positions shown (see illustrations).

Connection to the mains water supply should incorporate a mains stopcock with  $\frac{3}{4}$ " thread. The stopcock should be fitted by a qualified plumber.

# Installation

The connection point is subject to mains water pressure. Turn on the stopcock slowly and check for leaks. Correct the position of the washer and union if appropriate.

The "Waterproof system" is **NOT** suitable for connection to a hot water supply.

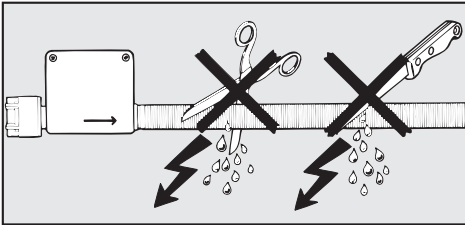

The protective sleeve of the hose **must not be damaged** (see illustration).

A "Waterproof system" with a hose length of approx. 4.5 metres is available as an optional extra from your Miele dealer or the Spare Parts Department.

## Function

At the heart of this leak protection system there is an **electric safety valve**, which works like an automatic stopcock.

The Miele "Waterproof system" protects from water damage in the following cases:

## Protection in the event of a leaking machine.

Any leaking water is collected in a sump in the base of the appliance. A float switch switches the safety valve off electrically. No more water will flow in.

## Protection in the event of a leaking water inlet hose

Leaking water is fed into the sump through the protective covering which surrounds the inlet hose as a "second skin". The float switch turns off the water supply.

## Maintenance

N.B. If you need to unscrew the "Waterproof system" unit from the mains water supply it is essential that the machine is first disconnected from the electricity supply.

Only use a genuine Miele "Waterproof system" able to withstand pressure of up to 70 bar, should you ever need a replacement.

To protect the filters in the water inlet valves the dirt filter in the "Waterproof system" connection must not be removed.

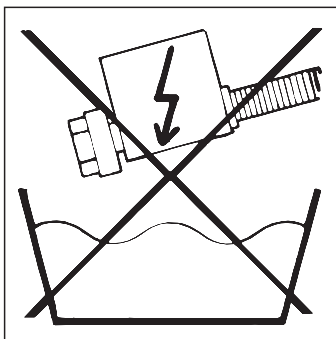
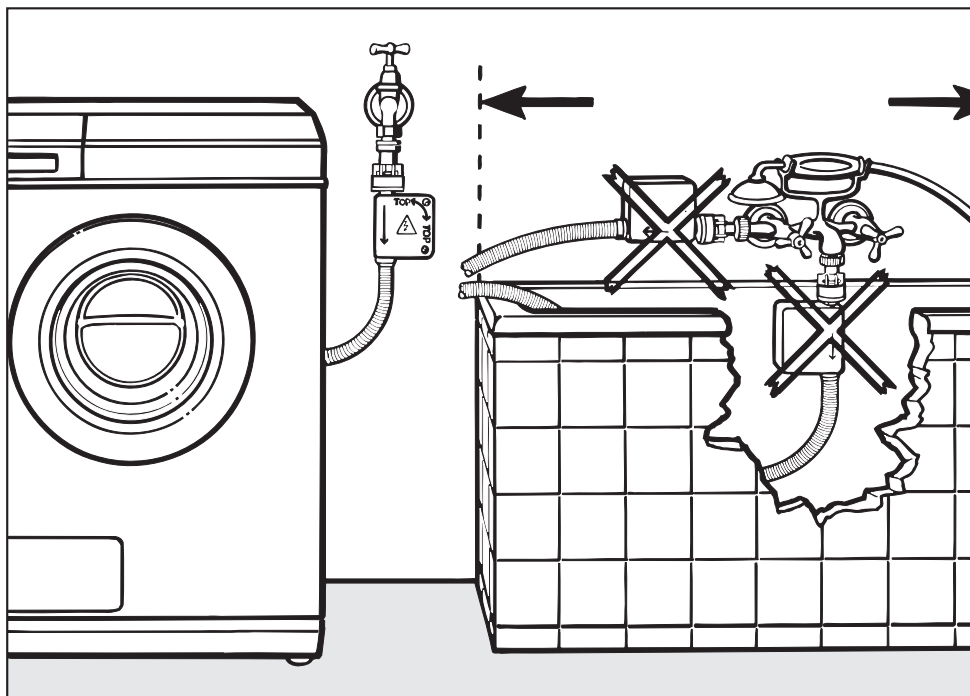

The "Waterproof system" must only be connected to its own stopcock. It must not be connected to mixer taps or similar.

## Important!

The plastic casing of the water connection contains an electric component.

**Do not dip into any liquid!**

# Installation

---

## Connection to the drainage system

The machine drains via a drain pump with a delivery head of 1 metre.

The drain hose is 1.5 m long. It must not be kinked as this restricts drainage. The swivel elbow at the end of the hose can be turned in either direction, or can be detached if required, with a sharp twist and pull.

### Drain hose connection:

1. Direct into a sink or basin:

Please note the following

- Hook the hose over the edge and secure.
  - Make sure that the water can drain away freely without hindrance. Otherwise there is a risk of water overflowing or of some of the drained water being sucked back into the machine.
2. Connected securely to a plastic drain pipe with a rubber nipple. There is no need to use a non-return valve.
  3. Connected securely to a standpipe.
  4. Connected securely to a floor gully.

If required, the drain hose can be extended to a length of 5 m. The necessary parts can be purchased from the Miele Spare Parts Department, or your Miele dealer.

For a delivery head of more than 1 m (up to a maximum of 1.8 m) a second Duo-drain pump is available with the corresponding conversion kit from the Miele Spare Parts Department or your Miele dealer.

## Electrical connection U.K.

All electrical work should be carried out only by a suitably qualified and competent person, in strict accordance with national and local safety regulations.

Ensure power is not supplied to the appliance while installation work is being carried out.

The appliance is supplied with a mains cable with moulded plug for connection to a 230-240V mains supply. **The voltage, rated load and fuse rating are given on the data plate.** Please ensure these match the household mains supply.

Connection should be made via a fused plug and suitable switched socket which is easily accessible after installation.

For extra safety it is advisable to install a residual current device (RCD), with a trip current of 30 mA (in accordance with DIN VDE 0664, VDE 0100, section 739).

Do not connect via an extension lead.

## Electrical connection U.K. Non-rewireable plugs BS 1363

If this machine is fitted with a non-rewireable plug and the socket outlets are not suitable for the plug supplied or if the existing plug needs to be replaced by a new one, the old plug will need to be cut off and an appropriate plug fitted. The fuse carrier and the fuse should be removed from the old plug and disposed of.

The plug cut from the cable should then be disposed of and on no account be inserted into any socket elsewhere in the house (electric shock hazard).

The fuse cover must be refitted when changing the fuse, and if the fuse cover is lost, the plug must not be used until a suitable replacement is obtained. The colour of the correct replacement cover is that of the coloured insert in the base of the plug, or the colour that is embossed in words on the base of the plug (as applicable to the design of plug fitted).

Replacement fuses should be ASTA approved to BS 1362 and have the correct rating. Replacement fuse covers may be purchased from your local electrical supplier or Service agent.

# Installation

---

## Important

The wires in the mains lead are coloured in accordance with the following code:

Green/yellow = earth

Blue = neutral

Brown = live

If the colours of the wires in the mains lead of this appliance do not correspond with the coloured markings identifying the terminals of your plug, proceed as follows:

- The wire which is coloured green and yellow must be connected to the terminal in the plug which is marked with the letter E or by the earth symbol  $\perp$  or coloured green, or green and yellow.
- The wire which is coloured blue must be connected to the terminal in the plug which is marked with the letter N or coloured black.
- The wire which is coloured brown must be connected to the terminal in the plug which is marked with the letter L or coloured red.

**WARNING: THIS APPLIANCE  
MUST BE EARTHED**

## Consumption data

Programme (without any additional options or programmable functions)	Load	Consumption data			
		Energy in kWh	Water litres	Programme time	
				normal	short
<b>COTTONS</b>					
95°C	5.0 kg	1.70	49	1 h 54 mins	1 h 22 mins
60°C <sup>(1)</sup>	5.0 kg	0.95	49	1 h 58 mins	1 h 16 mins
40°C	5.0 kg	0.55	49	1 h 58 mins	1 h 06 mins
<b>MINIMUM IRON</b>					
40°C	2.5 kg	0.45	58	1 h 20 mins	49 mins
<b>DELICATES</b>					
30°C	1.0 kg	0.40	75	58 mins	48 mins
<b>WOOLLENS</b>					
30°C	1.0 kg	0.15	25	35 mins	-

<sup>(1)</sup> EN 60456 test programme

Consumption data can vary from the nominal values given depending on water pressure, water hardness, water inlet temperature, room temperature, type and volume of load, fluctuations in the electricity supply and any additional functions selected.

N.B.

Consumption data obtained from a machine designed for the German market.

## Technical Data

---

Height	85.0 cm
Width	59.5 cm
Depth	60.0 cm
Depth with door open	97.0 cm
Weight	102 kg
Maximum floor load	1600 Newton (ca. 160 kg)
Capacity	5 kg dry laundry
Voltage	see data plate
Rated load	see data plate
Fuse rating	see data plate
Water flow pressure min.	1 bar (100 kPa)
Water flow pressure max.	10 bar (1000 kPa)
Drain pump head max.	1.00 m
Drain pump head max.	5.00 m
Test certificates awarded	Radio/TV suppression, VDE









**United Kingdom:**

Miele Co. Ltd.  
Fairacres, Marcham Road  
Abingdon, Oxon, OX14 1TW  
tel. Abingdon (01235) 554455  
Service Office: (01235) 554466  
fax (01235) 554477  
Internet: [www.miele.co.uk](http://www.miele.co.uk)

**Ireland:**

Miele Ireland Ltd.  
Broomhill Road, Tallaght, Dublin 24  
Tel: (01) 46 10 710, Fax: (01) 46 10 797  
Email: [info@miele.ie](mailto:info@miele.ie)  
Internet: <http://www.miele.ie>

**Australia:**

Miele Australia Pty. Ltd.  
A.C.N. 005635398  
1 Gilbert Park Drive  
Knoxfield, VIC 3180  
Telephone: (03) 9764 7100  
Fax: (03) 9764 7129

**Distributor New Zealand:**

Steelfort Engineering Company. Ltd.  
500 Rangitikei Street  
Palmerston North, Priv. Bag 11045, NZ  
Telephone: (06) 350 1350  
Fax: (06) 356 1507

**South Africa:**

Miele (Pty) Ltd  
304 Tungsten Road  
Strijdom Park 2194  
P.O.Box 1654, Randburg 2125  
Tel. (011) 793-7452  
Telefax (011) 793-7447  
E-mail: [info@miele.co.za](mailto:info@miele.co.za)  
Internet: [www.miele.co.za](http://www.miele.co.za)

**Singapore:**

Miele Southeast Asia  
Miele Pte. Ltd.  
163 Penang Road  
# 04 - 02/03 Winsland House II  
Singapore 238463  
Tel : +65-67351161  
Fax: +65-67351191  
Email: [mielesea@miele.com.sg](mailto:mielesea@miele.com.sg)

**Hong Kong:**

Miele (Hong Kong) Limited  
AIA Plaza, Room 401, 4<sup>th</sup> Floor  
18 Hysan Avenue  
Causeway Bay  
Hong Kong  
Tel.: (852) 2610 1331  
Fax: (852) 2610 1013  
E-mail: [mielehk@netvigator.com](mailto:mielehk@netvigator.com)

## Free Manuals Download Website

<http://myh66.com>

<http://usermanuals.us>

<http://www.somanuals.com>

<http://www.4manuals.cc>

<http://www.manual-lib.com>

<http://www.404manual.com>

<http://www.luxmanual.com>

<http://aubethermostatmanual.com>

Golf course search by state

<http://golfingnear.com>

Email search by domain

<http://emailbydomain.com>

Auto manuals search

<http://auto.somanuals.com>

TV manuals search

<http://tv.somanuals.com>