

COMPLIANCE INFORMATION

UL Listed
C-UL Listed (Canada)
CISPR/EN55022 Class A

FCC Regulations

This equipment has been tested and found to comply with the limits for a class A digital device, pursuant to part 15 of the FCC rules. These limits are designed to provide reasonable protection against harmful interference when the equipment is operated in a commercial environment. This equipment generates, uses, and can radiate radio frequency energy and, if not installed and used in accordance with the instruction manual, may cause harmful interference to radio communications. Operation of this equipment in a residential area is likely to cause harmful interference, in which case the user will be required to correct the interference at the user's own expense.

Canadian Regulations

This digital apparatus does not exceed the Class A limits for radio noise for digital apparatus set out on the radio interference regulations of the Canadian Department of Communications.

Le présent appareil numérique n'émet pas de bruits radioélectriques dépassant les limites applicables aux appareils numériques de la class A prescrites dans le Règlement sur le brouillage radioélectrique édicté par le ministère des Communications du Canada.

European Regulations

Warning

This is a Class A product. In a domestic environment this product may cause radio interference in which case the user may be required to take adequate measures.

Achtung !

Dieses ist ein Gerät der Funkstörgrenzwertklasse A. In Wohnbereichen können bei Betrieb dieses Gerätes Rundfunkstörungen auftreten, in welchen Fällen der Benutzer für entsprechende Gegenmaßnahmen verantwortlich ist.

Attention !

Ceci est un produit de Classe A. Dans un environnement domestique, ce produit risque de créer des interférences radioélectriques, il appartiendra alors à l'utilisateur de prendre les mesures spécifiques appropriées



CAUTION: RJ connectors are NOT INTENDED FOR CONNECTION TO THE PUBLIC TELEPHONE NETWORK. Failure to observe this caution could result in damage to the public telephone network.

Der Anschluss dieses Gerätes an ein öffentliches Telekommunikationsnetz in den EG-Mitgliedstaaten verstößt gegen die jeweiligen einzelstaatlichen Gesetze zur Anwendung der Richtlinie 91/263/EWG zur Angleichung der Rechtsvorschriften der Mitgliedstaaten über Telekommunikationsendeinrichtungen einschliesslich der gegenseitigen Anerkennung ihrer Konformität.

Trademark Notice

All registered trademarks and trademarks are the property of their respective owners.

Copyright Restrictions

© 1999-2001 TRANSITION Networks.

All rights reserved. No part of this work may be reproduced or used in any form or by any means – graphic, electronic, or mechanical – without written permission from TRANSITION Networks.

Printed in the U.S.A.

Download from www.Somanuals.com. All Manuals Search And Download.

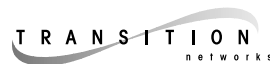

T1/E1 Copper-to-Fiber Media Converters T1E1-CF-01 USER'S GUIDE

TRANSITION Networks T1E1-CF-01 series media converters encode and decode T1 OR E1 signals over duplex fiber cables to extend the distance and transmission reliability of high speed T1 and E1 data traffic.

T1E1-CF-01

*Provides an RJ-45 twisted pair connector for T1 OR E1 signals, a set of RX (receive) and TX (transmit) coax connectors for E1 signals, and a set of RX and TX **ST** connectors to **850 nm multimode** fiber-optic cable.*

T1E1-CF-01(SC)

*Provides an RJ-45 twisted pair connector for T1 OR E1 signals, a set of RX (receive) and TX (transmit) coax connectors for E1 signals, and a set of RX and TX **SC** connectors to **850 nm multimode** fiber-optic cable.*

T1E1-CF-01(SM)

*Provides an RJ-45 twisted pair connector for T1 OR E1 signals, a set of RX (receive) and TX (transmit) coax connectors for E1 signals, and a set of RX and TX **ST** connectors to **1300 nm singlemode** fiber-optic cable.*

T1E1-CF-01(LH)

*Provides an RJ-45 twisted pair connector for T1 OR E1 signals, a set of RX (receive) and TX (transmit) coax connectors for E1 signals, and a set of RX and TX **ST** connectors to **1300 nm singlemode** fiber-optic cable.*

T1E1-CF-01 in the Network	2
Installation	4
Operation	7
Fault Isolation and Correction	8
Cable Specifications	10
Technical Specifications	11
Compliance Information	12

T1E1-CF-01 IN THE NETWORK

NOTE: THE T1E1-CF-01 REQUIRES A CSU BETWEEN THE MEDIA CONVERTER AND THE PUBLIC TELEPHONE NETWORK.

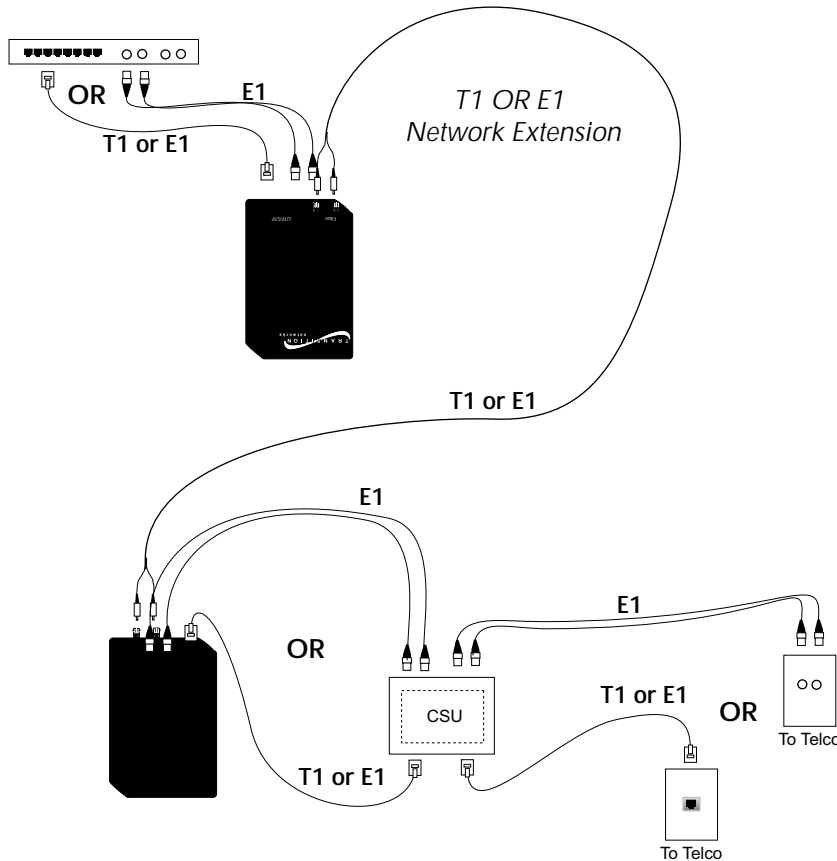

Features

- Media converter is framing independent (as ESF vs D4) and supports all common line codes, (AMI, B8ZS, HDB3).
- Distance extensions of 2 km 850 nm multimode or 8 km 1300 nm singlemode.
- Jitter attenuators optimize Bit Error Rate (BER) performance.
- Dry relay contacts allow media converter to be tied into separate alarm circuit
- All Ones Insertion (AIS), indicated by LEDs, on loss of signal at copper and/or fiber interface.

Download from www.Somanuals.com. All Manuals Search And Download.

TECHNICAL SPECIFICATIONS

Standards	<i>Emissions:</i> CISPR A	
	<i>T1/E1 Physical Layer:</i> ITU-T, ANSI, AT&T, ETSI	
Case Dimensions	4.75" x 3.0" x 2.0"	(119mm x 76mm x 50mm)
Shipping Weight	3 pounds	(1.4 kilograms)
Delay	400nsec round trip	
Environment	Temperature:	0-50°C (32° to 122° F)
	Humidity	10-90%, non condensing
	Altitude	0-10,000 feet

Power Supply Requirements Replace power supply with only the equivalent input rating (see below) and output rating (unregulated 9 VDC).

TN PN	Requirement	Location
3507	240 volts, 50 hertz	United Kingdom
3342	230 volts, 50 hertz	Europe
3340	120 volts, 60 hertz	USA/Canada/Mexico
3346	100 volts, 50-60 hertz	Japan
3511	240 volts, 50 hertz	Australia
3537	(with power cord: 3522)	South Africa

NOTE: This product also can be powered by the Transition Networks E-MCR series media converter rack.

Warranty Lifetime

TRANSITION NETWORKS

DECLARATION OF CONFORMITY

Name of Mfg: **Transition Networks**
6475 City West Parkway, Minneapolis MN 55344 USA

Model: **T1E1-CF-01 Series Copper-to-Fiber Media Converter**

Part Number: **T1E1-CF-01, T1E1-CF-01(SC), T1E1-CF-01(SM), T1E1-CF-01(LH)**

Regulation: **EMC Directive 89/336/EEC**

Purpose: To declare that the **T1E1-CF-01** and **T1E1-CF-01(SM)** to which this declaration refers is in conformity with the following standards.
EMC-CISPR 22: 1985 Class A; EN 55022: 1988 Class A; EN 50082-1:1992; EN 60950 A4:1997; IEC 801.2, IEC 801.3, and IEC 801.4; IEC 950

I, the undersigned, hereby declare that the equipment specified above conforms to the above Directive(s) and Standard(s).

Stephen Anderson
Stephen Anderson, Vice-President of Engineering

June 8, 1999
Date

CABLE SPECIFICATIONS

Fiber Cable

Bit error rate: ≤10⁻⁹

MULTIMODE

Fiber Optic Cable Recommended: 62.5 / 125 μm multimode fiber
 Optional: 100 / 140 μm multimode fiber

85 / 125 μm multimode fiber
 50 / 125 μm multimode fiber

T1E1-CF-01 850 nM

Fiber Optic Transmitter Power: min: -14.0 dBm max: -12.0 dBm

Fiber Optic Receiver Sensitivity: min: -25.0 dBm max: -12.0 dBm

Typical Maximum Cable Distance*: 2 kilometers

T1E1-CF-01(SC) 850 nM

Fiber-optic Transmitter Power: min: -14.0 dBm max: -12.0 dBm

Fiber-optic Receiver Sensitivity: min: -25.0 dBm max: -12.0 dBm

Typical Maximum Cable Distance*: 2 kilometers

SINGLEMODE

Fiber Optic Cable Recommended: 9 μm singlemode fiber

T1E1-CF-01(SM) 1300 nM

Fiber-optic Transmitter Power: min: -21.0 dBm max: -14.0 dBm

Fiber-optic Receiver Sensitivity: min: -25.0 dBm max: -14.0 dBm

Typical Maximum Cable Distance*: 8 kilometers

T1E1-CF-01(LH) 1300 nM

Fiber-optic Transmitter Power: min: -15.0 dBm max: -5.0 dBm

Fiber-optic Receiver Sensitivity: min: -25.0 dBm max: -14.0 dBm

Typical Maximum Cable Distance*: 15 kilometers

*Actual distance dependent upon physical characteristics of network installation.

Twisted-Pair Copper Cable

Twisted pair connection requires two active pairs. The two active pairs in a T1/E1 network are pins 1 & 2 and pins 4 & 5. Use only dedicated wire pairs (such as blue/white & white/blue) for the active pins.

Category 3 or better twisted-pair copper wire is required. Either shielded twisted-pair (STP) or unshielded twisted-pair (UTP) can be used.

T1:

Gauge 24 to 22 AWG
 Attenuation 2.6 dB/100 meters @ 1.0 MHz
 Differential Characteristic Impedance 100 Ω ±10%

E1:

Gauge 24 to 22 AWG
 Attenuation 2.6 dB/100 meters @ 1.0 MHz
 Differential Characteristic Impedance 120 Ω ±10%

Coax Copper Cable

E1:

Gauge 24 to 22 AWG
 Attenuation 2 dB/100 meters @ 1.0 MHz
 Differential Characteristic Impedance 75 Ω ±10%

Dry-Contact Relay

RJ-45 dry-contact relay opens if power, signal detect/copper or signal detect/fiber are lost.

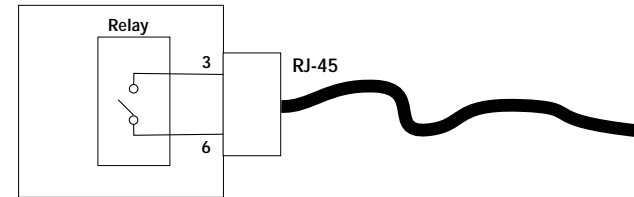

Operational rating on pins 3 and 6: 0-30VDC maximum 1A

Switch-Selectable Configurations

T1 COPPER RJ-45

Configured as either "long haul" or "short haul" on 100 ohm cable, with a variety of selectable distance settings.

E1 COPPER RJ-45

Configured as either "long haul" or "short haul" on 120 ohm cable.

E1 COPPER COAX

Configured as either "long haul" or "short haul" on 75 ohm cable.

STRAIGHT-THROUGH/CROSSOVER RJ-45

Allows straight-through cable to be used where crossover-configuration cable is required.

Switch-Selectable Functions

LOOPBACK TEST FUNCTION

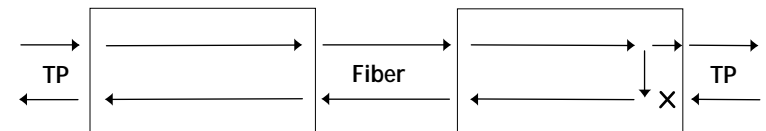

A loopback switch facilitates installation and network debug procedures. The path for the T1E1-CF-01 loopback is shown:

TRANSMIT ALL ONES FUNCTION

A selectable Transmit All Ones switch on the fiber interface and on the twisted-pair interface allows for insertion of an "all ones" pattern on that interface when *signal detect* is lost, which creates an alarm condition at the equipment connected to the interface.

INSTALLATION

Set Switches

Use small flatblade screwdriver or similar device to set recessed switches for site installation. Refer to label on top of media converter for MDI/ MDI-X switch settings. Refer to drawings below and at right for four-position switch settings.

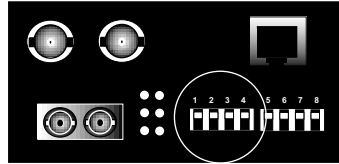

SHORT HAUL Switch Settings Switch #4 UP

1 2 3 4

	E1 2.37V 75 ohm cable Coax connectors
	E1 3.0V 120 ohm cable RJ-45 connector
	DSX-1 0'-133' 100 ohm cable
	DSX-1 133'-266' 100 ohm cable
	DSX-1 266'-399' 100 ohm cable
	DSX-1 399'-533' 100 ohm cable
	DSX-1 533'-655' 100 ohm cable
	ANSI T1.403 100 ohm cable
	DSX-1 6.0V 100 ohm cable

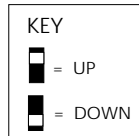

*LONG HAUL Switch Settings Switch #4 DOWN

1 2 3 4

	0 db
	-7.5 db
	-15 db
	-22.5 db

*Switch #3 not used for long haul settings.

5. Is the AISTP LED on either media converter illuminated?

YES

- Determine and correct failure of remote unit connected to twisted-pair interface that caused All Ones Insertion (AIS) on the twisted-

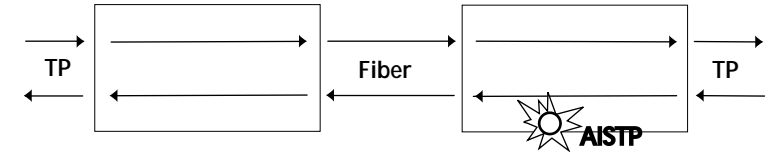

pair interface.

NO

- Contact Technical Support: (800) 260-1312/(800) LAN-WANS.

FAULT ISOLATION and CORRECTION

If the media converter fails, isolate and correct the failure by determining the answers to the following questions and then taking the indicated action:

1. Is the Power LED on the media converter illuminated?

NO

- Is the power adapter the proper voltage and cycle frequency for the AC outlet?
NOTE: Refer to the "Power Supply Requirements" on page 7.
- Is the power adapter properly installed in the media converter and in the outlet?
- Contact Technical Support: (800) 260-1312/(800) LAN-WANS.

YES

- Proceed to step 2.

2. Is the SDFiber (Signal Detect/Fiber) LED illuminated?

NO

- Check fiber cables for proper connection.
- Verify that TX and RX cables on media converter are connected to RX and TX ports, respectively, on other media converter.
- Contact Technical Support: (800) 260-1312/(800) LAN-WANS.

YES

- Proceed to step 3.

3. Is the SDTP (Signal Detect/Twisted-Pair) LED illuminated?

NO

- Check twisted pair cables for proper connection.
- Check RJ-45 Pinning Switch for correct twisted pair cable configuration.
- Check integrity of device attached to media converter by twisted-pair cable.
- Contact Technical Support: (800) 260-1312/(800) LAN-WANS.

YES

- Proceed to step 4.

4. Is the AISFiber LED on either media converter illuminated?

NO

- Proceed to step 5.

YES

- Determine if broken fiber link has caused All Ones Insertion (AIS) on the fiber interface and correct failure. If not, proceed to step 5.

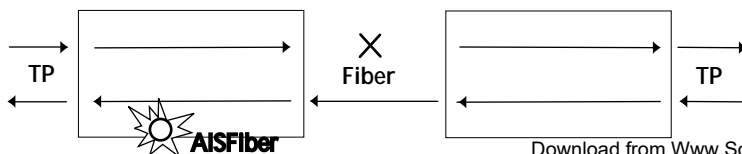

Download from www.Somanuals.com. All Manuals Search And Download.

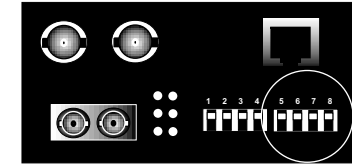

Set switches 5, 6, and 7 to enable test functions or to permit normal network operation. (Switch 8 not used.)

*NETWORK Switch Settings

5 6 7 8

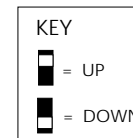

	Normal Operation
	Loop Transmit TP to Receive TP
	Transmit All Ones onto Fiber on loss of SDFiber
	NO Transmit All Ones onto Fiber
	Transmit All Ones onto TP on loss of SDTP
	NO Transmit All Ones onto Twisted-Pair

*Switch #8 not used.

Set the MDI/MDI-X switch to use straight-through cable where crossover-configuration cable is required.

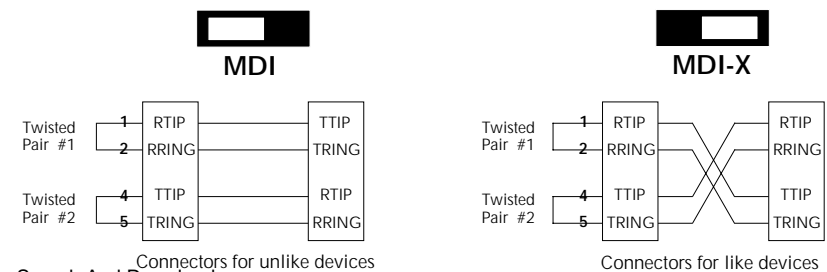

Connectors for unlike devices

Connectors for like devices

INSTALLATION (continued)

Install Cable

COPPER

T1 100 OHM (RJ-45 CONNECTOR)

OR E1 120 OHM (RJ-45 CONNECTOR)

NOTE: KEEP TWISTED-PAIR RUNS AS SHORT AS POSSIBLE.

- Locate or build twisted-pair cables that are compliant with specifications on page 10.
- Connect male RJ-45 plug connector at one end of cable to media converter RJ-45 jack connector.
- Set MDI/MDI-X switch to MDI-X according to network conditions.
- Connect male RJ-45 plug connector at other end of cable to network equipment..

E1 75 OHM (COAX CONNECTOR)

NOTE: Ground coax segment to earth ground at one end.

- Locate or build coax cables that are compliant with specifications on page 10.
- Connect BNC connector at one end of cable to media converter.
- Connect BNC connector at other end of cable to network equipment..

FIBER

- Locate or build duplex fiber cables that are compliant with specifications on page 10.
- Connect male TX and RX cable connectors at one end of cable to TX and RX female connectors, respectively, on media converter.
- Connect male TX and RX cable connectors at other end of cable to RX and TX connectors of compliant fiber device.

Connect to Power

- Install Power Adapter cord at back of Media Converter.
- Connect Power Adapter plug to AC power.
- Verify that Media Converter is powered by observing illuminated LED(s).

OPERATION

After installation, the media converter should function without operator intervention.

Status LEDs

Use the status LEDs to monitor media converter operation in the network.

Power

Steady green LED indicates connection to external AC power.

SDFiber

Signal Detect/Fiber - Steady green LED indicates fiber link is up.

AISFiber

All Ones Insertion/Fiber - Blinking green LED indicates all ones received on fiber

Coax

Steady green LED indicates coax interface selected.

SDTP

Signal Detect/Twisted-Pair - Steady green LED indicates twisted-pair link is up.

AISTP

All Ones Insertion/Twisted-Pair - Blinking green LED indicates all ones received on twisted-pair

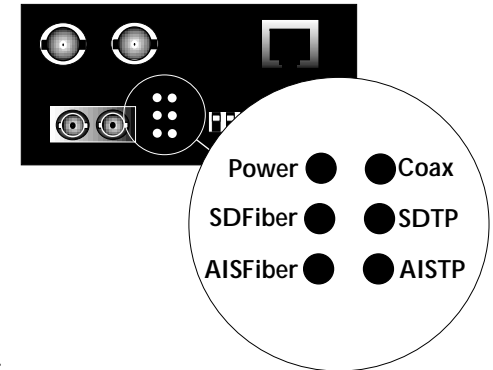

Free Manuals Download Website

<http://myh66.com>

<http://usermanuals.us>

<http://www.somanuals.com>

<http://www.4manuals.cc>

<http://www.manual-lib.com>

<http://www.404manual.com>

<http://www.luxmanual.com>

<http://aubethermostatmanual.com>

Golf course search by state

<http://golfingnear.com>

Email search by domain

<http://emailbydomain.com>

Auto manuals search

<http://auto.somanuals.com>

TV manuals search

<http://tv.somanuals.com>