

# UNITOR

OM-202 515C

2005-12

## Processes



Air Plasma Cutting  
and Gouging

## Description



Air Plasma Cutter

CE

# UPC 838

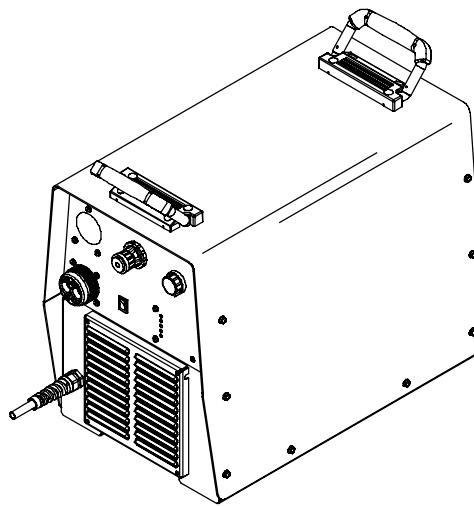

## OWNER'S MANUAL



# TABLE OF CONTENTS

<b>SECTION 1 – SAFETY PRECAUTIONS - READ BEFORE USING</b> .....	<b>1</b>
1-1. Symbol Usage .....	1
1-2. Plasma Arc Cutting Hazards .....	1
1-3. Additional Symbols For Installation, Operation, And Maintenance .....	3
1-4. California Proposition 65 Warnings .....	3
1-5. Principal Safety Standards .....	4
1-6. EMF Information .....	4
<b>SECTION 2 – CONSIGNES DE SÉCURITÉ – LIRE AVANT UTILISATION</b> .....	<b>5</b>
2-1. Signification des symboles .....	5
2-2. Dangers liés au coupage à l'arc au plasma .....	5
2-3. Dangers supplémentaires en relation avec l'installation, le fonctionnement et la maintenance .....	7
2-4. Principales normes de sécurité .....	8
2-5. Information sur les champs électromagnétiques .....	8
<b>SECTION 3 – DEFINITIONS</b> .....	<b>9</b>
3-1. Warning Label Definitions .....	9
3-2. Air Supply Precaution .....	10
3-3. Manufacturer's Rating Label For CE Products .....	11
3-4. Symbols And Definitions .....	11
<b>SECTION 4 – INSTALLATION</b> .....	<b>12</b>
4-1. Specifications .....	12
4-2. Duty Cycle And Overheating .....	12
4-3. Cutting Speed .....	13
4-4. Selecting a Location .....	14
4-5. Connecting Work Clamp And Gas/Air Supply .....	15
4-6. Electrical Service Guide .....	15
4-7. Connecting Input Power .....	16
<b>SECTION 5 – OPERATION</b> .....	<b>17</b>
5-1. Controls .....	17
5-2. Setting Gas/Air Pressure .....	18
5-3. Sequence Of Operation .....	19
<b>SECTION 6 – MAINTENANCE &amp; TROUBLESHOOTING</b> .....	<b>20</b>
6-1. Routine Maintenance .....	20
6-2. Trouble Lights .....	21
6-3. Checking Shield Cup Shutdown System .....	21
6-4. Troubleshooting .....	22
<b>SECTION 7 – ELECTRICAL DIAGRAM</b> .....	<b>24</b>
<b>SECTION 8 – PARTS LIST</b> .....	<b>26</b>

# Declaration of Conformity for European Community (CE) Products

**NOTE** 

This information is provided for units with CE certification (see rating label on unit).

Manufacturer's Name: **Miller Electric Mfg. Co.**

Manufacturer's Address: 1635 W. Spencer Street  
Appleton, WI 54914 USA

Declares that the product: **UPC 838**

conforms to the following Directives and Standards:

### Directives

Electromagnetic Compatibility Directives: 89/336/EEC, 92/31/EEC

Low Voltage Directive: 73/23/EEC

Machinery Directives: 89/392/EEC, 91/368/EEC, 93/C 133/04, 93/68/EEC

### Standards

Electromagnetic compatibility (EMC) Product standard for arc welding equipment:  
EN50199: August 1995

Safety Requirements for Arc Welding Equipment part 1: EN 60974-1: 1989

Arc Welding Equipment Part 1: Welding Power Sources: IEC 974-1  
(September 1998 – Draft revision)

Degrees of Protection provided by Enclosures (IP code): IEC 529: November 1989

Plasma Cutting Systems for Manual Use: EN 50192: 1995

European Contact: Mr. Danilo Fedolfi, Managing Director  
ITW WELDING PRODUCTS ITALY S.r.l.  
Via Privata Iseo 6/E  
20098 San Giuliano  
Milanese, Italy

Telephone: 39(02)98290-1  
Fax: 39(02)98290-203

# SECTION 1 – SAFETY PRECAUTIONS - READ BEFORE USING

pom\_nd\_8/03

## 1-1. Symbol Usage



Means Warning! Watch Out! There are possible hazards with this procedure! The possible hazards are shown in the adjoining symbols.

▲ Marks a special safety message.

☞ Means "Note"; not safety related.



This group of symbols means Warning! Watch Out! possible ELECTRIC SHOCK, MOVING PARTS, and HOT PARTS hazards. Consult symbols and related instructions below for necessary actions to avoid the hazards.

## 1-2. Plasma Arc Cutting Hazards

▲ The symbols shown below are used throughout this manual to call attention to and identify possible hazards. When you see the symbol, watch out, and follow the related instructions to avoid the hazard. The safety information given below is only a summary of the more complete safety information found in the Safety Standards listed in Section 1-5. Read and follow all Safety Standards.

▲ Only qualified persons should install, operate, maintain, and repair this unit.

▲ During operation, keep everybody, especially children, away.

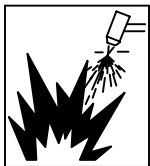

### CUTTING can cause fire or explosion.

Hot metal and sparks blow out from the cutting arc. The flying sparks and hot metal, hot workpiece, and hot equipment can cause fires and burns. Check and be sure the area is safe before doing any cutting.

- Protect yourself and others from flying sparks and hot metal.
- Do not cut where flying sparks can strike flammable material.
- Remove all flammables within 35 ft (10.7 m) of the cutting arc. If this is not possible, tightly cover them with approved covers.
- Be alert that sparks and hot materials from cutting can easily go through small cracks and openings to adjacent areas.
- Watch for fire, and keep a fire extinguisher nearby.
- Be aware that cutting on a ceiling, floor, bulkhead, or partition can cause fire on the hidden side.
- Do not cut on closed containers such as tanks or drums.
- Connect work cable to the work as close to the cutting area as practical to prevent cutting current from traveling long, possibly unknown paths and causing electric shock and fire hazards.
- Never cut containers with potentially flammable materials inside – they must be emptied and properly cleaned first.
- Do not cut in atmospheres containing explosive dust or vapors.
- Do not cut pressurized cylinders, pipes, or vessels.
- Do not cut containers that have held combustibles.
- Wear oil-free protective garments such as leather gloves, heavy shirt, cuffless trousers, high shoes, and a cap.
- Do not locate unit on or over combustible surfaces.
- Remove any combustibles, such as a butane lighter or matches, from your person before doing any cutting.



### ELECTRIC SHOCK can kill.

Touching live electrical parts can cause fatal shocks or severe burns. The torch and work circuit are electrically live whenever the output is on. The input power circuit and machine internal circuits are also live when power is on. Plasma arc cutting requires

higher voltages than welding to start and maintain the arc (200 to 400 volts dc are common), but also uses torches designed with safety interlock systems which turn off the machine when the shield cup is loosened or if tip touches electrode inside the nozzle. Incorrectly installed or improperly grounded equipment is a hazard.



### ELECTRIC SHOCK can kill.

**SIGNIFICANT DC VOLTAGE** exists on internal parts of inverter power sources AFTER the removal of input power.

- Turn Off unit, disconnect input power, check voltage on input capacitors, and be sure it is near zero (0) volts before touching any parts. Check capacitors according to instructions in Maintenance Section of Owner's Manual or Technical Manual before touching any parts.

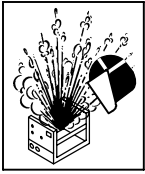

### EXPLODING PARTS can injure.

- On inverter power sources, failed parts can explode or cause other parts to explode when power is applied. Always wear a face shield and long sleeves when servicing inverters.

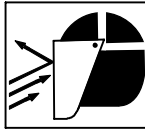

### FLYING SPARKS can cause injury.

Sparks and hot metal blow out from the cutting arc. Chipping and grinding cause flying metal.

- Wear approved face shield or safety goggles with side shields.
- Wear proper body protection to protect skin.
- Wear flame-resistant ear plugs or ear muffs to prevent sparks from entering ears.



### ARC RAYS can burn eyes and skin.

Arc rays from the cutting process produce intense visible and invisible (ultraviolet and infrared) rays that can burn eyes and skin.

- Wear face protection (helmet or shield) with correct shade of filter to protect your face and eyes when cutting or watching. ANSI Z49.1 (see Safety Standards) suggests a No. 9 shade (with No. 8 as minimum) for all cutting currents less than 300 amperes. Z49.1 adds that lighter filter shades may be used when the arc is hidden by the workpiece. As this is normally the case with low current cutting, the shades suggested in Table 1 are provided for the operator's convenience.
- Wear approved safety glasses with side shields under your helmet or shield.
- Use protective screens or barriers to protect others from flash and glare; warn others not to watch the arc.
- Wear protective clothing made from durable, flame-resistant material (leather and wool) and foot protection.

**Table 1. Eye Protection For Plasma Arc Cutting**

Current Level In Amperes	Minimum Shade Number	
Below 20		#4
20 - 40		#5
40 - 60		#6
60 - 80		#8

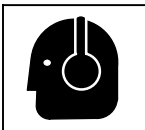

### NOISE can damage hearing.

Prolonged noise from some cutting applications can damage hearing if levels exceed limits specified by OSHA (see Safety Standards).

- Use approved ear plugs or ear muffs if noise level is high.
- Warn others nearby about noise hazard.



### FUMES AND GASES can be hazardous.

Cutting produces fumes and gases. Breathing these fumes and gases can be hazardous to your health.

- Keep your head out of the fumes. Do not breathe the fumes.

- If inside, ventilate the area and/or use exhaust at the arc to remove cutting fumes and gases.
- If ventilation is poor, use an approved air-supplied respirator.
- Read the Material Safety Data Sheets (MSDSs) and the manufacturer's instruction for metals to be cut, coatings, and cleaners.
- Work in a confined space only if it is well ventilated, or while wearing an air-supplied respirator. Fumes from cutting and oxygen depletion can alter air quality causing injury or death. Be sure the breathing air is safe.
- Do not cut in locations near degreasing, cleaning, or spraying operations. The heat and rays of the arc can react with vapors to form highly toxic and irritating gases.
- Do not cut on coated metals, such as galvanized, lead, or cadmium plated steel, unless the coating is removed from the cutting area, the area is well ventilated, and if necessary, while wearing an air-supplied respirator. The coatings and any metals containing these elements can give off toxic fumes when cut.
- Do not cut containers with toxic or reactive materials inside or containers that have held toxic or reactive materials – they must be emptied and properly cleaned first.

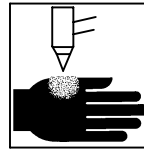

### PLASMA ARC can cause injury.

The heat from the plasma arc can cause serious burns. The force of the arc adds greatly to the burn hazard. The intensely hot and powerful arc can quickly cut through gloves and tissue.

- Keep away from the torch tip.
- Do not grip material near the cutting path.
- The pilot arc can cause burns – keep away from torch tip when trigger is pressed.
- Wear proper flame-retardant clothing covering all exposed body areas.
- Point torch away from your body and toward work when pressing the torch trigger – pilot arc comes on immediately.
- Turn off power source and disconnect input power before disassembling torch or changing torch parts.
- Use only torch(es) specified in the Owner's Manual.

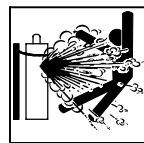

### CYLINDERS can explode if damaged.

Gas cylinders contain gas under high pressure. If damaged, a cylinder can explode. Since gas cylinders are normally part of metalworking processes, be sure to treat them carefully.

- Protect compressed gas cylinders from excessive heat, mechanical shocks, slag, open flame, sparks, and arcs.
- Install and secure cylinders in an upright position by chaining them to a stationary support or equipment cylinder rack to prevent falling or tipping.
- Keep cylinders away from any cutting or other electrical circuits.
- Never allow electrical contact between a plasma arc torch and a cylinder.
- Never cut on a pressurized cylinder – explosion will result.
- Use only correct gas cylinders, regulators, hoses, and fittings designed for the specific application; maintain them and associated parts in good condition.
- Turn face away from valve outlet when opening cylinder valve.
- Keep protective cap in place over valve except when cylinder is in use or connected for use.
- Read and follow instructions on compressed gas cylinders, associated equipment, and CGA publication P-1 listed in Safety Standards.

## 1-3. Additional Symbols For Installation, Operation, And Maintenance



### HOT PARTS can cause severe burns.

- Do not touch hot parts bare handed.
- Allow cooling period before working on torch.



### MOVING PARTS can cause injury.

- Keep away from moving parts such as fans.
- Keep all doors, panels, covers, and guards closed and securely in place.

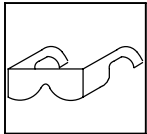

### FLYING METAL can injure eyes.

- Wear safety glasses with side shields or face shield.

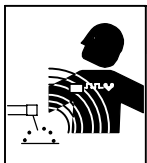

### MAGNETIC FIELDS can affect pacemakers.

- Pacemaker wearers keep away.
- Wearers should consult their doctor before going near plasma arc cutting operations.

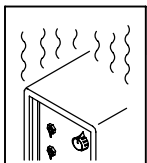

### OVERUSE can cause OVERHEATING.

- Allow cooling period; follow rated duty cycle.
- Reduce amperage (thickness) or reduce duty cycle before starting to cut again.



### EXPLODING HYDROGEN hazard.

- When cutting aluminum underwater or with the water touching the underside of the aluminum, free hydrogen gas may collect under the work-piece.

- See your cutting engineer and water table instructions for help.

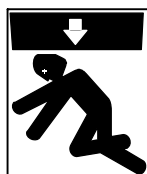

### FALLING UNIT can cause injury.

- Use lifting eye to lift unit only, NOT running gear, gas cylinders, or any other accessories.
- Use equipment of adequate capacity to lift unit.

- If using lift forks to move unit, be sure forks are long enough to extend beyond opposite side of unit.

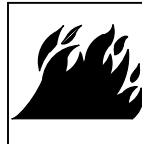

### FIRE OR EXPLOSION hazard.

- Do not locate unit on, over, or near combustible surfaces.
- Do not install unit near flammables.
- Do not overload building wiring – be sure power supply system is properly sized, rated, and protected to handle this unit.

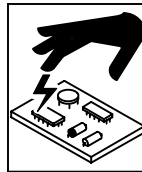

### STATIC (ESD) can damage PC boards.

- Put on grounded wrist strap BEFORE handling boards or parts.
- Use proper static-proof bags and boxes to store, move, or ship PC boards.

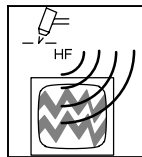

### H.F. RADIATION can cause interference.

- High frequency (H.F.) can interfere with radio navigation, safety services, computers, and communications equipment.
- Have only qualified persons familiar with electronic equipment perform this installation.
- The user is responsible for having a qualified electrician promptly correct any interference problem resulting from the installation.
- If notified by the FCC about interference, stop using the equipment at once.
- Have the installation regularly checked and maintained.
- Keep high-frequency source doors and panels tightly shut, keep spark gaps at correct setting, and use grounding and shielding to minimize the possibility of interference.

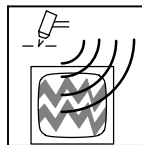

### ARC CUTTING can cause interference.

- Electromagnetic energy can interfere with sensitive electronic equipment such as computers and computer-driven equipment such as robots.
- To reduce possible interference, keep cables as short as possible, close together, and down low, such as on the floor.
- Locate cutting operation 100 meters from any sensitive electronic equipment.
- Be sure this cutting power source is installed and grounded according to this manual.
- If interference still occurs, the user must take extra measures such as moving the machine, using shielded cables, using line filters, or shielding the work area.

## 1-4. California Proposition 65 Warnings

- ▲ **Welding or cutting equipment produces fumes or gases which contain chemicals known to the State of California to cause birth defects and, in some cases, cancer. (California Health & Safety Code Section 25249.5 et seq.)**
- ▲ **Battery posts, terminals and related accessories contain lead and lead compounds, chemicals known to the State of California to cause cancer and birth defects or other reproductive harm. Wash hands after handling.**

### For Gasoline Engines:

- ▲ **Engine exhaust contains chemicals known to the State of California to cause cancer, birth defects, or other reproductive harm.**

### For Diesel Engines:

- ▲ **Diesel engine exhaust and some of its constituents are known to the State of California to cause cancer, birth defects, and other reproductive harm.**

## 1-5. Principal Safety Standards

*Safety in Welding and Cutting*, ANSI Standard Z49.1, from American Welding Society, 550 N.W. LeJeune Rd, Miami FL 33126

*Safety and Health Standards*, OSHA 29 CFR 1910, from Superintendent of Documents, U.S. Government Printing Office, Washington, D.C. 20402.

*Recommended Practices for Plasma Arc Cutting*, American Welding Society Standard AWS C5.2, from American Welding Society, 550 N.W. LeJeune Rd, Miami, FL 33126

*Recommended Safe Practices for the Preparation for Welding and Cutting of Containers That Have Held Hazardous Substances*, American Welding Society Standard AWS F4.1, from American Welding Society, 550 N.W. LeJeune Rd, Miami, FL 33126

*National Electrical Code*, NFPA Standard 70, from National Fire Protection Association, Batterymarch Park, Quincy, MA 02269.

*Safe Handling of Compressed Gases in Cylinders*, CGA Pamphlet P-1, from Compressed Gas Association, 1235 Jefferson Davis Highway, Suite 501, Arlington, VA 22202.

*Code for Safety in Welding and Cutting*, CSA Standard W117.2, from Canadian Standards Association, Standards Sales, 178 Rexdale Boulevard, Rexdale, Ontario, Canada M9W 1R3.

*Safe Practices For Occupation And Educational Eye And Face Protection*, ANSI Standard Z87.1, from American National Standards Institute, 1430 Broadway, New York, NY 10018.

*Cutting And Welding Processes*, NFPA Standard 51B, from National Fire Protection Association, Batterymarch Park, Quincy, MA 02269.

## 1-6. EMF Information

Considerations About Welding Or Cutting And The Effects Of Low Frequency Electric And Magnetic Fields

Welding or cutting current, as it flows through the welding or cutting cables, will cause electromagnetic fields. There has been and still is some concern about such fields. However, after examining more than 500 studies spanning 17 years of research, a special blue ribbon committee of the National Research Council concluded that: "The body of evidence, in the committee's judgment, has not demonstrated that exposure to power-frequency electric and magnetic fields is a human-health hazard." However, studies are still going forth and evidence continues to be examined. Until the final conclusions of the research are reached, you may wish to minimize your exposure to electromagnetic fields when welding or cutting.

To reduce magnetic fields in the workplace, use the following procedures:

1. Keep cables close together by twisting or taping them.
2. Arrange cables to one side and away from the operator.
3. Do not coil or drape cables around your body.
4. Keep cutting power source and cables as far away from operator as practical.
5. Connect work clamp to workpiece as close to the cut as possible.

### **About Pacemakers:**

Pacemaker wearers consult your doctor first. If cleared by your doctor, then following the above procedures is recommended.



## 2-1. Signification des symboles



Signifie Mise en garde ! Soyez vigilant ! Cette procédure présente des risques de danger ! Ceux-ci sont identifiés par des symboles adjacents aux directives.

▲ **Identifie un message de sécurité particulier.**

☞ Signifie NOTA ; n'est pas relatif à la sécurité.



Ce groupe de symboles signifie Mise en garde ! Soyez vigilant ! Il y a des risques de danger reliés aux CHOCS ÉLECTRIQUES, aux PIÈCES EN MOUVEMENT et aux PIÈCES CHAUDES. Reportez-vous aux symboles et aux directives ci-dessous afin de connaître les mesures à prendre pour éviter tout danger.

## 2-2. Dangers liés au coupage à l'arc au plasma

▲ **Les symboles présentés ci-après sont utilisés tout au long du présent manuel pour attirer votre attention et identifier les risques de danger. Lorsque vous voyez un symbole, soyez vigilant et suivez les directives mentionnées afin d'éviter tout danger. Les consignes de sécurité présentées ci-après ne font que résumer l'information contenue dans les normes de sécurité énumérées à la section 2-4. Veuillez lire et respecter toutes ces normes de sécurité.**

▲ **L'installation, l'utilisation, l'entretien et les réparations ne doivent être confiés qu'à des personnes qualifiées.**

▲ **Au cours de l'utilisation, tenir toute personne à l'écart et plus particulièrement les enfants.**

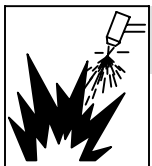

**LE COUPAGE présente un risque de feu ou d'explosion.**

Des particules de métal chaud et des étincelles peuvent jaillir de la pièce au moment du coupage. Les étincelles et le métal chaud, la pièce à couper chauffée et l'équipement chaud peuvent causer un feu ou des brûlures. Avant de commencer à travailler, assurez-vous que l'endroit est sécuritaire.

- Protégez-vous, ainsi que toute autre personne travaillant sur les lieux, contre les étincelles et le métal chaud.
- Ne coupez pas dans un endroit où des étincelles pourraient atteindre des matières inflammables.
- Déplacez toute matière inflammable se trouvant à l'intérieur d'un périmètre de 10,7 m (35 pi) de la pièce à couper. Si cela est impossible, vous devez les couvrir avec des housses approuvées et bien ajustées.
- Assurez-vous qu'aucune étincelle ni particule de métal ne peut se glisser dans de petites fissures ou tomber dans d'autres pièces.
- Afin d'éliminer tout risque de feu, soyez vigilant et gardez toujours un extincteur à la portée de la main.
- Si vous coupez sur un plafond, un plancher ou une cloison, soyez conscient que cela peut entraîner un feu de l'autre côté.
- Ne coupez pas sur un contenant fermé tel qu'un réservoir ou un bidon.
- Fixez le câble de masse sur la pièce à couper, le plus près possible de la zone à couper afin de prévenir que le courant de coupage ne prenne une trajectoire inconnue ou longue et ne cause ainsi une décharge électrique ou un feu.
- Ne coupez jamais des contenants qui peuvent contenir des matières inflammables. Vous devez en premier lieu les vider et les nettoyer convenablement.
- Ne coupez pas dans un endroit où l'atmosphère risque de contenir de la poussière ou des vapeurs explosives.
- Ne coupez pas de bouteilles, de tuyaux ou de contenants pressurisés.
- Ne coupez pas de contenants qui ont déjà reçu des combustibles.
- Portez des vêtements de protection exempts d'huile tels que des gants en cuir, une veste résistante, des pantalons sans revers, des bottes et un casque.
- Ne placez pas le poste sur une surface combustible ou au-dessus de celle-ci.
- Avant le coupage, retirez tout combustible de vos poches, par exemple un briquet au butane ou des allumettes.



**UNE DÉCHARGE ÉLECTRIQUE peut entraîner la mort.**

Le fait de toucher à une pièce électrique sous tension peut donner une décharge fatale ou entraîner des brûlures graves. Le chalumeau et le circuit de masse sont automatiquement actifs lorsque le poste est sous tension. L'alimentation d'entrée et les circuits internes de l'appareil le sont également. Le coupage au plasma d'arc exige des tensions plus élevées que le soudage pour amorcer et maintenir l'arc (souvent de 200 à 400 V CC), c'est pourquoi on fait appel à des chalumeaux conçus avec un système de verrouillage sécuritaire qui met l'appareil hors tension lorsque la capsule anti-feu est desserrée ou si le tube touche l'électrode à l'intérieur de la buse. Un poste incorrectement installé ou inadéquatement mis à la terre constitue un danger.

- Ne touchez pas aux pièces électriques sous tension.
- Portez des gants isolants et des vêtements de protection secs et sans trous.
- Isolez-vous de la pièce à couper et du sol en utilisant des housses ou des tapis assez grands afin d'éviter tout contact physique avec la pièce à couper ou le sol.
- Ne touchez pas aux pièces du chalumeau si vous êtes en contact avec la pièce à couper ou le sol.
- Mettez l'appareil hors tension avant d'effectuer la vérification, le nettoyage ou le changement d'une pièce du chalumeau.
- Coupez l'alimentation d'entrée avant d'installer l'appareil ou d'effectuer l'entretien. Verrouillez ou étiquetez la sortie d'alimentation selon la norme OSHA 29 CFR 1910.147 (reportez-vous aux Principales normes de sécurité).
- Installez le poste correctement et mettez-le à la terre convenablement selon les consignes du manuel de l'opérateur et les normes nationales, provinciales et locales.
- Assurez-vous que le fil de terre du cordon d'alimentation est correctement relié à la borne de terre dans la boîte de coupure ou que la fiche du cordon est branchée à une prise correctement mise à la terre – vous devez toujours vérifier la mise à la terre.
- Avant d'effectuer les connexions d'alimentation, vous devez relier le bon fil de terre.
- Vérifiez fréquemment le cordon d'alimentation afin de vous assurer qu'il n'est pas altéré ou à nu, remplacez-le immédiatement s'il l'est. Un fil à nu peut entraîner la mort.
- L'équipement doit être hors tension lorsqu'il n'est pas utilisé.
- Vérifiez et remplacez les cosse du câble du chalumeau si elles sont usées ou altérées.
- Le câble du chalumeau ne doit pas s'enrouler autour de votre corps.
- Si les normes le stipulent, la pièce à couper doit être mise à la terre.
- Utilisez uniquement de l'équipement en bonne condition. Réparez ou remplacez immédiatement toute pièce altérée.
- Portez un harnais de sécurité si vous devez travailler au-dessus du sol.
- Assurez-vous que tous les panneaux et couvercles sont correctement en place.
- N'essayez pas d'aller à l'encontre des systèmes de verrouillage de sécurité ou de les contourner.
- Utilisez uniquement le ou les chalumeaux recommandés dans le manuel de l'opérateur.
- N'approchez pas le tube du chalumeau et l'arc pilote lorsque la gâchette est enfoncée.
- Le câble de masse doit être pincé correctement sur la pièce à couper, métal contre métal (et non de telle sorte qu'il puisse se détacher), ou sur la table de travail le plus près possible de la ligne de coupage.

- Isoler la pince de masse quand pas mis à la pièce pour éviter le contact avec tout objet métallique.

## Il y a DU COURANT CONTINU IMPORTANT dans les convertisseurs après la suppression de l'alimentation électrique.

- Arrêter les convertisseurs, débrancher le courant électrique, et décharger les condensateurs d'alimentation selon les instructions indiquées dans la partie entretien avant de toucher les pièces.



### DÉCHARGES ÉLECTRIQUES potentiellement mortelles.

Les pièces internes des sources d'alimentation de l'inverseur ont DES CHARGES C.C. SIGNIFICATIVES même APRÈS coupure du courant d'alimentation.

- Mettre l'unité hors tension, mesurer la tension des condensateurs d'entrée et s'assurer qu'elle est pratiquement nulle avant de toucher à l'une quelconque des pièces. Mesurer cette tension conformément aux directives énoncées à la section Entretien du manuel de l'utilisateur ou du manuel technique avant de toucher à l'une quelconque des pièces.

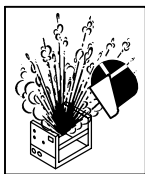

### Risque de blessure en cas D'EXPLOSION DES PIÈCES.

- Mise sous tension, toute pièce défectueuse des sources d'alimentation de l'inverseur peut exploser ou faire exploser d'autres pièces. Pour entretenir les inverseurs, toujours porter un masque protecteur et un vêtement à manches longues.

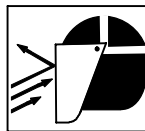

### LES ÉTINCELLES VOLANTES risquent de provoquer des blessures.

Le coupage plasma produit des étincelles et projections de métal à très haute température. Lorsque la pièce refroidit, du laitier peut se former.

- Portez une visière ou des lunettes de sécurité avec des écrans latéraux approuvés.
- Portez des vêtements de protection adéquats afin de protéger votre peau.
- Ayez recours à des protège-tympons ou à un serre-tête ignifuges afin d'éviter que les étincelles n'entrent dans vos oreilles.

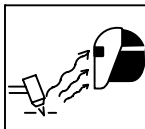

### LES RAYONS D'ARC peuvent entraîner des brûlures aux yeux et à la peau.

Les rayons d'arc provenant du procédé de coupage produisent des rayons visibles et invisibles intenses (ultraviolets et infrarouges) qui peuvent entraîner des brûlures aux yeux et à la peau.

- Lorsque vous coupez ou regardez quelqu'un couper, portez un masque ou un écran facial avec le filtre approprié. La norme ANSI Z49.1 (reportez-vous aux Principales normes de sécurité) suggère d'utiliser un filtre de teinte n° 9 (n° 8 étant le minimum) pour tout travail de coupage faisant appel à un courant de moins de 300 A. On mentionne également dans la norme Z49.1 qu'un filtre plus faible peut être utilisé lorsque l'arc est caché par la pièce à couper. Comme cela est habituellement le cas pour les travaux de coupage à faible courant, les teintes énumérées au tableau 1 sont fournies à titre d'information pour l'opérateur.
- Porter des lunettes de sécurité à coques latérales sous votre casque ou écran facial.
- Ayez recours à des écrans protecteurs ou à des rideaux pour protéger les autres contre les rayonnements et les éblouissements; prévenez toute personne sur les lieux de ne pas regarder l'arc.
- Portez des vêtements confectionnés avec des matières résistantes et ignifuges (cuir et laine) et des bottes de protection.

Tableau 1. Protection des yeux pour le coupage au plasma d'arc

Intensité de courant en ampères	Filtre de teinte (minimum)	
Moins de 20		no. 4
20 - 40		no. 5
40 - 60		no. 6
60 - 80		no. 8

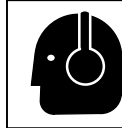

### LE BRUIT peut endommager l'ouïe.

Certaines applications de coupage produisent un bruit constant, ce qui peut endommager l'ouïe si le niveau sonore dépasse les limites permises par l'OSHA (reportez-vous aux Principales normes de sécurité).

- Utilisez des protège-tympons ou un serre-tête antibruit si le niveau sonore est élevé.
- Prévenez toute personne sur les lieux du danger relié au bruit.



### LES FUMÉES ET LES GAZ peuvent être dangereux.

Le coupage produit des vapeurs et des gaz. Respirer ces vapeurs et ces gaz peut être dangereux pour la santé.

- Ne mettez pas votre tête au-dessus des vapeurs. Ne respirez pas ces vapeurs.
- Si vous êtes à l'intérieur au moment du coupage, ventilez la pièce ou ayez recours à une ventilation aspirante installée près de l'arc pour évacuer les vapeurs et les gaz.
- Si la ventilation est médiocre, utilisez un respirateur anti-vapeurs approuvé.
- Veuillez lire le Material Safety Data Sheets (MSDS) et les instructions du fabricant pour obtenir plus de renseignements sur les métaux à couper, les enrobages et les nettoyants.
- Travaillez dans un espace restreint uniquement s'il est bien ventilé ou si vous portez un respirateur anti-vapeurs. Les vapeurs causées par le coupage et l'épuisement de l'oxygène peuvent altérer la qualité de l'air et entraîner des blessures ou la mort. Assurez-vous que l'air ambiant est sain pour la santé.
- Ne coupez pas dans un endroit près d'opérations de décapage, de nettoyage ou de vaporisation. La chaleur et les rayons d'arc peuvent réagir avec les vapeurs et former des gaz hautement toxiques et irritants.
- Ne coupez pas des métaux enrobés tels que des métaux galvanisés, contenant du plomb ou de l'acier plaqué au cadmium, à moins que l'enrobage ne soit ôté de la surface du métal à couper, que l'endroit où vous travaillez ne soit bien ventilé, ou, si nécessaire, que vous ne portiez un respirateur anti-vapeurs. Les enrobages ou tous métaux qui contiennent ces éléments peuvent créer des vapeurs toxiques s'ils sont coupés.
- Ne coupez pas de contenants qui renferment ou ont renfermés des matières toxiques ou réactives – vous devez en premier lieu les vider et les nettoyer convenablement.

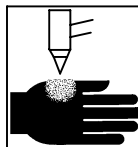

### LE PLASMA D'ARC peut entraîner des blessures.

La chaleur dégagée par le plasma d'arc peut entraîner de sérieuses brûlures. La force de l'arc est un facteur qui s'ajoute au danger de brûlures. La chaleur intense et la puissance de l'arc peuvent rapidement passer au travers de gants et de tissus.

- N'approchez pas le tube du chalumeau.
- Ne saisissez pas la pièce à couper près de la ligne de coupage.
- L'arc pilote peut causer des brûlures – n'approchez pas le tube du chalumeau lorsque vous avez appuyé sur le gâchette.
- Portez des vêtements de protection adéquats qui recouvrent tout votre corps.
- Ne pointez pas le chalumeau en direction de votre corps ni de la pièce à couper lorsque vous appuyez sur la gâchette – l'arc pilote s'allume automatiquement.
- Mettez l'alimentation hors tension et débranchez le cordon d'alimentation avant de démonter le chalumeau ou de changer une pièce du chalumeau.
- Utilisez uniquement le ou les chalumeaux recommandés dans le manuel de l'opérateur.

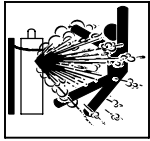

### LES BOUTEILLES peuvent exploser si elles sont endommagées.

Les bouteilles de gaz contiennent du gaz sous haute pression. Si une bouteille est endommagée, elle peut exploser. Puisque les bouteilles de gaz sont habituellement partie d'un processus de travail des métaux, assurez-vous de les manipuler correctement.

- Protégez les bouteilles de gaz comprimé contre la chaleur excessive, les chocs mécaniques, le laitier, la flamme, les étincelles et l'arc.
- Installez et attachez les bouteilles dans la position verticale à l'aide d'une chaîne, sur un support stationnaire ou un châssis porte-bouteille afin de prévenir qu'elles ne tombent ou ne basculent.
- Les bouteilles ne doivent pas être près de la zone de coupage ni de tout autre circuit électrique.

## 2-3. Dangers supplémentaires en relation avec l'installation, le fonctionnement et la maintenance



### DES PIÈCES CHAUDES peuvent provoquer des brûlures graves.

- Ne pas toucher des parties chaudes à mains nues.
- Laisser refroidir avant d'intervenir sur la torche.



### DES ORGANES MOBILES peuvent provoquer des blessures.

- S'abstenir de toucher des organes mobiles tels que des ventilateurs.
- Maintenir fermés et verrouillés les portes, panneaux, recouvrements et dispositifs de protection.

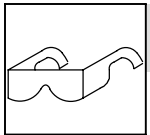

### DES PARTICULES VOLANTES peuvent blesser les yeux.

- Porter des lunettes de sécurité avec protections latérales ou frontales.

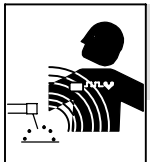

### LES CHAMPS MAGNÉTIQUES peuvent affecter les stimulateurs cardiaques.

- Porteurs de stimulateur cardiaque, restez à distance.
- Les porteurs sont priés de consulter leur médecin avant d'approcher les opérations de coupage plasma.

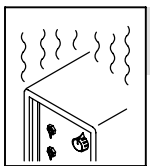

### L'EMPLOI EXCESSIF peut SURCHAUFFER L'ÉQUIPEMENT.

- Prévoir une période de refroidissement; respecter le cycle opératoire nominal.
- Réduire l'ampérage (épaisseur) avant de continuer à couper ou réduire le facteur de marche.



### Danger D'EXPLOSION D'HYDROGÈNE.

- Lors du coupage d'aluminium partiellement ou totalement immergé dans l'eau, de l'hydrogène libre peut s'accumuler sous la pièce.
- Consultez votre ingénieur de coupage et les instructions de la table de coupage.



### LA CHUTE DE L'APPAREIL peut blesser.

- Utiliser l'anneau de levage uniquement pour soulever l'appareil, NON PAS les chariot, les bouteilles de gaz ou tout autre accessoire.
- Utiliser un engin d'une capacité appropriée pour soulever l'appareil.
- En utilisant des fourches de levage pour déplacer l'unité, s'assurer que les fourches sont suffisamment longues pour dépasser du côté opposé de l'appareil.

- Un contact électrique ne doit jamais se produire entre un chalumeau de plasma d'arc et une bouteille.
- Ne coupez jamais sur une bouteille pressurisée – une explosion en résulterait.
- Utilisez uniquement des bouteilles de gaz, des détendeurs, des boyaux et des raccords conçus pour l'application déterminée. Gardez-les, ainsi que toute autre pièce associée, en bonne condition.
- Détournez votre visage du détendeur-régulateur lorsque vous ouvrez la soupape de la bouteille.
- Le couvercle du détendeur doit toujours être en place, sauf lorsque vous utilisez la bouteille ou qu'elle est reliée pour usage ultérieur.
- Lisez et suivez les instructions sur les bouteilles de gaz comprimé, l'équipement connexe et le dépliant P-1 de la CGA mentionné dans les Principales normes de sécurité.



### Risque D'INCENDIE OU D'EXPLOSION.

- Ne pas placer l'appareil sur, au-dessus ou à proximité de surfaces inflammables.
- Ne pas installer l'appareil à proximité de produits inflammables.
- Ne pas surcharger l'installation électrique – s'assurer que l'alimentation est correctement dimensionnée et protégée avant de mettre l'appareil en service.

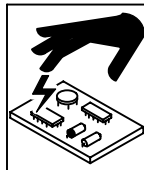

### LES CHARGES ÉLECTROSTATIQUES peuvent endommager les circuits imprimés.

- Etablir la connexion avec la barrette de terre avant de manipuler des cartes ou des pièces.
- Utiliser des pochettes et des boîtes antistatiques pour stocker, déplacer ou expédier des cartes PC.

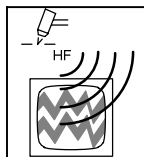

### LE RAYONNEMENT HAUTE FRÉQUENCE (H.F.) risque de provoquer des interférences.

- Le Rayonnement haute fréquence (H.F.) peut provoquer des interférences avec les équipements de radio-navigation et de communication, les services de sécurité et les ordinateurs.
- Demander seulement à des personnes qualifiées familiarisées avec des équipements électroniques de faire fonctionner l'installation.
- L'utilisateur est tenu de faire corriger rapidement par un électricien qualifié les interférences résultant de l'installation.
- Si le FCC signale des interférences, arrêter immédiatement l'appareil.
- Effectuer régulièrement le contrôle et l'entretien de l'installation.
- Maintenir soigneusement fermés les portes et les panneaux des sources de haute fréquence, maintenir les éclateurs à une distance correcte et utiliser une terre et un blindage pour réduire les interférences éventuelles.

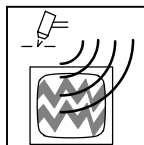

### LE COUPAGE À L'ARC peut causer des interférences.

- L'énergie électromagnétique peut gêner le fonctionnement d'appareils électroniques comme des ordinateurs et des robots.
- Pour réduire la possibilité d'interférence, maintenir les câbles aussi courts que possible, les grouper, et les poser aussi bas que possible (ex. par terre).
- Veiller à couper à une distance de 100 mètres de tout équipement électronique sensible.
- S'assurer que la source de coupage est correctement branchée et mise à la terre.
- Si l'interférence persiste, l'utilisateur doit prendre des mesures supplémentaires comme écarter la machine, utiliser des câbles blindés de des filtres, ou boucler la zone de travail.

## 2-4. Principales normes de sécurité

*Safety in Welding and Cutting*, norme ANSI Z49.1, de l'American Welding Society, 550 N.W. Lejeune Rd, Miami FL 33126

*Safety and Health Standards*, OSHA 29 CFR 1910, du Superintendent of Documents, U.S. Government Printing Office, Washington, D.C. 20402.

*Recommended Safe Practice for the Preparation for Welding and Cutting of Containers That Have Held Hazardous Substances*, norme AWS F4.1, de l'American Welding Society, 550 N.W. Lejeune Rd, Miami FL 33126

*National Electrical Code*, NFPA Standard 70, de la National Fire Protection Association, Batterymarch Park, Quincy, MA 02269.

*Safe Handling of Compressed Gases in Cylinders*, CGA Pamphlet P-1, de la Compressed Gas Association, 1235 Jefferson Davis Highway, Suite 501, Arlington, VA 22202.

*Règles de sécurité en soudage, coupage et procédés connexes*, norme CSA W117.2, de l'Association canadienne de normalisation, vente de normes, 178 Rexdale Boulevard, Rexdale (Ontario) Canada M9W 1R3.

*Safe Practices For Occupation And Educational Eye And Face Protection*, norme ANSI Z87.1, de l'American National Standards Institute, 1430 Broadway, New York, NY 10018.

*Cutting and Welding Processes*, norme NFPA 51B, de la National Fire Protection Association, Batterymarch Park, Quincy, MA 02269.

## 2-5. Information sur les champs électromagnétiques

Données sur le soudage électrique et sur les effets, pour l'organisme, des champs magnétiques basse fréquence

Le courant de soudage ou de coupage passant dans les câbles de puissance crée des champs électromagnétiques. Il y a eu et il y a encore un certain souci à propos de tels champs. Cependant, après avoir examiné plus de 500 études qui ont été faites pendant une période de recherche de 17 ans, un comité spécial ruban bleu du National Research Council a conclu: "L'accumulation de preuves, suivant le jugement du comité, n'a pas démontré que l'exposition aux champs magnétiques et champs électriques à haute fréquence représente un risque à la santé humaine". Toutefois, des études sont toujours en cours et les preuves continuent à être examinées. En attendant que les conclusions finales de la recherche soient établies, il vous serait souhaitable de réduire votre exposition aux champs électromagnétiques pendant le soudage ou le coupage.

Afin de réduire les champs électromagnétiques dans l'environnement de travail, respecter les consignes suivantes :











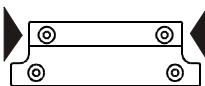
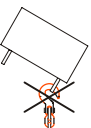
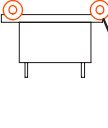
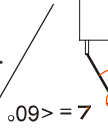



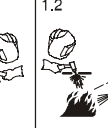

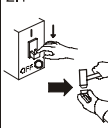
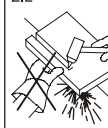







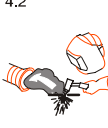

- 1 Garder les câbles ensemble en les torsadant ou en les attachant avec du ruban adhésif.
- 2 Mettre tous les câbles du côté opposé de l'opérateur.
- 3 Ne pas courber pas et ne pas entourer pas les câbles autour de vous.
- 4 Garder le poste de soudage et les câbles le plus loin possible de vous.
- 5 Relier la pince de masse le plus près possible de la zone de soudure.

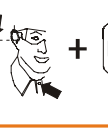
### Consignes relatives aux stimulateurs cardiaques :

Les consignes mentionnées précédemment font partie de celles destinées aux personnes ayant recours à un stimulateur cardiaque. Veuillez consulter votre médecin pour obtenir plus de détails.

# SECTION 3 – DEFINITIONS

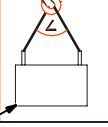
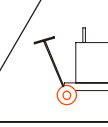
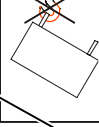
## 3-1. Warning Label Definitions

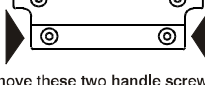
<p>IMPORTANT: Remove these two handle screws when opening case.</p> 			
			
			
1 	1.1 	1.2 	1.3 
2 	2.1 	2.2 	2.3 
3 	3.1 	3.2 	3.3 
4 	4.1 	4.2 	4.3 
5 	5.1 	5.2 	5.3 
6 	6.1 	6.2 	6.3 
7 	8 	9 	10 
11 	<p>IMPORTANT: Remove these two handle screws when opening case.</p> 		

199 065

Warning! Watch Out! There are possible hazards as shown by the symbols.

- 1 Cutting sparks can cause explosion or fire.
  - 1.1 Keep flammables away from cutting. Do not cut near flammables.
  - 1.2 Cutting sparks can cause fires. Have a fire extinguisher nearby, and have a watchperson ready to use it.
  - 1.3 Do not cut on drums or any closed containers.
- 2 The plasma arc can cause injury and burns.
  - 2.1 Turn off power before disassembling torch.
  - 2.2 Do not grip material near cutting path.
  - 2.3 Wear complete body protection.
- 3 Electric shock from torch or wiring can kill.
  - 3.1 Wear dry insulating gloves. Do not wear wet or damaged gloves.
  - 3.2 Protect yourself from electric shock by insulating yourself from work and ground.
  - 3.3 Disconnect input plug or power before working on machine.
- 4 Breathing cutting fumes can be hazardous to your health.
  - 4.1 Keep your head out of the fumes.
  - 4.2 Use forced ventilation or local exhaust to remove the fumes.
  - 4.3 Use ventilating fan to remove fumes.
- 5 Arc rays can burn eyes and injure skin.
  - 5.1 Wear hat and safety glasses. Use ear protection and button shirt collar. Use welding helmet with correct shade of filter. Wear complete body protection.
- 6 Become trained and read the instructions before working on the machine or cutting.
- 7 Do not remove or paint over (cover) the label.
- 8 Falling equipment can cause injury and damage to unit.
- 9 Always lift and support unit using both handles. Keep angle of lifting device less than 60 degrees.
- 10 Use a proper cart to move unit.
- 11 Do not use one handle to lift or support unit.

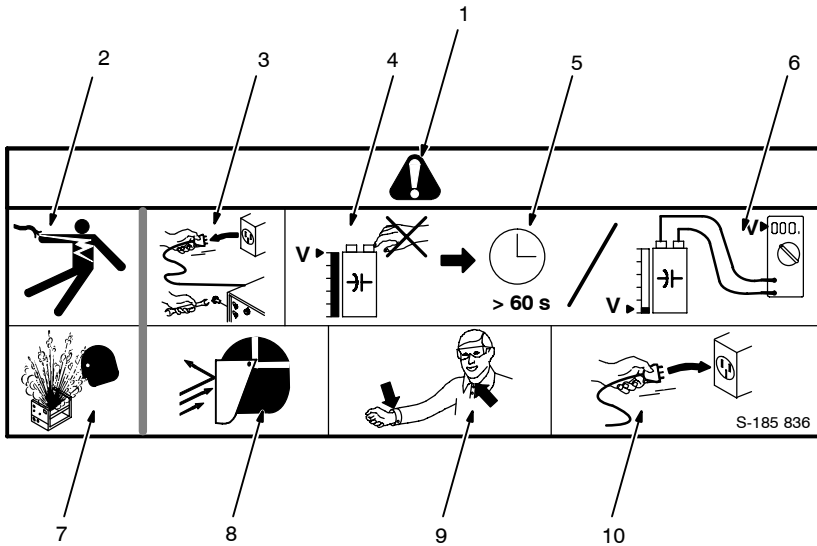





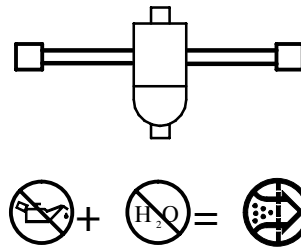

- 1 Warning! Watch Out! There are possible hazards as shown by the symbols.
- 2 Electric shock from wiring can kill.
- 3 Disconnect input plug or power before working on machine.
- 4 Hazardous voltage remains on input capacitors after power is turned off. Do not touch fully charged capacitors.
- 5 Always wait 60 seconds after power is turned off before working on unit, OR
- 6 Check input capacitor voltage, and be sure it is near 0 before touching any parts.
- 7 When power is applied failed parts can explode or cause other parts to explode.
- 8 Flying pieces of parts can cause injury. Always wear a face shield when servicing unit.
- 9 Always wear long sleeves and button your collar when servicing unit.
- 10 After taking proper precautions as shown, connect power to unit.

### 3-2. Air Supply Precaution



**Use Only Oil Free  
Dry Compressed Air**

















### 3-3. Manufacturer's Rating Label For CE Products

		EN 50192		EN 50199	
		30A/92V		80A/112V	
		X		60%	
	U <sub>0</sub> = 310V	I <sub>2</sub>		80A	
		U <sub>2</sub>		112V	
 3~ 50/60 Hz	IP23 	U <sub>1</sub> = 380V	I <sub>1max</sub> = 21.6A	I <sub>1eff</sub> = 16.7A	
		U <sub>1</sub> = 440V	I <sub>1max</sub> = 19.3A	I <sub>1eff</sub> = 14.9A	

194331

### 3-4. Symbols And Definitions

**NOTE**  Some symbols are found only on CE products.



<b>A</b>	Amperes		Plasma Arc Cutting (PAC)		Adjust Air/Gas Pressure		Air Pressure
<b>V</b>	Volts		Increase		No - Do Not Do This		Temperature
	Protective Earth (Ground)	3~	Three Phase		Constant Current		Voltage Input
<b>I</b>	On		Off	%	Percent		Direct Current
<b>U<sub>0</sub></b>	Rated No Load Voltage (Average)	<b>U<sub>1</sub></b>	Primary Voltage	<b>U<sub>2</sub></b>	Conventional Load Voltage		Line Connection
	Suitable for Some Hazardous Locations	<b>I<sub>2</sub></b>	Rated Cutting Current	<b>X</b>	Duty Cycle		Three Phase Transformer Rectifier
<b>IP</b>	Degree Of Protection		Loose Shield Cup	<b>Hz</b>	Hertz	<b>I<sub>1max</sub></b>	Rated Maximum Supply Current
<b>I<sub>1eff</sub></b>	Maximum Effective Supply Current		Trigger Hold On		Trigger Hold Off		

# SECTION 4 – INSTALLATION

## 4-1. Specifications

Model/Rated Output	Input		KVA	KW	Rated Cutting Capacity	Type of Output	Plasma Gas	Maximum Open-Circuit Voltage DC
	Volts @ 50/60 Hz, 3 Phase	Amperes @ Rated Cutting Capacity						
UPC 838 80 A @ 112 Volts DC, 60% Duty Cycle	380	21.6	14.21	13.50	7/8 in (22 mm) At 10 IPM	Direct Current, Straight Polarity (DCEN)	Air Or Nitrogen Only	350
	440	19.3	14.71	13.9	7/8 in (22 mm) At 10 IPM			

## 4-2. Duty Cycle And Overheating

**Three-Phase Input Power:  
60% Duty Cycle**



6 Minutes Cutting



→



4 Minutes Resting



Duty Cycle is percentage of 10 minutes that unit can cut at rated load without overheating.

If unit overheats, thermostat(s) opens, output stops, and cooling fan runs. Wait fifteen minutes for unit to cool. Reduce amperage or duty cycle before cutting.

**▲ Exceeding duty cycle can damage unit and void warranty.**

---

**Overheating**





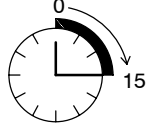

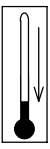

Minutes



OR



Reduce Duty Cycle



duty1 4/95



### 4-3. Cutting Speed

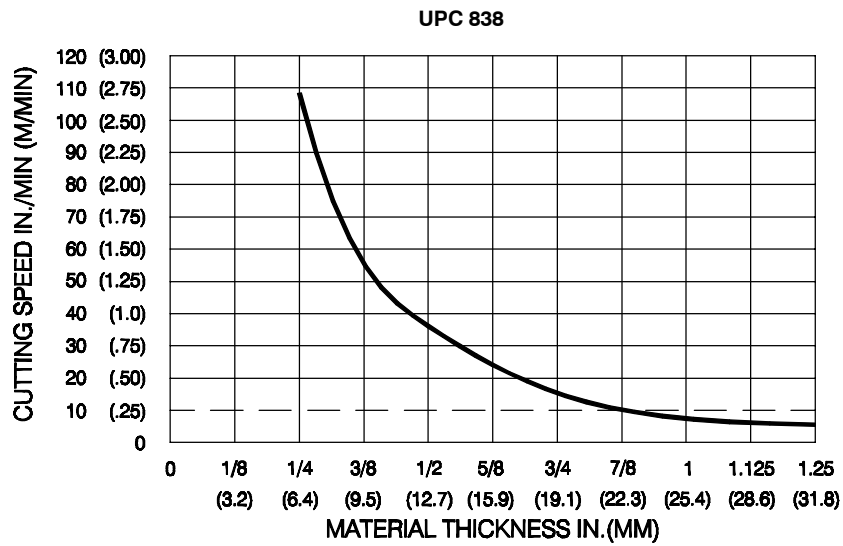

The cutting speed curve shows the recommended maximum cutting speed capabilities of the power source and torch for mild steel of various thickness.

▲ Exceeding recommended cutting speeds will cause rapid erosion of the tip and electrode.

 Cutting speed is approximately 10 inches per minute at 0.88 in (22 mm) mild steel thickness at max setting/tip saver mode.

## 4-4. Selecting a Location



### Dimensions And Weight

74 lb (34.6 kg)

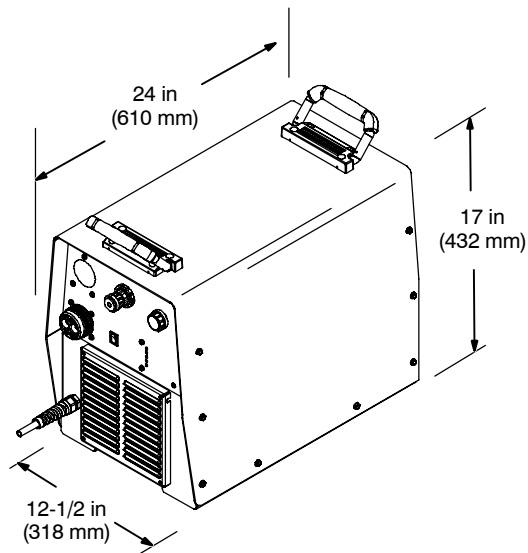

### Movement

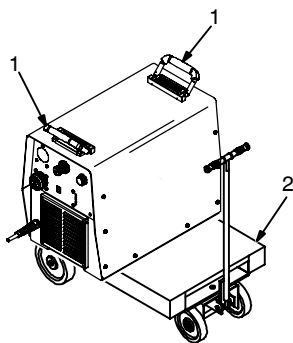

▲ Do not move or operate unit where it could tip.

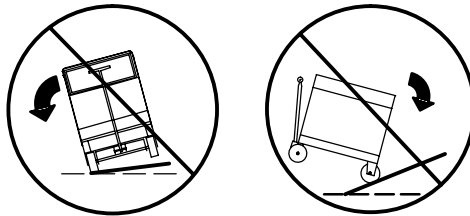

1 Lifting Handles

Use handles to lift unit.

2 Hand Cart

Use cart or similar device to move unit.

3 Rating Label

Use rating label to determine input power needs.

4 Line Disconnect Device

Locate unit near correct input power supply.

▲ Special installation may be required where gasoline or volatile liquids are present – see NEC Article 511 or CEC Section 20.

### Location

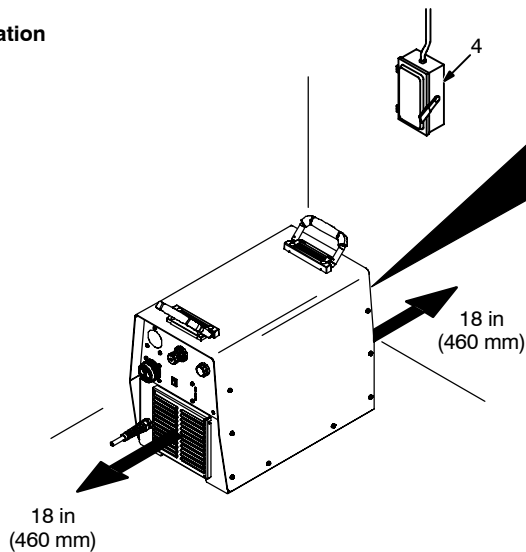

3~		EN 50192		EN 50199	
	U <sub>0</sub> = 310V				
	IP23				
3~ 50/60 Hz					

loc\_2 3/96 - 802 140 / Ref. 151 556

## 4-5. Connecting Work Clamp And Gas/Air Supply

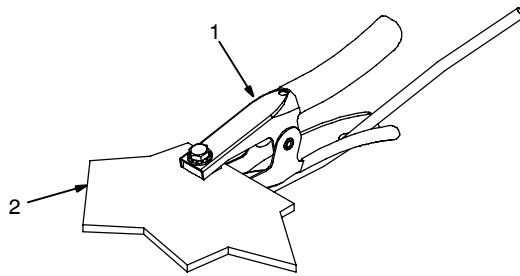

- 1 Work Clamp
- 2 Workpiece

Connect work clamp to a clean, paint-free location on workpiece, as close to cutting area as possible.

 Use only clean, dry air with 90 to 150 psi pressure.

- 3 Gas/Air Inlet Opening
- 4 Hose
- 5 Teflon Tape

Obtain hose with 3/8 in (9.5 mm) or larger diameter and 1/4 NPT right-hand thread fitting. Wrap threads with teflon tape (optional) or apply pipe sealant, and install fitting in opening. Route hose to gas/air supply.

Adjust gas/air pressure according to Section 5-2.

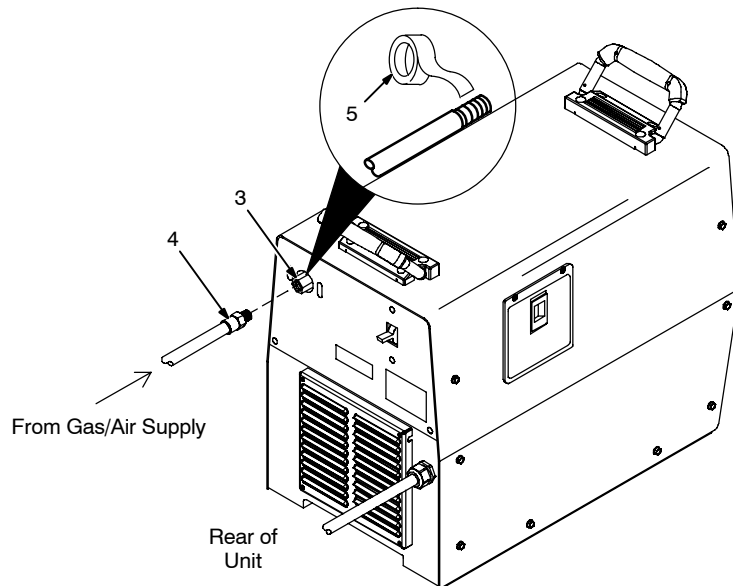

Tools Needed:



Ref. 803 640-A / 802 803-A

## 4-6. Electrical Service Guide

	UPC 838		
	380	440	
<b>Input Voltage</b>	380	440	
<b>Input Amperes At Rated Cutting Capacity</b>	21.6	19.3	
<b>Max Recommended Standard Fuse Rating In Amperes</b>	30	30	35
	35	35	
<b>Min Input/Grounding Conductor Size In mm<sup>2</sup></b>	4	6	10
<b>Max Recommended Input Conductor Length In Meters</b>	50	100	150

Reference: 1999 National Electrical Code (NEC)

1 Choose a circuit breaker with time-current curves comparable to a Time Delay Fuse.

2 "Time-Delay" fuses are UL class "RK5".

3 "Normal Operating" (general purpose – no intentional delay) fuses are UL class "K5" (up to and including 60 amp), and UL class "H" (65 amp and above).

## 4-7. Connecting Input Power



Check input voltage available at site.

- 1 Input And Grounding Conductors
- 2 Line Disconnect Device

See Section 4-6.

▲ **Always connect green wire to supply grounding terminal, never to a line terminal. Connect black, brown, and blue wires (L1, L2, L3) to line terminals.**

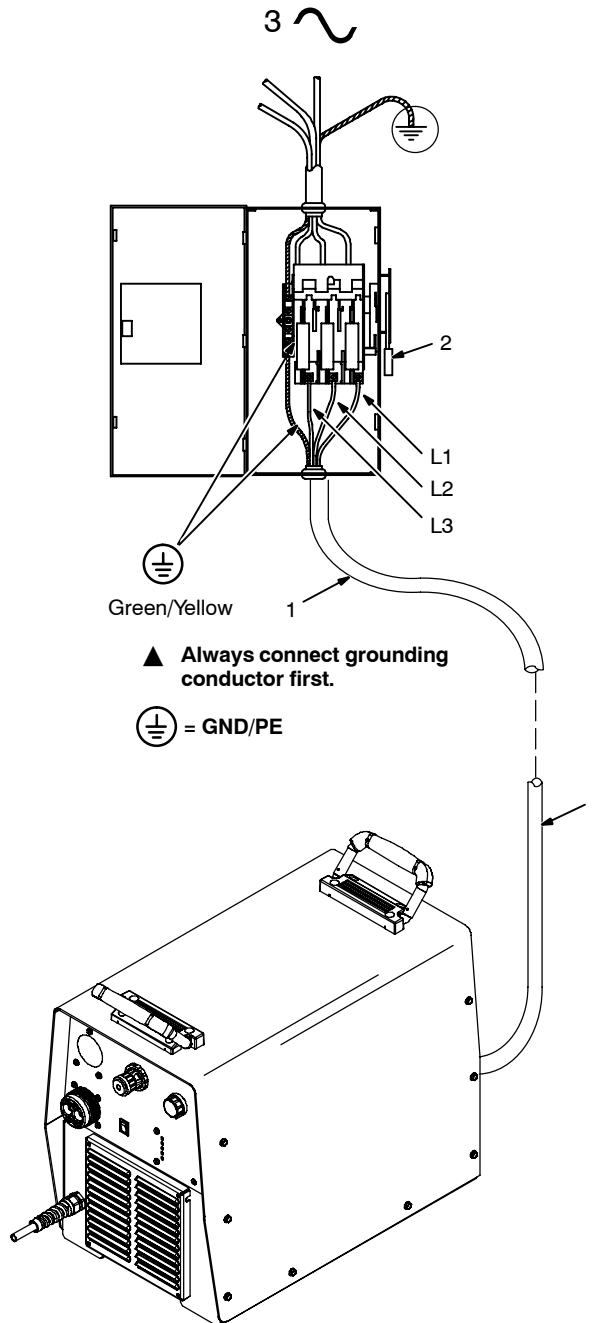

input\_2 3/96 - Ref. 144 221 / Ref. 070 399-C / 802 140

# SECTION 5 – OPERATION

## 5-1. Controls

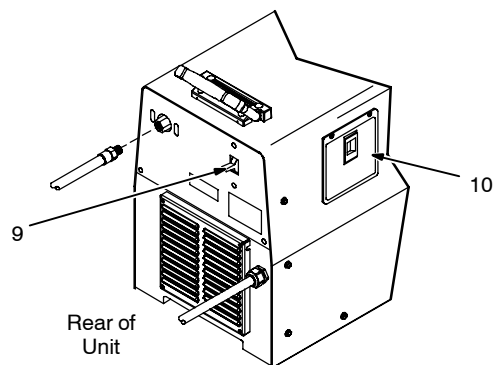
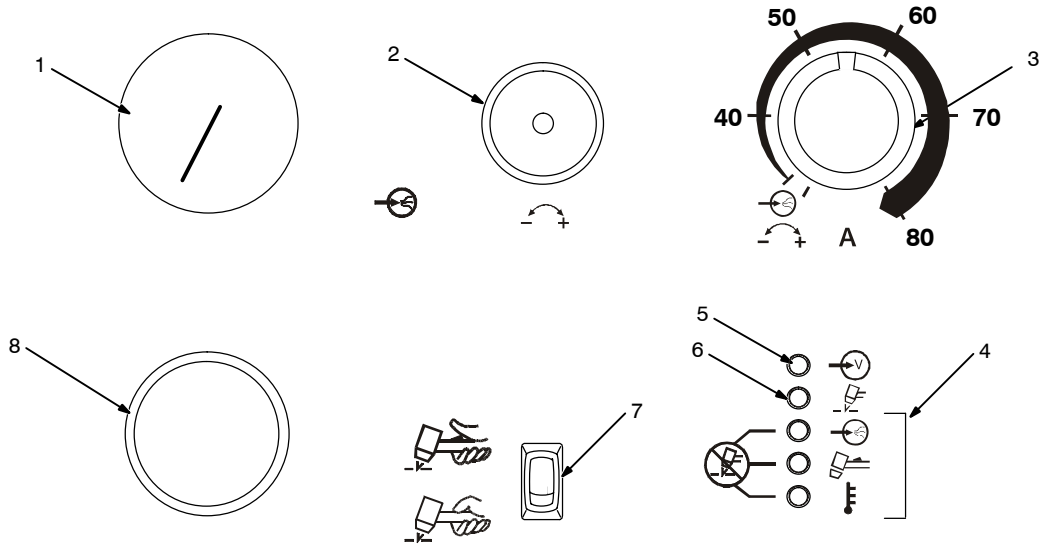

- 1 Gas/Air Pressure Gauge
- 2 Gas/Air Pressure Adjustment Knob
- 3 Output Control

Use control to set cutting output.

Gas/air automatically flows at the set pressure.

Use Gas/Air Set area of control range for setting gas/air pressure (see Section 5-2).

- 4 Trouble Lights (see Section 6-2)

Power light comes On when Power switch is placed in On position.

- 5 Power Light
- 6 Ready Light

Ready light comes On when unit is On to indicate that all safety shutdown systems are okay. If Ready light does not come On, check trouble lights.

- 7 Trigger Hold Switch

To cut without holding torch trigger, set trigger hold switch so upper end is pressed In. Press

the torch trigger, begin cutting, and release the trigger. To stop cutting, press and release trigger.

When set in down position, trigger must be held closed while cutting.

- 8 Torch Quick-Disconnect Connector

- 9 Power Switch

- 10 Door for Consumables Storage

Ref. 202 359 / Ref. 802 803-A

## 5-2. Setting Gas/Air Pressure

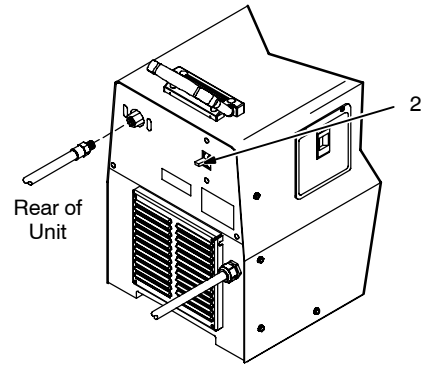
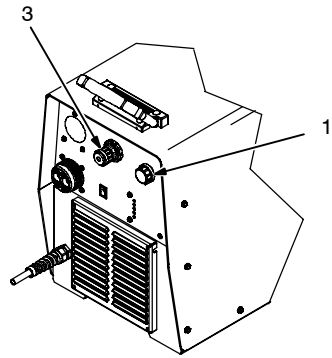

### Setting Gas/Air Pressure

Ref. 802 140 / Ref. 802 803-A

Place Output Control in  
Gas/Air Set Position

Power Switch On

Requires  
90–150 PSI Supply

Set UPC 838 To **80 PSI**

Set Controls → Turn On Gas/Air Supply → Adjust Pressure On Unit → Select Desired Amperage To Begin Cutting

1 Output Control

2 Power Switch

Place controls as indicated. Only gas/air circuit is activated when the Power switch is turned On with Output Control in Gas/Air Set position.

3 Gas/Air Pressure Adjustment Knob

Pull knob and turn to adjust pressure. Push knob in to lock setting. Select desired cutting output with Output Control.

### 5-3. Sequence Of Operation



**⚠ Do not clean torch by hitting it against a hard surface. Hitting hard surfaces can damage torch parts and stop proper operation.**

**⚠ Inspect shield cup, tip, and electrode for wear before cutting or whenever cutting speed has been significantly reduced (see torch Owner's Manual). Do not operate torch without a tip or electrode in place.**

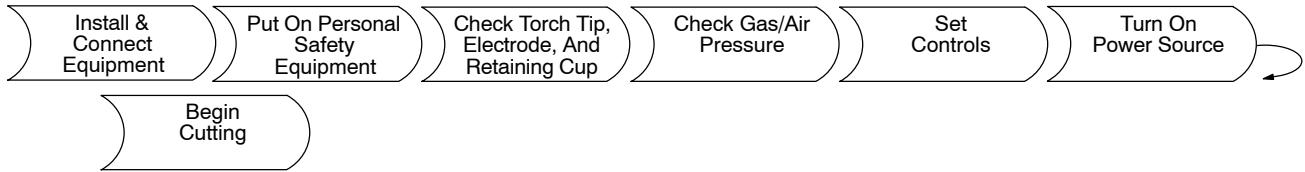

#### EXAMPLE Of Cutting Operation

**⚠ The pilot arc starts immediately when trigger is pressed.**

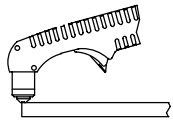

Place drag shield on edge of metal, or allow correct standoff distance – approximately 1/8 in (3 mm).

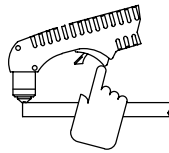

Press trigger. Pilot arc starts.

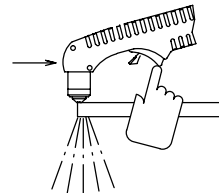

After cutting arc starts, slowly start moving torch across metal.

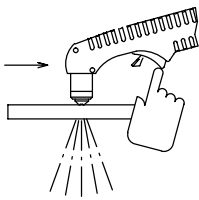

Adjust torch speed so sparks go thru metal and out bottom of cut.

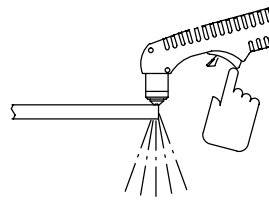

Pause briefly at end of cut before releasing trigger.

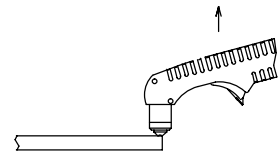









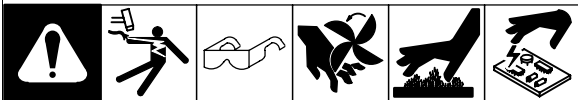
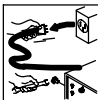

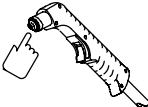
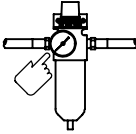
Postflow continues for approx. 20 to 30 seconds after releasing trigger; cutting arc can be instantly restarted during postflow by pressing trigger.

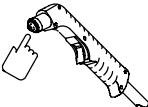
Ref. 801 400-A

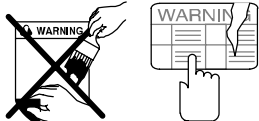
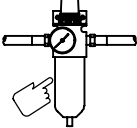
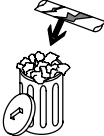
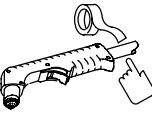
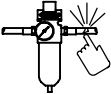
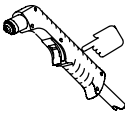
# SECTION 6 – MAINTENANCE & TROUBLESHOOTING

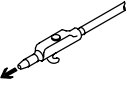
## 6-1. Routine Maintenance

				<p>▲ <b>Disconnect power before maintaining.</b></p>	<p>☞ <i>Maintain more often during severe conditions.</i></p>	
 <b>Each Use</b>						
 <p>Check Torch Tip, Electrode, And Shield Cup</p>			 <p>Check Gas/Air Pressure</p>			
 <b>Every Week</b>						
 <p>Check Shield Cup Shutdown System</p>						
 <b>3 Months</b>						
 <p>Replace Unreadable Labels</p>			 <p>Service Air Filter/Regulator Assembly Filter</p>			
 <p>Replace Cracked Parts</p>			 <p>Tape Torn Outer Covering Or Replace Cable</p>			
<p>Check Gas/Air Hose</p> 			 <p>Check Torch Body</p>			
 <b>6 Months</b>						
			<p>OR</p> 			<p>Blow Out Or Vacuum Inside</p>



## 6-2. Trouble Lights

 Difficulty establishing pilot arc may indicate consumables need to be cleaned or replaced.

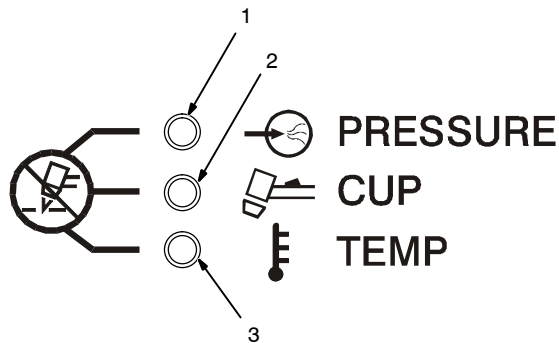

### 1 Pressure Light

Lights if gas/air pressure is below 50 PSI (345 kPa).

Turn power Off, and check for proper gas/air pressure (see Section 5-2).

### 2 Cup Light

Lights if shield cup is loose.

Turn power Off, and check shield cup connection (see torch Owner's Manual). Power must be reset whenever the cup shutdown is activated.

Check shield cup shutdown system once a week (see Section 6-3).

### 3 Temperature Light

Lights if power source overheats (see Section 4-2).

## 6-3. Checking Shield Cup Shutdown System



 Power must be reset whenever the cup shutdown system is activated. **Always turn Off power when changing or checking consumables.**

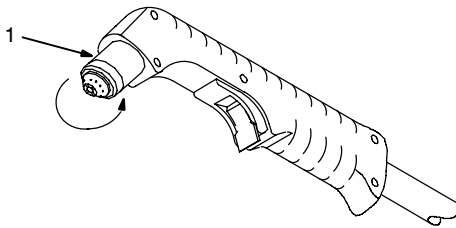

### 1 Torch Shield Cup

Turn Power On and loosen shield cup. If shutdown system works properly, Ready light goes off and Cup light comes on. If not, immediately turn Off power and have Factory Authorized Service Agent check safety control board PC1 operation.

If system works properly, retighten cup and reset power.

Ref. 801 300-A

## 6-4. Troubleshooting

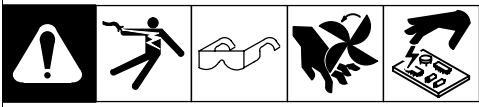
	
Trouble	Remedy
No pilot arc; difficulty in establishing an arc.	Clean or replace worn consumables as necessary (see torch Owner's Manual).
	Check for damaged torch or torch cable (see torch Owner's Manual).
No cutting output; Power light off; Trouble lights off; Ready light off; fan motor FM does not run.	Place Power switch in On position.
	Place line disconnect device in On position (see Section 4-7).
	Check line fuse(s) and replace if needed or reset circuit breakers (see Section 4-7).
Pilot arc working; no cutting output; Power light on; Ready light on; Trouble lights off; fan motor running.	Be sure work clamp is connected.
	Clean or replace worn consumables as necessary (see torch Owner's Manual).
No gas/air flow; Power light on; Ready light on; Trouble lights off; fan motor running.	Have Factory Authorized Service Agent check for proper torch connections. Check operation of gas valve GS1, and check gas/air system for leaks.
Pressure Trouble light On; Ready light off.	Check for correct gas/air pressure adjustment (see Section 5-2).
	Check for sufficient gas/air supply pressure (see Section 4-5).
	Check for dirty air filter/regulator and clean, if needed (see manufacturer's instructions).
	Check air lines for leaks.
	Have Factory Authorized Service Agent check pressure switch and control board.
Cup Trouble light On; Ready light off.	Check torch shield cup (see Section 6-3). Reset power switch.
	Have Factory Authorized Service Agent check for proper torch connections.
Temperature Trouble light On; Ready light off.	Inverter heat sink or output heat sink overheating. Allow fan to run; the Trouble light goes out when the unit has cooled.
	Have Factory Authorized Service Agent check control board.
Trouble lights not working.	Have Factory Authorized Service Agent check unit.
Power light flashing, Trouble lights off.	Reset power switch.



# SECTION 7 – ELECTRICAL DIAGRAM

	<b>WARNING</b>
	<ul style="list-style-type: none"> <li>• Do not touch live electrical parts.</li> <li>• Disconnect input power or stop engine before servicing.</li> <li>• Do not operate with covers removed.</li> <li>• Have only qualified persons install, use, or service this unit.</li> </ul>
<b>ELECTRIC SHOCK HAZARD</b>	

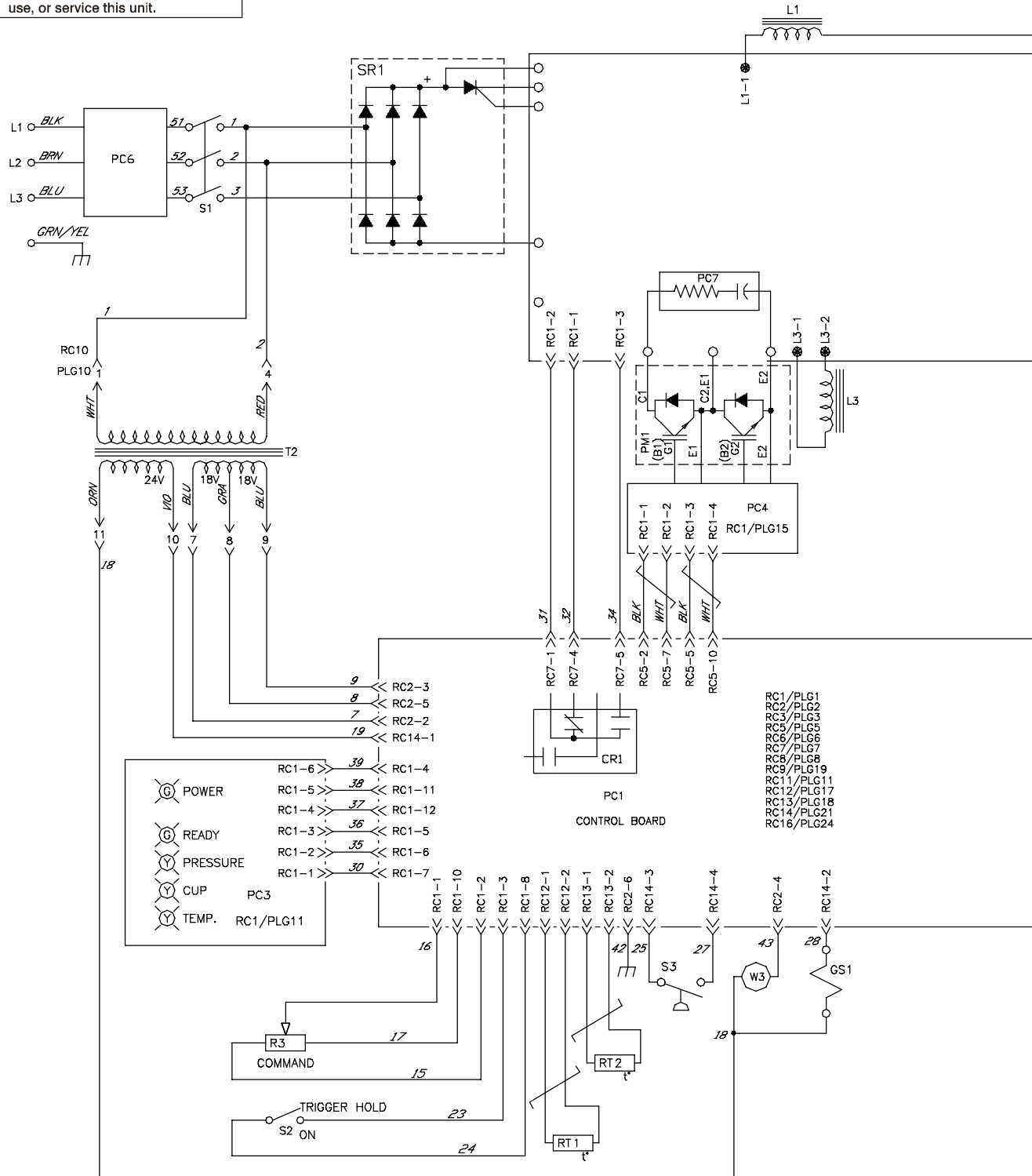
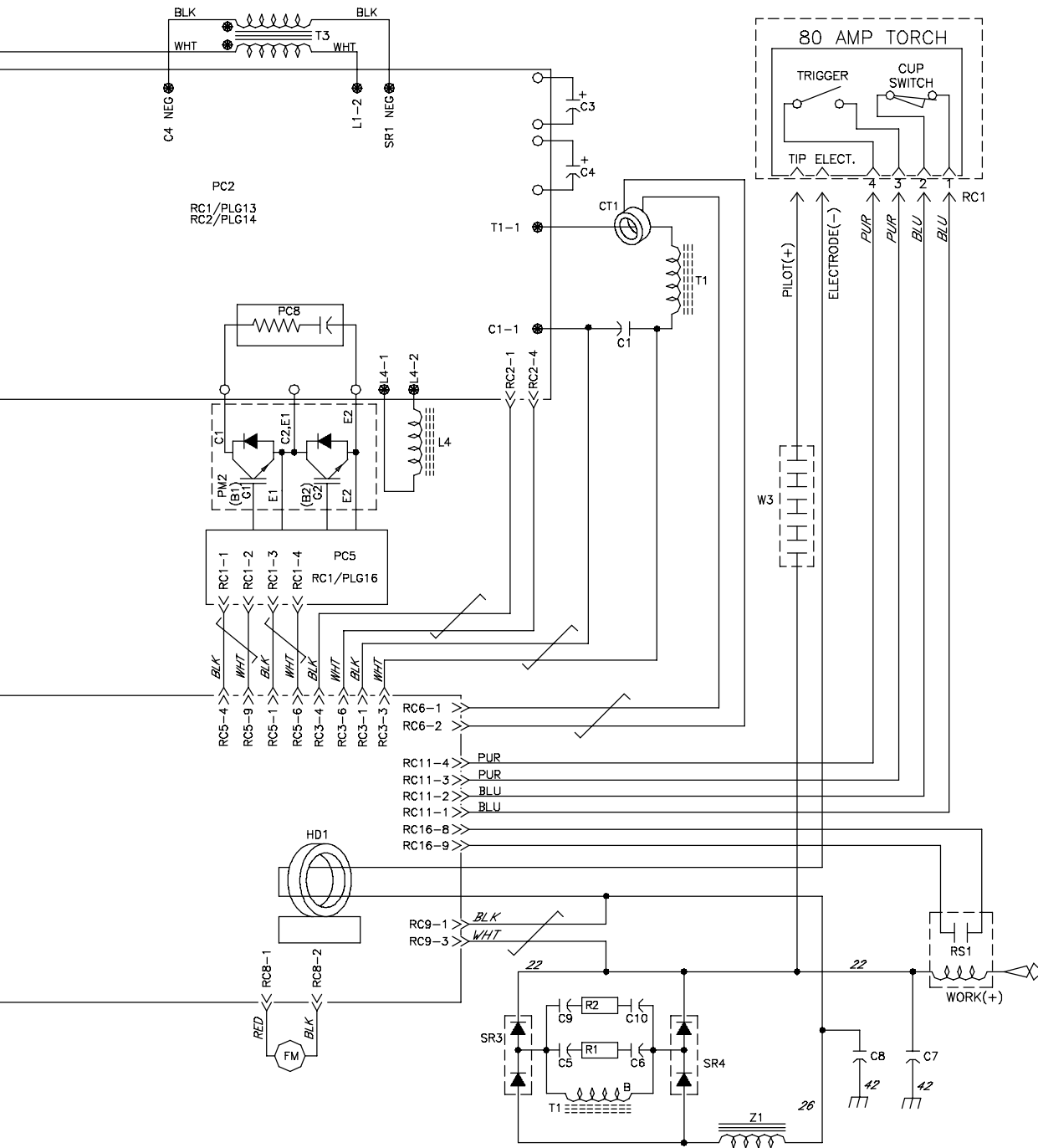



Figure 6-1. Circuit Diagram For Power Source



# SECTION 8 – PARTS LIST

 Hardware is common and not available unless listed.

\*Service Note: Item 29 is supplied as a two-circuit card assembly. Separate and discard breakaway portion of circuit card assembly located in lower right-hand corner, and replace with circuit card 670 349, Item 66.

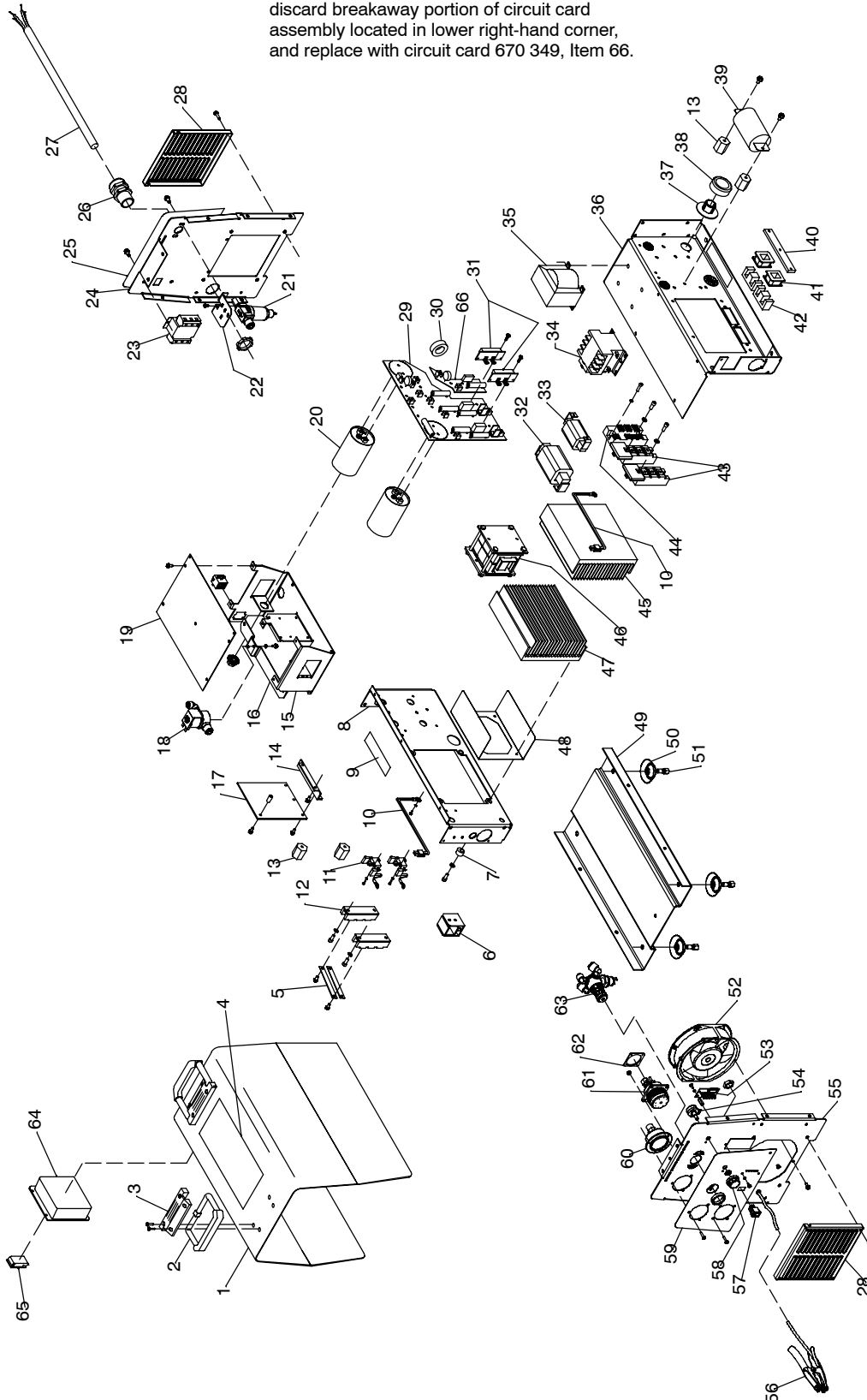

Figure 7-1. Complete Assembly

Item No.	Dia. Mkgs.	Unitor Part No.	Description	Quantity
----------	------------	-----------------	-------------	----------

**Figure 7-1. Complete Assembly**

1		671 222	WRAPPER, 206 278	1
2		671 073	HANDLE, molded, 126 416	2
3		671 065	CLAMP, molded, 126 415	2
4			LABEL, warning precautionary plasma cutting, 199 065	1
5			BUS BAR, output rectifier, 187 783	2
6	RS1	671 297	SWITCH, reed, 190 602	1
7			INSULATOR, screw, 181 853	4
8			WINDTUNNEL, lh, 193 969	1
9			LABEL, warning, 185 836	1
10			THERMISTOR, NTC, 173 632	2
11	C9,R2,C10			
	C5,R1,C6		RESISTOR, capacitor, 189 352	2
12	SR3,SR4	671 347	KIT, diode ultra fast (includes 2 diodes), 198 148	1
13			STAND-OFF, insulator, 025 248	4
14			BRACKET, mtg filter board, 194 375	1
15			BRACKET, mtg contactor, 175 136	1
16			BRACKET, mtg valve, 188 142	1
17	PC6	670 794	CIRCUIT CARD ASSY, input filter, 185 697	1
18	GS1	671 271	VALVE, solenoid w/fittings, 190 586	1
19	PC1	671 305	CIRCUIT CARD ASSY, control, 206 140	1
20	C3,C4	671 081	CAPACITOR, elcltt, 174 980	2
21		671 289	FILTER, air w/fittings, 190 590	1
22			BRACKET, mtg filter, 187 784	1
23	S1	671 057	SWITCH, tgl 3pst 60A, 045 835	1
24		671 214	PANEL, rear, 187 781	1
25		636 985	NAMEPLATE, rear CE polycarb, 205 850	1
26		657 155	BUSHING, strain relief, 213 099	1
27		657 163	CABLE, power, 210 346	1
28		670 836	BOX, louver, 175 138	1
29	PC2	671 255	CIRCUIT CARD ASSY, interconnect, 190 427 (see Service Note on Figure 7-1)	1
30			CHOKER, common mode, 182 108	1
31			CIRCUIT CARD ASSY, snubber, 193 653	2
32	Z1	671 321	STABILIZER, output, 194 602	1
33	L1	671 339	INDUCTOR, input, 194 606	1
34	W3	671 180	CONTACTOR, 200 677	1
35	T2		XFMR, control, 201 308	1
36			WINDTUNNEL, rh, 202 514	1
37			BUSHING, snap-in nyl, 177 547	1
38	CT1		XMFR, current, 175 199	1
39	C1		CAPACITOR, polyp, 188 446	1
40			BRACKET, DI/DT, 175 140	1
41	L3,L4		COIL, DI/DT, 175 482	2
42			CORE, ferrite, 109 056	2
43	PM1,PM2	670 901	KIT, transistor IGBT module (includes 2 IGBT's), 180 110	1
44	SR1	670 893	KIT, diode power module, 179 629	1
45			HEAT SINK, power module, 173 631	1
46	T1	671 313	XFMR, hf, 193 434	1
47			HEAT SINK, rectifier, 189 354	1
48			INSULATOR, rectifier, 175 255	1
49		670 919	BASE, 175 132	1
50			FOOT, mtg unit, 173 693	4
51			SCREW, mtg foot, 176 736	4
52	FM	670 935	MOTOR, fan, 175 084	1
53	PC3	671 230	CIRCUIT CARD ASSY, display, 189 387	1
54	R3	671 248	POTENTIOMETER, w/leads, 189 484	1
55		671 206	PANEL, front, 187 780	1

Item No.	Dia. Mkgs.	Unitor Part No.	Description	Quantity
----------	------------	-----------------	-------------	----------

**Figure 7-1. Complete Assembly (continued)**

56		671 354	WORK CLAMP/CABLE ASSY, 6M No.8 w/clamp, strain relief & terminal	1
57	S2		SWITCH, rocker, 120 376	1
58			KNOB, lg, 940 024-101	1
59		637 009	NAMEPLATE, front polycarb Unitor CE, 205 849	1
60		671 263	GAUGE, pressure air w/ftg, 190 585	1
61		671 123	DISCONNECT, quick, 178 263	1
62			FLANGE, receptacle, 201 817	1
63		671 248	REGULATOR, switch w/ftg, 190 029	1
64		636 969	CONSUMABLE STORAGE BOX, w/door & latch, 204 326	1
65		636 977	LATCH, slide flush style series 40, 089 899	1
66		671 925	KIT, rectifier protection 198 095	1
		671 198	TORCH, replacement ICE-80C 7.6m (25ft), 176 830	1
		671 131	TORCH, replacement ICE-80C 15.2m (50ft), 176 832	1

**To maintain the factory original performance of your equipment, use only Manufacturer's Suggested Replacement Parts. Model and serial number required when ordering parts from your local distributor.**

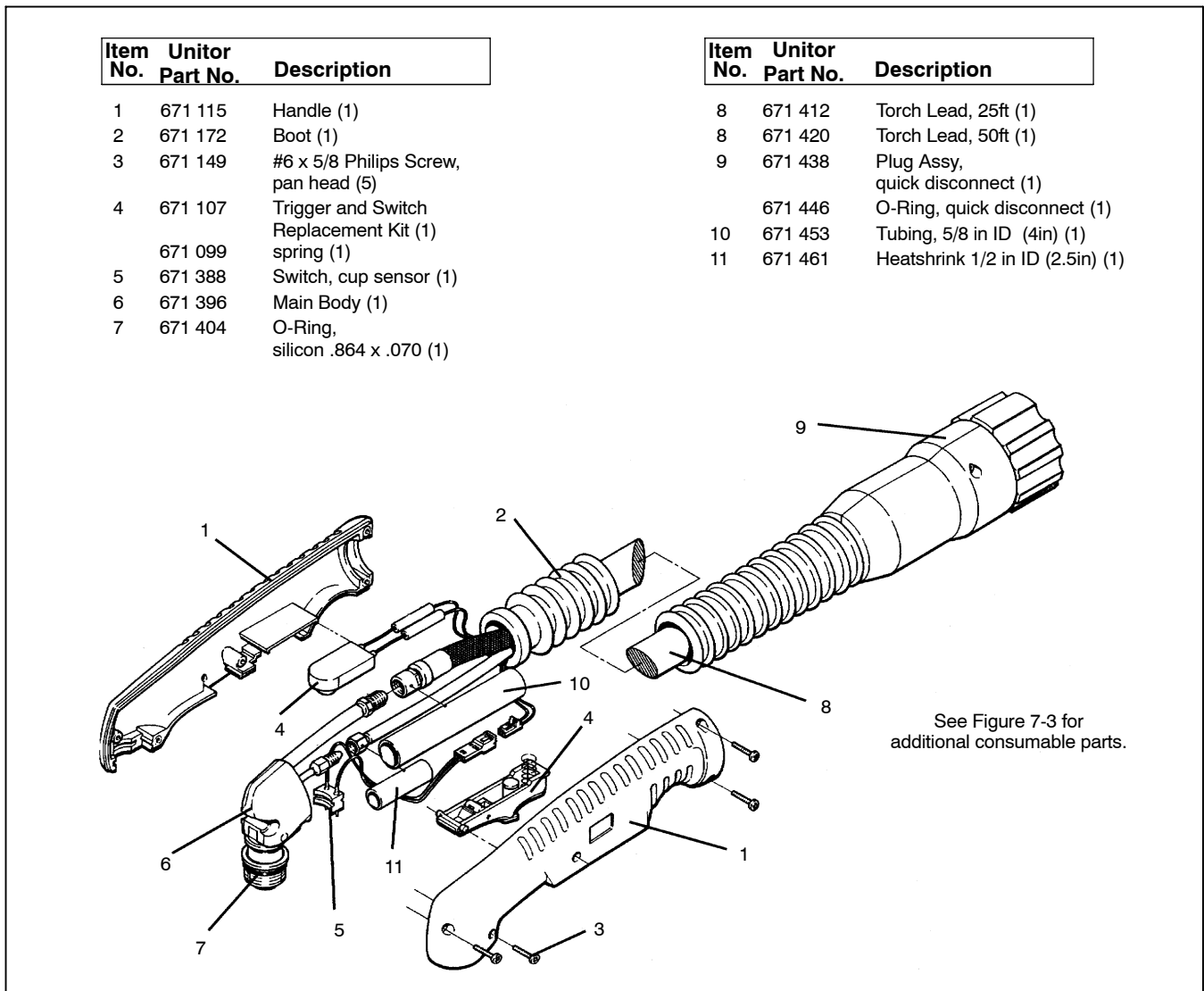

**Figure 7-2. Torch, ICE-80C**



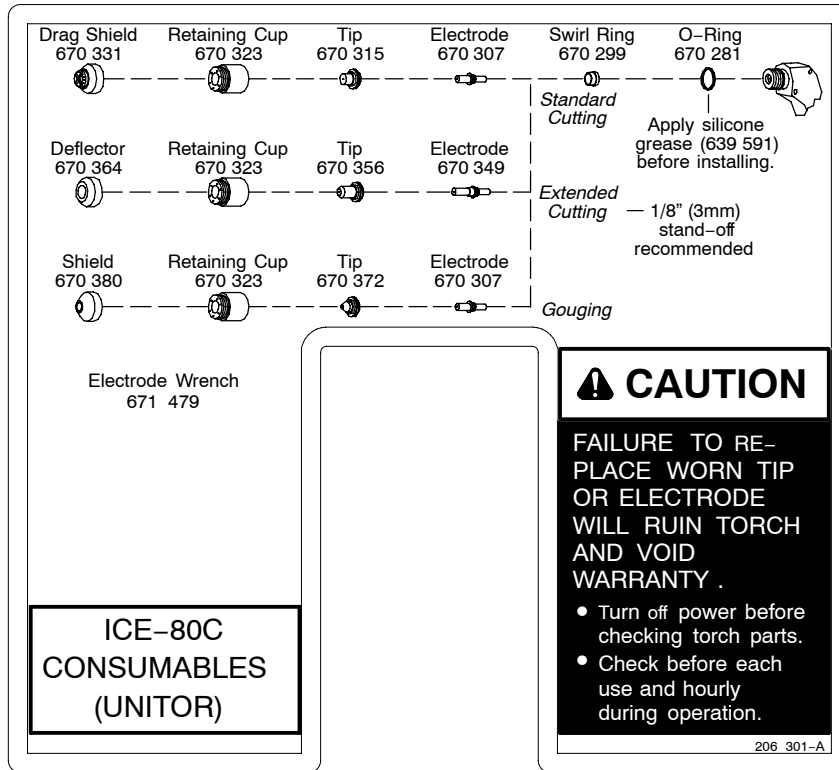

206 301

**Figure 7-3. Consumable Parts For ICE-80C**







# Owner's Record

Please complete and retain with your personal records.

Model Name

Serial/Style Number

Purchase Date

(Date which equipment was delivered to original customer.)

Distributor

Address

City

State

Zip



# Resources Available

Always provide Model Name and Serial/Style Number.

Contact your Distributor for:

Welding Supplies and Consumables

Options and Accessories

Personal Safety Equipment

Service and Repair

Replacement Parts

Owner's Manuals

Circuit Diagrams

Contact the Delivering Carrier to:

File a claim for loss or damage during shipment.

For assistance in filing or settling claims, contact your distributor and/or equipment manufacturer's Transportation Department.

## Free Manuals Download Website

<http://myh66.com>

<http://usermanuals.us>

<http://www.somanuals.com>

<http://www.4manuals.cc>

<http://www.manual-lib.com>

<http://www.404manual.com>

<http://www.luxmanual.com>

<http://aubethermostatmanual.com>

Golf course search by state

<http://golfingnear.com>

Email search by domain

<http://emailbydomain.com>

Auto manuals search

<http://auto.somanuals.com>

TV manuals search

<http://tv.somanuals.com>