



OM-181 712C

January 2005

Processes



MIG (GMAW) Welding

Description



Weld Control For Spoolmatic Gun

CE

WC-24

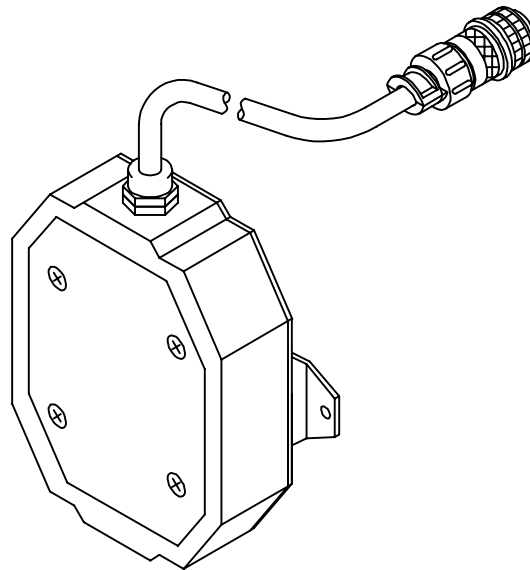

Visit our website at
www.MillerWelds.com

OWNER'S MANUAL

From Miller to You

Thank you and congratulations on choosing Miller. Now you can get the job done and get it done right. We know you don't have time to do it any other way.

That's why when Niels Miller first started building arc welders in 1929, he made sure his products offered long-lasting value and superior quality. Like you, his customers couldn't afford anything less. Miller products had to be more than the best they could be. They had to be the best you could buy.

Today, the people that build and sell Miller products continue the tradition. They're just as committed to providing equipment and service that meets the high standards of quality and value established in 1929.

This Owner's Manual is designed to help you get the most out of your Miller products. Please take time to read the Safety precautions. They will help you protect yourself against potential hazards on the worksite.

We've made installation and operation quick and easy. With Miller you can count on years of reliable service with proper maintenance. And if for some reason the unit needs repair, there's a Troubleshooting section that will help you figure out what the problem is. The parts list will then help you to decide the exact part you may need to fix the problem. Warranty and service information for your particular model are also provided.



Miller is the first welding equipment manufacturer in the U.S.A. to be registered to the ISO 9001:2000 Quality System Standard.

Miller Electric manufactures a full line of welders and welding related equipment. For information on other quality Miller products, contact your local Miller distributor to receive the latest full line catalog or individual catalog sheets. **To locate your nearest distributor or service agency call 1-800-4-A-Miller, or visit us at www.MillerWelds.com on the web.**



Working as hard as you do – every power source from Miller is backed by the most hassle-free warranty in the business.



TABLE OF CONTENTS

SECTION 1 – SAFETY PRECAUTIONS - READ BEFORE USING	1
1-1. Symbol Usage	1
1-2. Arc Welding Hazards	1
1-3. Additional Symbols For Installation, Operation, And Maintenance	3
1-4. California Proposition 65 Warnings	3
1-5. Principal Safety Standards	4
1-6. EMF Information	4
SECTION 2 – CONSIGNES DE SÉCURITÉ – À LIRE AVANT UTILISATION	5
2-1. Signification des symboles	5
2-2. Dangers relatifs au soudage à l'arc	5
2-3. Autres symboles relatifs à l'installation, au fonctionnement et à l'entretien de l'appareil.	7
2-4. Principales normes de sécurité	8
2-5. Information sur les champs électromagnétiques	8
SECTION 2 – DEFINITIONS	9
2-1. Manufacturer's Rating Label For CE Products	9
2-2. Symbols And Definitions	9
SECTION 4 – INSTALLATION	10
4-1. Specifications	10
4-2. Typical Process Connections	10
4-3. 14-Pin Plug Information	10
4-4. Connecting WC24 To A Millermatic 200 Or Spoolmate 200	11
4-5. Weld Control Connections	11
SECTION 5 – MAINTENANCE & TROUBLESHOOTING	12
5-1. Routine Maintenance	12
5-2. Troubleshooting	12
SECTION 6 – ELECTRICAL DIAGRAMS	13
SECTION 7 – PARTS LIST	14
WARRANTY	

Declaration of Conformity for European Community (CE) Products

NOTE 

This information is provided for units with CE certification (see rating label on unit).

Manufacturer's Name: **Miller Electric Mfg. Co.**

Manufacturer's Address: 1635 W. Spencer Street
Appleton, WI 54914 USA

Declares that the product: **WC-24**

conforms to the following Directives and Standards:

Directives

Low Voltage Directive: 73/23/EEC

Electromagnetic Compatibility (EMC) Directive: 89/336/EEC

Machinery Directives: 89/392/EEC, 91/368/EEC, 93/C 133/04, 93/68/EEC

Standards

Arc Welding Equipment Part I: Welding Power Sources: IEC 974-1
(April 1995 – Draft Revision)

Arc Welding Equipment: Wirefeed Systems: IEC 974-4
(May 1995 – Draft Revision)

Degrees of Protection Provided By Enclosures (IP Code): IEC 529:1989

Insulation Coordination For Equipment With Low-Voltage Systems:
Part I: Principles, Requirements and Tests: IEC 664-1: 1992

Electromagnetic Compatibility, (EMC): EN 50199

European Contact: Mr. Danilo Fedolfi, Managing Director
ITW WELDING PRODUCTS ITALY S.r.l.
Via Privata Iseo 6/E
20098 San Giuliano
Milanese, Italy

Telephone: 39(02)98290-1
Fax: 39(02)98290-203

SECTION 1 – SAFETY PRECAUTIONS - READ BEFORE USING

som _8/03



Means Warning! Watch Out! There are possible hazards with this procedure! The possible hazards are shown in the adjoining symbols.

▲ Marks a special safety message.

☞ Means "Note"; not safety related.



This group of symbols means Warning! Watch Out! possible ELECTRIC SHOCK, MOVING PARTS, and HOT PARTS hazards. Consult symbols and related instructions below for necessary actions to avoid the hazards.

▲ The symbols shown below are used throughout this manual to call attention to and identify possible hazards. When you see the symbol, watch out, and follow the related instructions to avoid the hazard. The safety information given below is only a summary of the more complete safety information found in the Safety Standards listed in Section NO TAG. Read and follow all Safety Standards.

▲ Only qualified persons should install, operate, maintain, and repair this unit.

▲ During operation, keep everybody, especially children, away.



ELECTRIC SHOCK can kill.

Touching live electrical parts can cause fatal shocks or severe burns. The electrode and work circuit is electrically live whenever the output is on. The input power circuit and machine internal circuits are also live when power is on. In semiautomatic or automatic wire welding, the wire, wire reel, drive roll housing, and all metal parts touching the welding wire are electrically live. Incorrectly installed or improperly grounded equipment is a hazard.

- Do not touch live electrical parts.
- Wear dry, hole-free insulating gloves and body protection.
- Insulate yourself from work and ground using dry insulating mats or covers big enough to prevent any physical contact with the work or ground.
- Do not use AC output in damp areas, if movement is confined, or if there is a danger of falling.
- Use AC output ONLY if required for the welding process.
- If AC output is required, use remote output control if present on unit.
- Disconnect input power or stop engine before installing or servicing this equipment. Lockout/tagout input power according to OSHA 29 CFR 1910.147 (see Safety Standards).
- Properly install and ground this equipment according to its Owner's Manual and national, state, and local codes.
- Always verify the supply ground – check and be sure that input power cord ground wire is properly connected to ground terminal in disconnect box or that cord plug is connected to a properly grounded receptacle outlet.
- When making input connections, attach proper grounding conductor first – double-check connections.
- Frequently inspect input power cord for damage or bare wiring – replace cord immediately if damaged – bare wiring can kill.
- Turn off all equipment when not in use.
- Do not use worn, damaged, undersized, or poorly spliced cables.
- Do not drape cables over your body.

- If earth grounding of the workpiece is required, ground it directly with a separate cable.
- Do not touch electrode if you are in contact with the work, ground, or another electrode from a different machine.
- Use only well-maintained equipment. Repair or replace damaged parts at once. Maintain unit according to manual.
- Wear a safety harness if working above floor level.
- Keep all panels and covers securely in place.
- Clamp work cable with good metal-to-metal contact to workpiece or worktable as near the weld as practical.
- Insulate work clamp when not connected to workpiece to prevent contact with any metal object.
- Do not connect more than one electrode or work cable to any single weld output terminal.

SIGNIFICANT DC VOLTAGE exists after removal of input power on inverters.

- Turn Off inverter, disconnect input power, and discharge input capacitors according to instructions in Maintenance Section before touching any parts.

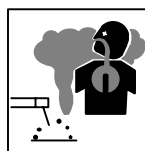

FUMES AND GASES can be hazardous.

Welding produces fumes and gases. Breathing these fumes and gases can be hazardous to your health.

- Keep your head out of the fumes. Do not breathe the fumes.
- If inside, ventilate the area and/or use exhaust at the arc to remove welding fumes and gases.
- If ventilation is poor, use an approved air-supplied respirator.
- Read the Material Safety Data Sheets (MSDSs) and the manufacturer's instructions for metals, consumables, coatings, cleaners, and degreasers.
- Work in a confined space only if it is well ventilated, or while wearing an air-supplied respirator. Always have a trained watch-person nearby. Welding fumes and gases can displace air and lower the oxygen level causing injury or death. Be sure the breathing air is safe.
- Do not weld in locations near degreasing, cleaning, or spraying operations. The heat and rays of the arc can react with vapors to form highly toxic and irritating gases.
- Do not weld on coated metals, such as galvanized, lead, or cadmium plated steel, unless the coating is removed from the weld area, the area is well ventilated, and if necessary, while wearing an air-supplied respirator. The coatings and any metals containing these elements can give off toxic fumes if welded.



ARC RAYS can burn eyes and skin.

Arc rays from the welding process produce intense visible and invisible (ultraviolet and infrared) rays that can burn eyes and skin. Sparks fly off from the weld.

- Wear a welding helmet fitted with a proper shade of filter to protect your face and eyes when welding or watching (see ANSI Z49.1 and Z87.1 listed in Safety Standards).
- Wear approved safety glasses with side shields under your helmet.
- Use protective screens or barriers to protect others from flash and glare; warn others not to watch the arc.
- Wear protective clothing made from durable, flame-resistant material (leather and wool) and foot protection.



WELDING can cause fire or explosion.

Welding on closed containers, such as tanks, drums, or pipes, can cause them to blow up. Sparks can fly off from the welding arc. The flying sparks, hot workpiece, and hot equipment can cause fires and burns. Accidental contact of electrode to metal objects can cause sparks, explosion, overheating, or fire. Check and be sure the area is safe before doing any welding.

- Protect yourself and others from flying sparks and hot metal.
- Do not weld where flying sparks can strike flammable material.
- Remove all flammables within 35 ft (10.7 m) of the welding arc. If this is not possible, tightly cover them with approved covers.
- Be alert that welding sparks and hot materials from welding can easily go through small cracks and openings to adjacent areas.
- Watch for fire, and keep a fire extinguisher nearby.
- Be aware that welding on a ceiling, floor, bulkhead, or partition can cause fire on the hidden side.
- Do not weld on closed containers such as tanks, drums, or pipes, unless they are properly prepared according to AWS F4.1 (see Safety Standards).
- Connect work cable to the work as close to the welding area as practical to prevent welding current from traveling long, possibly unknown paths and causing electric shock and fire hazards.
- Do not use welder to thaw frozen pipes.
- Remove stick electrode from holder or cut off welding wire at contact tip when not in use.
- Wear oil-free protective garments such as leather gloves, heavy shirt, cuffless trousers, high shoes, and a cap.
- Remove any combustibles, such as a butane lighter or matches, from your person before doing any welding.

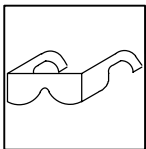

FLYING METAL can injure eyes.

- Welding, chipping, wire brushing, and grinding cause sparks and flying metal. As welds cool, they can throw off slag.
- Wear approved safety glasses with side shields even under your welding helmet.



BUILDUP OF GAS can injure or kill.

- Shut off shielding gas supply when not in use.
- Always ventilate confined spaces or use approved air-supplied respirator.



HOT PARTS can cause severe burns.

- Do not touch hot parts bare handed.
- Allow cooling period before working on gun or torch.

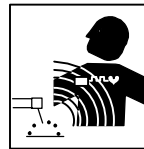

MAGNETIC FIELDS can affect pacemakers.

- Pacemaker wearers keep away.
- Wearers should consult their doctor before going near arc welding, gouging, or spot welding operations.

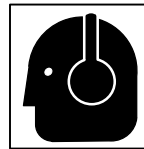

NOISE can damage hearing.

Noise from some processes or equipment can damage hearing.

- Wear approved ear protection if noise level is high.

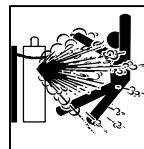

CYLINDERS can explode if damaged.

Shielding gas cylinders contain gas under high pressure. If damaged, a cylinder can explode. Since gas cylinders are normally part of the welding process, be sure to treat them carefully.

- Protect compressed gas cylinders from excessive heat, mechanical shocks, slag, open flames, sparks, and arcs.
- Install cylinders in an upright position by securing to a stationary support or cylinder rack to prevent falling or tipping.
- Keep cylinders away from any welding or other electrical circuits.
- Never drape a welding torch over a gas cylinder.
- Never allow a welding electrode to touch any cylinder.
- Never weld on a pressurized cylinder – explosion will result.
- Use only correct shielding gas cylinders, regulators, hoses, and fittings designed for the specific application; maintain them and associated parts in good condition.
- Turn face away from valve outlet when opening cylinder valve.
- Keep protective cap in place over valve except when cylinder is in use or connected for use.
- Read and follow instructions on compressed gas cylinders, associated equipment, and CGA publication P-1 listed in Safety Standards.



FIRE OR EXPLOSION hazard.

- Do not install or place unit on, over, or near combustible surfaces.
- Do not install unit near flammables.
- Do not overload building wiring – be sure power supply system is properly sized, rated, and protected to handle this unit.



FALLING UNIT can cause injury.

- Use lifting eye to lift unit only, NOT running gear, gas cylinders, or any other accessories.
- Use equipment of adequate capacity to lift and support unit.
- If using lift forks to move unit, be sure forks are long enough to extend beyond opposite side of unit.

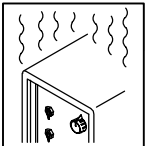

OVERUSE can cause OVERHEATING

- Allow cooling period; follow rated duty cycle.
- Reduce current or reduce duty cycle before starting to weld again.
- Do not block or filter airflow to unit.

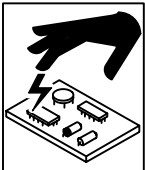

STATIC (ESD) can damage PC boards.

- Put on grounded wrist strap BEFORE handling boards or parts.
- Use proper static-proof bags and boxes to store, move, or ship PC boards.



MOVING PARTS can cause injury.

- Keep away from moving parts.
- Keep away from pinch points such as drive rolls.



WELDING WIRE can cause injury.

- Do not press gun trigger until instructed to do so.
- Do not point gun toward any part of the body, other people, or any metal when threading welding wire.



MOVING PARTS can cause injury.

- Keep away from moving parts such as fans.
- Keep all doors, panels, covers, and guards closed and securely in place.

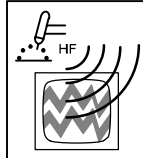

H.F. RADIATION can cause interference.

- High-frequency (H.F.) can interfere with radio navigation, safety services, computers, and communications equipment.
- Have only qualified persons familiar with electronic equipment perform this installation.
- The user is responsible for having a qualified electrician promptly correct any interference problem resulting from the installation.
- If notified by the FCC about interference, stop using the equipment at once.
- Have the installation regularly checked and maintained.
- Keep high-frequency source doors and panels tightly shut, keep spark gaps at correct setting, and use grounding and shielding to minimize the possibility of interference.

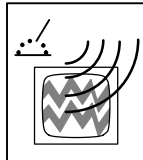

ARC WELDING can cause interference.

- Electromagnetic energy can interfere with sensitive electronic equipment such as computers and computer-driven equipment such as robots.
- Be sure all equipment in the welding area is electromagnetically compatible.
- To reduce possible interference, keep weld cables as short as possible, close together, and down low, such as on the floor.
- Locate welding operation 100 meters from any sensitive electronic equipment.
- Be sure this welding machine is installed and grounded according to this manual.
- If interference still occurs, the user must take extra measures such as moving the welding machine, using shielded cables, using line filters, or shielding the work area.

▲ **Welding or cutting equipment produces fumes or gases which contain chemicals known to the State of California to cause birth defects and, in some cases, cancer. (California Health & Safety Code Section 25249.5 et seq.)**

▲ **Battery posts, terminals and related accessories contain lead and lead compounds, chemicals known to the State of California to cause cancer and birth defects or other reproductive harm. Wash hands after handling.**

For Gasoline Engines:

▲ **Engine exhaust contains chemicals known to the State of California to cause cancer, birth defects, or other reproductive harm.**

For Diesel Engines:

▲ **Diesel engine exhaust and some of its constituents are known to the State of California to cause cancer, birth defects, and other reproductive harm.**

Safety in Welding, Cutting, and Allied Processes, ANSI Standard Z49.1, from American Welding Society, 550 N.W. LeJeune Rd, Miami FL 33126 (phone: 305-443-9353, website: www.aws.org).

Recommended Safe Practices for the Preparation for Welding and Cutting of Containers and Piping, American Welding Society Standard AWS F4.1, from American Welding Society, 550 N.W. LeJeune Rd, Miami, FL 33126 (phone: 305-443-9353, website: www.aws.org).

National Electrical Code, NFPA Standard 70, from National Fire Protection Association, P.O. Box 9101, 1 Battery March Park, Quincy, MA 02269-9101 (phone: 617-770-3000, website: www.nfpa.org and www.sparky.org).

Safe Handling of Compressed Gases in Cylinders, CGA Pamphlet P-1, from Compressed Gas Association, 1735 Jefferson Davis Highway, Suite 1004, Arlington, VA 22202-4102 (phone: 703-412-0900, website: www.cganet.com).

Code for Safety in Welding and Cutting, CSA Standard W117.2, from Canadian Standards Association, Standards Sales, 178 Rexdale

Boulevard, Rexdale, Ontario, Canada M9W 1R3 (phone: 800-463-6727 or in Toronto 416-747-4044, website: www.csa-international.org).

Practice For Occupational And Educational Eye And Face Protection, ANSI Standard Z87.1, from American National Standards Institute, 11 West 42nd Street, New York, NY 10036-8002 (phone: 212-642-4900, website: www.ansi.org).

Standard for Fire Prevention During Welding, Cutting, and Other Hot Work, NFPA Standard 51B, from National Fire Protection Association, P.O. Box 9101, 1 Battery March Park, Quincy, MA 02269-9101 (phone: 617-770-3000, website: www.nfpa.org and www.sparky.org).

OSHA, Occupational Safety and Health Standards for General Industry, Title 29, Code of Federal Regulations (CFR), Part 1910, Subpart Q, and Part 1926, Subpart J, from U.S. Government Printing Office, Superintendent of Documents, P.O. Box 371954, Pittsburgh, PA 15250 (there are 10 Regional Offices—phone for Region 5, Chicago, is 312-353-2220, website: www.osha.gov).

Considerations About Welding And The Effects Of Low Frequency Electric And Magnetic Fields

Welding current, as it flows through welding cables, will cause electromagnetic fields. There has been and still is some concern about such fields. However, after examining more than 500 studies spanning 17 years of research, a special blue ribbon committee of the National Research Council concluded that: "The body of evidence, in the committee's judgment, has not demonstrated that exposure to power-frequency electric and magnetic fields is a human-health hazard." However, studies are still going forth and evidence continues to be examined. Until the final conclusions of the research are reached, you may wish to minimize your exposure to electromagnetic fields when welding or cutting.

To reduce magnetic fields in the workplace, use the following procedures:

1. Keep cables close together by twisting or taping them.
2. Arrange cables to one side and away from the operator.
3. Do not coil or drape cables around your body.
4. Keep welding power source and cables as far away from operator as practical.

5. Connect work clamp to workpiece as close to the weld as possible.

About Pacemakers:

Pacemaker wearers consult your doctor first. If cleared by your doctor, then following the above procedures is recommended.

1. Keep cables close together by twisting or taping them.
2. Arrange cables to one side and away from the operator.
3. Do not coil or drape cables around your body.
4. Keep welding power source and cables as far away from operator as practical.
5. Connect work clamp to workpiece as close to the weld as possible.

About Pacemakers:

Pacemaker wearers consult your doctor first. If cleared by your doctor, then following the above procedures is recommended.

SECTION 2 – CONSIGNES DE SÉCURITÉ – À LIRE AVANT UTILISATION

som_fre 8/03



Signifie « Mise en garde. Faire preuve de vigilance. » Cette procédure présente des risques identifiés par les symboles adjacents aux directives.

▲ Identifie un message de sécurité particulier.

☞ Signifie « NOTA » ; n'est pas relatif à la sécurité.



Ce groupe de symboles signifie « Mise en garde. Faire preuve de vigilance. » Il y a des dangers liés aux CHOCS ÉLECTRIQUES, aux PIÈCES EN MOUVEMENT et aux PIÈCES CHAUDES. Se reporter aux symboles et aux directives ci-dessous afin de connaître les mesures à prendre pour éviter tout danger.

▲ Les symboles ci-après sont utilisés tout au long du présent manuel pour attirer l'attention sur les dangers potentiels et les identifier. Lorsqu'on voit un symbole, faire preuve de vigilance et suivre les directives mentionnées afin d'éviter tout danger. Les consignes de sécurité énoncées ci-après ne font que résumer le contenu des normes de sécurité mentionnées à la section NO TAG Lire et respecter toutes ces normes.

▲ L'installation, l'utilisation, l'entretien et les réparations ne doivent être confiés qu'à des personnes qualifiées.

▲ Pendant l'utilisation de l'appareil, tenir à l'écart toute personne, en particulier les enfants.



LES DÉCHARGES ÉLECTRIQUES peuvent être mortelles.

Un simple contact avec des pièces sous tension peut causer une électrocution ou des blessures graves. L'électrode et le circuit de soudage sont sous tension dès que l'appareil est en fonctionnement. Le circuit d'entrée et les circuits internes de l'appareil sont également sous tension. En soudage semi-automatique ou automatique, le fil, le dévidoir, le logement des galets d'entraînement et les pièces métalliques en contact avec le fil de soudage sont sous tension. Tout matériel mal installé ou mal mis à la terre présente un danger.

- Ne jamais toucher aux pièces électriques sous tension.
- Porter des gants et des vêtements de protection secs et exempts de trous.
- S'isoler de la pièce et de la terre au moyen de tapis ou autres dispositifs isolants suffisamment grands pour empêcher tout contact physique avec la pièce ou la terre.
- Ne pas se servir d'une source de courant alternatif dans les zones humides, les endroits confinés ou là où on risque de tomber.
- Ne se servir d'une source de courant alternatif QUE si le procédé de soudage l'exige.
- Si l'utilisation d'une source de courant alternatif s'avère nécessaire, se servir de la fonction de télécommande si l'appareil en est équipé.
- Couper l'alimentation ou arrêter le moteur avant de procéder à l'installation, à la réparation ou à l'entretien de l'appareil. Couper/étiqueter l'alimentation selon la norme OSHA 29 CFR 1910.147 (voir les normes de sécurité).
- Installer et mettre à la terre correctement l'appareil conformément à son manuel d'utilisation et aux codes nationaux, provinciaux et municipaux.
- Toujours vérifier la terre du cordon d'alimentation – Vérifier et s'assurer que le fil de terre du cordon d'alimentation est bien raccordé à la borne de terre du sectionneur ou que la fiche du cordon est raccordée à une prise correctement mise à la terre.
- Pour exécuter les branchements d'entrée, fixer d'abord le conducteur de mise à la terre adéquat et contre-vérifier les connexions.
- Vérifier fréquemment le cordon d'alimentation et s'assurer qu'il n'est ni endommagé ni dénudé ; le remplacer immédiatement s'il est endommagé – tout câble dénudé peut causer une électrocution.
- Mettre l'appareil hors tension quand on ne l'utilise pas.
- Ne pas utiliser de câbles usés, endommagés, de calibre insuffisant ou mal épissés.
- Ne pas s'enrouler les câbles autour du corps.
- Si la pièce soudée doit être mise à la terre, le faire directement avec un câble distinct.
- Ne pas toucher l'électrode quand on est en contact avec la pièce, la terre ou une électrode d'une autre machine.

- N'utiliser que du matériel en bon état. Réparer ou remplacer sur-le-champ les pièces endommagées. Entretien l'appareil conformément au présent manuel.
- Porter un harnais de sécurité quand on travaille en hauteur.
- Maintenir solidement en place tous les panneaux et capots.
- Fixer le câble de retour de façon à obtenir un bon contact métal sur métal avec la pièce à souder ou la table de travail, le plus près possible de la soudure.
- Ne pas connecter plus d'une électrode ou plus d'un câble de masse à un même terminal de sortie.

Il subsiste un COURANT CONTINU IMPORTANT dans les convertisseurs après la suppression de l'alimentation électrique.

- Arrêter les convertisseurs, débrancher le courant électrique et décharger les condensateurs d'alimentation selon les instructions énoncées à la section Entretien avant de toucher les pièces.

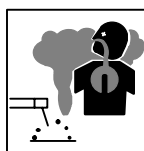

LES FUMÉES ET LES GAZ peuvent être dangereux.

Le soudage génère des fumées et des gaz dont l'inhalation peut être dangereuse pour la santé.

- Se tenir à distance des fumées et ne pas les inhaler.
- À l'intérieur, ventiler la zone et/ou utiliser un dispositif d'aspiration au niveau de l'arc pour l'évacuation des fumées et des gaz de soudage.
- Si la ventilation est insuffisante, utiliser un respirateur à adduction d'air agréé.
- Lire les fiches techniques de santé-sécurité (FTSS) et les instructions du fabricant concernant les métaux, les consommables, les revêtements, les nettoyeurs et les dégraissateurs.
- Ne travailler dans un espace clos que s'il est bien ventilé ou porter un respirateur à adduction d'air. Demander toujours à un surveillant dûment formé de se tenir à proximité. Des fumées et des gaz de soudage peuvent se substituer à l'air, abaisser la teneur en oxygène et causer des lésions ou des accidents mortels. S'assurer que l'air est respirable.
- Ne pas souder à proximité d'opérations de dégraissage, de nettoyage ou de pulvérisation. La chaleur et les rayons de l'arc peuvent réagir en présence de vapeurs et former des gaz hautement toxiques et irritants.
- Ne pas souder de métaux munis d'un revêtement, tels que la tôle d'acier galvanisée, plombée ou cadmiée, à moins que le revêtement n'ait été enlevé dans la zone de soudage, que l'endroit soit bien ventilé, et si nécessaire, porter un respirateur à adduction d'air. Les revêtements et tous les métaux renfermant ces éléments peuvent dégager des fumées toxiques lorsqu'on les soude.



LES RAYONS DE L'ARC peuvent causer des brûlures oculaires et cutanées.

Le rayonnement de l'arc génère des rayons visibles et invisibles intenses (ultraviolets et infrarouges) susceptibles de causer des brûlures oculaires et cutanées. Des étincelles sont projetées pendant le soudage.

- Porter un masque de soudage muni d'un filtre de la nuance adéquate pour se protéger le visage et les yeux pendant le soudage ou pour regarder (voir les normes de sécurité ANSI Z49.1 et Z87.1).
- Porter des lunettes de sécurité à écrans latéraux sous le masque.
- Utiliser des écrans ou des barrières pour protéger les tiers de l'éclat éblouissant ou aveuglant de l'arc ; leur demander de ne pas regarder l'arc.
- Porter des vêtements de protection en matière durable et ignifuge (cuir ou laine) et des chaussures de sécurité.



LE SOUDAGE peut causer un incendie ou une explosion.

Le soudage effectué sur des récipients fermés tels que des réservoirs, des fûts ou des conduites peut causer leur éclatement. Des étincelles peuvent être projetées de l'arc de soudure. La projection d'étincelles, les pièces chaudes et les équipements chauds peuvent causer des incendies et des brûlures. Le contact accidentel de l'électrode avec tout objet métallique peut causer des étincelles, une explosion, un surchauffement ou un incendie. Avant de commencer le soudage, vérifier et s'assurer que l'endroit ne présente pas de danger.

- Se protéger et protéger les tiers de la projection d'étincelles et de métal chaud.
- Ne pas souder à un endroit où des étincelles peuvent tomber sur des substances inflammables.
- Placer toutes les substances inflammables à une distance de 10,7 m de l'arc de soudage. En cas d'impossibilité, les recouvrir soigneusement avec des protections agréées.
- Des étincelles et des matières en fusion peuvent facilement passer même par des fissures et des ouvertures de petites dimensions.
- Surveiller tout déclenchement d'incendie et tenir un extincteur à proximité.
- Le soudage effectué sur un plafond, un plancher, une paroi ou une cloison peut déclencher un incendie de l'autre côté.
- Ne pas souder des récipients fermés tels que des réservoirs, des fûts ou des conduites, à moins qu'ils n'aient été préparés conformément à l'AWS F4.1 (voir les normes de sécurité).
- Brancher le câble sur la pièce le plus près possible de la zone de soudage pour éviter que le courant ne circule sur une longue distance, par des chemins inconnus, et ne cause des risques d'électrocution et d'incendie.
- Ne pas utiliser le poste de soudage pour dégeler des conduites gelées.
- En cas de non utilisation, enlever la baguette d'électrode du porte-électrode ou couper le fil au raz du tube-contact.
- Porter des vêtements de protection exempts d'huile tels que des gants en cuir, une chemise en tissu épais, des pantalons sans revers, des chaussures montantes et un masque.
- Avant de souder, retirer tout produit combustible de ses poches, tel qu'un briquet au butane ou des allumettes.

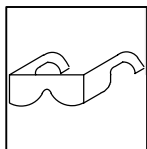

LES PARTICULES PROJETÉES peuvent blesser les yeux.

- Le soudage, le burinage, le passage de la pièce à la brosse métallique et le meulage provoquent l'émission d'étincelles et de particules métalliques. Pendant leur refroidissement, les soudures risquent de projeter du laitier.
 - Porter des lunettes de sécurité à écrans latéraux agréés, même sous le masque de soudage.



LES ACCUMULATIONS DE GAZ peuvent causer des blessures ou même la mort.

- Couper l'alimentation en gaz protecteur en cas de non utilisation.
- Veiller toujours à bien ventiler les espaces confinés ou porter un respirateur à adduction d'air agréé.



LES PIÈCES CHAUDES peuvent causer des brûlures graves.

- Ne pas toucher les pièces chaudes à main nue.
- Prévoir une période de refroidissement avant d'utiliser le pistolet ou la torche.

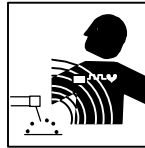

LES CHAMPS MAGNÉTIQUES peuvent perturber le fonctionnement des stimulateurs cardiaques.

- Les personnes qui portent un stimulateur cardiaque doivent se tenir à distance.
- Ils doivent consulter leur médecin avant de s'approcher d'un lieu où on exécute des opérations de soudage à l'arc, de gougeage ou de soudage par points.

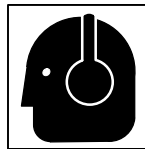

LE BRUIT peut affecter l'ouïe.

Le bruit de certains processus et équipements peut affecter l'ouïe.

- Porter des protecteurs d'oreille agréés si le niveau sonore est trop élevé.

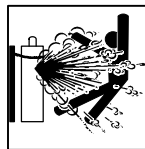

Les BOUTEILLES endommagées peuvent exploser.

Les bouteilles de gaz protecteur contiennent du gaz sous haute pression. Toute bouteille endommagée peut exploser. Comme les bouteilles de gaz font normalement partie du procédé de soudage, les manipuler avec précaution.

- Protéger les bouteilles de gaz comprimé de la chaleur excessive, des chocs mécaniques, du laitier, des flammes nues, des étincelles et des arcs.
- Placer les bouteilles debout en les fixant dans un support stationnaire ou dans un porte-bouteilles pour les empêcher de tomber ou de se renverser.
- Tenir les bouteilles éloignées des circuits de soudage ou autres circuits électriques.
- Ne jamais poser une torche de soudage sur une bouteille de gaz.
- Ne jamais mettre une électrode de soudage en contact avec une bouteille de gaz.
- Ne jamais souder une bouteille contenant du gaz sous pression – elle risquerait d'exploser.
- N'utiliser que les bouteilles de gaz protecteur, régulateurs, tuyaux et raccords adéquats pour l'application envisagée ; les maintenir en bon état, ainsi que les pièces connexes.
- Détourner la tête lorsqu'on ouvre la soupape d'une bouteille.
- Laisser le capuchon protecteur sur la soupape, sauf en cas d'utilisation ou de branchement de la bouteille
- Lire et suivre les instructions concernant les bouteilles de gaz comprimé, les équipements associés et les publications P-1 de la CGA, mentionnées dans les normes de sécurité.



Risque D'INCENDIE OU D'EXPLOSION

- Ne pas placer l'appareil sur une surface inflammable, ni au-dessus ou à proximité d'elle.
- Ne pas installer l'appareil à proximité de produits inflammables.
- Ne pas surcharger l'installation électrique – s'assurer que l'alimentation est correctement dimensionnée et protégée avant de mettre l'appareil en service.



LA CHUTE DE L'APPAREIL peut blesser.

- N'utiliser que l'anneau de levage pour lever l'appareil. NE PAS utiliser le chariot, les bouteilles de gaz ou tout autre accessoire.
- Utiliser un engin de capacité adéquate pour lever l'appareil.
- Si on utilise un chariot élévateur pour déplacer l'unité, s'assurer que les fourches sont suffisamment longues pour dépasser du côté opposé de l'appareil.

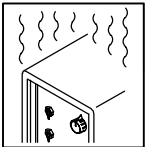

L'EMPLOI EXCESSIF peut FAIRE SURCHAUFFER L'ÉQUIPEMENT.

- Prévoir une période de refroidissement ; respecter le cycle opératoire nominal.
- Réduire le courant ou le cycle opératoire avant de reprendre le soudage.
- Ne pas obstruer les orifices ou filtrer l'alimentation en air du poste.

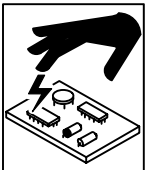

LES CHARGES ÉLECTROSTATIQUES peuvent endommager les circuits imprimés.

- Mettre un bracelet antistatique AVANT de manipuler des cartes ou des pièces.
- Utiliser des pochettes et des boîtes antistatiques pour stocker, déplacer ou expédier des cartes de circuits imprimés.



LES PIÈCES MOBILES peuvent causer des blessures.

- Se tenir à l'écart des pièces mobiles.
- Se tenir à l'écart des points de coincement tels que les dévidoirs.



LES FILS DE SOUDAGE peuvent causer des blessures.

- Ne pas appuyer sur la gâchette avant d'en avoir reçu l'instruction.
- Ne pas diriger le pistolet vers soi, vers d'autres personnes ou vers toute pièce mécanique en engageant le fil de soudage.



LES ORGANES MOBILES peuvent causer des blessures.

- Se tenir à l'écart des organes mobiles comme les ventilateurs.
- Maintenir fermés et bien fixés les portes, panneaux, recouvrements et dispositifs de protection.

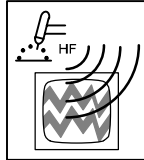

LE RAYONNEMENT HAUTE FRÉQUENCE (H. F.) risque de causer des interférences.

- Le rayonnement haute fréquence peut causer des interférences avec les équipements de radio-navigation et de communication, les services de sécurité et les ordinateurs.
- Ne demander qu'à des personnes qualifiées familiarisées avec les équipements électroniques de faire fonctionner l'installation.
- L'utilisateur est tenu de faire corriger rapidement par un électricien qualifié les interférences causées par l'installation.
- Si la Federal Communications Commission signale des interférences, arrêter immédiatement l'appareil.
- Faire régulièrement contrôler et entretenir l'installation.
- Maintenir soigneusement fermés les panneaux et les portes des sources de haute fréquence, maintenir le jeu d'éclatement au réglage adéquat et utiliser une terre et un blindage pour réduire les interférences éventuelles.

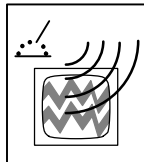

LE SOUDAGE À L'ARC peut causer des interférences.

- L'énergie électromagnétique peut causer des interférences avec l'équipement électronique sensible tel que les ordinateurs et l'équipement commandé par ordinateur tel que les robots.
- Veiller à ce que tout l'équipement de la zone de soudage soit compatible au point de vue électromagnétique.
- Pour réduire la possibilité d'interférence, maintenir les câbles de soudage aussi courts que possible, les grouper, et les poser aussi bas que possible (par ex. : à terre).
- Veiller à souder à une distance de 100 mètres de tout équipement électronique sensible.
- Veiller à ce que le poste de soudage soit posé et mis à la terre conformément au présent manuel.
- En cas d'interférences après exécution des directives précédentes, il incombe à l'utilisateur de prendre des mesures supplémentaires telles que le déplacement du poste, l'utilisation de câbles blindés, l'utilisation de filtres de ligne ou la pose de protecteurs dans la zone de travail.

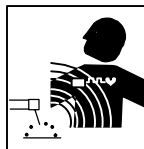

LES CHAMPS MAGNÉTIQUES peuvent affecter les stimulateurs cardiaques.

- Porteurs de stimulateur cardiaque, restez à distance.
- Les porteurs d'un stimulateur cardiaque doivent d'abord consulter leur médecin avant de s'approcher des opérations de soudage à l'arc, de gougeage ou de soudage par points.

Safety in Welding, Cutting, and Allied Processes, norme ANSI Z49.1, de l'American Welding Society, 550 N.W. LeJeune Rd, Miami FL 33126 (téléphone : (305) 443-9353, site Web : www.aws.org).

Recommended Safe Practices for the Preparation for Welding and Cutting of Containers and Piping, norme American Welding Society AWS F4.1, de l'American Welding Society, 550 N.W. LeJeune Rd, Miami, FL 33126 (téléphone : (305) 443-9353, site Web : www.aws.org).

National Electrical Code, norme NFPA 70, de la National Fire Protection Association, P.O. Box 9101, 1 Battery March Park, Quincy, MA 02269-9101 (téléphone : (617) 770-3000, sites Web : www.nfpa.org et www.sparky.org).

Safe Handling of Compressed Gases in Cylinders, brochure CGA P-1, de la Compressed Gas Association, 1735 Jefferson Davis Highway, Suite 1004, Arlington, VA 22202-4102 (téléphone : (703) 412-0900, site Web : www.cganet.com).

Code for Safety in Welding and Cutting, norme CSA W117.2, de la Canadian Standards Association, Standards Sales, 178 boulevard

Rexdale, Rexdale (Ontario) Canada M9W 1R3 (téléphone : (800) 463-6727 ou à Toronto : (416) 747-4044, site Web : www.csa-international.org).

Practice For Occupational And Educational Eye And Face Protection, norme ANSI Z87.1, de l'American National Standards Institute, 11 West 42nd Street, New York, NY 10036-8002 (téléphone : (212) 642-4900, site Web : www.ansi.org).

Standard for Fire Prevention During Welding, Cutting, and Other Hot Work, norme NFPA 51B, de la National Fire Protection Association, P.O. Box 9101, 1 Battery March Park, Quincy, MA 02269-9101 (téléphone : (617) 770-3000, site Web : www.nfpa.org et www.sparky.org).

OSHA, Occupational Safety and Health Standards for General Industry, Title 29, Code of Federal Regulations (CFR), Part 1910, Subpart Q, and Part 1926, Subpart J, de l'U.S. Government Printing Office, Superintendent of Documents, P.O. Box 371954, Pittsburgh, PA 15250 (il y a 10 bureaux régionaux - Téléphone pour la Région 5, Chicago : (312) 353-2220, site Web : www.osha.gov).

Données sur le soudage électrique et les effets des champs magnétiques basse fréquence sur l'organisme

En parcourant les câbles de soudage, le courant crée des champs électromagnétiques. Les effets potentiels de tels champs restent préoccupants. Cependant, après avoir examiné plus de 500 études qui ont été faites pendant une période de recherche de 17 ans, un comité de spécialistes du National Research Council a conclu : « L'accumulation de preuves n'a pas démontré que l'exposition aux champs magnétiques et aux champs électriques à haute fréquence constitue un risque pour la santé humaine ». Toutefois, les études et l'examen des preuves se poursuivent. En attendant les conclusions finales de la recherche, il serait souhaitable de réduire l'exposition aux champs électromagnétiques pendant le soudage ou le coupage.

Afin de réduire les champs électromagnétiques en milieu de travail, respecter les consignes suivantes :

1. Garder les câbles ensemble en les torsadant ou en les fixant avec du ruban adhésif.
2. Mettre tous les câbles du côté opposé à l'opérateur.
3. Ne pas s'enrouler les câbles autour du corps.
4. Garder le poste de soudage et les câbles le plus loin possible de soi.

5. Placer la pince de masse le plus près possible de la zone de soudage.

Consignes relatives aux stimulateurs cardiaques :

Les personnes qui portent un stimulateur cardiaque doivent avant tout consulter leur médecin. Si ce dernier les déclare aptes, il leur est recommandé de respecter les consignes ci-dessus.

Afin de réduire les champs électromagnétiques dans l'environnement de travail, respecter les consignes suivantes :

- 1 Garder les câbles ensemble en les torsadant ou en les attachant avec du ruban adhésif.
- 2 Mettre tous les câbles du côté opposé de l'opérateur.
- 3 Ne pas courber pas et ne pas entourer pas les câbles autour de votre corps.
- 4 Garder le poste de soudage et les câbles le plus loin possible de vous.
- 5 Relier la pince de masse le plus près possible de la zone de soudure.

Consignes relatives aux stimulateurs cardiaques :

Les personnes qui portent un stimulateur cardiaque doivent avant tout consulter leur docteur. Si vous êtes déclaré apte par votre docteur, il est alors recommandé de respecter les consignes ci-dessus.

SECTION 3 – DEFINITIONS

3-1. Manufacturer's Rating Label For CE Products



S/N:





For label location
see Section 4-5.





U_1 24 V \sim 1 \sim 50/60 Hz
 $I_1 = 1.0$ A IP 23



U_2 100 V $I_2 = 200$ A X 100 %
 = MILLER ELECTRIC MFG. CO., APPLETON, WI USA

178 794-A

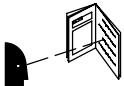
3-2. Symbols And Definitions

NOTE		<i>Some symbols are found only on CE products.</i>					
	Output	\sim	Alternating Current	A	Amperes	V	Volts
1 \sim	Single Phase	X	Duty Cycle	Hz	Hertz	IP	Degree Of Protection
	Read Instructions	%	Percent	U_1	Primary Voltage	U_2	Conventional Load Voltage
	Line Connection	I_1	Primary Current	I_2	Rated Welding Current		

SECTION 4 – INSTALLATION

4-1. Specifications

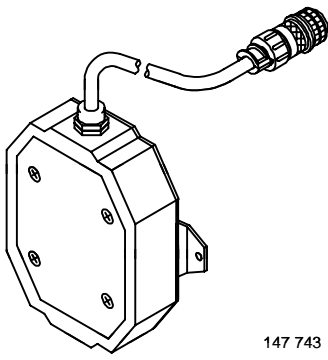
 <p>147 743</p>	Weld Control Connects Spoolmatic Gun To Constant Voltage (CV) DC Welding Power Source With Contactor For DC Gas Metal Arc Welding (GMAW)
	Provides 30 VDC Control Circuit Voltage to Gun/Feeder
	IP Rating: 23
	Receptacle For Connecting Gun/Feeder Control Cord Plug
	Dimensions: 1-3/4 in (44 mm) Long, 5-1/2 in (140 mm) Wide, 7-3/8 in (187 mm) High Center To Center Mounting Hole Spacing: 6 in (153 mm) Weight: 2 lb (0.9 kg)
24 VAC, 1A, 50/60 Hertz, Single-Phase Input Power; 5 ft (1.5 m) Long Input Power Cord And 14-Pin Plug	

4-2. Typical Process Connections

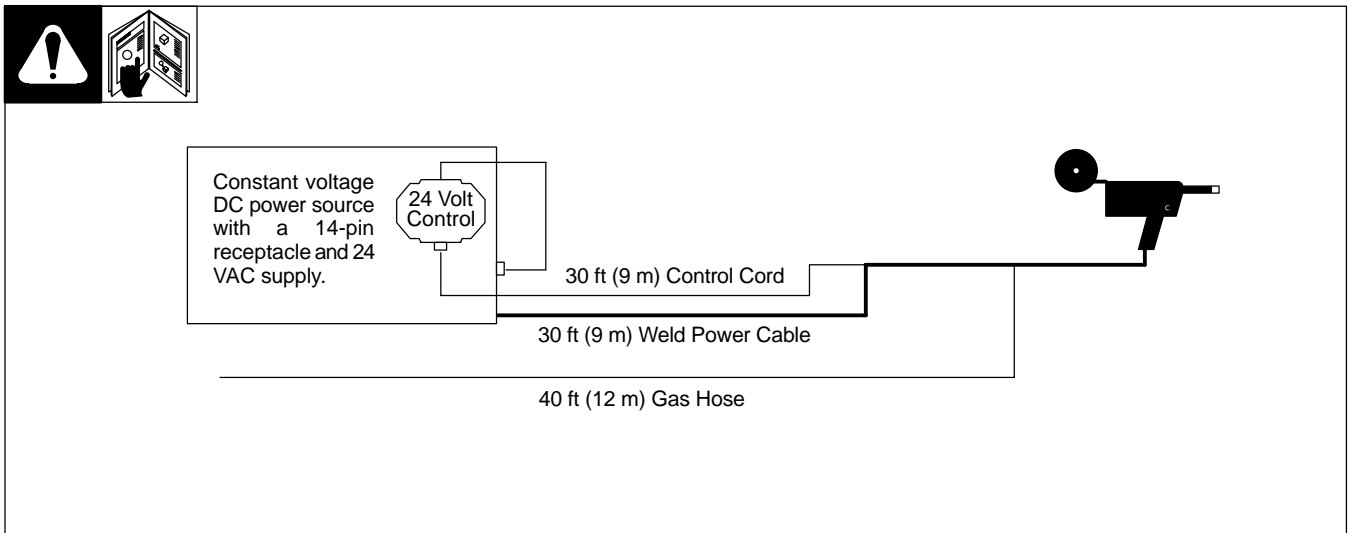



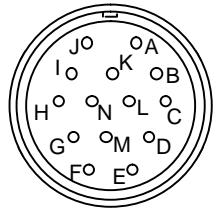



4-3. 14-Pin Plug Information

 REMOTE 14	Pin*	Pin Information
	A	Contact output signal.
	B	Input control to energize weld contactor. Contact closure to A completes 24 volts ac contactor control circuit.
	G	Circuit common for 24 volts ac circuit.



*The remaining pins are not used.

SECTION 5 – MAINTENANCE & TROUBLESHOOTING

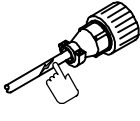
5-1. Routine Maintenance

				▲ Disconnect power before maintaining.
 3 Months				
		Replace Damaged Or Unreadable Labels		Repair Or Replace Cracked Cord

5-2. Troubleshooting

			
Trouble	Remedy		
Pressing gun trigger does not energize or feed wire.	Secure plug PLG4 in 14 pin receptacle on welding power source (see Section 4-5).		
	Secure gun plug in Gun Control receptacle RC3 on weld control (see Section 4-5).		
	See Troubleshooting Section of gun and/or welding power source Owner's Manual.		
Pressing gun trigger energizes wire, but wire does not feed.	See Troubleshooting Section of gun Owner's Manual.		
Pressing gun trigger feeds wire, but wire is not energized.	Secure plug PLG4 in 14 pin receptacle on welding power source (see Section 4-5).		
	See Troubleshooting Section of welding power source Owner's Manual.		
Wire feeds erratically.	See Troubleshooting Section of gun Owner's Manual.		
Wire burns back.	Secure plug PLG4 in 14 pin receptacle on welding power source (see Section 4-5).		
	Secure gun plug in Gun Control receptacle RC3 on weld control (see Section 4-5).		
	See Troubleshooting Section of gun and/or welding power source Owner's Manual.		

SECTION 6 – ELECTRICAL DIAGRAMS

⚠ WARNING



ELECTRIC SHOCK HAZARD

- Do not touch live electrical parts.
- Disconnect input power or stop engine before servicing.
- Do not operate with covers removed.
- Have only qualified persons install, use, or service this unit.

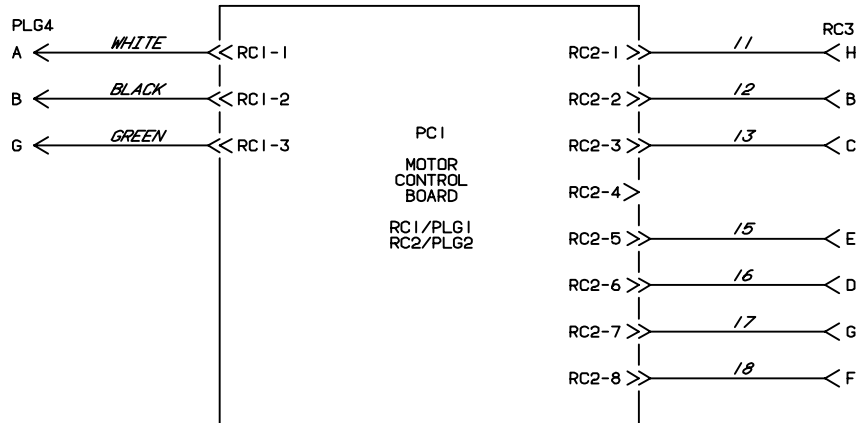

141 989

Figure 6-1. Circuit Diagram

SECTION 7 – PARTS LIST

 Hardware is common and not available unless listed.

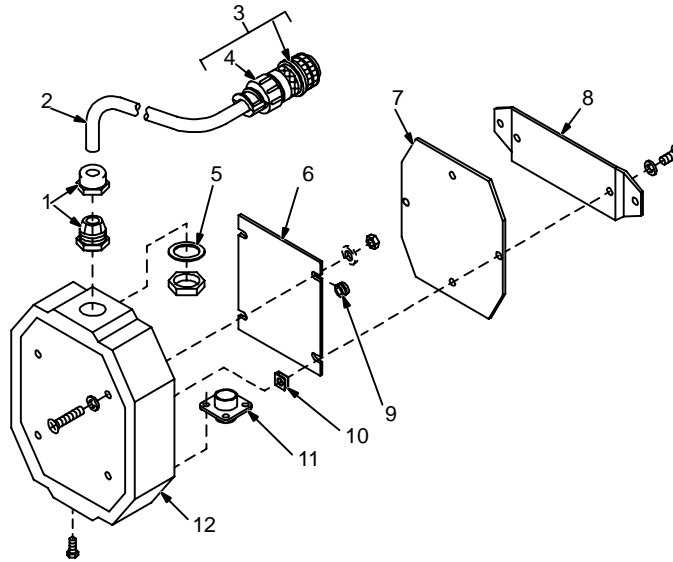

143 224-A

Figure 7-1. Complete Assembly

Item No.	Dia. Mkgs.	Part No.	Description	Quantity
Figure 7-1. WC-24 Control				
...	1	139 042	.. BUSHING, strain relief .270/.480 ID x .804mtg hole	1
...	2	600 341	.. CABLE, port No. 16 3/c (order by ft)	6ft
...	3	PLG4 141 162	.. CONNECTOR & PINS, (consisting of)	1
...	4	143 922	.. CONNECTOR, clamp str rlf sz 17-20 Amp 206070-3	1
...	5	135 736	.. WASHER, flat rbr .812 ID x 1.125 ID x .031thk	1
...	6	PC1 154 068	.. CIRCUIT CARD, SC motor	1
...	PLG1	115 094	.. CONNECTOR & SOCKETS	1
...	PLG2	115 092	.. CONNECTOR & SOCKETS	1
...	7	138 384	.. COVER, control	1
...		148 550	.. GASKET, cover	1
...	8	136 840	.. BRACKET, mtg control	1
...	9	601 242	.. INSULATOR, washer heat sink	4
...	10	135 363	.. NUT, speed push-on-type 6-32 U type	4
...	11	RC3 190 363	.. RCPT w/SKTS	1
...	12	135 370	.. HOUSING, circuit control	1

To maintain the factory original performance of your equipment, use only Manufacturer's Suggested Replacement Parts. Model and serial number required when ordering parts from your local distributor.

TRUE BLUE[®]

WARRANTY

Effective January 1, 2005

(Equipment with a serial number preface of "LF" or newer)

This limited warranty supersedes all previous Miller warranties and is exclusive with no other guarantees or warranties expressed or implied.

Warranty Questions?

Call
1-800-4-A-MILLER
for your local
Miller distributor.

Your distributor also gives
you ...

Service

You always get the fast,
reliable response you
need. Most replacement
parts can be in your
hands in 24 hours.

Support

Need fast answers to the
tough welding questions?
Contact your distributor.
The expertise of the
distributor and Miller is
there to help you, every
step of the way.

LIMITED WARRANTY – Subject to the terms and conditions below, Miller Electric Mfg. Co., Appleton, Wisconsin, warrants to its original retail purchaser that new Miller equipment sold after the effective date of this limited warranty is free of defects in material and workmanship at the time it is shipped by Miller. THIS WARRANTY IS EXPRESSLY IN LIEU OF ALL OTHER WARRANTIES, EXPRESS OR IMPLIED, INCLUDING THE WARRANTIES OF MERCHANTABILITY AND FITNESS.

Within the warranty periods listed below, Miller will repair or replace any warranted parts or components that fail due to such defects in material or workmanship. Miller must be notified in writing within thirty (30) days of such defect or failure, at which time Miller will provide instructions on the warranty claim procedures to be followed.

Miller shall honor warranty claims on warranted equipment listed below in the event of such a failure within the warranty time periods. All warranty time periods start on the date that the equipment was delivered to the original retail purchaser, or one year after the equipment is sent to a North American distributor or eighteen months after the equipment is sent to an International distributor.

- 5 Years Parts — 3 Years Labor
 - * Original main power rectifiers
 - * Inverters (input and output rectifiers only)
- 3 Years — Parts and Labor
 - * Transformer/Rectifier Power Sources
 - * Plasma Arc Cutting Power Sources
 - * Semi-Automatic and Automatic Wire Feeders
 - * Inverter Power Sources (Unless Otherwise Stated)
 - * Water Coolant Systems (Integrated)
 - * Intelligig
 - * Maxstar 150
 - * Engine Driven Welding Generators
(NOTE: Engines are warranted separately by the engine manufacturer.)
- 1 Year — Parts and Labor Unless Specified
 - * DS-2 Wire Feeder
 - * Motor Driven Guns (w/exception of Spoolmate Spoolguns)
 - * Process Controllers
 - * Positioners and Controllers
 - * Automatic Motion Devices
 - * RFCS Foot Controls
 - * Induction Heating Power Sources and Coolers
 - * Water Coolant Systems (Non-Integrated)
 - * Flowgauge and Flowmeter Regulators (No Labor)
 - * HF Units
 - * Grids
 - * Maxstar 85, 140
 - * Spot Welders
 - * Load Banks
 - * Arc Stud Power Sources & Arc Stud Guns
 - * Racks
 - * Running Gear/Trailers
 - * Plasma Cutting Torches (except APT & SAF Models)
 - * Field Options
(NOTE: Field options are covered under True Blue[®] for the remaining warranty period of the product they are installed in, or for a minimum of one year — whichever is greater.)
- 6 Months — Batteries
- 90 Days — Parts
 - * MIG Guns/TIG Torches

- * Induction Heating Coils and Blankets
- * APT & SAF Model Plasma Cutting Torches
- * Remote Controls
- * Accessory Kits
- * Replacement Parts (No labor)
- * Spoolmate Spoolguns
- * Canvas Covers

Miller's True Blue[®] Limited Warranty shall not apply to:

- Consumable components; such as contact tips, cutting nozzles, contactors, brushes, slip rings, relays or parts that fail due to normal wear. (Exception: brushes, slip rings, and relays are covered on Bobcat, Trailblazer, and Legend models.)**
- Items furnished by Miller, but manufactured by others, such as engines or trade accessories. These items are covered by the manufacturer's warranty, if any.
- Equipment that has been modified by any party other than Miller, or equipment that has been improperly installed, improperly operated or misused based upon industry standards, or equipment which has not had reasonable and necessary maintenance, or equipment which has been used for operation outside of the specifications for the equipment.

MILLER PRODUCTS ARE INTENDED FOR PURCHASE AND USE BY COMMERCIAL/INDUSTRIAL USERS AND PERSONS TRAINED AND EXPERIENCED IN THE USE AND MAINTENANCE OF WELDING EQUIPMENT.

In the event of a warranty claim covered by this warranty, the exclusive remedies shall be, at Miller's option: (1) repair; or (2) replacement; or, where authorized in writing by Miller in appropriate cases, (3) the reasonable cost of repair or replacement at an authorized Miller service station; or (4) payment of or credit for the purchase price (less reasonable depreciation based upon actual use) upon return of the goods at customer's risk and expense. Miller's option of repair or replacement will be F.O.B., Factory at Appleton, Wisconsin, or F.O.B. at a Miller authorized service facility as determined by Miller. Therefore no compensation or reimbursement for transportation costs of any kind will be allowed.

TO THE EXTENT PERMITTED BY LAW, THE REMEDIES PROVIDED HEREIN ARE THE SOLE AND EXCLUSIVE REMEDIES. IN NO EVENT SHALL MILLER BE LIABLE FOR DIRECT, INDIRECT, SPECIAL, INCIDENTAL OR CONSEQUENTIAL DAMAGES (INCLUDING LOSS OF PROFIT), WHETHER BASED ON CONTRACT, TORT OR ANY OTHER LEGAL THEORY.

ANY EXPRESS WARRANTY NOT PROVIDED HEREIN AND ANY IMPLIED WARRANTY, GUARANTY OR REPRESENTATION AS TO PERFORMANCE, AND ANY REMEDY FOR BREACH OF CONTRACT TORT OR ANY OTHER LEGAL THEORY WHICH, BUT FOR THIS PROVISION, MIGHT ARISE BY IMPLICATION, OPERATION OF LAW, CUSTOM OF TRADE OR COURSE OF DEALING, INCLUDING ANY IMPLIED WARRANTY OF MERCHANTABILITY OR FITNESS FOR PARTICULAR PURPOSE, WITH RESPECT TO ANY AND ALL EQUIPMENT FURNISHED BY MILLER IS EXCLUDED AND DISCLAIMED BY MILLER.

Some states in the U.S.A. do not allow limitations of how long an implied warranty lasts, or the exclusion of incidental, indirect, special or consequential damages, so the above limitation or exclusion may not apply to you. This warranty provides specific legal rights, and other rights may be available, but may vary from state to state.

In Canada, legislation in some provinces provides for certain additional warranties or remedies other than as stated herein, and to the extent that they may not be waived, the limitations and exclusions set out above may not apply. This Limited Warranty provides specific legal rights, and other rights may be available, but may vary from province to province.





Owner's Record

Please complete and retain with your personal records.

Model Name	Serial/Style Number
Purchase Date	(Date which equipment was delivered to original customer.)
Distributor	
Address	
City	
State	Zip



For Service

Contact a **DISTRIBUTOR** or **SERVICE AGENCY** near you.

Always provide Model Name and Serial/Style Number.

Contact your Distributor for:	Welding Supplies and Consumables
	Options and Accessories
	Personal Safety Equipment
	Service and Repair
	Replacement Parts
	Training (Schools, Videos, Books)
	Technical Manuals (Servicing Information and Parts)
	Circuit Diagrams
	Welding Process Handbooks
	To locate a Distributor or Service Agency visit www.millerwelds.com or call 1-800-4-A-Miller

Contact the Delivering Carrier to:	File a claim for loss or damage during shipment.
	For assistance in filing or settling claims, contact your distributor and/or equipment manufacturer's Transportation Department.

Miller Electric Mfg. Co.

An Illinois Tool Works Company
1635 West Spencer Street
Appleton, WI 54914 USA

International Headquarters—USA

USA Phone: 920-735-4505 Auto-Attended
USA & Canada FAX: 920-735-4134
International FAX: 920-735-4125

European Headquarters – United Kingdom

Phone: 44 (0) 1204-593493
FAX: 44 (0) 1204-598066

www.MillerWelds.com



Free Manuals Download Website

<http://myh66.com>

<http://usermanuals.us>

<http://www.somanuals.com>

<http://www.4manuals.cc>

<http://www.manual-lib.com>

<http://www.404manual.com>

<http://www.luxmanual.com>

<http://aubethermostatmanual.com>

Golf course search by state

<http://golfingnear.com>

Email search by domain

<http://emailbydomain.com>

Auto manuals search

<http://auto.somanuals.com>

TV manuals search

<http://tv.somanuals.com>