

Big Blue® Air Pak™

Issued October 2008 • Index No. ED/10.5

Engine-Driven Welder/
AC Generator/Air Compressor 

Quick Specs



Heavy Industrial Applications

Railroad Maintenance
Mining Maintenance
Maintenance and Repair Rigs

Processes

Stick (SMAW)
MIG (GMAW)
Flux Cored (FCAW)
Submerged Arc (SAW)
AC TIG (GTAW)*
DC TIG (GTAW)

Stud Welding — 1/2 in (12.7 mm)

Air Plasma Cutting
with Optional Spectrum Models

Air Carbon Arc (CAC-A)
1/2 in (12.7 mm) Carbons

Battery Charging/Jump-Starting*
Air Compressor

Output Range

DC Stick 45–750 A MIG/FCAW 14–40 V
DC TIG 20–450 A AC 20–575 A*
Battery Charge 12/24 V, 50–750 A*

*Deluxe Model Only.

Weld Output Rated at 104°F (40°C)

Stick 600 A, 44 V, 26.4 kW, 40% Duty Cycle
Stick 550 A, 42 V, 23.1 kW, 60% Duty Cycle
MIG/FCAW 500 A, 40 V, 20 kW, 100% Duty Cycle
AC TIG 400 A, 26 V, 10.4 kW, 100% Duty Cycle*

Air Compressor 100 PSI, 60 CFM, 100% Duty Cycle

Generator Output Rated at 104°F (40°C)

5,500 Watts Peak — 4,000 Watts Continuous
20,000 Watts 3-Phase/12,000 Watts 1-Phase
Continuous*

**Accu-Rated™—Not Inflated
Generator Power**

The Power of Blue.®

Welder/generator/air compressor.

One machine that will do it all. Designed and built to be the most reliable high-output system in the world.

 **Ingersoll Rand® ultra-reliable industrial rotary screw air compressor.** Belt-driven with automatic belt tensioner with a life expectancy of 30,000 hrs.

Independent compressor controls. On/off switch for applications not requiring compressed air. At **idle speed** will produce 100 PSI at 40 CFM.

Weatherproof Lexan® nameplate resists cracking and fading, and is color-coded for ease of operation.

Enclosed robust case design protects internal components from impact and allows air flow to cool and prolong the life of the engine. Also reduces sound levels.

GFCI receptacle as required on most job sites to protect operators from electrical hazards.

Low maintenance with easy single-side access to engine and 500 hour oil changes for both engine and compressor.

Quiet at only 70 dB (95 Lwa) when idle, 79 dB (104 Lwa) at maximum output. Improves work site communications.

BUILT TOUGH



turbocharged four-cylinder diesel engine provides ample power at high altitudes.

Improved!

Maintenance Displays!



NEW! Meter maintenance display

- Hour meter function
- Oil Change interval
- Diesel: High coolant temperature and low oil pressure shutdowns
- Diesel: Low fuel shutdown — engine shuts down before system runs out of fuel making restarts easy

Hot Start™ provides positive stick electrode starts to make it easy to start all types of electrodes.

Arc-Drive makes welding easy. Automatically enhances Stick welding, especially on pipe, by focusing the arc and preventing the electrode from going out.

Optional AC/DC/battery charge/jump-start for AC TIG welding and 12 or 24 volt batteries. Simply select the battery voltage and connect cables to the separate battery output studs.

(High-frequency unit required for AC TIG.)

TRUE BLUE®

3YR. WARRANTY

Welder/Generator/Air Compressor is warranted by Miller for 3 years, parts and labor.
Engine is warranted by Deutz for 3 years.

MADE IN **USA**
APPLETON, WI



Miller Electric Mfg. Co.
An Illinois Tool Works Company
1635 West Spencer Street
Appleton, WI 54914 USA

International Headquarters
Phone: 920-735-4505
USA FAX: 920-735-4134
Canadian FAX: 920-735-4169
International FAX: 920-735-4125

Web Site
www.MillerWelds.com



Specifications (Subject to change without notice.)



Welding Mode	Weld Output Range	Weld Output Rated at 104° F (40° C) NEMA Amperage and Voltage	Max. Open-Circuit Voltage	Generator Output Rated at 104° F (40° C)	Dimensions**	Weight Without Fuel***
CC/DC	20–750 A	600 A, 44 V, 26.4 kW, 40% Duty Cycle 550 A, 42 V, 23.1 kW, 60% Duty Cycle 500 A, 40 V, 20 kW, 100% Duty Cycle	95	Peak: 5500 watts Continuous: 4000 watts, 120/240 VAC, 34/17 A, 60 Hz while welding	H: 43 in (1092 mm) W: 28-1/2 in (724 mm) D: 67-1/2 in (1715 mm)	Net: 1931 lb (876 kg) Ship: 1982 lb (899 kg)
CV/DC	14–40 V	500 A, 40 V, 20 kW, 100% Duty Cycle	56			
CC/AC*	20–575 A	400 A, 36 V, 14.4 kW 100% Duty Cycle	64	Optional kW 3-phase, 20 kW, 36 A, 240 VAC 1-phase, 12 kW, 50 A, 120/240 VAC while not welding		Deluxe Model Net: 1956 lb (887 kg) Ship: 2007 lb (910 kg)
Battery* Charge Jump-Start	12/24 V	750 A, 12 V, Jump-Start 750 A, 24 V, Jump-Start	14/28			

Meets NEMA and IEC output ratings. *Only available on deluxe model. **Additional 7 in (178 mm) to top of exhaust. ***Additional 190 lb (86 kg) when fuel tank is full.

CSA approved.

Engine

Engine Brand	Features	HP	Type	Engine Speeds	Fuel Capacity	Oil Capacity	Automatic Engine Shutdowns
 Deutz, BF4M 2011 Diesel TD2011L04w	Tier IVi, EPA-certified, turbocharged direct-injected, liquid-cooled (oil) engine. Right side service access with 500 hr intervals for oil and filters. MSHA approved with purchase of certificate from Deutz dealer.	63.4	Four-cylinder, industrial, liquid-cooled engine	1850 Run 1235 Idle	25 gal (95 L)	11 qt (10.4 L)	Oil pressure Oil temperature

Air Compressor

Compressor Brand	Features	Free Air Delivery at 1850 RPM	Free Air Delivery at 1235 RPM	Working Pressure Constant	Duty Cycle	Oil Capacity	Automatic Compressor Shutdowns
 Ingersoll-Rand CE55 G1	Rotary screw with electric clutch for on/off. Oil change intervals 500 hrs (same as engine). Life expectancy 30,000 hrs.	60 cfm (1.70 m ³ /min)	40 cfm (1.13 m ³ /min) Idle	100 psig 7 bar	100%	5 qt (4.7 L)	Oil temperature

Control Panel

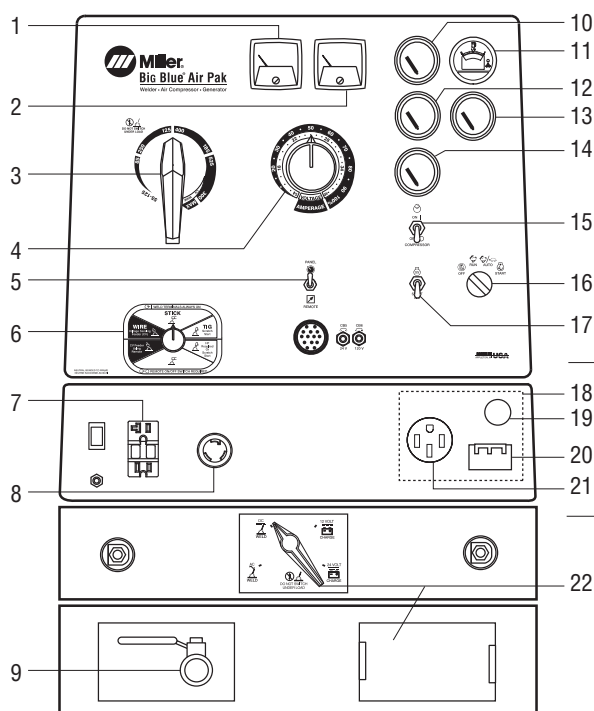

1. AC/DC Voltmeter*
2. AC/DC Ammeter*
3. Amperage Range Switch
4. Amperage/Voltage Adjust Control
5. Amperage/Voltage Adjust Switch and Remote Amperage/Voltage Adjust 14-Pin Receptacle
6. Process/Contactor Selector Switch
7. 120 VAC, 20 A GFCI Duplex Receptacle
8. 240 VAC, 30 A TwistLock Receptacle (NEMA L6-30)
9. Air Outlet Valve 3/4 in NPT
10. Engine Oil Pressure Gauge
11. Fuel Gauge—displays engine hours and oil change intervals
12. Engine Coolant Temperature Gauge
13. Battery Voltmeter
14. Air Compressor Pressure Gauge
15. Air Compressor On/Off Switch
16. Engine Control Switch
17. Starting Aid Switch*
18. 20 kW, 3-Phase Generator*
19. Strain Relief*
20. 50 A, 3-Phase Circuit Breaker*
21. 50 A, 1-Phase 120/240 V Receptacle (NEMA 14-50)*
22. AC/DC/Battery Charge/Jump-Start Switch*
23. International Model—240 VAC, 16 A Pin and Sleeve Receptacle

*On Select Models

International Model

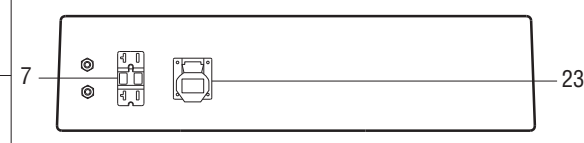

Performance Data

FUEL CONSUMPTION CURVE

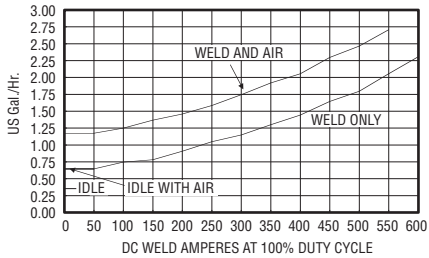

GENERATOR POWER CURVE OPTION

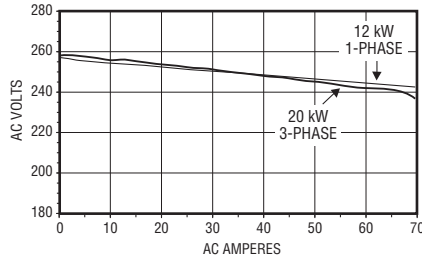

Ingersoll-Rand Rotary Screw Air Compressor

This industrial grade compressor, has a life expectancy of 30,000 hours, is belt driven and utilizes an electric clutch control to allow the compressor to be turned off if not needed. This design increases efficiency, reduces fuel consumption and saves you money at the pump. An automatic belt tensioner provides proper belt tension even after years of service. The compressor is protected by a high temperature shutdown switch.

AIR SUPPLY CURVE

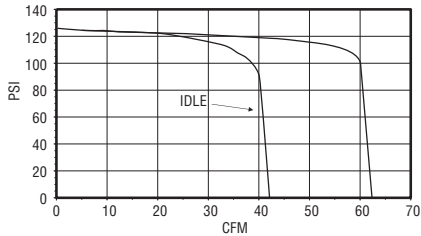

VOLT/AMP CURVE – STICK MODE

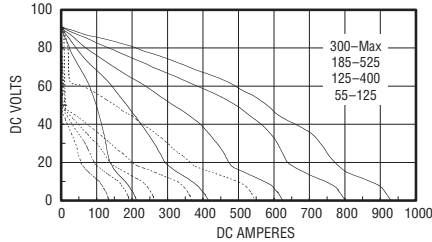

VOLT/AMP CURVE – MIG MODE

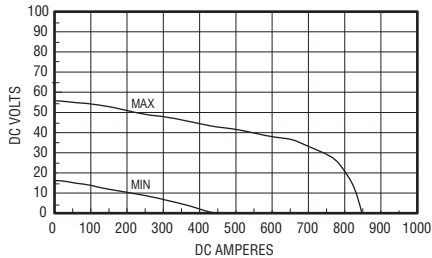

VOLT/AMP CURVE – DC TIG MODE

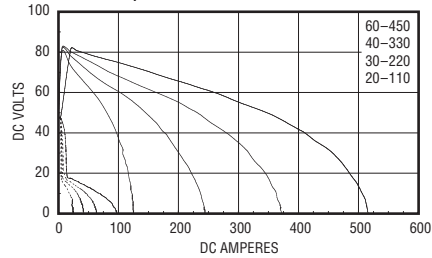

VOLT/AMP CURVE – AC TIG MODE

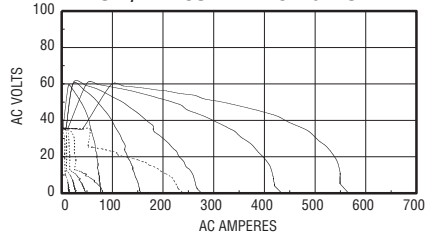

BATTERY CHARGE OUTPUT

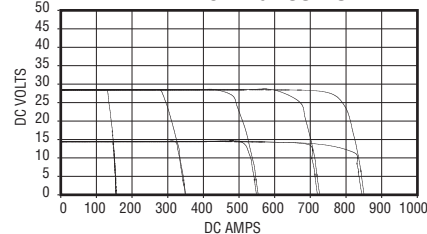

Toolless Generator Brushes

100% copper-wound generator features quick and easy brush and slip ring inspection. Brushes can be removed and/or replaced in a matter of seconds.

Brushes can be removed and/or replaced in a matter of seconds.

The Vault

Superior Circuit Board Design

Miller's critical circuit boards are engineered to carry *low power* and *low heat* to reduce thermal stress and minimize expansion and contraction. In contrast, our competitor's boards carry *high power* and *high heat*, making them more vulnerable to failure.

"The Vault" Makes Upgrading to Miller CC/CV Units Worry-Free

Concerns with circuit board reliability have resulted in some operators steering clear of CC/CV welder/generators — even though they

offer a superior arc and multiple welding processes. Miller's circuit board reliability isn't a concern since all PRO 300 and Big Blue multiprocess industrial engine drives feature the Vault.

Created out of two aluminum halves sealed with silicone, as well as watertight harness connections, the Vault provides a clean circuit board environment, protecting the electronics — and controlling output — in heavy industrial applications. No other competitor protects their electronics with a sealed vault, leaving critical



circuit boards exposed to harsh elements that can disrupt the machine's electronics, and therefore, its operation.



Field Kit Accessories

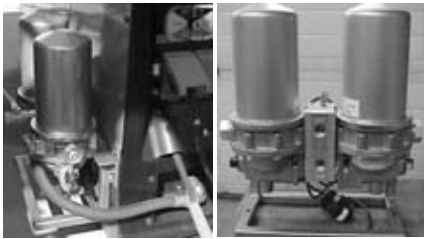

Desiccant Air Dryer System #195 117

A regenerating inline air dryer system that eliminates moisture in the air stream to prevent air tool freeze-ups in cold climates. Internal thermostat and heating elements insure good air quality in all climates. The system can be mounted on the side of the machine or remotely for truck mount installations.

AC/DC/Battery Charge/Jump-Start Switch #195 148 Field

AC TIG welding and 12/24 V battery charge/jump-starting system.



FA-1D Lockable Flame Arrestor Fuel Cap #043 947

Fuel cap can be padlocked to prevent vandalism. A built-in flame arrestor prevents flames or sparks from entering the fuel tank.

Cold Weather Starting Aids*

#043 959 Field 12 V intake manifold heater.

#195 086 Field 120 V oil pan heater element.

*Note: for extreme cold weather both starting aids can be used in conjunction.

Weld Ammeter and Voltmeter

#195 131 Field

Panel-mounted AC/DC analog meters to monitor weld output.



Vandalism Lockout Kit

#195 118 Field Lockable hinged steel panels cover and protect name plate gauges and ignition switch (padlock included). Also includes engine compartment door lock and key.



Cable Holder #043 946

Saddle-bag-style cable holder. Convenient wrap-around storage of coiled cable for transportation. Stores 100 ft of 2/0 cable on each side.

Note: For best results do not weld when cable is coiled! Canvas cover cannot be used with cable holder.



Battery Lockout/Tagout Disconnect Switch #195 120 Field

Lockable battery disconnect switch for safe routine maintenance.

Stick (SMAW) Welding

Weld Leads

#173 851 2/0, 350 A, 100% duty cycle, 50 ft stinger, 50 ft work cable

#043 952 2/0, 300 A, 100% duty cycle, 100 ft stinger, 50 ft work cable

Plasma Cutting



Spectrum® 375 X-TREME™ #907 303

Spectrum® 375 X-TREME™ with X-CASE™

#907 339 (not shown)

See Lit. Index No. PC/9.2.

Spectrum® 625 #907 058

See Lit. Index No. PC/9.5.

Spectrum 2050 #903 777-01-2

See Lit. Index No. PC/7.0.

MIG/Flux Cored Welding



Millermatic® Passport® Plus #907 401

Portable, all-in-one MIG package features ultimate arc performance, self-contained gas bottle, and flexibility to plug into 115 or 230 V power with Miller exclusive Multi-Voltage Plug. See Lit. Index No. DC/12.53.



SuitCase™ X-TREME™ 8VS

Wire Feeder #300 093

SuitCase™ X-TREME™ 12VS

Wire Feeder #195 500

Lightweight, portable, voltage-sensing wire feeders include secondary contactor and gas valve. Require drive roll kit. See Lit. Index No. M/6.41.

MIG/Flux Cored Welding (continued)



SuitCase™ 8RC Wire Feeder #194 938 SuitCase™ 12RC Wire Feeder #194 940

Lightweight, modular design and flexible enough to run a variety of wires up to 5/64 in diameter. Comes standard with remote voltage control. See Lit. Index No. M/6.5.



S-32SL Wire Feeder #109 294

Simple to use, but with all the features needed for heavy-duty applications up to 7/64 in wire diameter. See Lit. Index No. M/6.21.



Spoolmatic® 30A Spool Gun #130 831

Air-cooled, 200-amp, 1-lb spool gun for aluminum MIG. See Lit. Index No. M/1.73.

WC-24 Control #137 549

Use with Spoolmatic 30A.

XR™ Wire Feeders and Guns

Push-pull system designed to handle difficult-to-feed soft alloy wires such as aluminum. See Lit. Index No. M/1.7, M/1.71, and M/1.73.

TIG (GTAW) Welding



Dynasty® 200 Series

For premium portable AC/DC TIG arc quality. See Lit. Index No. AD/4.8.



HF-251 Series #042 388

HF-251D-1, 115 VAC
High-frequency arc starter and stabilizer. See Accessory Lit. Index No. AY/5.0.

Remote Controls



RHC-14 Hand Control #129 340

Miniature hand control for remote current and contactor control. Dimensions: 4 x 4 x 3-1/4 in (102 x 102 x 82 mm). Includes 20 ft (6 m) cord and 14-pin plug.



RFCS-14 HD Foot Control #194 744

Heavy-duty foot current and contactor control. Includes 20 ft (6 m) cord and 14-pin plug.



RMLS-14 #129 337

14-pin plug Momentary- and maintained-contact rocker switch for contactor control. Push forward for maintained contact and back for momentary contact. Includes 20 ft (6 m) cord.



RCC-14 Remote Contactor and Current Control #151 086 14-pin plug Rotary-motion fingertip control fastens to TIG torch using two Velcro® straps. Includes 28 ft (8.5 m) control cord.

Extension Cords for 14-Pin Remote Controls

#122 973 25 ft (7.6 m)

#122 974 50 ft (15.2 m)

#122 975 75 ft (23 m)

Trailers and Hitches (Note: Trailers are shipped unassembled.)



HWY-224 Trailer #043 805 For highway use.
OFR-224 Trailer #043 802 For off-road use. A 2650 lb (1202 kg) capacity trailer. Welded steel tubing frame, heavy-duty axle with roller bearing hubs and leaf-spring suspension. Includes jack stand, 2 in (50 mm) ball hitch. *HWY-224 also includes fenders and lights.*

Note: Trailer is shipped unassembled.

Cable Tree #043 826

Provides an area to conveniently wrap weld cables and extension cords.

Lunette Eye 2-1/2 in (64 mm) #043 824

HWY-430 Tandem Axle Trailer #043 806

Smooth riding with 3750 lb (1701 kg) capacity. Includes hand-operated parking brake, hydraulic brake system, and a break-away device to lock brakes if the trailer comes loose. Includes jack stand, fenders and lights. (Hitch must be ordered separately.)

Note: Some assembly required.

Cable Tree #043 826

Provides an area to conveniently wrap weld cables and extension cords.

Ball Hitch 2 in (50 mm) #043 864

Lunette Eye 3 in (76 mm) #043 863

4 West Four-Wheel Steerable Off-Road Trailer #042 801

A heavy-duty 2570 lb (1166 kg) capacity trailer designed for use in mines, quarries, and other rough terrain. Has narrow 22 ft (6.7 m) turning radius. Includes 3 in lunette eye, universal hitch and safety chains.

Note: Trailer is shipped unassembled.

Trailer Specifications (Subject to change without notice.)

Model	Gross Axle Weight Rating	Gross Vehicle Weight Rating	Net Payload	Height of Bed	Road Clearance	Track (Center to center of tires)	Standard Tires (Standard rating or P-size rating)	Dimensions	Net Weight
4 West	2000 lb/axle (907 kg/axle)	3000 lb (1361 kg)	2570 lb (1166 kg)	21-1/4 in (540 mm)	8 in (203 mm)	55-1/4 in (1403 mm)	B78-13	Length: 91 in (2311 mm)** Width: 61-1/4 in (1556 mm)	430 lb (195 kg)
HWY-224 OFR-224	3500 lb (1588 kg)	2960 lb (1343 kg)	2650 lb (1202 kg)	18-1/2 in (470 mm)	7-1/2 in (191 mm)	52 in (1321 mm)	B78-13B	Length: 122-1/2 in (3112 mm) Width: HWY-61 in (1549 mm)* OFR-58-1/2 in (1486 mm)	355 lb (161 kg)
HWY-430	2200 lb/axle (998 kg/axle)	4280 lb (1941 kg)	3750 lb (1701 kg)	19-1/4 in (489 mm)	8-1/2 in (216 mm)	52 in (1321 mm)	B78-13B	Length: 156-1/2 in (3975 mm) Width: 61 in (1549 mm)*	530 lb (240 kg)

*Width at outside of fenders.

**Does not include tongue.

Mounting Specifications

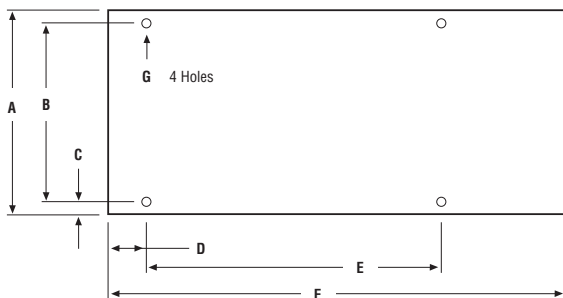

- A. 20 in (508 mm)
- B. 16-1/2 in (419 mm)
- C. 1-3/4 in (44 mm)
- D. 6-1/16 in (154 mm)
- E. 32-3/4 in (832 mm)
- F. 45-3/8 in (1153 mm) (Gas)
52 in (1321 mm) (Diesel)
- G. 13/32 in (10 mm) diameter

Height: (to top of exhaust)

- 33 in (838 mm) (Gas)
- 34-1/4 in (870 mm) (Diesel)

Width: 20 in (508 mm)

- Depth:** 45-7/8 in (1164 mm) (Gas)
- 52-1/2 in (1334 mm) (Diesel)

Typical Installations



Stick (SMAW) Basic Equipment

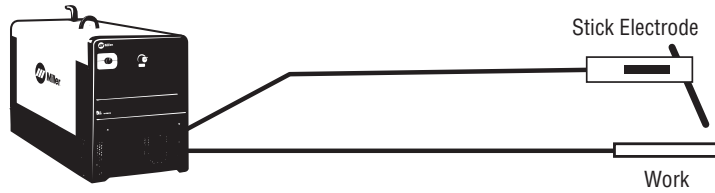

Flux-Cored (FCAW) Basic Equipment

SuitCase™ X-TREME™ 8VS #300 093
 SuitCase™ X-TREME™ 12VS #195 500

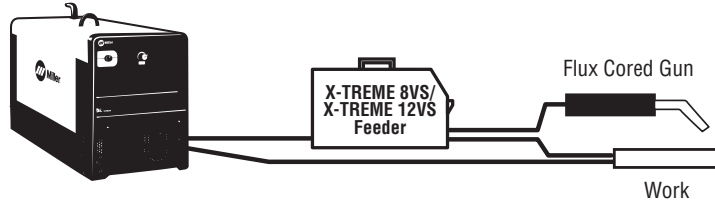

MIG (GMAW) Basic Equipment

SuitCase™ 8RC #194 938
 SuitCase™ 12RC #194 940

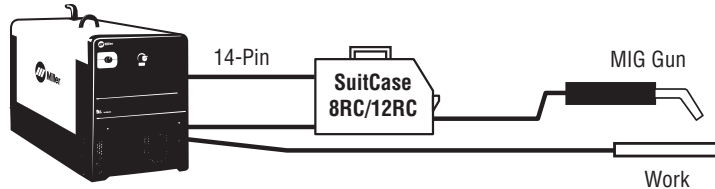

Aluminum MIG (GMAW) Basic Equipment

Spoolmatic® 30A #130 831
 WC-24 #137 549

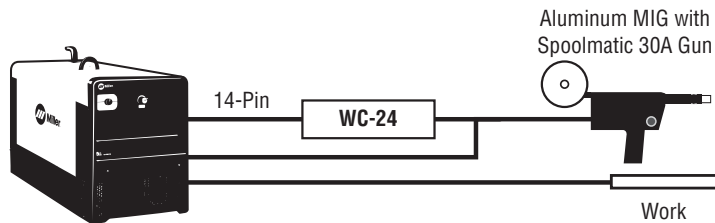

TIG (GTAW) Basic Equipment

Dynasty® 200 Series
 HF-251D-1 #042 388*
 *TIG power cable adapter required

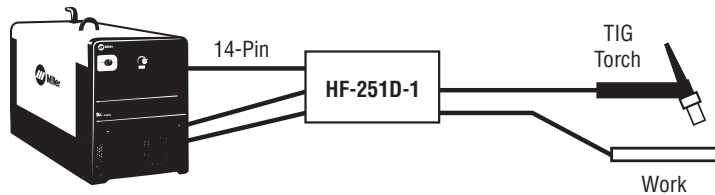

Plasma Basic Equipment

Spectrum® 375 X-TREME™ #907 303
 Spectrum® 375 X-TREME™ with X-CASE™ #907 339
 Spectrum® 625 #907 058
 Spectrum® 2050 #903 777-01-2

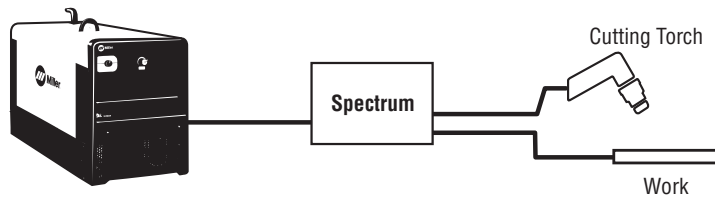

Ordering Information

Equipment and Factory Options	Stock No.	Description	Qty.	Price
Big Blue® Air Pak™ CC/CV Base Model International Model Cold Weather Model Deluxe Model	#907 062	Automatic Idle, Engine Gauges, 5.5 kW AC Generator		
	#907 062-01-1	50/60 Hz, Dry Battery, Automatic Idle, Engine Gauges, 5.5 kW AC Generator		
	#907 062-04-1	Automatic Idle, Engine Gauges, 5.5 kW AC Generator, Weld Meters, Battery Lockout/Tagout Disconnect Switch, 12 V Intake Manifold Heater, 120 V Oil Pan Heater		
	#907 062-07-1	Automatic Idle, Engine Gauges, 5.5 kW AC Generator, Weld Meters, Battery Lockout/Tagout Disconnect Switch, 12 V Intake Manifold Heater, 120 V Oil Pan Heater, Vandalism Lockout Kit, 20 kW Generator, AC/DC/Battery Charge/Jump-Start Switch		
Field Kit Accessories				
Weld Ammeter and Voltmeter Kit	#195 131	AC/DC analog weld output meters		
Lockable Fuel Cap Flame Arrestor	#043 947	Padlock not included		
Cold Weather Starting Aids	#043 959	12 volt intake manifold heater		
	#195 086	120 volt oil pan heater		
Desiccant Air Dryer System	#195 117	Removes moisture from air supply		
Vandalism Lockout Kit	#195 118	Lockable front control panel and engine compartment		
Battery Lockout/Tagout Disconnect Switch	#195 120	Allows machine battery to be disconnected and locked		
AC/DC/Battery Charge/Jump-Start Switch	#195 148	Field		
Cable Holder	#043 946	Stores up to 200 ft of 2/0 weld cable		
Protective Cover	#195 159	Will not fit over machine with cable holder attached		
Stick Accessories				
Welding Leads	#173 851	2/0, 350 A, 100% Duty Cycle, 50 ft stinger, 50 ft work clamp		
	#043 952	2/0, 300 A, 100% Duty Cycle, 100 ft stinger, 50 ft work clamp		
Plasma Cutters				
Spectrum® Plasma Cutter		See page 4		
Wire Feeders				
SuitCase™ X-TREME™ 8VS	#300 093	Includes contactor and gas valve. See Lit. Index No. M/6.41		
SuitCase™ X-TREME™ 12VS	#195 500	Includes contactor and gas valve. See Lit Index No. M/6.41		
SuitCase™ 8RC	#194 938	See Lit Index No. M/6.5		
SuitCase™ 12RC	#194 940	See Lit Index No. M/6.5		
S-32SL Wire Feeder	#109 294	See Lit. Index No. M/6.21		
Spoolmatic® 30A Spool Gun	#130 831	Requires WC-24 Control. See Lit. Index No. M/1.73		
Guns and Consumables		See Lit. Index No. M/10.0 and M/13.4		
TIG Accessories				
HF-251D-1	#042 388	High frequency unit for AC TIG welding		
Water Coolant System		See Lit. Index No. AY/7.2		
TIG Torch, Consumables				
Remote Controls				
RHC-14	#129 340	Hand control		
RFCS-14 HD	#194 744	Foot control		
RMLS-14	#129 337	Momentary and maintained contact switch		
RCC-14	#151 086	Fingertip control		
Extension Cords	#122 973	25 ft (7.6 m)		
	#122 974	50 ft (15.2 m)		
	#122 975	75 ft (22.9 m)		
Trailers and Hitches				
HWY-224 Trailer	#043 805	Highway trailer with 2650 lb (1202 kg) capacity		
OFR-224 Trailer	#043 802	Off-road trailer with 2650 lb (1202 kg) capacity		
HWY-430 Tandem Axle Trailer	#043 806	Highway trailer with 3750 lb (1701 kg) capacity.		
4-West Trailer	#042 801	Off-road steerable trailer with 2570 (1166 kg) capacity		
Lunette Eye	#043 824	2-1/2 in (64 mm). For 224 trailers only		
	#043 863	3 in (76 mm). For 430 trailer only		
Ball Hitch	#043 864	2 in (51 mm). For 430 trailer only		
Clevis	#043 823	For 430 trailer only		
Cable Tree	#043 826	Works on 224 and 430 trailers		

Date:

Total Quoted Price:

Distributed by:



Free Manuals Download Website

<http://myh66.com>

<http://usermanuals.us>

<http://www.somanuals.com>

<http://www.4manuals.cc>

<http://www.manual-lib.com>

<http://www.404manual.com>

<http://www.luxmanual.com>

<http://aubethermostatmanual.com>

Golf course search by state

<http://golfingnear.com>

Email search by domain

<http://emailbydomain.com>

Auto manuals search

<http://auto.somanuals.com>

TV manuals search

<http://tv.somanuals.com>