

Minelab Sovereign XS-2a Pro with BBS Technology

Multiple Frequency Treasure Hunting

Sovereign XS-2a Pro

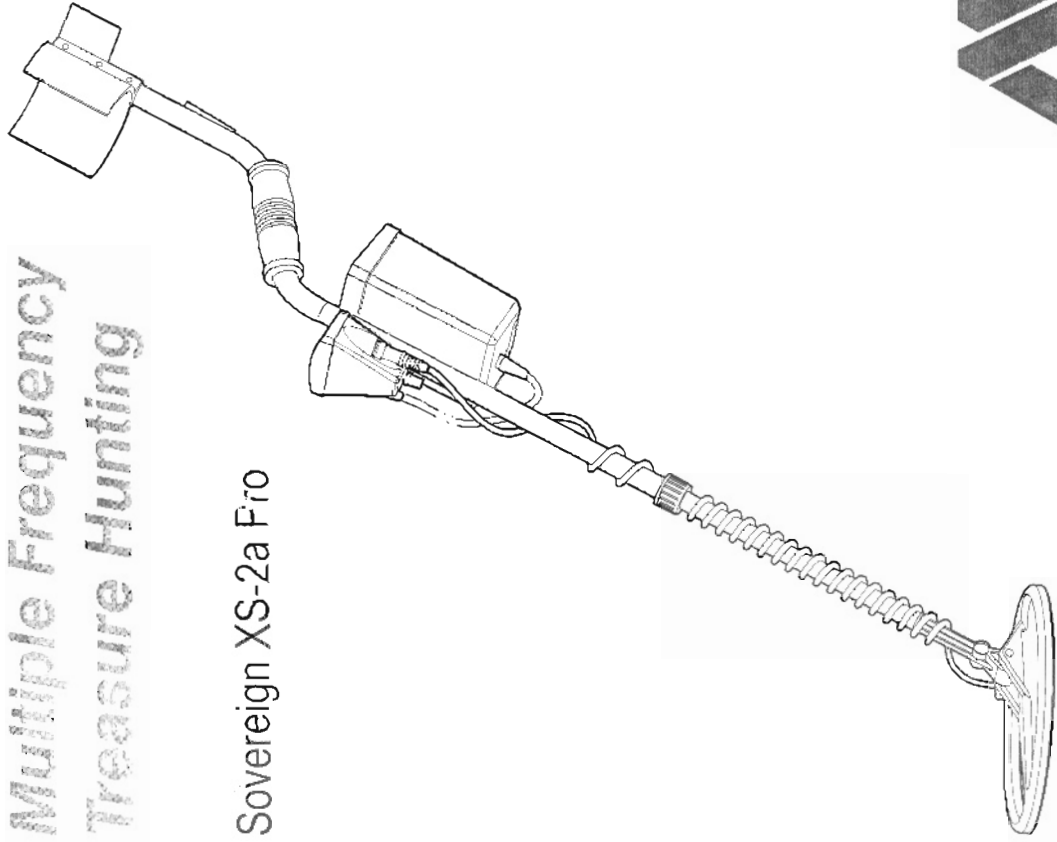

MINELAB ELECTRONICS PTY LTD

118 Hayward Avenue, Torrensville, SA 5031, Australia
PO Box 537, Torrensville Plaza, SA 5031, Australia
Telephone: +618 8238 0888
Facsimile: +618 8238 0890
Email: ho@minelab.com.au

MINELAB INTERNATIONAL LTD

Maragh, Bandon
County Cork, Ireland
Telephone: +353 23 52101
Facsimile: +353 23 52106
Email: minelab@minelab.ie

MINELAB USA INC

2700 E. Patrick Lane, Suite 11
Las Vegas, Nevada 89120, USA
Telephone: +1 702 891 8809
Facsimile: +1 702 891 8810
Email: minelab@minelabusa.com

www.minelab.com.au



4901-0034

1. Introduction

Congratulations on purchasing Minelab's Sovereign XS-2a Pro detector. The Sovereign XS-2a Pro metal detector has been designed for general purpose treasure hunting and is an upgrade to the highly successful Sovereign Extra Sensitive detector which was voted America's "Detector of the Year 1997" by Treasure Hunter's Gazette.

Sovereign XS-2a Pro detectors use Minelab's unique new **Broad Band Spectrum (BBS) technology**, which enables the Sovereign XS-2a Pro to automatically transmit at 17 individual frequencies at the same time.

The benefits of multiple frequency technology are numerous and include increased depth, greater sensitivity to non-ferrous metal objects, increased accuracy in discrimination, increased accuracy in target indication and increased stability under most ground conditions.

Sovereign XS-2a Pro detectors are designed to locate valuable metal objects in high trash areas and in areas of either extreme salt or ground mineralisation, conditions which are commonly encountered by treasure hunters around the world. When using a single or dual-frequency detector under these conditions, a treasure hunter may experience a significant loss of detection depth and discrimination accuracy. However, the Sovereign XS-2a Pro, with its 17 individual frequencies, compensates for interference from these ground conditions and enables you to penetrate deeply and discriminate accurately at full depth.

Sovereign XS-2a Pro detectors are simple to operate, having very few controls that require adjustment after they have been set. The extremely advanced, yet simple-to-use discrimination features enable you to accurately select only the types of metal objects that you want to find and to ignore the rest. The variable signal tone responses enable you to accurately identify the object found before you recover it.

If you have any questions or comments regarding the Sovereign XS-2a Pro or any other Minelab product, then please feel free to contact us via your local Authorised Minelab Dealer or write to us direct.

Minelab wish you every success in your treasure hunting.

The Minelab Sovereign XS-2a Pro Instruction Manual

2. BBS Technology

When developing BBS technology, Minelab's scientists first looked at technology that was already available in the market and identified its limitations in field use. Discussions with seasoned treasure hunters from around the world identified a number of common problems facing detector operators. These problems included:

- Loss of detection depth in highly mineralised ground.
- Inaccurate target identification beyond 5 or 6 inches
- Inability to detect good targets in close proximity to iron trash.
- Erratic operation when searching salt-water beaches.

Most detectors on the market operate on a single (or dual) frequency, ranging from 1 to 70 kHz. Although this technology has served the industry well for years, Minelab's scientists found that a frequency that worked well in one area would often offer only marginal performance when used in another location. Ground mineralisation, trash content, and target size all had an effect on how well a detector transmitting a single frequency would operate.

The BBS circuit automatically transmits 17 frequencies simultaneously - a feature unique to Minelab metal detectors. Ranging from 1.5 to 25.5 kHz in 1.5 kHz increments, the signal received from the coil is analysed and information is relayed to the operator via the speaker, headphone, and meter (if attached). Through the use of its 17 frequencies, the Sovereign XS-2a Pro is able to find and accurately identify targets at maximum depth, in varying ground conditions or trash present.

Essentially, when using a Sovereign XS-2a Pro with BBS technology, it is like swinging 17 single-frequency detectors at the same time. Because BBS operates at a number of frequencies that no other detector does, BBS detectors such as the Sovereign XS-2a Pro can find a broad range of objects that no other individual detector has the ability to find.

BBS technology combines Minelab's unique multiple frequency BBS technology with improved signal processing to give:

- Greater detecting depth.
- Consistent sensitivity over a wide range of targets
- Less interference from electromagnetic sources

Therefore, the treasure hunter is more likely to detect targets normally missed.

1.	Introduction	3
2.	BBS Technology	4
3.	List of Parts	6
4.	Accessories	6
5.	Assembling the Detector	7
5.1	Armrest / Upper Shaft Assembly	7
5.2	Intermediate Shaft Assembly	7
5.3	Lower Shaft Assembly	7
5.4	Completing the Shaft Assembly	8
5.5	Shaft Mount	8
5.6	Rear Shaft Mount	9
5.7	Hipmounting	9
6.	Batteries	10
6.1	Installation of Alkaline Batteries	10
6.2	Installation of NiCad Battery Pack (Accessory)	11
6.3	Low Battery Warning and NiCad Recharging	11
7.	Control Panel	12
7.1	Quickstart Operating Instructions	12
7.2	Volume Control and On/Off Switch	13
7.3	Sensitivity Control	13
7.4	Threshold Control	15
7.5	Disc/All Metal Switch	14
7.6	Disc Control	17
7.7	Notch Control	19
7.8	Tone ID Switch	21
7.9	Audio Output	21
8.	Digital Target Indication Meter (Accessory)	22
8.1	Installation	22
8.2	Calibration	23
9.	Quick Operating Instructions	24
10.	Practising the Controls	26
11.	Treasure Hunting Tips	28
11.1	Pinpointing the Target	29
11.2	Recovering the Object	30
12.	Environmental Concerns	31
13.	Detector Care	32
14.	Trouble-shooting Guide	33
15.	Specifications	34
16.	Warranty and Service	36
17.	Minelab Service Repair Form	37

5. Assembling the Detector

Please follow these instructions to assemble the Sovereign XS-2a Pro. Refer to the drawings to identify parts and how they are positioned. Please contact your Minelab dealer for further instructions should any difficulties arise.

5.1 Armrest/Upper Shaft Assembly

- Remove the black nylon bolt and wing nut (2) from the armrest (1).
- With the armrest's larger fins pointing in the same direction as the foam hand grip (4), slide the armrest (1) onto the end of the black upper shaft (3).
- Push the nylon bolt (2) through the holes and tighten the wing nut by hand.

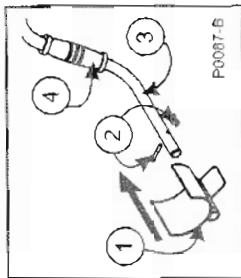

Figure 2 - Armrest/upper shaft assembly

5.2 Intermediate Shaft Assembly

- Slide the intermediate shaft (7) into the upper shaft (3). The black "V" clip (6) must be facing down along the foam handgrip section of the upper shaft (see Figure 4).
- Ensure that the pieces click together and do not come apart easily.

5.3 Lower Shaft Assembly

- Remove the tape on the lower fibreglass tube (9) that is holding the black teardrop washers (10) in place. **NOTE:** Ensure the washers do not fall out after removing the tape.
- Remove the black nylon wing nut, and bolt (11) from the coil (12).
- With the teardrop washers in place, push the lower tube (9) into the coil bracket so that the holes line up.

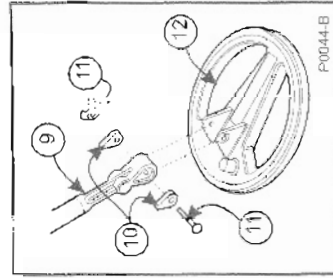

Figure 3 - The coil and lower shaft assembly

WARNING

**THIS DOCUMENT CONTAINS
MINELAB ELECTRONICS PTY LTD
RIGHTS TECHNICAL DATA OR
RESTRICTED RIGHTS DATA OR BOTH.**

Minelab Electronics Pty Ltd

This work is copyright. Apart from any use as permitted under the Copyright Act 1968, no part may be reproduced by any process without written permission from
Minelab Electronics Pty Ltd,
118 Hayward Avenue,
Torrensville, SA 5031,
Australia.

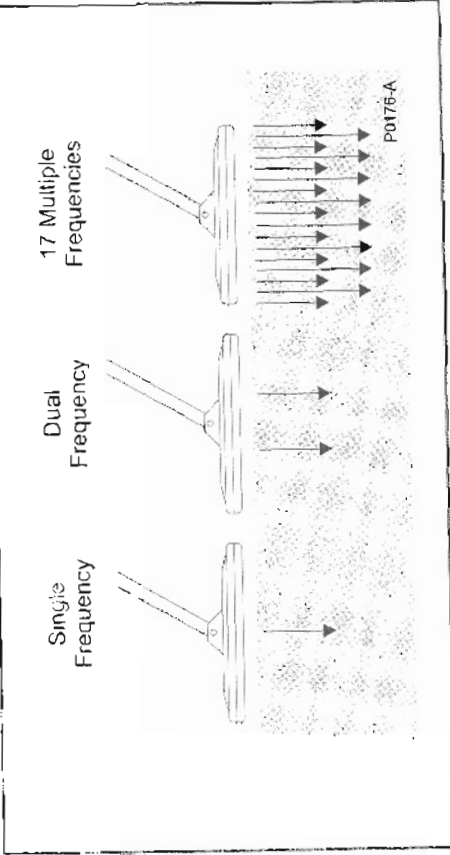

Figure 1 - Detector comparison chart.

The most important factor when comparing detectors with and without BBS circuitry is that BBS-based detectors have the ability to hunt even in the most mineralised areas at maximum performance without the need to manually ground-balance the detector.

As soon as the Sovereign XS-2a Pro is turned on and swept across the ground, the ground mineralisation is analysed and then compensated for by the microprocessor. This ensures that the Sovereign XS-2a Pro can locate targets deeper than other units, due to its automatic compensation of changing ground conditions.

One of the major overall benefits of BBS technology is that although it automatically operates at 17 frequencies - all at the same time - it is actually easier to use than most of its competitors. Because it is microprocessor controlled, all you need do is set the threshold, discrimination, and volume, and the rest is done for you automatically.

ABBS detector will penetrate more deeply, discriminate more accurately, and can be used in even the worst ground conditions. The bottom line is that when using a Minelab detector such as the Sovereign XS-2a Pro with its BBS technology, you will find more good targets than you will with any other detector.

NOTE: Ensure that the black nylon spring clip near the top of the fibreglass tube is pointing toward the rear of the coil.

- d) Push the black nylon bolt (11) through the holes in the bracket on the coil from the cable entry side and tighten the wing nut by hand.

5.4 Completing the Shaft Assembly

- a) Slide the lower shaft assembly (9) into the intermediate shaft (7).

NOTE: The black plastic locking nut (8) may need to be loosened to position the lower shaft assembly correctly.

- b) Set the length of the shaft by locking the black nylon spring clip into one of the holes provided, then tighten the plastic locking ring by hand.

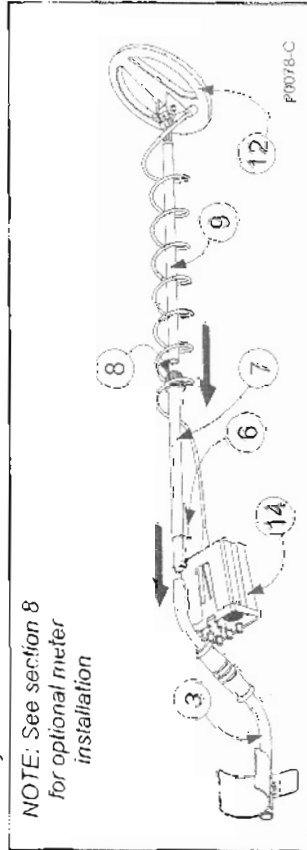

Figure 4 - Completing the shaft assembly

5.5 Shaft Mount

- a) Check that there are charged batteries in the control box (14).
- b) Position the control box (14) into the shaft "V" clip (6) then push down firmly towards the coil until the control box "clicks" into place and cannot be easily removed.

NOTE: Ensure that the small teeth moulded into the control box are locked into the groove of the "V" clip.

3. List of Parts

The box in which the Sovereign XS-2a Pro is shipped should contain the following generic items. Please check that all of these items are in the box

	Sovereign XS-2a Pro
Control Box	•
10" or 8" Round BRS coil (inc. nuts & bolts)	•
3-Piece Shaft Assembly (inc. Velcro™ straps)	•
Black Armrest (inc. nuts & bolts)	•
2 Alkaline Battery Holders	•
Black PCB NiCad to Alkaline Battery Adapter	•
Teardrop Washers (2)	•
Warranty card	•
Instruction Manual	•

4. Accessories

The following accessories are available to further enhance your machine.

- NiCad Battery Pack
- Mains NiCad Charger
- Hipmount Bag
- 12V NiCad Battery Vehicle Charger
- Digital Identification Meter.

Please refer to your Packing List, to verify if any of the above items are included as standard.

For further information on these and other Minelab products call your Minelab dealer.

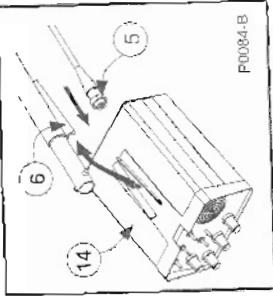

Figure 5 - Mounting the control box on the shaft

c) Begin winding the coil cable firmly around the shaft. Wind between 25 and 28 turns of the cable until it reaches the control box.

NOTE: Leave enough slack at the bottom of the cable near the coil to adjust the coil position without straining the coil cable.

d) Connect the plug connector (5) to the socket on the rear of the control box and tighten the locking nut.

5.6 Rear Shaft Mount

The Sovereign XS-2a Pro provides the option of mounting the control box at the rear of the shaft (3), before the armrest.

In order to mount the control box (14) in this position the armrest must first be moved to the second hole from the rear of the shaft (see Fig. 6) This position provides easy access to the shaft "V" clip (6) provided. Continue to connect the control box as described above.

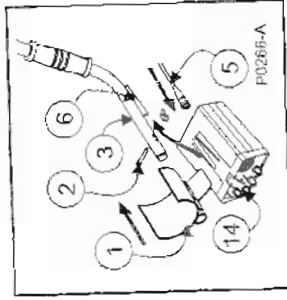

Figure 6 - Mounting the control box to the rear of the shaft

5.7 Hipmounting

Hipmounting is an alternative to mounting the detector on the shaft and significantly reduces physical strain, enabling longer search time without undue fatigue. An additional Hipmount Bag can be supplied with the Sovereign XS-2a Pro for this purpose.

- a) Check that there are charged batteries in the control box (14).
- b) With its control panel facing outwards, put the control box into the hip-mount bag.

- c) Begin winding the coil cable firmly around the shaft. Wind between 25 and 28 turns of the cable until it reaches the control box.

NOTE: Leave enough slack at the bottom of the cable near the coil to adjust the coil position without straining the coil cable.

- d) Connect the plug connector (5) to the socket on the rear of the control box and tighten the locking nut.

Important:

Use the Velcro straps to hold the first and last winding of the cable in position.

6. Batteries

The Sovereign XS-2a Pro detector is supplied with two alkaline battery holders and a black PCB NiCad to alkaline battery adapter.

6.1 Installation of Alkaline Batteries

Ensure that the detector is switched Off before opening the battery compartment.

- a) Place 8 "AA" cell alkaline batteries into the supplied holders (17). Make sure that they are aligned as indicated in the holders.
- b) Clip the battery holders onto the PCB alkaline adapter (18).
- c) Open the battery compartment lid (15) by pushing firmly down and sliding it from the rear of the control box (14).

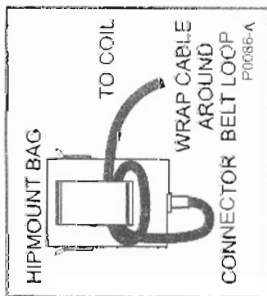

Figure 7 - Hipmounting the control box

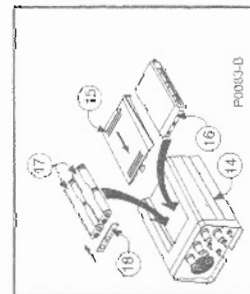

Figure 8 - Installing the batteries

- d) Install the assembled battery holders and adapter in the control box. Ensure that the battery terminals are aligned correctly.
- e) Replace the lid by sliding it back over the compartment until it "clicks" into place.

CAUTION: Good quality alkaline batteries will power the Sovereign for about 10 to 15 hours. Using headphones will extend battery life. Good quality alkaline batteries should always be used instead of standard carbon batteries. Alkaline batteries should be removed from the detector if it is to be stored for extended periods to avoid damage caused by leaking batteries.

6.2 Installation of NiCad Battery Pack (accessory)

- a) Open the battery compartment lid (15) on the control box (14).
- b) Place the battery pack (16) into the battery compartment in the control box (14). Ensure that the holes in the pack are aligned with the spring connectors of the compartment.
- c) Replace the lid by sliding it back over the compartment until it "clicks" into place.

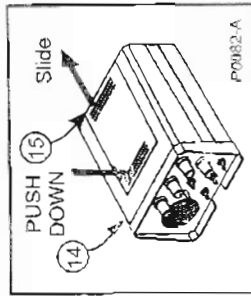

Figure 9 - Replacing the battery lid

6.3 Low Battery Warning and NiCad Recharging

As the batteries begin to reach the point at which they will no longer operate the Sovereign XS-2a Pro, a distinct sharp "pip" will sound from the speaker (or headphones) approximately every 30 seconds. At this point there will be approximately 15 to 20 minutes of life left in the batteries. It is recommended that the batteries be replaced immediately to avoid missing any targets.

The NiCad power pack (accessory) will provide 10 to 15 hours of detecting time from a full charge. NiCad batteries can develop a memory and require a consistent charging routine to ensure a long service life. Ideally a NiCad power pack should be fully discharged before recharging for 10-12 hours using a genuine Minelab Charger. The simplest method of ensuring that the power pack is fully discharged is to leave the detector turned "On" overnight with the Threshold and Volume controls turned down.

7. Control Panel

This section gives detailed descriptions of the Sovereign XS-2a Pro's controls and their functionality.

It is important that this section is read carefully as it will provide all the information required to set and adjust these controls. It may be beneficial to refer back to this section in the future.

NOTE: Each control has a recommended setting (indicated by a silver dot) called a **Quickstart Setting** (see section 7.1).



Figure 10 - The Sovereign XS-2a Pro Control Panel

7.1 Quickstart Operating Instructions

To start detecting as soon as possible, the Sovereign XS-2a Pro has provided "Quickstart" settings. These settings, indicated by a silver "dot" on each control, have been selected by the factory as best for immediate detecting. Adjust the Sovereign XS-2a Pro controls to these settings and start searching.

Once you are familiar with all the controls you will gain greater performance and versatility by setting the controls to suit the needs of the area being detected.

7.2 Volume Control and On / Off Switch



This control, located at the bottom right of the control panel is used to adjust a target's signal volume in addition to switching the Sovereign XS-2a Pro On or Off.

When in the fully counter clockwise position, the Sovereign XS-2a Pro is turned Off. Turning the control clockwise, will "click" the Sovereign XS-2a Pro On. Continue to turn this control in a clockwise direction, the volume of target signals will increase. At the most clockwise position, the volume will be set at the "maximum" position. Minelab recommends this position for most circumstances. Users should be aware that, when using headsets, if a large target is detected close to the surface, the resulting loud signal may cause some hearing discomfort.

7.3 Sensitivity Control



The Sensitivity control, located at the bottom of the control panel, allows the level of sensitivity to be adjusted to suit the conditions in which you are detecting. It is often thought of in terms of a depth control and it is, to a point, but more importantly it also makes the unit more or less sensitive to interference caused by ground chemistry "mineralization", or electromagnetic fields.

At the most counter clockwise position this control "clicks" into the Auto position. In this setting the Sovereign XS-2a Pro will automatically adjust the level of sensitivity to the optimal level under the prevailing conditions.

Beginners should operate the unit in Auto, no matter where you are detecting.

Turning the control clockwise will "click" the Sovereign XS-2a Pro out of the Auto setting into manual sensitivity. As this control continues to be turned in a clockwise direction the level of sensitivity will be reduced. At the most clockwise position, the Sovereign XS-2a Pro is set at "minimum" sensitivity.

Experienced operators detecting in wet sand at the beach should set the Sensitivity control out of Auto and into the area marked Beach on the control. The dot indicates the optimum position. The knob adjustment should always be set as counter clockwise as possible without the detector false signalling.

In general, the more moist the beach sand, the more clockwise the knob must be turned. The incidence of false signalling is minimised if the operator concentrates on sweeping the coil as parallel and even to the beach sand surface as possible, whether in or out of the water. In summary, for greatest detection depth:

- Keep the coil sweep as parallel to the beach sand as possible.
- Turn the sensitivity knob as counter clockwise as possible (within the manual region) so that minimal false signalling occurs.
- This setting will need to be altered, depending on the sand moisture level

Advanced users operating inland can operate the unit in either **Auto** or in **manual**. In more mineralised soils **Auto** is recommended. Note that "hot rocks", "Roman pennies" or some ancient red/orange/brown pottery or tiles may cause the unit to respond as if the targets are ferrous. This is not a false signal but the correct response and indicates that the unit is set at a relatively high sensitivity.

Advanced users operating in non-mineralised soils or areas of high trash concentration should set the sensitivity control out of **Auto** and into the variable **manual** region. The requirements of this setting are the same as those for the advanced beach detection. The control should be set as counter clockwise as possible (out of **Auto** and into the variable manual region), so that minimal false signalling occurs. This setting will depend on the degree of soil mineralisation and of the metal junk concentration.

7.6 Disc Control

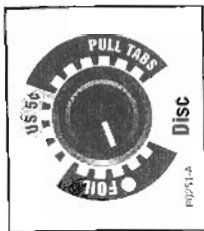

The **Disc** (Discriminate) control is located at the top left-hand side of the control panel and is used when in **Disc Mode** to "discriminate" or "ignore" unwanted non-ferrous metal targets.

If the **Disc** control is set to the most counter clockwise position (ensure the **Notch** control is also set to this position), then ferrous metals will be "ignored" and the Sovereign XS-2a Pro will not produce a "signal beep" (large ferrous objects may produce short "pops" or "clicks"). However, non-ferrous will give a "signal beep" or be "accepted".

Typical ferrous objects encountered by treasure hunters are nails, screws, washers, bits of wire, etc. These objects are generally not considered to be of value, so it is a distinct advantage to be able to ignore them while detecting. Objects that will cause the Sovereign XS-2a Pro to produce a "signal beep" will be non-ferrous metals, including such items as aluminium foil, most jewellery, pull-tabs, coins, bottle tops, gold, silver, brass, etc.

Not all of these non-ferrous objects are considered valuable. Therefore, by using the **Disc** control, the Sovereign XS-2a Pro can be adjusted to ignore some of the less valuable non-ferrous objects while still locating more valuable targets. The **Disc** control is a one-turn pot, continuously variable with 17 graduations as a guide for the setting of the control. Turn the **Disc** control clockwise and increase the "discrimination" level, non-ferrous objects of lower conductivity will be ignored.

The Sovereign XS-2a Pro uses the electrical conductivity of the object to determine the type of metal detected and, based upon the **Disc** control setting, will either ignore or accept the object. The most effective way to demonstrate this is to consider a number of objects, all of varying conductivity, placed in a line on the ground. As the detector is moved from left to right, the objects increase in conductivity.

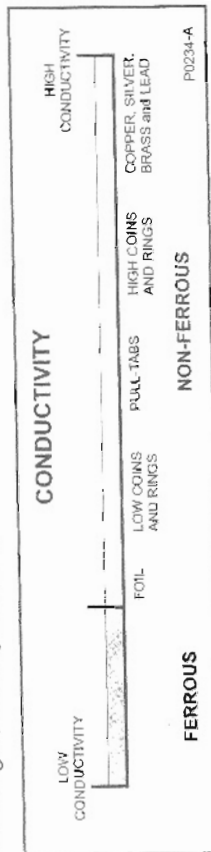

Figure 11 - Target conductivity.

Turn the **Disc** control further clockwise and objects of greater conductivity will be ignored. If the **Disc** control is set to ignore the pull-tab this will mean that all objects having a similar or lower conductivity than the pull-tab will be ignored while objects of high conductivity will be accepted (see Fig 12).

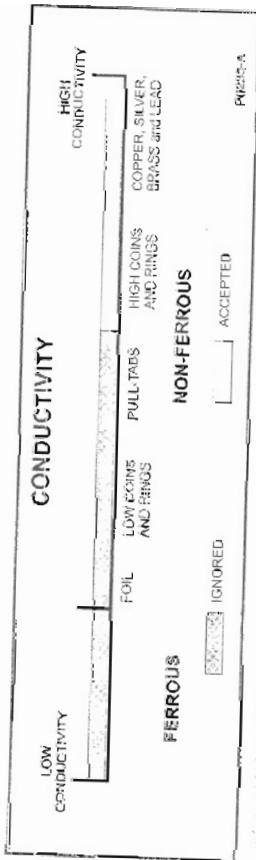

Figure 12 - Discriminating targets based on conductivity

Figure 13 shows some common objects and where the **Disc** control has to be set to ignore them. As a general rule, the two objects **treasure hunters** most commonly wish to ignore are aluminium foil and pull tabs. As can be seen in Figure 13, these objects both cover a significant range on the **Disc** control. The conductivity of objects that the user wishes to accept or ignore often overlaps, so, setting the **Disc** control to ignore both foil and pull-tabs will also ignore a large amount of valuable non-ferrous objects including coins, rings, and other jewellery.

Example:

If hunting for fine white gold rings, with the **Disc** control set to position 4, some types of aluminium foil will also be detected. To avoid old bottle caps but detect brass buttons and copper coins, the **Disc** control should be set higher (approximately at number 13), but most fine white gold rings, foil, and some yellow gold rings will also be ignored. With experience, setting the **Disc** control to ignore most unwanted targets (in combination with the **Notch** control) will become second nature.

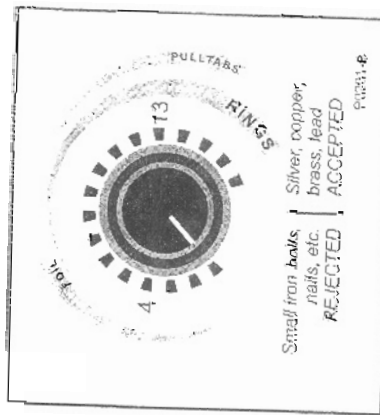
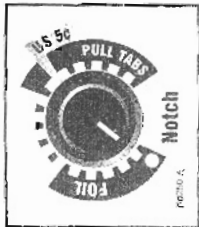

Figure 13 - Disc control

7.7 Notch Control



Located on the center left of the control panel, the **Notch** control is used in combination with the **Disc** control to discriminate against, or ignore, certain metal objects. As with the **Disc** control, it is continuously variable and features 17 graduations as a guide to setting the control.

The main difference between the **Notch** and **Discrimination** controls is the **Discrimination** is a continuous band of discrimination whereas the **Notch** is in fact a short segment of discrimination which can be moved up or down the scale of conductivity (see Fig. 14).

For example, consider a number of objects, all of varying conductivity placed in a line on the ground. As the detector is moved from left to right, the objects increase of conductivity.

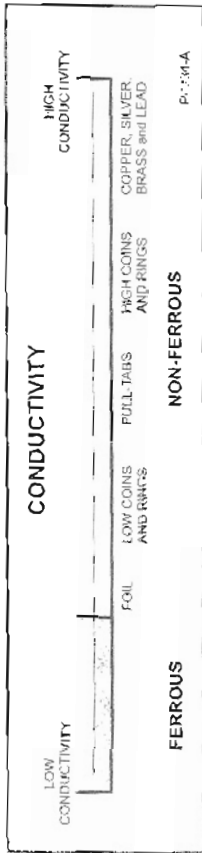

Figure 14 - Targets with increasing conductivity

Turn the **Notch** control further clockwise and objects of a certain conductivity will be ignored. Turning the **Notch** control to ignore the pull-tab will mean that only non-ferrous objects having a similar conductivity to the pull-tab will be ignored while all other non-ferrous objects of a different conductivity are still accepted. Note also in Figure 15 that ferrous objects are being ignored due to the **Disc** setting.



Figure 15 - Ignoring targets using the Notch control

When using the Notch and Disc controls in combination, most unwanted objects can be successfully ignored. Turning the Notch control to ignore the pull-tab and the Disc control to ignore the aluminium foil will set up the Sovereign XS-2a Pro to ignore pull-tabs and aluminium foil while still detecting most valuable non-ferrous objects.

NOTE: Different pull-tabs may require different Notch settings.

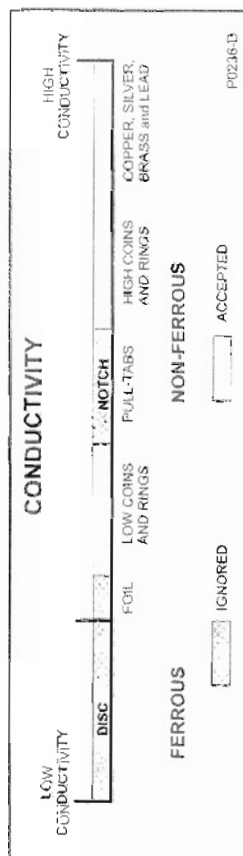

Figure 16 - Ignoring targets using the Disc and Notch controls

7.8 Tone ID Switch

Fixed Tone ID or Variable Tone ID in Disc.

In the Fixed position, the tone of the audio signal from a target will remain constant as the volume increases to indicate the target, regardless of the object's conductivity.



In the Variable position, the tone of audio signals received will change to help identify the object that has been detected. The lower an object's conductivity, the lower the pitch of the signal tone. For example, the pitch of a piece of aluminium foil will be lower than that of a gold coin. The advantage of Variable tone target indication is that it allows a target to be identified before recovering it from the ground.

7.9 Audio Output

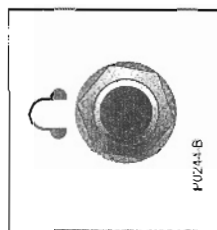

The audio output of the Sovereign XS-2a Pro is available through either an in-built loudspeaker or via a 1/4" stereo headphone jack. When the headphones are plugged in, the loudspeaker is disconnected.

Headphones are recommended for serious treasure hunting for several reasons: they are more sensitive to slight target signals than the loudspeaker; shielding the operator from external noise, which can be distracting and their use will increase battery life. Headphones used should be of a low impedance.

The socket will accept most stereo headphones with a 1/4" jack. If these headphones have a "Stereo/Mono" switch, set it to "Stereo".

Minelab recommends headphones to be 32 Ω or less.

8. Digital Target Indication Meter (Accessory)

The Digital Target meter has been designed to aid in the identification of metal targets before their recovery. It provides a digital display of the target ID tones produced by the Sovereign XS-2a Pro detector, and connects between the search coil and the control box without requiring any modification to the detector's electronics.

The meter has no negative effect upon the operation or overall performance of the detector, it simply provides for easier target recognition. It is also very useful for people with tonal hearing loss.

8.1 Installation

Plug the coil connector (21) into the socket (22) on the meter box, winding the excess cable around the shaft. Plug the meter cable connector (23) into the control box (14), winding the excess cable around the shaft.

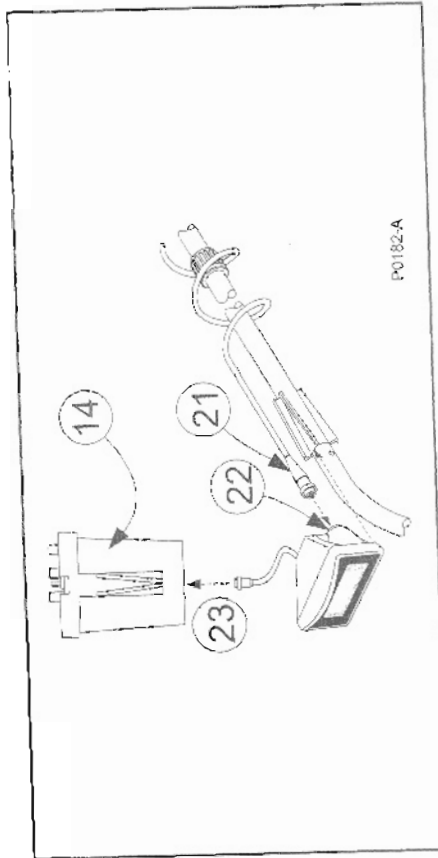

Figure 17 - Installing the meter

If hipmounting the control box, secure the meter cable to the shaft of the detector using the Velcro™ straps provided. Loop the meter cable twice through the belt loop of the hipmount bag before attaching it to the control box. This reduces any stresses placed on the meter cable caused by hip-mounting and reduces the possibility of failure of the cable.

The meter requires no batteries (see Figure 17).

8.2 Calibration

Before using the Digital Target meter, it is necessary to calibrate it:

- a) Set the Calibration control knob (situated to the rear of the meter) to the center position of its range.
- b) Place the detector in a stationary position with the coil flat on the ground.
- c) Set the Sensitivity control on the Control box to Auto.
- d) If the threshold is varying because of electrical interference, adjust Sensitivity towards minimum until a constant threshold is present.
- e) Slowly pass a common coin across the coil and finely adjust the Calibration control to the nearest number, divisible by 5. e.g. US quarter (set to 550), AUS 20¢ (set to 500).
- f) Slowly pass additional coins and other common targets across the coil and record the results on the target recognition table shown on page 24.

This table will become an excellent guide when used in conjunction with the Digital Target Indicator until the various target responses become familiar. This meter should not be solely relied upon for discrimination. It is important to use the other features of the Sovereign XS-2a Pro to aid in the process of discrimination.

Be aware that some similar objects may vary in Target Indication readings because of changes in composition. For example, a gold ring will vary depending upon the purity of the gold and the size of the band. Coins minted in different years may have different alloy combinations and so the reading will differ. In addition, if different objects provide the same reading, this is because they have a similar conductivity.

The Target Indication readings will also be influenced by an object's orientation, by the length of time it has been buried in the ground as well as different ground conditions.

Target Recognition Table

Object	Type	Reading
US quarter AUS 20¢	non-ferrous non-ferrous	550 500

- k) Now turn the **Disc** control progressively clockwise in steps and pass the coil over the objects. Take note of when certain objects are rejected, this will enable more accurate discrimination of these objects in the field.
- l) Turn the **Disc** control to the position where it ignores the pull-tab. Passing the coil over objects with lower conductivity (such as the aluminium foil) will not produce a signal. Take note of the threshold tone as it disappears and then returns again. It should return at a slightly different pitch than normal. This indicates that the Sovereign XS-2a Pro ignored a non-ferrous object.
- m) Turn the **Disc** control back to the most counter clockwise position.
- n) Now progressively turn the **Notch** control in a clockwise direction, again passing the coil over the test objects. The **Notch** control enables the detector to ignore a small number of objects with similar conductivity while still detecting other valuable non-ferrous objects, even if they are of lower conductivity.
- o) Turn the **Notch** control to ignore the pull-tab. Objects with similar conductivity to the pull-tab will be ignored. Pass the coil over the aluminium foil and the Sovereign XS-2a Pro will produce a signal. This would not be possible using the **Disc** control.
- p) Now turn the **Disc** control to ignore the aluminium foil.

The Sovereign XS-2a Pro is now set to ignore the types of objects most commonly unwanted by treasure hunters.

11. Treasure Hunting Tips

The Sovereign XS-2a Pro will perform at its best when the BBS XS-2a coil is kept in close proximity to the ground. Inexperienced operators should practice maintaining a constant coil height at the extremity of each swing, maintaining contact with the ground will make this easier. This is important, as variation in coil height at the end of each swing can cause confusing sounds and will reduce detection depth.

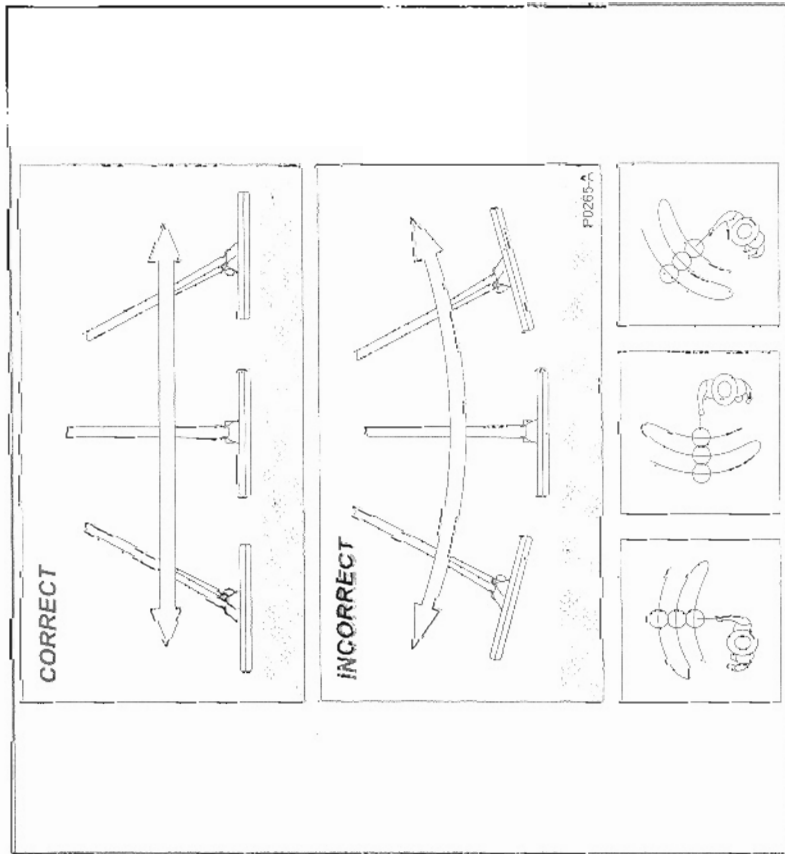

Figure 18 - Sweeping the coil

NOTE: Each sweep of the coil should overlap the last one. This will ensure good ground coverage.

Keeping the BBS XS-2a Pro coil in contact with the ground will increase detection depth and response to small objects.

11.1 Pinpointing the Target

When the approximate location of the target has been determined, move the coil slowly over the target. The audio tone will increase in volume while moving towards the target and decrease in volume as the coil is passed over it. The tone will be loudest when the coil is directly over the target. Quite often the detector will be producing its maximum volume for a broad area over the target. This generally indicates that the target is near the surface or is quite large.

To receive a sharper, more precise signal over the target, it may also be beneficial to switch to All Metals mode as this will produce a pinpoint response to the target.

The open design of the BBS XS-2a Pro coil makes it easy to mark the ground directly above the target to aid recovery.

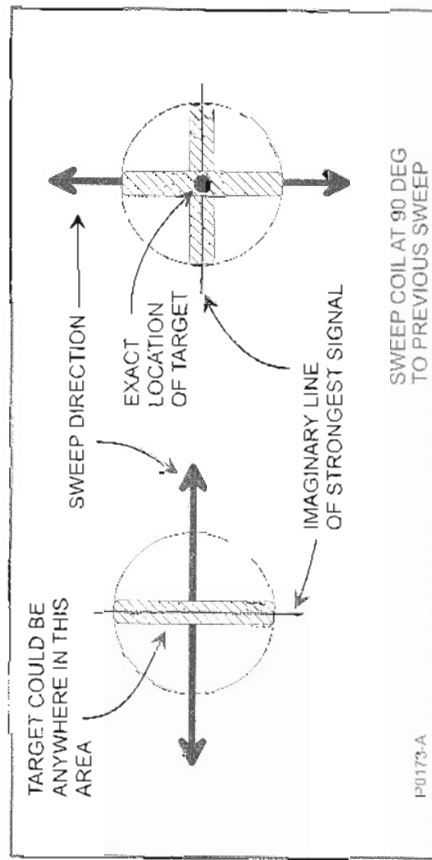

Figure 19 - Pinpointing the target with the Sovereign XS-2a Pro

11.2 Recovering the Object

Once the target has been pinpointed, clear the surface of loose material and check again for the signal. If there is no signal then the target is amongst the surface material. In this case search the surface material until the target is located.

If the target is still in the ground, recheck using the pinpoint mode. Cut a grass plug in a horse shoe shape leaving one corner attached, then bend the sod back. If you have pinpointed properly your find should be in the middle of the exposed hole. If not, the use of a probe can assist in locating the find exactly and minimise soil disturbance.

If you cannot see the target, and are confident it is still in the hole, remove some soil and place it on a plastic sheet next to the hole. This will enable you to pour back the dirt and leave the surrounding area clean after taking out your find.

Place the coil flat on the ground next to you and gradually remove handfuls of soil from the plastic sheet and pass these over the coil. Keep repeating this procedure until you hear and find your target. Be sure to recheck the hole and surrounding soil, as several coins can sometimes be found in one hole.

Pour back the loose soil and carefully tread the sod down to its original appearance. This will retain the pristine nature of your site and help to maintain future access for everyone to enjoy this great pastime.

Please note: Dig carefully so as not to gouge or scratch the target, which may be valuable or unique. Be sure to remove any rings or watches from your hands before passing soil across the coil. You may get conflicting signal responses from metal items on or close to you.

Once again, always remember to refill holes.

12. Environmental Concerns

Firstly, it should be pointed out that treasure hunting with a metal detector is the most environmentally friendly way to recover coins, rings, and other treasure items. However, it is important to leave an area searched in the same condition you found it.

When searching parklands or properties where the grassland or lawn is sensitive to disturbance, always use special tools to enable the recovery of targets without digging large holes. This retains the surface "plug" of grass and soil to be returned undisturbed.

All holes that have been dug must be properly refilled. Not only is it environmentally unacceptable to not fill in holes, it is also dangerous.

The use of headphones when detecting will also reduce noise, another important environmental concern.

Take away and properly dispose of any junk that is found or produced, such as nails, tin cans, or flat batteries. Leaving an area "scarred" can result in action being taken to prevent the use of metal detectors, which will spoil this fascinating hobby.

13. Detector Care

The Sovereign XS-2a Pro is a high-quality electronic instrument, finely engineered and packaged in a durable housing. Taking proper care of the detector is mostly common sense.

- **Do not leave batteries in the control box when the detector is not in use for any period exceeding two weeks.** Damage caused by leaking batteries would be severe and would void the warranty through user negligence.
- If temperatures are very high, **do not leave the detector in the sun for longer than necessary.** Covering it when not in use will help protect it. Try to avoid leaving it in a closed trunk or in a car sitting in sunlight.
- While the coil of the detector is designed to be waterproof, the control box is quite susceptible to water intrusion. Always protect it when using the detector in rain or on the beach where salt spray is prevalent. **Never allow the box to come into contact with gasoline or other oil-based liquids.**
- **Keep the detector clean and dry and avoid getting sand and grit into the shafts or the tightening nuts.** Do not use solvents to clean the detector. Use a damp cloth with mild soap detergent.
- **Batteries.** Flat or faulty batteries cause many detector problems. Ensure that only quality alkaline batteries are used, and that they are replaced when the warning signal indicated through the headphones or speaker is heard.
- **Cables.** Ensure the coil cable is in good condition and not subject to undue stress. The coil connector at the base of the cable must be firmly tightened.

Visual Display: Display 2.5 digit LCD digital meter
(accessory)

Warranty: Control Box 2 years
Coil 1 year

Patents: Patents apply.

16. Warranty and Service

There is a two-year parts and labour warranty for the electronic control box of the Sovereign XS-2a Pro. Refer to the Warranty Card for further details. The BBS XS-2a Pro coil has a one year parts and labour warranty. Refer to the supplier or Minelab for service, either in or out of warranty.

NOTE: This warranty is not transferable, nor is it valid unless the enclosed warranty registration card is returned to Minelab or an authorised Minelab distributor within 14 days of the original purchase.

The Minelab warranty does not cover damage caused by accident, misuse, neglect, alteration, modifications, or unauthorised service. For specific details of the Minelab warranty, please refer to the machine's "Product Warranty Card".

14. Trouble-shooting Guide

Fault	Solution
No Sound	<ul style="list-style-type: none"> Check batteries and battery connections. Ensure battery lid is completely closed. Check headphones and their connection.
Erratic Noises	<ul style="list-style-type: none"> Check battery charge and battery connections. Ensure coil plug is tightened firmly. Reduce the Sensitivity by turning clockwise. Switch to the Auto position. Check headphones and their connection. Check for sand or grit between coil cover and coil.
No Target Response	<ul style="list-style-type: none"> Ensure the unit is turned On. Check battery charge and battery connections. Check coil connection. Check headphones and their connection. Check Disc and Notch settings.

In the unfortunate circumstance that the detector needs to be returned to Minelab for service, please fill out the Minelab Service Repair Form (on page 37 - or a photocopy of the same) and enclose it with the detector. Please supply as much detail about the fault as possible as this will assist our service engineers to rectify the problem quickly and efficiently.

NOTES:

15. Specifications

These specifications are subject to change without notice

- Applications:** Coin, relic, and treasure hunting
Inland, beach or shallow water
- Length:** Extended 55" (1400mm)
Unextended 33" (840mm)
- Weight:** Control Box (excl. Batteries) 550 g
8" BBS XS-2a Pro 800 Coil 590 g
10" BBS XS-2a Pro 1000 Coil 780 g
- Batteries:** Alkaline Cells Eight 1.5V "AA"
NiCad Battery Pack 12V, 700 mA/hr
(accessory)
- Coil:** either 8" Round "Double D" waterproof
or 10" Round "Double D" waterproof XS-2a
- Headphones:** Jack - Stereo / Mono 1/4"
- Transmission:** Broad Band Spectrum, multiple simultaneous
frequency transmission at 1, 3, 4.5, 6, 25.5 kHz
- Ground Rejection:** Automatic Ground Tracking
- Detection Modes:** detects ferrous and non-ferrous metals
- All Metals/ Pinpoint:** rejects ferrous and unwanted non-ferrous metals
- Disc/Iron Mask:** rejects ferrous and unwanted non-ferrous metals
- Controls:** Volume (On / Off) Pot. and Switch
Sensitivity (Auto or Manual) Pot. and Switch
Threshold Pot. 1 Turn
Disc Pot. 1 Turn
Notch Pot. 1 Turn
Mode Switch 2 Position
Tone ID Switch Switch 2 Position

17. Minelab Service Repair Form

Today's Date:

Defect: Model: Serial No.:

Purchased From:

Purchase Date:

Parts being returned:

Description of Fault:

Owner's Name:

Address:

Phone: Day () Home ()

Fax () Email:

Please use additional sheets if more space is required.

FCC Compliance

NOTE:

This equipment has been tested and found to comply with the limits for a Class B digital device, pursuant to part 15 of the FCC rules. These limits are designed to provide reasonable protection against harmful interference in a residential installation. This equipment generates, uses and can radiate radio frequency energy and, if not installed and used in accordance with the instructions, may cause harmful interference to radio communications. However, there is no guarantee that interference will not occur in a particular installation. If this equipment does cause harmful interference to radio or television reception, which can be determined by turning the equipment off and on, the user is encouraged to try to correct the interference by one or more of the following measures:

- < Re-orient or relocate the receiving antenna.
- < Increase the separation between the equipment and receiver.
- < Consult the dealer or an experienced radio/TV technician for help.

EC Conformity

NOTE:

This product complies with the essential requirements of EMC Directive 89/336/EEC.

Free Manuals Download Website

<http://myh66.com>

<http://usermanuals.us>

<http://www.somanuals.com>

<http://www.4manuals.cc>

<http://www.manual-lib.com>

<http://www.404manual.com>

<http://www.luxmanual.com>

<http://aubethermostatmanual.com>

Golf course search by state

<http://golfingnear.com>

Email search by domain

<http://emailbydomain.com>

Auto manuals search

<http://auto.somanuals.com>

TV manuals search

<http://tv.somanuals.com>