

# MINELAB XT 17000

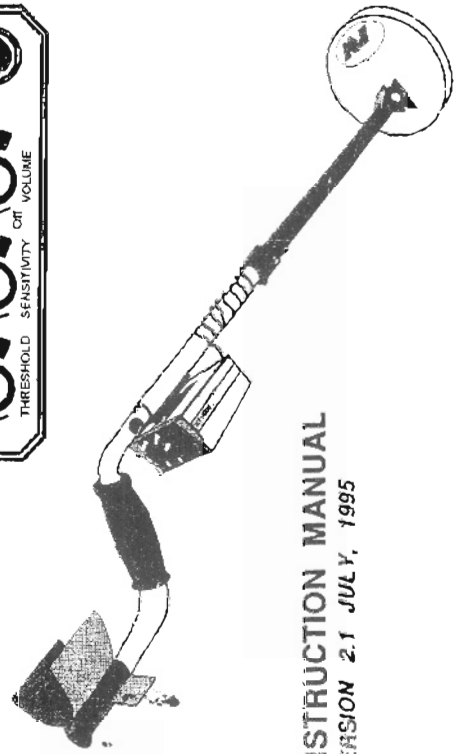
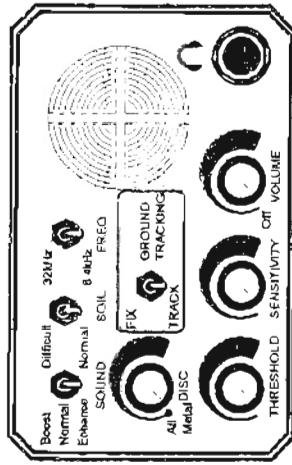
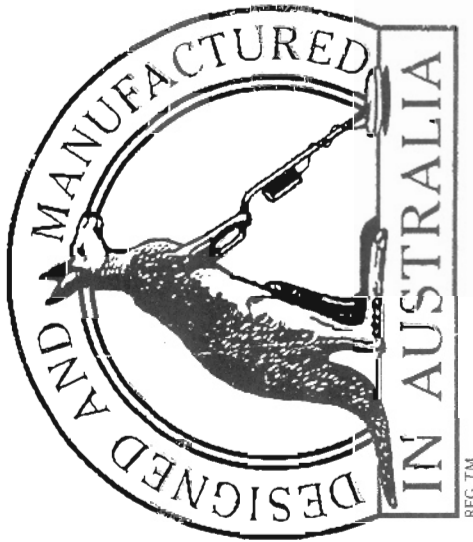

INSTRUCTION MANUAL  
VERSION 2.1 JULY, 1995

**MINELAB ELECTRONICS PTY LTD**

P.O. Box 35, Stepney  
South Australia 5069

Phone 331 9958 Fax 331 9280

Area Codes: National (08) International (618)

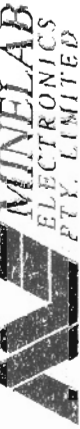

# INSTRUCTION MANUAL FOR THE MINELAB XT 17000

	PAGE
1.0 Introduction.....	1
2.0 Contents of the Box.....	2
3.0 Assembling the XT 17000.....	2
4.0 Batteries Installation.....	6
5.0 The Controls.....	7
6.0 Search Coils.....	17
7.0 Operating Instructions.....	18
8.0 General Detecting Techniques.....	20
9.0 Prospecting Tips.....	24
10.0 Environmental Concerns.....	27
11.0 Detector Care and Trouble-Shooting.....	27
12.0 Warranty.....	29
13.0 Specifications.....	29

## AUTOMATIC GROUND TRACKING

The following simplified diagrams show how Automatic Ground Tracking (AGT) in the XT-17000 allows you to cover more ground in less time.

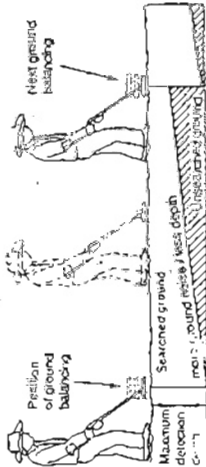

Figure 1 shows normal searching without AGT. Ground noises reduce the effective searching depth when you move from where you last ground balanced. The shaded area shows ground which is not properly searched.

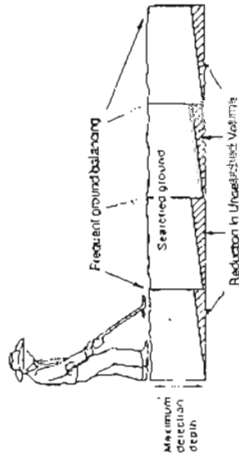

Figure 2 shows how a hardworking experienced professional will avoid missing treasure in that area. The detector is rebalanced more often: which is very time consuming.

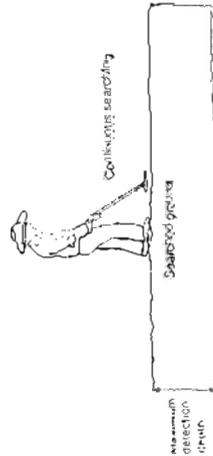

Figure 3 shows how genuine automatic ground tracking covers all the ground quickly and effectively. For this to occur, the detector must track quickly enough and not reduce its sensitivity.

## 1. INTRODUCTION

Congratulations on purchasing Minelab Electronics XT 17000. This detector is a development of the highly successful GT 16000 and GT 16000. For the first time the advantages of true Automatic Ground Balance are available with the convenience of a Dual Frequency detector.

The XT 17000 allows the operator to choose between 6.4 kHz and 32 kHz at the flick of a switch. The 6.4 kHz mode of operation is particularly suitable for the detection of larger objects at greater depths. In the 32 kHz mode the XT 17000 will excel at locating very small metal objects near the surface of the ground. Both these features available in the same detector, truly the best of both worlds!

The XT 17000 continues the Minelab tradition of true automatic ground balance detectors which allow more ground to be covered in less time.

Before Minelab's True Automatic Ground Balance this function was achieved by the operator interpreting the signals produced by the detector and adjusting the Ground Balance Control (usually a 10 turn control) to compensate for the noises caused by ground mineralisation. This was a highly skilled operation which required a great deal of concentration while detecting.

Thus the XT 17000 has several advantages over the manual Ground Balance detector in that it is constantly adjusting the ground balance to keep it correct, it is much more precise and it never tires of Ground Balancing. This enables an inexperienced operator to be using the detector with optimum performance in a very short time and the experienced operator to be detecting accurately more ground than is possible with a manual machine.

We at Minelab have set out to produce the highest performance, most versatile detector available, and we wish you every success in your prospecting.

## 2.0 CONTENTS OF THE BOX

To unpack the contents of the box, firstly, remove the brown inner box liner. This liner will lift the entire contents out of the box so that it can be easily accessed.

Now remove the contents and lay them out so that each piece can be seen and assembly can easily be carried out.

Your new XT 17000 should have the following parts in the box. If any parts are missing then please contact your dealer.

- Control Box
- 3 Piece Shaft Assembly
- Black Armrest
- NiCad Battery Pack
- Goldsearch Coil with Skid Plate
- NiCad Battery Charger
- Blue Hipmount Bag
- Warranty Card
- Basic Field Guide

Please now complete your warranty card and mail it to Minelab. It is extremely important that we receive your warranty card as it will register your new detector on our warranty file.

## 3.0 ASSEMBLING THE XT 17000

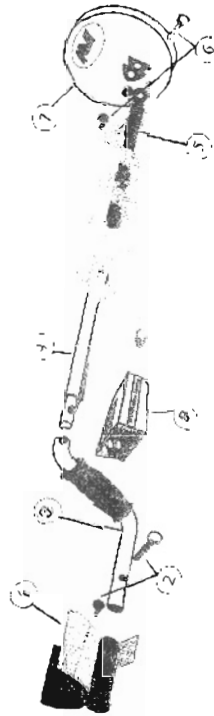

Figure 1 - Assembly of the XT 17000  
XT17000 Manual (3)

Please follow these simple instructions to assemble your new XT 17000. If you have any difficulties please call your dealer for further instructions.

### 3.1 Armrest Assembly

- Remove the black nylon bolt and nut (2) from the armrest (1).
- Slide the armrest (1) (with the support fins pointing to the ground) onto the end of the grey upper shaft (3) furthest from the foam handgrip (as is shown in figure 1). Line up the holes at a comfortable position for the length of your arm.
- Push the nylon bolt (2) through the holes and tighten the wing nut by hand.

### 3.2 Intermediate Shaft Assembly

- Slide the intermediate shaft (4) into the upper shaft (3) taking note of the position of the black "Y" clip (as shown in figure 1). Ensure that they click together correctly and will not easily come apart.

### 3.3 Lower Shaft Assembly

- Remove the tape on the lower fibreglass tube (5) which is holding the black teardrop washers in place. Make sure the washers do not fall out after removing the tape.
- Remove the white nylon nut and bolt (6) from the coil (7).
- Push the lower fibreglass tube (5), with the teardrop washers in place, into the bracket on the coil so that the holes line up. Make sure that the black nylon spring clip, near the top of the fibreglass tube, is pointing toward the rear of the coil.

- D. Push the white nylon nut and bolt (6) (as shown in figure 1) through the holes in the bracket on the coil from the cable entry side, then place the spacer and wing nut on the other end of the bolt and tighten by hand.

### 3.4 Completing the Shaft Assembly

- A. Slide the lower shaft assembly into the intermediate shaft (4). Note that the black plastic locking nut may need to be loosened to get the lower shaft assembly in.
- B. Set the length of the shaft by locking the black nylon spring clip into one of the holes provided and then tighten the plastic locking ring by hand.

### 3.5 Shaft Mount

- A. Position the control box (8) into the shaft "V" clip and push down hard towards the coil until it clicks into position and cannot be easily removed.
- B. Using the velcro tabs provided place one on the shaft 4-5 inches above the coil. Place the other on the shaft 3-4 inches below the control box (or at a comfortable position when hip mounting).

- C. Stand the detector upright so that the coil is sitting flat on the ground. Now lay the detector backwards so that the control box sits on the ground ensuring that the coil remains flat on the ground. Pick the detector up and begin to wind the coil cable from the coil firmly around the shaft. Wind it between 25 and 28 turns until it reaches the control box.

Leave enough slack at the bottom of the cable near the coil to allow for adjusting the coil angle without placing strain on the coil cable.

XTT7000 Manual

(4)

- D. Fasten the cable with the velcro which will ensure that it does not move at all. Any movement in the cable whilst detecting can cause false signals to occur.

- E. Plug the cable connector into the control box and tighten the locking nut by hand. Please do not use pliers to tighten this nut because it will damage the connector.

### 3.6 Hipmount

By hipmounting the detector you will significantly reduce the amount of weight on your arm enabling you to search for longer periods of time without becoming tired.

- A. If the control box is on the shaft then remove it. Place the control box into the blue hipmount bag provided, ensuring that the control panel is facing outwards.
- B. Then either thread the bag onto your belt or alternatively suspend it from the strap provided.
- C. Stand the detector upright so that the coil is sitting flat on the ground. Now lay the detector backwards so that the control box sits on the ground ensuring that the coil remains flat on the ground. Pick the detector up and begin to wind the coil cable from the coil. Wind the cable tightly around the shaft between 10 and 15 turns leaving enough free cable to allow movement of the shaft whilst searching.

Leave enough slack at the bottom of the cable near the coil to allow for adjusting the coil angle without placing strain on the coil cable.

- D. Fasten the cable to the shaft using the velcro tabs provided.

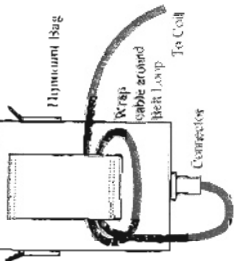

E. To prevent strain being placed on the cable and connector, wrap one turn of cable through the bell strap (as seen in figure 2) and then plug the connector into the control box ensuring the locking nut.

Figure 2

Once correctly assembled, your new XT 17000 should look similar to figure 3.

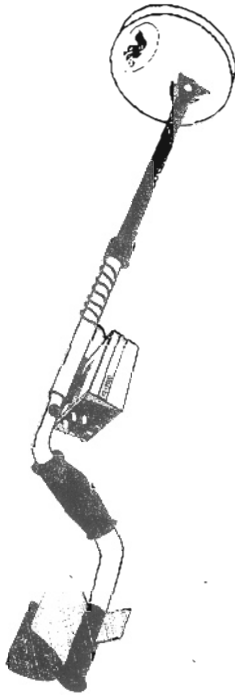

Figure 3 - The completed XT 17000

## 4.0 BATTERIES

The XT 17000 is supplied with a Nickel-Cadmium (NiCad) Battery Pack. These batteries can be recharged many times, which can provide a substantial cost saving over Alkaline Batteries.

Prior to your first operation of the XT 17000 it is recommended that you charge the battery pack for 10 to 12 hours to ensure they provide peak performance in the field.

XT17000 Manual

(6)

**Note:** When the detector is shipped the battery pack is stored in the battery compartment but not connected.

### 4.1 INSTALLATION

1. Ensure Detector is turned OFF before accessing the battery compartment.
2. To access the battery compartment slide the battery lid from the detector by pushing down on the front of the lid and sliding the lid out to the rear of the control box as shown in the figure 4.
3. To connect the battery simply plug the connector from the control box into the socket on the battery.

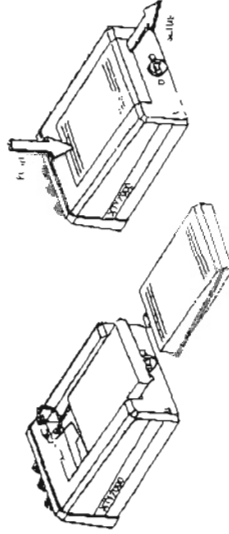

Figure 4. Battery removal and installation.

### 4.2 LOW BATTERY WARNING AND RECHARGING

The XT 17000 has an automatic "battery low" warning system. When the battery life is critically low, a distinct sharp "pip" will sound at about 20 second intervals through the headphones or loudspeaker. These signals are quite distinctive and indicate that the batteries have about 15-20 minutes useful life left from when the sound first started.

The XT 17000's NiCad batteries can be recharged from the supplied mains powered charger or if you are away from mains power an optional 12V can be purchased and used to charge your batteries from your vehicle's cigarette lighter.

It is recommended that the NiCad batteries be completely discharged before being recharged. This will ensure a long life from the NiCad batteries and prevent them from acquiring a "memory" which reduces the battery charge.

#### 4.3 BATTERY ALTERNATIVES

If you are in the field and the NiCad batteries lose their charge, you can replace them with 8 x "AA" penlite batteries by using the optional "Alkaline Adaptor Kit". Always use high quality Alkaline batteries with this kit. **DO NOT USE CARBON BATTERIES.** We cannot guarantee the correct operation of the XT 17000 with Carbon batteries

## 5.0 THE CONTROLS

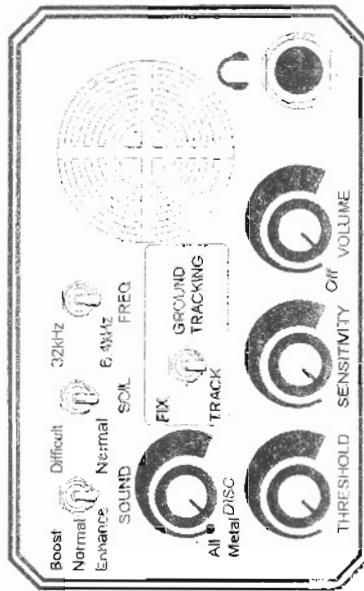

Figure 5. XT 17000 Control Panel

### 5.1 VOLUME CONTROL

The Volume Control is located on the bottom right of the Control Panel, next to the Loudspeaker. The XT 17000 has a Volume Control which

XT17000 Manual

(8)

incorporates the ON / OFF switch. When the Volume Control is turned fully counter-clockwise the XT 17000 is OFF. Turn the Volume Control Clockwise and the XT 17000 "clicks" ON.

The Volume Control also enables you to control the volume of signals received from various objects. As you turn the knob clockwise the volume of signals increases.

This control is a volume limiter. As the Control is turned further clockwise the maximum signal volume available increases while the level of the threshold volume remains constant. This is a very useful feature when using headphones as very loud signals can be limited thus preventing ear damage, whilst maintaining full response to small signals.



Figure 6. Volume



Figure 7. Threshold

### 5.2 THRESHOLD CONTROL

The Threshold Control is located in the bottom left corner of the Control Panel. This control is used to set the background sound level or "Threshold Tone".

The Threshold Control should be set just a slight turn of the knob past the point where the tone is just audible, but not at a level where prolonged use could be irritating.

It is important to know that small objects and large, deep objects may not produce a distinct signal but rather only cause a slight change in the threshold.

You are likely to encounter excessive "spurious" noises if you search in variable ground using this setting. Use this mode to pin-point an object which gives a faint signal under "normal" circumstances.

The "Enhance" mode is specially designed to enable the detection of small and medium size nuggets in highly variable ground. In this mode, a detected signal also alters the frequency of the response. The ear is more sensitive to such changes and thereby you can detect small responses more accurately. Excessive numbers of "hot rocks" may make this mode ineffective in some grounds.



**Figure 9. Sound Switch**

**Figure 10. Soil Switch**

### 5.7 SOIL SWITCH

The Soil Switch is located in the centre, at the top of the Control Panel. This toggle switch should always be set on the "Normal" position for ground that is not highly mineralised.

In highly mineralised or "hot ground", which will be very noisy and produce large variable responses, the "Difficult" setting should be used. In "Difficult" the sensitivity will be reduced slightly and should be selected only for ground concentrated in ironstone or mineralisation.

If the detector produces a high pitch "squeal", called the Overload Signal, this indicates that the ground is extremely "hot" or there is a very large object close to the Search Coil. If the Overload Signal is caused by "hot" ground, set the Soil Switch to "Difficult".

### 5.8 FREQUENCY SWITCH

The Frequency Switch is located in the top right hand corner of the Control Panel next to the Loudspeaker. The XT 17000 has 2 operating frequencies; these are 6.4 kHz and 32 kHz. As a general rule 6.4 kHz is better for larger, deeper nuggets and 32 kHz is better for smaller nuggets nearer the surface.

It will be necessary to wait a few seconds for the Automatic Ground Balance to readjust after changing frequency. There will be a period of 2 seconds after changing frequencies when the detector will not detect any objects.



**Figure 11. Frequency Switch** **Figure 12. Discriminator**

### 5.9 DISCRIMINATE CONTROL

The Discriminate Control is located at the centre, left of the Control Panel. The discriminator is a useful aid to gold prospecting when its limitations are fully appreciated and the operator understands the conditions under which it will be reliable.

It requires a proper understanding of the following paragraphs as well as the skill gained from practice and experience. **Many experienced users recommend that you dig all objects detected.**

Unlike the discriminator on the GT 16000 and the FT 16000 the discriminator of the XT 17000 is only ferrous / non-ferrous, to the limit of its accuracy.



Use of the XT 17000 discriminating mode will not sacrifice sensitivity or depth, but it will not necessarily discriminate at the full depth at which the object can be detected.

The discriminator is "off" or in "All metal" mode when the knob is turned completely counter-clockwise until it clicks "off". A slight clockwise turn to setting "1" will switch the discriminator "On" to Ferrous / Non-ferrous discrimination mode with minimum sensitivity. Ferrous objects will be signaled by staccato-like sounds which are noticeably different from the non-ferrous sound.

A unique feature of the discriminator is its ability to read the degree of ground interference in the process of discrimination. The detector automatically adjusts its discriminating power depending on the type of ground present, thereby achieving the maximum reliable discrimination depth. Thus in "mild" ground the detector will discriminate accurately at greater depth while in "hot" ground the discrimination depth is reduced to maintain reliable discrimination.

At all times, however, an audible "object" sound is heard without loss of sensitivity so that no object can be missed.

If the detector head is held in the air or stationary over the ground for an extended period of time the discrimination sensitivity increases to maximum. If it is then used on "hot" ground, false discriminatory signals will first appear. After a short time the detector will adjust to its new condition and the discriminatory power will be correctly adjusted.

### 5.9.1 DISCRIMINATING IN "HOT" GROUND

The best procedure for attempting to discriminate in "hot" ground is to move the search coil over the ground near the object (but not close enough to produce the object sound) to allow it to "read" the ground conditions and then pass it over the object.

Repeated movement over a ferrous object will again desensitize the discriminator and false readings will begin to occur. During this procedure it is very important to move the search coil across the ground keeping it at the same height.

XT17000 Manual

(14)

### 5.9.2 DISCRIMINATING WITHIN HOLES

The discriminator must NOT be used to test the object in a hole that has been dug in the process of retrieving the object. Moving the Search Coil within a hole will often produce a false signal.

Similarly the discriminator should not be used to test an object within a pile of soil which has been taken from this hole as again false signals are likely to occur, particularly in highly mineralised ground.

The discriminator will give the most reliable result when the object is tested while it is on or within undisturbed ground. In all other cases it is likely to be unreliable.

### 5.9.3 ADDITIONAL CONTROL OF THE DISCRIMINATOR

The operator has some additional control over the sensitivity of the discriminator. As the knob is turned further clockwise, the sensitivity of the discriminator increases. That is, the XT 17000 will be able to indicate whether an object is ferrous at greater depths.

The depth to which an object can be detected will be unchanged, it is just the depth at which discrimination can be achieved that increases. The chance of the discriminator making a mistake also increases when the Discriminator Control is turned to greater sensitivity. Therefore this setting must be used with great caution otherwise valuable objects may be overlooked.

Experience is the best guide, the operator must be able to recognize the conditions which permit a high degree of discrimination i.e. extremely mild soil or sand.

When the search coil is passed over large objects near the surface, the discriminator electronics may sometimes overload. This is indicated by a high pitch "chirp" or "bell" ringing sound. Either sweep the search coil further from the object or set the Soil Switch to "Difficult".

XT17000 Manual

(15)

## 6.0 SEARCH COILS

### 6.1 8" ROUND GOLDSEARCH COIL

The "Double D" configuration of this coil is ideal for locating deep targets in variable ground particularly in the 6.4 kHz mode.

The detection pattern is "blade like" and is sensitive across almost its complete width; this allows more ground to be searched with each sweep than with concentric coil configurations.

It will be easier to locate larger, deep objects with the "Double D" than the concentric, however very small objects near the surface may be harder to pin-point.

The 8" round coil is suitable also in the 32 kHz mode but for optimum performance use the 10" Elliptical coil.

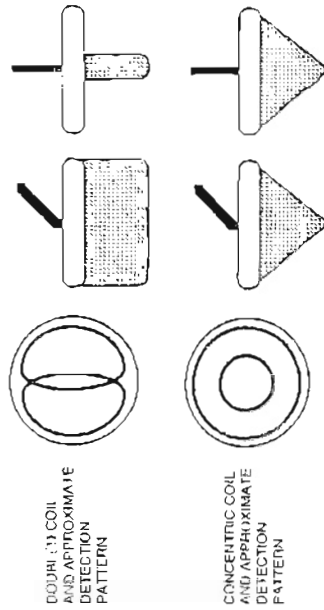

Figure 14. Coil Detection Patterns

### 6.2 10" ELLIPTICAL GOLDSEARCH COIL

This coil is also a Double D configuration, is designed to be used in the 32 kHz mode and is excellent for locating very small objects on or near the surface of the ground.

XT17000 Manual (17)

The discriminator may sound where a "target" and a "non-target" object are close together. Consequently, most experienced users recommend that you retrieve all detected objects.

### 5.10 GROUND BALANCE SWITCH

The Ground Balance Switch is in the centre of the Control Panel. It has two positions, **Track** and **Fix**. In both positions the XT 17000 is a motion detector; that is, the coil must be moving over the object for it to be detected. If the coil is stationary there will be no response.

In the **Track** mode, the XT 17000 is an Automatic Ground Balance Detector. This means the detector continually adjusts its Ground Balance setting to maintain "tune" with the ground which will greatly reduce noises caused by ground interference.

In the **Fix** mode, the XT 17000 will no longer follow the changes in the ground mineralisation but will remain set at the ground balance setting produced by the last use of the track position.



Figure 13. Ground Balance Switch/ Tracking Switch

This mode is useful when detecting over suspected deep objects after ground balancing on a nearby patch of ground. It is also useful when testing soil from a hole for the presence of objects.

It is important to know that a deep object may be "balanced" out by continual sweeping over it when pin-pointing in the "Track" mode. By balancing next to the object and the switching to the "Fix" mode, the object cannot be balanced out.

XT17000 Manual

(16)

## 7.2. INITIAL CONTROL SETTINGS

To begin detecting in normal conditions, the XT 17000 should be set up in the following manner.

Sound Switch: "Normal"      Ground Bal. Switch: "Track"  
Soil Switch: "Normal"      Discriminate Control: "All Metal"  
Sensitivity: "Maximum"      Tone Control: "Anywhere"  
Threshold : "Maximum"      Volume Control: "OFF"

With the coil away from the ground or metal objects, turn the Volume Control fully clockwise. After a couple of seconds the XT 17000 will settle down.

Adjust the Threshold Control fully counter-clockwise until the sound ceases. Turn the knob slightly clockwise to a point where the tone is just audible, but not at a level where prolonged use would be irritating.

Adjust the Tone Control so that the tone of the threshold is to your liking.

Ground Balance the XT 17000 by switching to the "Track" mode and then raising and lowering the Search Coil between 3 and 10 cm (1 and 4 inches) above the ground. Initially you will hear a signal each time the coil moves in one of the two directions.

After a few moments the sound will diminish with each movement until it almost vanishes. The XT 17000 is now Ground Balanced and will track the changes in ground conditions as you move.

We recommend that for maximum effectiveness in highly variable ground, you use the "Track" mode with the Sound Switch set to "Enhance".

XT17000 Manual

(19)

The search pattern of this coil is similar to the 8" round coil, however, due to its shape is easier to pin-points objects with.

For optimum performance we recommend that the 10" elliptical coil is best for use in the 32 kHz mode. It is not recommended for use in the 6.4 kHz mode as this will cause excessive battery drain.

## 7.0 OPERATING INSTRUCTIONS

### 7.1 DETECTOR SOUNDS

There are 4 basic signals the XT 17000 will produce, these are:

1. Small or large variations in the volume of the Threshold Tone which are generally produced by metal objects or ground mineralisation.
2. Low Battery Alert. This is a sharp "pip" which will occur approximately every 20 seconds when the useful life of the batteries is at an end. (See section 4)
3. Overload Signal. This is a loud high pitch "squeal" which indicates the presence of a very large object or very highly mineralised ground. To overcome this raise the Search Coil or switch the Soil Switch to Difficult.
4. Discriminator Overload Signal. This is a loud "Bell-ringing" sound indicating that the XT 17000 has detected a signal too large for the discriminator to accurately process. To overcome this raise the Search Coil or switch the Soil Switch to Difficult or turn the Discriminator "OFF".

Note: The Discriminator will overload well before the XT 17000 will overload in All Metal.

It is important to remember to keep the coil parallel at all times and be aware that there is a tendency for the coil to be raised at the end of each sweep across the body. Figure 16 shows the correct sweeping technique.

Variation in coil height at the end of each swing can cause confusing sounds and will reduce detection depth. Keeping the Search Coil in contact with the ground will increase detection depth and response to very small objects.

Each sweep from one side of the body to the other should take between 2 and 4 seconds to complete. This speed will depend upon the soil conditions and area which you are in.

The XT 17000 is a "Motion" detector which means that in order to detect an object the coil must be moving.

### 8.2 PIN POINTING THE TARGET

After an object has been detected it is necessary to accurately determine its position to enable it to be recovered in the shortest possible time and causing the least amount of damage to the environment.

The XT 17000 has 8" and 10" Double D coils which are sensitive across their complete length enabling a large amount of ground to be searched with each sweep of the coil.

To pin point the actual location of the object detected, sweep the coil over the general area taking note of where the strongest signal is received as the coil is moved over the object. By decreasing the length of the sweep it should be possible to draw an imaginary line in the ground where the strongest signal is located (as can be seen in figure 17)

The object could be anywhere across the length of the coil so in order to pin point its exact location it will be necessary for you to turn at a 90 degree angle and repeat the sweep across the target.

XT17000 Manual

(21)

## 8.0 GENERAL DETECTING TECHNIQUES

Now that you are somewhat familiar with the operation of your new XT 17000, it is essential to learn some basic detecting techniques such as sweeping, pin pointing and digging targets.

### 8.1 SWEEPING

One of the most important detecting techniques, and perhaps one of the hardest to perfect is the sweeping of the coil across the surface of the ground.

The sweeping motion to cover the ground is shown in figure 15. It is essential that the coil sweeps are overlapped in order to ensure that all ground is searched.

Sweeping is carried out in a snaking motion along the ground to cover the area being searched.

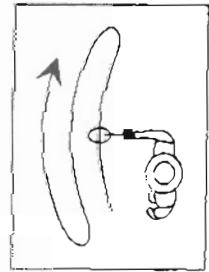
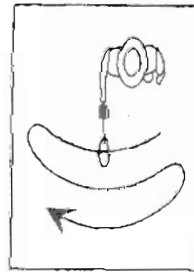

Figure 15

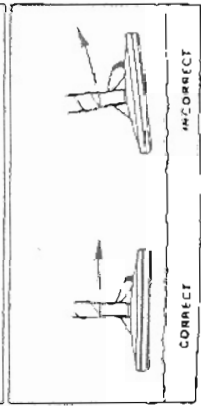
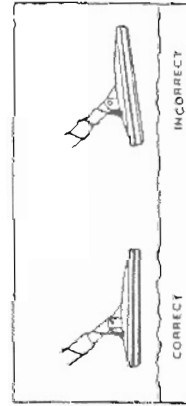

Figure 16

Firstly clear the surface material and check if the signal is still there. If there is no signal then the target must be amongst the surface material.

If the signal is still there then dig down a few inches. Dig a hole which is dish shaped, any corners on the hole may cause a false signal to occur.

If the target is not visible sweep the coil over the hole. The signal should become louder so continue to dig. If the signal has gone then the target should be in the pile you have just dug.

Take care how you dig as a swift blow to an object can split a nugget in two causing a loss in value.

If the object is not clearly visible you may need to scan the soil which has been dug up so be sure to pile the soil carefully whilst digging. The object can be located in this soil by the following methods.

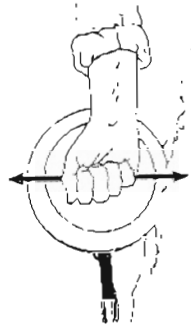

Figure 18 - Locating a target

1. Sweep the coil over the pile of soil to locate the object. (Be sure that there are no objects buried under the soil directly below the pile).
2. When the object has been removed from the hole, ensure the Ground Balance Control is in "Fix" and lay the detector down with the Search Coil flat on the ground, close by the hole.

XT17000 Manual (23)

Again take note of the point where the strongest signal is and draw another imaginary line in the ground. Where the two imaginary lines cross is where the object is located.

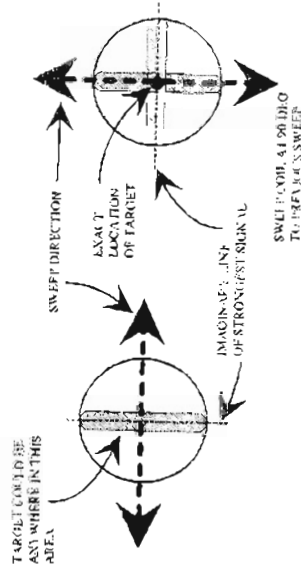

Figure 17 - Pin Pointing

### 8.3 DIGGING THE TARGET

Once you have established the exact location of the target it is necessary to dig a small hole to recover it.

In order to preserve the environment it is essential to make the hole as small as possible and always replace the soil or grass which is removed and fill in the hole.

It is a good idea to have some sought of digging tool when searching, the best tools are:

- A. A small strong digging spade
- B. A small knife for grassy areas
- C. A small pick

if you find a broad "positive" sound which you feel is probably due to mineralisation but is positive enough to make you suspect a possible deep object, pass the Search Coil in a circular path around the centre of the positive sound source, while maintaining the closest edge of the Search Coil about 2 to 3 inches from this centre.

After 2 or 3 rotations (1 to 1.5 seconds each) pass the coil directly over the centre and listen to the "positiveness" of the signal. Repeat this procedure but this time with Search Coil at right angles to the previous orientation and pass the coil over the positive sound centre at right angles to the first pass.

If both passes result in a significant positive response, dig! As the hole gets deeper keep checking for the presence of the signal by passing the detector over the hole at ground level (not at the level of the bottom of the hole).

If the signal remains clear you may well be onto something (obviously removing ground will not weaken object signals), on the other hand if the signal becomes fainter and more diffuse i.e. seems to be more spread out then the source of the signal is probably ground noise. However, keep digging until you are sure.

It is possible for gold nuggets to be entirely encased in rocks so thorough checking is necessary to ensure no gold is missed. Breaking rocks in two, then passing each section of the rock across the Search Coil, one after the other, will determine which piece contains the gold.

Sometimes "negative" hot rocks or ground "holes" are encountered. In this case the sound from the detector is reduced as it passes over the rock or "hole". The detector, on recovering from this loss of sound, can give an audible signal which to the beginner may be confused with the sound of an object. Experience will soon enable the operator to recognise this characteristic sound which is in fact quite different from an object.

XT17000 Manual

(25)

Pick up a handful of soil from the pile and pass it across the coil (as shown in figure 18). If there is no signal then place the soil in a second pile away from the first and grab another handful from the pile. Continue this process until the object is in your hand. Sift through the soil in your hand until you find the object.

Once the object has been recovered it is a good idea to run the detector over the hole again to make sure that there are no other objects to be found (it would not be the first time that objects are located under each other).

When you have recovered all objects from the hole it is advisable to search the surrounding area carefully as there is a high chance that more objects will be close by.

## 9.0. PROSPECTING TIPS

It will take time and practice until you can learn to recognize which signal to dig and which to ignore. Interfering signals are known as "ground noises". The XT 17000 is particularly good at minimising these ground noises and this is the reason for the exceptional depth capability, however even with this detector some ground noises will occur particularly in heavily mineralised ground.

### 9.1. MINERALISATION AND HOT ROCKS

Typically mineralised ground can make a detector respond with an indication that there might be an object reasonably deep beneath the surface. The sound could be rather broad and not very loud, or sometimes crisp and reasonably sharp.

Other noises which most affect detectors are "hot rocks". These are rocks rich in iron which can have very strong audio signals. With the strong ones, some detectors have problems in tuning them out, but with the XT 17000 signals from hot rocks are not as great a problem.

XT17000 Manual

(24)

best to continue to dig until the reason for the signal becomes clear. (Note: Once the charcoal is removed from the ground the signal will vanish.)

## 10.0. ENVIRONMENTAL CONCERNS

To preserve the environment and our hobby of metal detecting, it is important that all the holes you dig are refilled properly. Not only is it environmentally unacceptable to not fill in your holes but it is also very dangerous.

Please take with you any junk that you find and dispose of properly. Leaving an area "scarred" can result in action being taken to prevent the use of metal detectors and spoiling this fascinating hobby for others as well as yourself. This has already happened in many productive areas which are now lost to the detector operator.

## 11.0 DETECTOR CARE AND TROUBLE-SHOOTING

### 11.1 PROPER CARE OF YOUR DETECTOR

The XT 17000 is a high quality electronic instrument, finely engineered and packaged in a durable housing. Taking proper care is mostly common sense.

1. Do not leave batteries in the Control Box when the detector is not in use for a period exceeding two weeks. Damage caused by leaking batteries can be severe and will void your warranty.
2. If temperatures are very high, do not leave the detector in the sun longer than necessary. Covering it from direct sunlight will help protect it. Try to avoid leaving it in a closed trunk or the car sitting in the sunlight.

XT17000 Manual

(27)

### 6.2. CLAY DOMES

A common occurrence in nugget bearing country is soil mineralisation known as "clay domes". These are regions of rather broad sound which can be confused with the sound which would come from a deep large nugget. The following procedure will quickly establish whether or not the sound comes from clay or a metal object.

1. Remove about 4 cm (1.5") of soil in a broad 30 cm diameter circle with no sharp edges. This will allow the Search Coil to approach the "object" by about 4 cm. Now with the coil in this lowered position over the hole attempt to ground balance the signal.
2. If ground balance can be achieved then this source of sound is probably clay, since it is not possible to ground balance a metal object which has been brought closer to the coil. In addition, the signal from a metal object is greatly enhanced when the object is brought even slightly closer to the coil.
3. Be careful that the edges of the shallow hole are not producing spurious signals. The technique requires practice and experience but it is essential to develop a good technique to avoid digging many deep holes unnecessarily.

### 6.3. CHARCOAL

Charcoal can sound loud at times and rather like a metallic object when close to the surface. Charcoal is usually created by farmers burning off tree stumps or by bushfires. The growth is burnt below the ground level, so it is not always obvious what the sounds are until you have actually dug up the causes of these noises a few times.

Again, experience will teach the operator how to read the ground efficiently and gain understanding of the detector's response to the ground. An indication of charcoal is that the sound seems more spread out than the object and becomes more patchy as the ground is dug, however for inexperienced operators it is

XT17000 Manual

(26)

## 12.0 WARRANTY

Your new XT 17000 has a specified warranty. The most important points relating to the product warranty for the detector and its parts are contained in the following paragraph. For the complete warranty details please consult your warranty card.

Minelab Electronics Pty Ltd warrants the control box for a period of two years (parts and labour) and the coil for a period of one year (parts and labour).

## 13.0 SPECIFICATIONS AND PATENTS

These are subject to modification without notice.

Length	Extended Unassembled	1350 mm (53") 840 mm (33")
Weight	Complete (excluding batteries) Control Box ("") Shaft and Search Coil	1620g 620g 925g
Frequency	VLF search	6.4 kHz & 32kHz

Ground Rejection Automatic with no loss of sensitivity in all modes

Search Modes Tracking Ground Balance, Motion with Threshold  
Fixed Ground Balance while searching, Motion with Threshold.  
Discrimination All metal / Variable: adjustable control

Controls	Threshold adjustment ("tuning")	1 Turn
	Discriminator	1 Turn
	Sensitivity	1 Turn
	Volume	1 Turn
	Tone	Screwdriver adjustment
		(29)

XT17000 Manual

3. The Search Coil housing will wear through if you scrub the ground with it while searching. We recommend that you use an easily replaceable skid plate to protect it.
4. The hipmount bag is designed to protect the Control Box, especially from dust, mist and rain. It will also cushion potentially damaging knocks. Use the bag where possible.
5. Whilst the Control Box has been designed to be water resistant, it is not waterproof. Avoid wetting it unnecessarily. Never allow the box to come into contact with petrol or other oil based liquids.
6. Should the Search Coil be used in salt water, it must be washed with fresh water. Keep the unit dry and clean and avoid getting sand and grit into the shafts or the tightening nuts. Do not use solvents to clean the detector. Use a damp cloth with mild soap detergent.

### 11.2 TROUBLE-SHOOTING

If your detector is not performing satisfactorily please check the following:

**Batteries.** Many detector problems are caused by flat or faulty batteries. Ensure the NiCad batteries are correctly maintained- see batteries section. If using penlite or "AA" cells only use Alkaline batteries.

**Cables.** Ensure the Coil cable is in good condition and not subject to undue stress. Tighten the cable connector as a loose connection may cause false signals to occur.

**Interference.** The XT 17000 is a very sensitive VLF radio receiver. There are many external sources of noise that may affect the performance of the detector; these include: another detector in close proximity, high power transmitters, power lines and electric fences. To overcome false signals reduce the sensitivity control.



Controls	Ground Balance Sound	Automatic / Fix 3 position switch
Search Coils	Type	Round
	Windings Size (diameter)	Double-D 203 mm (8")
	Weight	475 g
	Cable length	2.3 m
	Type	Elliptical
	Windings Size (diameter)	Double-D 250 x 135 mm (10")
	Weight	388 g
	Cable length	2.3 m
	Audio Output/Audio booster	Yes
	Enhanced Mode	Yes
Speaker	Moisture resistant	51 mm (2")
Headphone jack	stereo/mono	1/4"
Built in Arm Rest & Detector Stand		Yes
Type	Shaftmount	Yes
	Hipmount	Yes
	Strapmount	Yes
Batteries	NiCad	12V, 600 mA Hr or more
	Number of cells	10
	Duration	10 to 15 hrs
	Battery low alert	High pitched beep for 1/2 sec. every 30 sec. when becoming flat.
Warranty	Control Box - 2 years parts and labour, limited Search Coil - 1 year parts and labour, limited	
Patents	US 4894618, AUS 595835, CAN 1260146, US 4890064, others pending.	

## Free Manuals Download Website

<http://myh66.com>

<http://usermanuals.us>

<http://www.somanuals.com>

<http://www.4manuals.cc>

<http://www.manual-lib.com>

<http://www.404manual.com>

<http://www.luxmanual.com>

<http://aubethermostatmanual.com>

Golf course search by state

<http://golfingnear.com>

Email search by domain

<http://emailbydomain.com>

Auto manuals search

<http://auto.somanuals.com>

TV manuals search

<http://tv.somanuals.com>