

DX User IP II - Quick Start Guide



1. Introduction

To take advantage of the DX User IP II full range of features, we recommend you read the softcopy User Guide after performing the Quick Start procedure. It's in PDF format on the supplied CD or on our website www.minicom.com in the Support section.

Figure 1 illustrates the basic configuration of the DX system with the DX User IP II and DX Users connected to peripheral devices via the DX Central.

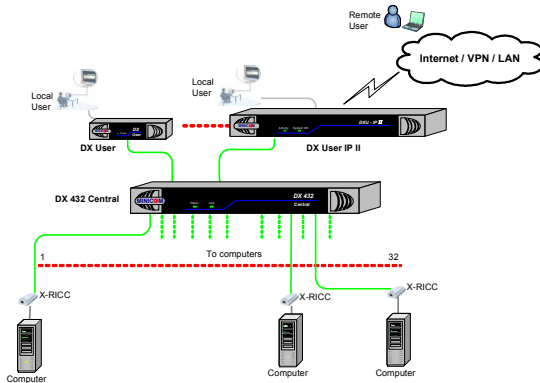

Figure 1 DX User IP II usage scenario

Technical support - support@minicom.com

© 2009 Copyright Minicom Advanced Systems. All rights reserved.
SUM60000 V1.2 9/09

1.1 Standalone mode or KVM.net

DX User IP II can be used in any of the following 3 modes:

- Standalone
- KVM.net enabled
- KVM.net managed

KVM.net is a centralized IP based system for secure control of servers and network devices, power and user administration in the data center environment. KVM.net combines Out-Of-Band, KVM via IP access with modern IT standards and requirements. It is the most comprehensive remote server maintenance solution available in the market today.

These 3 modes are now explained.

1.1.1 Standalone mode

Standalone mode refers to using the DX User IP II as part of the DX system only and working via the DX AIM interface without KVM.net, for remote KVM access and control via a LAN or Internet connection.

1.1.2 KVM.net enabled / managed

The DX User IP II can be KVM.net enabled or KVM.net managed. Both of these refer to managing and accessing servers connected to the DX system via the KVM.net Manager.

KVM.net enabled means the DX is still capable of working in Standalone mode. KVM.net managed means the DX is fully managed and controlled by KVM.net, access to the AIM interface is blocked but can be achieved where necessary via hotkeys. Details of the differences between KVM.net enabled and managed will be explained in the configuration and operating sections later on in this Guide.

2. DX User IP II front panel

Figure 2 illustrates the DX User IP II front panel.

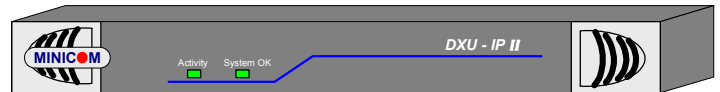

Figure 2 Front panel

The table below explains the functions of the front panel LEDs.

1

QUICK START GUIDE

LED	Function
Activity	LED solid when a remote user operates the DXU IP II
System OK	LED solid when DX User IP II connected and functioning

2.1 DX User IP II rear panel

Figure 3 illustrates the rear panel of the DX User IP II.

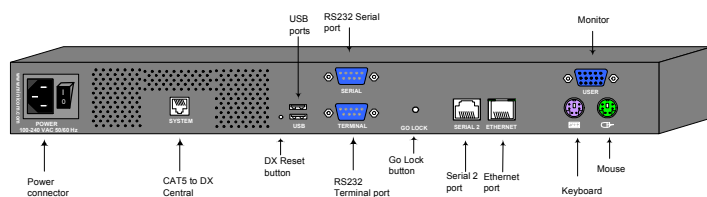

Figure 3 DX User IP II rear panel ports

DX Reset button

The DX Reset button resets the DX parts of the DX User IP II.

Go Lock button

The Go Lock button disconnects the active remote session and returns control to the local user.

Serial / Serial 2 port

The Serial port is only used for KVM.net managed mode when the DX User IP II is the Master Console – (explained in the softcopy User Guide).

In Standalone and KVM.net enable modes, the Serial 2 port can be used for any RS232 application, e.g. managing a router or power switch.

Terminal port

In Standalone and KVM.net enable modes only, when there are X-RICC RS232s in the DX system, you can control them locally through an RS232 terminal connected to the DX User IP II.

Ethernet - Connects the DX User IP II to an Ethernet network.

DX USER IP II

USB ports

Update the DXU firmware via a Minicom Flash USB key. See the DX User Guide for information on updating firmware.

System port – Used to connect the DX User IP II to the DX Central.

KVM ports – Used for optional local console.

3. Pre-installation guidelines

- Place cables away from fluorescent lights, air conditioners, and machines that are likely to generate electrical noise
- The maximum distance between each device (computer, KVM switch or second level DX Central) and the DX Central is 100m/330ft. The maximum distance between the DX Central and the DX User IP II is also 100m/330ft. For best performance place the DXU IP II as close as possible to the DX Central.

4. Connecting the DX User IP II

Figure 4 below illustrates the connections of the DX User IP to the DX system. See below for more details.

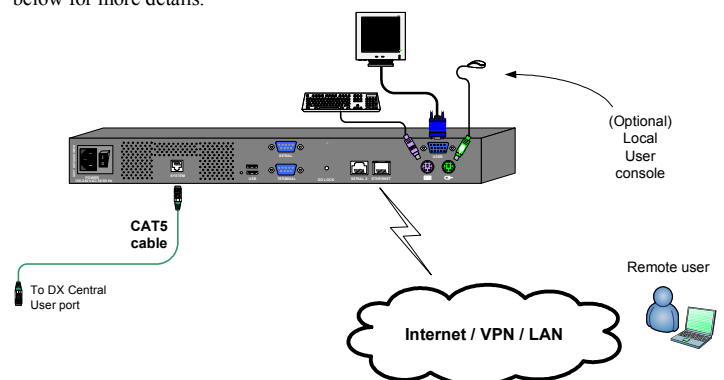

Figure 4 DX User IP connections

4.1 Connecting the DX User IP to the WAN/LAN

The Ethernet connector on the DX User IP II can be used either for a 100 Mbps 100BASE-TX connection or for a 10 Mbps 10BASE-T connection. The adapter adjusts to the appropriate operation mode automatically.

To connect to a LAN/WAN, connect an Ethernet cable to the DX User IP II Ethernet port and the Network switch.

4.2 Connecting the DX User IP II to the DX Central unit

For **KVM.net managed** mode connect a CAT5 cable to the DX User IP II System port and to DX Central User port 1. This DX User IP II must be assigned as the Master Console – (explained in the softcopy User Guide). Where there are more than one IP devices in the DX system, (e.g. DX User IP II units or IP Access connected to a DX User unit etc), one of them must be connected to User port 1 of the DX Central. The others can be connected to any other User port number.

For **Standalone and KVM.net enabled** modes connect a CAT5 cable to the DX User IP II System port and to any DX Central User port.

4.3 Local User

To use the DX User IP II locally, connect a keyboard, video and mouse, as illustrated in Figure 4.

4.4 Serial cable - KVM.net managed mode only

The Serial cable is only used when this DX User IP II is assigned to be the Master Console in KVM.net managed mode (explained in the softcopy User Guide). Note! The Master Console IP device must be connected to User Port 1 of the DX Central unit.

Connect the Serial cable as illustrated below.

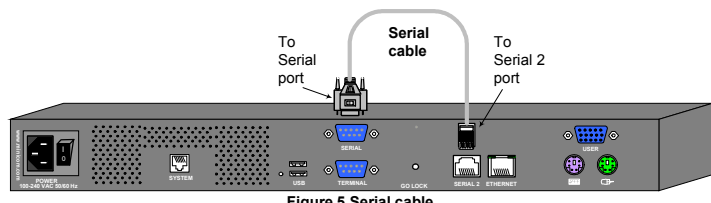

Figure 5 Serial cable

4.4.1 Order of powering on

Connect the DX User IP to the power supply using the power cord provided.

The devices and servers can be powered on at any time. Power on the DX components in the following order:

1. The DX Central.
2. The DX User IP II unit.

5. Configuring the system – web interface

How exactly to configure the system depends on how the DX User IP II is being used. There are 3 possible options - Standalone, KVM.net enabled or KVM.net managed. Explained in the softcopy User Guide.

5.1 Initial settings - Default IP address

By default, DXU IP II boots with an automatically assigned IP address from a DHCP (Dynamic Host Configuration Protocol) server on the network. The DHCP server provides a valid IP address, gateway address and subnet mask.

To identify the IP address, the DXU IP II MAC address appears on the underside of the DXU IP II box. The device number (D.N.) can also be found there.

If no DHCP server is found on the network, DXU IP II boots with the static IP address: 192.168.0.155.

Note! If a DHCP server later becomes available, the unit picks up the IP settings from DHCP server. To keep the static IP address, disable DHCP – explained in the softcopy User Guide.

5.2 Logging into the Web interface

Complete the initial setup via the Web configuration interface:

1. Open your Web browser (Internet Explorer version 6.0 or higher).
2. Type the DXU IP II system IP address - `https://IP address/config` - and press **Enter**.
3. Type the default Administrator user name - **admin** - and password - **access** - (both lower case).
4. Press **Enter**. The Web interface opens at the Network Configuration page. See Figure 6.



Figure 6 DXU IP II Web interface

Consult your Network Administrator for the network settings. See the softcopy User Guide for more information on configuring the system.

6. Operating the system

From a remote computer console open Internet Explorer (6.0 and above) and type the DXU IP IP's IP address. `https://IP address`. The DX Login page appears. Type the username and password and press Enter. By default, the user name is: **admin** and the password is **admin**, (both lower case). The DX AIM appears, see Figure 7. Login to AIM and use the IP toolbar for switching between the servers.

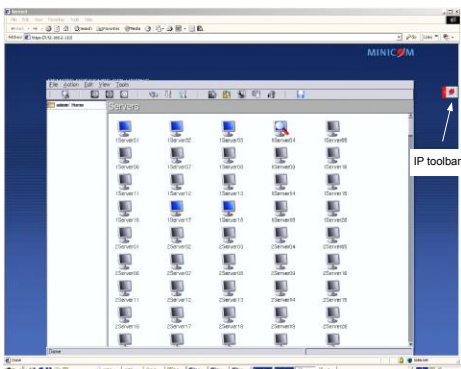

Figure 7 Servers page



When access is via IP, you should not switch to the servers/devices using the DX AIM, but only via the IP toolbar, see Figure 7.

6.1.1 Accessing a server/device

To connect to a server/device:

Important!

Accessing or switching to the servers from the IP toolbar, only works when the DX AIM is on the Servers/Devices page, see Figure 7.

1. Select **View/Servers/Devices** to display the Servers/Devices page.
2. From the Toolbar, click  or right-click . A list of connected servers/devices the user has permission to access appears. **Note!** These are the server names as configured in the IP interface and not the DX AIM interface – we recommend giving the servers the same names in both the IP and DX portions.
3. Click the desired server or Serial device. The screen of the server or the Serial device window appears..
4. To switch to a different server repeat steps 1 and 2 above.
5. To display the DX AIM press the left **Shift** key twice.
6. On logging out and then logging in again, the screen of the last accessed server/device appears.

6.2 Accessing servers/devices via KVM.net

When the DX User IP II is in KVM.net enabled and managed modes: From the KVM.net GUI, Targets are accessed from the My Targets folder. See the KVM.net User Guide for further details. Note! Only permitted Targets appear in the list.

For the rest of the configuration and operating instructions please see the softcopy User Guide on the supplied CD or on our website
<http://www.minicom.com/supportusersguides.htm>

Free Manuals Download Website

<http://myh66.com>

<http://usermanuals.us>

<http://www.somanuals.com>

<http://www.4manuals.cc>

<http://www.manual-lib.com>

<http://www.404manual.com>

<http://www.luxmanual.com>

<http://aubethermostatmanual.com>

Golf course search by state

<http://golfingnear.com>

Email search by domain

<http://emailbydomain.com>

Auto manuals search

<http://auto.somanuals.com>

TV manuals search

<http://tv.somanuals.com>