

Operating Instructions

Digital AV Mixer

AG-MX70P

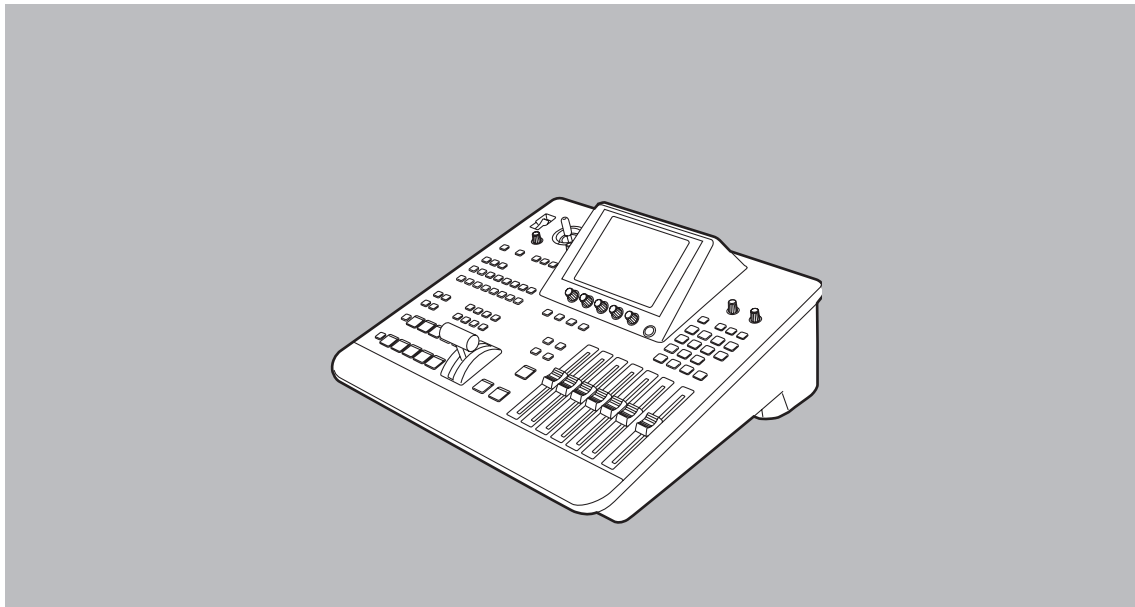

Panasonic[®]

Before attempting to connect, operate or adjust this product, please read these instructions completely.





CAUTION
RISK OF ELECTRIC SHOCK
DO NOT OPEN



CAUTION: TO REDUCE THE RISK OF ELECTRIC SHOCK,
DO NOT REMOVE COVER (OR BACK).
NO USER SERVICEABLE PARTS INSIDE.
REFER TO SERVICING TO QUALIFIED SERVICE PERSONNEL.



The lightning flash with arrowhead symbol, within an equilateral triangle, is intended to alert the user to the presence of uninsulated "dangerous voltage" within the product's enclosure that may be of sufficient magnitude to constitute a risk of electric shock to persons.



The exclamation point within an equilateral triangle is intended to alert the user to the presence of important operating and maintenance (service) instructions in the literature accompanying the appliance.

WARNING:

TO REDUCE THE RISK OF FIRE OR SHOCK HAZARD, DO NOT EXPOSE THIS EQUIPMENT TO RAIN OR MOISTURE.

WARNING:

TO REDUCE THE RISK OF FIRE OR SHOCK HAZARD, KEEP THIS EQUIPMENT AWAY FROM ALL LIQUIDS—USE AND STORE ONLY IN LOCATIONS WHICH ARE NOT EXPOSED TO THE RISK OF DRIPPING OR SPLASHING LIQUIDS, AND DO NOT PLACE ANY LIQUID CONTAINERS ON TOP OF THE EQUIPMENT.

CAUTION:

TO REDUCE THE RISK OF FIRE OR SHOCK HAZARD, REFER MOUNTING OF THE OPTIONAL INTERFACE BOARD TO QUALIFIED SERVICE PERSONNEL.

FCC Note:

This device complies with Part 15 of the FCC Rules. To assure continued compliance follow the attached installation instructions and do not make any unauthorized modifications.

This equipment has been tested and found to comply with the limits for a class A digital device, pursuant to Part 15 of the FCC Rules. These limits are designed to provide reasonable protection against harmful interference when the equipment is operated in a commercial environment. This equipment generates, uses, and can radiate radio frequency energy and, if not installed and used in accordance with the instruction manual, may cause harmful interference to radio communications. Operation of this equipment in a residential area is likely to cause harmful interference in which case the user will be required to correct the interference at his own expense.

CAUTION:

TO REDUCE THE RISK OF FIRE OR SHOCK HAZARD AND ANNOYING INTERFERENCE, USE THE RECOMMENDED ACCESSORIES ONLY.

CAUTION:

Do not install or place this unit in a bookcase, built-in cabinet or any other confined space in order to maintain adequate ventilation. Ensure that curtains and any other materials do not obstruct the ventilation to prevent risk of electric shock or fire hazard due to overheating.

 indicates safety information.

Overview

This digital audio mixer is designed for a host of applications including cases where the video signals of video equipment are combined through digital processing or where many different kinds of effects are added. It incorporates two frame synchronizers, a feature which makes it unnecessary for two video signals to be synchronized. Its dedicated software program, the MX-Navi, enables titles to be downloaded from a PC to facilitate the insertion of titles. In addition to the wipe, mix and digital effects, this unit comes with built-in chroma key and luminance key functions. Since its downstream keys, fade controls and audio mixers can also be used, the effects required for AB roll editing can be added by just this one unit. Connectors for connecting an external controller are also provided.

- **AB roll editing**

AB roll editing is made possible by the unit's two built-in frame synchronizers.

- **Connection of external editing controller**

The unit is equipped with GPI and RS-422A/RS-232C connectors to enable an external editing controller to be connected.

- **Digital effect functions**

By using the unit's internal digital memory, it is possible to mobilize the still, strobe, negative, mono, multi-strobe (division into 4, 9 or 16), mirror, mosaic and paint functions. Field/frame switching is possible for the still, strobe and multi functions. Ripple, multi, spark and other effects can also be provided by adding the 3D optional board (AG-VE70).

- **Audio mixing**

The unit comes with four sets of input facilities.

- **Mixed effects**

The unit provides a range of mixed effect functions enabling chroma key, luminance key, mix, wipe and DVE combinations as well as DSK and fading.

- **Internal event memory**

The unit has a built-in memory that accommodates 100 patterns.

- **Advanced reference 1 output featured**

Contents

AG-MX70

Overview	3	[Audio Effects] settings	49
Parts and their functions	6	[PAN] setting	49
Front panel controls	6	[EQ] equalizer setting	50
Rear panel connection area	14	[EQ Mid] equalizer midrange setting	50
External interfaces	17	[Voice] (voice changer) setting	50
GPI	17	[Mute] setting	50
RS-422A	17	[Setup] initial setting screen	51
RS-232C	17	[Power] (power ON) setting	52
Tally	17	[Direct Pattern] setting	52
System diagram	18	[Audio Video Input] settings	54
Power supply and backup	20	[Memory] setting	55
Setting panel screen	20	[Gen Lock] external synchronization setting	55
[INTVideo] internal video setting screen	20	[Video Format] setting	55
[Color Effects] setting screen	23	[System1] setting	56
[Video Effects] setting screen	24	[System2] setting	56
Execution of Effects	30	[Bus] setting	56
Effect-by-effect setting screens	31	[Audio Level] setting	57
[Transition] wipe pattern settings	31	[File] setting	57
[Chroma Key] setting	34	Other settings	58
[Luminance Key] and [EXT Key] (external key) settings ...	36	Event memory	58
[Title Key] setting	37	Pattern settings	58
[Basic Pattern Key] setting	38	Transition time setting	59
Other key settings	39	Transition patterns	60
DSK/Fade settings	46	Key patterns	68
[DSK Source] settings	46		
[DSK Key] settings	47		
[Crop] setting	47		
[DSK On/Off] setting	47		
[Fade] settings	48		

- “Microsoft” and “Windows” are registered trademarks of Microsoft Corporation of the United States in both the U.S. and other countries.
- “Dynamic Rounding” and the DR logo are registered trademarks of Quantel Ltd. in both the United Kingdom and other countries.

Contents

MX-Navi

About this software	74	Title data operations	86
Description of the software	74	Flow until Title data playback	86
System requirements	74	Registering Title data in the transmission list	86
Overview of MX-Navi	74	Setting the Title data playback properties	86
Processing of image data	75	Manual transmission and playback of Title data	88
By data type	75	Automatic transmission and playback of Title data	88
Display methods	75	Clearing Title data	88
DSK effects	75	Checking the Title data image	89
Image size	75	Reordering the transmission list	89
Image formats supported	75	Saving the transmission list	89
Management of the image memory	76	Opening the transmission list	89
Before use	77	Deleting Title data from the transmission list	89
AG-MX70 connections	77	Other operations	90
Installation of the USB driver	77	Checking the memory status of the AG-MX70	90
For Windows 98 and Windows 2000	77	Changing the AG-MX-70 memory settings	90
For Windows ME	78	Transmission and playback of IntVideo data	91
For Windows XP	78	Clearing IntVideo data	91
Installation of MX-Navi	79	Reading data	91
Operation confirmation	79	Recalling events	91
Startup and shutdown	80	Setting the initial properties	92
How to start up MX-Navi	80	Setting the operating environment	93
How to shut down MX-Navi	80	List of short-cut keys	94
Screen descriptions	80	Before calling for service	95
Main window	80	Specifications	97
Icon mode	80		
List mode	82		
Menu descriptions	83		
File menu	83		
Edit menu	83		
View menu	84		
Cursor menu	84		
Operation menu	85		
Tool menu	85		
Help menu	85		
		AG-YA70 & AG-VE70	
		Installation of the AG-VE70	100
		Installation of the AG-YA70	101
		Specifications	101

Parts and their functions

Front panel controls

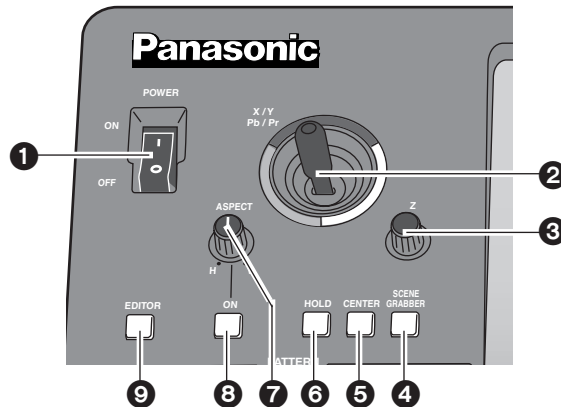

1 POWER switch

This is used to switch the AC power on and off. Select "Power" from the "Setup" initial setting screen: "Reset" is selected to establish the default setting when the power is turned ON, and "Preset" is selected to start operation using the same settings which were in effect upon conclusion of the previous operation. When [Demo] is selected, the demo mode is established after the power is turned on. The demo mode can be exited by selecting [Enter].

When the power is off, the operation panel settings are stored in the memory.

2 Joystick

The joystick is used both as the XY positioner and the controller for the color settings. It is switched as required. It can set X, Y and Z for patterns that can be positioned.

It can also set the color corrector UV white balance and chroma saturation.

It can be used as the position X/Y controller for the selection of the blue background when the chroma keys are set.

3 Rotary Z control

This control is used to set the key size Z during the key position settings and the luminance setting Y among the color settings.

4 SCENE GRABBER button

When this is set to ON with a specific key pattern, it can paste the image in the key onto the pattern and move it.

<Note>

It is possible to select either the multi-strobe or scene grabber (but not both). Whichever one was selected last takes precedence, and the previously selected effects are canceled.

5 CENTER button

Centering is performed when this button is set to ON.

In the case of color settings, the color saturation is set to zero.

In the case of position settings, the pattern is centered.

6 HOLD button

The joystick operation is stopped when this button is set to ON. However, even when this button is set to ON, the center button can be used.

Updating to the joystick value occurs when this button is set to OFF.

7 ASPECT ratio control

This control is used to set the aspect ratio for key patterns whose aspect ratio can be set. When it is turned in the H direction, the width (horizontal) is increased; when it is turned in the V direction, the height (vertical) is increased.

8 Aspect ON button

When this button is at ON, the setting performed by the aspect ratio control takes effect. When it is at OFF, the default aspect ratio (center value) is established.

9 EDITOR enable button

Editor enable can enable or disable control using RS-422A, and when control is disabled, settings can be performed by manual operations even during editing operations using RS-422A.

When the lamp of this button is lighted (ON), the settings from the editor are accepted; when it is off (OFF), the settings are canceled, and the settings can be performed manually.

Parts and their functions

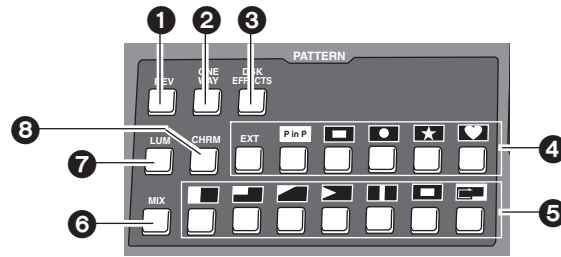

① REV (reverse) button

This button is used to reverse the keys and transition key patterns, reverse the frame in/out, and reverse the chroma key, luminance key, external key and title α key signals.

The button's lamp flashes with patterns that have no reverse operations, indicating that these patterns cannot be reversed.

② ONE WAY button

At the AB bus setting stage, this button sets the transition pattern to a pattern from one direction.

The button's lamp flashes with preset bus or program bus or with patterns that have no reverse patterns, indicating that the effects cannot be executed.

③ DSK EFFECTS button

When this button is set to the ON position, the transition pattern and 3D-DVE are used for DSK. ME is set to Diss.

When the DSK effects are ON, the chroma key and luminance key cannot be selected.

This button is set to OFF as the default setting, and some patterns cannot be used for the DSK effects.

<Note>

If DSK-Effects has been set to ON for a pattern which is not supported by DSK using a wipe pattern number, the button's lamp flashes to indicate that DSK effects cannot be applied.

④ Direct key pattern buttons

These buttons are used to call the key patterns directly. With the setup initial settings, key patterns can be set from the default settings to any patterns.

The settings accompanying borders are also stored in the memory for each button.

⑤ Direct transition pattern buttons

These buttons are used to directly call the transition patterns directly. With the setup initial settings, transition patterns can be set from the default settings to any patterns.

The settings accompanying borders are also stored in the memory for each button.

⑥ MIX button

This is used to call mix transitions.

⑦ LUM (luminance) key button

This is used to call the luminance key. When it is called, the previous setting is stored in the memory.

⑧ CHRM (chroma) key button

This is used to call the chroma key. When it is called, the previous setting is stored in the memory.

Parts and their functions

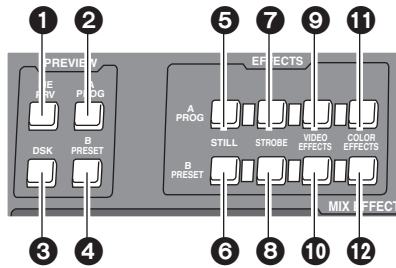

Preview output selection area

The controls in this area are used to determine which images among the transition preview, DSK preview and A/B bus images are to be output from the PREVIEW output connector on the rear panel.

① ME PRV selector button

This button is used to select ME preview as the image to be output to the preview connector. With transitions, the image of the transition destination can be previewed; with keys, combined images can be previewed.

② A/PROG bus selector button

This button is used to select the A/PROG bus as the image to be output to the preview connector.

③ B/PRESET bus selector button

This button is used to select the B/PRESET bus as the image to be output to the preview connector.

④ DSK selector button

This button is used to select the DSK combined image as the image to be output to the preview connector.

Effect execution button area

⑤ A/PROG bus / STILL execution button

This button forcibly applies the still effect to the A/PROG bus.

When it is pressed, the A/PROG video effect setting page appears on the LCD screen.

⑥ B/PRESET bus / STILL execution button

This button forcibly applies the still effect to the B/PRESET bus.

When it is pressed, the B/PRESET video effect setting page appears on the LCD screen.

⑦ A/PROG bus / STROBE execution button

This button forcibly applies the strobe effect to the A/PROG bus. The setting is performed as a [Video Effects] setting screen.

When the button is pressed, the A/PROG video effect setting page appears on the LCD screen.

⑧ B/PRESET bus / STROBE execution button

This button forcibly applies the strobe effect to the B/PRESET bus.

When the button is pressed, the B/PRESET video effect setting page appears on the LCD screen. The still and strobe field/frame setting is performed using the time effect settings of [Video Effects].

<Note>

Both still and strobe cannot be selected at the same time. Whichever one was selected last takes precedence. In the case of manual strobe, the effect is applied by pressing the button together with "Shift."

⑨ A/PROG bus / VIDEO EFFECTS execution button

This applies the mosaic, decay and other video effects set by [Video Effects] to the A/PROG bus.

When the button is pressed, the A/PROG video effect setting page appears on the LCD screen. When it is pressed together with the Shift button, the A/PROG video effect setting page can be displayed on the LCD screen without changing the ON/OFF setting of the effects.

⑩ B/PRESET bus / VIDEO EFFECTS execution button

This applies the mosaic, decay and other video effects set by [Video Effects] to the B/PRESET bus.

When it is pressed together with the Shift button, the A/PROG video effect setting page can be displayed on the LCD screen without changing the ON/OFF setting of the effects.

⑪ A/PROG bus color effect execution button

This applies the white balance, brightness adjustment and other color effects set by [Color Effects] to the A/PROG bus.

When it is pressed together with the Shift key, the A/PROG color effect setting page can be displayed on the LCD screen without changing the ON/OFF setting of the effects.

⑫ B/PRESET bus / COLOR EFFECTS execution button

This applies the white balance, brightness adjustment and other color effects set by [Color Effects] to the B/PRESET bus.

When it is pressed together with the Shift key, the B/PRESET color effect setting page can be displayed on the LCD screen without changing the ON/OFF setting of the effects.

<Note>

Both the color effects and mono effects cannot be selected at the same time. If both are selected, the mono effects always take precedence.

Parts and their functions

Setting panel area

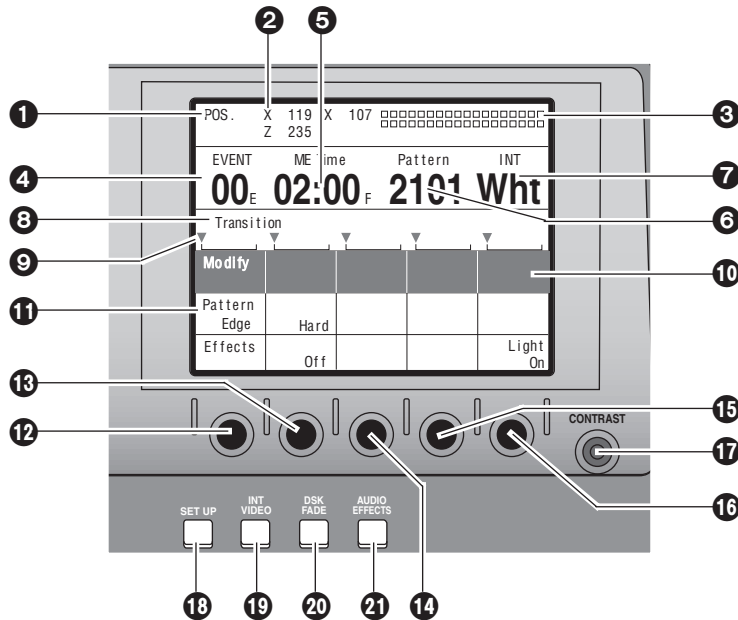

1 LCD (liquid crystal) display

The effect parameters, time settings and other information are shown on this display.

2 Joystick, Z parameter display area

During positioning, the X/Y/Z parameters are displayed here; during the color settings, the Pb/Pr/Y parameters are displayed.

3 Audio level meter

This indicates the level of the output sound.

4 Event number display area

The event numbers are displayed here.

5 Time display area

The ME, DSK and FADE transition times are displayed here.

6 Pattern number display area

The transition and key numbers are displayed here.

7 Internal (internally generated) video display area

The settings for the internal video signals are displayed here.

8 Setting page display area

The name of the page which has been set by the button operations is displayed here.

9 Rotary control setting position display area

The currently set positions of the rotary 1, 2, 3, 4 and 5 controls are displayed here.

10 Scroll bar

This displays the position on the page of the item currently displayed.

11 Item, parameter setting area

The details which are set using the setting pages are switched and displayed here. The selected settings are displayed negatively, and the parameters can each be changed using the rotary 1, 2, 3, 4 and 5 controls.

12 Rotary 1 control

This control is used to set the parameter of a selected item.

13 Rotary 2 control

This control is used to set the parameter of a selected item.

14 Rotary 3 control

This control is used to set the parameter of a selected item.

15 Rotary 4 control

This control is used to set the parameter of a selected item.

16 Rotary 5 control

This control is used to set the parameter of a selected item.

Parts and their functions

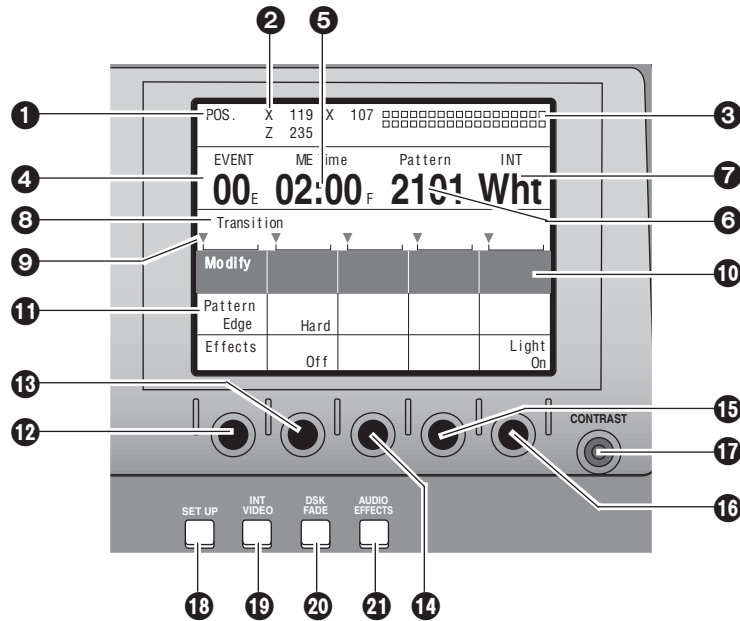

17 LCD CONTRAST control

This control is used to adjust the contrast of the LCD display.

18 SET UP (initial setting page display) button

This button displays the initial setting page.

19 INT VIDEO (internal video setting page display) button

This button displays the internal video setting page.

20 DSK FADE (DSK/fade setting page display) button

This button displays the DSK/fade setting page.

21 AUDIO EFFECTS (audio effect setting page display) button

This button displays the audio effect setting page.

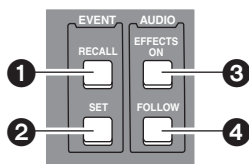

1 EVENT RECALL button

This button is used to read out events.

2 EVENT SET button

This button is used to store events in the memory.

3 AUDIO EFFECTS ON (audio effect execution) button

At the button's ON setting, the effects which were set on the audio effect setting page are executed.

4 AUDIO FOLLOW video button

This button enables the audio to be matched with the video during video ME transition or fading. Its function is supported at the ON position.

ON or OFF is preset for fading on the DSK/fade setting page.

Parts and their functions

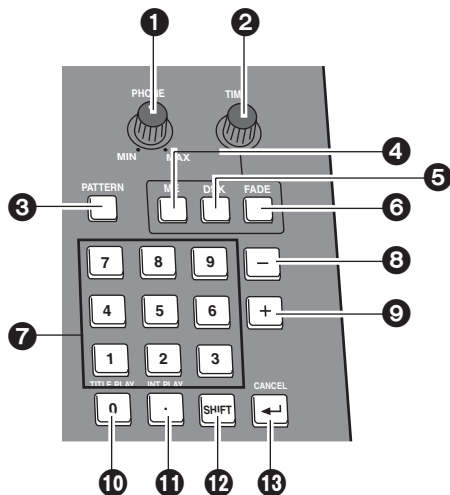

1 PHONE (headphone volume) control

This control is used to adjust the level of the rear panel headphone (PHONE) output.

The sound of the portion to be faded using the DSK/Fade setting can be monitored before fading so that it can be heard even when AudioFade is used.

The sound is output from the rear panel. Since the audio meter displays the Prog output level, it will remain unchanged even when the headphone level is changed.

2 TIME (time setting) rotary control

This control is used to set the ME, DSK and FADE transition times.

3 PATTERN (transition/key pattern number setting) button

Set this button to ON to set the pattern numbers using the number keys. At its OFF position, the time can be set using the number keys.

4 ME (ME transition/key transition time) setting button

Set this button to ON to set the time to be applied to the ME transition/key using the time setting rotary control.

When the pattern number setting button is OFF, the time can be set using the number keys.

5 DSK (DSK transition time) setting button

Set this button to ON to set the time to be applied to DSK using the time setting rotary control.

When the pattern number setting button is OFF, the time can be set using the number keys.

6 FADE (fade transition time) setting button

Set this button to ON to set the time to be applied to the FADE using the time setting rotary control.

When the pattern number setting button is OFF, the time can be set using the number keys.

7 Number keys 1 to 9

These keys can be used to input numerical values for the event numbers when the event recall button or event setting button is ON, for the pattern numbers when the event recall button or event setting button is OFF and the pattern number setting button is ON, and for the transition times when the pattern number setting button is OFF.

8 "+" key

This key is used to increment the event numbers when the event recall button or event setting button is ON, the pattern numbers when the event recall button or event setting button is OFF and the pattern number setting button is ON, and the transition times when the pattern number setting button is OFF.

9 "-" key

This key is used to decrement the event numbers when the event recall button or event setting button is ON, the pattern numbers when the event recall button or event setting button is OFF and the pattern number setting button is ON, and the transition times when the pattern number setting button is OFF.

10 0 number key

This key is used to input zeros. When it is pressed together with the shift key, the animation in the title memory now selected starts playing.

11 Period key

This key is used to enter the seconds when inputting the time.

Example: [2].[5] → 2 seconds 5 frames

When it is pressed together with the shift key, the internal video movie now selected starts playing.

12 Shift key

When this key is pressed together with another key, the resulting effect differs from the one produced when the key concerned is pressed on its own.

13 Enter key

This key is used to enter numerical values.

When "OK?" appears on the LCD display, press this key to enter the setting.

Entry is canceled when it is pressed together with the shift key.

Parts and their functions

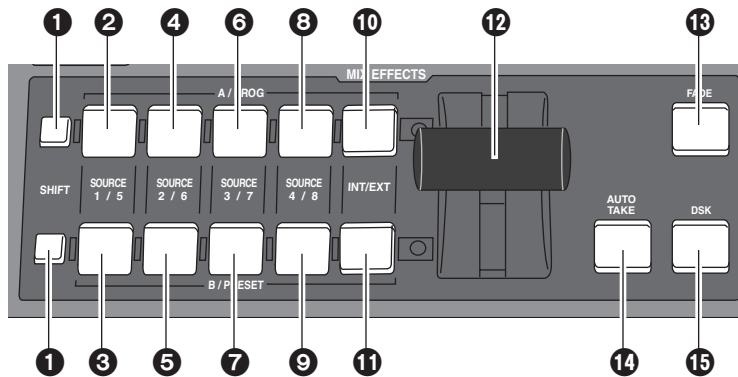

① SHIFT key

This key has the same function as the shift key for the number keys.

② A/PROG /SOURCE 1/5 selector button

This button is used to select source 1 selected by the initial settings for the A/PROG bus. When it is pressed together with the shift key, source 5 is selected.

③ B/PRESET / SOURCE 1/5 selector button

This button is used to select source 1 selected by the initial settings for the B/PRESET bus. When it is pressed together with the shift key, source 5 is selected.

④ A/PROG / SOURCE 2/6 selector button

This button is used to select source 2 selected by the initial settings for the A/PROG bus. When it is pressed together with the shift key, source 6 is selected.

⑤ B/PRESET / SOURCE 2/6 selector button

This button is used to select source 2 selected by the initial settings for the B/PRESET bus. When it is pressed together with the shift key, source 6 is selected.

⑥ A/PROG / SOURCE 3/7 selector button

This button is used to select source 3 selected by the initial settings for the A/PROG bus. When it is pressed together with the shift key, source 7 is selected.

⑦ B/PRESET / SOURCE 3/7 selector button

This button is used to select source 3 selected by the initial settings for the B/PRESET bus. When it is pressed together with the shift key, source 7 is selected.

⑧ A/PROG / SOURCE 4/8 selector button

This button is used to select source 4 selected by the initial settings for the A/PROG bus. When it is pressed together with the shift key, source 8 is selected.

⑨ B/PRESET / SOURCE 4/8 selector button

This button is used to select source 4 selected by the initial settings for the B/PRESET bus. When it is pressed together with the shift key, source 8 is selected.

⑩ A/PROG / INT/EXT selector button

This button is used to select the image (INT) selected on the internal video setting page for the A/PROG bus. When it is pressed together with the shift key, the external input (EXT) is selected.

⑪ B/PRESET / INT/EXT selector button

This button is used to select the image (INT) selected on the internal video setting page for the B/PRESET bus. When it is pressed together with the shift key, the external input (EXT) is selected.

⑫ Transition lever

This lever enables transitions to be performed manually.

⑬ FADE (fade execution) button

This button enables fade-out into the color set on the [DSK/FADE] setting page. During execution, its lamp lights; during fade-out, it flashes.

⑭ AUTO TAKE button

This button enables the ME transitions and keys to be transited automatically. During execution, its lamp lights. When it is pressed again during transiting, the transiting stops at the position where it was pressed. While the transiting is stopped, it flashes. When it is pressed again, the transiting resumes.

⑮ DSK execution button

This enables DSK which was set on the [DSK/FADE] setting page to be executed. During execution, its lamp lights; during DSK, it flashes.

Parts and their functions

Audio mixer area

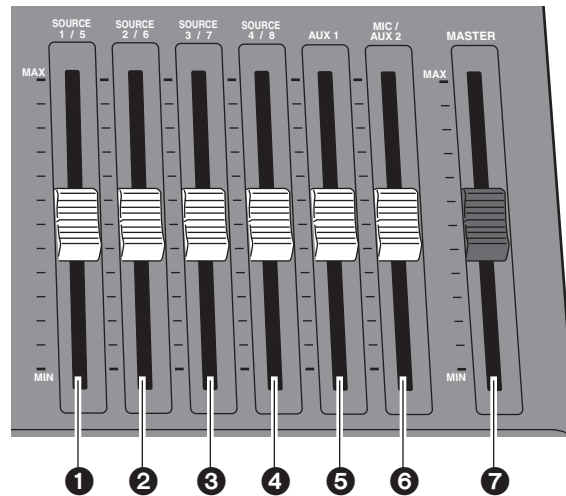

① SOURCE 1/5 fader

This fader is used to adjust the audio level of input 1 which was set on the initial setting page; when it is operated together with the shift key, it is used to adjust the audio level of input 5.

The operation of the fader lever takes effect from where the internal level and lever position match or where the higher/lower relationship between them has been reversed when the input has been switched.

② SOURCE 2/6 fader

This fader is used to adjust the audio level of input 2 which was set on the initial setting page; when it is operated together with the shift key, it is used to adjust the audio level of input 6.

The operation of the fader lever takes effect from where the internal level and lever position match or where the higher/lower relationship between them has been reversed when the input has been switched.

③ SOURCE 3/7 fader

This fader is used to adjust the audio level of input 3 which was set on the initial setting page; when it is operated together with the shift key, it is used to adjust the audio level of input 7.

The operation of the fader lever takes effect from where the internal level and lever position match or where the higher/lower relationship between them has been reversed when the input has been switched.

④ SOURCE 4/8 fader

This fader is used to adjust the audio level of input 4 which was set on the initial setting page; when it is operated together with the shift key, it is used to adjust the audio level of input 8.

The operation of the fader lever takes effect from where the internal level and lever position match or where the higher/lower relationship between them has been reversed when the input has been switched.

<Note>

The adjusted sounds of 1 to 8 are selected at the cross points and combined.

When [FOLLOW] is ON, the transition is coupled with Video. When [FOLLOW] is OFF, the transition is not coupled with Video. The sounds of both A and B are combined.

The output level can be adjusted using the MASTER fader. The effects that have been set are executed using the Audio Effects ON button.

⑤ AUX 1 fader

This fader is used to set the audio level of input AUX 1.

⑥ MIC/AUX 2 fader

This fader is used to adjust the audio level of the input AUX2 selected on the initial setting page or of MIC (sound selected by Setup).

⑦ MASTER fader

This fader is used to adjust the output level.

It executes the effects which have been set by the Audio Effects ON button.

Parts and their functions

Rear panel connection area

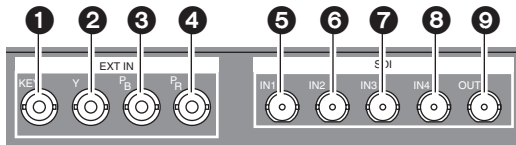

EXT IN (external key input area)

① External key input connector

This connector can be used for key or DSK applications. It can also be used for genlock signal using the settings on the initial setting page.

② External input Y connector

The cross point EXT or DSK Y signal is input to this connector.

The DSK source can be set on the DSK/FADE setting page.

③ External input PB connector

The cross point EXT or DSK PB signal is input to this connector.

④ External input PR connector

The cross point EXT or DSK PR signal is input to this connector.

<Notes>

- Non-standard signals are not accepted.
- Since the input signals do not pass through the frame synchronizers, they must be synchronized with this unit.

SDI (SDI option area)

⑤ IN1 connector

⑥ IN2 connector

⑦ IN3 connector

⑧ IN4 connector

⑨ OUT connector

The connectors listed above are used when the optional board (AG-YA70) has been installed.

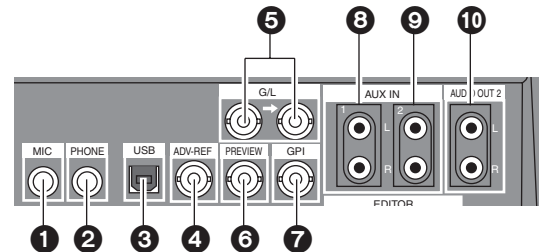

① MIC input connector

This connector can be set to MIC or AUX 2 on the initial setting page.

② PHONE (headphone) output connector

The headphones are connected to this connector.

③ USB interface connector

This connector is used to connect to a personal computer and download files.

④ ADV-REF (advanced reference) output connector

This connector outputs the reference signal with advanced vertical phase for source input uses.

⑤ G/L (genlock reference) input connectors

These are loop-through, automatically terminated connectors.

They supply signals to the source VTR or camera and initiate genlock.

They enable genlock for the G/L input or EXTKEY input by making a selection on the initial setting page.

⑥ PREVIEW output connector

The signals selected by the preview selector button are output from this connector.

⑦ GPI input connector

A trigger is applied and a transition is enabled for ME, DSK or fade as selected on the initial setting page. The effect is applied 3 frames later.

⑧ AUX IN (spare) 1 L and R input connectors AND

⑨ AUX IN (spare) 2 L and R input connectors

These connectors can be used by making a selection on the initial setting page.

⑩ AUDIO OUT 2 L and R output connectors

These are unbalanced audio output connectors.

Parts and their functions

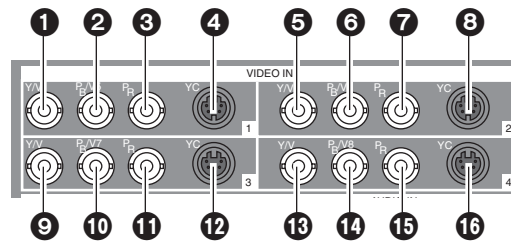

- ❶ Composite/component Y input 1 connector
- ❷ Composite 5/component P_B input 1 connector
- ❸ Component P_R input 1 connector
- ❹ YC input 1 connector
- ❺ Composite/component Y input 2 connector
- ❻ Composite 6/component P_B input 2 connector
- ❼ Component P_R input 2 connector
- ❽ YC input 2 connector
- ❾ Composite/component Y input 3 connector
- ❿ Composite 7/component P_B input 3 connector
- ⓫ Component P_R input 3 connector
- ⓬ YC input 3 connector
- ⓭ Composite/component Y input 4 connector
- ⓮ Composite 8/component P_B input 4 connector
- ⓯ Component P_R input 4 connector
- ⓰ YC input 4 connector

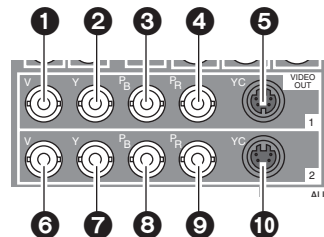

- ❶ Composite output 1 connector
- ❷ Component Y output 1 connector
- ❸ Component P_B output 1 connector
- ❹ Component P_R output 1 connector
- ❺ YC output 1 connector
- ❻ Composite output 2 connector
- ❼ Component Y output 2 connector
- ❽ Component P_B output 2 connector
- ⓫ Component P_R output 2 connector
- ⓬ YC output 2 connector

Parts and their functions

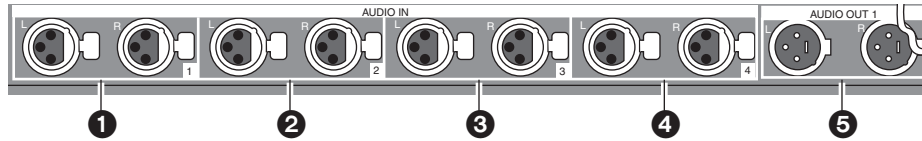

❶ Analog audio 1 input connectors

The audio signals supplied to these connectors are input to the cross point selected on the initial setting page.

❷ Analog audio 2 input connectors

The audio signals supplied to these connectors are input to the cross point selected on the initial setting page.

❸ Analog audio 3 input connectors

The audio signals supplied to these connectors are input to the cross point selected on the initial setting page.

❹ Analog audio 4 input connectors

The audio signals supplied to these connectors are input to the cross point selected on the initial setting page.

❺ Analog audio output connectors

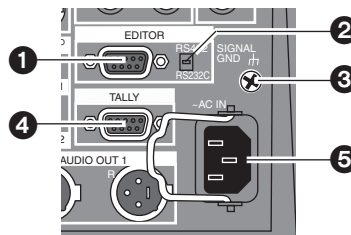

❶ EDITOR interface connector (9-pin)

This connector is used to connect the unit with an RS-422A or RS-232C controller.

❷ RS-422A/RS-232C selector switch

This is used to switch between the RS-422A and RS-232C control protocols.

❸ SIGNAL GND (ground) terminal

❹ TALLY output connector

The rear panel tally is for the cross point 1, 2, 3, 4, 5, 6, 7 or 8 output.
The connector used by the cross point is turned ON.

❺ AC IN power socket

External interfaces

This unit comes with three connectors to support four external interfaces: a GPI input connector, RS-422A/RS-232 (9-pin) connector and a Tally output connector. Select the connector that suits the editing controller model used.

■ GPI (general purpose interface)

This enables the use of auto takes with the GPI output of the external controller. At the fall of the GPI signal, wipe/mix set on the panel or DSK or Fade is executed.

■ RS-422A

This enables the AG-A850 external editing controller to be connected to the unit and the VTR to be controlled from a remote location.

● Functions that can be controlled from the AG-A850

- Wipe settings
- Mixing
- Auto take time and auto fade time settings
- Downstream key fade-in and fade-out
- Cross point source 1/source 2 (source 2/source 3 or source 3/source 4) switching
(Cross mode switching is performed by the RS-422A/RS-232C selector switch on the rear panel. Support for the editing controller is shown below.)

● Connections

- 1) Set the RS-422A/RS-232C selector switch to "RS-422A."
- 2) Connect the connecting cable from the AG-A850 to the editing controller connector on this unit.
- 3) The pin layout of the editing controller connector is shown below.

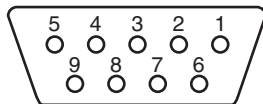

Connector (9P)

Pin No	Signal
1	FRAME GROUND
2	TRANSMIT A
3	RECEIVE B
4	RECEIVE COMMON
5	SPARE
6	TRANSMIT COMMON
7	TRANSMIT B
8	RECEIVE A
9	FRAME GROUND

■ RS-232C

This enables the unit to be controlled using a personal computer. All of the unit's functions with the exception of AUX 1 and AUX 2 can be set.

● Connection of conversion cable

RS-232C	AG-MX70
25-pin	9-pin
1 TXD	1 SPARE
3 RXD	2 RXD
4 RTS	3 TXD
5 CTS	4 DTR
6 DSR	5 SIG.G
7 SIG.G	6 DSR
20 DTR	9 SPARE

[DCE CONNECTION]

Use the above conversion with the 9-pin straight cable as well.

<Notes> Editing using the RS-422A, RS-232 and GPI interface connectors

- The commands are received and then executed 3 frames later.
- If, while the 3D optional board is installed, the 1-Frame Dly mode has been selected by the system 1 settings (see page 56) on the "Setup" initial setting screen, the pictures and sound from the source are always output with a 1-frame delay.
- When selecting a DVE pattern, set the transition time to more than 2 frames. No guarantees are made for frame accuracy if the time setting is lower than this.

■ Tally

An open connector is provided for outputting the tally lamp signals.

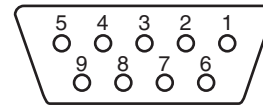

Connector (9P)

Pin No	Signal
1	Output for cross point 1
2	Output for cross point 2
3	Output for cross point 3
4	Output for cross point 4
5	Output for cross point 5
6	Output for cross point 6
7	Output for cross point 7
8	Output for cross point 8 or EXT
9	GND

System Diagram

By connecting cameras, VTRs and other video components, this unit can digitally process the video signals of these components.

Example 1 Live application (1)

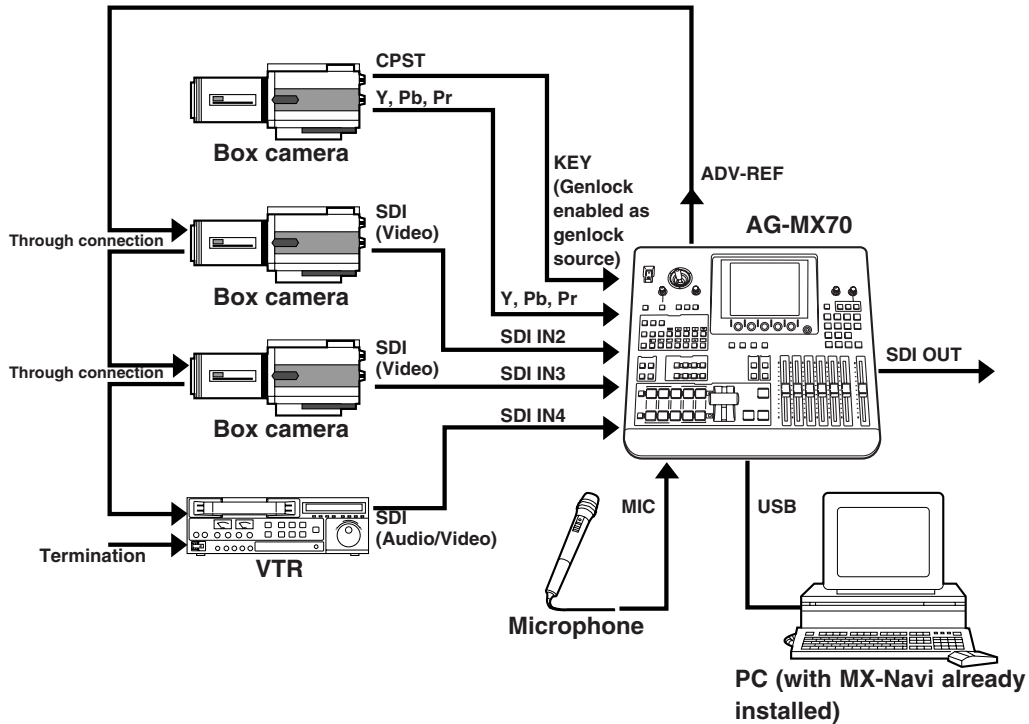

Example 2 Live application (2)

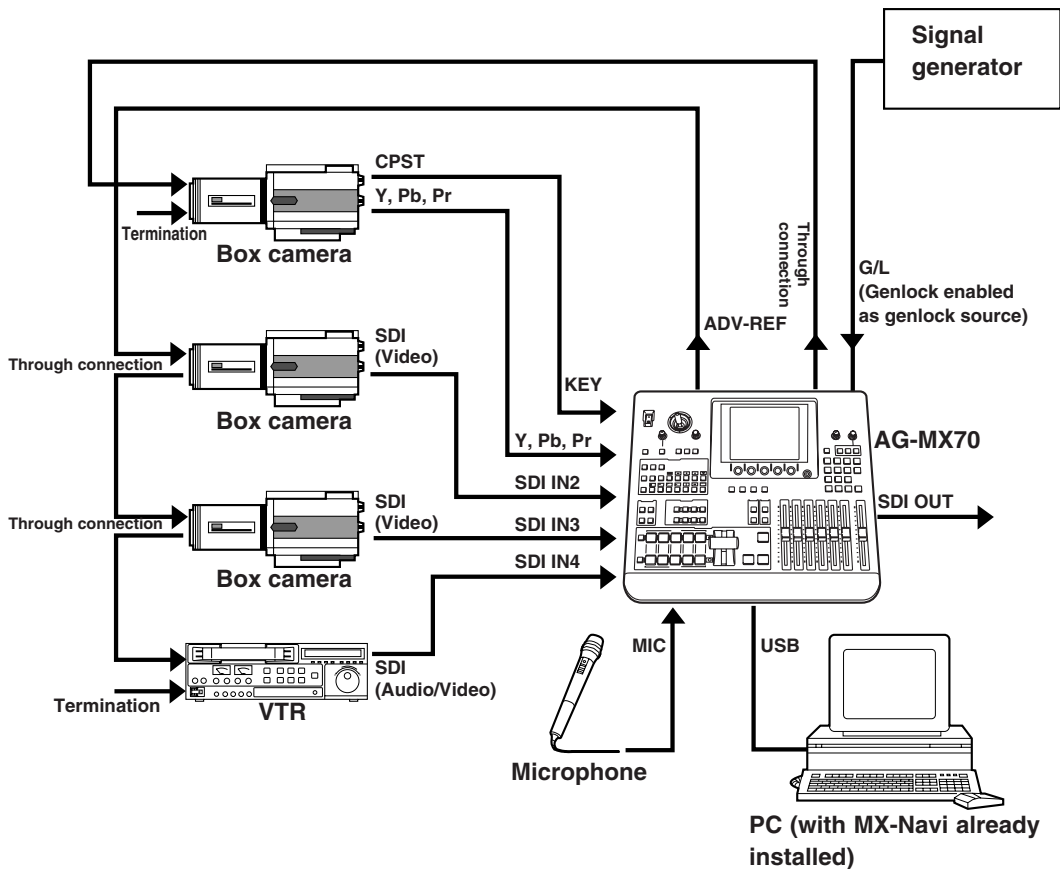

System Diagram

Example 3 Editing application

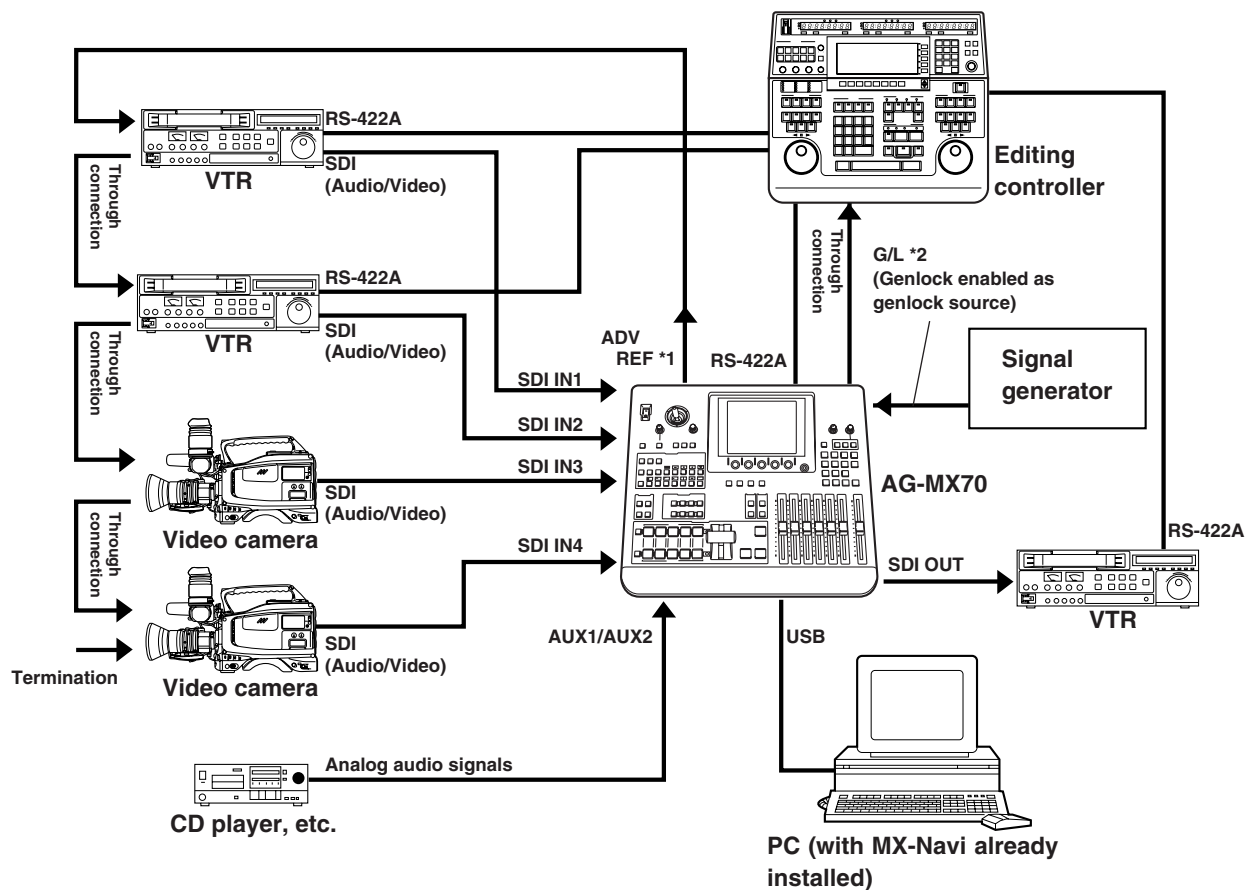

*1: Connection of the ADF REF signal is not absolutely essential but when this signal has been connected, "StillOff" can be selected by the bus setting (see page 56) on the "Setup" initial setting screen and input can be switched directly using the cross point button.

*2: ADV REF can also be used as an alternative to the G/L loop-through signal as the sync signal supplied to the AG-A850 editing controller.

[INTVideo] internal video setting screen

When [Back Matte] has been selected

The joystick XY and rotary Z control displays are set to Wash, and the wash color that is the companion color for gradation is set.

The joystick [X][Y] and rotary [Z] display change to [Pb], [Pr] and [Y], and the color can be set. [Pb][Pr] can be set to any value from 0 to 255 and [Y] to any value from 16 to 255 but only when [Custom1] or [Custom2] has been selected using rotary 2 control.

Colors are selected using the rotary 2 control. There are 10 choices: White, Yellow, Cyan, Green, Magenta, Red, Blue, Black, Custom1 and Custom2.

The color level (Y level for White) is set using the rotary 3 control. When [Custom1] or [Custom2] has been selected, either Back Matte or Wash is set.

[Pattern] (gradation pattern) is set using the rotary 4 control. There are the following nine choices.

- [Off] : No gradation
- [H1] : Horizontal gradation 1
- [H2] : Horizontal gradation 2
- [H3] : Horizontal gradation 3
- [V1] : Vertical gradation 1
- [V2] : Vertical gradation 2
- [V3] : Vertical gradation 3
- [Diag1] : Diagonal gradation 1
- [Diag2] : Diagonal gradation 2

R1	R2	R3	R4	R5
Back Matte	Color White	Level 255	Pattern H1	Grade 0
	White	Level 0 - 255	Off	0 - 255
	Yellow	Set BackM Wash	H1	
	Cyan		H2	
	Green		H3	
	Magenta		V1	
	Red		V2	
	Blue		V3	
	Black		Diag1	
	Custom1		Diag2	
	Custom2			

The [Grade] combined gradation level is set using the rotary 5 control. Any value from 0 to 255 can be set. The gradation position is set using [Shift] + rotary 5 control.

When [Custom1, 2] has been selected

The rotary 3 control is used to select whether BackM (back matte) or Wash is to be set using the joystick. With Set BackM, the joystick XY and rotary Z control at the top of the screen appear as "Matte," and with Set Wash, they appear as "Wash," enabling the respective colors to be adjusted.

The default color for Custom1 and Custom2 is black.

R1	R2	R3	R4	R5
Black Matte	Color Custom1	Set BackM	Pattern H1	Grade 0
		Set BackM Wash	Off	0 - 255
			H1	
			H2	
			H3	
			V1	
			V2	
			V3	
			Diag1	
			Diag2	

[INTVideo] internal video setting screen

When [Memory] has been selected

Described below are the write and preview procedures for “Still” (still picture) or “Movie” (moving picture). It is possible to set the number of frames (number of pages) that can be used to a maximum of 30 (NTSC) or 26 (PAL). However, if pages are allocated to titles, the number of pages will be reduced by the equivalent amount. The page allocation can be changed on the “Setup” initial setting screen.

- Write procedure

Use the rotary 5 control to set the mode to “Write.”

Use the rotary 2 control to select the page on which the images are to be written.

Use the rotary 3 control to set the number of frames to be written. Set 1 as the number of frames for Still writing and set a number greater than 1 for Movie writing.

Check the image to be written at the Prog output, and when the image to be written appears, write it using “Enter.” In the case of Movie, the images are written consecutively from the page designated by the rotary 2 control up to the page equivalent to the number of frames designated by the rotary 3 control. Any existing data will be deleted in the process of image writing.

- Preview procedure

Use the rotary 5 control to set the mode to “Preview.”

Use the rotary 2 control to select the page on which the images are to be previewed. To preview Still, use the rotary 4 control to select “Field” output or “Frame” output.

To preview Movie, use the rotary 3 control to set the number of frames to be previewed and the rotary 4 control to select “Repeat” (repeat) playback or “Once” (once-only) playback. If a value exceeding the number of frames written has been set by the rotary 3 control, the setting will be ignored.

Start the preview using “Enter.” Even when the page selected by the rotary 2 control is midway through the Movie, the Movie is played back from its beginning.

If the settings are acceptable, use the rotary 5 control to set the mode to “Exit”, then enter the settings using “Enter.” The page set is recalled by the “INTVideo” button and played back.

Even when another “Matte” or “CustomColor” selection has been set using “INTVideo” upon completion of the settings, the images previously stored in the memory can be read by selecting “Memory” again but they will be cleared after the power is turned off.

The playback trigger is applied using “Shift” + “.”.

The “Grade” setting which was set by “BackMatte” also takes effect for “Memory.”

<Note>

Images cannot be written during Movie playback. If images are to be written, first set [Mode] to [Exit] and press the [Enter] button to exit Movie playback, and then proceed.

When Frame = 1

R1	R2	R3	R4	R5
Memory	Page 1	Frame 1	Field Frame	Mode Write
	1 - 30/26 (NTSC/PAL)	1 - 30/26 (NTSC/PAL)	Field Frame	Write Preview Exit

When Frame > 1

R1	R2	R3	R4	R5
Memory	Page 1	Frame 5F	Repeat Once	Mode Write
	1 - 30/26 (NTSC/PAL)	1 - 30/26 (NTSC/PAL)	Repeat Once	Write Preview Exit

[Color Effects] setting screen

Color	Pb 128	Pr 128	[Icons]				
Effect	C Gain 128		[Icons]				
Event	ME Time	Pattern	INT				
00E	10:00F	3015	Blue				
Color Effects			ch A				
Y Setup	Y Gain	Pb	Pr	C Gain			
128	128	128	128	128			
R1	R2	R3	R4	R5			

This menu is selected using the A or B bus [Color Effects] button. If the status of the [Color Effects] button is not to be changed, press the [Color Effects] button of the bus to be set while holding down the [Shift] key.

Settings can be performed separately for the A bus and B bus.

Preview is set to A by pressing the [Color Effects] button for A.

Preview is set to B by pressing the [Color Effects] button for B.

The Y setup [0 to 255] can be set using the rotary 1 control. The default setting is 128.

The Y gain [0 to 255] can be set using the rotary 2 control (0dB=0). The default setting is 128.

The Pb and Pr color balance can be set using the joystick's X direction (for adjusting Pb) and rotary 3 control or using the joystick's Y direction (for adjusting Pr) and rotary 4 control, and the chroma gain can be set using the rotary Z and rotary 5 controls.

At this time, the XYZ display is switched to Pb/Pr/C Gain.

Using transition pattern numbers 200 to 211, 215 to 220 and 222, effects are applied to the B or Preset bus using the settings established for this channel, and the pattern is changed to MIX (56).

<Notes>

- In the case of pattern numbers 221, 222, 1068 and 1069, color effects can be applied to the B channel and transitions can be initiated. When this is done, the pattern is changed to MIX (56). (With the A bus/B bus)
With the preset bus/program bus, the effects are applied to preset, and they are turned off by setting the reverse button to ON.
- Color effects cannot be applied to the INT EXT inputs.

[Video Effects] setting screen

[Mosaic] setting

Select [On] or [Off] for this effect using the rotary 2 control. The default setting is [Off].

Select [XY] (both horizontal and vertical), [X] (horizontal only) or [Y] (vertical only) using the rotary 3 control.

Set the size using the rotary 4 control. Any setting from 0 to 30 can be set for Size, and the setting can be changed in 2-step increments. The default setting is 8.

This level setting is used for the level of transition numbers 1001, 1002 and 1003 (200, 201 and 202).

R1	R2	R3	R4	R5
Mosaic	Off	XY	Size 8	
		X Y XY	0 - 30	

[Defocus] setting

Select [On] or [Off] for this effect using the rotary 2 control. The default setting is [Off].

Select level 0 to 7 using the rotary 3 control. The default setting is 2.

This level setting is used for the level of transition number 1004 (203). It cannot be made to take effect at the same time as a 2-dimensionally compressed pattern.

R1	R2	R3	R4	R5
Defocus	Off	Level 2		
		0 - 7		

<Note>

Either [Mosaic] or [Defocus] can be selected. The effect selected last takes precedence, and the previously selected effect is canceled.

[Mono] (monochrome) setting

Select [On] or [Off] for this effect using the rotary 2 control. The default setting is [Off].

This effect takes precedence over the setting initiated by [Color Effects].

R1	R2	R3	R4	R5
Mono	Off			
	On Off			

[Video Effects] setting screen

[Time Effects] still/strobe setting

Select the still or strobe effect with Video Effects ON using the rotary 2 control.

R1	R2	R3	R4	R5
Time Effects	Still	Field	Screen 1	Time 10F
	Off Still Strobe	Field Frame	1 @4 @9 @16 R4 R9 R16	2 - 124 Manual

- When [Off] has been selected
The regular screen is output.

R1	R2	R3	R4	R5
Time Effects	Off			

- When [Still] has been selected
Either [Field] or [Frame] is selected as the type using the rotary 3 control. The default setting is [Field].

R1	R2	R3	R4	R5
Time Effects	Still	Field		
		Field Frame		

- When [Strobe] has been selected
Set the number of strobe screens and the repeat operation using the rotary 4 control. The default setting is 1.
Select the strobe time setting from 2 to 124 using the rotary 5 control. The default setting is 20. The time setting can be changed in 2-step increments.
Select @4 to @16 for a once-only still operation. Select R4 to R16 for repeat operations. The number denotes the number of screens. At the Manual setting, the screen can be stopped by pressing the cross point [Strobe] button with the [Shift] key. This time setting is used for the level of transition numbers 1062, 1063, 1064 and 1065 (215, 216, 217 and 218). Still and strobe (including multi strobe) cannot be made to take effect at the same time as a 2-dimensionally compressed pattern.

R1	R2	R3	R4	R5
Time Effects	Strobe	Field	Screen 1	Time 10F
		Field Frame	1 @4 @9 @16 R4 R9 R16	2 - 124 Manual

<Notes>

- Only one of three effects—namely soft, border or soft border—for both multi strobe and pattern edges can be selected when any of the special patterns below have been selected. The effect selected last takes precedence, and the previously selected effect is canceled.
 - 1541 to 1550 (32 to 35, 130 to 133, 141 to 142)
 - 1601 to 2617
 - 3303, 3314, 3324, 3501 to 3378
 - 4601 to 6716
- Only multi strobe or scene grabber can be selected. The effect selected last takes precedence, and the previously selected effect is canceled.
- Noise may remain on the screen while the VHS is set to a special playback (such as fast forwarding or rewinding) mode.

[Video Effects] setting screen

[Decay] setting

The A and B multi strobe, transition, Key, DSK shadow and trail cannot be selected at the same time. Only one of these effects is valid at a time.

Select [On] or [Off] for the effect using the rotary 2 control.

Any time setting from 0 to 32 can be selected using the rotary 3 control. The default setting is 16.

This level setting is used for the level of transition number 1066 (219).

R1	R2	R3	R4	R5
Decay	Off	Time 16		
	On Off	0 - 32		

[Paint] setting

Select [On] or [Off] for the effect using the rotary 2 control.

Any level setting from 0 to 7 can be selected using the rotary 3 control. The default setting is 4.

This level setting is used for the level of transition number 1034 (211).

R1	R2	R3	R4	R5
Paint	Off	Level 4		
	On Off	0 - 7		

[Nega] (negative) setting

The Y negative setting and chroma key negative setting can be selected separately using the rotary 2 control and rotary 3 control, respectively. In both cases, the default setting is [Off].

R1	R2	R3	R4	R5
Nega	Y Off	C Off		
	On Off	On Off		

[Mirror] setting

The H (horizontal direction) mirror setting and V (vertical direction) mirror setting can be selected separately using the rotary 2 control and rotary 3 control, respectively. In both cases, the default setting is [Off].

R1	R2	R3	R4	R5
Mirror	H Off	V Off		
	On Off	On Off		

<Note>

Only one of the effects—namely, multi strobe, decay, trail or shadow hardware—effect can be selected. The effect selected last takes precedence, and the previously selected effect is canceled.

[Video Effects] setting screen

[3D] setting

Select [OFF], [Ripple], [Multi] or [Spark] for 3D using the rotary 2 control. This setting is only effective when the 3D optional board (AG-VE70) has been installed. It cannot be made to take effect at the same time as 3D transition or key pattern. The default setting is [Off].

R1	R2	R3	R4	R5
3D	Ripple	Level 32	Time 64	Width 1
	Off Ripple Multi Spark	0 - 255	0 - 255	0 - 5

- When [Ripple] has been selected

The extent of the [Level] effect can be set to any value from 0 to 255 using the rotary 3 control. The default setting is 32.

[Time] can be set to any value from 0 to 255 using the rotary 4 control. The default setting is 64.

[Width] can be set to any value from 0 to 5 using the rotary 5 control. The default setting is 1.

The ripple position can be set using joystick XY.

This level and other settings are used as the transition number 1981 settings.

R1	R2	R3	R4	R5
3D	Ripple	Level 32	Time 64	Width 1
		0 - 255	0 - 255	0 - 5

- When [Multi] (multi-screen) has been selected

[Size] can be set to any value from 0 to 15 using the rotary 3 control. The default setting is 8.

[Pitch] can be set to any value from 0 to 255 using the rotary 4 control. The default setting is 16.

[Reverse] can be set to [On] or [Off] using the rotary 5 control. The default setting is [Off].

This level and other settings are used as the transition number 1983 settings.

R1	R2	R3	R4	R5
3D	Multi	Size 8	Pitch 2	Reverse Off
		0 - 15	0 - 255	On Off

- When [Spark] has been selected

[Width] can be set to any value from 0 to 255 using the rotary 3 control. The default setting is 32.

[Size] can be set to any value from 1 to 3 using the rotary 4 control. The default setting is 2.

[Time] can be set to any value from 0 to 255 using the rotary 5 control. The default setting is 255.

This level and other settings are used as the transition number 1982 settings.

R1	R2	R3	R4	R5
3D	Spark	Width 32	Size 2	Time 255
		0 - 255	1 - 3	0 - 255

[Video Effects] setting screen

<Notes>

- In the case of pattern numbers 200 to 211, 1001 to 1034, 213 to 220, 222, 1060 to 1067 and 1069, transitions can be initiated with the DVE setting parameters applied to the B channel. When this is done, the pattern is changed to MIX (56). (With the A bus/B bus) With the preset bus/program bus, the effects are applied to preset, and they are turned off by setting the reverse button to ON.
- [Ripple], [Multi], [Spark] and other 3D patterns*¹ can be selected for one channel only, either A or B. The pattern selected last takes precedence, and the previously selected pattern is canceled.

*1 The "other 3D patterns" are as follows.

- | | |
|--|---------------------|
| • 1501 to 1533 (28 to 31, 36 to 42, 128 to 129) | 2Dcomp |
| • 1301 to 1333 (43 to 46, 51 to 54, 138 to 140) | Slide |
| • 1401 to 1498 (143 to 182) | 2Dcomp/Move |
| • 3301 to 3303, 3311 to 3313, 3321 to 3323, 3401 to 3478 | 2Dcomp Key |
| • 3601 to 3623 | Bounce keys |
| • 1601 to 2999 | Transition patterns |
| • 4601 to 6999 | Key patterns |

Execution of Effects

AB transition

1) Preparation

Slide the transition lever to the A side.

2) Input selection and preview

Select the input source of the transition destination using the B bus cross point button.

The preview selection can now be set as ME and the images of the transition destination can be previewed at the Preview connector.

3) Pattern selection

Select the pattern using the direct transition button or using the number keys. Patterns with numbers 2999 or lower are transition patterns.

Perform the border, shadow, trail and other settings on the LCD setting screen.

The separate border, trail and other settings are stored in each direct button and read out.

4) Execution

Slide the transition lever to the opposite side or set the ME transition time, and then press the Auto Take button.

To execute a transition from B to A, set the A bus input in step 2) and follow the same procedure.

Preset program transmission

1) Preparation

When the transition lever is slid all the way to one end, the cross point button setting is switched over by Prog/Preset.

2) Input selection and preview

Same as for AB transition.

3) Pattern selection

Same as for AB transition.

4) Execution

Same as for AB transition.

The transition can be executed by repeating steps 2), 3) and 4).

Key

1) Preparation

Slide the transition lever to the A side. The A bus now becomes the background.

2) Input selection and preview

Select the input source to be inlaid using the B bus cross point button.

The preview selection can now be set as ME and the keyed images can be previewed at the Preview connector. In the case of chroma keys, the colors are selected using the cursor on the preview screen.

3) Pattern selection

Select the pattern using the direct transition button or using the number keys. Patterns with numbers 3000 and up are key patterns.

Perform the border, shadow, trail and other settings on the LCD setting screen.

The separate border, trail and other settings are stored in each direct button and read out.

4) Key adjustment

Adjust the slice, slope and other settings on the LCD setting screen.

5) Execution

Slide the transition lever to the B side or set the ME transition time and press the Auto Take button.

DSK key

1) Preparation

Check that the DSK button's lamp is neither lighted nor flashing. If it is lighted or flashing, it means that the DSK ON status is already established so press the DSK button to turn off the lamp.

2) Setting

Select the input source of the transition destination using the Preset bus cross point button.

The preview selection can now be set as ME and the images of the transition destination can be previewed at the Preview connector.

3) Execution

Press the DSK/Fade button and perform the DSK/Fade settings.

Select the DSK source, and perform the slice and slope settings.

Set the DSK transition time.

When the button is pressed again, the transition is executed until the DSK ON status. To set DSK to OFF, press the DSK button to turn off its lamp.

Fade

1) Preparation

Perform the fade destination color and audio fade settings using the DSK/Fade settings.

2) Execution

Press the FADE button. When its lamp flashes, the fade-out status is established. For fade-in, press the FADE button to turn off its lamp.

Effect-by-effect setting screens

The settings for the transition and key patterns are performed on these screens. The items that can be set differ from one pattern to another. The LCD display changes as soon as one of the patterns is selected. The key slice, slope, key level, crop, edge, effects and DVEPlus settings are stored in the memory for each effect group. If the system was started using Reset, the default settings are established. Furthermore, the 3D modify settings are stored for each pattern group.

[Transition] wipe pattern settings

The transition wipe patterns (numbers 1 to 2999) are opened directly or when selected using the number keys.

<Note>

When transition numbers 200 to 222 (1001 to 1004, 1021 to 1023, 1030 to 1034 and 1059 to 1069) and 1981 to 1983 are selected, the pattern is changed to MIX (56).

Pos. X 128 Y 128		□ □ □ □ □ □ □ □ □ □ □ □		
Z 196		□ □ □ □ □ □ □ □ □ □ □ □		
Event	ME Time	Pattern	INT	
00E	10:00F	0013	Wh	
Transition				
Modify	Off			
Pattern	Hard	Width	Color	
Edge		0	White	
Effects	Off			
R1	R2	R3	R4	R5

[Modify] settings

The item to be changed in the pattern is selected from [Off], [Comp] (compression), [Slide], [Multi] and [Blinds] using the rotary 2 control. The default setting is [Off].

The levels applying when the settings are selected are set using the rotary 3 control.

- With the [Comp] setting: [Single] or [Both]
- With the [Slide] setting: [Single] or [Both]
- With the [Multi] setting: [H3], [V3], [HV3], [H6], [V6], [HV6], [Pair], [H3 Pair], [V3 Pair], [HV3 Pair], [H6 Pair], [V6 Pair], [HV6 Pair]

With the [Blinds] setting: None

Only the basic patterns and their related patterns can be set.

R1	R2	R3	R4	R5
Modify	Off			
	Off			
	Comp			
	Slide			
	Multi			
	Blinds			

Effect-by-effect setting screens

[Pattern Edge] setting

This is used to set edges for the patterns. The border color set here is used as the border matte for trail. It is updated by the color which is read out for the direct pattern.

Select [Hard], [Soft], [Border] or [Soft Border] using the rotary 2 control. The default setting is [Hard].

When [Soft] or [Soft Border] has been selected, No.2001 to 2195 and 6008 to 6010 patterns cannot be selected.

When [Soft Border] has been selected, the #701 to No.707 (24 to 27), 801 to 814 (183 to 196) patterns cannot be selected.

The [Width] thickness can be set to any value from 1 to 255 using the rotary 3 control. The default setting is 16. Only 1 or 2 can be set for [Width] if any of the following patterns have been selected:

- No.701 to 707 (24 to 27), 801 to 814 (183 to 196)

Select the [Color] border color using the rotary 4 control.

[White], [Yellow], [Cyan], [Green], [Magenta], [Red], [Blue], [Black], [Custom1] or [Custom2] can be selected. Custom1 and Custom2 are colors which have been set by INT Matte.

<Note>

When the PinP pattern has been selected and STILL is executed through B bus, the edge cannot be reflected.

R1	R2	R3	R4	R5
Pattern Edge	Hard	Width 0	Color White	
	Hard Soft Border Soft Border	1 - 255	White Yellow Cyan Green Magenta Red Blue Black Custom1 Custom2	

Effect-by-effect setting screens

[Effects] setting

This is used to perform the DVE settings.

Select the [Off], [Shadow] or [Trail] effect using the rotary 2 control.

Set the [Light] (lighting) using the rotary 5 control. This is valid only when the 3D optional board (AG-VE70) has been installed for use.

- When [Shadow] has been set

When [Shadow] has been selected, the shadow position can be set by setting the position while holding down [Shift].

In this case, the center, scene grabber and hold buttons flash temporarily.

- When [Trail] has been set

Set the trail color and spark using the rotary 3 control. Select the [Self] original image, [Self-spark], [BodM] border color or [BodM-spark] border spark.

The time can be set to any value from 1 to 32 using the rotary 4 control.

When trail has been set, the trail offset position can be set by setting the position while holding down [Shift]. In this case, the center, scene grabber and hold buttons flash temporarily. Whichever trail or shadow effect was selected last among trail and shadow for DSK, and multi strobe and decay for A/B videoEffects takes effect, and the previous effect is canceled.

R1	R2	R3	R4	R5
Effects	Off			Light On
	Off Shadow Trail			Lights when 3D board has been installed.

R1	R2	R3	R4	R5
Effects	Shadow			Light On
				Lights when 3D board has been installed.

R1	R2	R3	R4	R5
Effects	Trail	Self	Time 16	Light On
		Self Self-spark BodM BodM-spark	1 - 32	Lights when 3D board has been installed.

<Note>

Only one of three settings—namely, soft, border or soft border—for both multi strobe and pattern edges can be selected when a special pattern has been selected. For further details, refer to the note on page 26.

Effect-by-effect setting screens

[Chroma Key] setting

The chroma key is opened directly or when selected using the number keys. The RGB selected color display can be selected using [Shift] + rotary 2. Alternatively, the number of the selected color can be switched and written over the existing data. ME is automatically selected for the Preview output, and the chroma key cursor and keyed output are displayed.

Pos. X 128 Y 128		<input type="checkbox"/> <input type="checkbox"/> <input type="checkbox"/> <input type="checkbox"/> <input type="checkbox"/> <input type="checkbox"/> <input type="checkbox"/> <input type="checkbox"/> <input type="checkbox"/> <input type="checkbox"/> <input type="checkbox"/> <input type="checkbox"/> <input type="checkbox"/> <input type="checkbox"/> <input type="checkbox"/> <input type="checkbox"/> <input type="checkbox"/> <input type="checkbox"/> <input type="checkbox"/> <input type="checkbox"/> <input type="checkbox"/>			
Z 196					
Event 00E		ME Time 10:00F		Pattern 3101	iNT Wht
Chroma Key 1		R = ---	G = ---	B = ---	
Key		Slice 0	Slope 0	K Level 255	
Color Cancel	Offset 0	C Slice 0	C-Area 0	Mono L	
Crop	▲ 6	▼ 2	◀ 12	▶ 12	
Effects Off					
Border	Color White				
DVE Plus	Off		6301		
3D Modify	Rotate 0	Amp 16	Speed 16	TransF 32	
R1	R2	R3	R4	R5	

Display of selected number: 1, 2 or 3 is selected.

Selected color display

Scrolled display

Displayed only with 3Dop

Displayed by DVEPlus only with special patterns

[Key] setting

Align the cursor on the chroma key Preview screen with the color (blue) to be extracted using the joystick XY, and use [Enter] to enter it. Up to three colors can be stored in the memory, and the values are displayed for R, G and B.

When four or more colors have been selected, only the last three will be stored in the memory.

To cancel a selected color which is stored in the memory, select "Shift" + "Selected color number."

The [Slice] level can be set to any value from 0 to 255 using the rotary 3 control.

[Slope] can be set to any value from 0 to 15 using the rotary 4 control.

The [K Level] key (transparency) level can be set to any value from 0 to 255 using the rotary 5 control. This can be set separately from the other keys.

R1	R2	R3	R4	R5
Key		Slice 128	Slope 15	K Level 255
		0 - 255	0 - 15	0 - 255

Effect-by-effect setting screens

[Color cancel] setting

This is used to perform the settings for color cancel.
 The offset from the [Offset] key can be set to any value from 0 to 255 using the rotary 2 control.
 The [C Slice] (cancel slice) can be set to any value from 0 to 255 using the rotary 3 control.
 The [C-Area] (cancel area) can be set to any value from 0 to 3 using the rotary 4 control.
 The [Mono L] (monochrome level) can be set to any value from 0 to 15 using the rotary 5 control.

	R1	R2	R3	R4	R5
Color Cancel		Offset 0	C Slice 0	C-Area 2	Mono L 6
		0 - 255	0 - 255	0 - 3	0 - 15

[Crop] setting

This is used to perform the crop settings for the keys. These settings can be performed separately with [LumKey], [EXTKey] and [PatternKey].
 The top part of the image can be set to any value from 2 to 230 (NTSC) or to 277 (PAL) using the rotary 2 control. The default setting is 6.
 The bottom part of the image can be set to any value from 2 to 230 (NTSC) or to 277 (PAL) using the rotary 3 control. The default setting is 2.
 The left part of the image can be set to any value from 0 to 680 using the rotary 4 control.
 The right part of the image can be set to any value from 0 to 680 using the rotary 5 control. The default setting in each case is 12.

	R1	R2	R3	R4	R5
Crop		▲ 6	▼ 2	◀ 12	▶ 12
		2 - 230 (NTSC) 2 - 277 (PAL)	2 - 230 (NTSC) 2 - 277 (PAL)	0 - 680	0 - 680

If the top setting is changed, the bottom setting will change, and vice versa, in such a way that the total setting will not exceed 230 (NTSC) or 277 (PAL). Similarly, if the left setting is changed, the right setting will change, and vice versa, in such a way that the total setting will not exceed 680. The left and right settings can be changed in 2-step increments.

[Border] setting

Select the [Color] (border color) using the rotary 2 control. There are 10 choices: White, Yellow, Cyan, Green, Magenta, Red, Blue, Black, Custom1 and Custom2. The default setting is [White]. Custom1 and Custom2 are colors which have been set by INT Matte.

[Effects] setting

The effects can be added in the same way as with the basic patterns. The default setting is [Off].

[DVE Plus]

This takes effect only when the 3D optional board (AG-VE70) has been installed.
 It is possible to add the DVEs in key numbers 3401 to 3478, 3601 to 3623, 6001 to 6003, 6006, 6007, and 6009 to 6634.
 Select [On] or [Off] using the rotary 2 control. The default setting is [Off].
 The numbers are input using the rotary 3, 4 and 5 controls. The parameters for patterns with numbers 6001 to 6438 and 6601 to 6716 can be changed with [3D Modify].

Effect-by-effect setting screens

[Basic Pattern Key] setting (numbers 3001 to 3046)

The basic pattern key is opened directly or when selected using the number keys.

Pos. X 128 Y 128		□ □ □ □ □ □ □ □ □ □ □ □		
Z 196		□ □ □ □ □ □ □ □ □ □ □ □		
Event	ME Time	Pattern	INT	
00E	10:00F	3002	Wht	
Basic Pattern Key				
Pattern	Width	Color	K Level	
Edge	Hard	0	White	255
Effects	Off			
DVE	Plus	Off	6301	
3D	Rotate	Amp	Time	TransF
Modify	0	16	16	32
Key	Empty	Setup		
Learn	9000			
	R1	R2	R3	R4

Scrolled display

Displayed only with 3D option

Displayed by DVEPlus only with special patterns

Select [Hard], [Soft], [Border] or [Soft Border] using the rotary 2 control. The default setting is [Hard].

The thickness can be set to any value from 0 to 255 using the rotary 3 control. The default setting is 16.

Select the border color using the rotary 4 control. [White], [Yellow], [Cyan], [Green], [Magenta], [Red], [Blue], [Black], [Custom1] or [Custom2] can be selected. The default setting is [White].

The key level (transparency level) can be set to any value from 0 to 255 using the rotary 5 control. This can be set separately from the other keys. The default setting is 255.

The crop setting can also be set separately from the other keys. Effects can be added for the effect settings in the same way as for other patterns.

Effect-by-effect setting screens

[3Dmodify] setting

This takes effect only for the special 3D patterns (numbers 6001 to 6438 and 6601 to 6716) when the 3D optional board (AG-VE70) has been installed.

The parameters of the pattern for the 3D keys can be changed using the rotary 2, 3, 4 and 5 controls. They can be stored in the memory for each pattern.

- With the sphere group (numbers 6001, 6301 to 6438)

R2: [Rotate] (rotation) setting

R4: [Time] setting

R5: [TransF] (transformation) setting

R1	R2	R3	R4	R5
3D Modify	Rotate 128		Time 0	TransF 255
	<input type="text" value="0 - 255"/>		<input type="text" value="0 - 255"/>	<input type="text" value="0 - 255"/>

- With the flag group (numbers 6002, 6101 to 6139)

R2: [Width] (flag width) setting

R3: [Angle] setting

R4: [Time] (fluttering time) setting

R5: [Amp] (amplitude) setting

R1	R2	R3	R4	R5
3D Modify	Width 192	Angle 96	Time 48	Amp 32
	<input type="text" value="0 - 255"/>	<input type="text" value="0 - 255"/>	<input type="text" value="0 - 255"/>	<input type="text" value="0 - 255"/>

- With the accordion group (numbers 6003, 6201 to 6239)

R2: [Width] (accordion width) setting

R3: [Angle] setting

R5: [Amp] (amplitude) setting

R1	R2	R3	R4	R5
3D Modify	Width 160	Angle 96		Amp 48
	<input type="text" value="0 - 255"/>	<input type="text" value="0 - 255"/>		<input type="text" value="0 - 255"/>

- With perspectives (numbers 6006 and 6007, 6601 to 6634 and 6501 to 6532)

With door number 6004 to 6005, 6701 to 6716 groups

R2: [Rotate] (rotation) setting

R3: [Axis] (rotary axis) setting

R4: [View] (viewer) setting

R5: [Depth] setting

R1	R2	R3	R4	R5
3D Modify	Rotate 128	Axis 0	View 128	Depth 64
	<input type="text" value="0 - 255"/>	<input type="text" value="0 - 255"/>	<input type="text" value="0 - 255"/>	<input type="text" value="0 - 255"/>

6007 to 6007: All parameters can be set.

6601 to 6634: Only [View] and [Depth] can be set.

6501 to 6532: Only [View] and [Depth] can be set.

Door

6004 to 6005: Only [Depth] can be set.

6701 to 6716: Only [View] and [Depth] can be set.

Effect-by-effect setting screens

- With the page turn group (number 6008)

R2: [Rotate] (rotation) setting
 R3: [Angle] setting
 R4: [Turn] setting
 R5: [Radius] setting

R1	R2	R3	R4	R5
3D	Rotate	Angle	Turn	Radius
Modify	128	32	64	3
	0 - 255	0 - 255	0 - 255	0 - 7

- With the ripple group (number 6031)

R2: [Level] (amplitude) setting
 R3: [Time] setting
 R4: [Width] setting
 The position of the ripple center can be changed using [Shift] + XY.

R1	R2	R3	R4	R5
3D	Level	Time	Width	
Modify	32	64	1	
	0 - 255	0 - 255	0 - 5	

- With the spark group (number 6032)

R2: [Width] setting
 R3: [Size] setting
 R4: [Time] setting

R1	R2	R3	R4	R5
3D	Width	Size	Time	
Modify	32	2	255	
	0 - 255	1 - 3	0 - 255	

- With the melt group (numbers 6033 to 6034)

R2: [Level] setting

R1	R2	R3	R4	R5
3D	Level			
Modify	128			
	0 - 255			

- With the twist group (numbers 6009 to 6010)

R2: [Rotate] (rotation) setting
 R3: [Turn] setting
 R4: [Tilt] setting

R1	R2	R3	R4	R5
3D	Rotate	Turn	Tilt	
Modify	128	128	128	
	0 - 255	0 - 255	0 - 255	

Effect-by-effect setting screens

[Key Learn] setting

This is used to set key learn. It cannot be set for number 3001 to 3006, 3301 to 3305, 6001 to 6003 and 6006 to 6010 doors. The key XYZ, key level and 3D modify settings are stored in the memory for each key frame.

The key patterns are selected using the rotary 2 and 3 controls. Selection is made from 9000 to 9019.

[Saved] is displayed for a pattern once set by the pattern number, and [Empty] is displayed for a pattern which has not yet been set.

Select [Setup], [Preview], [CLR] or [All CLR] using the rotary 4 control, and enter the selection using [Enter].

The operation of a set key is reproduced by selecting a pattern with the [Saved] display and then selecting [Preview] followed by [Enter].

When a pattern with the [Saved] display is selected and either [CLR] or [All CLR] is selected followed by [Enter], [OK?] appears. By selecting [Enter] at this point, the selected key learn pattern is cleared if [CLR] was selected or all the key learn patterns are cleared if [All CLR] was selected. Clearing is canceled using [Shift] + [Enter].

With either [Empty] or [Saved] patterns, the editing mode is established by selecting [Setup] followed by [Enter], and the display is switched. When a [Saved] pattern is to be set, [OK?] appears: use [Enter] to set the pattern or [Shift] + [Enter] to cancel the setting.

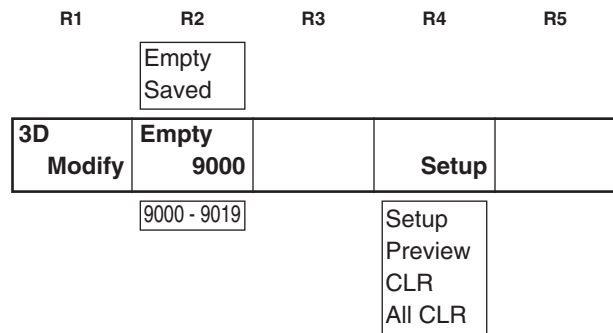

Effect-by-effect setting screens

Pos. X 128 Y 128 Z 196				
Event 00E ME Time 10:00F Pattern 3013 INT Wht				
Key				
Learn	9000			
Insert				
Replace	Basic			
CLR KF	K Frame			K Level
Copy	00			255
Paste				
Exit				
R1	R2	R3	R4	R5

In the key learn editing mode, the key frame number is displayed in [K Frame].
 Using the rotary 1 control, the editing items are selected and key frames are set. Key frames 00 to 19 can be set, and they are displayed during editing in the rotary 2 control display area.
 The time settings for the key frames to date can be set by [ME Time]. This is useful for an additional [KeyFrame]. During learning, ME is automatically selected for time.

Editing items that can be selected by the rotary 1 control

- Insert: A key frame is inserted in the space of the next key frame. Insert is executed using [Enter].
- Replace: The current key frame is replaced. Replace is executed using [Enter].
- CLR KF: The current key frame is cleared. Clear is executed using [Enter].
- Copy: The current key frame is copied. Copy is executed using [Enter].
- Paste: The key frame in the copy buffer is pasted by overwriting. Paste is executed using [Enter]. If the key frame has not been copied, the execution menu cannot be selected.
- Exit: Key learn is stored in the memory after exiting the editing mode. Exit is executed using [Enter].

In the editing mode, it is possible to set the parameters using the rotary 2, 3, 4 and 5 controls, XYZ using the joystick XY and rotary Z control, the aspect ratio using [Aspect], the key frames using [Shift] + rotary 2 control, and the key level using [Shift] + rotary 5 control.

To set another key pattern, first exit this screen, proceed with key pattern input again, and execute key learn.

With basic patterns (#3001 to #3006) that can be positioned and basic compressed patterns (#3301 to #3304)

	R1	R2	R3	R4	R5
Insert					
Replace	Basic				
CLR KF	K Frame				K Level
Copy	00				255
Paste					
Exit					

With Sphere (#6001)

	R1	R2	R3	R4	R5
Insert					
Replace	Sphere				
CLR KF	K Frame				K Level
Copy	00				255
Paste	Rotate		Time		TransF
Exit	128		0		255

R2: [Rotate] rotation setting
 R4: [Time] setting
 R5: [TransF] (transformation) setting
 XY Position
 3D parameters are the same as with 3DModify.

Effect-by-effect setting screens

With flag (#6002)

	R1	R2	R3	R4	R5
Insert	Flag				
Replace	Flag				
CLR KF	K Frame				K Level
Copy	00				255
Paste	Width	Angle	Time		Amp
Exit	192	64	48		32

R2: [Width] (flag width) setting
 R3: [Angle] setting
 R4: [Time] (fluttering time) setting
 R5: [Amp] (amplitude) setting
 3D parameters are the same as with 3DModify.

With page turn (#6008)

	R1	R2	R3	R4	R5
Insert	Page Turn				
Replace	Page Turn				
CLR KF	K Frame				K Level
Copy	00				255
Paste	Rotate	Angle	Turn		Radius
Exit	128	32	64		3

R2: [Rotate] (rotation) setting
 R3: [Angle] setting
 R4: [Turn] setting
 R5: [Radius] setting
 3D parameters are the same as with 3DModify.

With accordion (#6003)

	R1	R2	R3	R4	R5
Insert	Accordion				
Replace	Accordion				
CLR KF	K Frame				K Level
Copy	00				255
Paste	Width	Angle			Amp
Exit	192	64			32

R2: [Width] (accordion width) setting
 R3: [Angle] setting
 R5: [Amp] (amplitude) setting
 3D parameters are the same as with 3DModify.

With twist group (#6009 to #6010)

	R1	R2	R3	R4	R5
Insert	Twist				
Replace	Twist				
CLR KF	K Frame				K Level
Copy	00				255
Paste	Rotate	Turn	Tilt		
Exit	128	128	128		

R2: [Rotate] (rotation) setting
 R3: [Turn] setting
 R4: [Tilt] setting

With the perspectives group (#6006 to #6007)

	R1	R2	R3	R4	R5
Insert	Perspective				
Replace	Perspective				
CLR KF	K Frame				K Level
Copy	00				255
Paste	Rotate	Axis	View	Depth	
Exit	128	0	128	64	

R2: [Rotate] (rotation) setting
 R3: [Axis] (rotary axis) setting
 R4: [View] (viewer) setting
 R5: [Depth] setting
 3D parameters are the same as with 3DModify. Key learn is not possible for doors.

Effect-by-effect setting screens

<Notes>

When a compression effect has been applied to images, some of the effects may be automatically canceled.

- When applying 2D compression effects to channel A

Under the conditions below, the Still, Strobe and Multi Strobe for channel A are turned OFF when the Transition lever or key size adjustment Z has been changed or the compression rate has been changed by the aspect ratio.

Conditions: When [DSK-Effects] is OFF and any of the Rev or Dual PinP patterns below has been selected

- 2DcompKey (2D + 3Dcomp included) + Rev
- 2DcompTrans + Rev
- 2Dcomp2Trans (+ Rev)
- 2Dslide1Trans (+ Rev)
- 2Dslide2Trans (+ Rev)

- When applying 2D compression effects to channel B

Under the conditions below, the Still, Strobe and Multi Strobe for channel B are turned OFF when the Transition lever or key size adjustment Z has been changed or the compression rate has been changed by the aspect ratio.

Conditions: When [DSK-Effects] is OFF and any of the Norm or Dual PinP patterns below has been selected

- 2DcompKey (2D + 3Dcomp included) + Rev
- 2DcompTrans
- 2Dcomp2Trans
- 2Dslide1Trans
- 2Dslide2Trans

The processing procedure differs depending on whether the 3D optional board (AG-VE70) has been installed or nor. Details are as follows.

- When the 3D optional board (AG-VE70) is not installed

Pattern number selected	Processing after cancel operation
1501 to 1533 (28 to 31, 36 to 42, 128 to 129)	2Dcomp
1541 to 1550 (32 to 35, 130 to 133, 141 to 142)	2chComp
1301 to 1333 (43 to 46, 51 to 54, 138 to 140)	2Dslide1 (only Multi Strobe is set OFF)
1341 to 1348 (47 to 50, 134 to 137)	2Dslide2 (only Multi Strobe is set OFF)
1401 to 1498 (143 to 182)	2Dcomp/MoveKey
3301 to 3303, 3311 to 3313, 3501 to 3578	2Dcomp Key
3304, 3314, 3324, 3501 to 3378	Dual PinP
3401 to 3478	2DcompMoveKey (OFF when Z is changed)
3601 to 3623	Bounce Key (OFF when Z is changed)

- When the 3D optional board (AG-VE70) is installed

Pattern number selected	Processing after cancel operation
1341 to 1348 (47 to 50, 134 to 137)	2Dslide2 (only Multi Strobe is set OFF)
1541 to 1550 (32 to 35, 130 to 133, 141 to 142)	2chComp
3304, 3314, 3324, 3501 to 3378	Dual PinP
4601 to 5614, 6031 to 6037	3D + 2Dcomp Key (OFF when Z is changed)

DSK/Fade settings

These settings are opened when the DSK/FADE button or DSK Preview is selected. Both DSK and Fade settings can be performed.

Select the [DSK Source], [DSK Key], [Crop], [DSK On/Off], [DSK Effects] or [Fade] item using the rotary 1 control. When the title memory is 0, the Key [Memory], Source [Memory], [Memory], [Mode] and [Slide] settings are canceled.

Pos. X 128 Y 128		□ □ □ □ □ □ □ □ □ □ □ □		
Z 196		□ □ □ □ □ □ □ □ □ □ □ □		
Event 00E		ME Time 10:00F		Pattern 3015
INT Wht				
DSK Fade			Still	
DSK Source	Key EXT	Fill EXT	Page 1-1	Mode Write
DSK Key	Slice 0	Slope 8	K Level 255	
Crop	▲ 6	▼ 2	◀ 12 ▶	12
DSK On/Off	ME Trig Off	Slide In Off	Slide Out Off	Speed 8
DSK Effects	Off			Light On
Fade	To Black	Audio On	Phone After	
R1	R2	R3	R4	R5

Still
Crawl
Roll
Movie

[DSK Source] settings

These are used to select the DSK [Key] and [Fill] signals.

Select the key signals using the rotary 2 control. Either [EXT] (external) or [Title] can be selected.

Select the key fill signals using the rotary 3 control. [EXT] (external) input, [Title] or [BodMat] (border matte) can be selected.

Select the page number of the title memory using the rotary 4 control. The total number of pages can be changed on the [Setup] setting screen.

Set the operation using the rotary 5 control. Either [Write] or [Preview] can be selected.

Set [Mode] to [Write], and use [Enter] to save the external input in the memory.

Set [Mode] to [Preview], and select [Enter] to initiate the preview display. It is now possible to check the slides or movie movements from On to Off. The default setting is [Preview].

When [Title] has been selected for [Key] and [Fill] and preview is initiated, the title, star and heart keys are canceled and changed to MIX (56).

The title page can be selected using the rotary 4 control. The first number is for the page and the second number for the sub-pages.

When part of a group has been selected, playback is initiated from the start of that part.

Writing initiated by [Write] applies to the entire screen. Sub-frames are ignored. If the page concerned is used as a group, the pages of the entire group will be cleared as well. Since the saving that is initiated by [Write] supports only the [EXT] external inputs, set [Key] and [Fill] to [EXT].

The playback type of the title concerned is displayed in the top section. Playback or pause for [Movie], [Crawl] and [Roll] is initiated by [Shift] + [0].

R1	R2	R3	R4	R5
DSK Source	Key EXT	Fill EXT	Page 1-1	Mode Write
	EXT Title	EXT Title BodMat	1-30/26 (NSTC/PAL) - 1-8	Write Preview

DSK/Fade settings

[DSK Key] settings

These are used to set the DSK key signals (for external applications). Memory keys are used in their original form. The [Slice] level can be set to any value from 0 to 255 using the rotary 2 control. The default setting is 0. [Slope] can be set to any value from 0 to 15 using the rotary 3 control. The default setting is 0. The [K Level] (key level) can be set to any value from 0 to 255 using the rotary 5 control. The default setting is 255.

R1	R2	R3	R4	R5
DSK Key	Slice 0	Slope 0		K Level 255
	0 - 255	0 - 15		0 - 255

[Crop] setting

This is used to set crop for DSK. The top can be set to any value from 2 to 200 using the rotary 2 control. The default setting is 6. The bottom can be set to any value from 2 to 200 using the rotary 3 control. The default setting is 2. The left can be set to any value from 0 to 680 using the rotary 4 control. The right can be set to any value from 0 to 680 using the rotary 5 control. The default setting in each of these cases is 12. If the top setting is changed, the bottom setting will change, and vice versa, in such a way that the total setting will not exceed 200. Similarly, if the left setting is changed, the right setting will change, and vice versa, in such a way that the total setting will not exceed 680. The left and right settings can be changed in 2-step increments.

R1	R2	R3	R4	R5
Crop	▲ 6	▼ 2	◀ 12	▶ 12
	0 - 200	0 - 200	0 - 680	0 - 680

[DSK On/Off] setting

This is used to set the DSK on/off operations. [Slide IN/OUT] takes effect when [Title] has been selected for [Key] and [Fill]. Whether the in or out operation is to be initiated during an ME transition is set using the rotary 2 control. Whether the sliding in operation is to be initiated in the horizontal or vertical direction during DSK ON is set using the rotary 3 control. Whether the sliding out operation is to be initiated in the horizontal or vertical direction during DSK OFF is set using the rotary 4 control.

- ▶: Slide toward the right
- ◀: Slide toward the left
- ▲: Slide toward the top
- ▼: Slide toward the bottom

The default setting in each of these cases is [Off].

The sliding speed is set using the rotary 5 control. Any even number from 2 to 64 can be selected. The default setting is 8. When sliding has been selected, the DSKTime is changed to 0. During sliding, the DSK buttons have no effect but become operational again upon completion of the sliding operation. This setting can also be changed at the PC.

R1	R2	R3	R4	R5
DSK On/Off	ME Trig Off	Slide In Off	Slide Out Off	Speed 8
	On Off	Off ▶ ◀ ▲ ▼	Off ▶ ◀ ▲ ▼	2 - 64

DSK/Fade settings

[Fade] settings

These are used to perform the fade settings.

The image to be faded is selected from [Black], [White] or [Blue] using the rotary 2 control. The default setting is [Black].

[On] or [Off] is selected for [Audio] fading using the rotary 3 control. The default setting is [On].

[After] or [Pre] is selected for [Phone] fading using the rotary 4 control. At [After], the sound is heard with the fading effect applied to the images; at [Pre], it is heard with no fading effect applied to the images. The default setting is [After].

R1	R2	R3	R4	R5
Fade	To Black	Audio On	Phone After	
	Black White Blue	On Off	After Pre	

<Note>

Only one of three settings—namely, DSK memory, title key or star/heart key—can be selected. The key selected last takes precedence, and the previously selected key is canceled.

When the pattern is changed to MIX (56), the title key or heart/star key is to be canceled. During title DSK, the heart/star key cannot be used.

[Audio Effects] settings

1 - 8
Aux1
Aux2

Pos. X 128 Y 128		□ □ □ □ □ □ □ □ □ □ □ □							
Z 196		□ □ □ □ □ □ □ □ □ □ □ □							
Event 00E		ME Time 10:00F		Pattern 3015		INT Wht			
Audio Effects									
1	Pan		Off		IN Ch L		Balance 0		
	EQ		On		Low 0		High 0		
	EQ Mid		M Level 0		Freq 1.01KHz		Q 0.5		
	Voice Change		Off		Pitch Up		Level 5		
Mute			Off		Ch AB				
R1		R2		R3		R4		R5	

[Audio Effects] is opened using Audio Effects or the ON button. Audio effects can be set for each input. Select the input from [1] (crosspoint 1), [2] (crosspoint 2), [3] (crosspoint 3), [4] (crosspoint 4), [5] (crosspoint 5), [6] (crosspoint 6), [7] (crosspoint 7), [8] (crosspoint 8), [AUX1] or [AUX2] using the rotary 1 control. Select the item from [PAN], [EQ] (equalizer), [EQ Mid] equalizer midrange, [Voice] (voice changer) or [Mute] using the rotary 2 control.

[PAN] setting

Set [On] or [Off] using the rotary 3 control. The default setting is [Off].
 Select the input channel to be used using the rotary 4 control. Select [L], [R] or [L+R]. The default setting is [L].
 Set the output balance using the rotary 5 control. Make the selection from L7 to 0 to R7. The default setting is 0.

R1	R2	R3	R4	R5
	PAN 1	Off	IN Ch L	Balance 0
		On Off	L R L+R	L7 - 0 - R7

[Audio Effects] settings

[EQ] equalizer setting

This is used to set the equalizers.

Set [On] or [Off] for all equalizers using the rotary 3 control.

The default setting is [On].

The [L Level] bass level can be set in 2 dB intervals to any value from -14 dB to 0 to +14 dB using the rotary 5 control.

The default setting is [0].

The [H Level] treble level can be set in 2 dB intervals to any value from -14 dB to 0 to +14 dB using the rotary 4 control.

The default setting is [0].

R1	R2	R3	R4	R5
1	EQ	On	L Level 0	H Level 0
		On Off	-14 - +14	-14 - +14

[EQ Mid] equalizer midrange setting

The [M Level] midrange level can be set in 2 dB intervals to any value from -14 dB to 0 to +14 dB using the rotary 3 control. The default setting is [0].

The midrange frequency can be set to any value from 100 Hz to 10.2 kHz using the rotary 4 control. The default setting is 1.01 kHz.

Select [0.5], [1], [2] or [5] for Q using the rotary 5 control.

The default setting is [0.5].

R1	R2	R3	R4	R5
1	EQ Mid	M Level 0	Freq 1.01KHz	Q 0.5
		-14 - +14	100 Hz - 10.2 KHz	0.5 1 2 5

[Voice Change] (voice changer) setting

This is used to set the voice changer.

Set [On] or [Off] using the rotary 3 control. The default setting is [Off].

Set [Up] or [Down] for the [Pitch] using the rotary 4 control. The default setting is [Up].

[Level] can be set to any value from [0] to [10] using the rotary 5 control. The default setting is [5].

R1	R2	R3	R4	R5
1	Voice Change	Off	Pitch Up	Level 5
		On Off	Up Down	0 - 10

[Mute] setting

Set the mute level using the rotary 3 control. [Off], [-12 dB], [-20 dB] or [-60 dB] can be selected. The default setting is [Off].

Select the channel to be muted using the rotary 4 control. [AB] (AB bus only), [ABAUX1] (AB bus and Aux1) or [All] can be selected. The default setting is [All].

R1	R2	R3	R4	R5
	Mute	-12dB	AB	
		Off -12dB -20dB -60dB	AB ABAUX1 All	

[Setup] initial setting screen

Wash Ph 128 Pr 128 Z 196				
<input type="checkbox"/> <input type="checkbox"/> <input type="checkbox"/> <input type="checkbox"/> <input type="checkbox"/> <input type="checkbox"/> <input type="checkbox"/> <input type="checkbox"/> <input type="checkbox"/> <input type="checkbox"/> <input type="checkbox"/> <input type="checkbox"/> <input type="checkbox"/> <input type="checkbox"/> <input type="checkbox"/> <input type="checkbox"/> <input type="checkbox"/> <input type="checkbox"/> <input type="checkbox"/> <input type="checkbox"/> <input type="checkbox"/>				
Event 00E		ME Time 10:00F		Pattern 3015
INT Wh				
Setup				
Power	Reset			
Direct Pattern	Setup			
Audio Video	Input Setup			
Memory	INT V 30	Title 0		
Gen Lock	Ref in	H Phase 0	SC Phase 0	
Video Format	NTSC	Aspect 4:3	Setup 0	Pb Pr Beta
System1	Dly 1Frame	Time Sec	GPI ME	RS422 GVG
System2	Lcd 0	Stby Off	VBClean On	DR
Bus	Type AB	Still On	Audio CP	Tally 8
Audio Level	Alignment 4dB			Head 18dB
File	Empty 1	Save		
R1	R2	R3	R4	R5

Scrolled display

Select the item to be set using the rotary 1 control. Items consist of [Power], [Direct Pattern], [Audio Video], [Memory], [Gen Lock], [Video Format], [System1], [System2], [Bus], [Audio Level] and [File].
The setup settings are not returned to the factory settings even if the system is started by Reset. They can be restored to the factory settings by pressing [Shift] and [Enter] together when the power is turned on.

[Setup] initial setting screen

[Power] (power ON) setting

Whether the system is to be started from the [Reset] status, from the [Preset] status or in the [Demo] mode can be selected using the rotary 2 control.

With [Reset], the settings except for the event memories, setup settings, file memory and key learn settings are initialized.

With [Preset], the mode in which the system is started from the status prior to power OFF is established when the power is next turned on.

If no status prior to power OFF existed (when, for instance, the system is used for the very first time after assembly or its memories have been destroyed), the system is started from the factory setting status.

With [Demo], the system starts up in the demonstration mode when the power is next turned on. This menu is displayed in the demonstration mode so that when the system is restarted by selecting [Preset] or [Reset], the regular operation screen will appear. Alternatively, when [Enter] is pressed, the demonstration mode is suspended and operation is enabled. To execute the demonstration mode again, turn the power off and then back on again. The audio faders can be used even in the demonstration mode.

The default setting is [Preset].

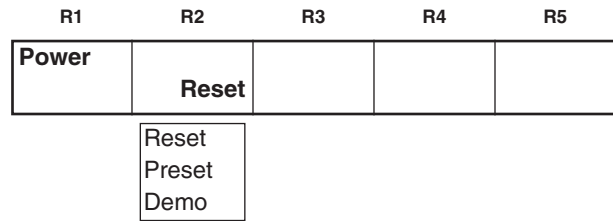

[Direct Pattern] setting

This is used to set the pattern which is to be called as the direct pattern.

When [Setup] is selected using the rotary 2 control and [Enter] is pressed, [OK?] appears so press [Enter] to change to the setting mode. Use [Shift] + [Enter] to cancel.

When [Default] is selected using the rotary 2 control and [Enter] is pressed, [OK?] appears so press [Enter] to change to the default setting. Use [Shift] + [Enter] to cancel.

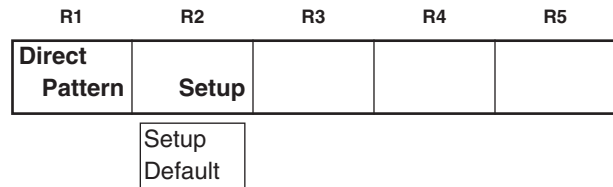

Setting method in the setting mode

[ME] is selected for Preview so it can be used to check.

1. Press the direct pattern button.
2. The lamp of the selected button flashes. The [Mix], [Chrm] (chroma) key and [Lum] (luminance) key cannot be set.
3. Use the number keys to input the pattern to be assigned. (The pattern is displayed in the pattern area.) The program output can be checked using the wipe lever.

[Setup] initial setting screen

[Audio Video Input] settings

These are used to set the audio and video inputs.

When [Setup] is selected using the rotary 2 control and [Enter] is pressed, [OK?] appears so press [Enter] to change to the setting mode. Use [Shift] + [Enter] to cancel.

When [Default] is selected using the rotary 2 control and [Enter] is pressed, [OK?] appears so press [Enter] to change to the default setting.

When [V-Link] is selected using the rotary 2 control and [Enter] is pressed, [OK?] appears so press [Enter] to change operation so that the audio input is matched with the video input.

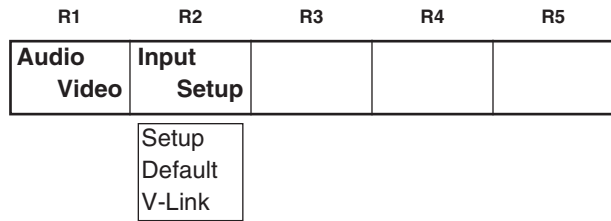

Factory settings

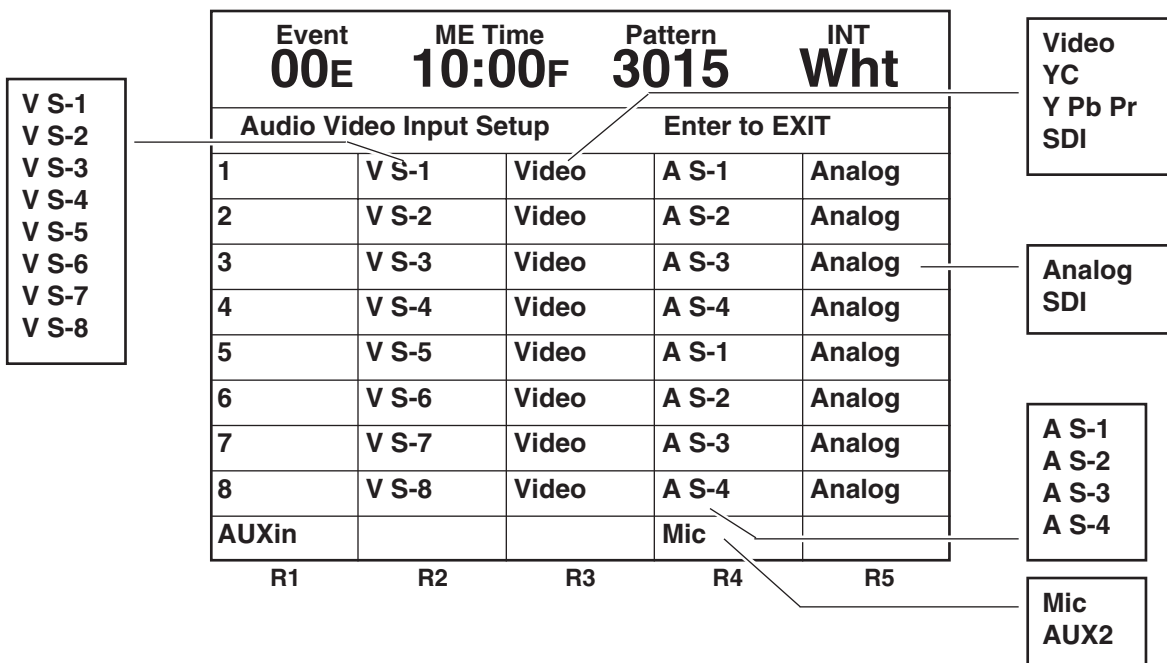

Setting method

Press the button of the cross point to be set. Alternatively, select the button of the cross point which is to be set using the rotary 1 control. The lamp of the selected button flashes, and the bus is automatically output to Preview. When the cross point has been selected using the rotary 1 control, the A bus is output to Preview.

Select V S-1, V S-2, V S-3, V S-4, V S-5, V S-6, V S-7 or V S-8 as the video input using the rotary 2 control.

Select [Video] composite, [YC], [Y Pb Pr] component or [SDI] using the rotary 3 control.

Except for [Video], the sources extend from S-1 to S-4 so [5] is changed to [1], [6] to [2], [7] to [3] and [8] to [4]. If the setting operation is exited part of the way through, the settings performed so far will not be stored in the memory. They are entered using [Enter], and operation returns to the [Audio Video Input] settings.

Select A S-1, A S-2, A S-3 or A S-4 as the audio input using the rotary 4 control.

Select [ANALOG] or [SDI] using the rotary 5 control.

Video input combinations that cannot be set: S-5 to S-8 + YC/Y Pb Pr/SDI

Audio input combinations that cannot be set: Combination of SDIs with different source numbers

Example: SDI of S-1 for video and SDI of S-2 for audio

[Mic] or [AUX2] can be set for [AUXin] using the rotary 4 control. The default setting is [Mic].

[Setup] initial setting screen

[Memory] setting

This is used to set the memories used for INTVideo and DSK. When the setting is changed, all the memories are cleared. How much memory is to be used for [INT V] and how much for [Title] for DSK and TitleKey is set using the rotary 2 and 3 controls.

If the allocation to one memory is changed, the allocation to the other memory will change so that the total remains 30. When a change is to be made, [OK?] appears. Execute the change using [Enter], and use [Shift] + [Enter] to cancel. The default setting is 15 each for [INT V] and [Title] with NTSC and 13 each for [INT V] and [Title] with PAL.

R1	R2	R3	R4	R5
Memory	INT V 30	Title 0		
	0 - 30/26	0 - 30/26		

[Gen Lock] external synchronization setting

Select [G/L] or [ExtKey] as the [Ref] (reference) source using the rotary 2 control. The default setting is [G/L].

Adjust the [H Phase] (horizontal phase) using the rotary 3 control. The default setting is 128.

Adjust the [SC Phase] (subcarrier phase) using the rotary 4 control. The default setting is 512.

[H Phase] and [SC Phase] are stored in the memory separately in accordance with [G/L] or [Ext Key] for the input.

R1	R2	R3	R4	R5
Gen Lock	Ref G/L	H Phase 128	SC Phase 512	
	G/L Ext Key	28 - 228	0 - 1023	

[Video Format] setting

Either [NTSC] or [PAL] is selected as the format by the rotary 2 control.

The default setting is the format used in the area where the system was purchased.

When a change is to be made, [OK?] appears. Execute the change using [Enter], and use [Shift] + [Enter] to cancel.

Set [4:3] or [16:9] as the [Aspect] ratio of the patterns using the rotary 3 control. The default setting is [4:3].

Select [0] or [7.5] for [Setup] using the rotary 4 control. The default setting is [0].

Select [Beta] or [M2] for the [Pb Pr] component level using the rotary 5 control. The default setting is [Beta].

When the NTSC or PAL format is changed, the system is initialized, and the [INT V] and title memories are cleared.

R1	R2	R3	R4	R5
Video Format	NTSC	Aspect 4:3	Setup 0	Pb Pr Beta
	NSTC PAL	4:3 16:9	0 7.5	Beta M2

[Setup] initial setting screen

[System1] setting

This is used to perform a variety of settings.

The rotary 2 control is used to set the amount of delay for the source input when the [AdvRef] advanced reference signal is connected with the 3D optional board (AG-VE70) installed. If 0Frame is selected, the video delay amount is different between when the 3D effects are applied and when they are not. The default setting is 1Frame. The setting is fixed at 0Frame when the 3D optional board is not installed. The audio source delay amount is also set according to this setting.

[Sec] (seconds + frames) or [Frame] (frames) only is selected for the time display using the rotary 3 control. The default setting is [Sec].

Whether [ME], [DSK] or [Fade] is to be executed by GPI can be set using the rotary 4 control. The default setting is [ME]. [GVG] or [SONY] can be selected as the RS-422A protocol using the rotary 5 control. The default setting is [GVG].

R1	R2	R3	R4	R5
System1	Dly 1Frame	Time Sec	GPI ME	RS422 GVG
	1Frame 0Frame	Sec Frame	ME DSK Fade	GVG SONY

[System2] setting

The time taken until the LCD is set to the power saving mode can be selected using the rotary 2 control.

With the 0 setting, the display is always on. The time can be set in 10-minute increments from 0 to 60. The default setting is 0.

[On] or [Off] is selected using the rotary 3 control to set whether or not cleaning is to be performed inside the vertical blanking period (VBlk). The default setting is [Off].

[On] or [Off] is selected using the rotary 4 control to set whether or not the [DR] (dynamic rounding) is to be performed. The default setting is [On].

R1	R2	R3	R4	R5
System2	LCDStby 0	VBClean Off	DR On	
	0 - 60	On Off	On Off	

<Note>

Selecting [Off] for [VBClean] may result in a deviation in the amount of delay between the video signals and vertical blanking signals depending on the setting for the [Dly] item among the [System1] settings and on whether the 3D optional board (AG-VE70) has been installed.

[Bus] setting

AB (AB bus) or PrgPre (program/preset system) can be selected as the bus system using the rotary 2 control. The default setting is AB.

[On] (initiate Still) or [Off] (do not initiate Still) when cross points are to be changed is selected using the rotary 3 control. The default setting is [On].

The Audio MIX system can be selected using the rotary 4 control.

At the [CP] setting, two audio sources allocated to the selected cross point are output. At the [1,2] setting, the audio sources 1, 2 allocated to the cross point are mixed at all times. The default setting is [CP].

[8] or [EXT] can be selected using the rotary 5 control as the setting for the eight tally outputs. At the [8] setting, the tally signal is output when cross point 8 has been selected; at the [EXT] setting, it is output when EXT has been selected.

R1	R2	R3	R4	R5
Bus	Type AB	Still On	Audio CP	Tally 8
	AB Prg Pre	On Off	CP 1, 2	8 EXT

<Note>

When [Still] is to be set to [Off], do not mix the analog and SDI signals for the input. Be absolutely sure to use the analog-only system or SDI-only system.

[Setup] initial setting screen

[Audio Level] setting

The [Alignment] (alignment) level is set using the rotary 2 control. [-3 dB], [0 dB] or [4 dB] can be selected. The default setting is [4 dB] for NTSC and [0 dB] for PAL.

The [Head] (headroom) is set using the rotary 5 control. Either [18 dB] or [20 dB] can be selected. The default setting is [20 dB] for NTSC and [18 dB] for PAL.

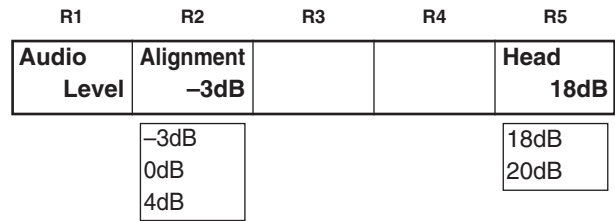

[File] setting

The statuses set by [Setup] can be stored in the memory. Select 1 to 8 using the rotary 2 control. An empty file is indicated by [Empty]. A file with settings is indicated by [Saved].

Select [Save], [Recall] or [AllCLR] using the rotary 3 control, and execute using [Enter]. [Save] saves the settings and overwrites any existing settings, [Recall] loads the settings, and [All CLR] clears the settings.

When [Save] or [AllCLR] is selected, [OK?] appears. Enter the selection again using [Enter] or cancel using [Shift] + [Enter].

It is also possible to clear all the settings by holding down [Shift] + [Enter] when the power is turned on so that the factory settings are restored.

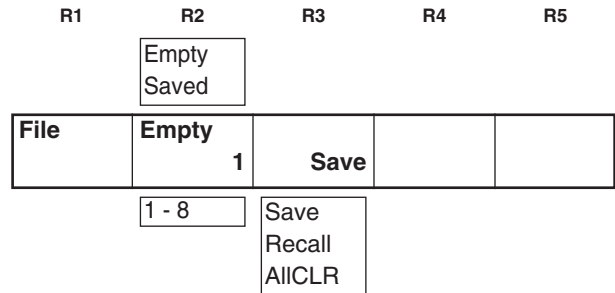

Other settings

Event memory

Setting method

Event
00E

One hundred panel statuses can be stored in event memories 0 to 99. Press the Set button, set the event number using the number keys, and enter the setting using [Enter].

Set button: Its lamp lights during the setting process. When [Enter] is pressed, it flashes for two seconds and then goes off.

When the setting is in progress, Event is displayed in reverse video, and the event is then entered using [Enter]. Event numbers can be incremented and decremented using the “+” and “-” keys. Empty events are indicated by [E] appearing next to the event number.

Recall method

Press the [Recall] button, select the event number to be loaded using the number keys, and recall it using the [Enter] or [AutoTake] button.

Recall button: Its lamp flashes while recall is underway. It lights when the button is set to ON, and goes off when it is set to OFF or when the recall is completed.

Since the input settings are not reflected during loading, events are executed in respect of the input set beforehand. Events 50 to 59, 60 to 69, 70 to 79, 80 to 89 and 90 to 99 can be set consecutively in units of 10 events and also recalled consecutively so they can also serve as key frame settings. Events are executed using the [Auto] button. With the recall of events 50 to 99, the Setup status of the head event is valid.

Clearing events

Set the number of the event to be cleared using [Recall], and execute clearing using [Shift] + [Enter]. Clearing all the events is possible by inputting a period twice at the recall stage and then pressing [Shift] + [.] . Alternatively, this can be achieved by starting the system by pressing [Shift] + [Enter] when the power is turned on, and restoring the factory settings.

Pattern settings

Press the [Pattern] button, input the pattern number using the number keys, and execute using [Enter]. If the pattern does not exist, operation will jump to the nearest pattern number.

Pattern
3015

Each time [Pattern] is pressed, the function is set to ON or OFF. The default setting is MIX (56).

Pattern numbers are incremented and decremented using the “+” and “-” keys. Patterns that do not exist are skipped and displayed in turn.

Other settings

Transition time setting

Select the item to be set, and press the [ME], [DSK] or [FADE] button.

Input the numerical value using the number keys, and press [Enter].

The numerical value can be incremented and decremented using rotary TIME or the “+” and “-” keys.

Set the ME (back, key transition), DSK or fade time.

Set the time of the item selected for ME, DSK or Fade above the number keys.

The time is indicated on the LCD display. It can also be input or output using the number keys.

With x:xx displays, it is possible to input [2][.][5] to display 2:05 where [.] is used as a delimiter.

The default setting is 60F.

ME Time
10:00F

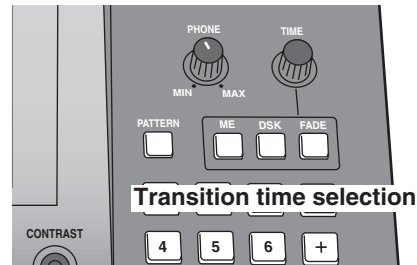

Correlation between number key settings and [Pattern] button

[Pattern] takes precedence over [ME], [DSK] and [Fade].

Items selected by ME, DSK or Fade can be set by the rotary controls. The number keys can also be used when Pattern is OFF. The items selected appear on the LCD display.

There are three options—ME, DSK and Fade—and they can be set to OFF by pressing the ON button. In this case, neither the rotary controls nor the number keys can be used.

Number key priorities

The number key priorities are: event memories → pattern settings → transition time settings → LCD screen settings.

In the event memories, the number keys cannot be used for pattern settings, transition time settings or LCD screen settings.

Transition patterns

Basic												
	1	2	3	4	5	6	7	8	9	10	11	
Pair												
	63	64	65	66	67	68	69	70				
Blinds												
	79	80	81	82	83	84	85	86	87	88	89	
Multi H3												
	301		302		303	304	305	306	307		308	
Multi V3												
		321		322	323	324	325	326		327	328	
Multi H6												
Overlap	103 341		342		343	344	345	346	347		348	
Multi V6												
		104 361		362	363	364	365	366		367	368	
Multi HV3												
				381	382	383	384				385	
Multi HV6												
				105 398	106 399	107 400	108 401				109 402	
Multi PairH3												
Overlap	122 415			416	417	418	419					
Multi PairV3												
Overlap		123 428		429	430	431	432					

Transition patterns

Basic												
	12	13	14	15	16	17	18	19	20	21	22	23
Pair												
					71	72	73	74	75	76	77	78
Blinds												
	90	91	92	93	94	95	96	97	98	100	101	102
Multi H3												
	309	310	311	312	313	314	315	316	317	318	319	320
Multi V3												
	329	330	331	332	333	334	335	336	337	338	339	340
Multi H6												
	349	350	351	352	353	354	355	356	357	358	359	360
Multi V6												
	369	370	371	372	373	374	375	376	377	378	379	380
Multi HV3												
	386	387	388	389	390	391	392	393	394	395	396	397
Multi HV6												
Overlap	110 403	111 404	112 405	113 406	114 407	115 408	116 409	117 410	118 411	119 412	120 413	121 414
Multi PairH3												
					420	421	422	423	424	425	426	427
Multi PairV3												
Overlap					124 433	125 434	435	436	126 437	127 438	439	440

Transition patterns

Multi PairH6												
	441				442	443	444	445				
Multi PairV6												
		454			455	456	457	458				
Multi PairHV3												
					467	468	469	470				
Multi PairHV6												
					479	480	481	482				
Mtrix												
Overlap	24 701	25 702	26 703	27 704	705	706	707					
Basic2												
Overlap	183 801	184 802	185 803	186 804	187 805	188 806	189 807	190 808	191 809	192 810		
DVE BPreSet	Mosaic XY	Mosaic X	Mosaic Y	Defocus	H Mirror	V Mirror	HV Mirror	Nega YC	Nega Y	Nega C	Mono	Paint
Overlap	200 1001	201 1002	202 1003	203 1004	204 1005	205 1006	206 1007	207 1008	208 1009	209 1010	210 1011	211 1012
Shutter												
Overlap	223 1091	224 1092	225 1093	226 1094								
Direct Pattern	DT 1	DT 2	DT 3	DT 4	DT 5	DT 6	DT 7					
	241	242	243	244	245	246	247					
Comp1												
Overlap +Diss	28 1501 1521	29 1502 1522	30 1503 1523	31 1504 1524	36 1505 1525	37 1506 1526	38 1507 1527	39 1508 1528	40 1509 1529	41 1510 1530		
Comp2												
Overlap	32 1541	33 1542	34 1543	35 1544	130 1545	131 1546	132 1547	133 1548				

<Notes>

- The DVE and Shutter patterns cannot be used for DSK effect. The Comp1 and Comp2 patterns can be used for DSK effect only when the 3D optional board (AG-VE70) has been installed.
- Pattern MIX (56) is used for DVE BPreSet.

Transition patterns

Multi PairH6												
					446	447	448	449	450	451	452	453
Multi PairV6												
					459	460	461	462	463	464	465	466
Multi HV3												
					471	472	473	474	475	476	477	478
Multi PairHV6												
					483	484	485	486	487	488	489	490
Panel	Panel Setting	Panel Setting										
	0	99										
Basic2					LUM	CUT MIX	SAT MIX					
	193 811	194 812	195 813	196 814	197 1082	198 1083	199 1084					
DVE BPreSet	CUT	Still Field	Still Fram	Strobe	4Multi Strob	9Multi Strob	16Multi Strob	Decay	Video FxB	Color FxB	V+C FxB	
	212 1059	213 1060	214 1061	215 1062	216 1063	217 1064	218 1065	219 1066	220 1067	221 1068	222 1069	
			MIX	MIX			NAM					
			55 1010	56 1080	57	58	60 1081					
Direct Pattern	DK 1	DK 2	DK 3	DK 4	DK 5	DK 6						
	248	249	250	251	252	253						
Comp1												
Overlap +Diss	42 1511 1531	128 1512 1532		129 1513 1533								
Tumble												
Overlap	141 1549	142 1550										

+DISS: This denotes a pattern to which the dissolve effect can be applied.

Transition patterns

Slide1												
Overlap +Diss	43 1301 1311	44 1302 1312	45 1303 1313	46 1304 1314	51 1305 1315	52 1306 1316	53 1307 1317	54 1308 1318				
Slide2												
Overlap	47 1341	48 1342	49 1343	50 1344	134 1345	135 1346	136 1347	137 1348				
2D Move1												
Overlap +Diss	143 1401 1411	144 1402 1412	145 1403 1413	146 1404 1414	147 1405 1415	148 1406 1416	149 1407 1417	150 1408 1418				
2D Move2 /Exp												
Overlap +Diss	151 1421 1431	152 1422 1432	153 1423 1433	154 1424 1434	155 1425 1435	156 1426 1436	157 1427 1437	158 1428 1438				
2D Move2 /Exp Curve2												
Overlap +Diss	167 1461 1471	168 1462 1472	169 1463 1473	170 1464 1474	171 1465 1475	172 1466 1476	173 1467 1477	174 1468 1478				
Rotate												
+Diss	1601 1611	1602 1612	1603 1613	1604 1614								
Split Slide												
+Diss	1620 1660	1621 1661	1622 1662	1623 1663	1624 1664	1625 1665	1626 1666	1627 1667	1628 1668	1629 1669	1630 1670	
Split												
+Diss	1639 1679	1640 1680	1641 1681	1642 1682	1643 1683	1644 1684	1645 1685	1646 1686	1647 1687	1648 1688	1649 1689	1650 1690
Pers1												
+Diss	1701 1741	1702 1742	1703 1743	1704 1744	1705 1745	1706 1746	1707 1747	1708 1748	1730 1750	1731 1751	1732 1752	1733 1753
PersMove1												
+Diss	1761 1781	1762 1782	1763 1783	1764 1784	1765 1785	1766 1786	1767 1787	1768 1788				
PersMove2												
+Diss	1801 1821	1802 1822	1803 1823	1804 1824	1805 1825	1806 1826	1807 1827	1808 1828				

<Notes>

- The 2D Move2/EXP patterns cannot be used for DSK effect. The Slide1, Slide2, 2D Move1 and 2D Move2 patterns can be used for DSK effect only when the 3D optional board (AG-VE70) has been installed.
- Transition patterns 1601 to 2617 can be used only when the 3D optional board (AG-VE70) has been installed.

Transition patterns

Bounce												
Overlap +Diss	138 1321 1331	139 322 1332	140 1323 1333									
2D Move2 /Exp												
Overlap +Diss	159 1441 1451	160 1442 1452	161 1443 1453	162 1444 1454	163 1445 1455	164 1446 1456	165 1447 1457	166 1448 1458				
2D Move2 /Exp Curve2												
Overlap +Diss	175 1481 1491	176 1482 1492	177 1483 1493	178 1484 1494	179 1485 1495	180 1486 1496	181 1487 1497	182 1488 1498				
Split Slide												
2DComp +Diss	1631 1671	1632 1672	1633 1673	1634 1674	1635 1675	1636 1676	1637 1677	1638 1678				
Split												
+Diss	1651 1691	1652 1692	1653 1693	1654 1694	1655 1695	1656 1696	1657 1697	1658 1698	1659 1699			
Pers1												
+Diss	1734 1754	1735 1755	1736 1756	1737 1757	1738 1758	1739 1759						
PersMove1												
+Diss	1769 1789	1770 1790	1771 1791	1772 1792	1773 1793							
PersMove1												
+Diss	1769 1789	1770 1790	1771 1791	1772 1792	1773 1793							

+DISS: This denotes a pattern to which the dissolve effect can be applied.

Transition patterns

Spin												
+Diss	1841 1851	1842 1852	1843 1853	1844 1854	1845 1855	1846 1856						
Flip Tumble												
Overlap	1902	1903	1904	1905	1906		1960	1961	1962	1963		
Twist												
+Diss	2001 2011	2002 2012	2003 2013	2004 2014	2005 2015	2006 2016	2007 2017	2008 2018	2009 2019			
Roll												
+Diss	2051 2071	2052 2072	2053 2073	2054 2074	2055 2075	2056 2076	2057 2077	2058 2078				
Page1												
+Diss	2101 2151	2102 2152	2103 2153	2104 2154	2105 2155	2106 2156	2107 2157	2108 2158				
Page2												
+Diss	2118 2168	2119 2169	2120 2170	2121 2171	2122 2172	2123 2173	2124 2174	2125 2175				
Page3												
+Diss	2131 2183	2132 2184	2133 2185	2134 2186	2135 2187	2136 2188	2137 2189	2138 2190				
Sphere												
2DComp +Diss	2201 2231	2202 2232	2203 2233	2204 2234	2205 2235	2206 2236	2207 2237	2208 2238	2209 2239			
Accordion Flag1												
2DComp +Diss	2401 2461	2402 2462	2403 2463	2404 2464	2405 2465	2406 2466	2407 2467	2408 2468	2409 2469	2410 2470	2411 2471	2412 2472
Flag2												
2DComp +Diss	2431 2491	2432 2492	2433 2493	2434 2494	2435 2495	2436 2496	2437 2497	2438 2498	2439 2499	2440 2500		
Ripple												
2DComp +Diss	2601 2611	2602 2612	2613	2604 2614	2605 2615	2606 2616	2617					

<Notes>

- The Flip Tumble, Twist and Roll and Page1, 2, 3 patterns cannot be used for DSK Effect.
- Transition patterns 1601 to 2617 can be used only when the 3D optional board (AG-VE70) has been installed.

Transition patterns

Spin												
2DComp +Diss	1861 1871	1862 1872	1863 1873	1864 1874	1865 1875	1866 1876	1881 1891	1882 1892	1883 1893	1884 1894		
Flip Tumble												
Overlap	1964	1965	1966	1967								
Shutter						3D DVE	Ripple	Spark	Multi Move			
Overlap	1971	1972	1973	1974			1981	1982	1983			
Roll												
+Diss	2059 2079	2060 2080	2061 2081	2062 2082	2063 2083	2064 2084	2065 2085	2066 2086	2067 2087	2068 2088		
Page1												
+Diss	2109 2159	2110 2160	2111 2161	2112 2162	2113 2163	2114 2164	2115 2165	2116 2166	2117 2167			
Page2												
+Diss	2126 2176	2127 2177	2128 2178	2129 2179								
Page3												
+Diss	2139 2191	2140 2192	2141 2193	2142 2194	2143 2195							
Sphere												
+Diss	2210 2240	2211 2241	2212 2242	2213 2243	2214 2244	2215 2245	2216 2246	2217 2247	2218 2248	2219 2249	2220 2250	
Accordion Flag1												
+Diss	2413 2473	2414 2474	2415 2475	2416 2476	2417 2477	2418 2478	2419 2479	2420 2480	2421 2481	2422 2482	2423 2483	
Flag2												
+Diss	2441 2501	2442 2502	2443 2503									

+DISS: This denotes a pattern to which the dissolve effect can be applied.

Key patterns

BasicPattern Key													
Diss Exp Exp+Diss	3001 3021 3041	3002 3022 3042	3003 3023 3043	3004 3024 3044	3005 3025 3045	3006 3026 3046							
Basic Key	CHR	LUM	EXT										
Overlap	62 3101	61 3102	59 3103										
PinP													
Diss Exp Exp+Diss	3301 3311 3321	3302 3312 3322	3303 3313 3323	3304 3314 3324									
2D Move													
Exp +Diss	3401 3411	3402 3412	3403 3413	3404 3414	3405 3415	3406 3416	3407 3417	3408 3418					
2D Move2													
ExpCurve2 +Diss	3441 3451	3442 3452	3443 3453	3444 3454	3445 3455	3446 3456	3447 3457	3448 3458					
DualPinP													
Move +Diss	3501 3511	3502 3512	3503 3513	3504 3514	3505 3515	3506 3516	3507 3517	3508 3518					
DualPinP													
Move +Diss	3541 3551	3542 3552	3543 3553	3544 3554	3545 3555	3546 3556	3547 3557	3548 3558					
Slide1 +Comp													
Move +Diss	3601 3621	3602 3622	3603 3623										
Rotate													
2DComp +Diss	4601 4611	4602 4612	4603 4613	4604 4614									
3D Slide													
2DComp +Diss	4620 4660	4621 4661	4622 4662	4623 4663	4624 4664	4625 4665	4626 4666	4627 4667	4628 4668	4629 4669	4630 4670		
Split													
2DComp +Diss	4639 4679	4640 4680	4641 4681	4642 4682	4643 4683	4644 4684	4645 4685	4646 4686	4647 4687	4648 4688	4649 4689	4650 4690	

<Notes>

- The key patterns that can be used for DSK Effect are 6001, 6002, 6003, 6006, 6007 and 6101 to 6634.
- BasicPattern Key, Basic Key and Title are the key patterns for which Rev can be used.
- Key patterns 4601 to 6716 can be used only when the 3D optional board (AG-VE70) has been installed.

Key patterns

Spot Light													
Diss Exp Exp+Diss	3305	3315 3325											
2D Move													
Exp +Diss	3421 3431	3422 3432	3423 3433	3424 3434	3425 3435	3426 3436	3427 3437	3428 3438					
2D Move2													
ExpCurve2 +Diss	3461 3471	3462 3472	3463 3473	3464 3474	3465 3475	3466 3476	3467 3477	3468 3478					
DualPinP													
Move +Diss	3521 3531	3522 3532	3523 3533	3524 3534	3525 3535	3526 3536	3527 3537	3528 3538					
DualPinP													
Move +Diss	3561 3571	3562 3572	3563 3573	3564 3574	3565 3575	3566 3576	3567 3577	3568 3578					
3D Slide													
2DComp +Diss	4631 4671	4632 4672	4633 4673	4634 4674	4635 4675	4636 4676	4637 4677	4638 4678					
Split													
2DComp +Diss	4651 4691	4652 4692	4653 4693	4654 4694	4655 4695	4656 4696	4657 4697	4658 4698	4659 4699				

+DISS: This denotes a pattern to which the dissolve effect can be applied.
EXP: This denotes a pattern that appears bigger and bigger.

Key patterns

Pers1												
2DComp +Diss	4701 4741	4702 4742	4703 4743	4704 4744	4705 4745	4706 4746	4707 4747	4708 4748	4730 4750	4731 4751	4732 4752	4733 4753
PersMove1												
2DComp +Diss	4761 4781	4762 4782	4763 4783	4764 4784	4765 4785	4766 4786	4767 4787	4768 4788				
PersMove2												
2DComp +Diss	4801 4821	4802 4822	4803 4823	4804 4824	4805 4825	4806 4826	4807 4827	4808 4828				
Spin												
2DComp +Diss	4841 4851	4842 4852	4843 4853	4844 4854	4845 4855	4846 4856						
Sphere												
2DComp +Diss	5201 5231	5202 5232	5203 5233	5204 5234	5205 5235	5206 5236	5207 5237	5208 5238	5209 5239			
Flag1												
2DComp +Diss	5401 5461	5402 5462	5403 5463	5404 5464	5405 5465	5406 5466	5407 5467	5408 5468	5409 5469	5410 5470	5411 5471	5412 5472
Flag2												
2DComp +Diss	5431 5491	5432 5492	5433 5493	5434 5494	5435 5495	5436 5496	5437 5497	5438 5498	5439 5499	5440 5500		
Ripple												
2DComp +Diss	5601 5611	5602 5612	5613	5614								
3DBasic												
+Diss	6001	6002	6003	6004	6005	6006	6007	6008	6009	6010		
Ripple												
2DComp +Diss	6031	6032										
Flag Move												
Move +Diss	6101 6111	6102 6112	6103 6113	6104 6114	6105 6115	6106 6116	6107 6117	6108 6118	6109 6119			

<Notes>

- The key patterns that can be used for DSK Effect are 6001, 6002, 6003, 6006, 6007 and 6101 to 6634.
- Key patterns 4601 to 6716 can be used only when the 3D optional board (AG-VE70) has been installed.

Key patterns

Pers1												
2DComp +Diss	4734 4754	4735 4755	4736 4756	4737 4757	4738 4758	4739 4759						
PersMove1												
2DComp +Diss	4769 4789	4770 4790	4771 4791	4772 4792	4773 4793							
Spin												
2DComp +Diss	4861 4871	4862 4872	4863 4873	4864 4874	4865 4875	4866 4876	4881 4891	4882 4892	4883 4893	4884 4894		
Sphere												
2DComp +Diss	5210 5240	5211 5241	5212 5242	5213 5243	5214 5244	5215 5245	5216 5246	5217 5247	5218 5248	5219 5249	5220 5250	
Flag1												
2DComp +Diss	5413 5473	5414 5474	5415 5475	5416 5476	5417 5477	5418 5478	5419 5479	5420 5480	5421 5481	5422 5482	5423 5483	
Flag2												
2DComp +Diss	5441 5501	5442 5502	5443 5503									
Melt												
2DComp +Diss	6033	6034										
Flag Move												
Move +Diss	6121 6131	6122 6132	6123 6133	6124 6134	6125 6135	6126 6136	6127 6137	6128 6138	6129 6139			

+DISS: This denotes a pattern to which the dissolve effect can be applied.

EXP: This denotes a pattern that appears bigger and bigger.































Key patterns

Accordion												
Move +Diss	6201 6211	6202 6212	6203 6213	6204 6214	6205 6215	6206 6216	6207 6217	6208 6218	6209 6219			
Sphere												
Move +Diss	6301 6311	6302 6312	6303 6313	6304 6314	6305 6315	6306 6316	6307 6317	6308 6318				
Sphere Curve												
Move +Diss	6401 6411	6402 6412	6403 6413	6404 6414	6405 6415	6406 6416	6407 6417	6408 6418				
Spin to Pers												
Move +Diss	6501 6521	6502 6522	6503 6523	6504 6524	6505 6525	6506 6526	6507 6527	6508 6528	6509 6529	6510 6530	6511 6531	6512 6532
Pers In												
Move +Diss	6601 6611	6602 6612	6603 6613	6604 6614	6605 6615	6606 6616	6607 6617	6608 6618				
Pers In 2												
Move +Diss	6701 6711	6702 6712	6703 6713	6704 6714	6705 6715	6706 6716						
Key Learn	Key Learn1	Key Learn2	Key Learn3	Key Learn4	Key Learn5	Key Learn6	Key Learn7	Key Learn8	Key Learn9	Key Learn10		
	9000	9001	9002	9003	9004	9005	9006	9007	9008	9009		
Title	T-1	T-2	T-3	T-4	T-5	T-6	T-7	T-8	T-9	T-10	T-11	T-12
Diss	9501	9511	9521	9531	9541	9551	9561	9571	9581	9591	9601	9611
Title	T-25	T-26	T-27	T-28	T-29	T-30						
Diss	9741	9751	9761	9771	9781	9791						

<Notes>

- The key patterns that can be used for DSK Effect are 6001, 6002, 6003, 6006, 6007 and 6101 to 6634.
- Key patterns 4601 to 6716 can be used only when the 3D optional board (AG-VE70) has been installed.

Key patterns

Accordion												
Move +Diss	6221 6231	6222 6232	6223 6233	6224 6234	6225 6235	6226 6236	6227 6237	6228 6238	6229 6239			
Sphere												
Move +Diss	6321 6331	6322 6332	6323 6333	6324 6334	6325 6335	6326 6336	6327 6337	6328 6338	6329 6339			
Sphere Curve												
Move +Diss	6421 6431	6422 6432	6423 6433	6424 6434	6425 6435	6426 6436	6427 6437	6428 6438				
Pers In												
Move +Diss	6621 6631	6622 6632	6623 6633	6624 6634								
Title	Key Learn11	Key Learn12	Key Learn13	Key Learn14	Key Learn15	Key Learn16	Key Learn17	Key Learn18	Key Learn19	Key Learn20		
Diss	9010	9011	9012	9013	9014	9015	9016	9017	9018	9019		
Title	T-13	T-14	T-15	T-16	T-17	T-18	T-19	T-20	T-21	T-22	T-23	T-24
Diss	9621	9631	9641	9651	9661	9671	9681	9691	9701	9711	9721	9731

+DISS: This denotes a pattern to which the dissolve effect can be applied.

EXP: This denotes a pattern that appears bigger and bigger.

About this software

Description of the software

The software contained in the CD is described below.

■ USB driver

This driver software is for communications when the AG-MX70 is connected to a PC via the USB port.

■ MX-Navi

This software is for use when transmitting images from a PC to the AG-MX70 and playing them back and when reading still images from the AG-MX70 into a PC. Installing this software makes the following possible.

Transmitting of images from a PC to the AG-MX70

- PC images can be transmitted to the AG-MX70 as Title data or IntVideo data.
- Playback and pause operations can be performed with the transmitted data.

Reading of still images from the AG-MX70 into a PC

- Images displayed on the AG-MX70 can be read into a PC as still images.

Management of the AG-MX70 memory

- It is possible to check the status and change the settings of the AG-MX70's image memory.

Refer to "Before use" on pages 77 to 79 when installing this software.

System requirements

The PC to be used should meet the following requirements.

- | | |
|-------------|--|
| • Computer | DOS/V with USB port |
| • OS | Windows 98
Windows ME
Windows 2000 Professional
Windows XP HomeEdition
Windows XP Professional |
| • CPU | Pentium II 300 MHz or better |
| • RAM | 64 MB or more |
| • Display | True Color (24 bits, 32 bits)
800×600 dots or more |
| • Hard disk | 5 MB or more free space |
| • Other | CD-ROM drive |

Overview of MX-Navi

MX-Navi is software used when transmitting images from a PC to the AG-MX70 and displaying them and when reading still images from the AG-MX70 into a PC.

The following are possible when a PC has been connected to the AG-MX70.

- DSK display of the PC screen as telop or animation.
- Display of the PC screen with internal matte.
- Images provided as input to the AG-MX70 can be read into the PC as still images and be converted to image files.

Processing of image data

■ By data type

Image data is processed by the AG-MX70 either as Title data or IntVideo data, depending on the application. When image data is transmitted to the AG-MX70, it is necessary to first select one of these 2 data types.

● Title data

Data to be used for DSK playback should be transmitted as Title data. RGB data and α channel data are used by Title data. When an image having an α channel is used, the image is subjected to transparency processing corresponding to the value of the α channel. When an image not having an α channel is used, transparency processing is not performed.

● IntVideo data

When the image is to be played back as internal matte, it is transmitted as IntVideo data. The image uses only RGB data. As the α channel is not used, transparency processing is not performed.

■ Display methods

It is possible to select from the following display methods according to how the image data is to be played back.

● STILL

With this method, a single image is played back as a still image. Both Title data and IntVideo data can be used. When Title data is used, it is possible to set the horizontal position and vertical position of the image.



● MOVIE

With this method, two or more images are played back consecutively. A single image is processed as one frame. It is possible to select from ONCE or REPEAT playback. Both Title data and IntVideo data can be used. When Title data is used, it is possible to set the horizontal position and vertical position of the image.

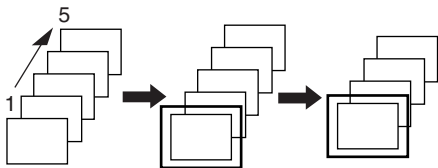

● CRAWL

Two or more images are lined up one after the other and played back (scrolled) horizontally on the screen. It is possible to set the direction and the speed for scrolling. Only Title data can be used with this method. It is possible to set the vertical position of the image.

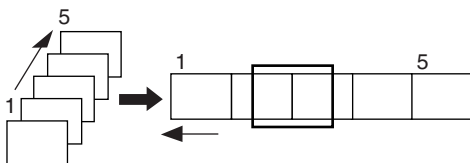

● ROLL

Two or more images are lined up one after the other and played back (scrolled) vertically on the screen. It is possible to set the direction and the speed for scrolling. Only Title data can be used with this method. It is possible to set the horizontal position of the image.

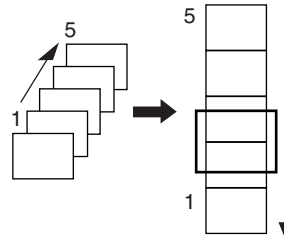

■ DSK effects

When an image is displayed on (DSK ON) or cleared from (DSK OFF) the monitor, it is possible to apply dissolve or 2 or 3D transition effects.

■ Image size

The appropriate size of images for the Monitor 1 screen differs, depending on the video format setting of the AG-MX70 and the MX-Navi settings.

NTSC: Monitor 1 screen = 640 × 480

PAL: Monitor 1 screen = 768 × 576

It is possible to select any image size for playback, however, if the image size selected is larger than the Monitor 1 screen, only the part of the image that fits onto the screen will be transmitted and played back.

■ Image formats supported

It is possible to use the following image formats for playback with the AG-MX70.

● TARGA (.tga)

24 bit/pixel (no α channel) data and 32 bit/pixel (with α channel) data can be used.

● JPEG (.jpg)

● BMP (.bmp)

24 bit/pixel (no α channel) data can be used.

A 32 bit/pixel image of the TARGA format must be used when the image is to be displayed with transparency processing. When displaying images using either MOVIE, ROLL or CRAWL methods, it is necessary to use consecutively numbered file names.

(e.g. Image001.tga to Image015.tga)

Processing of image data

■ Management of the image memory

● Memory capacity

Images transmitted from the PC are stored in the AG-MX70's image memory. The memory capacity differs, depending on the AG-MX70's video format setting.

NTSC: 30 pages

(1 page = amount of memory required for 1 image on Monitor 1 screen)

PAL: 26 pages

The image memory is divided into separate areas for Title data and IntVideo data and capacity can be allocated freely as required.

● DIVIDE

The number of memory pages used differs, depending on the number of vertical pixels, however this only applies when images are transmitted as Title data. The memory pages being used can be reduced by adjusting the size of the image for DSK playback, so that a larger number of images can be played back.

	Number of vertical pixels	Number of memory pages used
NTSC	1 to 60	1/8 page
	61 to 120	1/4 page
	121 to 240	1/2 page
	241 to 480	1 page
PAL	1 to 72	1/8 page
	73 to 144	1/4 page
	145 to 288	1/2 page
	289 to 576	1 page

<Notes>

- When the vertical position is set, images with a small number of vertical pixels can be played back on the lower part of the screen. This is effective for DSK playback of telop or logos at the lower part of the screen.
- IntVideo data always use one memory page, regardless of the image size.

Before use

AG-MX70 connections

It is necessary to connect the PC to the AG-MX70 using the USB cable before installing the software. Follow the steps below.

- 1) Turn off the power to the AG-MX70.
- 2) Connect the PC to the AG-MX70 using the USB cable.
Insert the USB cable connectors into the corresponding USB ports on the PC and on the rear panel of the AG-MX70.

This completes the connection. When the 2 units are being connected for the first time, install the USB driver by following the steps in "Installation of USB driver" below.

<Note>

The USB cable is not supplied with this unit. Use a commercially available 3 m or shorter USB cable. Note that if the cable to be used is more than 3 m in length, communications may not be performed correctly.

Installation of the USB driver

It is necessary to install this driver in the PC to enable USB communications between the PC and AG-MX70 after they are connected for the first time. (It is only necessary to install the USB driver software once.) Follow the steps below.

■ For Windows 98 and Windows 2000

<Notes>

- The steps outlined below are for Windows 98. With Windows 2000, the screens will differ slightly, but the driver software can still be installed following the same steps.
- Be sure to log on as a user with Administrator rights when installing this software in a PC with Windows 2000.

- 1) Connect the PC to the AG-MX70 correctly.
- 2) Turn on the power to the PC.
Check that Windows has started up.
- 3) Place the setup CD-ROM in the PC's CD-ROM drive.
- 4) Turn on the power to the AG-MX70.
After a short while, the "Add New Hardware Wizard" dialog will be displayed.
- 5) Click on the "Next" button.

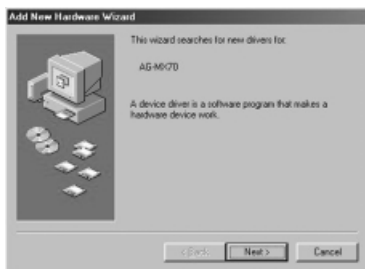

- 6) Select "Search for the best driver for your device," then click on the "Next" button.



- 7) Place a check next to "Specify a location," enter the USB_DRV folder in the setup CD-ROM as the search location and click on the "Next" button.



- 8) If the driver is searched correctly, a screen similar to the one shown below will be displayed.



- 9) When the screen indicating that the installation is complete is displayed, click on the "Finish" button.



Before use

■ For Windows ME

- 1) Connect the PC to the AG-MX70 correctly.
- 2) Turn on the power to the PC.
Check that Windows has started up.
- 3) Place the setup CD-ROM in the PC's CD-ROM drive.
- 4) Turn on the power to the AG-MX70.
After a short while, the "Add New Hardware Wizard" dialog will be displayed.
- 5) Select "Automatic search for a better driver," then click on the "Next" button.



- 6) When the screen indicating that the installation is complete is displayed, click on the "Finish" button.



■ For Windows XP

<Note>

Be sure to log on as a user with Administrator rights when installing this software.

- 1) Connect the PC to the AG-MX70 correctly.
- 2) Turn on the power to the PC.
Check that Windows has started up.
- 3) Place the setup CD-ROM in the PC's CD-ROM drive.
- 4) Turn on the power to the AG-MX70.
After a short while, the "Found new hardware wizard" dialog will be displayed.
- 5) Select "Install the software automatically," then click on the "Next" button.



- 6) If the installation warning screen is displayed, click on the "Continue Anyway" button.



- 7) When the screen indicating that the installation is complete is displayed, click on the "Finish" button.



Before use

Installation of MX-Navi

After installing the USB driver, install MX-Navi, the software for handling image exchange with the AG-MX70. Follow the steps below.

- 1) Select "Run..." from the "Start" menu. Click the "Browse" button, select Setup.exe in the MX-Navi folder of the setup CD-ROM, and click "OK."

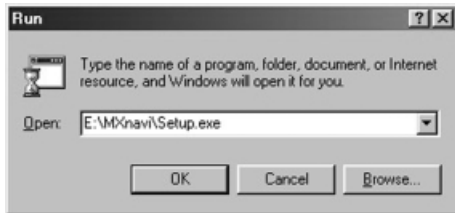

- 2) The setup start screen will be displayed. Click the "Next" button.

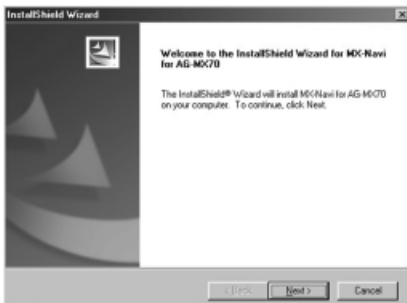

- 3) The screen for setting the MX-Navi installation destination will be displayed. If the destination shown is the one desired, just click the "Next" button. To change the installation destination, click the "Browse" button, change the installation destination, and click the "Next" button.

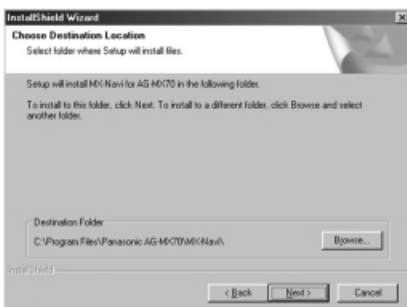

- 4) The screen for selecting the installation type is displayed. When "Typical" has been selected, the program files of MX-Navi and sample images are installed. When "compact" has been selected, only the MX-Navi program is installed. Select the type and click the "Next" button.

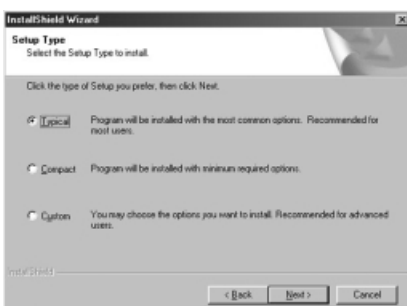

- 5) The installation contents confirmation screen appears.

To proceed with the installation of the contents shown, click the "Next" button. To change the contents, use the "Back" button to return to the previous screen, and change the settings.

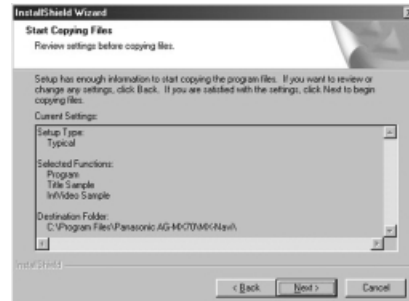

- 6) After the files have been copied, the installation end screen appears. Installation is completed by clicking the "Finish" button now.

Operation confirmation

This completes installation of all of the software. Use the following procedure to confirm that the software has been installed correctly.

- 1) Confirm that the PC and the AG-MX70 have been connected correctly and that the power of the AG-MX70 is switched on.
- 2) Select "Programs" → "Panasonic AG-MX70" → "MX-Navi" from the Windows Start menu. MX-Navi will start.
- 3) When the display column of the status bar on the left bottom of the main window of MX-Navi shows "Connecting," it means that the software has been installed correctly.

Check that this column shows "Connecting."



<Notes>

If "Not connecting" is shown, check the following.

- PC and AG-MX70 must be connected correctly.
- The power of the AG-MX70 must be switched on.
- The length of the USB cable must be within 3 m.

When a USB hub is being used, correct operation may be obtained when the hub is removed and the cable is connected directly to the USB port of the PC.

Startup and shutdown

How to start up MX-Navi

Select "Program" → "Panasonic AG-MX70" → "MX-Navi" from the Windows Start menu.

How to shut down MX-Navi

Shutdown is possible in the following two ways.

- Click the button  at the right top of the main window.
- Select "Exit" from the "File" menu of the main window.

Screen descriptions

Main window

A list of Title data, called the transmission list, is displayed on the main window. The main window of MX-Navi has two display modes, the icon mode and the list mode. The modes can be switched using the "view" menu.

Icon mode

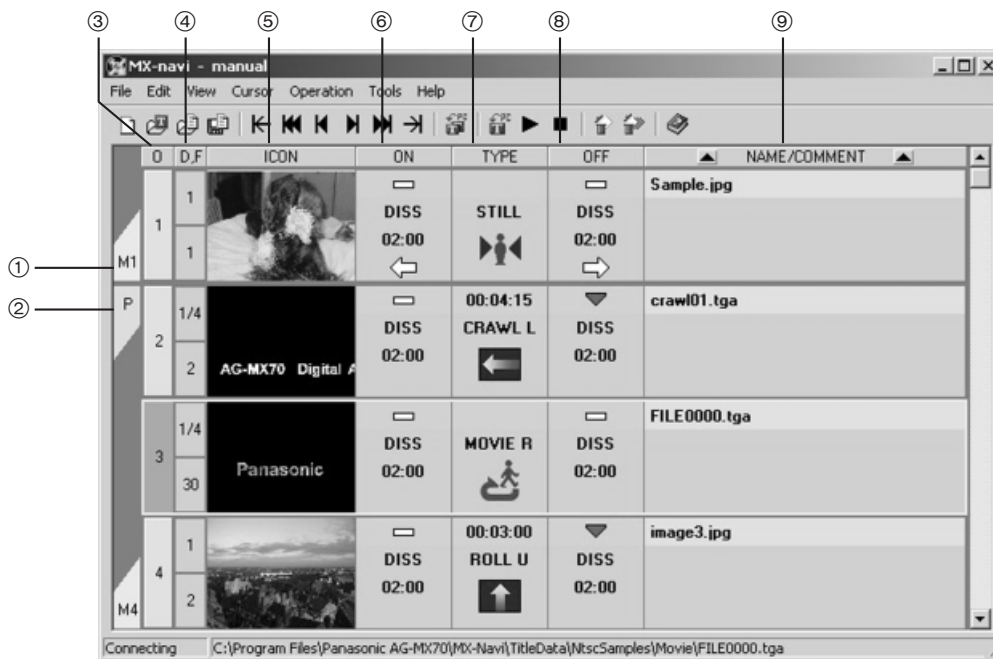

① For data with a Mark setting, the Mark number is displayed. For details on Mark settings, refer to page 87.

② This is displayed for data with the Protect setting. For details on the Protect setting, refer to page 87.

③ O (Order)

The order of the data in the transmission list is displayed. The color changes according to the title transmission status.

- Not transmitted Dark gray
- Transmitted Light gray
- Transmission not possible Dark red (insufficient MX70 memory)

Screen descriptions

④ D, F

The upper line shows the Divide value for the data and the lower line shows the number of images of the data.

⑤ ICON

The image is reduced and displayed. When several files are used with one title, one of them will be used for the display. The aspect ratio of the reduced image changes according to the memory setting (16:9/4:3) of the main unit.

When double-clicked, the image display screen (page 89) opens and the original image can be checked.

⑥ ON

The operation at the time of DSK ON will be displayed. When double-clicked, the Properties window (page 86) will open.

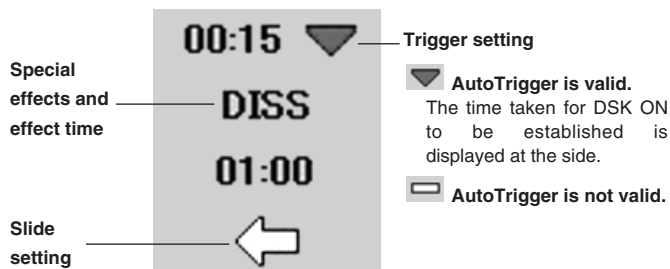

⑧ OFF

The operation at the time of DSK OFF will be displayed. The display contents are the same as for DSK ON. When double-clicked, the Properties window (page 86) will open.

⑨ NAME/COMMENT

The name given to the data and the comment string will be displayed. When double-clicked, the Properties window (page 86) will open.

⑦ TYPE

The data playback format will be displayed. When double-clicked, the Properties window (page 86) will open.

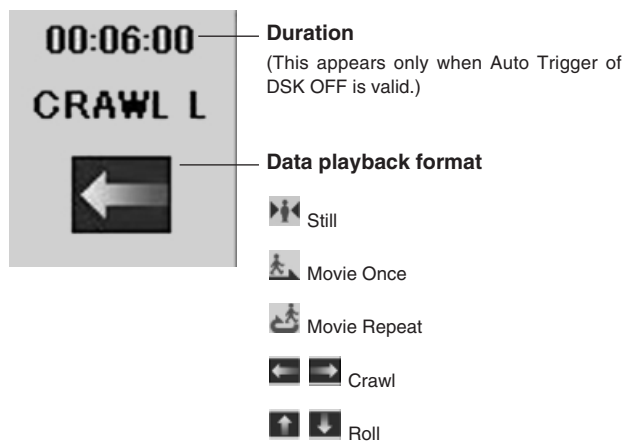

Screen descriptions

List mode

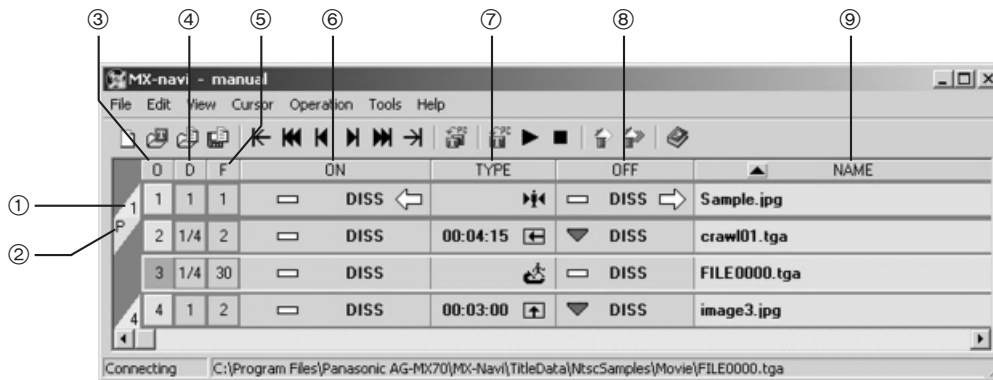

① For data with a Mark setting, the Mark number is displayed.

② This is displayed for data with the Protect setting.

③ O (Order)

The order of the data in the transmission list is displayed. This is the same as with icon mode.

④ D

The Divide value of the data is shown.

⑤ F

The number of images of the data is shown.

⑥ ON

The operation at the time of DSK ON will be displayed. When double-clicked, the Properties window (page 86) will open.



⑦ TYPE

The data playback format will be displayed. When double-clicked, the Properties window (page 86) will open.

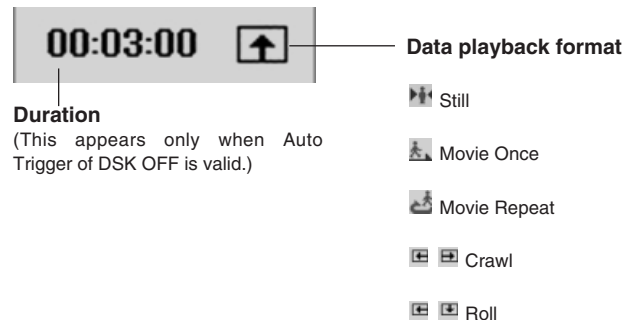

⑧ OFF

The operation at the time of DSK OFF will be displayed. The display contents are the same as for DSK ON. When double-clicked, the Properties window (page 86) will open.

⑨ NAME/COMMENT

The name given to the data will be displayed. When double-clicked, the Properties window (page 86) will open.

The yellow frame is the cursor. The data marked by the cursor will be the object for transmission, deletion, memory clearing, property setting, etc.

When the mouse is left-clicked on data, the cursor will move to that data. When "Ctrl" is held down, several titles can be selected by left-clicking, and when "Shift" is held down, the titles between the first click and the last click will be selected.

When several titles are selected, the data selected first will be the object for Properties settings and screen display. For other operations, all selected titles will be the object.

<Note>

For the setting contents for DSK ON and DSK OFF, refer to "Setting the title data playback properties" (page 86).

Menu descriptions

File menu

Creation of a new list

This clears the current transmission list and creates a new one (refer to page 86). The same operation can be performed with the operation button .

Open image

This opens an image and adds the title data at the end of the transmission list. The same operation can be performed with the operation button .

Open List

This clears the current transmission list and opens a previously saved transmission list. The same operation can be performed with the operation button .

Save List

This overwrites and saves the current transmission list. If the current transmission list does not have a name, the operation becomes the same as with "Save List as...". The same operation can be performed with the operation button .

Save List as...

This saves the current transmission list with a new name.

Preview

This opens the image display screen and displays the image of the title selected by the cursor. The same operation can be performed by double-clicking the ICON column of the data display and selecting "Preview" from the pop-up menu.

Property

This opens the Properties setting screen for the title selected by the cursor. The same operation can be performed by double-clicking the column IN, TYPE, OUT, NAME of the title data display or by right-clicking the title data and selecting "Property" from the displayed menu.

Read flash memory

This reads the data (SETUP menu settings, operation panel settings, etc.) in the flash memory of the AG-MX70, and saves it in files.

Select this menu item after turning on the power while holding down the "0" key and "5" key on the operation panel of the AG-MX70 and setting the AG-MX70 to the flash memory backup mode. A dialog box now appears so input the file name and click the "OK" button to save the flash memory data.

Write Flash memory

This writes the data of the saved file into the flash memory of the AG-MX70.

Select this menu item after turning on the power while holding down the "0" key and "5" key on the operation panel of the AG-MX70 and setting the AG-MX70 to the flash memory backup mode. A dialog box now appears so select the file and click the "OK" button to write the file data. When this operation is performed, all the data in the flash memory of the AG-MX70 is replaced.

Exit

This shuts down the program.

Edit menu

Undo

This undoes data additions, deletions and other operations. Up to 16 steps can be undone. The same operation can be performed by pressing "Ctrl" + "Z."

Redo

This cancels the contents of the Undo. The same operation can be performed by pressing "Ctrl" + "Y."

Cut

This deletes the selected title from the transmission list and saves it to the clipboard. The saved title can be added to the transmission list via the "Paste" menu. Only the title cut last will be saved. The same operation also can be performed by "Ctrl" + "X" or by right-clicking the title data display column and selecting "Cut" from the pop-up menu.

Copy

This copies the selected title to the clipboard. The saved title can be added to the transmission list via the "Paste" menu. Only the title cut last will be saved. The same operation can be performed with "Ctrl" + "C" or by right-clicking the title data display column and selecting "Copy" from the pop-up menu.

Paste

This adds the title saved on the clipboard to the transmission list. The same operation can be performed with "Ctrl" + "V" or by right-clicking the title data display column and selecting "Paste" from the pop-up menu.

Menu descriptions

Delete

This deletes the selected title from the transmission list.

The same operation can be performed with the “DEL” key or by right-clicking on the title data display column and selecting “Delete” from the pop-up menu.

Select all

This selects all titles in the transmission list.

The same operation can be performed by pressing “Ctrl” + “A.”

View menu

ICON view

This switches the display mode for the main screen to icon mode.

The same operation can be performed by right-clicking the data display and selecting “View” → “ICON view” from the displayed pop-up menu.

LIST view

This switches the display mode for the main screen to icon mode.

The same operation can be performed by right-clicking the data display and selecting “View” → “LIST view” from the displayed pop-up menu.

Sort by name

This rearranges the data of the transmission list by the Name character order.

The same operation can be performed with the ▲, ▼ buttons in the Name heading part of the data display.

Sort by comments

This rearranges the transmission list by the Comment character order.

The same operation can be performed with the ▲, ▼ buttons in the Comment heading part of the data display.

Cursor menu

Top

This moves the cursor to the start of the transmission list.

The same operation can be performed with the operation button  or with the HOME key.

Jump to 10th Previous

This moves the cursor up 10 from the present position.

The same operation can be performed with the operation button  or with the Left arrow key.

Previous

This moves the cursor up one from the present position.

The same operation can be performed with the operation button  or with the Up arrow key.

Next

This moves the cursor down one from the present position.

The same operation can be performed with the operation button  or with the Down arrow key.

Jump to 10th Next

This moves the cursor down 10 from the present position.

The same operation can be performed with the operation button  or with the Right arrow key.

Bottom

This moves the cursor to the end of the transmission list.

The same operation can be performed with the operation button  or with the END key.

Jump to the Current DSK Title

This moves the cursor to the title being played.

The same operation can be performed with the number key 0.

Jump to the marked Title

This moves the cursor to a title with a Mark setting.

Select Mark1 to Mark9 from the submenu.

The same operation can be performed with the number keys 1 to 9.

Menu descriptions

Operation menu

(effective only when the AG-MX70 is connected)

AutoLoad

This automatically transmits the data from the selected data to the end of the list and performs DSK playback. For details, refer to “Automatic transmission and playback of Title data” (page 88).

The same operation can be performed with the operation button  or with “Shift” + “Space.”

Load Title

This transmits the selected data. For details, refer to “Manual transmission and playback of Title data” (page 88). The same operation can be performed with the operation button  or with the L key.

Play

This performs DSK playback for the selected data. When the data has not yet been transmitted, DSK playback will be performed after transmission. For details, refer to “Manual transmission and playback of Title data” (page 88).

The same operation can be performed with the operation button  or with “Space.”

Stop

This stops DSK playback.

The same operation can be performed with the operation button .

Clear the selected title

This clears the selected data from the image memory of the AG-MX70. For details, refer to “Clearing Title data” (page 90).

The same operation can be performed with the operation button  or with “Ctrl” + “R.”

Clear all titles

This clears all data in the transmission list from the image memory of the AG-MX70. For details, refer to “Clearing Title data” (page 88).

The same operation can be performed with the operation button  or with “Ctrl” + “T.”

Auto Take

This executes Auto Take using the AG-MX70.

Tool menu

Memory status

This displays the memory status screen. For details, refer to “Checking the memory status of the AG-MX70” (page 90).

AG-MX70 setup

This displays the memory setting screen. For details, refer to “Changing the AG-MX-70 memory settings” (page 90) and “Recalling events” (page 91.)

Properties initial value setting

This displays the Properties initial value setting screen. For details, refer to “Initial set of Property data” (page 92).

Operating environment

This displays the Operating environment screen. For details, refer to “Setting the operating environment” (page 93).

Help menu

Help

This displays the Help contents.

The same operation can be performed with the operation button .

Version

This displays the version of this application.

Title data operations

Flow until Title data playback

The procedure for transmission of PC images as Title data and DSK playback is as follows.

- 1) Register the image in the list of Title data for transmission to the AG-MX70 (transmission list).
- 2) Perform data playback settings.
- 3) Play back and transmit data manually or automatically.

Registering Title data in the transmission list

The transmission list is a list of Title data to be transmitted to the AG-MX70. Up to 99 Title data items can be registered in the transmission list. Images can be registered as Title data in the transmission list using the following procedure.

- 1) Select "Open image" from the "File" menu of the main window. The "Open file" dialog will open.
- 2) Select the image to be transmitted. When playback as MOVIE, ROLL, or CRAWL is desired, select the image to be displayed first from a series of images.
- 3) Set the data playback format etc.

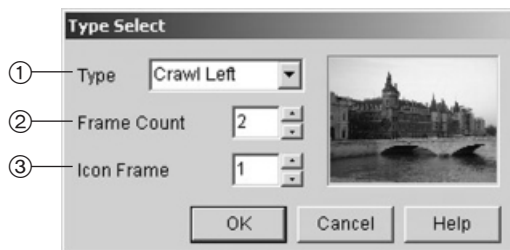

- ① Set the data playback format.
- ② Set the data frame number (number of images).
- ③ Set the frame number for the image to be displayed in the Icon row.

<Note>

When the selected image is not a series format, it will be registered automatically as STILL data, so this screen will not be displayed.

- 4) The data is added to the transmission list and displayed in the main window.

Setting the Title data playback properties

Setting of special effects with DSK ON, DSK OFF, the data display position, etc. will be done automatically according to the initial value settings at the time the data was registered in the transmission list.

These settings can be changed on the Properties screen of the data. The properties screen of the data is opened using the following procedure.

- 1) Move the mouse cursor to the data for which the settings are to be changed and left click on the data. The yellow band cursor will move and the data will be selected.
- 2) Select "Property" from the "File" menu of the main window. The Properties window will open.

Title data operations

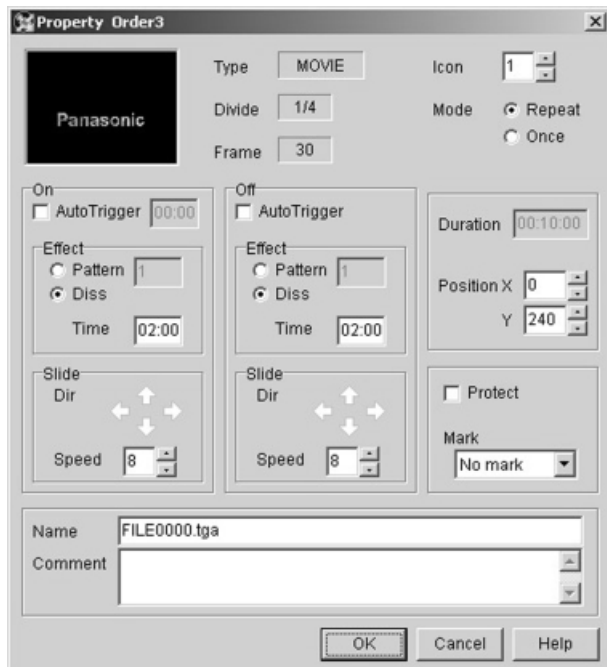

Description of the setting items (depending on the data playback format, some items may not be displayed or setting may not be possible)

Icon: This is used for setting the frame number of the image to be used for display in the ICON row of the main window.

Mode: This is used for selecting ONCE or REPEAT when MOVIE display is being used. During ROLL and CRAWL, it is used for selecting the scroll direction and entering the speed (number of pixels to be moved per field).

On: This is used for setting the operation when the data is displayed on the screen (DSK ON).

- **AutoTrigger:** This sets the start operation.
 - No check: DSK ON will be performed when the playback button on the main window is pressed or when the DSK button on the main unit is pressed.
 - Check: DSK ON will be executed when the specified time has expired after the data playback operation.
- **Effect:** This sets the special effects.
 - Pattern: The specified pattern will be used at DSK ON.
 - Diss: Dissolve will be used.
 - Time: Set the time for execution of special effects from 00:00 to 00:30.
- **Slide:** This is used for the slide display settings.
 - Dir: Click the arrow to select the slide direction.
 - Speed: Enter the slide speed (number of pixels to be moved per field).

Off: This is used for setting the operation to be performed when the data is deleted from the screen (DSK OFF).

- **AutoTrigger:** This sets the start operation.
 - No check: DSK OFF will be performed when the playback button on the main window is pressed or when the DSK button on the main unit is pressed.
 - Check: DSK OFF will be performed according to the time set for Duration.
- **Effect:** Same as for DSK ON.
- **Slide :** Same as for DSK ON.

Duration: This is used for setting the data playback time. The playback time also includes the time for DSK ON and DSK OFF. This is effective only when AutoTrigger of DSK OUT is checked.

Position: This is used for setting the data display position as the offset (pixels) from the left top of the screen. X and Y can be set for STILL and MOVIE, Y can be set for CRAWL, and X can be set for Roll.

- **X:** A value from 0 to 719 can be set for NTSC as well as PAL.
- **Y:** A value of 0 to 480 can be set for NTSC, and a value of 0 to 576 can be set for PAL (only even numbers).

Protect: When this is checked, the data will not be cleared from the memory by normal clearing operation.

Mark: Any number from 1 to 9 can be set. When the number to be set is selected via "Cursor" → "Jump to Mark." it is possible to jump straight to the desired data.

Name: This is used for setting the name of the data. Up to 128 single-byte characters can be entered.

Comment: This is used for setting a comment for the data. Up to 128 single-byte characters can be entered.

<Notes>

- The initial value for the playback setting can be changed at the "Initial set of Property data" screen. (Refer to page 92.)
- When the pattern entered for DSK ON and DSK OFF is a pattern that can not be used with DSK, automatic correction will be made to a similar pattern.
- When there are 3000 or more patterns, the same pattern must be used for DSK ON and DSK OFF. For 0 to 2999 patterns, the combination of DSK ON and DSK OFF can be selected freely.
- Set Time as 00:00 when no special effects are to be used with DSK ON and DSK OFF.
- The position Y value cannot be set when DIVIDE is 1.

Title data operations

Manual transmission and playback of Title data

Data registered in the transmission list can be transmitted to the AG-MX70 using the following procedure.

- 1) Move the cursor to the data to be transmitted and left click on the data.
The yellow frame cursor moves to the selected data.
- 2) Select "Operation" → "Load title" from the menu of the main window.
The data is transmitted to the AG-MX70.

<Notes>

- The time required for the transmission differs according to the image size and the number of images.
- Transmission is not possible when the image memory of the AG-MX70 does not have the required free space. Clear any data that is not required from the image memory (refer to "Clearing Title data") and repeat the transmission operation.
- Images cannot be transmitted while the "Loading..." display appears on the LCD screen immediately after the AG-MX70's power has been turned on or immediately after changes have been made to the image memory settings.
- While transmission is in progress, the LCD display of the AG-MX70 shuts down.

DSK playback of the transmitted data is possible using the following procedure.

- 1) Move the cursor to the data for DSK playback and left click on the data.
The yellow frame cursor moves to the selected data.
- 2) Select "Operation" → "Play" from the menu of the main window.
DSK playback is performed for the data.

<Note>

In order to perform DSK playback for the data, it is necessary to set Key and Fill to Title using the DSK/Fade item on the DSK Fade menu of the AG-MX70. For details, refer to page 46.

Automatic transmission and playback of Title data

The data from the cursor position to the end of the transmission list can be transmitted automatically and DSK playback can be performed automatically.

Select "Operation" → "Automatic title load" from the menu of the main window.

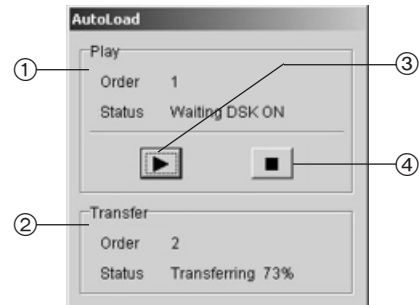

- ① The DSK status is displayed here.
- ② The transmission status is displayed here.
- ③ This executes DSK ON/OFF.
- ④ This stops automatic loading.

<Notes>

- Any data that has not been transmitted will be transmitted automatically. Transmission also will be executed during playback of other data.
- If the data transmission has not been completed by the time the DSK playback stage is reached, standby status will be maintained until it is completed.
- After DSK playback, data without the Protect setting will be cleared from the memory.

Clearing Title data

The data written to the image memory of the AG-MX70 will be cleared only by a clearing operation or when the power supply of the AG-MX70 is switched off. When space is required for transmission of new data, delete any data that is not required. The clearing operation is performed using the following procedure.

- 1) Move the cursor to the data to be cleared and left click on the data.
The yellow frame cursor moves to the selected data.
- 2) Select "Operation" → "Clear the selected title" from the menu of the main window.
The data is cleared.

<Notes>

- When "Operation" → "Clear all title" is selected from the menu of the main window, all transmitted Title data will be cleared.
- Data for which Protect has been set will not be cleared by this operation. Clearing of data for which Protect has been set must be done from the memory status screen. (Refer to page 90.)

Title data operations

Checking the Title data image

The image of the data selected on the image display screen can be displayed in the original size so it can be checked. The image display screen can be displayed using one of the following methods.

- Select “Preview” from the file menu of the main window.
- Select “Preview” from the menu displayed when the mouse is right-clicked on the data.
- Double-click the ICON part in the data display column.



When the selected data has been changed on the main window, the image changes to reflect the changes.

① Order

This is the order of the data to which the displayed image belongs. The order displayed data can be changed either by direct input of numbers or by clicking the arrows.

② Frame

This shows the data frame to which the displayed image corresponds. The displayed frame can be changed either by direct input of numbers or by clicking the arrows.

Reordering the transmission list

The transmission list can be reordered by any one of the following methods.

- Select the reordering method as “Sort by name” or “Sort by comments” from the “Display” menu.
- Double-click the ▲, ▼ buttons in the heading column of NAME/COMMENT of the transmission list. When the display mode is Icon mode, reordering by name will be done with the left button and reordering by comment with the right button. When the display mode is List mode, it is only possible to reorder by name.
- Data can be dragged to a different position by left-clicking on the data and releasing the button after dragging the cursor to a new position. The data will be moved to the position where the button was released.

Saving the transmission list

The created transmission list can be saved to a file.

- 1) Select “Save list as...” from the “File” menu of the main window. The “Save List as...” dialog will be displayed.
- 2) Enter the list name and click on the “OK” button.

Opening a transmission list

A saved transmission list can be opened as follows.

- 1) Select “Open list” from the “File” menu of the main window. The “Open file” dialog will be displayed.
- 2) Select the list to be opened and click on the “OK” button.

Deleting Title data from the transmission list

Data registered in the transmission list can be deleted from the list using the following procedure.

- 1) Move the cursor to the data to be deleted and left-click on the data. The yellow frame cursor moves to the selected data.
- 2) Select “Edit” → “Delete” from the menu of the main window. The data is deleted from the transmission list.

Other operations

Checking the memory status of the AG-MX70

The status of the image memory of the AG-MX70 can be checked on the memory status screen.

Select "Tools" → "Memory status" from the menu of the main window to open the memory status screen.

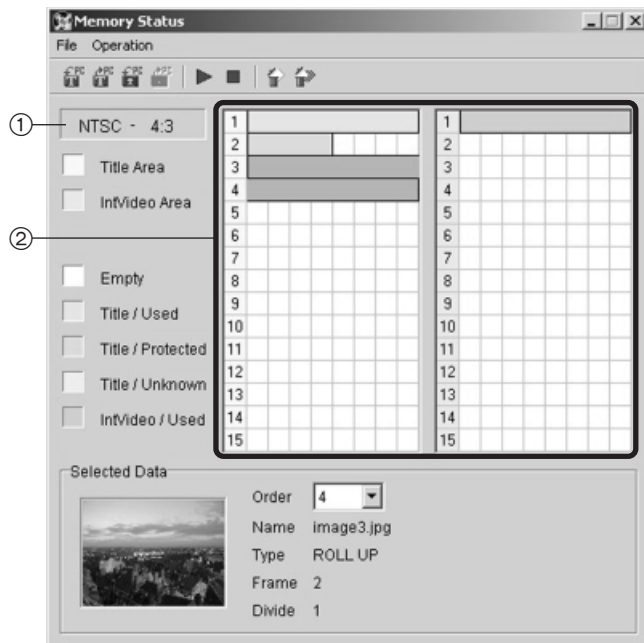

① The system setting status of the AG-MX70 is displayed here.

② This is the memory status display column.

- One line corresponds to one page.
- The column with the line numbers displayed in yellow is the Title data area, and the blue column shows the range of the IntVideo data.
- With Title data, the color differs according to the data type.

Orange: Normal data
 Pink: Data with Protect setting
 Green: Data that cannot be recognized by MX-Navi
 (data written on the AG-MX70 side, data transmitted the previous time when MX-Navi had been started, etc.)

- The data can be selected by left-clicking on the data in the status display column. The selected data becomes the object for clearing and for reading to the PC.

<Notes>

- On this screen, select the data to be cleared and then select "Operation" → "Clear specified area" from the menu. Title data with Protect setting also will be cleared by this operation.
- All Title IntVideo data can be cleared by selecting "Operation" → "All Clear" from the menu of this screen.

Changing the AG-MX-70 memory settings

The settings of the AG-MX70 (switching between NTSC and PAL, switching between 4:3 and 16:9, changing the page distribution between Title data and IntVideo data) can be changed from the PC.

- 1) From the menu of the main window, select "Tools" → "AG-MX70 setup" to open the mixer setting screen.
- 2) Change the memory settings in the Memory column on the mixer setting screen.
 Signal This setting can be switched between NTSC and PAL.
 Aspect This setting can be switched between 4:3 and 16:9.
 Allocation The page distribution between Title data and IntVideo data can be changed here.
- 3) The settings are reflected by clicking the "Set" button.

<Notes>

- When the memory setting has been switched to 4:3 or when the page distribution for Title data and IntVideo data has been changed, all data will be cleared from the image memory.
- When the memory setting has been switched from NTSC to PAL or vice versa, the current transmission list will be closed and a new list will be opened.

Other operations

Transmission and playback of IntVideo data

The operations for transmission and playback of PC images as IntVideo data is described below.

- 1) Select "Tools" → "Memory status" from the menu of the main window and open the memory status screen.
- 2) Select "File" → "Load Intvideo" from the menu of the memory status screen.
The "Open file" dialog will be opened.
- 3) For transmission of a STILL image to the AG-MX70, select the image and click "OK."
To play back MOVIE images, select the image to be played back first from a series of images and click "OK" to display the playback format setting screen. When the playback format and the number of frames to be transmitted have been set and "OK" is clicked, the images will be transmitted to the AG-MX70.
- 4) Left-click the data to be played back in the status display column on the memory management screen.
The data is set to the selected status (status in which the color darkens).
- 5) Select "Operation" → "Preview" from the memory status screen menu.
The data is now played back.

<Notes>

- Crawl and Roll playback formats cannot be used for IntVideo data.
- Images cannot be transmitted immediately after the AG-MX70's power has been turned on or immediately after changes have been made to the image memory settings.
- While transmission is in progress, the LCD display of the AG-MX70 shuts down.
- Before playback, INT/EXT must be selected by the AG-MX70.

Clearing IntVideo data

The operation for deletion of transmitted IntVideo data from the image memory of the AG-MX70 is described below.

- 1) Select "Tools" → "Memory status" from the menu of the main window to open the memory status screen.
- 2) Left-click the data to be deleted in the status display column of the memory status screen.
The data changes to selected status (the color becomes darker).
- 3) Select "Operation" → "Clear specified area" from the menu of the memory status screen.
The data is cleared.

Saving data

Title data or IntVideo data can be read to the PC from the image memory of the AG-MX70 and can be stored as still images. Use the following procedure.

- 1) Select "Tools" → "Memory status" from the menu of the main window to open the memory status screen.
- 2) Left-click on the data to be read into the PC in the status display column of the memory status screen.
The data changes to selected status (the color will become darker).

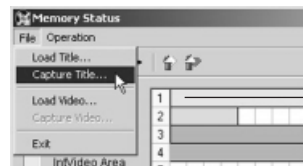

Select the data by left-clicking in the status display column.

- 3) Select "File" → "Capture Title" from the menu of the memory status screen to read in Title data.
Select "File" → "Save IntVideo" from the menu of the memory status screen to read in IntVideo data.
- 4) Enter the image format and the file name and click "OK."
When the data to be read in is composed of multiple images, a number will be automatically appended at the end of the file name.

<Notes>

- For saving in of Title data, the image format is fixed to TARGA (32 bit/pixel, with α channel).
- For saving in of IntVideo data, the image format can be selected as TARGA, JPEG, or BMP (all 24 bits/pixel, no α channel).
- Capture the IntVideo data after the IntVideo playback has been stopped at the AG-MX70 main unit.
- Images cannot be transmitted while the "Loading..." display appears on the LCD screen immediately after the AG-MX70's power has been turned on or immediately after changes have been made to the image memory settings.
- While transmission is in progress, the LCD display of the AG-MX70 shuts down.

Recalling events

AG-MX70 events can be recalled from the PC.

- 1) Select "AG-MX70 setup" from the "Tools" menu of the main window.
- 2) Input the number of the event to be recalled into the "Event Recall" column on the mixer setting window, and click the "Recall" button. The event is now recalled.

Other operations

Setting the initial properties

The initial values for the properties to be used with new data can be set on the “Initial set of Property Data” setting screen.

- 1) Select “Initial set of Property Data” from the Tools menu of the main window.
The “Initial set of Property Data” setting screen is displayed.
- 2) Set the individual items and click the “OK” button to change the settings.
All settings can be returned to the initial value by pressing the “Cancel” button.

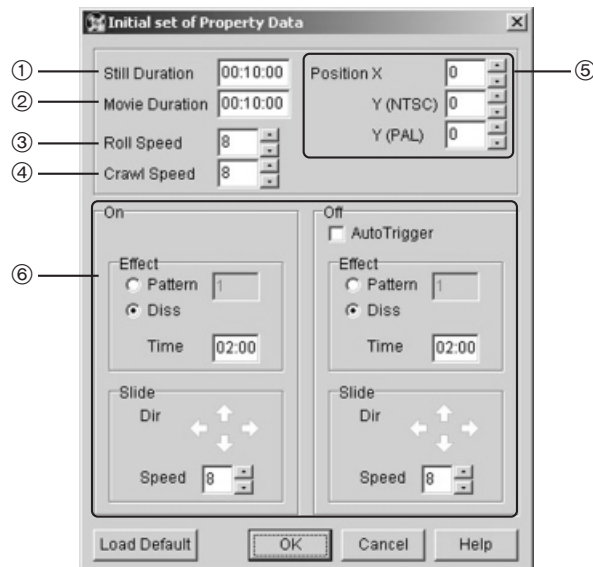

① Still Duration

The duration is set for when Still is used as the data playback format.

② Movie Duration

The duration is set for when Movie Repeat is used as the data playback format.

③ Roll Speed

The speed is set for when Roll is used as the data playback format.

④ Crawl Speed

The speed is set for when Crawl is used as the data playback format

⑤ Position

The display position is set here. The vertical position is different for NTSC and PAL.

X: The horizontal position can be set from 0 to 719.

Y (NTSC): For NTSC, the vertical position can be set from 0 to 480. (Only even numbers.)

Y (PAL): For PAL, the vertical position can be set from 0 to 576. (Only even numbers.)

⑥ ON, OFF settings

The operation at the time of DSK ON and DSK OFF is set. For further details on each item, refer to “Setting the data playback properties” (page 86).

● AutoTrigger (OFF only)

When this is checked, the OFF Trigger is set to Auto.

● Effect

The pattern to be used for special effects and the special effects time are set here.

● Slide

The slide direction and the speed are set here.

Other operations

Setting the operating environment

The operation settings for this application can be set on the operation environment screen.

- 1) Select “Operating environment” from the Tools menu of the main window.
The Environment screen will be displayed.
- 2) Set the individual items and click the “OK” button to change the settings.

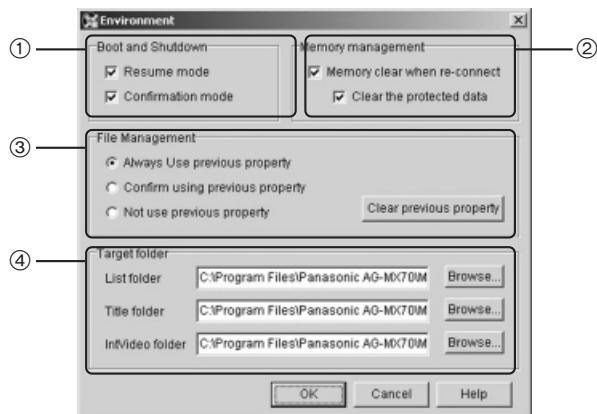

① Boot and shutdown

The operation at the time of boot and shutdown of this application is set.

- **Resume mode**

When this is checked, the transmission list which was open when the application was shut down the last time will be opened at startup and the status effective at the time the application was shut down the last time will be re-established.

When this is not checked, a new transmission list will be opened at startup.

- **Confirmation mode**

When this is checked, the confirmation screen will be displayed when the application is shut down.

② Memory management

The operation when the AG-MX70 is connected to the PC is set.

When “Memory clear when re-connect” is checked, all Title and IntVideo data will be cleared when the AG-MX70 is connected.

Check “Clear the protected data” when data with the Protect setting is also to be cleared.

③ File Management

When adding an image that has once been used as title data to the transmission list, select whether the previous property settings are to be used.

The previous properties can be cleared using the “Clear previous property” button.

- **Always Use previous property**

When the previous properties are still available, the previous property settings are used again and again.

- **Confirm using previous property**

When the previous properties are still available, a confirmation screen for using or canceling the previous properties appears.

If the previous properties are not going to be used, alternative properties are handled as new data.

- **Not use the previous property**

The data will always be handled as new data.

④ Target folder

The folder to be opened first when opening or saving data is set. Enter the folder directly or click the “Browse” button and select from the displayed folder selection screen.

- **List folder**

The folder to be opened first for opening or saving a transmission list is set.

The default folder is the ListData folder created under the folder in which this application has been installed.

- **Title folder**

The folder to be opened first when opening or saving Title data is set.

The default folder is the TitleData folder created under the folder in which this application has been installed.

- **IntVideo folder**

The folder to be opened first when opening or saving IntVideo data is set.

The default folder is the IntVideoData folder created under the folder in which this application has been installed.

List of short-cut keys

Move the cursor to the top	Home	Select all the data	Ctrl + A
Move the cursor back by 10	Left arrow	Delete the selected data	Delete
Move the cursor back	Up arrow	Cut out the selected data	Ctrl + X
Move the cursor ahead	Down arrow	Copy the selected data	Ctrl + C
Move the cursor ahead by 10	Right arrow	Paste the data	Ctrl + V
Move the cursor to the bottom	End	Clear the selected data	Ctrl + R
Jump to the data in DSK	0	Clear all data	Ctrl + T
Jump to the data of the corresponding Mark setting	1 to 9	Undo	Ctrl + Z
Open the properties of the selected data	Enter	Redo	Ctrl + Y
Transfer the selected data	L		
Play back the selected data	Space		
Stop the data being played back	S		
Automatically play back the data	Shift + Space		

Before calling for service

Troubleshooting

Contact your dealer if the problem persists even when you have checked the following items.

AG-MX70-related problems

Problem	What to check
● The power can not be switched on.	● Is the plug of the power cable inserted properly in the outlet? ● Has the fan stopped operating?
● There is no picture.	● Is the power of the VTR or other connected equipment switched on? ● Are the cables connected correctly? ● Has fade been applied? ● Has the source been input correctly?
● There is no color.	● Is the monochrome selection switch set to ON? ● Is only "Y" provided as input instead of the composite signal? ● Has the source been input correctly?
● There is no sound.	● Has audio fade-out been applied? ● Has the source been input correctly?
● The image does not change even when the transition lever is moved during mix/wipe mode.	● Has the same signal been selected for A-side and B-side?

MX-Navi-related problems

Problem	What to check
● A menu for title load or playback etc. is grayed out and operation is not possible.	The AG-MX70 has not been recognized by the PC. Check the following items. ● Is the power of the AG-MX70 switched on? ● Are the AG-MX70 and the PC connected correctly via a USB cable? ● Is the length of the USB cable less than 3 m? When operation is still not possible even though the above items are fulfilled, it is possible that the USB driver has not been installed successfully. Execute DrvUninstaller.exe in the DrvUninstaller folder of the setup CD-ROM to delete the USB driver (at this time the message "Cannot delete some files" may be displayed, but this does not present a problem), and then install the USB driver again.
● Image transmission or reading has been performed, but the processing stopped and the message "AG-MX70 is not ready to transfer, Please check Power and connection, and try again.." is displayed.	Images cannot be transmitted or captured while the "Loading..." display appears on the LCD screen immediately after the AG-MX70's power has been turned on or immediately after changes have been made to the image memory settings. Wait until the "Loading..." display is cleared, and then try again.
● The image does not change to DSK even when DSK playback operation is performed.	Check that the DSK/Fade items Key and Fill in the DSK/Fade menu of the AG-MX70 are set to Title.

Before calling for service

MX-Navi-related problems

Problem	What to check
• Patterns set for DSK ON and DSK OFF for Title data are changed.	When the set pattern can not be used for DSK, the pattern is changed automatically to a different pattern.
• The Title data has been cleared, but the data has not been deleted from the image memory.	When Protect has been set for the data, it will not be cleared even when clearing is performed from the menu of the main window. To clear data with the Protect setting, perform the clearing operation from the memory status window.
• The button display of main window is abnormal.	In a Windows 98 environment with certain video cards, the button display may become abnormal. Even if this problem should occur, operation of this software will not be influenced. It may be possible to eliminate the problem using one of the following methods. <ul style="list-style-type: none">• Update the video card driver to the newest version.• Click "Advanced" on the "Settings" page of "My Computer" → "Control Panel" → "Display," open the "Performance" page on the displayed Properties screen, and set the hardware accelerator setting to "Basic" or "None."

Specifications

[GENERAL]

Power Source	: 120 V AC, 50/60 Hz
Power Consumption	: 52 W (with no optional accessories installed), 70 W (with all optional accessories installed)

 indicates safety information.

Operating temperature:	41 °F to 104 °F (+ 5 °C to + 40 °C)
Operating humidity:	Less than 80% (relative humidity)
Dimensions (W × H × D):	16-3/4 × 7-3/4 × 15-3/4 inch (424 × 197 × 400 mm)
Weight:	8.2 kg (with no optional accessories installed) 8.7 kg (with all optional accessories installed)

[VIDEO]

Video format:	525 (NTSC)/625 (PAL) switchable
Quantization:	Main input: 9 bit External input (EXT): 8 bit
Internal processing:	4: 2: 2: 4 8 bits (ON/OFF switching for Dynamic Rounding processing enabled)
S/N ratio:	Key: 13.5 MHz Y: 13.5 MHz Pb/Pr: 6.75 MHz Component signal, Y: Less than -54 dB Pb/Pr: Less than -52 dB Composite signal, Y/C: Less than -50 dB
Band width:	Main input Y: 0.5 MHz to 4.5 MHz (±1.0 dB) Pb/Pr: 0.2 MHz to 2.0 MHz (+0.5 dB to -3.0 dB) External input (EXT) Y: 0.5 MHz to 4.5 MHz (±1.0 dB) Pb/Pr: 0.2 MHz to 2.0 MHz (±1.0 dB)
K factor:	Less than 1%
DG/DP:	Less than 4%/2°

[AUDIO]

Sampling frequency:	48 kHz
Quantization:	Analog Input: 20bit, Digital Input (option): 24bit
Frequency response:	20 Hz to 20 kHz (-1.0 dB to +1.0 dB)
Dynamic range:	More than 85dB (analog In/out)
THD:	Less than 0.05% (1 kHz)
Cross talk:	Less than -70 dB (1 kHz, between any two channels)
Headroom:	20 dB/18 dB switchable

Specifications

[VIDEO INPUT/OUTPUT]

Analog component input/output connectors:	BNC × 4 (sources 1/2/3/4) Y: 1.0 Vp-p, 75 Ω Pb/Pr (525): 0.525/0.757 Vp-p switchable, 75 Ω Pb/Pr (625): 0.7 Vp-p, 75 Ω
Analog composite input/output connectors:	BNC × 8 (sources 1 to 8), 1.0 Vp-p, 75 Ω
YC input/output connectors:	Mini-DIN4 × 4 (sources 1/2/3/4) Y: 1.0 VP-P, 75 Ω C: 0.286 VP-P, 75 Ω (525)/0.3 VP-P, 75 Ω (625)
EXT (external input) connector:	BNC × 1 (Y/Pb/Pr), Analog component signals Y: 1.0 Vp-p, 75 Ω Pb/Pr (525): 0.757 Vp-p, 75 Ω Pb/Pr (625): 0.7 Vp-p, 75 Ω Key: BNC × 1, 1.0 Vp-p, 75 Ω Analog composite signals (genlock possible)
G/L input connector:	BNC × 1 (with loop-through configuration), 1.0 Vp-p, 75 Ω Composite signal (genlock selection enabled from G/L, EXT-Key)
Preview output connector:	BNC × 1, 1.0 Vp-p, 75 Ω
Advanced reference input connector:	BNC × 1 (with loop-through configuration), 75 Ω, composite signals Sync: 0.286 Vp-p (525)/0.3 VP-P (625) Burst: 0.286 Vp-p (525)/0.3 Vp-p (625)

[AUDIO INPUT/OUTPUT]

Analog audio (L/R) connectors:	XLR × 4 sets, +4/0/-3 dBu switchable, 10 kΩ, balanced
AUX input (L/R) connectors:	RCA × 2 sets, -10 dBV, 10 kΩ, unbalanced (AUX2 switchable with MIC)
Audio output (L/R) connectors:	Program 1: XLR × 1 set, +4/0/-3 dBu switchable, 47 Ω, balanced Program 2: RCA × 1 set, 10 dBv, 47 Ω, unbalanced
Mic input jack:	M6 × 1, -60 dBv, 2 kΩ, unbalanced (switchable with AUX2)
Headphone output jack:	M6 × 1, 8 kΩ, unbalanced

[OTHER]

Editor:	D-sub 9-pin, RS-422A/232C switchable RS-422A protocol; GVG/Sony switchable
Connectable Editor:	Panasonic: AG-A850, AJ-A900, SONY: BVE-2000, BVE-910, PVE-500
Tally Out:	D-sub 9-pin, open-collector × 8 ch Collector current: Less than 50 mA, Maximum voltage: 35 V DC
GPI:	BNC × 1, Make-contact
USB:	Type-B connector × 1, USB Ver.1.1 (cable length: max. 3 m)

Specifications

[SDI] (Option)

Video input connectors:	BNC × 4 (inputs 1/2/3/4), SMPTE 259M-C/EBU Tech.3267-E
Video output connectors:	BNC × 1, SMPTE 259M-C/EBU Tech.3267-E
Audio input connectors:	Embedded audio (channels 1/2, 3/4, 5/6, 7/8 switchable)
Audio output connectors:	Embedded audio (channels 1/2)

[ACCESSORIES]

Power cable	1
Operating Instructions.....	1
MX-Navi installation CD.....	1
Warranty card	1

Installation of the AG-YA70

The AG-YA70 is an interface board that enables the AG-MX70 to be connected to a serial digital interface (SDI). Follow the procedure below to install it.

<Note>

Always consult your dealer or authorized service center regarding installation of the AG-YA70 in the AG-MX70.

- 1) Turn off the power of the AG-MX70, remove the ten screws from the bottom panel, and detach the top part including the LCD. Refrain from using any force to pull the top part away from the bottom part since the two parts are still connected by cables. (Refer to the figure on page 101.)
- 2) Remove the 20 screws, and remove the shield plate.
- 3) Remove the six screws from the rear panel of the AG-MX70, and remove the blank panel.

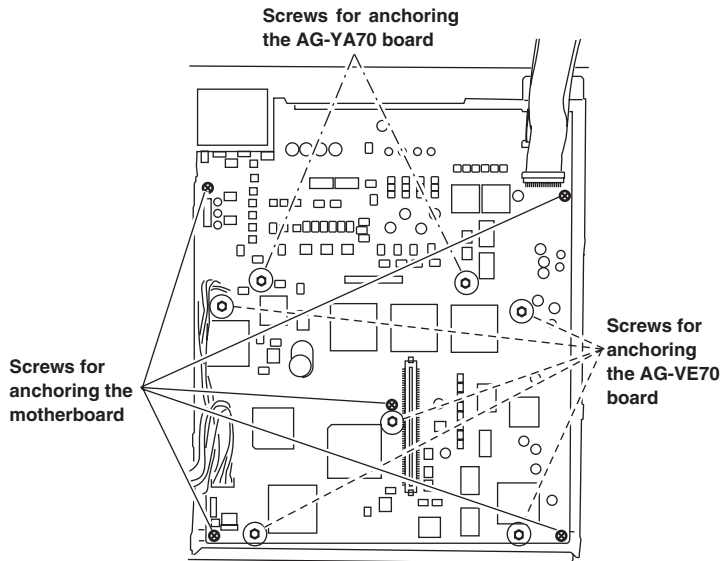
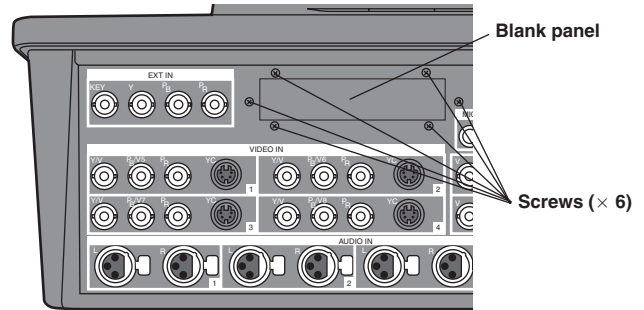

- 6) Refer to the figure on the right, and insert the AG-YA70 board.
- 7) Secure the two screws which were removed in step 4).
- 8) Secure the six screws which were removed in step 3).
- 9) Tighten up the five screws which were loosened in step 5).

- 4) Remove the two screws anchoring the AG-YA70 on the motherboard.
- 5) Slightly loosen the five screws anchoring the motherboard.

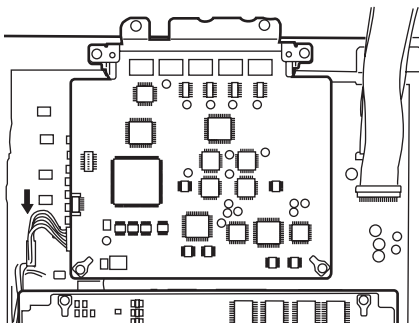
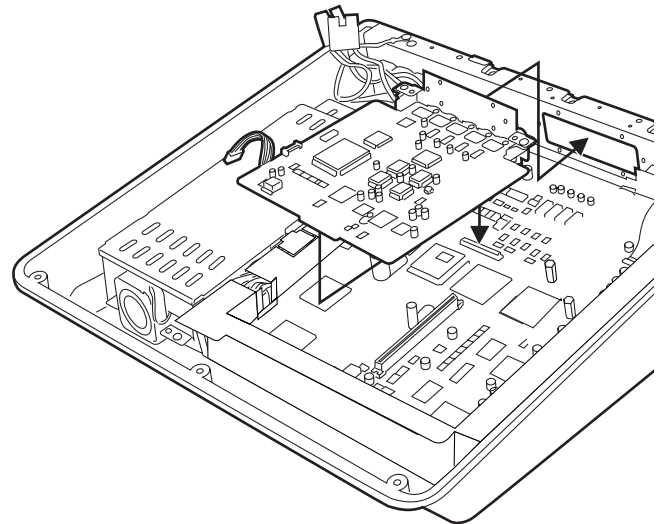

- 10) Refer to the figure on the left, and plug the cable attached to the AG-YA70 into the AG-MX70.
- 11) Secure the screws which were removed in steps 2) and 1).

Installation of the AG-VE70

The AG-VE70 is a 3D effect board that enables the 3D patterns, etc. of the AG-MX70 to be used. Follow the procedure below to install it.

<Note>

Always consult your dealer or authorized service center regarding installation of the AG-VE70 in the AG-MX70.

- 1) Turn off the power of the AG-MX70, remove the ten screws from the bottom panel, and detach the top part including the LCD. Refrain from using any force to pull the top part away from the bottom part since the two parts are still connected by cables.
- 2) Remove the 20 screws, and remove the shield plate.
- 3) Refer to the figure on the left, and insert the AG-VE70.
- 4) Remove the five screws provided on the five hexagonal posts in the center of the motherboard. (Refer to the figure on page 100.)
- 5) In the same way, plug the cable attached to the AG-VE70 into the AG-MX70. Route the wires carefully ensuring that they do not make contact with the transition lever unit.
- 6) Secure the five screws which were removed in step 4).
- 7) Secure the screws which were removed in steps 2) and 1).

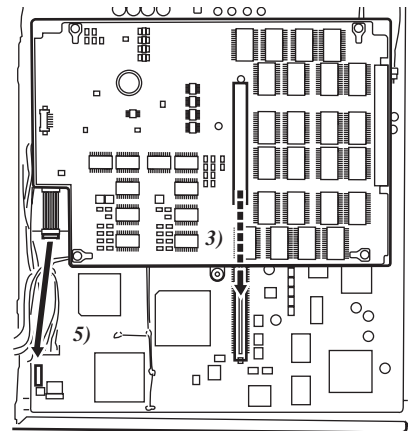
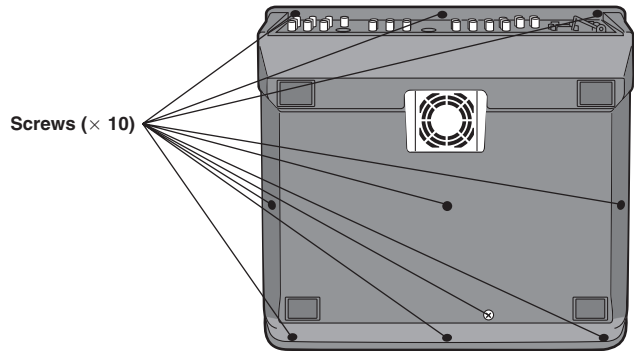

Specifications

[AG-YA70]

(SDI interface board: optional accessory)

Power Source: DC 5 V, 3.3 V
Power Consumption: 6.3 W

 indicates safety information.

Operating temperature: 41 °F to 104 °F
(+ 5 °C to + 40 °C)

Operating humidity: Less than 80%

Standard: SMPTE-259M-C standard
complied with

[AG-VE70]

(3D effect board: optional accessory)

Power Source: DC 5 V, 3.3 V
Power Consumption: 6.1 W

 indicates safety information.

Operating temperature: 41 °F to 104 °F
(+ 5 °C to + 40 °C)

Operating humidity: Less than 80%

Panasonic

PANASONIC BROADCAST & TELEVISION SYSTEMS COMPANY
UNIT COMPANY OF MATSUSHITA ELECTRIC CORPORATION OF AMERICA

Executive Office:

One Panasonic Way 4E-7, Secaucus, NJ 07094 (201) 348-7000

EASTERN ZONE:

One Panasonic Way 4E-7, Secaucus, NJ 07094 (201) 348-7621

Southeast Region:

1225 Northbrook Parkway, Ste 1-160, Suwanee, GA 30024 (770) 338-6835

Central Region:

1707 N Randall Road E1-C-1, Elgin, IL 60123 (847) 468-5200

WESTERN ZONE:

3330 Cahuenga Blvd W., Los Angeles, CA 90068 (323) 436-3500

Government Marketing Department:

52 West Gude Drive, Rockville, MD 20850 (301) 738-3840

Broadcast PARTS INFORMATION & ORDERING:

9:00 a.m. – 5:00 p.m. (EST) (800) 334-4881/24 Hr. Fax (800) 334-4880

Emergency after hour parts orders (800) 334-4881

TECHNICAL SUPPORT:

Emergency 24 Hour Service (800) 222-0741

Panasonic Canada Inc.

5770 Ambler Drive, Mississauga, Ontario L4W 2T3 (905) 624-5010

Panasonic de Mexico S.A. de C.V.

Av angel Urraza Num. 1209 Col. de Valle 03100 Mexico, D.F. (52) 1 951 2127

Panasonic Sales Company

Division of Matsushita Electric of Puerto Rico Inc.

San Gabriel Industrial Park, 65th Infantry Ave., Km. 9.5, Carolina, Puerto Rico 00630 (787) 750-4300



Free Manuals Download Website

<http://myh66.com>

<http://usermanuals.us>

<http://www.somanuals.com>

<http://www.4manuals.cc>

<http://www.manual-lib.com>

<http://www.404manual.com>

<http://www.luxmanual.com>

<http://aubethermostatmanual.com>

Golf course search by state

<http://golfingnear.com>

Email search by domain

<http://emailbydomain.com>

Auto manuals search

<http://auto.somanuals.com>

TV manuals search

<http://tv.somanuals.com>