

Operating Instructions

Interface Adapter
Model **AK-HTF900P**

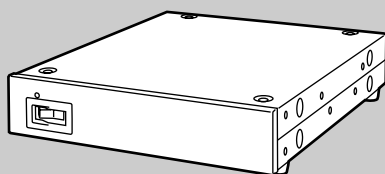

Panasonic[®]

Before attempting to connect, operate or adjust this product,
please read these instructions completely and save this manual for future use.

Download from [Www.Somanuals.com](http://www.Somanuals.com). All Manuals Search And Download.

For Your Safety

	CAUTION RISK OF ELECTRIC SHOCK DO NOT OPEN	
CAUTION: TO REDUCE THE RISK OF ELECTRIC SHOCK, DO NOT REMOVE COVER (OR BACK). NO USER SERVICEABLE PARTS INSIDE. REFER TO SERVICING TO QUALIFIED SERVICE PERSONNEL.		

The lightning flash with arrowhead symbol, within an equilateral triangle, is intended to alert the user to the presence of uninsulated “dangerous voltage” within the product’s enclosure that may be of sufficient magnitude to constitute a risk of electric shock to persons.



The exclamation point within an equilateral triangle is intended to alert the user to the presence of important operating and maintenance (servicing) instructions in the literature accompanying the appliance.



FCC Note:

This device complies with Part 15 of the FCC Rules. To assure continued compliance follow the attached installation instructions and do not make any unauthorized modifications.

This equipment has been tested and found to comply with the limits for a Class A digital device, pursuant to Part 15 of the FCC Rules. These limits are designed to provide reasonable protection against harmful interference when the equipment is operated in a commercial environment. This equipment generates, uses, and can radiate radio frequency energy and, if not installed and used in accordance with the instruction manual, may cause harmful interference to radio communications. Operation of this equipment in a residential area is likely to cause harmful interference in which case the user will be required to correct the interference at his own expense.

WARNING:

TO REDUCE THE RISK OF FIRE OR SHOCK HAZARD, DO NOT EXPOSE THIS EQUIPMENT TO RAIN OR MOISTURE.

CAUTION:

TO REDUCE THE RISK OF FIRE OR SHOCK HAZARD AND ANNOYING INTERFERENCE, USE THE RECOMMENDED ACCESSORIES ONLY.

..... For CANADA
: This class A digital apparatus complies :
: with Canadian ICES-003. :
: Cet appareil numérique de la classe A :
: est conforme à la norme NMB-003 du :
: Canada. :
.....

12 Volt Class II Power Supply Only.
(For Example: AW-PS505P)

 is the safety information.

Contents

For Your Safety	2
Outline	3
Precautions for Use	3
Controls and their Functions	
■ Front panel	4
■ Rear panel	5
How To Connect	7
Appearance and Dimensions	8
Specifications	9

Outline

- This unit is able to separate multiple data (camera control data and swivel stand control data) transmitted from the camera controller (AK-HRP900P), and to output the control information to the multi-purpose camera (AK-HC900P) and the swivel stand (AW-PH300A, etc.).
- The distance between this unit and the camera is 33 ft (10m) max.

Precautions for Use

- We recommend that the AC adapter AW-PS505P is used for power supply.
- Handle the unit with care.
If dropped or given a strong shock, it may cause a trouble or accident.
- Use the unit in a temperature range of 32°F to 104°F (0°C to + 40°C).
If used at a temperature below 32°F or higher than 104°F, it may cause bad influences to the component parts.
- Turn off the power before connecting or disconnecting the cable.
When connecting or disconnecting the cable, be sure to turn off the power switch of the unit beforehand.
- Avoid using the unit outdoors.
- Install the unit 3.3 ft (1 m) away from the monitor.
- Maintenance
Pull out the power cord plug and clean the unit with dry cloth. If it is hard to clean, moisten the cloth with a diluted neutral detergent solution and squeeze it well and lightly wipe the unit.

Precautions

- Do not use volatile solvents such as benzene or thinner.
- When using a chemical mop, carefully read the instructions.

Controls and their Functions

■ Front panel

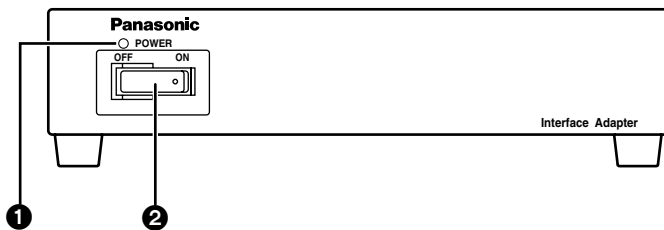

❶ Power indication LED [POWER]

When the power control switch ❷ is ON, it is lighted green. With the power control switch ❷ set to OFF, it goes out.

❷ Power control switch [POWER ON/OFF]

When this switch is set to ON, this unit and the camera connected to it are turned on. With the switch set to OFF, both of the unit and the camera are turned off.

Controls and their Functions

Rear panel

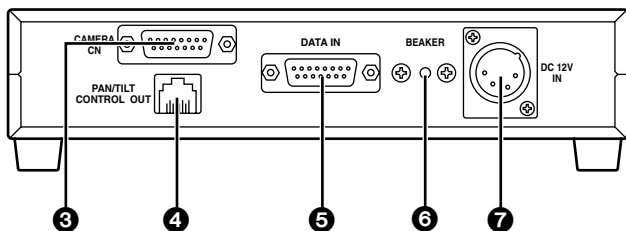

3 Camera connector [CAMERA I/F]

Connected to the camera (AK-HC900P) with the attached multi-cable.

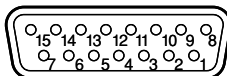

Pin No	Signal	Pin No	Signal
1	NC	8	NC
2	NC	9	NC
3	NC	10	NC
4	NC	11	NC
5	DC 12V	12	DC GND
6	Frame GND	13	TXD (C)
7	TXD (H)	14	RXD (H)
		15	RXD (C)

TXD: Data from camera to remote controller.

RXD: Data from remote controller to camera.

4 Swivel stand control signal output connector [PAN/TILT CONTROL OUT]

Connected to the swivel stand.

5 Control data input connector [DATA IN]

Used to input the data multiplexed by the camera controller (AK-HRP900P).

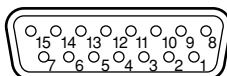

Pin No	Signal	Pin No	Signal
1	NC	8	NC
2	NC	9	NC
3	NC	10	NC
4	NC	11	NC
5	NC	12	NC
6	Frame GND	13	TXD (C)
7	TXD (H)	14	RXD (H)
		15	RXD (C)

Controls and their Functions

⑥ Breaker [BREAKER]

DC power breaker. The breaker operates to cut off the power in case of over-current.

⑦ DC12V input connector [DC 12V IN] (XLR4-pin)

Connects the AC adapter. We recommend that the AW-PS505P (option) is used.

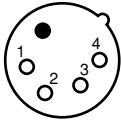

Pin No	Signal
1	GND
2, 3	—
4	12V

How To Connect

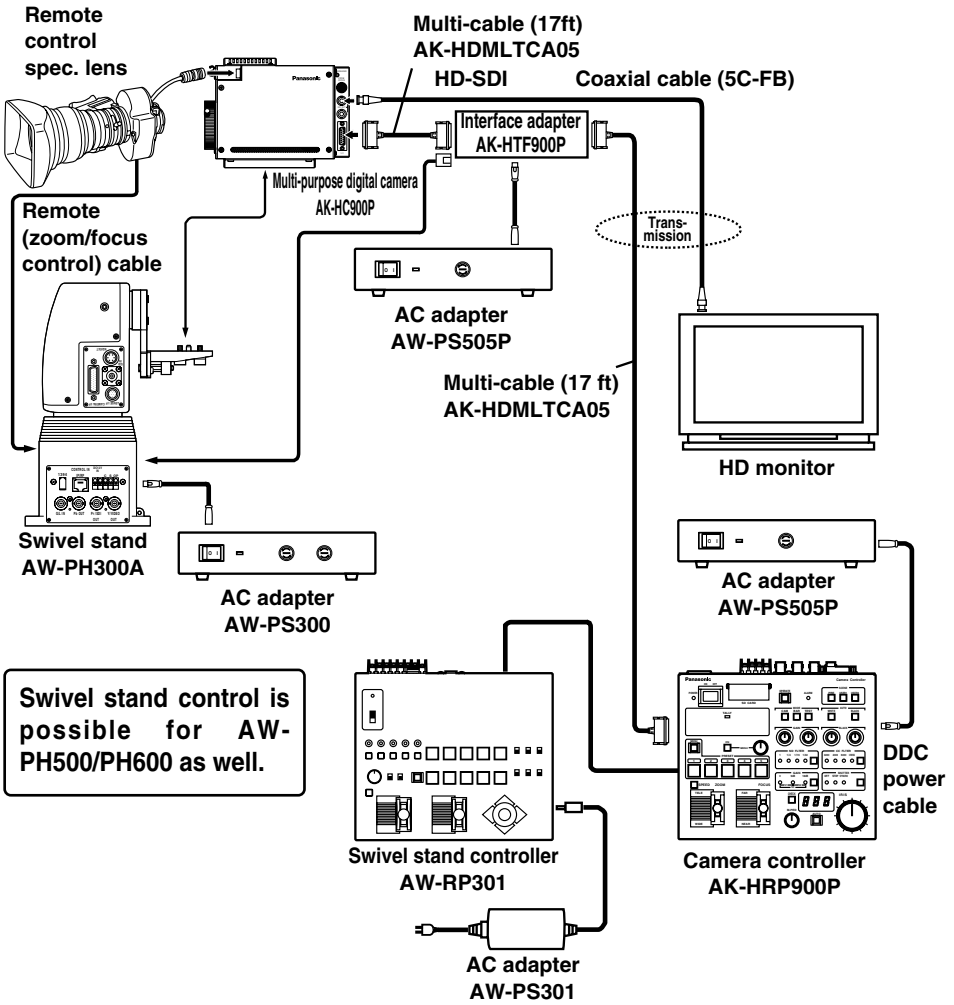

- Make the connections with all the units turned off.
- We recommend that the AW-PS505P (option) is used as AC adapter
- Use a swivel stand, AW-PH300A, AW-PH500, AW-PH600, and an adapter suited for the swivel stand.

Appearance and Dimensions

(): mm

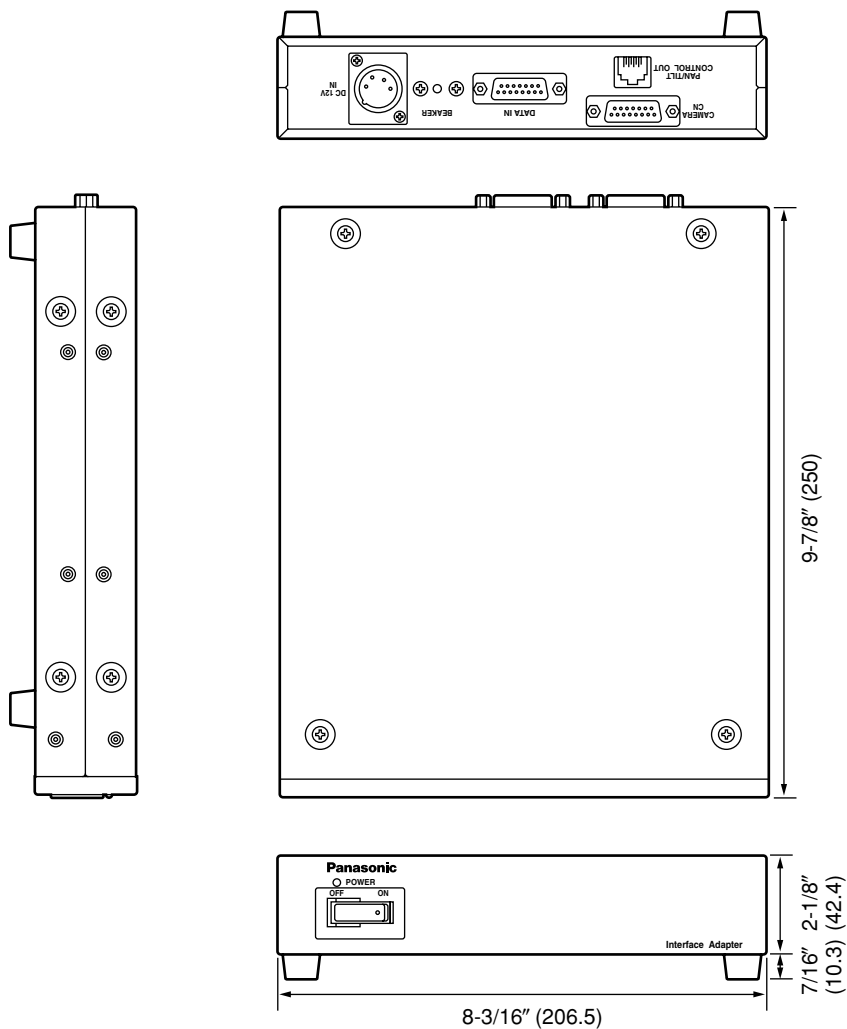

Specifications

Power supply:	DC +12V (XLR 4-pin connector)
Power consumption:	25 W (with camera connected)

 is the safety information.

Swivel control output:	Control signal (RJ-45 8P modular jack)
Switch function:	Power control
Cable max. extension distance:	33 ft (10m)
Operating temperature:	32°F to 104°F (0°C to +40°C)
Dimensions:	8-3/16(W)k2-1/8(H)×9-7/8(D) inch (206.5×52.7×250 mm)
Weight:	Approx. 4.18 lbs (1.9 kg)
Finish:	AV ivory coating (Munsell 7.9Y 6.8/0.8 approx. color)

Weight and dimensions shown are approximate.
Specifications are subject to change without notice.

Memo

A series of horizontal dashed lines for writing a memo.

Memo

A series of horizontal dashed lines for writing.

Panasonic

PANASONIC BROADCAST & TELEVISION SYSTEMS COMPANY

UNIT COMPANY OF MATSUSHITA ELECTRIC CORPORATION OF AMERICA

Executive Office:

One Panasonic Way 4E-7, Secaucus, NJ 07094 (201)348-7000

EASTERN ZONE

One Panasonic Way 4E-7, Secaucus, NJ 07094 (201)348-7621

Southeast Region:

1225 Northbrook Parkway, Ste 1-160, Suwanee, GA 30024 (770) 338-6835

Central Region:

1707 N Randall Road E1-C-1, Elgin, IL 60123 (847) 468-5200

WESTERN ZONE:

3330 Cahuenga Blvd W., Los Angeles, CA 90068 (323) 436-3500

Government Marketing Department:

52 West Gude Drive, Rockville, MD 20850 (301) 738-3840

Broadcast PARTS INFORMATION & ORDERING:

9:00 a.m. – 5:00 p.m. (EST) (800) 334-4881/24 Hr. Fax (800) 334-4880

Emergency after hour parts orders (800) 334-4881

TECHNICAL SUPPORT:

Emergency 24 Hour Service (800) 222-0741

Panasonic Canada Inc.

5770 Ambler Drive, Mississauga, Ontario L4W 2T3 (905) 624-5010

Panasonic de Mexico S.A. de C.V.

Av angel Urraza Num. 1209 Col. de Valle 03100 Mexico, D.F. (52) 1 951 2127

Panasonic Sales Company

Division of Matsushita Electric of Puerto Rico Inc.

San Gabriel Industrial Park, 65th Infantry Ave., Km. 9.5, Carolina, Puerto Rico 00630 (787) 750-4300

Printed in Japan

VQT0A80

F0902H 

Free Manuals Download Website

<http://myh66.com>

<http://usermanuals.us>

<http://www.somanuals.com>

<http://www.4manuals.cc>

<http://www.manual-lib.com>

<http://www.404manual.com>

<http://www.luxmanual.com>

<http://aubethermostatmanual.com>

Golf course search by state

<http://golfingnear.com>

Email search by domain

<http://emailbydomain.com>

Auto manuals search

<http://auto.somanuals.com>

TV manuals search

<http://tv.somanuals.com>