



Panasonic®

Handheld Computer

OPERATING INSTRUCTIONS

Model No. **CF-P1 Series**

TOUGHBOOK

Contents

Getting Started

Read Me First	3
Precautions	6
What's in the Box?	9
Names and Functions of Parts	10
First-time Operation	13

Operation

Starting Up/Shutting Down	16
LCD (Touchscreen)	20
Backlight Setting	22
Entering Information	23
Program Buttons	28
Battery Power	29
SD Memory Card/MultiMedia Card	31
Panasonic Backup	32
Pocket Internet Explorer	35
Connecting to Your Computer	36
Customizing the Computer	40

Troubleshooting

Dealing with Problems	43
-----------------------------	----

Appendix

For Effective Use	47
Specifications	48
LIMITED USE LICENSE AGREEMENT	50

Please read this instructions manual carefully before using this product and save this manual for future use.

Customer's Record

Model No.* _____	Dealer's Name _____
Serial No. _____ or _____	_____
Code No. _____	Dealer's Address _____
Date of Purchase _____	_____

* For the Model No., insert the 12 digit number (for example, CF-P1P3CDZ6M) located on the back of the computer.

Introduction

Thank you for purchasing the Panasonic Handheld Computer. Read the operating instructions thoroughly for proper operation of your new computer.

Illustrations and Terminology in this Manual

NOTE:

NOTE provides a useful fact or helpful information.

CAUTION:

CAUTION indicates a condition that may result in minor or moderate injury.

 - [Programs]:

This illustration means to tap  at the top of the screen, then to tap [Programs].

< For the CF-P1P3 series >

:

This illustration means to press the [A] key.

Mode key + NUM key:

This illustration means to press and hold the [0] key (Mode key), then press the [NUM▲] key.

< For the CF-P1P1 series >

:

This illustration means to press the [1] key.

:

Where to go for referred information.

● Some of the illustrations in this manual may differ slightly in shape from the actual items in order to make the explanation easier to understand.

This operating instructions describes the models below.

Note however that the illustrations mainly show the CF-P1P3 series.



CF-P1P3 series
(QWERTY key
type keyboard)



CF-P1P1 series
(numeric keypad
type keyboard)

Federal Communications Commission Radio Frequency Interference Statement

Note: This equipment has been tested and found to comply with the limits for a Class B digital device, pursuant to Part 15 of the FCC Rules. These limits are designed to provide reasonable protection against harmful interference in a residential installation. This equipment generates, uses and can radiate radio frequency energy and, if not installed and used in accordance with the instructions, may cause harmful interference to radio communications. However, there is no guarantee that interference will not occur in a particular installation. If this equipment does cause harmful interference to radio or television reception, which can be determined by turning the equipment off and on, the user is encouraged to try to correct the interference by one or more of the following measures:

- Reorient or relocate the receiving antenna.
- Increase the separation between the equipment and receiver.
- Connect the equipment into an outlet on a circuit different from that to which the receiver is connected.
- Consult the Panasonic Service Center or an experienced radio/TV technician for help.

Warning

To assure continued compliance, use only shielded interface cables when connecting to a computer or peripheral. Also, any changes or modifications not expressly approved by the party responsible for compliance could void the user's authority to operate this equipment.

This device complies with Part 15 of the FCC Rules. Operation is subject to the following two conditions:

- (1) This device may not cause harmful interference, and
- (2) This device must accept any interference received, including interference that may cause undesired operation.

Responsible Party: Matsushita Electric Corporation of America
One Panasonic Way
Secaucus, NJ 07094
Tel No: 1-800-LAPTOP-5 (1-800-527-8675)

Notice for the products using LCD

This product uses one or more fluorescent lamps containing a small amount of mercury. It also contains lead in some components. Disposal of these materials may be regulated in your community due to environmental considerations. For disposal or recycling information please contact your local authorities, or the Electronics Industries Alliance: <<http://www.eiae.org/>>

Warning

This apparatus must be earthed for your safety.

To ensure safe operation the three-pin plug must be inserted only into a standard three-pin power point which is effectively earthed through the normal household wiring.

Extension cords used with the equipment must be three-core and be correctly wired to provide connection to earth. Wrongly wired extension cords are a major cause of fatalities.

The fact that the equipment operates satisfactorily does not imply that the power point is earthed and that the installation is completely safe.

For your safety, if you have any doubt about the effective earthing of the power point, consult a qualified electrician.

FOR YOUR SAFETY PLEASE READ THE FOLLOWING TEXT CAREFULLY

This appliance is supplied with a moulded three pin mains plug for your safety and convenience.

A 3 amp fuse is fitted in this plug.

Should the fuse need to be replaced please ensure that the replacement fuse has a rating of 3 amps and that it is approved by ASTA or BSI to BS 1362.

Check for the ASTA mark  or the BSI mark  on the body of the fuse.

If the plug contains a removable fuse cover you must ensure that it is refitted when the fuse is replaced.

If you lose the fuse cover the plug must not be used until a replacement cover is obtained.

A replacement fuse cover can be purchased from your local Panasonic Dealer.

IF THE FITTED MOULDED PLUG IS UNSUITABLE FOR THE SOCKET OUTLET IN YOUR HOME THEN THE FUSE SHOULD BE REMOVED AND THE PLUG CUT OFF AND DISPOSED OF SAFELY.

THERE IS A DANGER OF SEVERE ELECTRICAL SHOCK IF THE CUT OFF PLUG IS INSERTED INTO ANY 13 AMP SOCKET.

If a new plug is to be fitted please observe the wiring code as shown below.

If in any doubt please consult a qualified electrician.

Warning: THIS APPLIANCE MUST BE EARTHED.

Important

The wires in this mains lead are coloured in accordance with the following code:

Green-and-yellow: Earth

Blue: Neutral

Brown: Live

As the colours of the wires in the mains lead of this apparatus may not correspond with the coloured markings identifying the terminals in your plug, proceed as follows:

The wire which is coloured GREEN-and-YELLOW must be connected to the terminal in the plug which is marked by the letter E or by the safety earth symbol  coloured GREEN or GREEN-and-YELLOW.

The wire which is coloured Blue must be connected to the terminal which is marked with the letter N or coloured BLACK.

The wire which is coloured Brown must be connected to the terminal which is marked with the letter L or coloured RED.

The mains plug on this equipment must be used to disconnect the mains power.

Please ensure that a socket outlet is available near the equipment and shall be easily accessible.

■ How to replace the fuse

Open the fuse compartment with a screwdriver and replace the fuse.

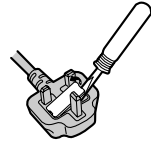

Warnings

- This equipment is not designed for connection to an IT power system. (An IT system is a system having no direct connections between live parts and Earth; the exposed-conductive-parts of the electrical installation are earthed. An IT system is not permitted where the computer is directly connected to public supply systems in the U.K.)
- Disconnect the mains plug from the supply socket when the computer is not in use.

This equipment is produced to BS800/1983.

For Europe



Declaration of Conformity (DoC)

“Hereby, we and Panasonic Service Europe GmbH (PSE), declares that this Personal Computer is in compliance with the essential requirements and other relevant provisions of EU Council Directives.”

Hint:

If you want to get a copy of the original DoC of our products, please contact to our web address: <http://doc.panasonic-tc.de>

Compliance Notice - CE Mark

This equipment is in conformance with the requirements of the European Council Directive listed below:

73/23/EEC Low Voltage Directive with amendment 93/68/EEC

89/336/EEC EMC Directive with amendments 92/31/EEC and 93/68/EEC

Interface Cable

Use of an interface cable longer than 3 m (9.84 feet) is not recommended.

Lithium Battery

Lithium Battery!

This computer contains a lithium battery to enable the date, time, and other data to be stored. The battery should only be exchanged by authorized service personnel.

Warning! A risk of explosion from incorrect installation or misapplication may possibly occur.

Precautions

The CF-P1 was developed based on thorough research into real-world portable computing environments. Exhaustive pursuit of usability and reliability under harsh conditions led to innovations such as the magnesium alloy exterior and flexible internal connections. The CF-P1's outstanding engineering has been tested using the stiff MIL-STD- 810F (for vibration and shock) and IP (for dust and water) based procedures. As with any portable computer device precautions should be taken to avoid to the CF-P1 damage. The following usage and handling procedures are recommended.

Before putting the computer away, be sure to wipe off any moisture.

Avoid Extreme Heat and Cold

Do not store or use the computer in locations exposed to heat (in an automobile on a sunny day, for example), direct sunlight, or extreme cold.

Avoid moving the computer between locations with large temperature differences.

Operation

Temperature: -20 °C to 50 °C {-4 °F to 122 °F}

Humidity: 30% to 80% RH (No condensation)

Storage

Temperature: -25 °C to 60 °C {-13 °F to 140 °F}

Humidity: 30% to 90% RH (No condensation)



Keep Small Objects Away

Do not insert paper clips or other small objects into the computer.



Do Not Disassemble the computer

Do not attempt to disassemble your computer.



Avoid Excessive Force on the LCD

Do not apply excessive downward force on the LCD.



Avoid Radio Frequency Interference

Do not place the computer near a television or radio receiver.



Keep SD memory cards and MultiMedia Cards (both sold separately) away from infants and small children.

Accidental swallowing will result in bodily injury.

In the event of accidental swallowing, see a doctor immediately.

Be careful of low-temperature burns

Avoid more than casual contact with any heat producing area of the computer, AC adaptor, and any option or accessory you use with it. Even low heat, if warmer than the body's temperature, can cause burns, if the skin is exposed to the heat source for a long enough period of time.



Avoid Magnetic Fields

Keep the computer away from magnets.



Avoid Stacking

Do not place heavy objects on the computer.

Handling

- Do not drop or hit your computer against solid objects.
- Remove all cables before transporting your computer.
- We recommend that the battery be fully charged. We also recommend that the backup battery (a built-in coin type battery) be fully charged.

When transporting spare batteries inside a package, briefcase, etc., we recommend that the batteries be stored in a plastic bag.

Handling (continued)

- Always carry your computer with you when traveling. Never check it in with luggage. For use of the computer inside an aircraft, we recommend asking the airlines regarding their policy on this issue.
- It is a good idea to make backup copies on SD memory cards/MultiMedia Cards and carry them with you.

Battery Pack

- Care should be exercised with regard to the following in order to avoid the possibility of over-heating, fire, or damage.



Avoid Heat

Do not throw the battery pack into a fire or expose it to excessive heat.



Do Not Use With Any Other Device

The battery pack is rechargeable and was intended for the specified computer. Do not use it with a device other than the one for which it was designed.



Keep Articles Away

Do not place the battery pack together with articles such as necklaces or hairpins when carrying or storing.



Stop Using

Should the battery emit an abnormal odor, become hot to the touch, become discolored, change shape, or become in any way different from normal, remove it from the computer and stop using it.



Do Not Disassemble

Do not insert sharp objects into the battery pack, expose it to bumps or shocks, or deform, disassemble, or modify it.

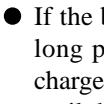

- If the battery pack will not be used for a long period of time (a month or more), charge or discharge (use) the battery pack until the remaining battery level becomes 30 % to 40 % and store it in a cool, dry place.
- The battery pack is not charged when the computer is first purchased. Be sure to charge it before using it for the first time. When the AC adaptor is connected to the computer, charging begins automatically.
- If the battery leaks and the fluid get into your eyes, do not rub your eyes. Immediately flush your eyes with clear water and see a doctor for medical treatment as soon as possible.



Do Not Short

Do not short the positive (+) and negative (-) contacts.



Avoid Extreme Heat, Cold and Direct Sunlight

Do not charge, use or leave the battery pack for extended periods where it will be exposed to direct sunlight, in a hot place (in an automobile on a sunny day, for example), or in a cold place.





Do Not Put Into a Microwave

Do not put the battery pack into a microwave oven or a pressurized chamber.

Precautions

About High Temperature Mode

This computer has a high temperature mode function that prevents the degradation of the battery in high temperature environments. We recommend setting the high temperature mode function when installing the computer in a car, etc. To do this, set [Charging mode:] in  - [Settings] - [System] tab - [Panasonic Settings] - [Charging Mode] tab*¹ to [High Temperature]. In the high temperature mode, the full charge capacity of battery becomes approximately 70 %.

*¹ To display the hidden tab, tap the  on the right edge of the tab.

NOTE

- The battery pack may become warm during recharging or normal use. This is completely normal.
- Recharging will not commence outside of the allowable temperature range (5 °C to 40 °C {41°F to 104°F})*². Even if charging stops because the temperature is outside the charging temperature range, the battery indicator will remain in the illuminated orange. Once the allowable range requirement is satisfied, charging begins automatically. Note that the recharging time varies based on the usage conditions. (Recharging takes longer than usual when the temperature is 10 °C {50 °F} or below.)
- If the temperature is low, the operating time is shortened. Only use the computer within the allowable temperature range.
- The battery pack is a consumable item. If the amount of time the computer can be run off a particular battery pack becomes dramatically shorter and repeated recharging does not restore its performance, the battery pack should be replaced with a new one.
- When a spare battery pack is to be carried in a pocket or bag, it is recommended that it be placed in a plastic bag so that its contacts are protected.
- Always power off the computer when it is not in use. Leaving the computer on when the AC adaptor is not connected will exhaust the remaining battery capacity.

*²These temperature settings are valid when the battery is charging and the computer is off. The temperature range may become narrower when the battery is charging and the computer is operating.

When Using Peripheral Devices





Pay strict attention to the following points to avoid damage to the computer, peripheral devices, cables, etc. Also, in addition to following this manual, carefully read the instruction manuals for the peripheral devices being used.

- Use only peripheral devices that conform to the computer's specifications.
- Connect the devices properly, paying close attention to the condition and position of the connectors.
- If a connection cannot be made easily, do not apply undue force; check once more to confirm the condition and position of the connector (alignment of pins, etc.).
- If the connector has holding screws, fasten the screws firmly.
- Do not carry the computer with cables attached, and do not pull on the cables forcefully.

What's in the Box?

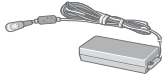
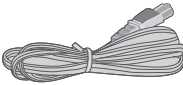
Make sure the parts shown in the figure have been supplied. If any of these items is missing or is not working properly, contact Panasonic Technical Support.

Make sure the provided stylus has been stored to the computer (☞ page 20).

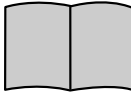
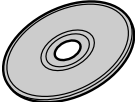
AC Adaptor 1	AC Cord 1	
 Model No:CF-AA1623A		
Battery Pack 1	Cradle 1	
 Model No: CF-VZSU28	 Model No: CF-VEBP12	
Strap 1	Operating Instructions .. 1	Companion CD* 1
 (see below)	 (this book)	

*1You can use the Companion CD to install various software, including Microsoft® Outlook® 2002 and Microsoft® ActiveSync® (☞ page 36).

Attaching the Strap

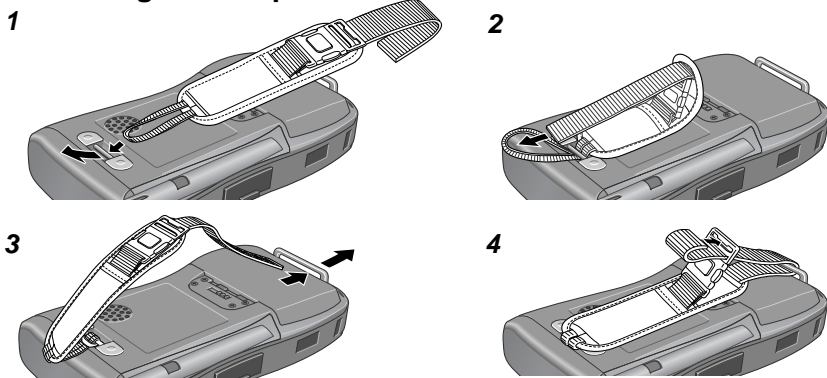

CAUTION

- The strap has been designed to carry only the weight of the computer. Therefore, be sure that the strap does not carry a weight that exceeds the weight of the computer. The strap may accidentally come loose from the computer.
- Do not use a strap that is damaged or about to tear.

Names and Functions of Parts

The illustrations shown may differ from the actual physical appearances.

Depending on built-in card or modules, some models have a different shape (e.g., barcode scanner). For details, refer to the attached Supplementary Instructions. (These cards and module cannot be changed.)

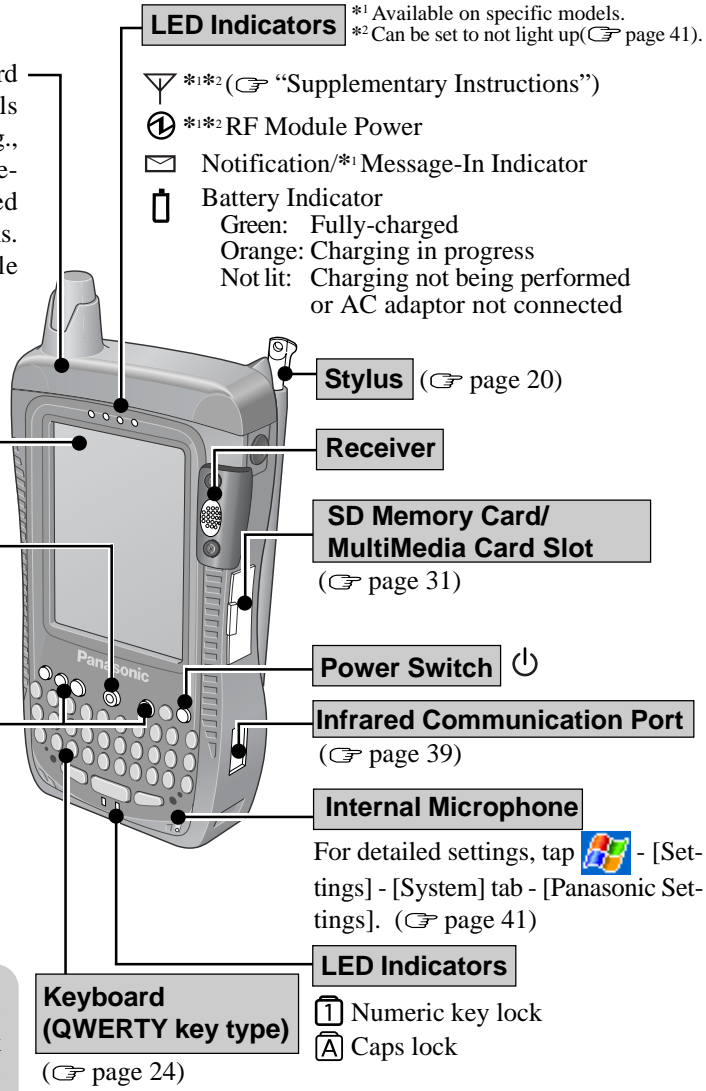

CAUTION

- Do not cover the computer with a thick cloth, such as a blanket.

< For the CF-P1P1 series >

The keyboard is of the numeric keypad type. There are no LED indicators (🔑 Numeric key lock and 🔒 Caps Lock).

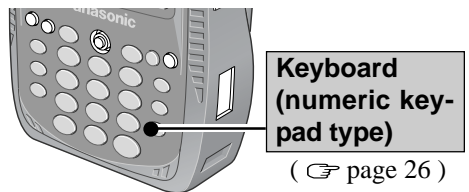

Strap Attachments

(☞ page 9)

Speaker

To adjust the volume, tap  - [Settings] - [Personal] tab - [Sounds & Notifications] - [Volume] tab.

Battery Pack

(☞ pages 13 and 30)

Headset Jack

Use this connector to connect a headset or a 3.5 DIA plug adaptor (☞ page 12). Audio output and voice call from the internal speaker are disabled when the headset or the 3.5 DIA plug adaptor is connected.

Reset Switch

(☞ page 43)

DC-IN Jack

Expansion Connector

Set the computer into the cradle (included) (☞ next page). Or, you can connect the computer directly to the computer using the proper cable (☞ page 38).

Cursor Control

Using the cursor control, the following operations can be performed.

“Push” Operation:

Executes a selected item from a menu, or a selected icon. For example, after an item within a menu is selected, the cursor control can be pushed to execute this selected item.

“Move Up/Down Right/Left” Operations:

Performs the same function as the up/down left/right cursor keys. For example, the “Move Up” operation can be performed to select an item towards the top within a menu.

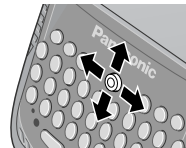
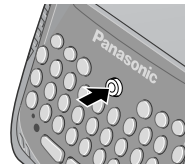

Changing the Cursor Control Settings

The cursor control settings allow you to adjust the interval between the waiting time until the repetition of an input begins (from the first input to the second input) if the cursor control is held down, and the repeat of the input (from the second input and on).

- 1 Tap  - [Settings] - [Personal] tab - [Buttons] - [Up/Down Control] tab.
- 2 Customize the way your cursor control repeats.
- 3 Tap [ok].

Names and Functions of Parts

Headset and 3.5 DIA plug adaptor

Only the CF-VHSP11W (sold separately) can connect to CF-P1's headset jack. CF-VHSP11W includes A and B. When using a 3.5 DIA plug, B is required. This adaptor can be connected to stereo headphones.

A. Headset



Front

*1 Answer switch



Back

Microphone

B. 3.5 DIA plug adaptor

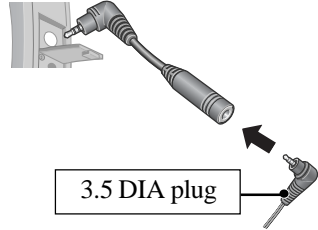

3.5 DIA plug

*1 Press for about one second to answer/hang up voice calls. Function will not operate if the switch is not pressed long enough.

Connecting/Removing the Cradle

Connecting the Cradle

Connect the cradle after removing the AC adaptor from the computer and closing the DC-IN Jack Cover.

DC-IN Jack Cover

- The AC adaptor is connected to the position shown by the arrow in the figure.
- Only the provided adaptor can be used.

DC-IN Jack

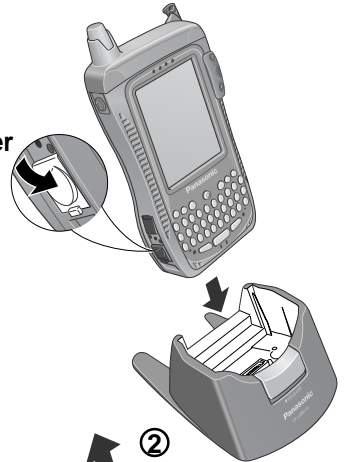
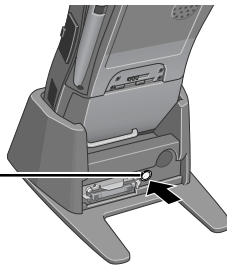

Removing the Cradle

1 Press the release lever.

2 While firmly holding the cradle and pressing down on the release lever with one hand, lift the computer up with the other hand.

Release Lever

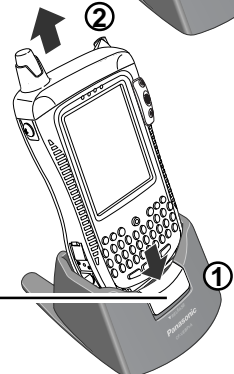

First-time Operation

1 Install the battery pack.

- (1) Power off your computer and turn it over.
- (2) Press position (A) to depress the battery pack cover and then slide the latch, and remove the battery pack cover.

NOTE

If the attached strap makes it difficult to remove the battery pack cover, unbuckle the strap and then remove the cover.

- (3) Set the arrow mark of the battery in the direction shown in the figure, and then insert the battery pack into the battery pack compartment.

- (4) Align the projecting part of the cover with the hole, attach the cover at an angle, and then set the cover on the body. Press position (A) to depress the battery pack cover and then slide the latch to lock the cover.

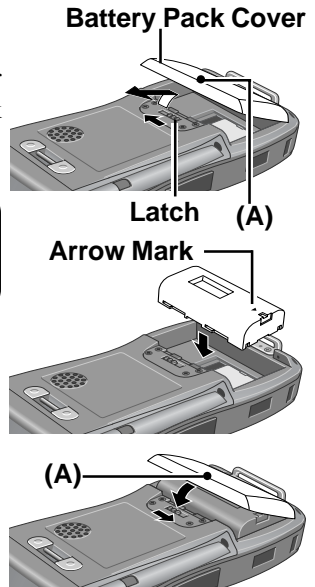

NOTE

After attaching the battery pack cover, slide the latch all the way to the left so that CF-P1 can turn on after the power switch is pressed.

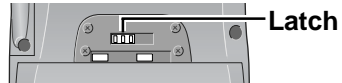

2 Connect your computer to a power outlet.

When the AC adaptor is connected to the computer, charging begins automatically.

Charging Time: Approx. 3 hours

This computer is equipped with a memory backup battery which automatically charges from the fully-charged lithium-ion battery (main battery). This backup battery retains data in memory when the lithium-ion battery is removed, and takes 36 hours to charge when you first use this computer.



First-time Operation

NOTE

- When the backup battery or main battery becomes low, some alert messages and icons will be displayed. (👉 page 17)

CAUTION

- Do not remove the main battery before the backup battery is fully charged. Otherwise, data in RAM will be lost.
- Take care to ensure that the remaining power in the main battery and the backup battery never discharges completely.

When any remaining power discharges completely, the computer will no longer function properly, and the computer powers off automatically. Connect the AC adaptor and recharge the battery. If the computer is left for 72 hours or more without recharging, the computer may be fully reset. When the computer is fully reset, all user-added data will be deleted. The computer will be returned to the condition at the time of purchase.

- After the cover is closed, press down firmly on the cover and confirm that the cover is locked.

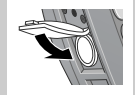

Handling the AC adaptor

- Do not twist or pull the AC power cord forcefully. Doing so may damage the connections.
- Use only the provided AC adaptor with your computer. Using an AC adaptor other than the one provided might damage the battery and/or the computer.
- When the DC plug is not connected to the computer, disconnect the AC cord from your AC wall outlet.
- Problems such as sudden voltage drops may arise during periods of thunder and lightning storms. Since this could adversely affect your computer, an uninterruptible power source (UPS) is highly recommended unless the battery pack is installed.

3 Turn your computer on

- (1) Using the provided stylus, push the center of the reset switch straight in for 1 second. If the DC-IN Jack's cover makes it difficult to push the reset switch, push the cover in a little as you push the switch.

Reset Switch



CAUTION

Use only the stylus provided to push the reset switch. Do not push the reset switch with any other sharp-pointed objects, i.e. pencils, and ball point pens. The reset switch or other parts may become damaged.

- (2) Tap the screen to set up your Pocket PC.

The Windows*¹ alignment screen is displayed.

*¹ This computer uses Microsoft® Windows® Mobile™ 2003 software for Pocket PC.

- (3) Align the touchscreen.

(For alignment, tapping operations are required. For information on tapping, refer to page 20.)

"+" is displayed in the center, upper left, lower left, lower right, and upper right portions of the screen, in that order. Each time the "+" mark is displayed, tap the center of the "+" mark with the stylus.

- (4) At [complete], tap the screen to begin using CF-P1.



4 Set the time and date

- (1) Tap  - [Settings] - [System] tab - [Clock].
- (2) Set the time and date.
- (3) Tap [ok].

NOTE

You can also set the time and date by tapping  on [Today] screen.

This concludes the first-time use operation guidelines.

Starting Up/Shutting Down

Starting Up (from the second time)

Lightly press the power switch once.

A program or file that was previously displayed appears on your screen.

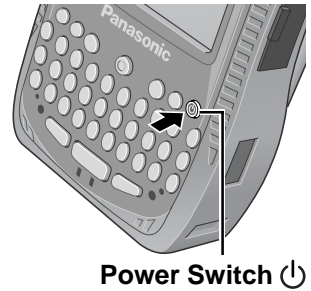

Power Switch



- Lightly press the power switch (for less than 0.5 seconds).
- To turn the backlights on/off:
Press the power switch until the LCD backlight and keyboard backlight go on/off and release the switch.
At the time of purchase, the setting of the keyboard backlight is "off". To turn the keyboard backlight on, refer to page 22.

NOTE

- When the backlight is on, more power is consumed, and the shortening of the operating time is accelerated.

The Navigation Bar and Command Bar

The navigation bar is located at the top of the screen. It displays the active program and current time, and allows you to switch to programs and close screens.

Use the command bar at the bottom of the screen to perform tasks in programs. The command bar includes menu names, buttons, and the input panel button.

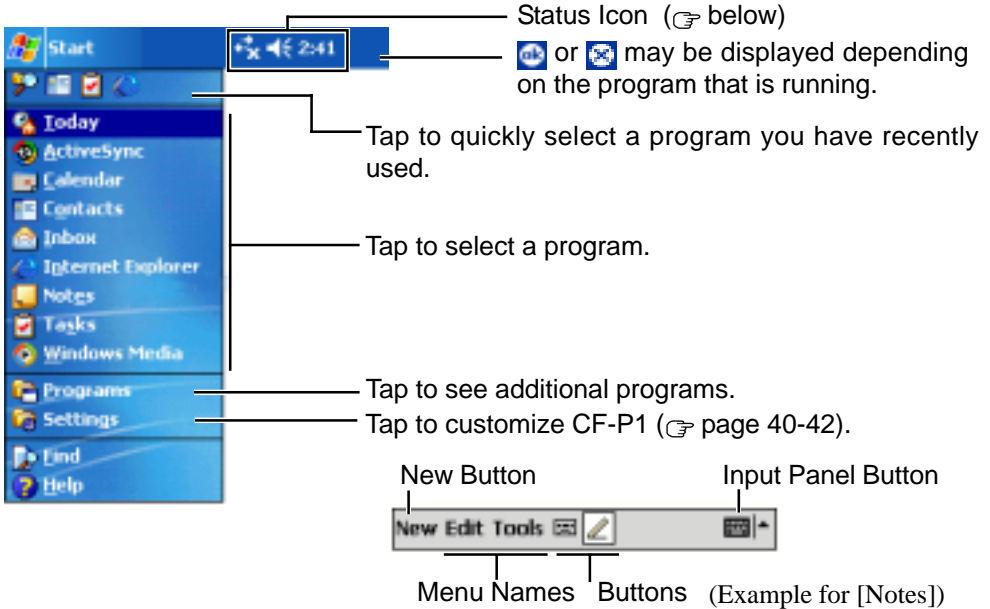

Following are some of the status icons you may see.

Status Icon & Meaning			
	Turn all sounds on and off		Connection is active
	Backup battery is very low		Synchronization is occurring
	Main battery is charging		Connection is not active
	Main battery is full		Notification that one or more instant messages were received
	Main battery is low		Notification that one or more e-mail messages were received
	Main battery is very low		*1 More Notification icons need to be displayed. Tap the icon to view all.

*1 This icon differs depending on model.

Starting Up/Shutting Down

Today Screen

You'll see the Today screen when you turn on the computer for the first time each day (or after 4 hours of inactivity*¹). You can also display it by tapping  - [Today]. On the Today screen, you can see at a glance important information for the day.

*¹ To change the setting, tap  - [Settings] - [Personal] tab - [Today] - [Items] tab.

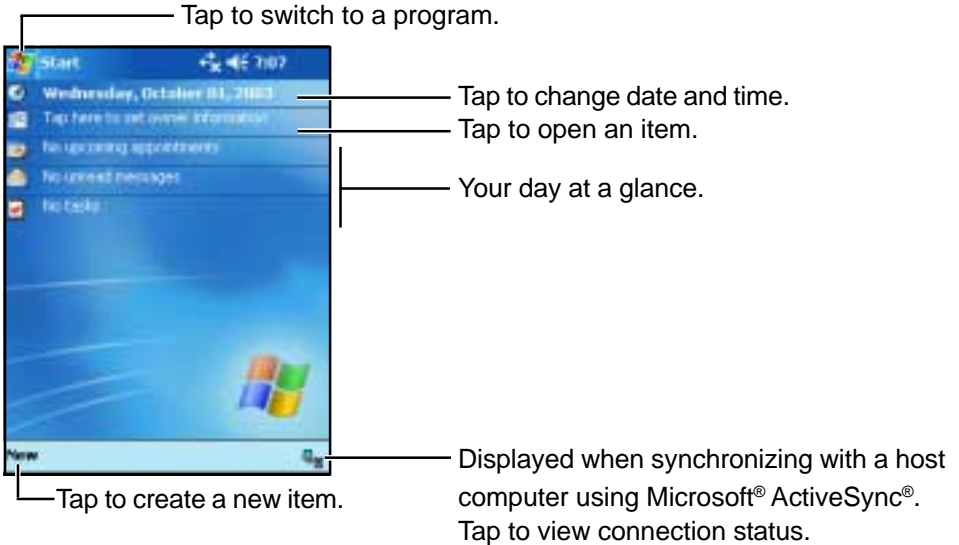

Pop-up Menus

With pop-up menus, you can quickly choose an action for an item. For example, you can use the pop-up menu in the contact list to quickly delete a contact, make a copy of a contact, or send an e-mail message to a contact. The actions in the pop-up menu vary from program to program. To access a pop-up menu, tap and hold the stylus on the item name that you want to perform the action on. When the menu appears, lift the stylus, and tap the action you want to perform. Or tap anywhere outside the menu to close the menu without performing an action.

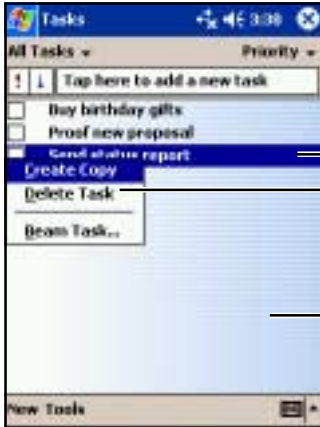

— Tap and hold to display the pop-up menu.

— Lift the stylus and tap the action you want.

— Tap outside the menu to close it without performing an action.

Shutting Down (power off)

Lightly press the power switch once (within 0.5 seconds). CF-P1 shutdown is the same as the standby state of a computer. (Standby state is a function allowing you to turn off the power without closing applications. The settings before the power was turned off are stored in the memory, so when the power is turned back on, the screen is the same as it was before the power was turned off (the same applications and files are opened) and you can start working immediately.)

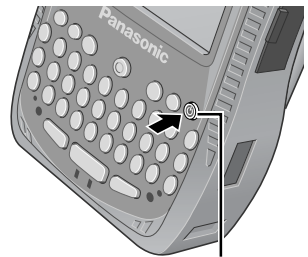

Power Switch 

CAUTION

Check that the SD memory card/MultiMedia Card is not being accessed before turning off the power. If the power is turned off while the card is being accessed, the data stored on the card may be damaged and the computer may stop working properly.

LCD (Touchscreen)

Using the Stylus

Use the stylus provided to perform operations on the touchscreen. The stylus is located in the stylus holder at the upper right of the computer, and can be held like a pen or pencil. The following operations are possible on the touchscreen.



Tapping

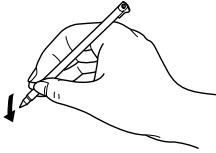

You can select an item on the screen by tapping it with the stylus. This operation is called a “tap”.

Dragging

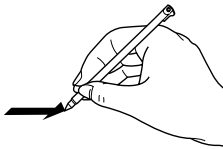

You can drag on item on the screen by holding the stylus down over the item and then moving the stylus. This operation is called a “drag”.

Tapping and Holding

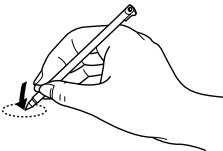

You can tap and hold the stylus on an item to see a list of actions available for that item. On the pop-up menu that appears, tap the action you want to perform.

Handling the Stylus

- Clean the stylus tip and screen prior to operation. Foreign particles can scratch the screen and impede the operation of the stylus.
- Use the provided stylus only on the screen. Using it for any other purpose may damage the stylus and scratch the screen.

Handling the Touchscreen

- Use the provided stylus with CF-P1. Do not use an implement other than the stylus that comes with the computer.
- Do not place any object on the surface or press down forcefully with sharp-pointed objects (e.g., nails), or hard objects that can leave marks (e.g., pencils and ball point pens).
- Do not operate the computer when such things as dust are on the LCD. Do not allow substances such as oil to contact the LCD. The cursor may not work properly in such cases.

Aligning the Screen

Align the screen if the cursor does not correctly move to the position where the stylus touches the screen of the computer.

1 Tap  - [Settings] - [System] tab - [Screen].

2 Tap [Align Screen].

3 "+" is displayed in the center, upper left, lower left, lower right, and upper right portions of the screen, in that order.

Each time the "+" mark is displayed, tap the center of the "+" mark with the stylus.

The alignment procedure is executed after the five "+" marks are touched.

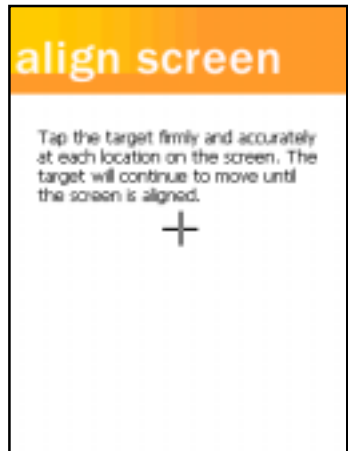

NOTE

<For the CF-P1P3 series>

You can also display the alignment screen when  (Mode key) + the cursor control are pushed.

<For the CF-P1P1 series>

You can also display the alignment screen when  (PF key) + the cursor control are pushed.

Backlight Setting

Adjust the LCD Brightness

Screen brightness can be adjusted in accordance with the usage conditions.

- 1 Tap  - [Settings] - [System] tab - [Backlight].
- 2 Tap the [Brightness] tab and adjust the brightness with the slider.
- 3 Tap [ok].

LCD Backlight ON/OFF

Press the power switch until the LCD backlight goes on/off after the computer is turned on and release the switch.

Setting of the LCD Backlight and Keyboard Backlight

The LCD backlight and keyboard backlight can be set to switch off automatically (e.g., for conserve power) by setting the timeout function. Individual settings can be made for battery use and AC adaptor use.

- 1 Tap  - [Settings] - [System] tab - [Backlight].
- 2 **Battery use setting:** Tap the [Battery Power] tab.
AC adaptor use setting: Tap the [External Power] tab.

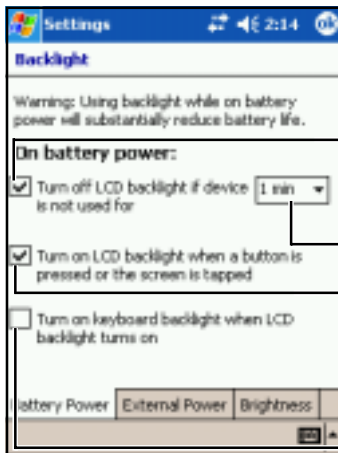

(Example for [Battery Power])

Add a check mark so that when the device is not operated, the LCD backlight switches off automatically when the timeout expires.

Timeout

Add a check mark so that tapping the screen turns the LCD backlight on.

Add a check mark to turn the keyboard backlight on when the LCD backlight turns on.

- 3 Tap [ok].

Entering Information

You can use the following options to enter information:

- Use the keyboard to input the number, character*¹ or symbol*¹ shown on the key top.
- Use the input panel to input typed text, either by using the soft keyboard or other input method.
- Write directly on the screen.*²
- Draw pictures on the screen.*²
- Speak into the internal microphone to record a message.*²
- Use Microsoft® ActiveSync® to synchronize or copy information from a host computer to CF-P1. For more information on Microsoft® ActiveSync®, see ActiveSync Help on the host computer (☞ page 36).

*¹ Only for the CF-P1P3 series.

*² For more information, tap  - [Help] - [Settings] - [Input].

Using the Input Panel

Use the input panel to enter information in any program on CF-P1. You can either type using the soft keyboard or write using Letter Recognizer, Block Recognizer, or Transcriber. In either case, the characters appear as typed text on the screen.

To show or hide the input panel, tap the input panel button. Tap the arrow next to the input panel button to see your choices.

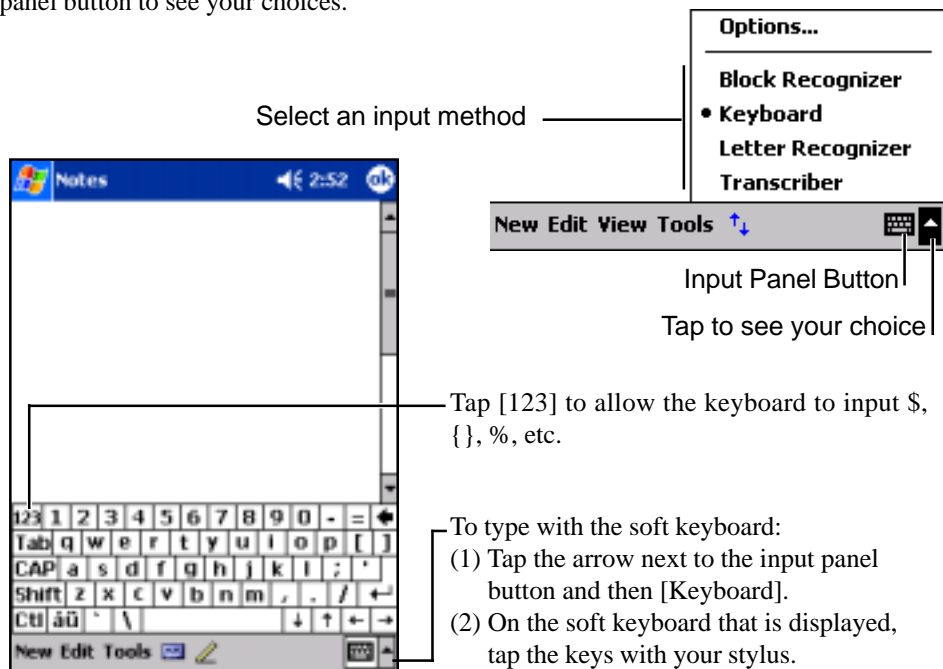

NOTE

If the keyboard is used while the soft keyboard is open, the soft keyboard will close.

Entering Information

Using the QWERTY Keypad Type Keyboard <For the CF-P1P3 series>



Mode Key

- A symbol or number on the key top is input by pressing the Mode key (the numeric key lock indicator goes on) followed by the corresponding alphabet key. Each Mode key press works for the input of only one symbol or number. This is convenient when using one hand to input sentences including symbols/numbers.

Example: To input “abc.def.”, press the keys in the following order.

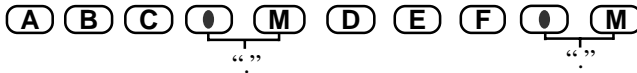

- To input only symbols or numbers on the key top, keep holding down this key while inputting symbols or numbers.
- This key is also for inputting accented letters, using [ESC]key and [DEL]key. For more details, see the explanation of each keys.

NUM key

- Each time the Mode key + NUM key are pressed, the mode changes from the alphabet input mode (default) to the symbol/number input mode, and vice versa. In the symbol/number input mode (numeric key lock indicator on), the symbols and numbers on the key top can be inputted continuously.
- To exit the symbol/number input mode, you can also choose to press only the NUM key.
- Pressing this key once and pressing an alphabet key can be input the capital letter.

áü/SPACE Key

- Pressing this key inserts a space.
- Pressing the Mode key + áü/SPACE key input accented letters after inputting the corresponding alphabet key.

Example: To input “à” or “â”, press the keys in the following order.



Hold down the Mode key and press the áü/SPACE key repeatedly if necessary, until the desired character appears.

▲ CAP Key

This key is used for inputting capital letters.

- Each time the Mode key + ▲ CAP key are pressed, the mode changes from the standard (non-caps) input mode to the caps lock mode, and vice versa. In the caps lock mode (caps lock indicator goes on), capital letters can be inputted continuously.

(When both the numeric key lock indicator and caps lock indicator are on, priority is given to the symbol/number input mode.)

Inputting non-capital characters in the caps lock mode:

Press an alphabet while also holding down on the NUM ▲ key.

- Pressing this key once and pressing an alphabet key can be input the capital letter (like the NUM ▲ key).

Enter Key

This key works the same as the Enter key of a computer, e.g., line feed in a document, and to select icons and items from menus, etc.

DEL (Delete) /Backspace Key

This key works the same as the Backspace key of a computer.

If pressed the Mode key + DEL/Backspace key, this key works the same as the Delete key of a computer.

TAB Key

This key works the same as the Tab key of a computer.

OK Key

This key works the same as the tapping [ok] on the screen.

ESC Key

If pressed with Mode key, this key works the same as the Esc key on a computer.

Entering Information

Using the Numeric Keypad Type Keyboard <For the CF-P1P1 series>

Press a key to input the number shown on the key top.

The keys can also be used as function keys. (See "PF key" below.)

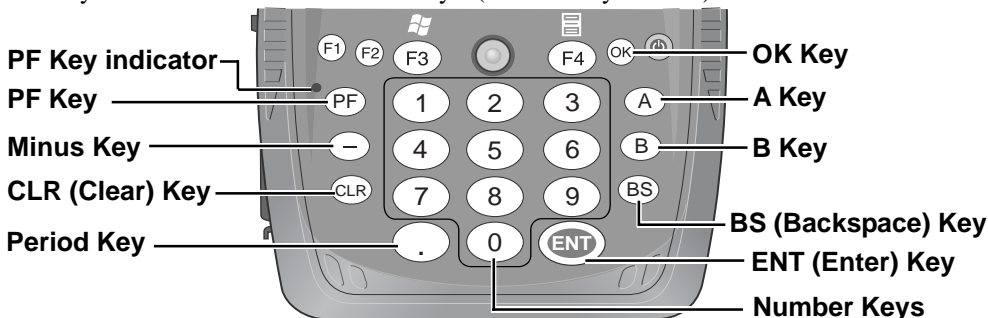

PF Key:

When PF is pressed and the PF key indicator is turned on (function key mode), the functions assigned to the each number key are activated when the corresponding keys are pressed.

(The functions assigned to the number keys differently depending on the application.)

- To use the function key mode only once:

Press PF once, then press a number key.

(You can also press the number key while pressing PF .)

Once the number key is pressed, PF indicator turns off. To turn it off without pressing a number key, press PF twice.

- To use the function key mode continuously:

Press PF twice to lock the function key mode, then press the number keys. Press PF once to unlock the function key mode.

You can also assign a combination of this key and the number key to the program. For detailed settings, see the next page.

Minus Key:

Press this to input a "-".

CLR (Clear) Key:

The function differently depending on the application.

Period Key:

When pressed, a period (".") is input.

ENT (Enter) Key:

This key works the same as the Enter key of a computer, e.g., line feed in a document, etc.

BS (Backspace) Key: This key works the same as the Backspace key of a computer.

A/B Key:

These operate as function keys.

You can also assign these keys to the program. For detailed settings, see the next page.

OK Key:

This key works the same as the tapping [ok] on the screen.

Assigning of Programs <Only for the CF-P1P1 series>

Customize the keys to open your most used programs.

1 Tap  - [Settings] - [System] tab - [Panasonic Settings] - [Buttons] tab.

2 Choose each setting.

The following functions are assigned to the keys at the time of purchase:

PF+6 - Volume up, PF+7- Volume down

The assignment of those keys can be changed.

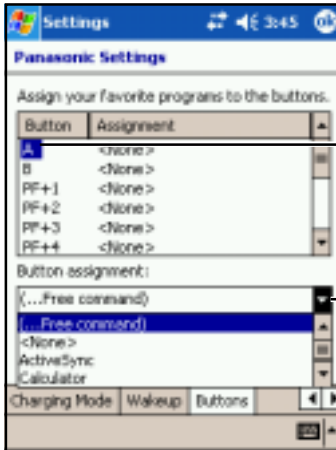

(1) Tap one item.

(2) Tap ▼ under [Button assignment] and select a program from the list.

When selecting [None], the button assignment in the list shown above will be none.

When selecting [...Free command], [Open] will be displayed (See below).

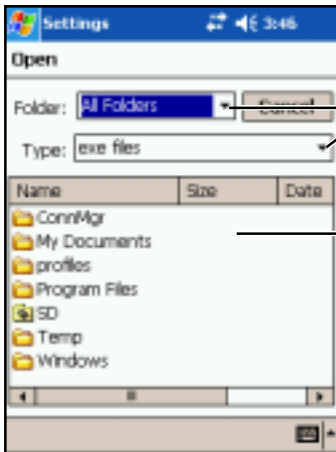

(3) Tap ▼ and select a folder and type of files.

(4) Tap folders and select a program from the list.

Program Buttons

The F1, F2, F3 and F4 buttons are called program buttons. If either of the program buttons is pressed after the computer has started up, the program assigned for that button is started up.

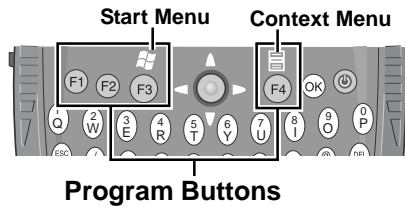

Changing the Assignment of a Program Button

Programs are assigned to the program buttons at the time of purchase.

F3 - Start Menu, F4 - Context Menu

You can change the assignment of the program buttons following the procedure.

1 Tap - [Settings] - [Personal] tab - [Buttons].

2 Choose each setting.

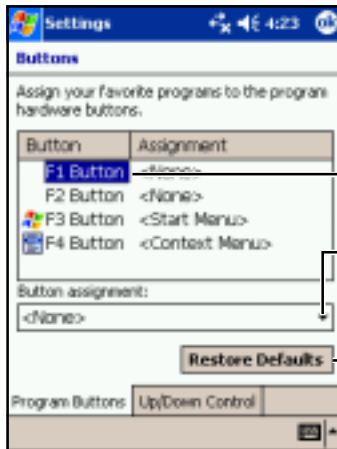

(1) Tap one button.

(2) Tap ▼ under [Button assignment] and select a program from the list.

If the [Restore Defaults] is tapped, the assignments will return to the default settings.

3 Tap [ok].

Setting to Resume with a Program Button

You can resume the computer with one of the F1, F2, F3 and F4 buttons.

1 Tap - [Settings] - [System] tab - [Panasonic Settings] - [Wakeup]*¹ tab.

*¹ To display the hidden tab, tap the on the right edge of the tab.

2 Add a check mark to resume when the program button is pressed.

3 Tap [ok].

Battery Power

CAUTION

- Ensure that the backup battery is fully charged before replacing the battery pack and replace the battery pack within 5 hours; otherwise the data in RAM will be lost.
- Do not touch the terminals of the battery pack. The battery pack may no longer function properly if the contacts are dirty or damaged.
- Do not expose the battery pack to water, or allow it to become wet.
- The battery pack is not charged when CF-P1 is first purchased. Be sure to charge it before using it for the first time. When the AC adaptor is connected to CF-P1, charging begins automatically.
- Use only the specified battery pack (CF-VZSU28W) with CF-P1.
- Do not install or remove the battery pack while CF-P1 is on.

Remaining Battery

Tap  - [Settings] - [System] tab - [Power].

The remaining battery charge is displayed.

When the Remaining Battery Charge Becomes Low

- Plug in the AC adaptor, and fully charge your battery.
- Use a spare battery if you have one.
- If you have neither the AC adaptor nor a spare battery, power off your computer.

About High Temperature Mode

This computer has a high temperature mode function that prevents the degradation of the battery in high temperature environments.

To use the high temperature mode function, tap  - [Settings] - [System] tab - [Panasonic settings] - [Charging mode] tab, and set [Charging mode] to [High Temperature]. A level corresponding to a 100% charge for high temperature is approximately equivalent to an 70% charge level for normal temperature mode.

Battery Power

Replacing the Battery Pack

When the charge provided by your battery pack is supplied for only a short period of time, even after full charging according to the instructions, it may be time to replace your battery pack. The battery pack is a consumable item and therefore requires replacement (CF-VZSU28W).

Remove the battery pack

- (1) Turn off your computer and wait for 30 seconds.
- (2) Turn your computer over.
- (3) Press position (A) to depress the battery pack cover and then slide the latch, and remove the battery pack cover.

NOTE

If the attached strap makes it difficult to remove the battery pack cover, unbuckle the strap and then remove the cover.

- (4) Remove the battery in the direction shown in the figure.

Install the battery pack

- (1) Turn off your computer.
- (2) Refer to page 13 about installing the battery pack.
- (3) Turn your computer on.
- (4) Save the unsaved data and push the reset switch.

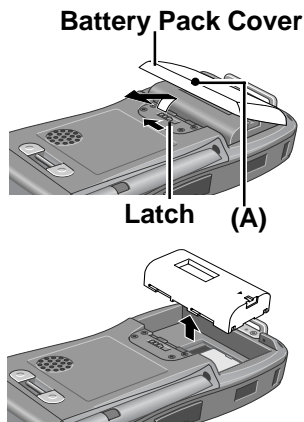

SD Memory Card/MultiMedia Card

An SD memory card/MultiMedia Card can be used for the following purposes.

- The exchange of data with various devices equipped with an SD memory card/MultiMedia Card slot, audio storage, and so on.

NOTE

Software (e.g., drivers) required to exchange data with these devices. (Refer to the instructions manual provided with each SD compatible peripheral device.)

- Use as a memory card (e.g., use as a storage unit on which files can be written).

Inserting/Removing an SD Memory Card/MultiMedia Card

1 Open the SD memory card/MultiMedia Card slot cover.

2 Inserting

Slide the card in until it snaps into place as shown in the illustration.

- Make sure the labeled face of the SD memory card/MultiMedia Card is towards the front of the computer and then firmly insert the card. If you mistake the back side of the card with the top surface side, the card cannot be inserted all the way into the slot.
- Do not insert the card at an angle.
- Insert the card all the way into the slot.

Removing

- (1) Press the card. It will come out slightly.
- (2) Remove the card.

3 Close the SD memory card/MultiMedia Card slot cover.



SD Memory Card/
MultiMedia Card Slot



CAUTION

Before removing an SD memory card/MultiMedia Card or powering off CF-P1, check to see if CF-P1 is trying to access the card. Such accesses are done intermittently for a short period of time. Be sure to remove the card or power off CF-P1 only after confirming that CF-P1 is not trying to access the card. If the card is removed or CF-P1 is powered off during an access attempt, valuable data may be lost or CF-P1 may fail to work properly.

Panasonic Backup

Using the backup function, you can back up data from the CF-P1 RAM to an SD memory card, MultiMedia Card, CF memory card or ROM option area, or restore data backed up on those storage area to the CF-P1 RAM.

CAUTION



- If a mail in [Inbox] is backed up using Panasonic Backup, it cannot be accessed after restoring. When using [Inbox], do not use Panasonic Backup. Use Microsoft® ActiveSync® to backup/restore.
- Do not do the following during the procedure:
 - Touching the power switch
 - Performing any keyboard and touchscreen.
- Disable the connection with the host computer, for example by disconnecting the cable.
- Confirm that battery remaining is at least 50%, disable all power management, and stop any other programs that may be running.

NOTE

- Backup processing cannot be executed manually during Auto Backup or Auto Restore.
- We recommend that each media be formatted as shown below when backing up.

SD	SD Format (use SD Formatter)
MultiMedia Card	FAT16
CF memory card/ROM option area	Not required.

Manual Backup

- 1 Reset CF-P1** (☞ page 43).
- 2 When backing up to an SD memory card, insert the SD memory card.**
- 3 Tap  - [Programs] - [Panasonic Backup] - [Backup] tab.**
- 4 Tap  to select the storage area to back up the data.**
- 5 Tap [Backup Start].**
- 6 Input the Backup file name.**
Add a check mark for [Set Password] and set a password if required.
- 7 Tap [OK].**

Follow the on-screen instructions.

The progress screen will be displayed. To stop the operation, tap [Abort].

“Backup successful” will be displayed when the backup is complete. Tap [ok].

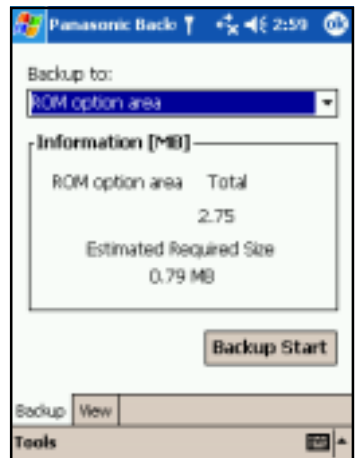

Auto Backup

1 Tap  - [Programs] - [Panasonic Backup].

2 Tap [Tools] on the command bar and select [Auto Backup Settings].

3 Tap [File] tab.

(1) Tap ▼ to choose the storage area for Auto Backup.

(2) Change the settings in [Settings].

If the ROM option area is chosen, some settings cannot be changed.

CAUTION

- If there is a check mark in [Stop other application before backup], some applications currently being executed may not be shut down properly.

4 Make a setting for Auto Backup.

- When making a setting at the time and day*¹:

(1) Tap [Schedule] tab.

(2) Add a check mark for [Scheduling backup].

(3) Set the time and day to back up at [Backup Schedule].

CAUTION

- When using 10 MB or more of storage memory, do not operate the computer for a few minutes after making settings.

- When making a setting to start Auto Backup when the remaining battery power is low*¹:

(1) Tap [Battery] tab.

(2) Add a check mark for [Backup when battery is low].

(3) Set the threshold.

NOTE

- If power is off, the amount of battery power remaining cannot be checked so that this function cannot work.

*¹[Scheduling backup] and [Battery] can be set simultaneously.

- When setting a password for backup files:

(1) Tap [Password] tab.

(2) Add a check mark for [Set Password].

(3) Set password for backup files.

5 Tap [ok].

Panasonic Backup

Auto Restore

1 Full reset CF-P1 (☞ page 43 step (1) - (4)).

[Panasonic Backup] screen will be displayed.

2 Select a file for restore, and tap [OK].

If a password has been set, a message will be displayed. Enter the password and press [OK]. Restore will start. The progress screen will be displayed. When the restore is complete, CF-P1 resets automatically.



Pocket Internet Explorer

You can connect to Internet service provider (ISP), and use the connection to send and receive e-mail messages and view Web or WAP pages.

Getting Connected

The settings will vary for different network environments. Ask your system administrator or the person in charge of the network and make settings using the followings.

(1) Tap  - [Settings] - [Connections] tab - [Connections] in order.

(2) Set up or change connection information

● On the [Tasks] tab:

(1) Tap one of the followings:

Add a new modem connection (My ISP)

Add a new modem connection (My Work Network)

Add a new VPN server connection (My Work Network)

Set up my proxy server (My Work Network)

(2) Enter the necessary information.

● On the [Advanced] tab:

Tap [Select Networks], [Select Location] or [Network Card] and set up if required.

For details, tap  - [Help].

To run Pocket Internet Explorer

Tap  - [Internet Explorer].



Home Button
Refresh Button
Favorites Button

Connecting to Your Computer

Use Microsoft® ActiveSync® to synchronize a host computer and CF-P1 information, to transfer files between a host computer and CF-P1, or to backup and restore data.

CAUTION

- To ensure that synchronization functions properly, install Microsoft® ActiveSync® 3.7 before connecting CF-P1 and the host computer for the first time.
- If a mail in [Inbox] is backed up using Panasonic Backup, it cannot be accessed after restoring. When using [Inbox], do not use Panasonic Backup. Use Microsoft® ActiveSync® to backup/restore.

The following methods can be used to connect the CF-P1 with a host computer.

- The use of a Serial Cable or USB Cable.
- The use of the infrared communication port.

Use an RS-232C Cable or a USB Adaptor Cable to connect CF-P1 with a peripheral.

Installing ActiveSync®

1 Set the Companion CD into the host computer.

The opening screen is displayed automatically.

- When the opening screen is not automatically displayed

In [Start] - [Run], input [x:\setup] and select [OK].

("x" is the drive letter. You can change the letter to suit your preference.)

2 Select button.

3 Select [Start Here].

4 Select [Install ActiveSync x.x*¹] and read the on-screen instructions and select [Install].

5 At [Installation Message], select [OK].

[File Download] will be displayed. This screen varies depending on the host computer's software (e.g. Internet Explorer version).

- If [Open] is displayed on [File Download], select [Open].
- If [Run this program from its current location] is displayed on [File Download], select it and then select [OK].

6 At [Microsoft ActiveSync], select [Next].

7 At [Select Installation Folder], select [Next].

8 At [Get Connected], read the on-screen instructions and connect the CF-P1 with a host computer.

(Refer to page 38 to connect the CF-P1 with a host computer.)

- Change the setting for the host computer or CF-P1, depending on the connection to the host computer. For details, refer to the ActiveSync Help of CF-P1, and also refer to Help displayed on the host computer during the installation.

*¹ The version is shown.

9 At [Set up a Partnership], select the partnership and select [Next].

NOTE

- To change the synchronization settings, tap, in order,  - [ActiveSync] - [Tools] - [Options...]. Be sure to disconnect the cable when changing the synchronization settings.
- Disconnect and connect the cable again if communications do not start.
- For information about the Microsoft® ActiveSync®, refer to the Microsoft® ActiveSync® Help.

CAUTION

- While performing communications, avoid the following:
 - Connect/disconnect the cable.
 - Remove the computer from the cradle.
 - Turn on/off the CF-P1 and the host computer.
- When adding a check mark for [Use mobile schedule to sync with this PC] in  - [ActiveSync] - [Tools] - [Options] - [PC] tab of CF-P1, be sure to check that Microsoft® ActiveSync® can be connected (for example, when the host computer's power is on). If Microsoft® ActiveSync® can not be connected, a situation may arise whereby even when the CF-P1's power is switched off, only the power to the LCD turns off, but the power to the main unit remains on (input from the keyboard is still possible). In this case, enable the Microsoft® ActiveSync® connection, and synchronize with the host computer again. If this situation occurs frequently, remove the checkmark from [Use mobile schedule to sync with this PC].

Backup/Restore data using ActiveSync®

Backup

- (1) At [Microsoft ActiveSync] on the host computer, select [Tools] - [Backup/Restore] - [Backup] tab.
- (2) Select [Full backup] or [Incremental backup] and then select [Back Up Now].
- (3) At [Backup Complete], select [OK].

Restore

- (1) After Backup procedure, at [Microsoft ActiveSync] on the host computer, select [Tools] - [Backup/Restore] - [Restore] tab, and select [Restore Now].
- (2) Follow the on-screen instructions and restore data.

Connecting to Your Computer

When Connecting the CF-P1 Directly with a Computer

CAUTION

- To ensure that synchronization functions properly, install Microsoft® ActiveSync® 3.7 before connecting CF-P1 and the host computer for the first time.
- Turn off the CF-P1, the connected computer, and all connected peripherals before connecting or disconnecting the cable.

Use a Connector Protector (optional: CF-VCCP11U) to connect CF-P1 with an external device firmly.

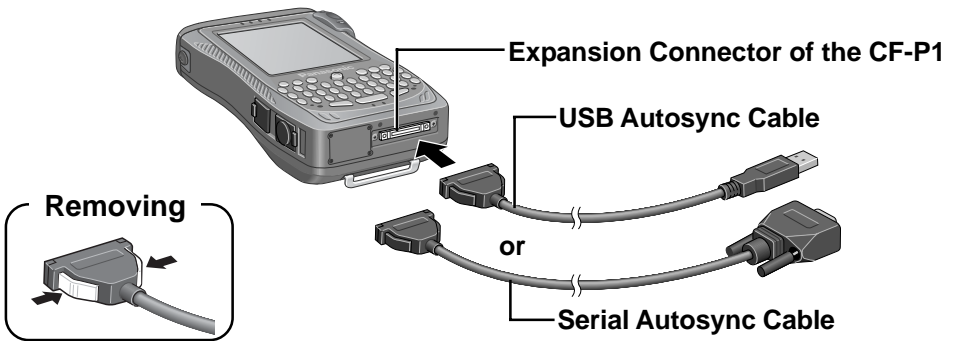
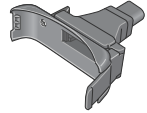

When Connecting the CF-P1 with a Computer via the Cradle

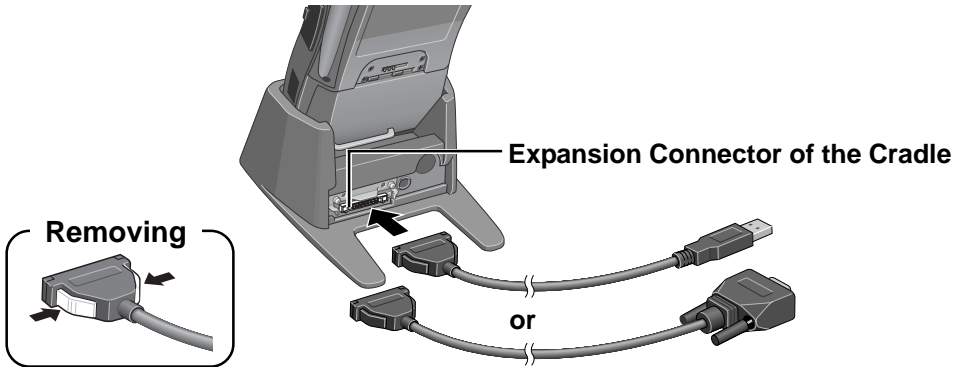

Using the Infrared Communication Port

By using the infrared communication port, data can be exchanged without a physical connection (e.g., using a cable or the cradle) between the CF-P1 and a host computer.

- Position CF-P1 so that the infrared communication port is face-to-face with the port of a host computer.
- Have the infrared port of the CF-P1 face the infrared communication port of a host computer.
- We recommend a port to port distance of 30 cm {11.8"} or less.

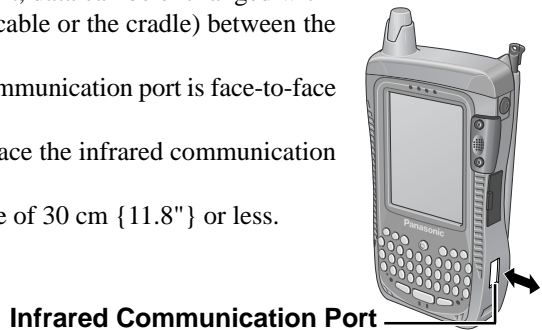

Customizing the Computer

If you want information on the various individual settings of the computer, tap  - [Settings] and then tap the item (icon) you want to check.

(For details, tap  - [Help] - [Settings].)

Personal



Buttons

Buttons

Program buttons and the cursor control settings.



Input

Input

Input panel (soft keyboard or letter recognizer, etc.) settings.



Menus

Menus

Select programs to be displayed in , or items to be displayed in [New] in the Today screen.



Owner Information

Owner Information

Registration (or changing) of the user's (owner's) personal information. You can choose to display the registered owner information on the screen when CF-P1 is turned on.



Password

Password

Password enable/disable, and a password hint setting.

If a password is set, it has to be inputted in order to open the password screen. When the wrong password is inputted four times, the set hint is displayed. At times certain characters, such as á and ü, cannot be input from the keyboard. Use the soft keyboard.



Sounds & Notifications

Sounds & Notifications

Volume setting and operation sound setting.

Specific sound settings to be generated in a wide range of situations.



Today

Today

Desktop display setting.

System



About

About

Display of release version and copyrights, and device ID setting.



Backlight

Backlight

LCD backlight timeout function, tap-induced backlight on and keyboard backlight setting, and LCD brightness adjustment.



Certificates

Certificates

Add and delete personal certificates and root certificates.



Clear Type Tuner

Clear Type Tuner

Make a text clear by moving the slider.



Clock

Clock

Time/date settings and alarm settings.



CPU Clock

CPU Clock

Change the operating speed of the processor.



Memory

Memory

Computer memory assignment possible (assignment of memory for data memory and memory for program execution). Display of total storage card memory if it is installed. Activate or stop the running programs.



Option Devices

Option Devices

Add a check mark in a box to activate CF card and RF module when the power is off*¹, and make Wireless LAN card*¹ on/off setting.

To set to not light up LED indicators*¹, remove the check mark at the [Use LED to indicate RF module status].

*¹ Available on specific models.



Panasonic Settings

Panasonic Settings

● [Version] tab: Display of ROM release version, the size of ROM option area, UUID and available devices*².

*² Available on specific models.

● [Record] tab: When a check mark is added at [Mix playsound], both play sound and microphone sound can be recorded. When the check mark is removed, only microphone sound can be recorded. (When using the telephone, both play sound and microphone sound will be recorded regardless of whether or not this check mark is turned on.) Select either [Use ALC (Automatic Level Control)] or [Manual] and move the slider to adjust the record gain level.

● [Phone] tab: Add a check mark for [Speaker phone] to use with the speaker phone when using the telephone.
Add a check mark for [Enable built-in microphone with Headset/Headphone] to use Headset/Headphone, using built-in microphone.

● [Charging Mode] tab (☞ page 8)

● [Wakeup] tab (☞ page 28)

● [Buttons] tab (only for CF-P1P1 series) : Change the assignment of a program keys. (☞ page 27)

Customizing the Computer



Power

Power

Current battery charge status, the wireless signals on/off settings and automatic power off time setting.



Regional Settings

Regional Settings

Display methods of the region, number system, currency, time, and date.



Remove Programs

Remove Programs

Remove programs in storage memory.



Screen

Screen

Touchscreen alignment (☞ page 21), ClearType setting.

Connections



Beam

Beam

Enable or disable the function for receiving data via infrared communication.



Connections

Connections

Internet connection and Intranet connection settings (☞ page 35).



Wireless Ethernet

Wireless Ethernet (Only for the wireless model)

The wireless ethernet settings.

Dealing with Problems

Resetting Your Computer

When the computer fails to respond to an operation, reset your computer. There are two methods for resetting the computer.

CAUTION

Use only the provided stylus to push in the reset switch.

Do not push the reset switch with any other sharp-pointed objects, i.e. pencils, and ball point pens. The reset switch or other parts may become damaged.

Performing a Reset

This selection saves all stored records and entries and then restarts the computer.

Unsaved data in open windows may be lost.

If possible, turn off the computer and push the center of the reset switch straight in.

Push the reset switch within 1 second using the stylus.

Resetting the computer may cause the clock to malfunction.

After resetting the computer, check the time and correct the clock settings if necessary.

Reset Switch

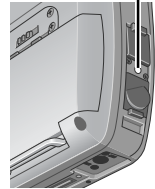

Performing a Full Reset

This selection erases all stored records and entries and then restarts the computer. Therefore, never perform a full reset unless a reset does not solve your problem.

(1) Using the provided stylus, push the center of the reset switch straight in for 1 second while holding down on the power switch.

(2) Tap the screen to set up your Pocket PC.

The Windows alignment screen is displayed.

(3) Align the touchscreen (☞ page 21 step 3).

(4) At [complete], tap the screen to begin using CF-P1.

If the [Panasonic Backup] screen is displayed, follow the on-screen instructions.

(5) Set the time and date.

Tap  - [Settings] - [System] tab - [Clock] to set the time and date, and tap [ok].

Dealing with Problems

Troubleshooting

Starting Up

CF-P1 does not turn on. Or, there is no display when CF-P1 is turned on.

- Check to see if a fully charged battery pack is properly installed.
- The power does not go on unless the AC adaptor is connected:
The battery level is too low. Charge the battery with the AC adaptor. (Make sure that the battery never discharges completely and that it is charged periodically.)
- Push the reset switch to restart CF-P1.
- Slide the latch to lock the battery pack cover all the way to the left.
- If the power does not turn on when the above operations are performed, the battery pack must be replaced.



Latch

The date and time are incorrect.

- You can set the date and time through [Clock] in  - [Settings] - [System] tab.
If you continue to experience problems, the backup battery maintaining the clock may need to be replaced. Contact Panasonic Technical Support.
- This computer will not correctly recognize the date and time starting from the year 2085 A.D.

CF-P1 shuts down automatically.

- The battery level may be too low. If the battery level goes below a certain threshold, CF-P1 automatically shuts down. In such cases, connect the AC adaptor and charge the battery.
- The computer may have entered a locked state. If this is the case, connect the AC adaptor and push the reset switch. Check the remaining battery level and make sure that multiple applications are not running simultaneously. Close all applications that are not being used.

The data cannot be copied.

- The computer may be turned off automatically while the data is being copied by beams or when using File Explorer. To prevent this, change the time setting to a longer time in  - [Settings] - [System] tab - [Power] - [Advanced] tab.

Alarm and Auto backup do not operate according to settings.

- It is possible that you were using 10 MB or more of storage memory, and that the power was turned off soon after making settings. In this case, wait a few minutes before turning off the computer.

Application Software

The computer locks up during the execution of an application, or the execution speed becomes noticeably slower.

- Connect the AC adaptor and push the reset switch. Check the remaining battery level and make sure that multiple applications are not running simultaneously. Close all applications that are not being used.
-

Display

It is hard to view the LCD.

- The LCD backlight may have automatically turned off due to the power-saving function. Turn on the LCD backlight by holding down the power switch until the backlight goes on.
 - Adjust the backlight brightness.
 - 1 Tap  - [Settings] - [System] tab - [Backlight].
 - 2 Tap the [Brightness] tab and adjust the brightness with the slider.
-

The cursor cannot be controlled.

- Push the reset switch to restart.
-

The cursor does not properly correspond to a stylus tap.

- Align the screen ( page 21).
-

Even when the CF-P1's power is switched off, only the power to the LCD turns off, but the power to the main unit remains on (input from the keyboard is still possible).

- Enable the Microsoft® ActiveSync® connection, and synchronize CF-P1 with the host computer. If this situation occurs frequently, tap  - [ActiveSync] - [Tools] - [Options] - [PC] tab to remove the checkmark from [Use mobile schedule to sync with this PC] and reset.
-

Connecting a Host PC

A host computer does not recognize CF-P1.

- Confirm that Microsoft® ActiveSync® 3.7 (or a later version) has been installed in the host computer.
 - Check to see if a fully charged battery pack is properly installed to CF-P1.
 - If a modem card has been inserted, disconnect these devices and check the communication status again.
 - Confirm that CF-P1's power is on.
 - Push the reset switch to restart.
 - If a cable or cradle is being used for the connection, recheck the connection to the host computer.
-

Dealing with Problems

Connecting Peripherals

Peripheral is not recognized even after driver is installed.

- Remove cards or other peripherals, and push the reset switch.
-

Network

Cannot connect to the network.

- Check the server information and network settings.
-

Sounds

Quality of recorded sound is poor.

- Tap  - [Settings] - [Personal] tab - [Input] - [Options] tab - [Voice recording format], and select a higher frequency.
-

Play sound is recorded even though the Mix playsound checkmark is off.

- Playsound (sound from the speaker) is being picked up and recorded by the microphone. If you want to avoid playsound recording completely, connect the headset or the headphone.
-

Noise in recording or playback sound.

- If a load is applied during recording or playback, for example when the SD memory card is disconnected or connected, then noise in the recording or playback will result. In this event, stop the recording or playback, and restart after closing other applications.
-

Program Buttons

The program assigned to the button does not start.

- When the program display of a start menu is changed after assigning a program, if you press a button, that program may not start. In that case, tap  - [Settings] - [System] tab - [Panasonic Settings] - [Buttons] tab, and re-assign the program.
-

Character Input < Only for CF-P1P1 series >

Entering characters

- Characters can be input using the input panel. (☞ page 23)
-

For Effective Use

Maintenance



LCD

Avoid using water when cleaning the panel. Ingredients included in water may leave residue and reduce readability of the screen.

<When cleaning dust/dirt>

Avoid rubbing off dust/dirt with cloth since it may leave scratch on the screen.

Sweep dust/dirt with fine brush, then wipe it with “dry” soft cloth used for cleaning glasses.

<When cleaning oily surface>

Apply camera lens cleaner on a soft gauze and clean it with gentle force. Then, wipe with dry soft cloth used for cleaning glasses.

Areas excluding the LCD

Wipe these areas with a soft cloth, after applying water or detergent diluted with water to the soft cloth and firmly wringing out excess water.

CAUTION

- Do not use benzene, thinner, or rubbing alcohol. Doing so may adversely affect the surface, e.g., discoloration. In addition, do not use commercially-available household cleaners and cosmetics, as they may contain components harmful to the surface.
- Do not directly add or spray water or detergent. If liquid enters the inside of the computer, it may cause the computer to work improperly or be damaged.

Specifications

Model No.		CF-P1P3 series	CF-P1P1 series	
CPU		Intel® XScale® PXA263 400MHz Instruction Cache Memory: 32 KB Data Cache Memory: 32 KB		
Memory (RAM/ROM)		64 MB (Max 128 MB)/ 64 MB (Flash)		
Video Memory		256 KB		
LCD	Type	3.5 type (Reflective color TFT with front light*1)		
	Displayed Colors	65536 colors (240 x 320 dots)		
Keyboard		38-key keyboard (QWERTY type)	23-key numeric keypad ("10-key" type)	
Pointing Device		Touchscreen, Cursor Control		
Slots	CF Card Slot	One Type I or Type II, Allowable current 3.3 V: 400 mA, 5 V: 400 mA		
	SD Memory Card Slot	SD memory card/MultiMedia Card		
Interface	Communication Port	IrDA 1.2 low power compliant, 115.2 kbps data transmission speed		
	Headset Jack	Miniature jack, 2.5 DIA		
Speaker		Monaural Speaker		
Microphone/Receiver		Built-in for supporting as Mobile Phone		
Sound		16-bit Stereo ADC/DAC, Sample Rate 48 kHz		
Battery	Battery Pack	Li-ion 7.4 V, 2.1 Ah		
		Operating Time*2	Approx. 10 hours - 32 hours	
		Charging Time*2	Approx. 3 hours	
	Sub-Battery	Lithium Rechargeable Backup Battery		
AC Adaptor *3	Input	100 V - 240 V AC, 50 Hz/60 Hz		
	Output	16 V DC, 2.5 A		
Operating System		Microsoft® Windows® Mobile™ 2003 software for Pocket PC		
Environment		In use	Temperature Humidity	-20 °C to 50 °C {-4 °F to 122 °F} 30 % to 80 % RH (No condensation)
		Not in use	Temperature Humidity	-25 °C to 60 °C {-13 °F to 140 °F} 30 % to 90 % RH (No condensation)

*1 In this manual, "front light" is described as "backlight".

*2 Varies depending on the usage conditions, backlight on/off, etc.

*3 <Only for North America>

The AC adaptor is compatible with power sources up to 240 V AC adaptor.

This computer is supplied with a 125 V AC compatible AC cord.

● Microsoft® ActiveSync® 3.7 System Requirements

Microsoft® Windows® XP, Microsoft® Windows® 2000, Microsoft® Windows® Millennium Edition, Microsoft® Windows NT® Workstation 4.0 with SP6 or later, or Microsoft® Windows® 98

Microsoft® Outlook® 98 or later required for synchronization to the desktop or portable computer of e-mail, calendar, contacts, tasks, and notes. (Microsoft® Outlook® 2002 recommended)

Microsoft® Internet Explorer 4.01 SP1 or later

Hard-disk drive with 12 to 65 MB of available hard-disk space (actual requirements will vary based on selection of features and user's current system configuration)

Available 9- or 25-pin communications port (adaptor required for 25-pin communications port), infrared port, or USB port (available for Windows® 98, Windows® Millennium Edition, Windows® 2000, and Windows® XP only)

One CD-ROM drive

VGA graphics card or compatible video graphics adapter at 256 color or higher

Keyboard

Microsoft® Mouse or compatible input device

● Options for Windows® XP, Windows® 2000, Windows® Millennium Edition, Windows NT® Workstation 4.0, or Windows® 98

Audio card/Speakers for sound

Microsoft® Office 97, Microsoft® Office 2000, or Microsoft® Office XP

Modem for remote synchronization

Ethernet LAN connection for remote synchronization

● Microsoft® Outlook® 2002 System Requirements

Hard disk space requirements will vary depending on configuration; custom installation choices may require more or less hard disk space.

245 MB of available hard disk space with 115 MB on the hard disk where the operating system is installed.

RAM requirements depend on the operating system used:

Windows® 98, or Windows® 98 Second Edition

24 MB of RAM plus an additional 8 MB of RAM for each Office program running simultaneously
Windows® Millennium Edition, or Microsoft® Windows NT®

32 MB of RAM plus an additional 8 MB of RAM for each Office program running simultaneously
Windows® 2000 Professional

64 MB of RAM plus an additional 8 MB of RAM for each Office program running simultaneously

LIMITED USE LICENSE AGREEMENT

THE SOFTWARE PROGRAM(S) ("PROGRAMS") FURNISHED WITH THIS PANASONIC® PRODUCT ("PRODUCT") ARE LICENSED ONLY TO THE END-USER ("YOU"), AND MAY BE USED BY YOU ONLY IN ACCORDANCE WITH THE LICENSE TERMS DESCRIBED BELOW. YOUR USE OF THE PROGRAMS SHALL BE CONCLUSIVELY DEEMED TO CONSTITUTE YOUR ACCEPTANCE OF THE TERMS OF THIS LICENSE.

Matsushita Electric Industrial Co., Ltd. ("MEI") has developed or otherwise obtained the Programs and hereby licenses their use to you. You assume sole responsibility for the selection of the Product (including the associated Programs) to achieve your intended results, and for the installation, use and results obtained therefrom.

LICENSE

- A. MEI hereby grants you a personal, non-transferable and non-exclusive right and license to use the Programs in accordance with the terms and conditions stated in this Agreement. You acknowledge that you are receiving only a LIMITED LICENSE TO USE the Programs and related documentation and that you shall obtain no title, ownership nor any other rights in or to the Programs and related documentation nor in or to the algorithms, concepts, designs and ideas represented by or incorporated in the Programs and related documentation, all of which title, ownership and rights shall remain with MEI or its suppliers.
- B. You may use the Programs only on the single Product which was accompanied by the Programs.
- C. You and your employees and agents are required to protect the confidentiality of the Programs. You may not distribute or otherwise make the Programs or related documentation available to any third party, by time-sharing or otherwise, without the prior written consent of MEI.
- D. You may not copy or reproduce, or permit to be copied or reproduced, the Programs or related documentation for any purpose, except that you may make one (1) copy of the Programs for backup purposes only in support of your use of the Programs on the single Product which was accompanied by the Programs. You shall not modify, or attempt to modify, the Programs.
- E. You may transfer the Programs and license them to another party only in connection with your transfer of the single Product which was accompanied by the Programs to such other party. At the time of such a transfer, you must also transfer all copies, whether in printed or machine readable form, of every Program, and the related documentation, to the same party or destroy any such copies not so transferred.
- F. You may not remove any copyright, trademark or other notice or product identification from the Programs and you must reproduce and include any such notice or product identification on any copy of any Program.

YOU MAY NOT REVERSE ASSEMBLE, REVERSE COMPILE, OR MECHANICALLY OR ELECTRONICALLY TRACE THE PROGRAMS, OR ANY COPY THEREOF, IN WHOLE OR IN PART.

YOU MAY NOT USE, COPY, MODIFY, ALTER, OR TRANSFER THE PROGRAMS OR ANY COPY THEREOF, IN WHOLE OR IN PART, EXCEPT AS EXPRESSLY PROVIDED IN THE LICENSE.

IF YOU TRANSFER POSSESSION OF ANY COPY OF ANY PROGRAM TO ANOTHER PARTY, EXCEPT AS PERMITTED IN PARAGRAPH E ABOVE, YOUR LICENSE IS AUTOMATICALLY TERMINATED.

TERM

This license is effective only for so long as you own or lease the Product, unless earlier terminated. You may terminate this license at any time by destroying, at your expense, the Programs and related documentation together with all copies thereof in any form. This license will also terminate effective immediately upon occurrence of the conditions therefore set forth elsewhere in this Agreement, or if you fail to comply with any term or condition contained herein. Upon any such termination, you agree to destroy, at your expense, the Programs and related documentation together with all copies thereof in any form.

YOU ACKNOWLEDGE THAT YOU HAVE READ THIS AGREEMENT, UNDERSTAND IT AND AGREE TO BE BOUND BY ITS TERMS AND CONDITIONS. YOU FURTHER AGREE THAT IT IS THE COMPLETE AND EXCLUSIVE STATEMENT OF THE AGREEMENT BETWEEN US, WHICH SUPERSEDES ANY PROPOSAL OR PRIOR AGREEMENT, ORAL OR WRITTEN, AND ANY OTHER COMMUNICATIONS BETWEEN US, RELATING TO THE SUBJECT MATTER OF THIS AGREEMENT.

About Intel® software products

The enclosed software products and documentation were developed at private expense, and are provided with “RESTRICTED RIGHTS.” Use, duplication or disclosure by the government is subject to restrictions as set forth in FAR 52.227-14 and DFARS 252.227-7013 et. seq. or its successor. The use of this product by the government constitutes acknowledgment of Intel's proprietary rights in the product.

Copyright

This manual is copyrighted by Matsushita Electric Industrial Co., Ltd. with all rights reserved. No part of this manual may be reproduced in any form without the prior written permission of Matsushita Electric Industrial Co., Ltd.

No patent liability is assumed with respect to the use of the information contained herein.

©2003 Matsushita Electric Industrial Co., Ltd. All Rights Reserved.

Disclaimer

Computer specifications and manuals are subject to change without notice. Matsushita Electric Industrial Co., Ltd. assumes no liability for damage incurred directly or indirectly from errors, omissions or discrepancies between the computer and the manuals.

Trademarks

Microsoft®, Windows®, Windows NT®, Outlook® and ActiveSync® are registered trademarks of Microsoft Corporation of the United States and/or other countries.

Mobile is a trademark of Microsoft Corporation of the United States and/or other countries.

Intel® and Pentium® are registered trademarks of Intel Corporation.

Panasonic® is a registered trademark of Matsushita Electric Industrial Co., Ltd.

Panasonic Computer Solution Company,

50 Meadowlands Parkway, Panazip 2F-5,
Secaucus, NJ 07094

Panasonic Canada Inc.

5770 Ambler Drive Mississauga,
Ontario L4W 2T3

PANASONIC U.K.LTD (PUK)

WILLOUGHBY ROAD,BRACKNELL,BERKSHIRE,
RG12 4FP

© 2004 Matsushita Electric Industrial Co., Ltd. All Rights Reserved.

Printed in Japan

SS1103-2064
DFQX5434YB



Free Manuals Download Website

<http://myh66.com>

<http://usermanuals.us>

<http://www.somanuals.com>

<http://www.4manuals.cc>

<http://www.manual-lib.com>

<http://www.404manual.com>

<http://www.luxmanual.com>

<http://aubethermostatmanual.com>

Golf course search by state

<http://golfingnear.com>

Email search by domain

<http://emailbydomain.com>

Auto manuals search

<http://auto.somanuals.com>

TV manuals search

<http://tv.somanuals.com>