

## Operating Instructions

### Instrucciones de Uso Mode d'emploi

---

## Household Massage Lounger Sillón de Masaje Doméstico Fauteuil vibromasseur

---

Model No./Nº de Modelo/Nº de modèle **EP-MA70**

---

---

---

<b>English</b>	1
<b>Español</b>	S1
<b>Français</b>	F1

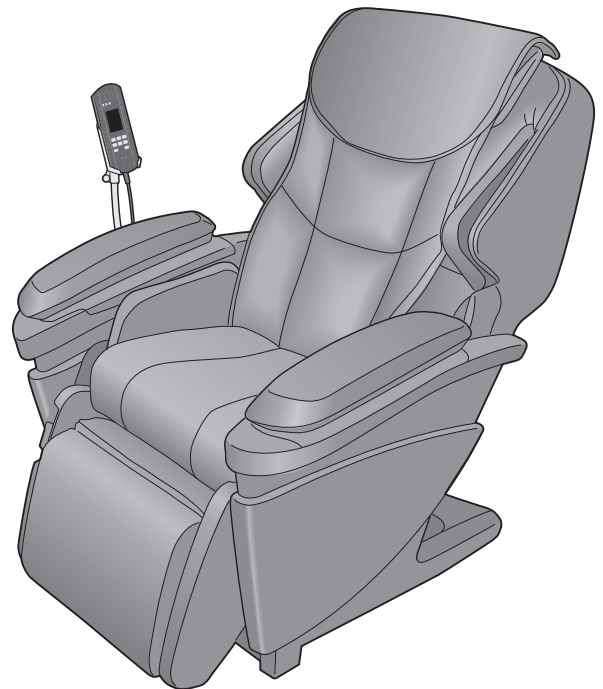

Before operating this unit, please read these instructions completely.  
Specifications and shapes of massage loungers may vary depending on the model.

Antes de utilizar esta unidad, lea completamente estas instrucciones y guárdelas para referencia futura. Las especificaciones y el tipo de las mecedoras de masaje podrían variar dependiendo del modelo.

Avant d'utiliser cet appareil, nous vous recommandons de lire l'ensemble de ces instructions et de les ranger dans un endroit accessible pour une consultation ultérieure. Caractéristiques et formes des fauteuils de massage pourraient varier selon les modèles.



# IMPORTANT SAFETY INSTRUCTIONS

Basic precautions should always be followed when using an electrical unit, including the following.

Please ensure that you read all instructions before using the Household Massage Lounger.

## **DANGER** – To reduce the risk of electric shock:

1. Always unplug this unit from the electrical outlet immediately after using and before cleaning.

## **WARNING** – To reduce the risk of burns, fire, electric shock, or injury to persons:

1. Always insert the power plug all the way into the outlet to reduce the risk of short-circuit and fire.
2. The unit should never be left unattended when plugged in. Always unplug the unit when not in use.
3. The unit is not to be used by people who cannot move or communicate on their own.
4. Only use the unit for the purpose described in these instructions.
5. Do not stand on the unit.
6. Do not use any accessories other than those recommended by the manufacturer.
7. Always return the seat to the upright position and make sure the legrest is completely retracted. Be careful that nothing is obstructing the legrest while retracting. Keep children away from the legrest.
8. Never operate the unit if it has a damaged power cord or plug. Return the unit to the nearest authorized service center if it is not working properly, if it has been dropped or damaged, or if it has been immersed in water.
9. Keep power cords away from heated surfaces. Do not carry the unit by the power cord.
10. Never block the air openings during operation and make sure that all air openings are kept free of lint and hair, etc. Do not drop or insert anything into any of the openings of the unit.
11. Do not use the unit on top of heating appliances, such as electric carpets, etc. Do not operate the unit under blanket or pillow. Excessive heating can occur and cause fire, electric shock, or injury to persons.
12. Do not use the unit in bathrooms or other damp or humid places as this may cause electric shock or cause the unit to malfunction. Do not spill water, etc. onto the controller.
13. Do not use the unit outdoors.
14. Do not use or operate where aerosol spray products are being used or where oxygen is being administered.
15. When unplugging the unit, turn off all controls before removing the plug from power outlet. Do not use the unit with a transformer as this may lead to malfunction or electric shock.
16. Connect this unit to a properly grounded outlet only. See Grounding Instructions.
17. Use heated surfaces carefully. May cause serious burns. Do not use over insensitive skin areas or in the presence of poor circulation. The unattended use of heat by children or incapacitated persons may be dangerous.
18. Always raise the comfort cushion to check that the fabric of the unit itself has not been ripped before using the unit. Please also check other areas to ensure that the fabric has not been ripped. No matter how small the rip, if you find one then immediately stop using the unit, unplug the power cord and have the unit repaired at an authorized service center.

## SAVE THESE INSTRUCTIONS

# SAFETY PRECAUTIONS

## CAUTION: To avoid the risk of injury:

1. Persons with any of the conditions listed below or who are undergoing medical treatment or suffer from medical conditions should consult with their physicians before using the unit:
  - a) Pregnant women, people who are ill, in poor physical shape.
  - b) People suffering from back, neck, shoulder, or hip pain.
  - c) People who have a pacemaker, defibrillator, or other personal medical devices prone to electronic interference.
  - d) People suffering from heart disease.
  - e) People who are prohibited from receiving massage by a physician due to thrombosis or aneurism, acute varicose veins, or other circulatory disorders.
  - f) People with irregular curvatures of the spine.
  - g) People who have a loss of heat sensation.
2. This unit should not be used by children. Remove the key when not in use and store out of reach of children.
3. Sit down slowly after checking the position of the massage heads. Never put any part of your body between the massage heads as the squeezing action of the massage heads may cause injury. Never put your fingers or feet in the gap between the backrest and seat, the backrest and the armrest, the seat and cover under the armrest, or the gap between the legrest and the footrest. Do not place your fingers or any part of your body in the mechanism below the legrest, or between the legrest and footrest.
4. Do not use the unit against bare skin. While thin clothing may increase effectiveness, exposing the skin directly to the massager may irritate the skin.  
Do not use the unit while wearing anything hard on your head like a hair accessory, etc. Do not use the unit for massaging the head, abdomen, front neck, elbows or knees.  
Do not use excessively strong massage action on the back of the neck.
5. When using the body scanning function, always ensure that the shoulder position is correct. If the shoulder position is not correct, use the POSITION button to adjust it properly. Or stop the massage function and re-try the body scanning function. You can adjust the shoulder position in this way in the auto program and manual operation. Failure to align the shoulder position correctly can lead to injury.
6. Do not stretch the back muscles for more than approximately 16 minutes at a time. To avoid overstretching the muscles which may result in discomfort, do not use the unit for more than 5 minutes when first using it. You can gradually increase the duration and strength of the massage as you become used to it.  
Do not massage any one point for more than 5 minutes at a time.  
Excessive massaging can overstimulate the muscles and nerves and result in an adverse effect.  
To prevent excessive massaging, do not use the massager for more than a total of 16 minutes each session.  
After approximately 16 minutes, the massage heads will be retracted and stop moving.  
The back cushion can be removed if you want to experience a stronger back massage. Exercise extreme care when you use this mode in order to avoid back pain or injury. Use only for short periods of time (no more than 16 minutes).  
Reinstall the back cushion if you want to restore to normal massage intensity.
7. While using the massager, if you start feeling sick or if the massage seems painful, stop using it immediately. While using the massager, if the pressure seems too strong, the movement of the massage heads can be stopped at any time by pressing the Quick Stop button.
8. Do not go to sleep while using the unit. Do not use the unit after drinking alcohol.
9. When the seat back is in a reclined position, do not sit on it or sit with your legs resting on the headrest.  
Do not sit on the legrest as the unit may fall over.
10. Do not allow children or pets to play on or around the unit, especially during operation.
11. Do not unplug the unit or turn it off during operation. Unplug the unit immediately if there is a power outage.
12. Be sure to start on the gentle massage program if using the massager for the first time. The shiatsu massage is stronger and should be enjoyed after one has gotten accustomed to the chair.
13. Do not allow children to play on this mechanized furniture or operate the mechanism. Legrest folds down on closing so that a child could possibly be injured. Always leave in an upright and closed position. Keep hands and feet clear of mechanism. Only the occupant should operate it.
14. Remove hard objects, such as false fingernails, wristwatches or rings, when massaging hands or arms.  
Empty pockets of hard objects when massaging the area of the seat or thighs.

15. Always raise the comfort cushion to check that the fabric of the unit itself has not been ripped before using the unit. Please also check other areas to ensure that the fabric has not been ripped. No matter how small the rip, if you find one then immediately stop using the unit, unplug the power cord and have the unit repaired at an authorized service center.
16. People with any of the conditions listed below should not use the Hip program:
  - 1) People suffering from acute lumbago, spinal disc herniation, or misalignment of the vertebrae
  - 2) People with hip joint problems such as hip osteoarthritis
  - 3) People with osteoporosis
  - 4) People who felt numbness or listlessness in the legsIt may worsen the symptoms.
17. Sit on the unit after confirming there is no foreign matter between the parts of the unit. (Confirm that there are no foreign objects stuck in the back cushion, legrest or hand/arm massage section.)  
Sit down and ensure that the legrest is properly locked in place.  
Failure to observe this precaution may result in accident or injury.
18. Always return the legrest to its original position before moving the unit.  
Failure to observe this precaution may result in injury due to the legrest returning to its original position when the unit is being moved.
19. Store the attachment screws out of reach of children.  
Accidental ingestion may occur.
20. Do not stand, jump on, or place objects on the seat until the air is completely extracted for the air massage.
21. When "Heat" massage heads are used, do not let the massage heads touch the same place for a long time.  
Low-temperature burn may occur.
22. Do not hold on the legrest leg/sole massage section when moving the unit.  
If this is not observed, the section may slide as you move the unit, and injuries may occur.
23. Do not drag or push the unit in an installed state.  
Protect your floor (place a mat or similar) when moving the unit on its wheels to avoid damage to your floor.

# OPERATING PRECAUTIONS

## CAUTION: To avoid damaging the chair, follow these precautions:

1. The chair is designed for a maximum user weight of 264 lbs (120 kg). Exceeding the maximum weight may cause permanent damage to the massage mechanism and/or other components of the unit. Any such damage is deemed to be user abuse and is not covered under the Limited Warranty.
2. Do not sit on or drop the controller. Do not pull the controller cord or the power cord. Be careful not to catch the cord of the controller between the armrest and the chair back.
3. Do not treat the chair roughly, such as turning the chair on its side, turning the chair over or standing on it.
4. Do not treat the covering roughly.
  - Keep sharp or pointed objects away from the covering of the chair. Be careful not to drop lit ashes, lit cigarettes or matches on the chair.
  - Exposure to direct sunlight can cause fading or a change in color of the covering.
5. If the massager functions abnormally, immediately turn off the power and have the massager checked by an authorized service center.
6. Do not repeatedly operate any switch at short intervals. Such action may cause the switch to malfunction.
7. Some noise may be heard coming from the massager while in use. This is due to the structure of the massager and is normal.
8. Make sure there are no obstacles behind the chair before reclining it. The chair can be reclined to a maximum angle of 170°. If the back hits a wall or pillar, the chair may malfunction. Be sure to have ample space behind the chair. Recline the chair slowly in order to avoid contact with an obstacle.
9. When excessive pressure is applied to the massage heads, they may stop moving for safety. When moving the heads up from the lowered position, one's body weight may stop the heads' movement. In such a case, slightly raise your body and allow the massage heads to move up.
10. After each massage, slide the power switch, which is located on the right side of the chair, to the "off" position and turn its lock switch to the "lock" position and remove the key and power plug.
11. Do not sit on the chair with wet body or hair.
12. The unit must not be used in "wet rooms" (sauna, swimming pool) or outdoors.
13. Do not attempt to open or disassemble any part of the unit. Only use an authorized Panasonic servicer to fix your unit.
14. Always hold the power plug, not the power cord, when unplugging it from a socket. Failure to observe this precaution may result in electric shock or short-circuit.

# GROUNDING INSTRUCTIONS

This product must be grounded. If it should malfunction or break down, grounding provides a path of least resistance for electric current to reduce the risk of electric shock. This product is equipped with a cord having an equipment-grounding conductor and a grounding plug. The plug must be plugged into an appropriate outlet that is properly installed and grounded in accordance with all local codes and ordinances.

## **⚠ DANGER**

Improper connection of the equipment-grounding conductor can result in a risk of electric shock. Check with a qualified electrician or serviceman if you are in doubt as to whether the product is properly grounded. Do not modify the plug provided with the product – if it will not fit the outlet, have a proper outlet installed by a qualified electrician.

This product is for use on a nominal 120-volt circuit and has a grounding plug that looks like the plug illustrated in Figure A. Make sure that the product is connected to an outlet having the same configuration as the plug. No adapter should be used with this product.

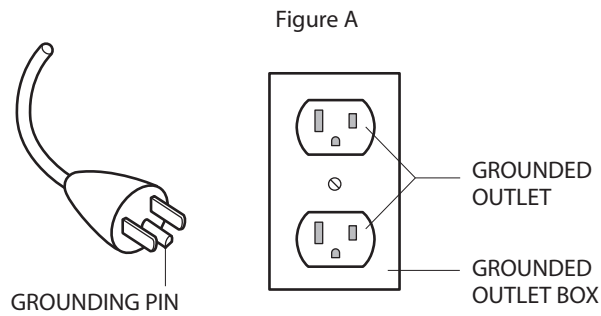

# SPECIFICATIONS

<b>Power Supply:</b>	AC 120 V 60 Hz
<b>Rated Current:</b>	2.5 A (Electric heating equipment 0.5 A)
<b>Upper Body Massage</b>	
Massage area (Up-Down):	Approx. 30.7 in. (78 cm) (The massage heads move a total of approx. 24.4 in. (62 cm))
Massage area (Left-Right):	Distance between massage heads during operation (massage width adjustable) Neck, Shoulder, Back, Lower back: Approx. 2.8 in. - 8.3 in. (7cm - 21cm) Distance between massage heads (including width of massage heads) during back roll and up-and-down movement: Approx. 2.8 in. - 6.7 in. (7cm - 17cm)
Massage area (Forward-Back):	Protrusion of massage heads (adjustable) Approx. 4 in. (10 cm)
Massage speed:	Tap: Approx. 190 cycles/minute – 520 cycles/minute (single side) Full roll: Approx. 36 seconds – 91 seconds (both ways) Other than the above: approx. 4 cycles/minute – 50 cycles/minute
<b>Air massage</b>	
Air Pressure (Calf):	Level 3: Approx. 32 kPa Level 2: Approx. 28 kPa Level 1: Approx. 16 kPa * It may vary with the area slightly.
<b>Reclining angle:</b>	Backrest: Approx 120° – 170° Legrest (Leg/sole massage section): Approx 5° – 85° Legrest (Flat section): Approx 15° – 95°
<b>Automatic shut-off:</b>	Automatically turns off after approx. 16 minutes
<b>Dimensions</b>	
When not reclined (H × W × D):	Approx. 45.3 in. × 37.4 in. × 48 in. (115 cm × 95 cm × 122 cm)
When reclined (H × W × D):	Approx. 26 in. × 37.4 in. × 79.6 in. (66 cm × 95 cm × 202 cm)
<b>Weight of Unit:</b>	Approx. 191.8 lbs (87 kg)
<b>Dimension of box (H × W × D):</b>	Approx. 28.7 in. × 30.7 in. × 63 in. (73 cm × 78 cm × 160 cm)
<b>Weight in box:</b>	Approx. 218.3 lbs (99 kg)
<b>Maximum user weight:</b>	Approx. 264 lbs (120 kg)
<b>Minimum distance from wall:</b>	16 in. (40 cm)

For those who weighing 221 lbs (100 kg) or more, the product operations may make more noise and the fabric cover may wear faster.

# Part names and functions

## Main unit

Front

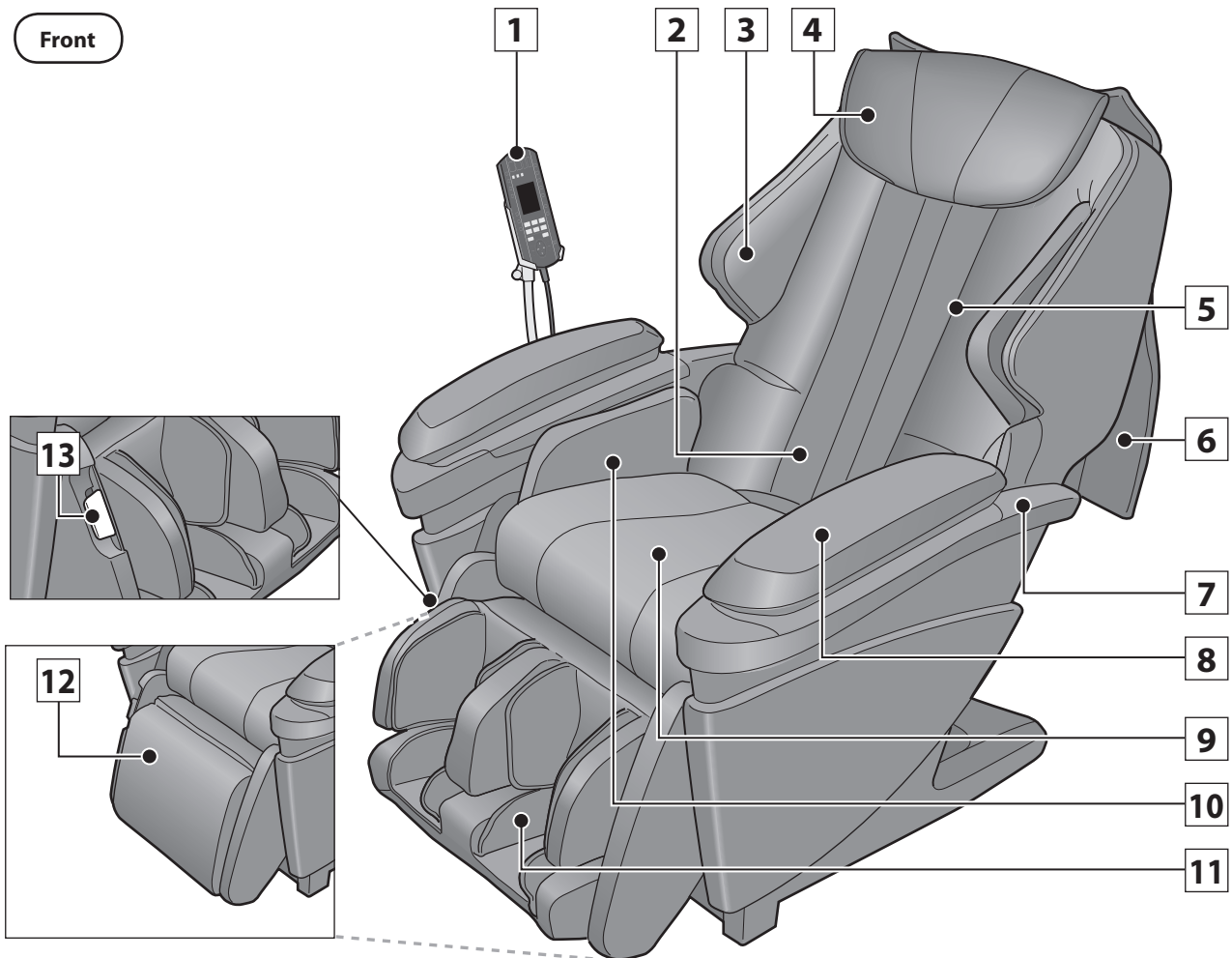

- 1 Controller**  
• See pages 9 –10.
- 2 Retracted position of massage heads**
- 3 Shoulder side massage section**  
• Includes integrated air massage function.
- 4 Pillow**
- 5 Backrest**  
• Massage heads:  
- Includes integrated massage heads.  
- Includes "Heat" massage heads.  
• Air bag for Lower Back massage is built in.
- 6 Comfort cushion**
- 7 Armrest**  
• Moves with the backrest.
- 8 Hand/Arm massage section**  
• Includes integrated air massage function.
- 9 Seat**  
• Air bag for Seat/Thigh massage is built in.

- 10 Seat/Thigh side massage section**  
• Includes integrated air massage function.

- 11 Legrest Leg/Sole massage section**  
• Includes air massage function.  
• Position can be adjusted by the leg slide.

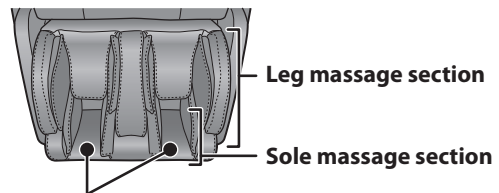

- Sole Shiatsu Sheet (Removable.)

- 12 Legrest flat section**  
• Use the unit as a comfort chair by rotating and storing when not using for massaging.

- 13 Lever for legrest rotation**  
• Rotate the legrest manually while pulling the lever.  
(Flat section ⇔ Leg/Sole massage section)



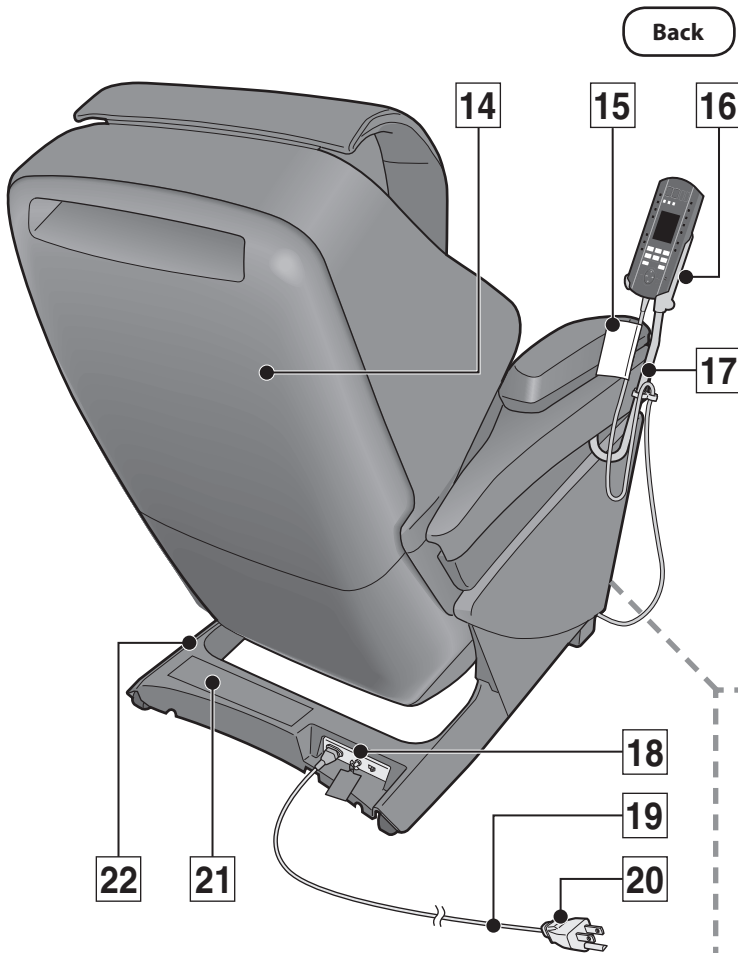

Back

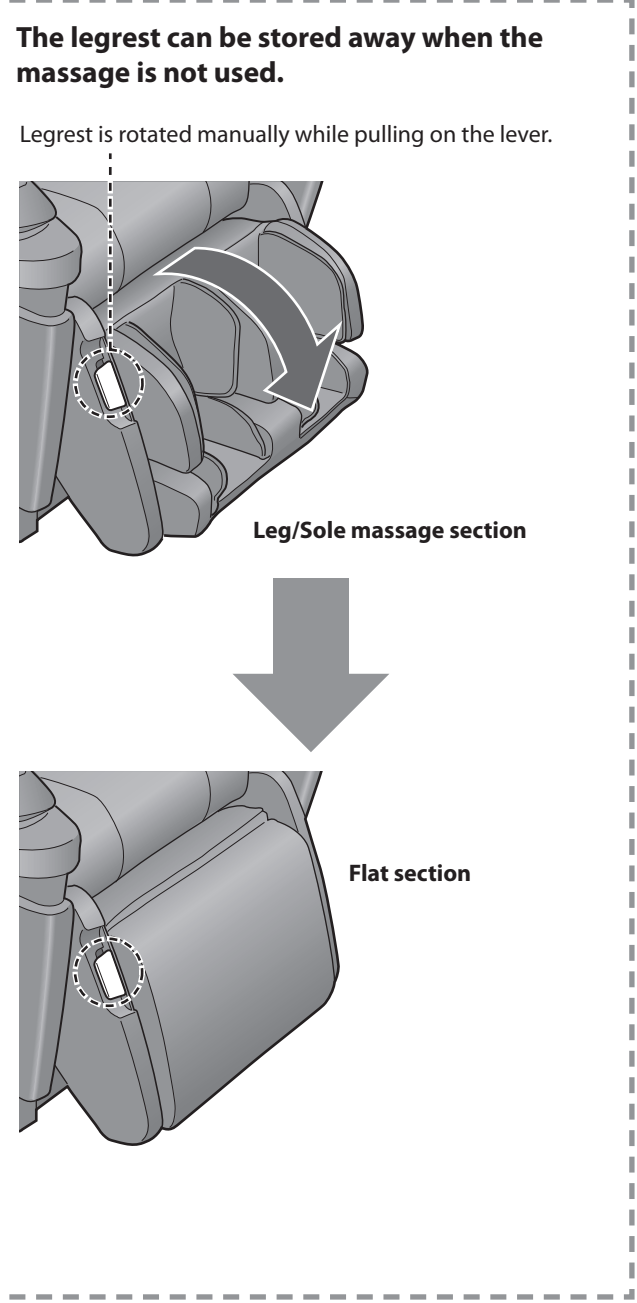

The legrest can be stored away when the massage is not used.

Legrest is rotated manually while pulling on the lever.

**14** Back Cover

**15** Child Safety Label

**16** Controller Holder

**17** Controller Stand

**18** Power switch section

- See pages 14 and 17.
- Lock switch is set to "open" and power switch is set to "on" prior to leaving the factory.

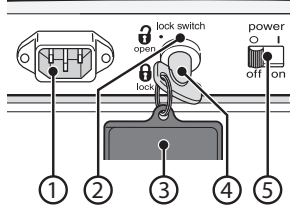

**1** Appliance Inlet

**2** Lock Switch

**3** Lock Switch Key Tag

- To prevent children from accidentally swallowing the lock switch key.

**4** Lock Switch Key

**5** Power Switch

**19** Power Cord

**20** Power plug

**21** Safety Precaution Label

**22** Leg cover

Leg/Sole massage section

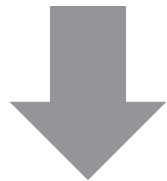

Flat section

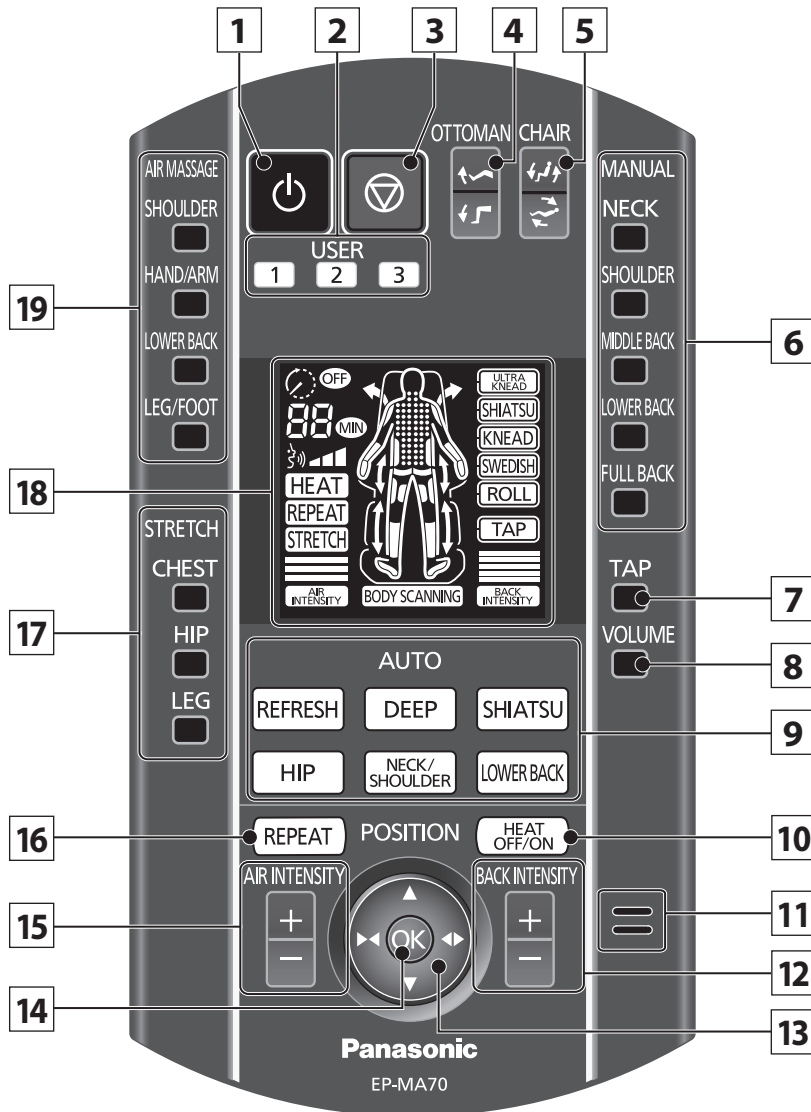

- |  |   |
|--|---|
| <p><b>1 On/Off</b></p> <p><b>2 User Memory</b><br/>• See pages 24–25.</p> <p><b>3 Quick Stop</b><br/>• Press this button to stop the massage immediately.</p> <p><b>4 Ottoman Angle Adjustment</b></p> <p><b>5 Reclining Angle Adjustment</b></p> <p><b>6 Manual Operation</b><br/>• See page 27.</p> <p><b>7 Add Tapping massage</b><br/>• See page 29.</p> <p><b>8 Voice Guidance Volume</b><br/>• See page 42.</p> <p><b>9 Program Selection</b><br/>• See page 20.</p> <p><b>10 “Heat” Massage Heads On/Off</b><br/>• See page 26.</p> | <p><b>11 Speaker</b></p> <p><b>12 Back Intensity Adjustment</b><br/>• See page 23.</p> <p><b>13 Position</b><br/>• See page 21.</p> <p><b>14 Confirmation</b></p> <p><b>15 Air Massage Intensity Adjustment</b><br/>• See page 23.</p> <p><b>16 Repetition</b><br/>• See page 23.</p> <p><b>17 Stretch On/Off</b><br/>• See page 30.</p> <p><b>18 Display</b><br/>• This illustration shows all features highlighted.<br/>• See page 10.</p> <p><b>19 Air On/Off</b><br/>• See page 30.</p> |
|--|---|

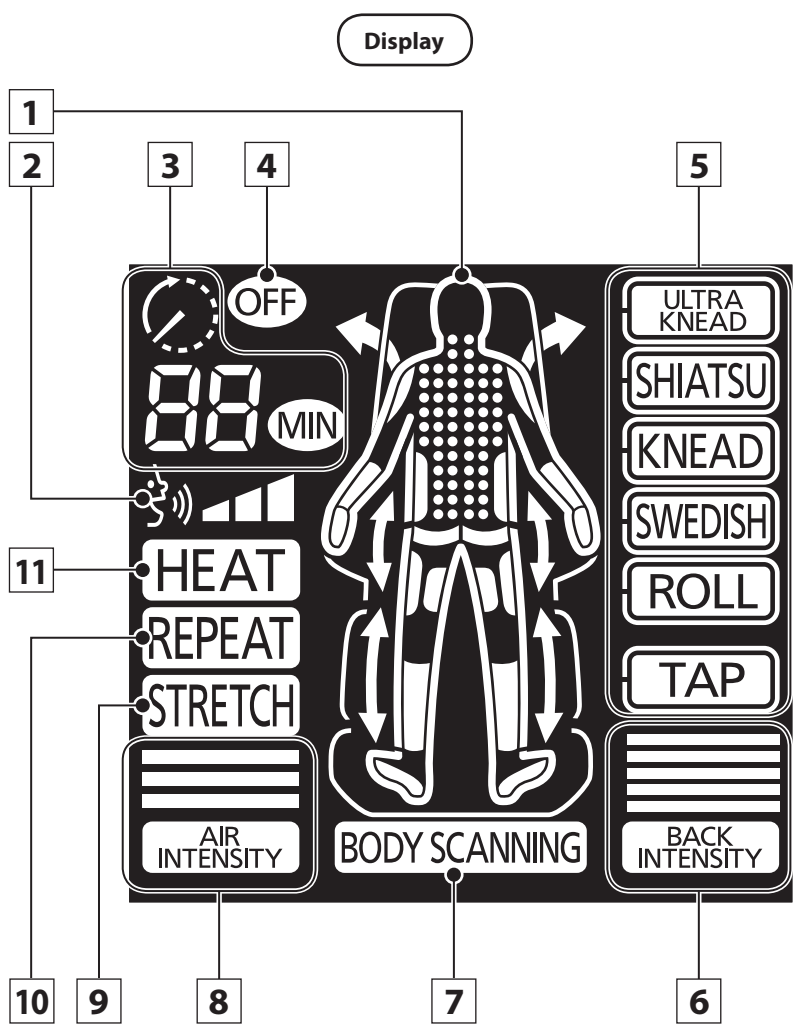

**1 Massage Area**

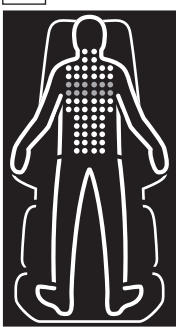

Current approximate massage position flashes.

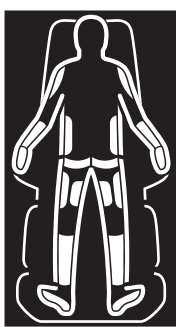

Currently selected air massage operation lights up. Current air massage position flashes.



Currently selected stretch operation lights up. Current stretch position flashes.

**2 Voice Guidance Volume**

**3 Time Remaining**

**4 Massage Ending**

**5 Operation**

- Currently performing massage operation is displayed while massaging.
- Currently selected operation's frame is flashed when Manual Operation is selected.

**6 Massage Intensity**

**7 Body Scanning**

**8 Air Intensity**

**9 Stretch**

**10 Repeat**

**11 "Heat" Massage Heads**

# Setting up the massage lounge

## 1 Where to use the unit

- Ensure adequate space to recline.
  - Do not expose the massage lounge to direct sunlight or high temperatures, such as in front of heating sources, because this can cause discolouration or hardening of the synthetic leather.
  - Place the unit on a mat to prevent floor damage.
  - When placing a mat under the unit, the size of the mat should be sufficient [at least 47.2 in. × 27.6 in. (120 cm × 70 cm)] to cover the areas where the unit touches and where the legrest could touch the floor, as shown in the diagram on the right.
  - Install the unit near a power socket.
- ⚠ See Warning No. 11 and 12 on page 1, and Caution No.23 on page 3.

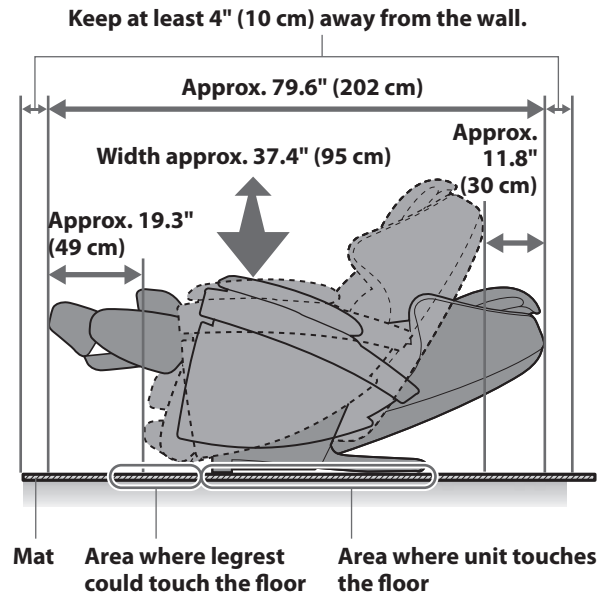

## 2 Installing the unit

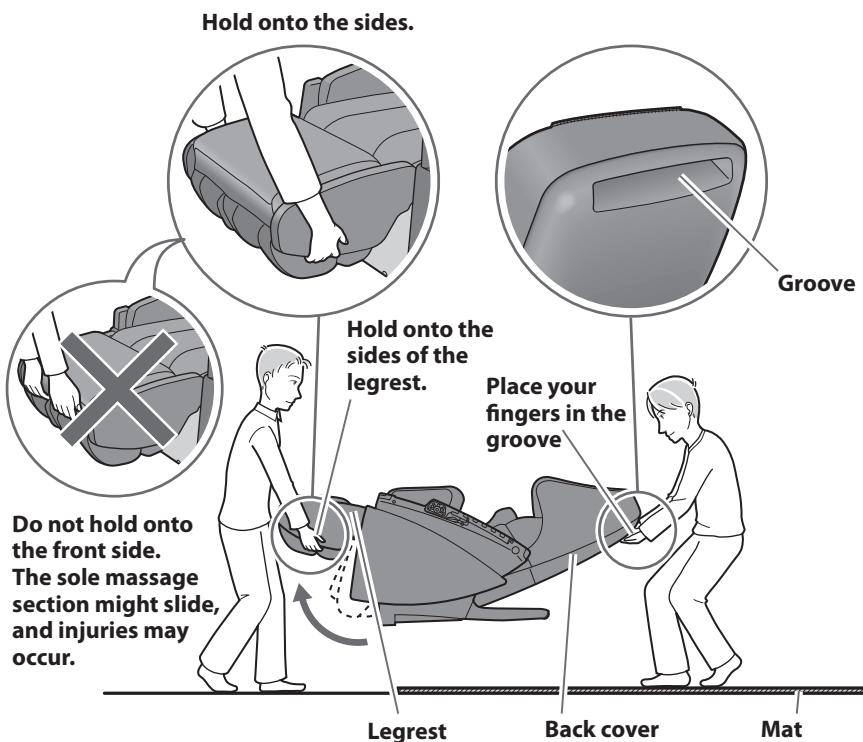

- Since the unit is very heavy [approximately 191.8 lbs (87 kg)], be careful to avoid back injuries. (The unit must be carried by two or more persons.)

### To put the unit down on the floor

- Put the unit down slowly and carefully watch your step.
- Put down the legrest by holding it with your hands until it has been set on the floor completely. If you release your hands before the legrest is fully extended, the legrest will forcefully return to the initial position.
- The floor may get damaged, so it is recommended to place a mat etc. on the floor.

⚠ See Caution No.22 and 23 on page 3.

**Confirm that the main unit and all accessories are in the box.**

**Main unit**

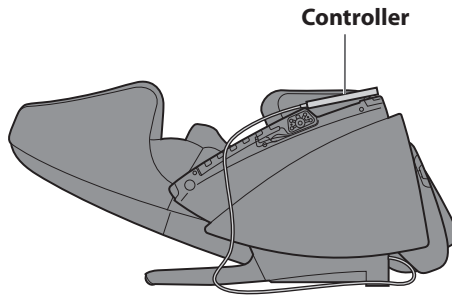

**Accessories**

**Armrests (Right/Left)**

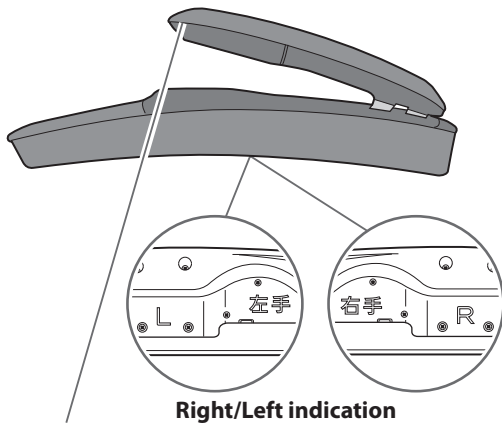

• Small holes on the inside fabric are an intentional part of the functional design.

**Attachment Screws**  
(M6 × 13) — Black 4 pcs.



(M6 × 20) — Silver 2 pcs.



**Allen Key**

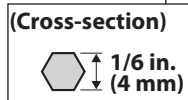

**Comfort cushion**

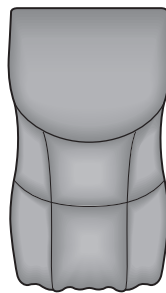

**Pillow**



**Sole Shiatsu Sheet**

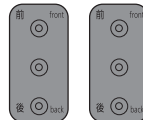

• This is pre-installed on the sole massage section.

**Controller Stand**

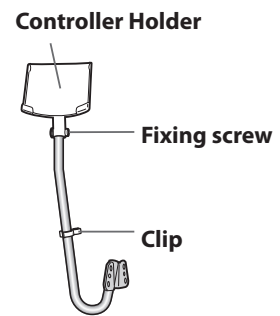

**Power Cord**

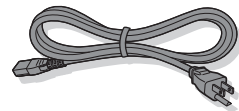

**Lock Switch Key**



• This is initially inserted in the lock switch of the power switch section.

# Assembly

## 1 Attaching the controller stand to the right or left side panel

### Fasten the controller stand with the attachment screws. (4 positions)

Use this screw: Attachment screws (M6 × 13)

 × 4 pcs. (Black)

#### How to tighten the screws

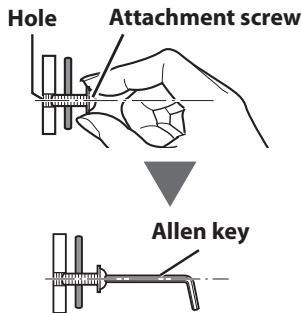

- Tighten the 4 screws lightly using your fingers. (Make the screws level with the holes.)

- Tighten firmly with the allen key.
- Screw may be damaged if you tighten the screw inserted into the hole crookedly using an allen key.

<When attaching on the right side panel>

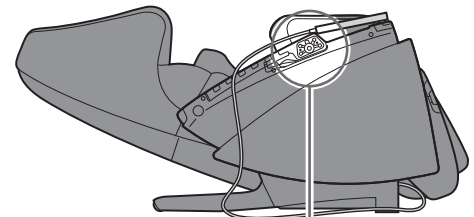

- Align the 2 prongs of the side panel with the holes of the controller stand.

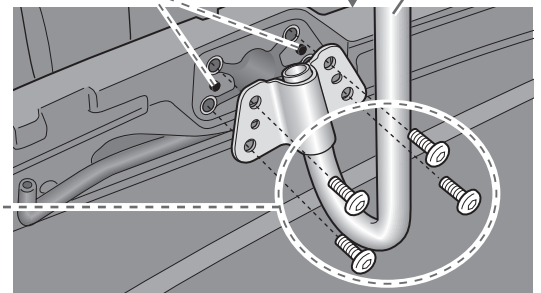

## 2 Fasten the armrest with the attachment screws. (On both sides)

### 1 Insert the armrest into the unit.

- "R" (right side) and "L" (left side) are indicated at the bottom of the armrest.
- Insert the armrest from the top aligning the ▲ marks on the side of the armrest.
- Be careful to avoid pinching your fingers or the air plugs.

### 2 Slide the armrest toward the front while pushing it downward.

### 3 Fasten the armrest with the attachment screws. (One position for each side)

Use this screw: Attachment screws (M6 × 20)

 × 2 pcs. (Silver)

<When attaching the right armrest>

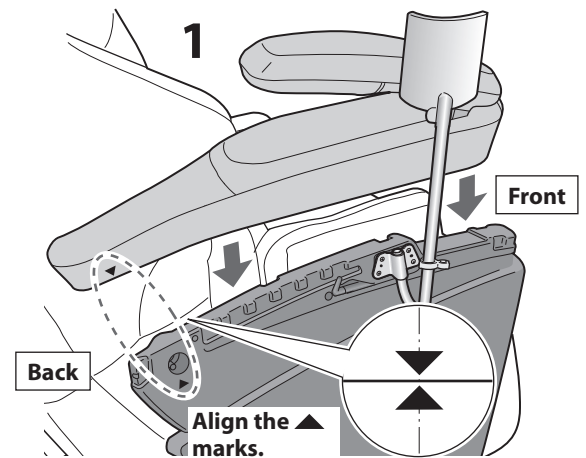

#### How to tighten the screws



- Put an attachment screw on the edge of the allen key and tighten the screw horizontally to the hole.
- Screw may be damaged if you tighten the screw inserted into the hole crookedly using an allen key.

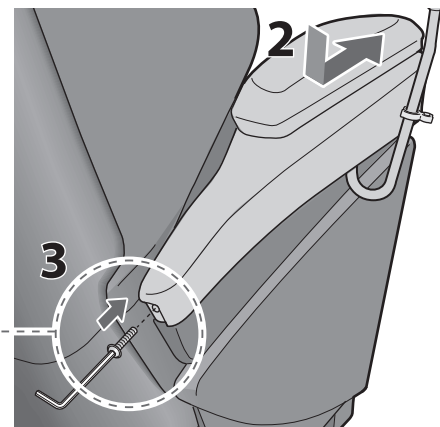

### 3 Connecting the air plugs (On both sides)

- Insert the air plugs into the lower part of the armrest.
- \* Arm massage will not operate unless the air plugs are inserted securely.

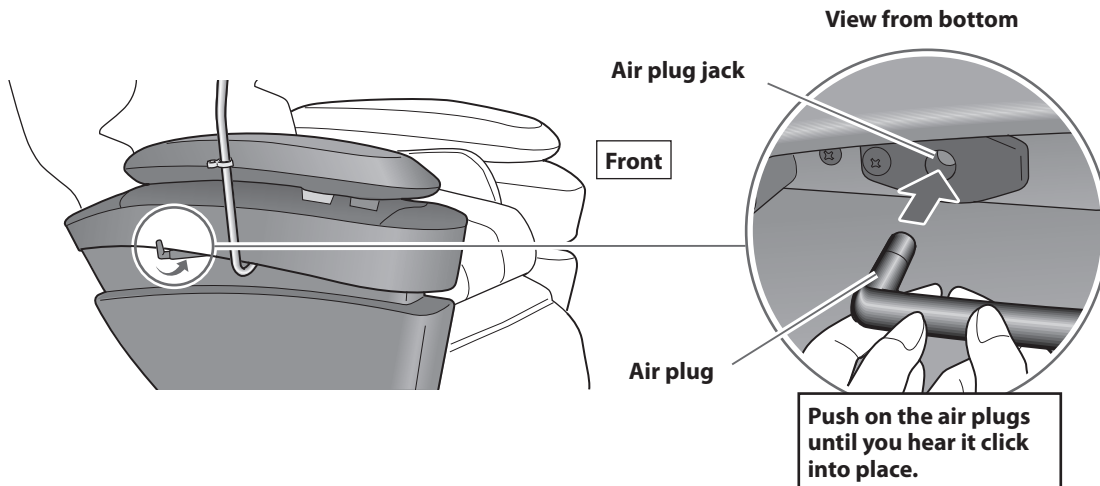

### 4 Connect the power cord to the unit

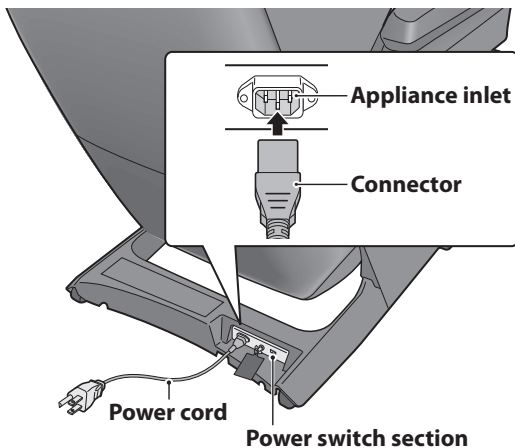

- 1 Check for dirt and damage on appliance inlet of the power switch section and the connector of the power cord.**
- 2 Insert the connector into the appliance inlet.**
- 3 Be sure to push the connector in all the way.**

### 5 Raising the backrest to the upright position

- 1 Insert the power plug into the power socket.**

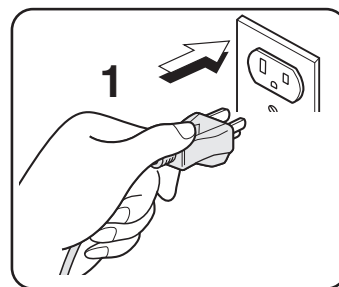

- 2 Confirm the lock switch key is set to the "open" position.**
- 3 Confirm the power switch is set to the "on" position.**
- 4 Press  button on the controller twice.**

- Press once, and then press again approx. 1 second later.
- Backrest will rise automatically.

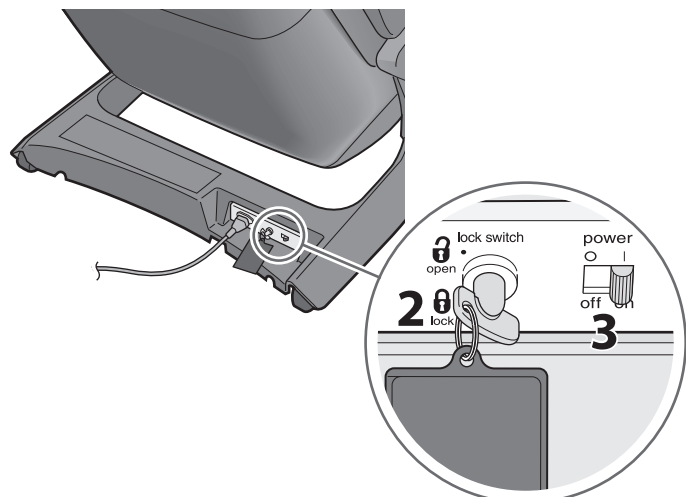

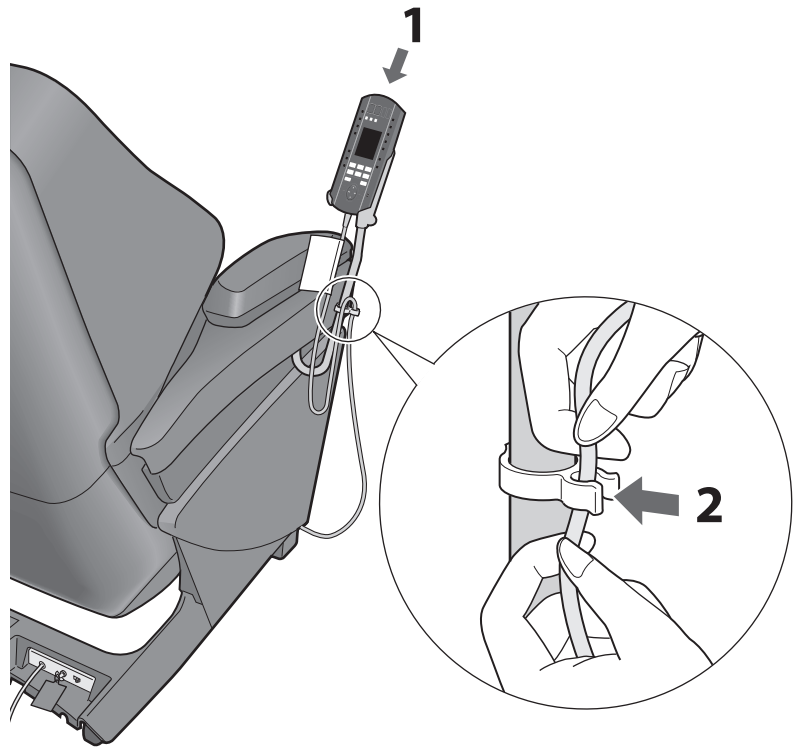

## 6 Placing the controller

- 1 Placing the controller into the controller stand.**
- 2 Fasten the controller cord using the clip.**
  - Fasten so the cable under the clip will not sag too much with the backrest raised. (Because there is a chance of your legs, etc., getting caught)



### When the controller stand is attached on the left side

- Run the controller cord to the left.

- 1 Press the  button on the controller to turn on the power.**
- 2 Press  button on the controller and hold until the legrest has risen far as it will go.**
  - Continue pressing until a “beep-beep-beep” sound is heard.

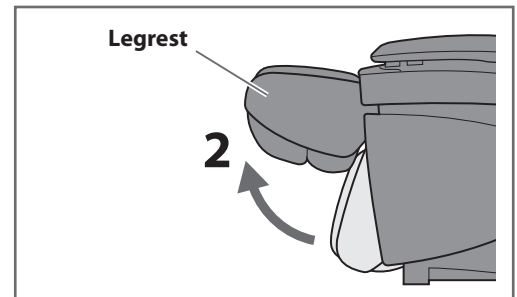

- 3 Disconnect the controller cord.**
  - Hook is released by pressing on the tab on the fastening band with your fingers.

- 4 Move the controller cord under the legrest to the left side.**

- 5 Fasten the controller cord.**
  - Press down from the edge if it does not fit in easily.

- 6 Insert the tip of the fastening band into the hole.**

- The controller cord is fastened to the right side prior to leaving the factory.

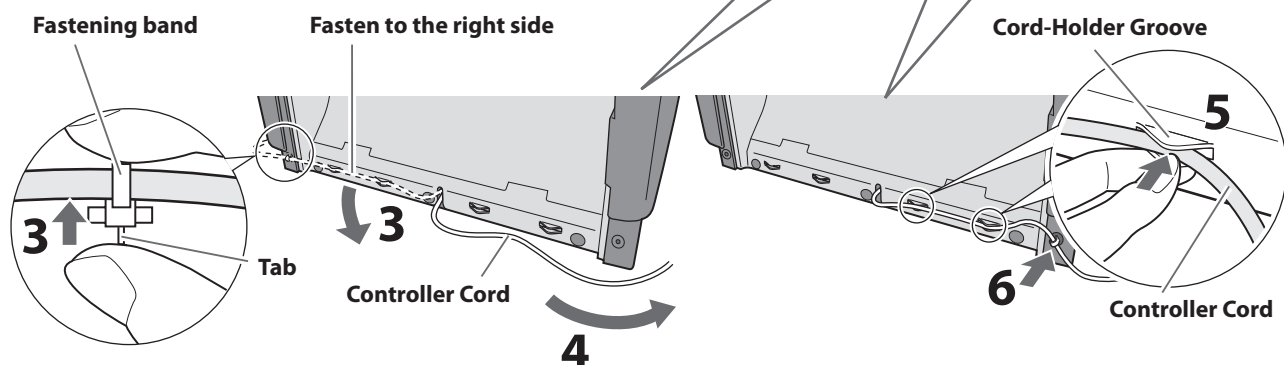
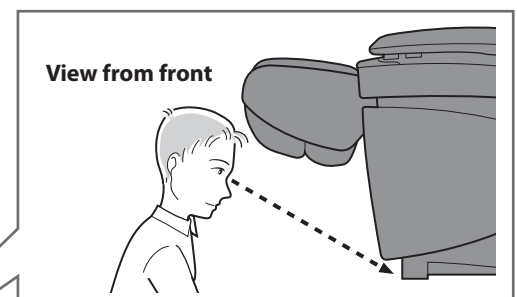



## 7 Fasten the pillow and the comfort cushion.

### 1 Fasten the pillow using the fasteners.

- See page 19 for guidelines on positioning the pillow during the massage.

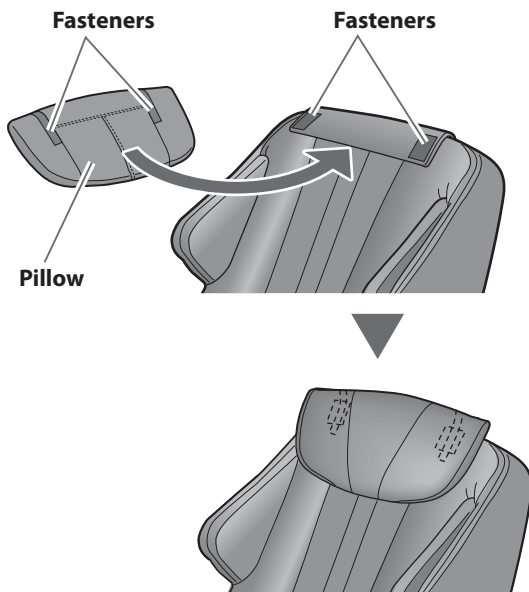

### 2 Fasten the comfort cushion using the zip.

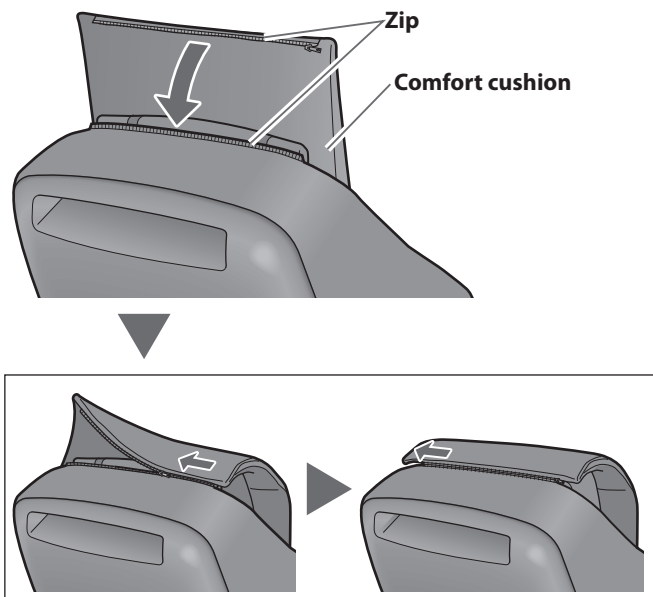

# Before sitting down

## Check the following before using the unit

### 1 Check the surrounding area.

Make sure there are no objects, people, or pets in the vicinity of the unit.

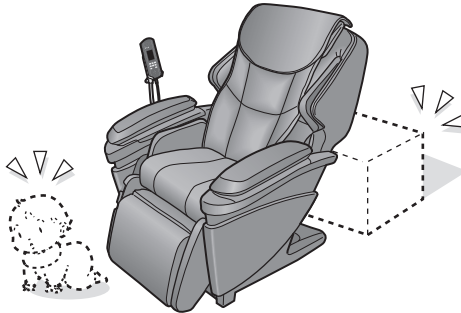

### 2 Flip up the comfort cushion and deploy the leg/sole massage section.

⚠ See Caution No. 3 on page 2, and No. 17 and 18 on page 3.

- Do not massage with the comfort cushion still on the backrest.



#### How to deploy the leg/sole massage section

- 1 Pull the release lever in the direction of the arrow.
- 2 Rotate from the bottom.
- 3 Rotate until it clicks into place.
- 4 Release the lever.
- 5 Check that the legrest is locked into place.

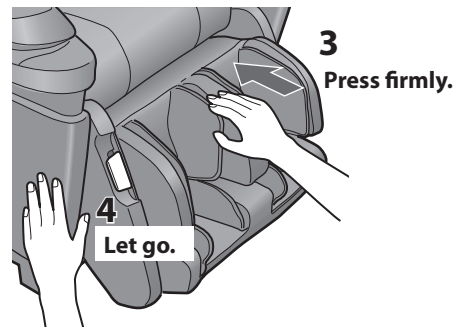
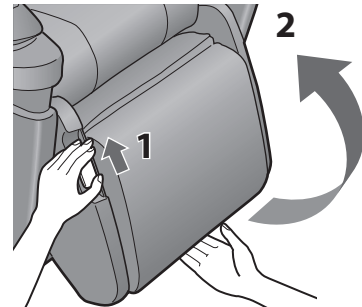

### 3 Check the power cord and the power plug.

⚠ See Warning No. 8 on page 1.

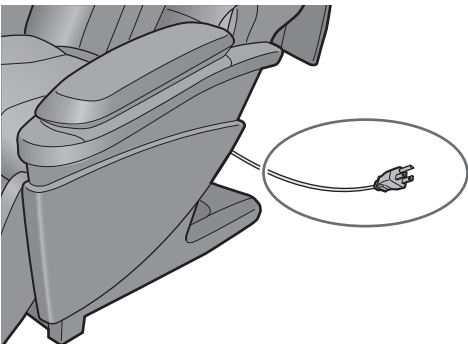

Be sure to push the connector all the way into the appliance inlet.

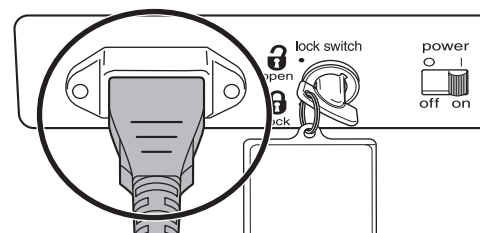

## 4 Switching on the power supply

- 1** Insert the power plug into an electrical socket.
- 2** Turn the lock switch key to the "open" position.
- 3** Slide the power switch to the "on" position.

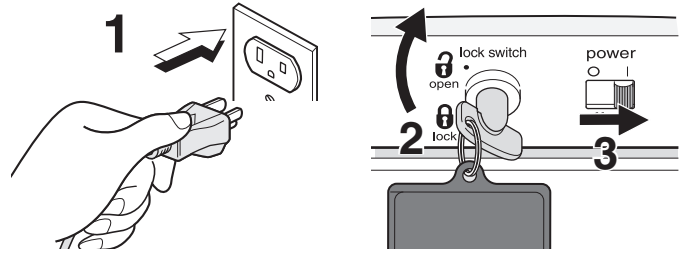

## 5 Check the unit.

- 1** Make sure there are no tears or rips in the fabric.

⚠ See Caution No. 15 on page 3.

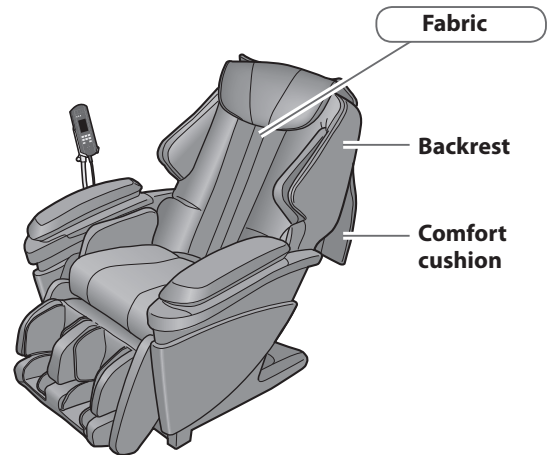

- 2** Make sure there is no foreign matter between the parts of the unit.

⚠ See Caution No. 17 on page 3.

- 3** Make sure the massage heads are in the retracted position.

### When the massage heads are not in the retracted position

Press the  button twice to return the massage heads to the retracted position.

- 4** Make sure the legrest is in the fully lowered position.

### When the legrest is not fully lowered

The legrest will lower by pressing on  twice.

⚠ See Caution No. 9 on page 2.

- 5** Check that the legrest is locked into place.

⚠ See Caution No. 17 on page 3.

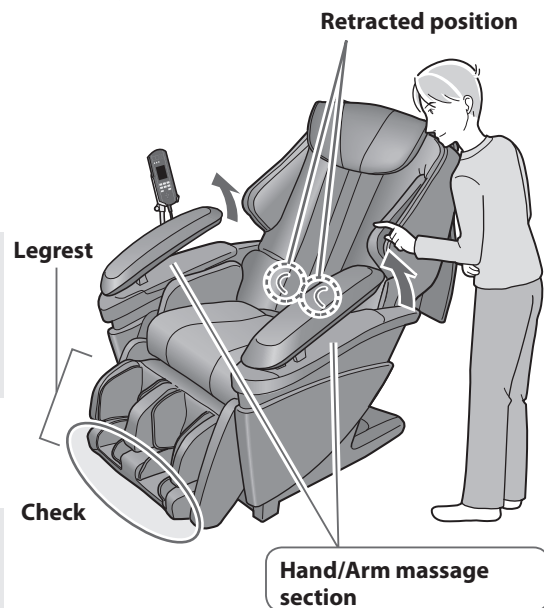

## 6 Adjust the pillow position.

### 1 Remove the pillow.

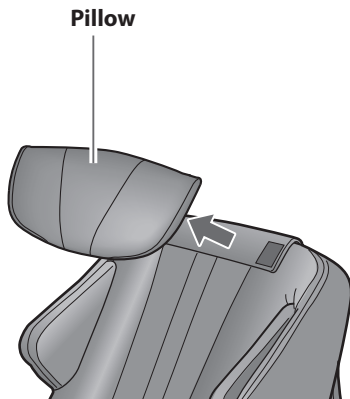

### 2 Adjust the height of the pillow so that the bottom edge is at ear level.

- If positioned too low, the pillow may interfere with a massage of the area around the neck.
- When the reclining angle changes, the position of the pillow may shift. In that case, readjust the position.

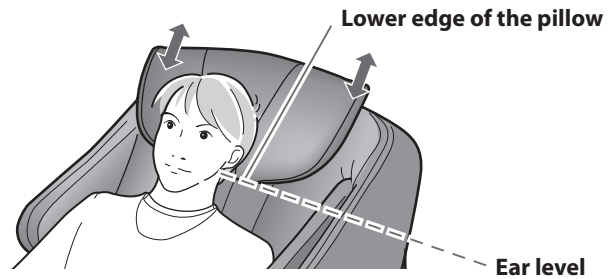

## 7 Slide the sole massage section to your preferred position.

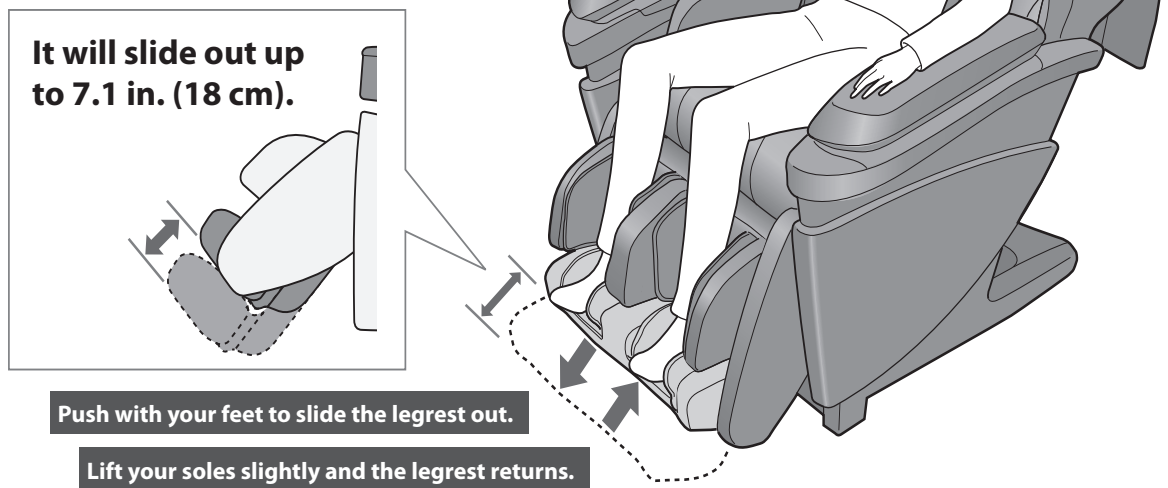

## 8 Adjust the controller stand.

Horizontal orientation can be adjusted.

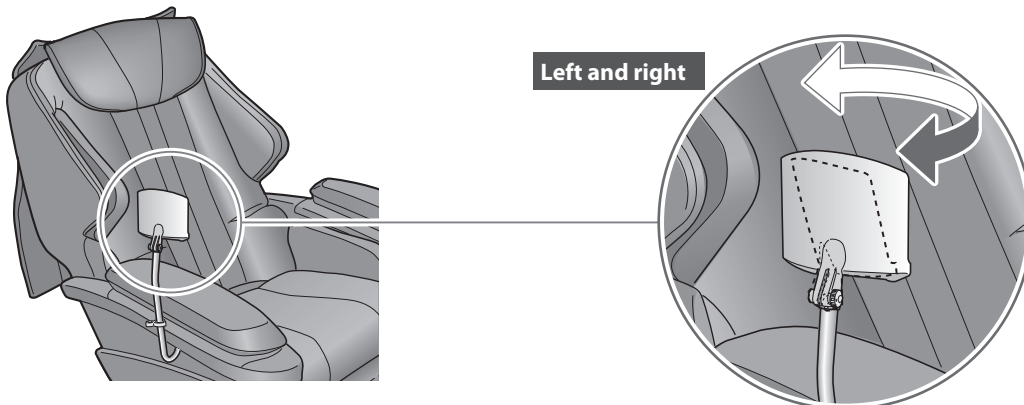

# If you want a complete massage

## Automatic programs

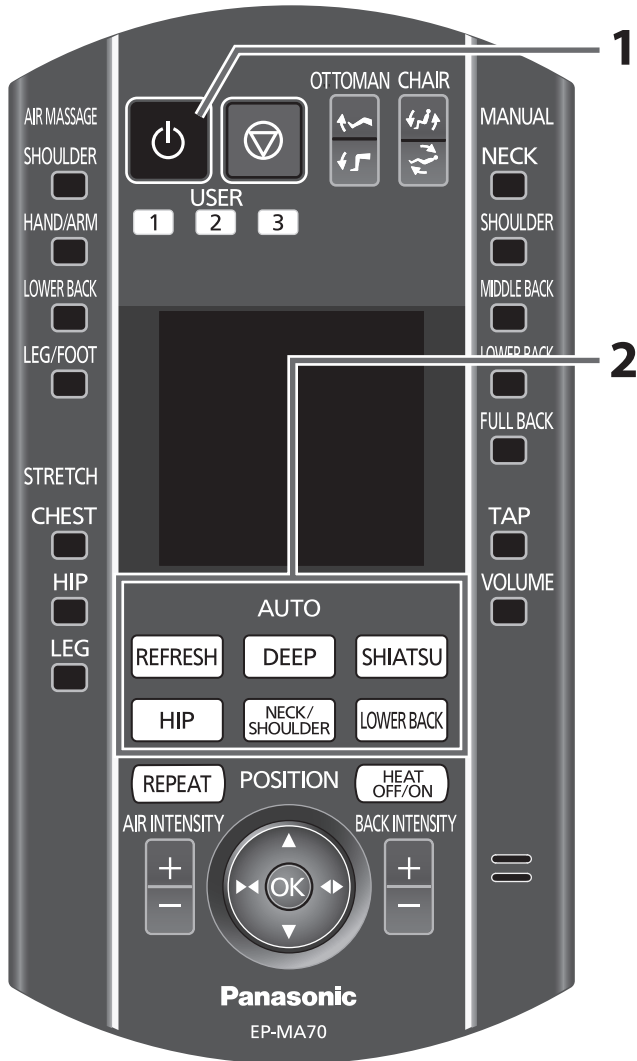

### 1 Press the button to turn on the power.

- The power is turned off automatically if 3 minutes or more pass without operation.

### 2 Press one of the buttons

(       ) to select the program.

### Characteristics of Automatic programs (Upper Body)

#### REFRESH

This is a program to relax your body pleasantly with light stimulation mainly by tapping massage.

#### DEEP

This is a standard program to deeply relax your muscles mainly by kneading massage.

#### SHIATSU

This is a program to strongly loosen points of muscle tightness mainly by shiatsu massage.

#### HIP

This is a program to relax the muscles around your pelvis using the air operation.

#### NECK/SHOULDER

This is a program to stretch and relax the muscles around your neck and your shoulders.

#### LOWER BACK

This is a program to relax the muscles around your lower and middle back.

- See page 41 for an overview of the respective programs.

Persons whose height is less than 55 in. (140 cm) or more than 72.8 in. (185 cm) are recommended to use the unit in the manner described below when the massage heads do not touch their shoulders.

#### Height is around 55 in. (140 cm) or less



Use by placing a cushion on the seat and sitting as far back as possible.

#### Height is around 72.8 in. (185 cm) or more



Use by reclining the backrest and sliding your body downward.

### 1 Body scanning will commence when the program is selected. ( **BODY SCANNING** will flash.)

- The body scanning will properly detect height ranges between approximately 55 and 72.8 in. (140 and 185 cm).

Sit as far back in the seat as possible with your head on the pillow.

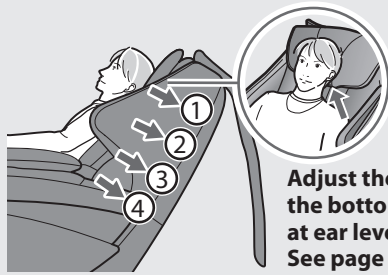

Adjust the pillow height so that the bottom edge of the pillow is at ear level. See page 19.

- ① NECK
- ② SHOULDER
- ③ MIDDLE BACK
- ④ LOWER BACK

The unit will automatically recline to the correct massage position.

#### Correct Massage Position

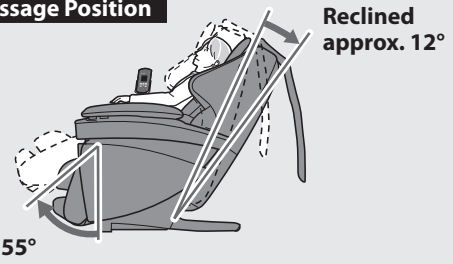

Raised approx. 55°

- If the massage lounger is reclined further than the massage position angle, it will not automatically return to the correct massage position.

### 2 Approximately 30 seconds after the body scanning starts, the massage heads slowly lower to the shoulder position, and a soft tapping action begins to determine your shoulder position.

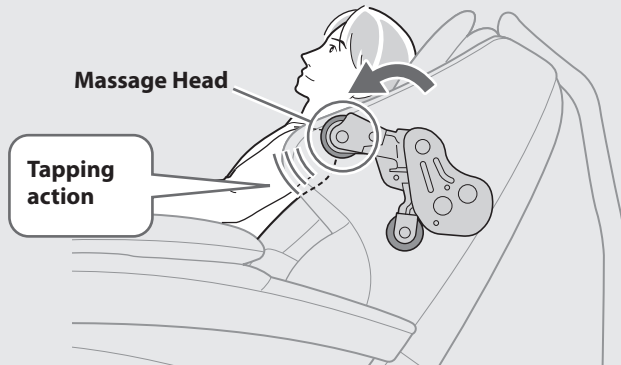

- Airbags in the seat will inflate so the body will not shift during the body scanning.



- Keep your head on the pillow until the soft tapping begins. Lifting your head from the pillow will result in incorrect determination of the shoulder position.

### 3 To adjust the shoulder position during the tapping action

- When the shoulder position is incorrect, adjust the shoulder position while the soft tapping is in progress (for approximately 12 seconds), and use the POSITION button to move the massage heads up or down and then press **OK** button.

#### POSITION

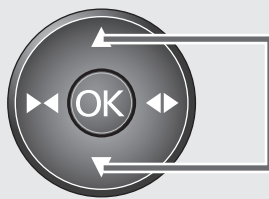

A single press of the button will raise or lower the massage heads approximately 1/2 in. (1.2 cm).

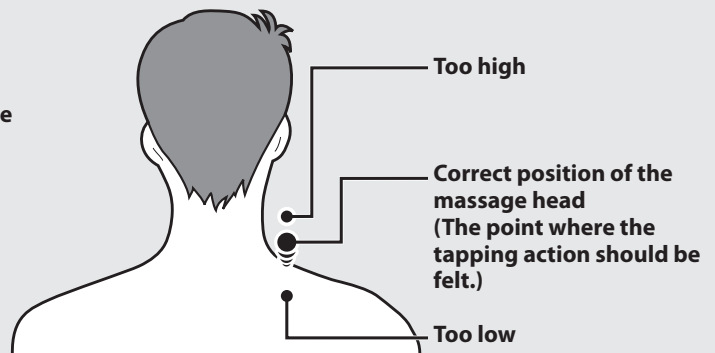

### 4 Body scanning is completed when the tapping finishes.

- If you press **OK** while the tapping action is still going on, it will end the body scanning and the massage will start.
- The legrest adjusts automatically so that the soles of the feet touch the footrest wells according to your estimated height based on the shoulder position.
- If the shoulder position is off drastically, turn the power off once, and repeat from Step 1 with your shoulder firmly pressed against the backrest.

**To customize**

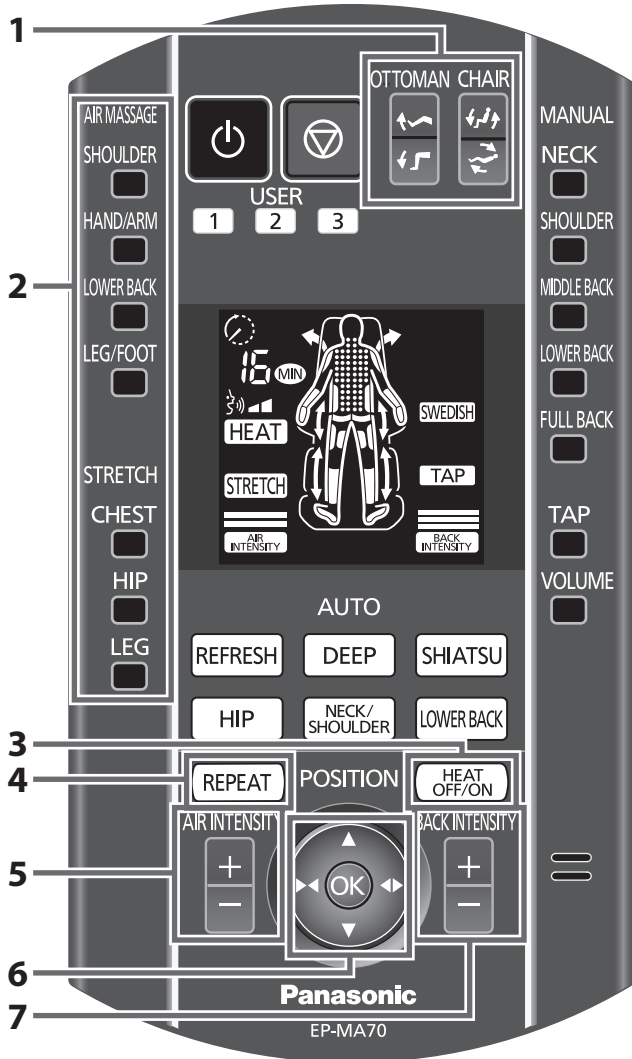

**1. Adjusting the reclining angle and legrest to massage in a relaxing position**

To adjust the reclining angle and the legrest angle:

OTTOMAN CHAIR

Adjust by pressing  button.

To adjust the length of the footrest:

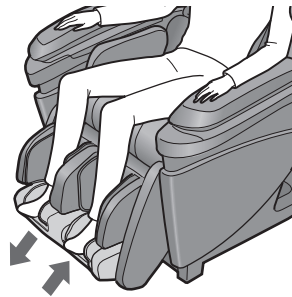

Push with your feet to slide the legrest out.

Lift your feet slightly and the legrest returns.

• See page 35 for a description on how to adjust the reclining angle and the legrest.

**2. Turning the air or stretch massage on or off**

- |             |         |
|-------------|---------|
| AIR MASSAGE | STRETCH |
| SHOULDER    | CHEST   |
| HAND/ARM    | HIP     |
| LOWER BACK  | LEG     |
| LEG/FOOT    |         |

Operation can be turned on/off by pressing the buttons on the left.

On/off for the air massage or stretch can be confirmed on the display.  
(Lit: On, Off: Off)

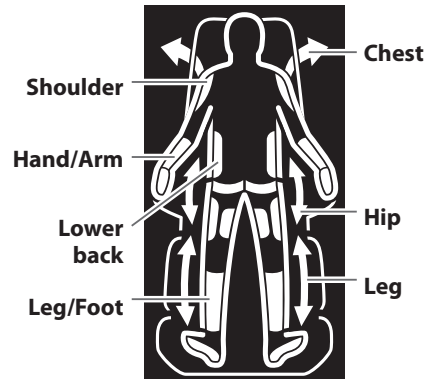

• Your preferred settings for these items can be saved and reused. (See page 24.)

**3. Turning the "Heat" massage heads on or off**

Your can turn the "Heat" massage heads on/off by pressing



Flashing: Warming up "Heat" massage heads.  
Lit: "Heat" massage heads are on.  
Off: "Heat" massage heads off.

- The temperature cannot be adjusted.
- The sense of warmth from the massage heads will differ depending on your body shape, massage area, massage action, clothing, and ambient temperature.
- See page 26 for details about "Heat" massage heads.

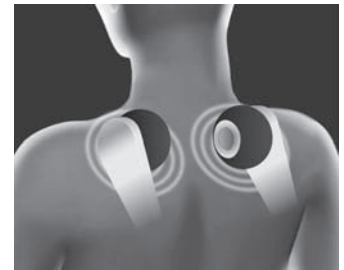

• Your preferred settings for these items can be saved and reused. (See page 24.)

## 4. To repeat the current massage

Contents of current massage action will be repeated by pressing **REPEAT**.

- The "REPEAT" command may not be accepted when the massage action is changing in that moment.
- **REPEAT** will flash while the massage is repeated.

## 5. Changing the intensity of the air massage

When performing a massage of the shoulder, arm, lower back or legs,

adjust the intensity by pressing the  button.



- See pages 30 to 34 for an effective method for usage and operation of the air massage and leg stretch.
- Your preferred settings for these items can be saved and reused. (See page 24.)

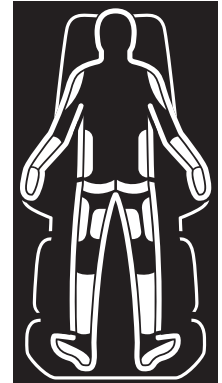

## 6. Fine adjustment of the position of the massage heads

(Number of adjustments possible)

- Adjustment may not be possible depending on the position.

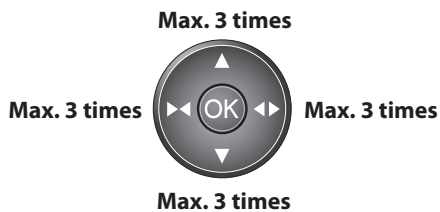

## 7. To adjust the back intensity

BACK INTENSITY



The back intensity can be adjusted by pressing the "+" or "-" of the Back Intensity button.

- The current position that is being massaged can be checked on the display.
- There are 3 levels of intensity for the Automatic programs.
- The intensity will not change further even if you keep pressing the button when the intensity is set to maximum or minimum.



### Caution

The intensity might increase drastically when increased in multiple steps.  
Always increase the intensity one step at a time, checking how it feels.

- For safety reasons, it is recommended not to increase the intensity drastically.
- If the intensity feels too weak at the maximum setting or too strong at the minimum setting:
  - <Feels too weak when set to a maximum in the automatic program>  
You can massage with greater intensity by reclining the backrest and making use of your body weight.
  - <Feels too strong when set to a minimum in the automatic program>  
Pressure of the massage heads will soften by placing a cloth or blanket between the backrest and your body. Also, if the intensity of the massage around your lower back is too strong, you can make it feel lighter by pressing the Lower Back button for the Air Massage to release the air around the lower back.
- Your preferred settings for these items can be saved and reused. (See page 24.)

### Caution

You may not feel the difference in intensity for massage or stretch even if the Back (Intensity) adjustment or Air (Intensity) adjustment button is pressed.

- When the intensity was increased right when the operation has changed.
- The feeling is different depending on the person or the position.



# To save your preferences

## Automatic programs

You can save your preferred settings set during the Automatic programs, and have them reproduced next time you are being massaged. You can save the settings for each program.

### ■ Example: When using the “REFRESH” program

1. You have set Air Massage “SHOULDER” and “LEG/FOOT” to “On”, and Stretch “CHEST” to “On”.  
(Air intensity was set to “Level 1” at this time.)
2. “Heat” massage heads was set to “Off”, and Back intensity was set to “Level 3”.
3. Volume for “voice guidance function” (see page 42) was set to “Loud”.
4. These settings were saved to User **1** after the massage completed.

Contents of the saved settings (1, 2, and 3 above) are restored if User **1** is pressed when the “REFRESH” program is used next time.

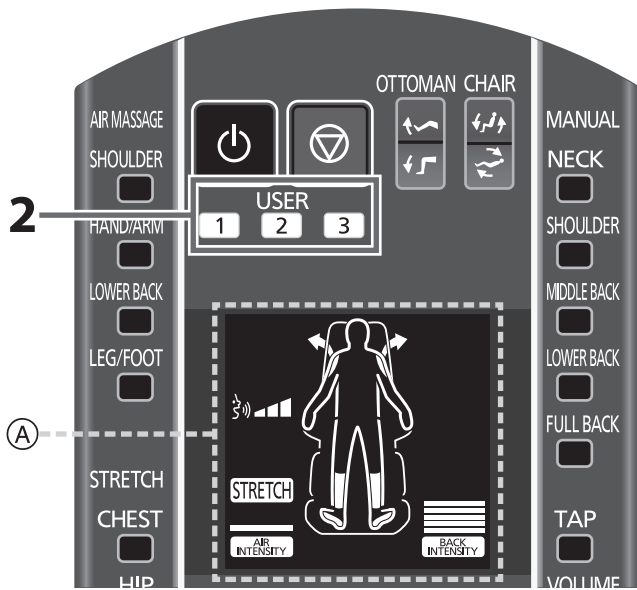

## 1 After the Automatic program has finished, or when the massage is completed by pressing during the program.

- (A): Your preferred settings (pages 22–23, 42 (volume)) are displayed and the User buttons will flash.

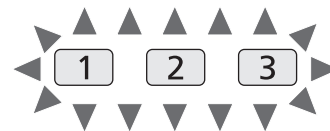

## 2 Select and press one button from **1** **2** **3** to store your settings while the buttons are flashing (approx. 15 seconds).

- Selected button will light. (Example: **1**)



### When saving your preferences is completed

- The pressed button will turn off, and the power of the chair will be turned off automatically in approximately 3 seconds.

- Be careful since preferred contents will not be saved when the power switch is turned “Off” or the power cord is disconnected during the massage.

### Contents that can be saved

- Air intensity and Back intensity settings
- “Heat” Massage Heads on/off setting
- Air and Stretch on/off settings  
(See pages 22–23.)
- Voice guidance volume setting (See page 42.)

\* Settings at the time the Automatic program is completed will be saved.

### About the “Heat” massage heads and Voice guidance volume settings

Only these 2 settings are applied to all the Automatic programs.

For example, “Heat” massage heads “Off” and Voice guidance volume “Loud” of the settings saved to User **1** for “REFRESH” in the above “■ Example” are applied, even if User **1** is pressed during a program other than “REFRESH”. (The settings for Air and Stretch are not applied.)

If there is another setting already saved, “Other settings are already registered.” will be announced.\*

■ To overwrite the contents with new settings\* press the same button again.



\* This will also be announced when you try to save to a separate Automatic program or save Automatic program contents that are the same as those already saved.

■ If you do not want to delete the settings already saved press another User button.

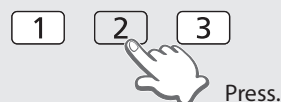

## To start a saved program

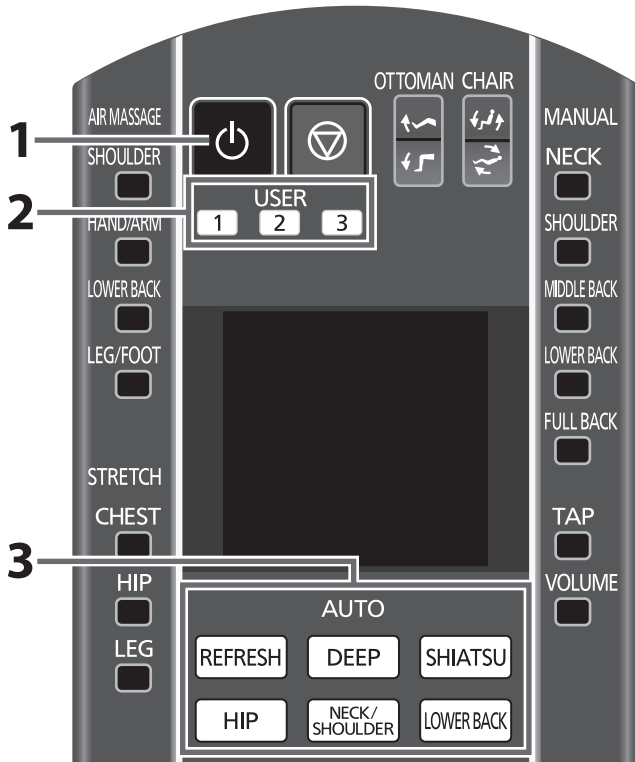

### 1 Press the button to turn on the power.

- The power is turned off automatically if 3 minutes or more pass without operation.

### 2 Select the User button with your saved settings.

- The selected User button will light. (Example: )



### 3 Select and press the Automatic program that was saved using the User button.

- (Example: "REFRESH")

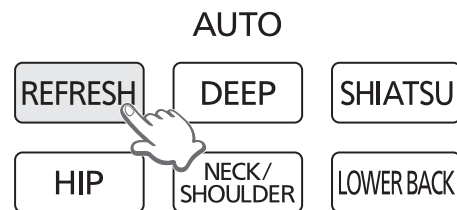

## The massage with your stored settings will start after body scanning.

- If you select a different automatic program than that which was stored with your saved settings (using one of the user buttons), your saved settings will not be reproduced. Only the saved settings regarding the "Heat" massage heads and Voice guidance volume will be applied. (See page 24.)

## To delete your saved settings (Example: )

### 1 Press the button to turn on the power. Select the program number you want to delete.

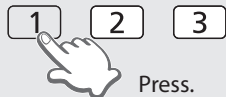

### 2 Press again and hold for more than 3 seconds until the button changes to flashing.

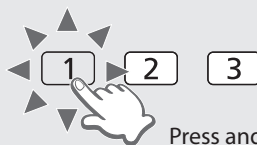

### 3 Press again while the button flashes (about 10 seconds).

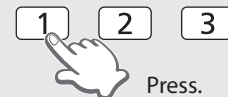

Deleting is completed once the flashing stops.

# To turn the "Heat" massage heads on or off

⚠ See Caution No. 21 on page 3.

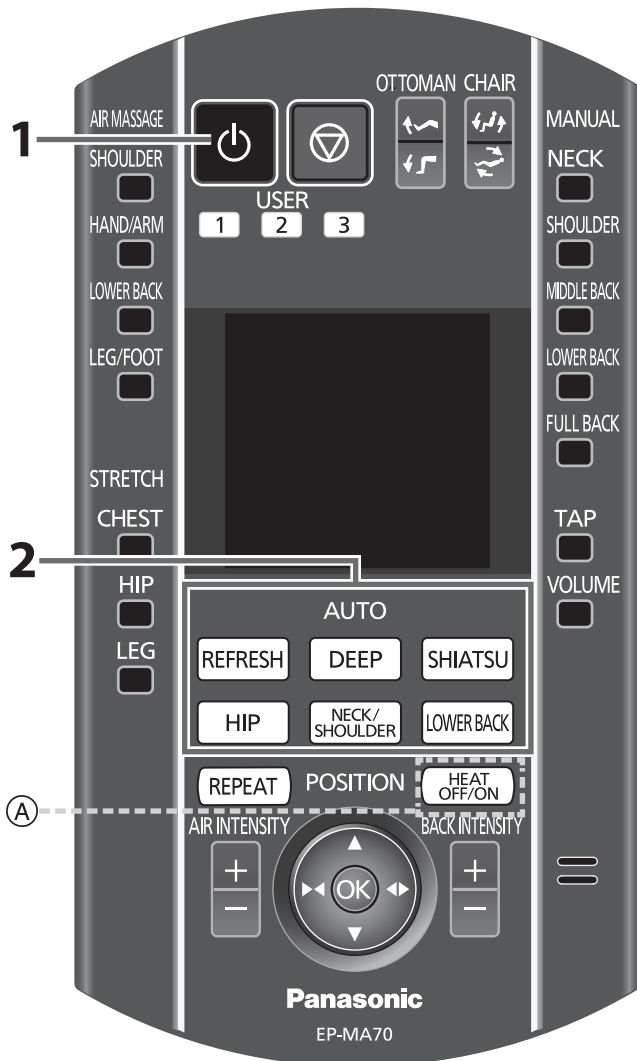

## 1 Press the button to turn on the power.

- The power is turned off automatically if 3 minutes or more pass without operation.

## 2 Press the Automatic program button and start the massage.

- Ⓐ: The "Heat" function is automatically turned on.

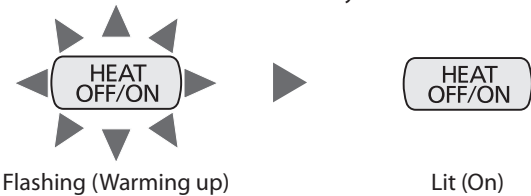

**HEAT** Flashing: Warming up "Heat" massage heads.  
Lit: "Heat" massage heads are on.

- The temperature cannot be adjusted.
- The sense of warmth from the massage heads will differ depending on your body shape, massage area, massage action, clothing, and ambient temperature.

## To turn the "Heat" massage heads off

Press  to turn them off.

- Button will turn off.

## To always have the "Heat" massage heads turned off

- Switch the "Heat" massage heads off and save this setting. (See page 24.)

The warm section on the "Heat" massage heads warm up the cloth, transferring the warmth to the massage location.

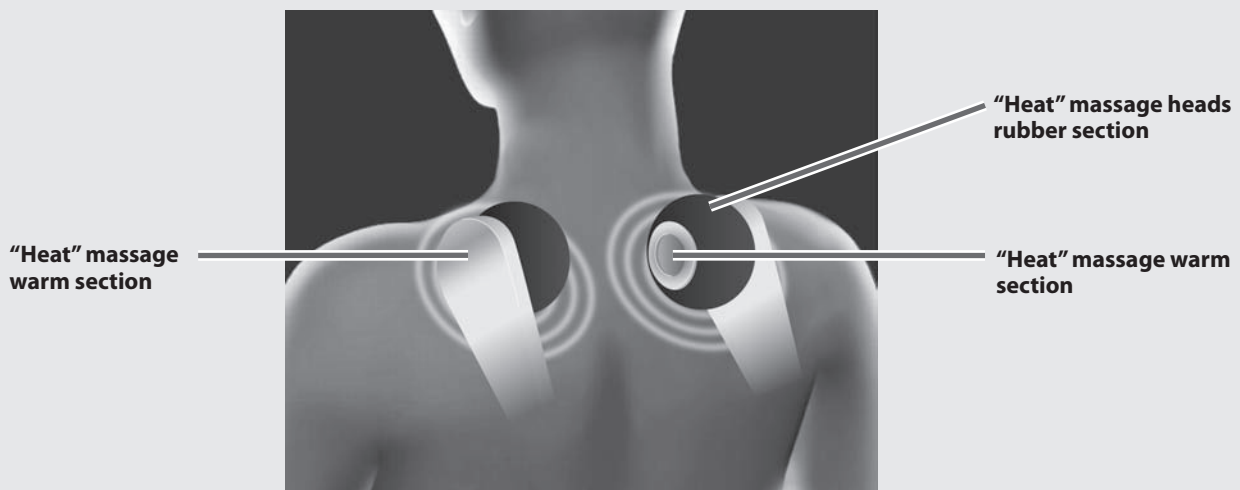

# Selection of a massage technique and body region

## Manual Operation

⚠ See Caution No. 6 on page 2.

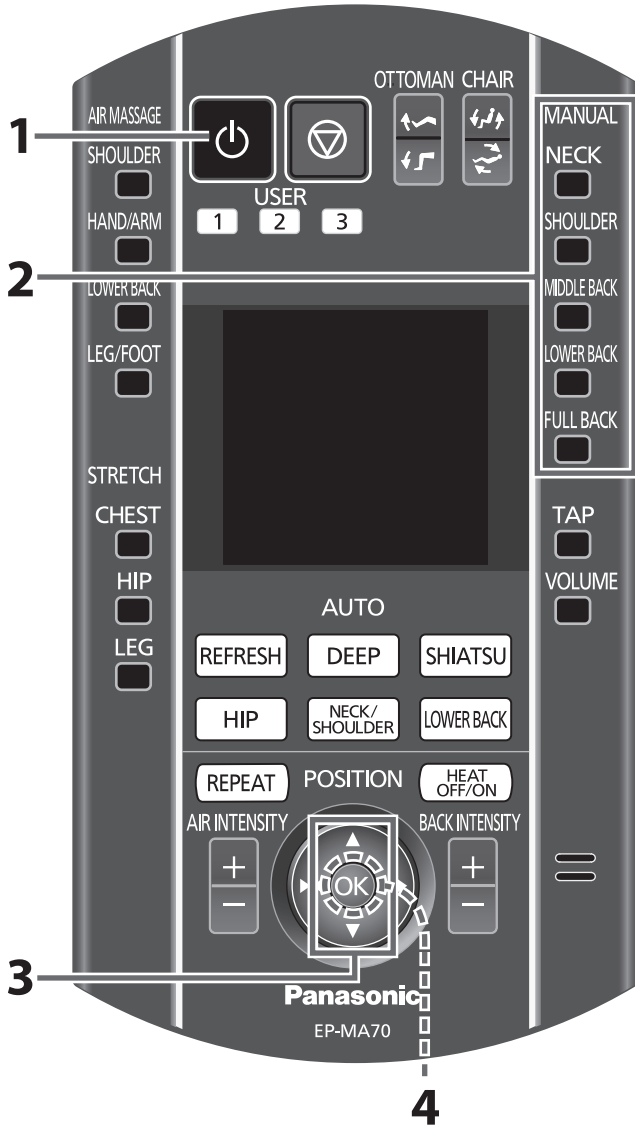

### 1 Press the button to turn on the power.

- The power is turned off automatically if 3 minutes or more pass without operation.

### 2 Select the part you want to massage

NECK SHOULDER MIDDLE BACK LOWER BACK FULL BACK  
(      ).

MANUAL

- The list of body parts that can be selected is displayed on the left.

NECK

(Example) When "NECK" is selected

MIDDLE BACK

LOWER BACK

FULL BACK



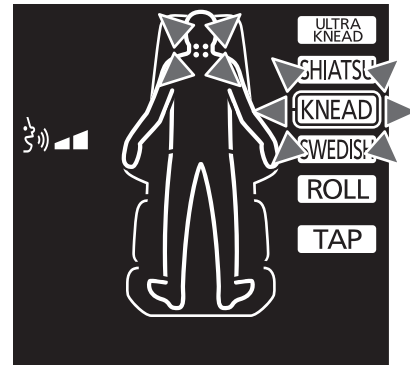

### 3 Select the massage action you prefer.

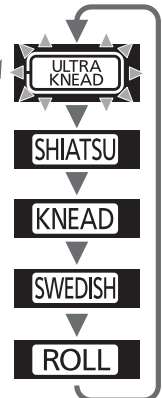

- The flashing frame is the currently selected operation.

- The massage technique can also be selected by repeatedly pressing the area selected in Step 2.



- When  is selected, "ROLL" or a combination of "ROLL" and another technique can be selected.

### 4 Press the button to start the massage.

- The massage heads will move to the selected position automatically to start the massage after the body scanning is completed.  
See page 21 for details about body scanning.
- See pages 28–29 for setting the massage in accordance with your preferences.
- When a massage to the same location has continued for 5 minutes, it will automatically move up approximately 1.2 in. (3 cm).

## Body scanning for Manual Operation

### Neck/Shoulder/Full back

....Normal body scanning.

### Middle back/Lower back

....Simple body scanning. (The massage heads will not come up to the shoulder position.)

## To change the technique in the middle of a massage

Select your favourite technique in Steps 2 to 4.

- Press the **OK** button within approximately 40 seconds after reselecting the technique in Step 2, otherwise the reselection will be cancelled automatically.

## If you want to massage with tap technique only

1 Press the **Power** button to turn on the power.

2 Select **TAP**.

3 Start the tap technique by pressing **OK**.

- Body scanning will not be performed.
- To change the technique, select with Steps 2–4 on the previous page.

## To customize

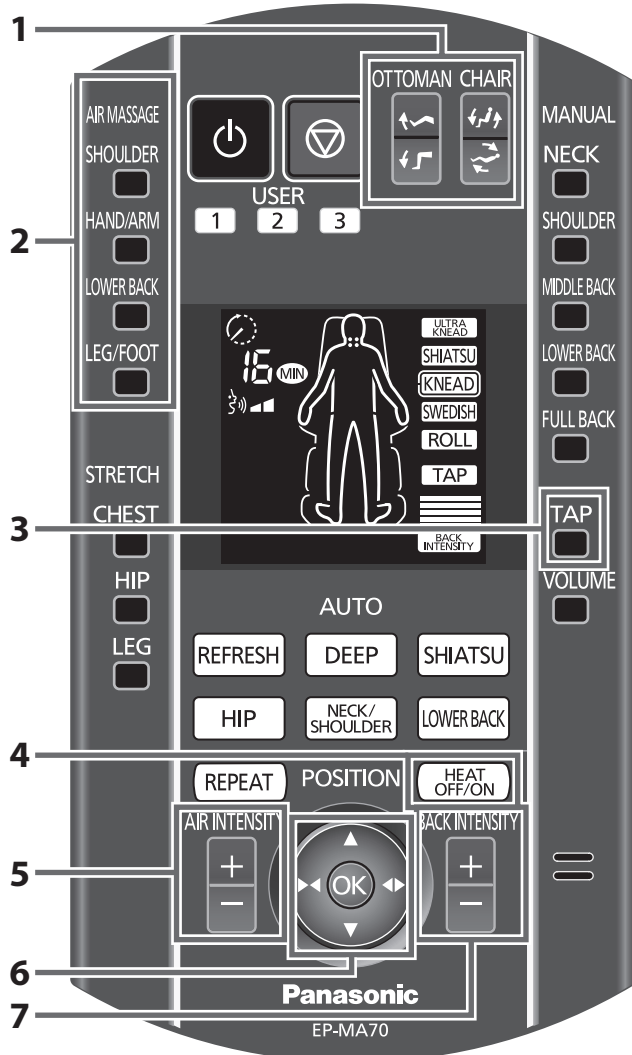

### 1. Adjusting the reclining angle and legrest to massage in a relaxing position

To adjust the reclining angle and the legrest angle:

Adjust by pressing **OTTOMAN CHAIR** button.

To adjust the protrusion of the foot massage section:

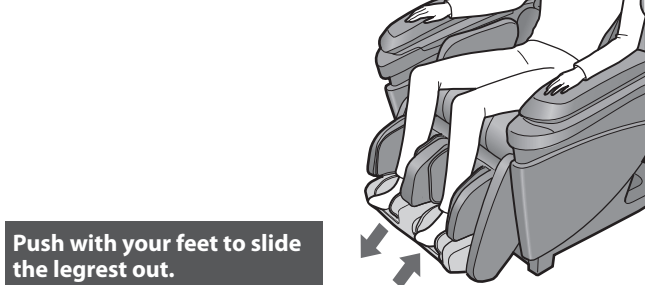

Push with your feet to slide the legrest out.

Lift your feet slightly and the legrest returns.

- See page 35 for description on how to adjust the reclining angle and the legrest.

### 2. Combining air massages

- AIR MASSAGE Operation can be turned on/off by pressing the buttons on the left.
- SHOULDER
- HAND/ARM
- LOWER BACK  On/off for the air massage or stretch can be confirmed on the display.
- LEG/FOOT  (Lit: On, Off: Off)

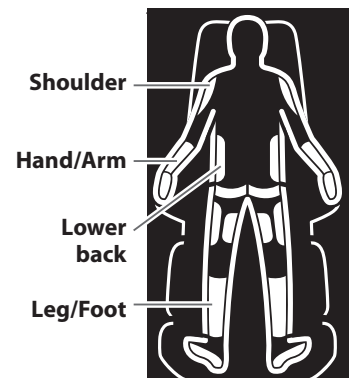

### 3. Adding tapping actions to the current operation

TAP  
Press the  button.

- You can select tap on/off every time it is pressed.
- \* You cannot select on/off when you are massaging only with the tap action.

### 4. To turn the "Heat" message heads on or off

You can turn the "Heat" message heads on or off by pressing  .

 Flashing: Warming up "Heat" message heads.  
Lit: "Heat" message heads are on.  
Off: "Heat" message heads off.

- The temperature cannot be adjusted.
- The sense of warmth from the message heads will differ depending on your body shape, massage area, massage action, clothing, and ambient temperature.
- See page 26 for details about "Heat" message heads.

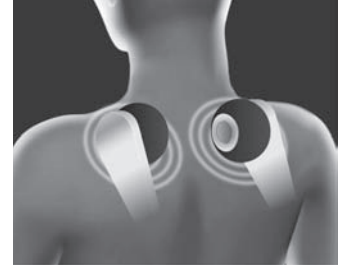

### 5. Changing the intensity of the air massage

When performing an air massage,  
AIR INTENSITY

adjust by pressing the  button.



- The intensity is displayed in 3 levels.

### 6. Fine adjustment of the massage heads position

POSITION

It can be adjusted with the  button.

- When you keep on pressing the button up or down, the position will move continuously until you release the button.

### 7. Adjusting the intensity of the massage

BACK INTENSITY



The back intensity can be adjusted by pressing the "+" or "-" of the Back Intensity button.

- The intensity for the manual operation is displayed in 5 steps.
- The level of intensity that can be adjusted differs depending on the action.

#### Caution

The intensity might increase drastically when increased in multiple steps.  
Always increase the intensity one step at a time, checking how it feels.

- For safety reasons, it is recommended not to increase the intensity drastically.



#### Caution

The stretch action will not be performed simultaneously.  
The manual operation is cleared when the Stretch button is pressed.

# Performing Air massage or Stretch action

## Air actions/Stretch actions

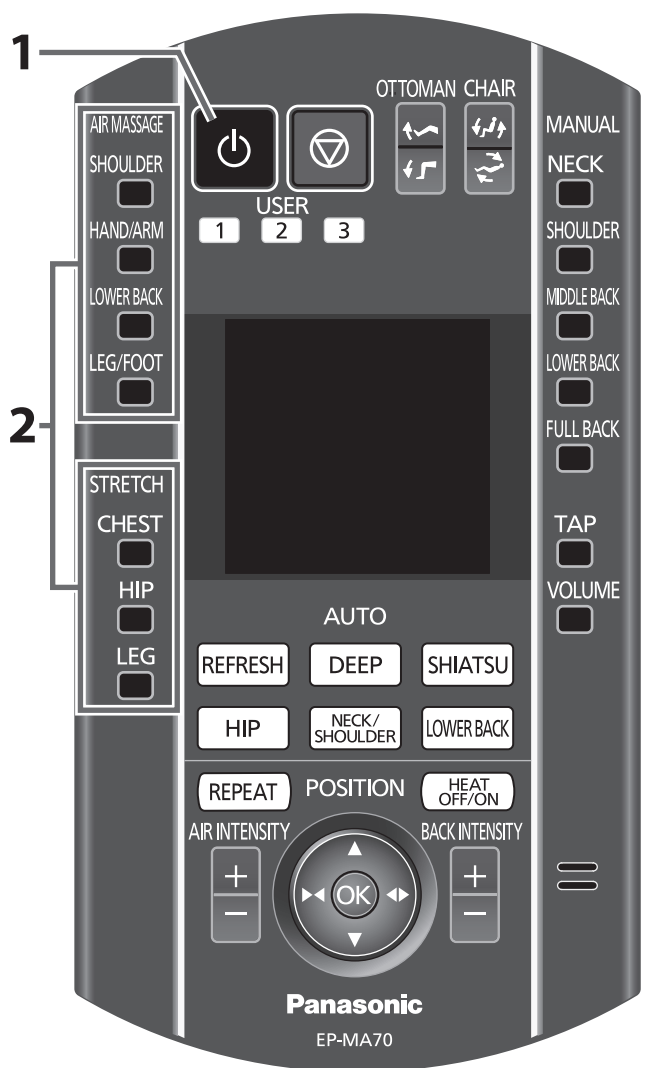

**1 Press the  button to turn on the power.**

- The power is turned off automatically if 3 minutes or more pass without operation.

**2**

AIR MASSAGE	STRETCH	<b>The operation can be turned on/off by pressing the buttons on the left.</b>
SHOULDER	CHEST	
<input type="checkbox"/>	<input type="checkbox"/>	
HAND/ARM	HIP	
<input type="checkbox"/>	<input type="checkbox"/>	
LOWER BACK	LEG	
<input type="checkbox"/>	<input type="checkbox"/>	
LEG/FOOT		
<input type="checkbox"/>		

On/off for the air massage or stretch action be confirmed on the display.  
(Lit: On, Off: Off)

- See page 33 for details about the air massage.
- See page 34 for details about the stretch action.
- For the stretch action, the massage heads will automatically move to selected after the body scanning, has been completed.

**To adjust the air intensity**

AIR INTENSITY

Adjust by pressing the  button.

- The intensity is displayed in 3 levels.

**To adjust the back intensity (only for stretch)**

BACK INTENSITY

Adjust by pressing the  button.

- The intensity is displayed in 3 levels.

**To turn the "Heat" massage heads on or off (only for stretch)**

You can turn the "Heat" massage heads on or off by pressing .

- See page 26 for details about "Heat" massage heads.

## Effective method for using the leg/foot air massage/stretch

### Adjust the legrest so that your feet fit in it completely.

#### For a person with small body dimensions

- If the legrest is raised, it is easier to fit your sole on it.

Press the  button.

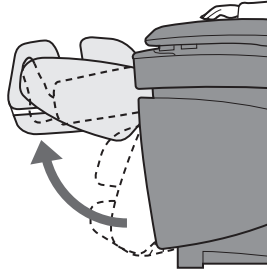

#### For a person with large body dimensions

- If the slide of the sole massage section is adjusted, your knees will not be lifted as much.

Push with your feet to slide the legrest out.

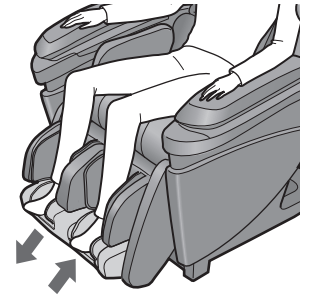

Lift your feet slightly and the legrest returns.

- The knees will not be lifted as much if lowering the legrest.

Press the  button.

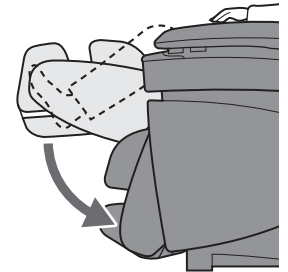

It is possible to massage your leg completely by laying the foot massage section flat.

Foot massage section

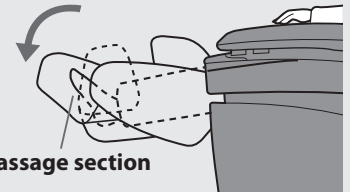

### For the sole shiatsu sheet

The sole shiatsu sheet is removable.

Opening

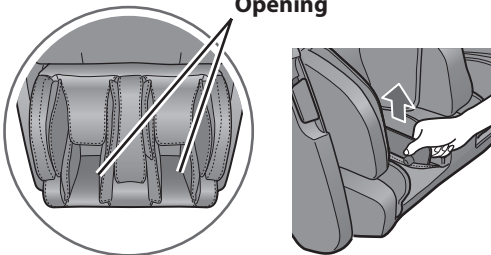

#### To attach the sole shiatsu sheet

Be sure of the proper direction of the sole shiatsu sheet and insert it into the opening.

Projections are on the upper side.

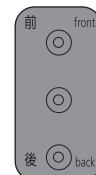
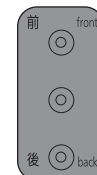

Toe

Heel



## How to use the Hand/Arm massage

⚠ See Caution No. 14 on page 2.

### 1 Lift up the Hand/Arm massage section.

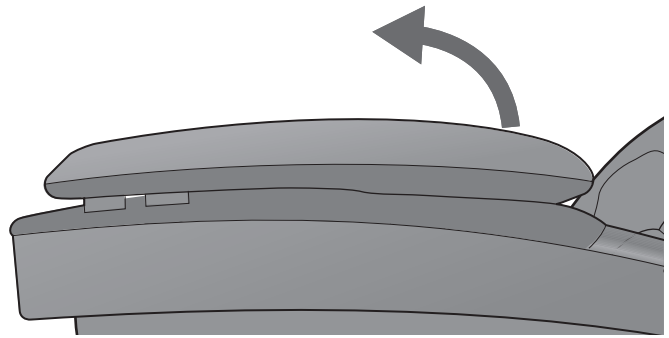

### 2 Insert the hand with fingers extended.

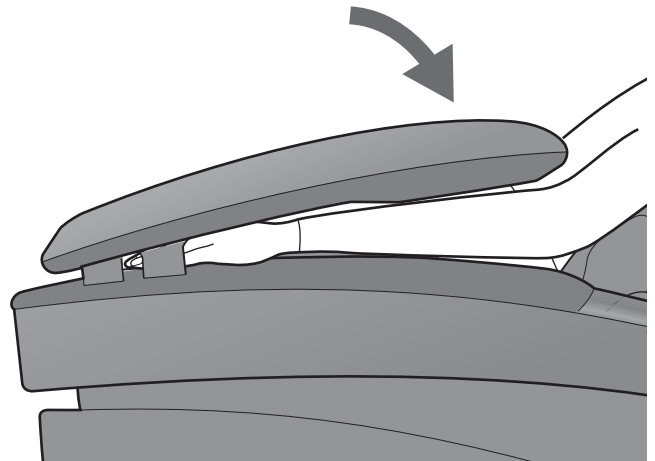

## Effective method for using the Hand/Arm massage

### Position the forearm and hand at the centre of the armrest.

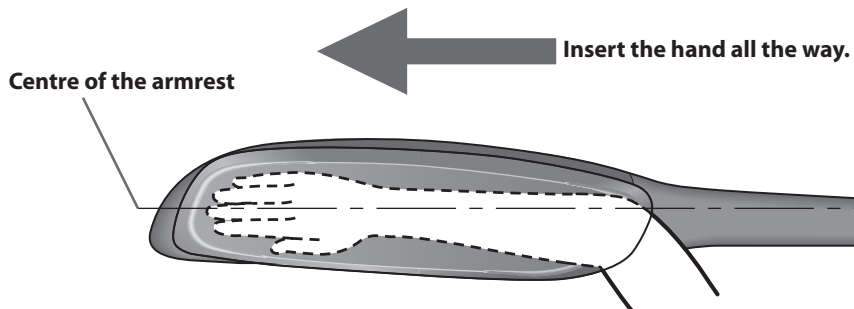

- Raise the backrest if any difficulty is experienced when positioning the hand and forearm.

## Operation of the Shoulder, Hand/Arm, Lower back, Leg/Foot Air massage

### Operation of the Shoulder massage

Lateral pressure is applied to squeeze your shoulders to your arms.

### Operation of the Lower back massage

Lateral pressure is applied to squeeze from your lower back to your thighs.

The region from your posterior to your hamstrings is stimulated with 3 airbags on the seat.



### Operation of the Hand/Arm massage

#### Hand/Arm

Hand to arm will be compressed as it is clamped from top and bottom.

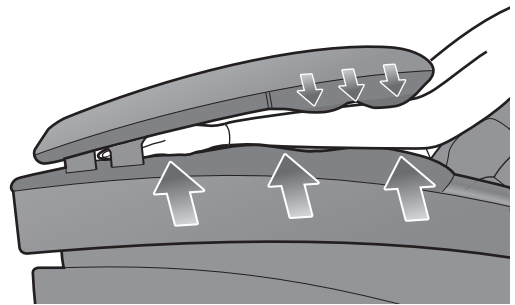

### Operation of the Leg/Sole massage

#### Leg

Calves will be compressed by embracing sidewise airbags.

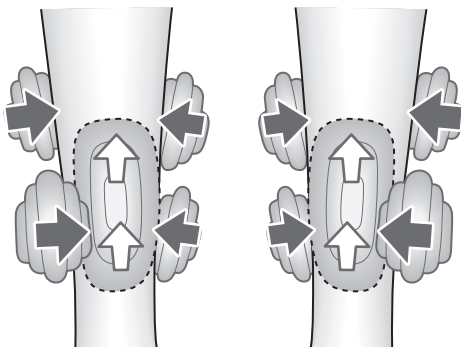

#### Sole

Feet will be compressed by embracing lateral airbags pressing the feet onto the shiatsu sole plate.

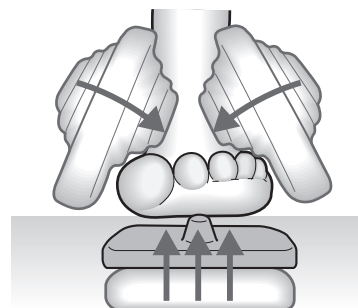

## Operation of the Shoulder Blade, Pelvis, Leg Stretch

### Operation of the Shoulder Blade Stretch

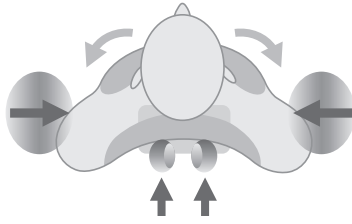

The muscles in the region from your shoulder blades to your chest are stretched by holding your shoulders with the shoulder side massage section and pressing your back with the massage heads.

### Operation of the Pelvis Stretch

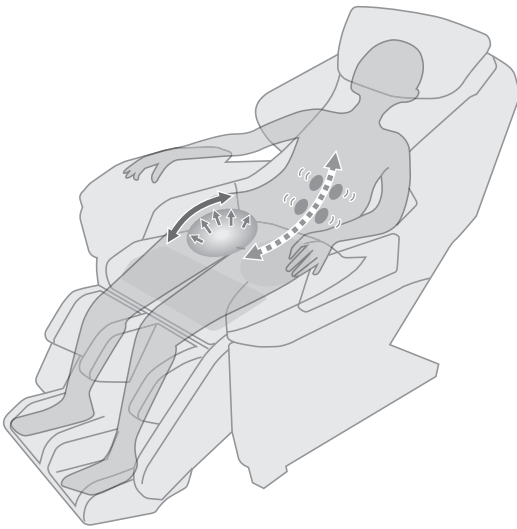

The muscles are loosened by widely twisting and swaying around your pelvis.

### Operations of the Leg Stretch

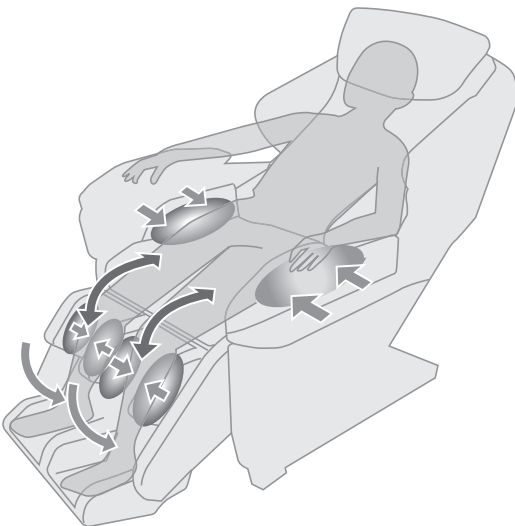

The legs are stretched by fixating your thighs and legs/soles while lowering the legrest.

- The legrest might hit the floor when fully extended.

# Adjustment of the reclining angle and/or legrest

## 1 Press the button to turn on the power.

- The power is turned off automatically if 3 minutes or more pass without operation.

## 2 Press the or button to adjust the angle.

- The movement will continue until a “beep-beep-beep” sound is heard if the buttons are held down.
- The movement of the legrest may be delayed slightly.
- The armrest will move in accordance with the reclining of the backrest.

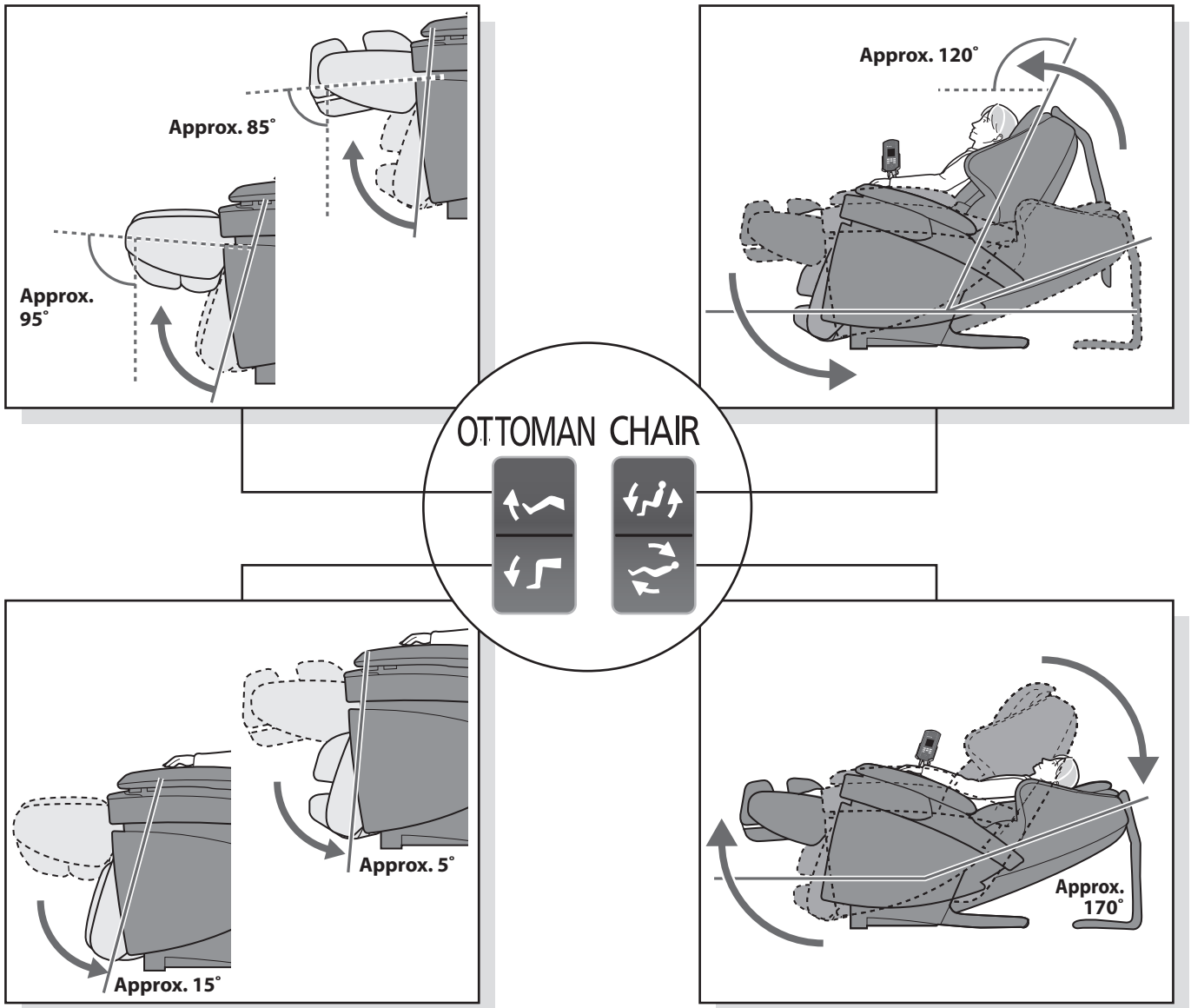

- Do not raise or lower the backrest and/or legrest repeatedly for any purpose other than adjusting them to your preferred positions.

## After completing the massage

### Timer function

**The massage will complete automatically approximately 16 minutes after the start of operations.**

- The foot massage section will retract, and the legrest will be lowered automatically so you can stand up safely.

The foot massage section will not retract all the way when the legrest is extended, since the sole massage section will hit the floor. Raise your legs to retract all the way.

- The backrest will not rise automatically.
- The massage heads move to the retracted position. The backrest will rise by pressing  button twice.



### Interrupting the massage

**Return the feet massage section to the original position and then press the  button.**

- The massage heads move to the retracted position.
- The legrest lowers and the backrest raises automatically. (The backrest will move after the massage heads retract.)

Lift your feet slightly and the legrest returns.

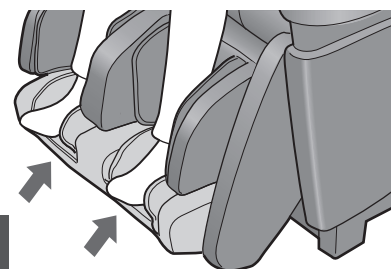

### If you experience any problems

**Press the  button.**

- All operations will stop immediately.
- Get off the unit carefully to prevent the unit from tipping over.

### Returning to normal chair position

**1 Flap the comfort cushion back onto the backrest.**

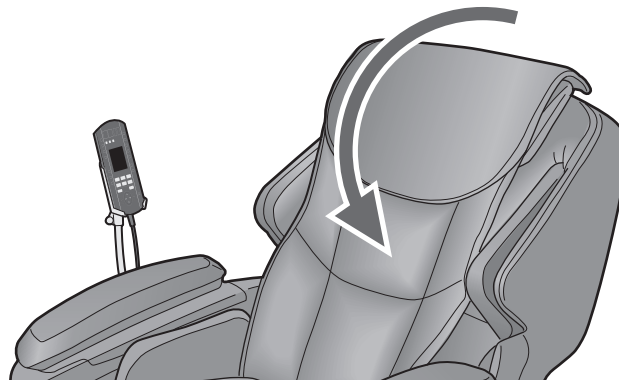

## 2 Store the legrest.

⚠ See Caution No. 3 on page 2, and No. 17 and No. 18 on page 3.

- 1 Pull the lever in the direction of the arrow.
- 2 Rotate from top.
- 3 Rotate until it locks into place.
- 4 Release the lever.
- 5 Check that the legrest is locked.

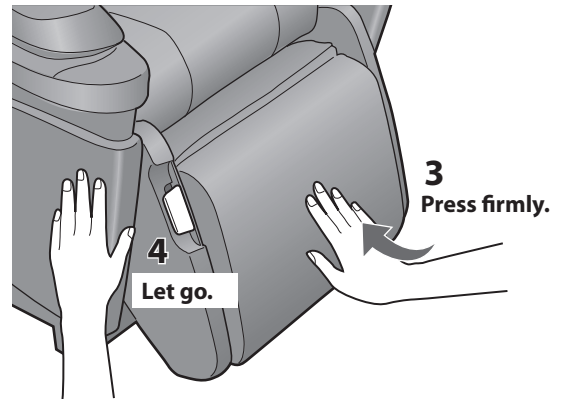
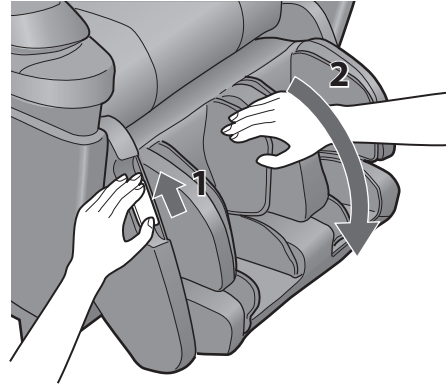

## Disconnecting the power

⚠ See Danger No.1 on page 1, Caution No.2 on page 2, and No.10 and No.14 on page 4.

- 1 Slide the power switch to the "off" position.
- 2 Turn the key to the "lock" position and remove it.

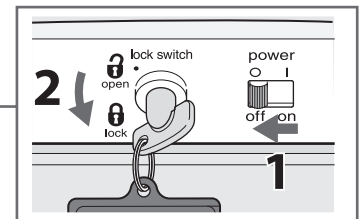
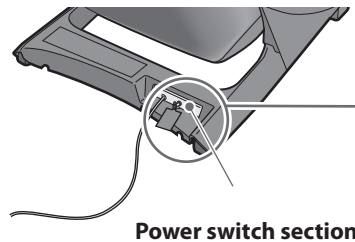

- 3 Remove the power plug from the power socket.

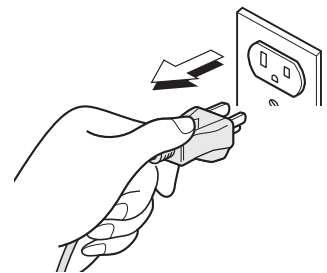

- 4 The key must be stored out of the reach of children.

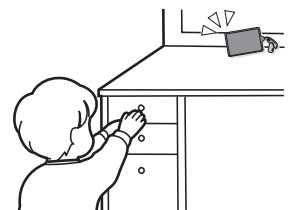

# Cleaning and Maintenance

⚠ See Danger No. 1 on page 1.

## Areas covered with synthetic leather

### Wipe these areas with a soft, dry cloth.

- When using commercially available leather-care products (wipes), follow its instructions.
- If the synthetic leather is particularly dirty, wipe it in the following manner:
  1. Soak a soft cloth in water or a 3% to 5% solution of mild detergent and wring it out thoroughly.
  2. Dab the surface with the moistened cloth.
  3. Rinse the cloth in water, wring it out thoroughly, and then wipe any remaining detergent from the surface.
  4. Wipe the surfaces with a soft, dry cloth.
  5. Allow to dry naturally.
- If it is difficult to remove dirt, soak a commercially available Melamine foam sponge in mild detergent and wipe the unit with it.
- Do not use a hair dryer to dry the surface more quickly.
- Since colours may transfer from clothing to the synthetic leather surface, be careful when using the unit with clothing such as jeans or coloured clothes.
- Do not allow these areas to come in contact with plastic for extended periods of time as this may lead to discolouration.
- Never use chemicals such as thinner, benzene, alcohol, etc.



## Plastic Area

### 1 Wipe the unit with a cloth moistened with mild detergent and thoroughly wrung out.

- Never use chemicals such as thinner, benzene, alcohol, etc.

### 2 Wipe the unit with a cloth moistened with plain water and thoroughly wrung out.

- Make sure to wring tightly before wiping the controller.

### 3 Allow the unit to dry naturally.



## Seat Fabric

### 1 Wipe the unit with a cloth moistened with mild detergent and thoroughly wrung out.

- Never use chemicals such as thinner, benzene, alcohol, etc.

### 2 Use water or a mild detergent and brush on areas where the seat fabric is particularly soiled.

- Be careful not to brush the fabric too much to avoid damage.

### 3 Wipe the unit with a cloth moistened with plain water and thoroughly wrung out.

### 4 Allow the unit to dry naturally.

- Since colour may transfer from clothing to the seat fabric, be careful when using the unit with clothing such as jeans or coloured clothes.



# Moving the Unit

⚠ See Caution No.18, No22 and No. 23 on page 3.

## Moving by lifting it with 2 or more persons

Move the unit with 2 or more people in front and back of the unit holding on the side of the legrest and the groove on the back cover of the backrest.

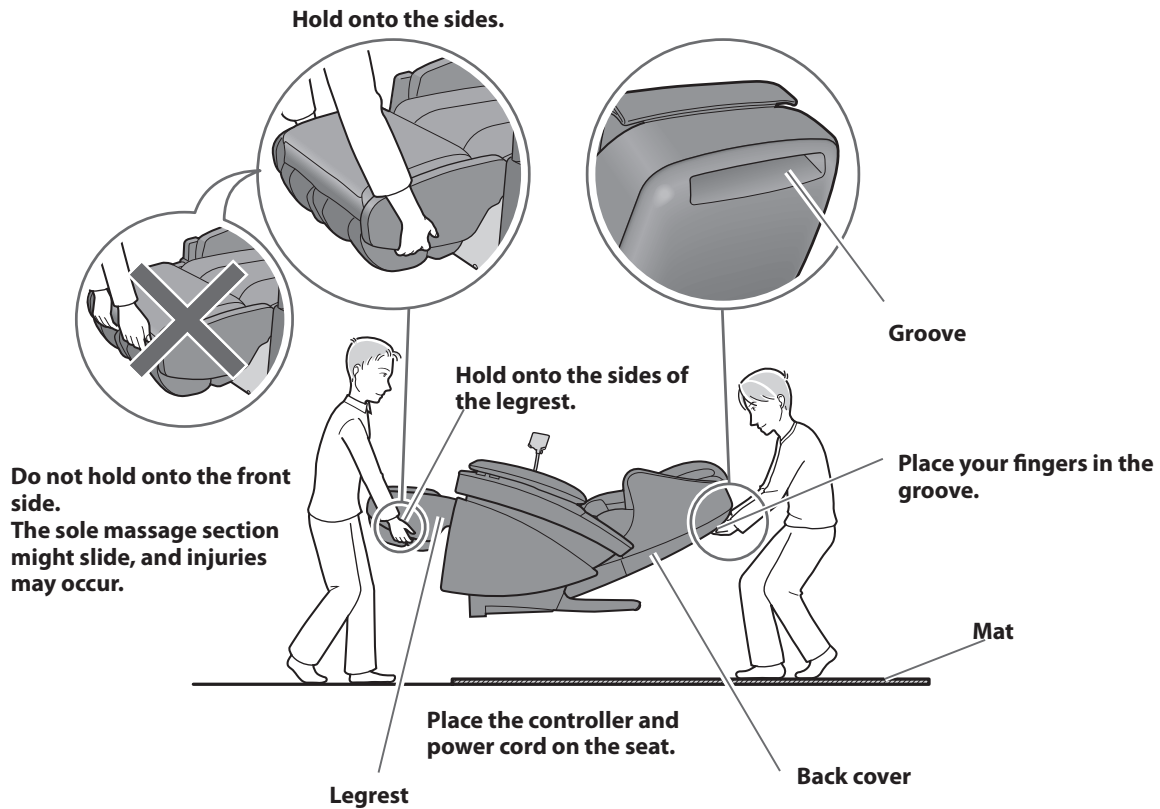

\* You may damage the floor by dropping the unit if you do not hold it correctly. Never carry it by the armrest, because it may get damaged.

### To put the unit down on the floor

- Put the unit down slowly and carefully watch your step.
- Put down the legrest by holding it with your hands until it has been set on the floor completely. If you release your hands before the legrest is fully extended, the legrest will forcefully return to the initial position.



## Using the wheels to move the unit

Move the unit by holding onto the side of the legrest and using the wheels.



### To put the unit down on the floor

- Put the unit down slowly and carefully watch your step.
  - Put down the legrest by holding it with your hands until it has been set on the floor completely.
- If you release your hands before the legrest is fully extended, the legrest will forcefully return to the initial position.

## How to remove the armrest

It is easier to move the unit with the armrest removed.

- 1 Remove the air plugs.**  
(See Step 3 on page 14.)
- 2 Remove the attachment screws.**  
(See Step 2-3 on page 13.)
- 3 Slide the armrest toward the rear, then pull it up holding on to it with both hands.**

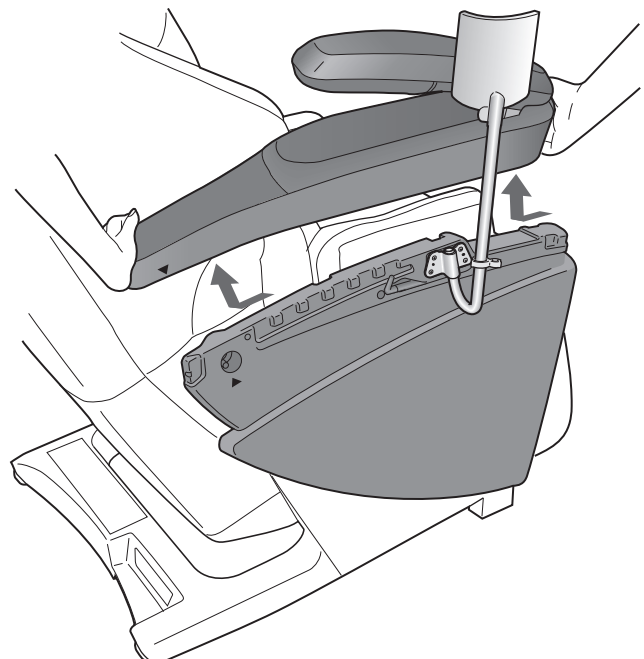

# About the Automatic programs/About the massage techniques/About the voice guidance function

**About the Automatic programs** (\* Time spent on "Finishing Touches" differs depending on your height and intensity setting.)

## Refresh program

- |                                  |  |  |   |                |                                   |                       |
|----------------------------------|--|--|---|----------------|-----------------------------------|-----------------------|
| 1) Tap/Swedish on neck/shoulders | 2) Tap/knead on lower back<br>Pelvis stretch | 3) Tap/knead on neck/ lower back<br>Shoulder blade stretch | 4) Tap/knead on middle back/ lower back | 5) Leg stretch | 6) Tap/Swedish on neck/ shoulders | 7) Finishing Touches* |
|----------------------------------|--|--|---|----------------|-----------------------------------|-----------------------|

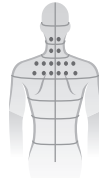

## Deep program

- |  |                             |                                  |  |                           |  |                       |
|--|-----------------------------|----------------------------------|--|---------------------------|--|-----------------------|
| 1) Ultra knead/ knead on neck/ shoulders | 2) Knead/roll on lower back | 3) Leg stretch<br>Pelvis stretch | 4) Ultra knead/ knead on neck/ shoulders | 5) Shoulder blade stretch | 6) Knead/roll on middle back/ lower back | 7) Finishing Touches* |
|--|-----------------------------|----------------------------------|--|---------------------------|--|-----------------------|



## Shiatsu program

- |   |                                |  |   |   |                                  |                       |
|---|--------------------------------|--|---|---|----------------------------------|-----------------------|
| 1) Shiatsu/ultra knead on neck/ shoulders | 2) Shiatsu/knead on lower back | 3) Shiatsu/roll on middle back<br>Shoulder blade stretch | 4) Shiatsu/ultra knead on neck/ shoulders | 5) Shiatsu/knead on middle back/ lower back | 6) Pelvis stretch<br>Leg stretch | 7) Finishing Touches* |
|---|--------------------------------|--|---|---|----------------------------------|-----------------------|



## Hip program

- |   |                                    |   |   |                                    |                                       |                       |
|---|------------------------------------|---|---|------------------------------------|---------------------------------------|-----------------------|
| 1) Pelvis stretch 3 times<br>Entire back roll | 2) Leg stretch<br>Entire back roll | 3) Shoulder blade stretch<br>Entire back roll | 4) Pelvis stretch 2 times<br>Entire back roll | 5) Leg stretch<br>Entire back roll | 6) Pelvis stretch<br>Entire back roll | 7) Finishing Touches* |
|---|------------------------------------|---|---|------------------------------------|---------------------------------------|-----------------------|

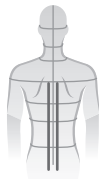
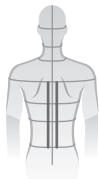
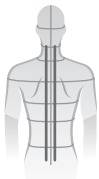

## Neck/shoulder program

- |                                     |  |                                     |                        |                                     |                       |
|-------------------------------------|--|-------------------------------------|------------------------|-------------------------------------|-----------------------|
| 1) Shiatsu/knead on neck/ shoulders | 2) Roll on middle back<br>Shoulder blade stretch | 3) Shiatsu/knead on neck/ shoulders | 4) Roll on middle back | 5) Shiatsu/knead on neck/ shoulders | 6) Finishing Touches* |
|-------------------------------------|--|-------------------------------------|------------------------|-------------------------------------|-----------------------|



## Lower back program

- |  |  |                                  |  |  |                       |
|--|--|----------------------------------|--|--|-----------------------|
| 1) Knead/roll on middle back/ lower back | 2) Knead/roll on middle back/ lower back | 3) Pelvis stretch<br>Leg stretch | 4) Knead/roll on middle back/ lower back | 5) Knead/roll on middle back/ lower back | 6) Finishing Touches* |
|--|--|----------------------------------|--|--|-----------------------|

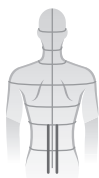
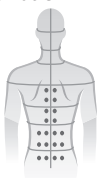
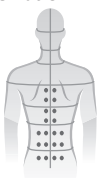

### About the massage techniques (The figures are images of the respective operations.)

#### ULTRA KNEAD

Fast kneading in small circles.

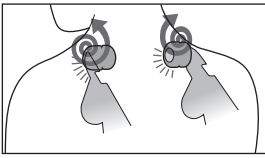

#### SHIATSU

Strong pointed massage.

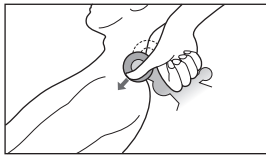

#### KNEAD

Deep kneading action.

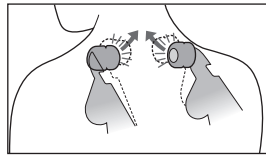

#### SWEDISH

Softer planar massage action.

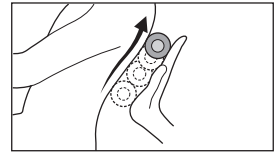

#### ROLL

Regional roll & stretch massage.

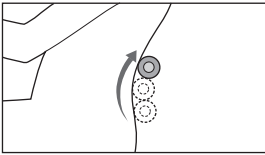

#### TAP

Tapping massage.

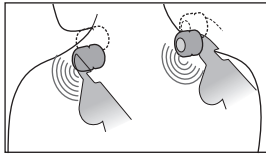

#### FULL BACK ROLL

Stretching massage along the backbone.

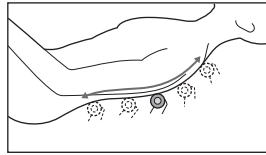

• The respective techniques are suitable for specific body parts.  
Actions of Shiatsu for the "NECK" are different from of the actions for the "SHOULDER".

### About the voice guidance function

This is a function which briefly explains the operation procedures and contents of the actions (in English).



When ready, select one of the Auto programs from the flashing buttons.

This is a program for those who prefer an intense Shiatsu-type massage from above the shoulders.

### Adjusting the voice guidance volume (only in English)

Press the **VOLUME** button to shift the volume level by one up/down.

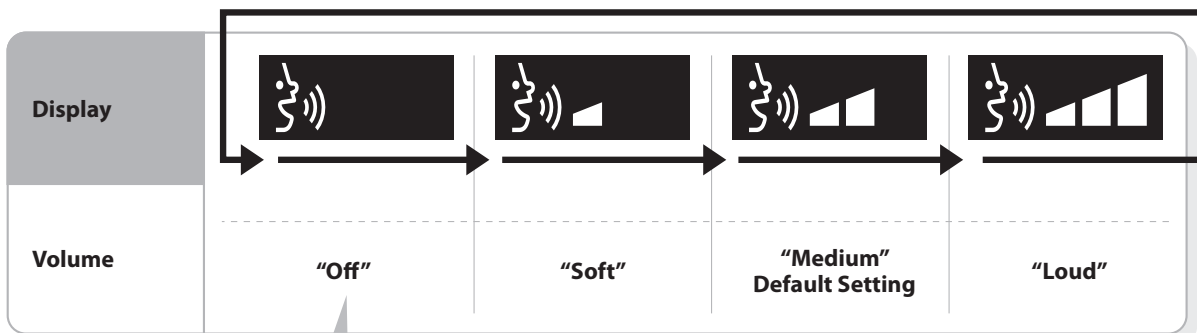

The single beep (when a button is pressed) and the triple beep (when the adjustable setting limit is reached) will always be audible.

This can be used with the volume saved during the Automatic program. (See page 24.)

# Troubleshooting

## Problem

### ▶ Cause and Remedy

#### Motor Noises

- It sounds and feels like the massage heads are straining to get over wrinkles in the cloth.
- There is operational noise of kneading or tapping actions.
- There is a creaking noise when the massage heads are in operation.
- There is a rattling sound when the massage heads move up or down.
- The belt can be heard rotating.
- The motor groans when it comes under load.
- There is a strange sound when the massage heads move in and out.
- There is a noise when I sit down.
- There is a noise when the comfort cushion moves over the armrest when the seat is reclining.
- There is a rubbing sound produced by the massage heads rubbing on the seat fabric.
- There is a noise of discharging air.
- There is operational noise when applying air pressure.
- The legrest rattles.
- There is a humming sound from the pump.
- There is operational noise of valves under the seat.
- There is an unstable sound when air escapes during the leg stretch.

▶ These sounds are perfectly normal and will not have any effect on the operation of the unit.

#### The massage heads stop during operation.

##### (All the displays and buttons on the controller will flash and then turn off.)

- ▶ If excessive force is applied to the massage heads during operation, in the interests of safety the massage heads may stop moving. If all markings and buttons on the controller start to flash, which is extremely unusual, turn off the power switch, wait for approximately 10 seconds and then turn the power switch on again.
- If the massage heads stop again, position yourself so that your back is not completely in contact with the backrest. [Caution should be exercised particularly when used by persons weighing 221 lbs (100 kg) or more.]

#### It is not possible to recline the unit.

##### The legrest cannot be raised or lowered.

##### (All the displays and buttons on the controller will flash and then turn off.)







- ▶ If the unit encounters an obstacle or if excessive force is exerted on it during operation, in the interests of safety the unit will come to a stop.
- When all displays and buttons are flashing and the backrest or the legrest has stopped, turn off the power of the unit once, turn "on" the power again after approximately 10 seconds, and then operate the unit.

#### The massage heads do not come up to the shoulder or neck.

- ▶ If your head does not contact with the pillow or your back does not contact with the backrest, the shoulder position may be detected as lower than the actual position during the body scanning. Sit on the seat in the deepest position and put your head on the pillow, and then repeat the operations again from the start. (See page 21.)

#### The height of the left and right massage heads is different.

- ▶ An alternating tapping method is employed, which means that this phenomenon will naturally occur. There is nothing wrong with the unit.

<b>Problem</b>
<b>▶ Cause and Remedy</b>
<b>“Heat” massage heads do not get warm.</b>
▶ •  button is set to Off. • Sense of warmth from the massage heads will differ depending on your body shape, massage area, massage action, clothing, and ambient temperature.
<b>The “Heat” massage heads do not cool down even after the “Heat” massage heads setting is turned off.</b>
▶ • Because of the structure of the heater, the “Heat” massage heads will feel warm for a while after heating due to the residual heat. • The temperature you feel may rise when you massage the same area for a long time even if the “Heat” massage heads setting is set to Off.
<b>Reclining does not take place even though a massage is started in pre-programs. (The backrest does not automatically recline.)</b>
▶ Automatic reclining will not activate when the backrest is reclined to flat position more than a massage position and legrest is in upper position.
<b>The backrest does not return to the upright position.</b>
▶ If the unit is stopped by automatic shut-off or by pressing the  button, it will not return automatically to the upright position. (To return from the reclined position to the original position, press the  button twice.)
<b>The unit will not operate at all.</b>
• Upper body (neck to lower back) massage • Lower body massage • Arm massage
▶ • The power cord has been disconnected. (See page 18.) • The power switch on the unit has not been turned on. • An Automatic program button or Manual Operation button hasn't been pressed after pressing  .
<b>It is not possible to massage hands and arms.</b>
▶ The air plug on the armrest is disconnected. (See page 14.)
<b>Sometimes the power won't turn on when  is pressed again when a massage has finished.</b>
▶ Approximately 5 seconds are required for program termination after a massage finishes. Wait at least 5 seconds once all movement has stopped before pressing  .
<b>The unit has been damaged.</b>
▶ Stop using the unit immediately.
<b>The power cord or power plug is abnormally hot.</b>
▶ Stop using the unit immediately.

 See Caution No. 5 and No.13 on page 4.

# Error display



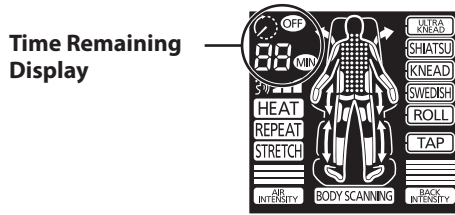



Contents of the error will be displayed in the remaining time display area when an error occurs during the operation.



<Example of error display>  
 • For the error "U10"  
 U and 10 will flash alternately.

Error display	Contents
U 10	For safety reasons, operation will terminate automatically when it cannot detect if someone is seated. If this error occurs even if you are seated, press the  button, sit back all the way to the backrest, and operate from the start again.
F 11	Operation is terminated because there is a problem with internal communication.
F 12	
F 03 F 04 F 05 F 06 F 18 F 33 F 36 F 37 F 38 F 80 F 81 F 82	Operation is terminated because there is a problem with the massage mechanism.
F 14 F 15 F 16 F 17 F 34 F 35	
	Operation except for the massage mechanism is terminated because there is a problem with the reclining mechanism or the raise/lowering mechanism of the legrest.

\* Please contact an authorized service centre.  
 Service and maintenance will be smoother if the error number is communicated when contacting.

<b>Problème</b>
► <b>Cause et solution</b>
<b>Les têtes de massage « Heat » ne se réchauffent pas.</b>
► • Le bouton  est désactivé. • La sensation de chaleur provenant des têtes de massage varie en fonction de la forme du corps, de la zone de massage, de l'action du massage, des vêtements et de la température ambiante.
<b>Les têtes de massage « Heat » ne refroidissent pas même une fois que le paramètre des têtes de massage « Heat » est désactivé.</b>
► • En raison de la structure du dispositif de chauffage, les têtes de massage « Heat » resteront chaudes pendant un moment après le chauffage grâce à la chaleur résiduelle. • La température ressentie peut augmenter lorsque vous massez la même zone pendant longtemps même si le paramètre des têtes de massage « Heat » est désactivé.
<b>Le siège ne s'incline pas, même lorsqu'une séance de massage est démarrée dans un des pré-programmes automatiques. (Le dossier ne s'incline pas automatiquement.)</b>
► L'inclinaison automatique n'est pas activée quand le dossier est incliné en position allongée au-delà de la position de massage et que le repose-jambes est en position relevée.
<b>Le dossier ne retourne pas à la position verticale.</b>
► En cas d'arrêt automatique ou commandé par le bouton  , le retour à la position verticale ne se fait pas automatiquement. (Pour passer d'une position inclinée à la position originale, appuyez deux fois sur le bouton  .)
<b>L'appareil ne fonctionne pas du tout.</b>
• Massage de la partie supérieure du corps (de la nuque à la partie inférieure du dos) • Massage de la partie inférieure du corps • Massage des bras
► • Le cordon d'alimentation est débranché. (Voir page F18) • L'interrupteur d'alimentation de l'appareil n'est pas enclenché. • Un bouton du programme automatique ou un bouton du fonctionnement manuel n'a pas été pressé après avoir appuyé sur  .
<b>Il n'est pas possible de masser les mains et les bras.</b>
► Le bouchon d'air de l'accoudoir est déconnecté. (Voir page F14.)
<b>Parfois, l'alimentation ne se met pas en marche lorsque le bouton  est de nouveau pressé lorsqu'un massage est terminé.</b>
► Il faut environ 5 secondes pour terminer un programme après la fin d'un massage. Attendez au moins 5 secondes après que tous les mouvements se sont arrêtés avant d'appuyer sur le bouton  .
<b>L'appareil a été endommagé.</b>
► Arrêtez immédiatement d'utiliser l'appareil.
<b>Le cordon d'alimentation ou la fiche d'alimentation sont anormalement chauds.</b>
► Arrêtez immédiatement d'utiliser l'appareil.

⚠ Voir les précautions N° 5 et N° 13 à la page F4.

## Panasonic Corporation of North America

One Panasonic Way, 1H-1  
Secaucus, NJ 07094

1-800-338-0552 (USA only) for questions and comments

1-877-PANAFIX (USA only) for massage chairs customer service

[www.panasonic.com/massage](http://www.panasonic.com/massage)

## Panasonic Canada Inc.

5770 Ambler Drive  
Mississauga, ON L4W 2T3

1-800-561-5505

[www.panasonic.ca](http://www.panasonic.ca)

© Panasonic Electric Works Co., Ltd. 2011

P9310MA70201  
Issued date: 2011-03-01  
Printed in Japan  
Impreso en Japón  
Imprimé au Japon



## Free Manuals Download Website

<http://myh66.com>

<http://usermanuals.us>

<http://www.somanuals.com>

<http://www.4manuals.cc>

<http://www.manual-lib.com>

<http://www.404manual.com>

<http://www.luxmanual.com>

<http://aubethermostatmanual.com>

Golf course search by state

<http://golfingnear.com>

Email search by domain

<http://emailbydomain.com>

Auto manuals search

<http://auto.somanuals.com>

TV manuals search

<http://tv.somanuals.com>