

Operating Instructions

Instrucciones de Uso
Mode d'emploi

Household Massage Lounger Sillón de Masaje Doméstico Fauteuil vibromasseur

Model No./Nº de Modelo/Nº de modèle **EP-MS40**

English	1
Español	S1
Français	F1

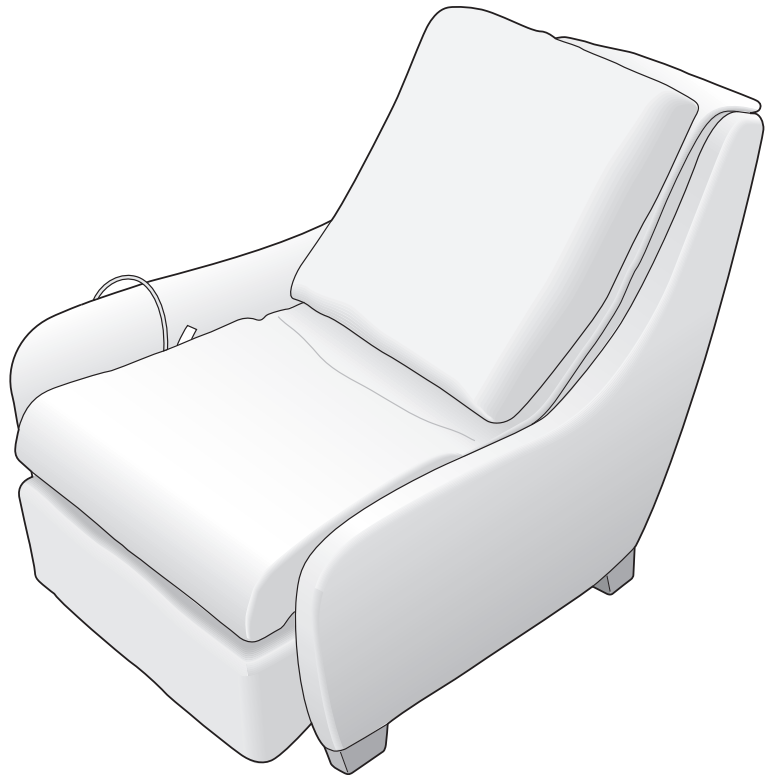

Before operating this unit, please read these instructions completely.

Antes de utilizar esta unidad, lea completamente estas instrucciones y guárdelas para referencia futura.

Avant d'utiliser cet appareil, nous vous recommandons de lire l'ensemble de ces instructions et de les ranger dans un endroit accessible pour une consultation ultérieure.



IMPORTANT SAFETY INSTRUCTIONS

Basic precautions should always be followed when using an electrical unit, including the following.

Please ensure that you read all instructions before using the Household Massage Lounger.

DANGER – To reduce the risk of electric shock:

1. Always unplug this unit from the electrical outlet immediately after using and before cleaning.

WARNING – To reduce the risk of burns, fire, electric shock, or injury to persons:

1. Always insert the power plug all the way into the outlet to reduce the risk of short-circuit and fire.
2. The unit should never be left unattended when plugged in. Always unplug the unit when not in use.
3. The unit is not to be used by people who cannot move or communicate on their own.
4. Only use the unit for the purpose described in these instructions.
5. Do not stand on the unit.
6. Do not use any accessories other than those recommended by the manufacturer.
7. Never operate the unit if it has a damaged power cord or plug. Return the unit to the nearest authorized service center if it is not working properly, if it has been dropped or damaged, or if it has been immersed in water.
8. Keep power cords away from heated surfaces. Do not carry the unit by the power cord.
9. Never block the air openings during operation and make sure that all air openings are kept free of lint and hair, etc. Do not drop or insert anything into any of the openings of the unit.
10. Do not use the unit on top of heating appliances, such as electric carpets, etc. Do not operate the unit under blanket or pillow. Excessive heating can occur and cause fire, electric shock, or injury to persons.
11. Do not use the unit in bathrooms or other damp or humid places as this may cause electric shock or cause the unit to malfunction. Do not spill water, etc. onto the controller.
12. Do not use the unit outdoors.
13. Do not use or operate where aerosol spray products are being used or where oxygen is being administered.
14. When unplugging the unit, turn off all controls before removing the plug from power outlet. Do not use the unit with a transformer as this may lead to malfunction or electric shock.
15. Connect this unit to a properly grounded outlet only. See Grounding Instructions.

SAVE THESE INSTRUCTIONS

SAFETY PRECAUTIONS

CAUTION: To avoid the risk of injury:

1. Persons with any of the conditions listed below or who are undergoing medical treatment or suffer from medical conditions should consult with their physicians before using the unit:
 - a) Pregnant women, people who are ill, in poor physical shape.
 - b) People suffering from back, neck, shoulder, or hip pain.
 - c) People who have a pacemaker, defibrillator, or other personal medical devices prone to electronic interference.
 - d) People suffering from heart disease.
 - e) People who are prohibited from receiving massage by a physician due to thrombosis or aneurism, acute varicose veins, or other circulatory disorders.
 - f) People with irregular curvatures of the spine.
2. This unit should not be used by children. Remove the key when not in use and store out of reach of children.
3. Sit down slowly after checking the position of the massage heads. Never put any part of your body between the massage heads as the squeezing action of the massage heads may cause injury. Never put your hands or feet in the gap between the unit and leg/foot massage section.
4. Do not use the unit against bare skin. While thin clothing may increase effectiveness, exposing the skin directly to the massager may irritate the skin.
Do not use the unit while wearing anything hard on your head like a hair accessory, etc. Do not use the unit for massaging the head, abdomen, front neck, elbows or knees.
Do not use excessively strong massage action on the back of the neck.
5. Do not stretch the back muscles for more than approximately 15 minutes at a time. To avoid overstretching the muscles which may result in discomfort, do not use the unit for more than 5 minutes when first using it. You can gradually increase the duration and strength of the massage as you become used to it.
Do not massage any one point for more than 5 minutes at a time.
Excessive massaging can overstimulate the muscles and nerves and result in an adverse effect.
To prevent excessive massaging, do not use the massager for more than a total of 15 minutes each session.
After approximately 15 minutes, the massage heads will be retracted and stop moving.
6. While using the massager, if you start feeling sick or if the massage seems painful, stop using it immediately. While using the massager, if the pressure seems too strong, the movement of the massage heads can be stopped at any time by pressing the Quick Stop button.
7. Do not go to sleep while using the unit. Do not use the unit after drinking alcohol.
8. Do not unplug the unit or turn it off during operation. Unplug the unit immediately if there is a power outage.
9. Be sure to start on the gentle massage program if using the massager for the first time. The shiatsu massage is stronger and should be enjoyed after one has gotten accustomed to the chair.
10. Always fold down the back pad to check that the fabric of the unit itself has not been ripped before using the unit. Please also check other areas to ensure that the fabric has not been ripped. No matter how small the rip, if you find one then immediately stop using the unit, unplug the power cord and have the unit repaired at an authorized service center.
11. Sit on the unit after confirming there is no foreign matter between the parts of the unit. (Confirm that there are no foreign objects stuck in the back pad, the seat or the leg/foot massage section.)
Failure to observe this precaution may result in accident or injury.
12. Always return the leg/foot massage section to its original position before moving the unit.
Failure to observe this precaution may result in injury due to the leg/foot massage section returning to its original position when the unit is being moved.

13. Do not drag or push the unit in an installed state.
Do not move the unit using the wheels on the floor. (Always place a mat or similar object underneath.)
The floor may be damaged.
14. Do not stand on the leg/foot massage section.
The end portion of the leg/foot massage section may rotate, or the main unit may tip, causing accident or injury.
Also, the bottom of the leg/foot massage section may make contact with and scratch the floor.
15. Do not insert your feet between the sole section and calf section of the leg/foot massage section and attempt to stand up.
Failure to observe this precaution may result in accident or injury in a fall.

OPERATING PRECAUTIONS

CAUTION: To avoid damaging the chair, follow these precautions:

1. Do not sit on or drop the controller. Do not pull the controller cord or the power cord. Be careful not to catch the cord of the controller between the armrest and the chair back.
2. Do not treat the chair roughly, such as turning the chair on its side, turning the chair over or standing on it.
3. Do not treat the covering roughly.
 - Keep sharp or pointed objects away from the covering of the chair. Be careful not to drop lit ashes, lit cigarettes or matches on the chair.
 - Exposure to direct sunlight can cause fading or a change in color of the covering.
4. If the massager functions abnormally, immediately turn off the power and have the massager checked by an authorized service center.
5. Do not repeatedly operate any switch at short intervals. Such action may cause the switch to malfunction.
6. Some noise may be heard coming from the massager while in use. This is due to the structure of the massager and is normal.
7. When excessive pressure is applied to the massage heads, they may stop moving for safety. When moving the heads up from the lowered position, one's body weight may stop the heads' movement. In such a case, slightly raise your body and allow the massage heads to move up.
8. After each massage, slide the power switch, which is located on the back side of the chair, to the "off" position and turn its lock switch to the "lock" position. Remove the key and power plug.
9. Do not sit on the chair with wet body or hair.
10. The unit must not be used in "wet rooms" (sauna, swimming pool) or outdoors.
11. Do not attempt to open or disassemble any part of the unit. Only use an authorized Panasonic servicer to fix your unit.

GROUNDING INSTRUCTIONS

This product must be grounded. If it should malfunction or break down, grounding provides a path of least resistance for electric current to reduce the risk of electric shock. This product is equipped with a cord having an equipment-grounding conductor and a grounding plug. The plug must be plugged into an appropriate outlet that is properly installed and grounded in accordance with all local codes and ordinances.

DANGER

Improper connection of the equipment-grounding conductor can result in a risk of electric shock. Check with a qualified electrician or serviceman if you are in doubt as to whether the product is properly grounded. Do not modify the plug provided with the product – if it will not fit the outlet, have a proper outlet installed by a qualified electrician.

This product is for use on a nominal 120-volt circuit and has a grounding plug that looks like the plug illustrated in Figure A. Make sure that the product is connected to an outlet having the same configuration as the plug. No adapter should be used with this product.

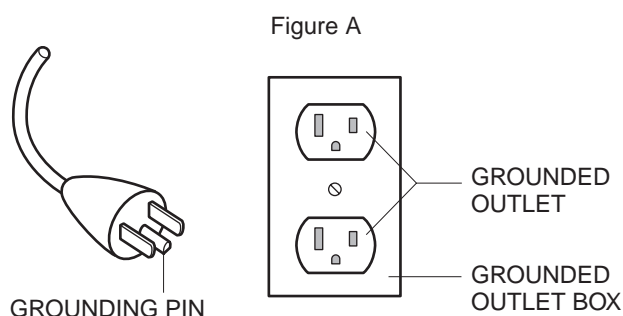

SPECIFICATIONS

Power Supply:	AC 120 V 60 Hz
Rated Current:	1.2 A
Upper Body Massage	
Massage area (Up-Down):	Approx. 25.6 in. (65 cm) [The massage heads move a total of approx. 23.6 in. (60 cm)]
Massage area (Left-Right):	Distance between massage heads during operation Neck, Shoulder, Back, Lower back: Approx. 1.6 in. – 5.9 in. (4 cm – 15 cm)
Massage area (Forward-Back):	Projected amount of massage head (Intensity adjustable) Approx. 2.3 in. (6 cm)
Massage speed:	Soft shiatsu: Approx. 285 cycles/minute – 400 cycles/minute (single side) Knead: Approx. 14 cycles/minute – 25 cycles/minute Tap: Approx. 375 cycles/minute – 495 cycles/minute (single side)
Vertical travel:	Vertical travel (Long): Approx. 25.6 in. (65 cm) up-down auto return
Massage width:	Same as massage area (left-right)
Air massage	
Air Pressure (Calf):	3: Approx. 32 kPa 2: Approx. 28 kPa 1: Approx. 20 kPa
Automatic shut-off:	Automatically turns off after a maximum of 15 minutes
Dimensions (H x W x D):	Approx. 33.5 in. x 27.5 in. x 42.5 in. (85 cm x 70 cm x 108 cm)
Weight of Unit:	Approx. 103.9 lbs (47 kg)
Dimensions of box (H x W x D):	Approx. 37 in. x 30.7 in. x 48 in. (94 cm x 78 cm x 123 cm)
Weight in box:	Approx. 130 lbs (59 kg)

- For those who weighing 220 lbs (100 kg) or more, the product operations may make more noise and the fabric cover may wear faster.
- This product is designed for users of between 61 to 72.8 in. (155 to 185 cm) in height. Users who are taller than approximately 72.8 in. (185 cm) or shorter than approximately 61 in. (155 cm) may not be able to use the upper body massage and leg/foot massage simultaneously.

PART NAMES AND FUNCTIONS

Main unit

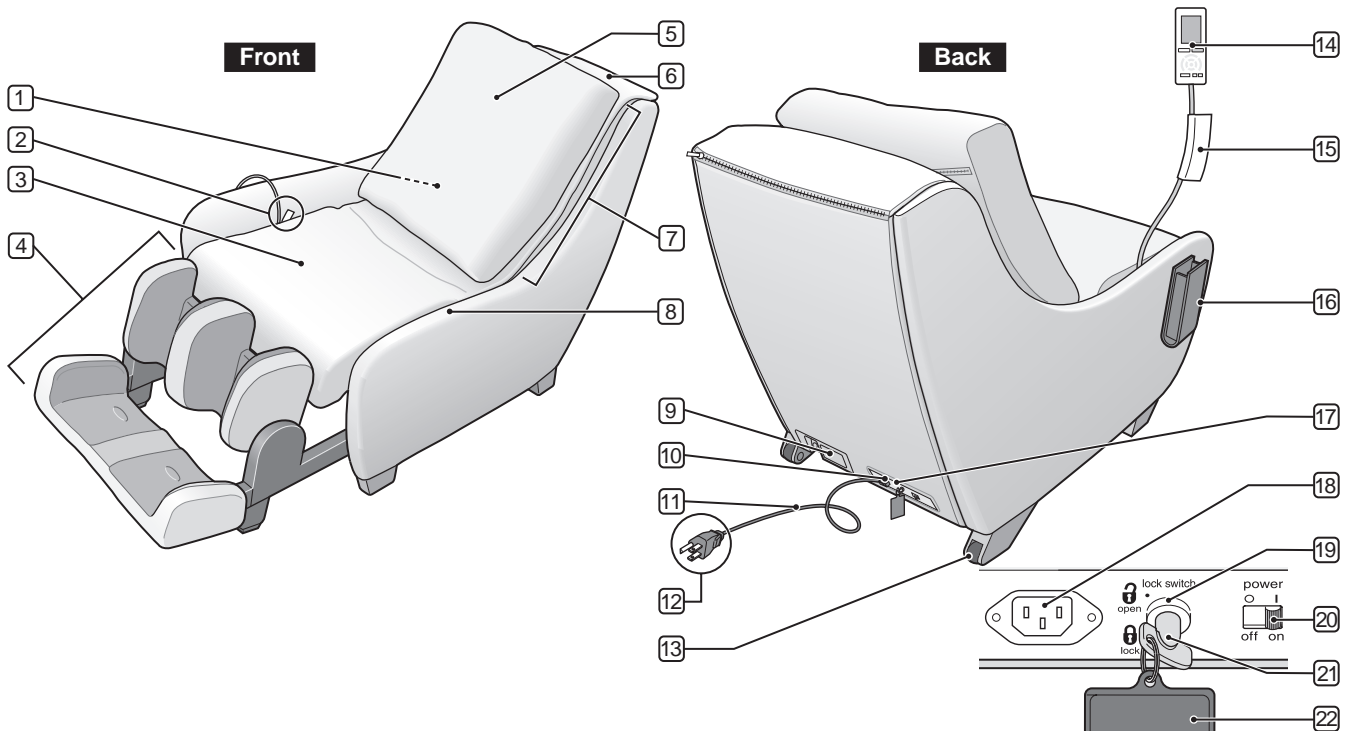

1 Retracted Position of Massage Heads

2 Leg/foot massage lock release strap
• See page 11.

3 Seat

4 Leg/foot massage section
• Includes an air massage function.

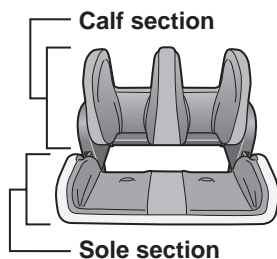

5 Backrest Cushion

6 Back Pad

7 Backrest
• Includes integrated massage heads.

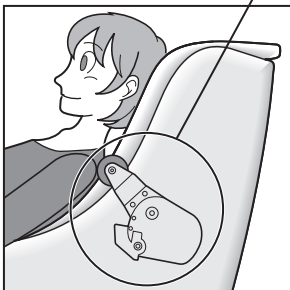

8 Armrest

9 Specification Label

10 Connector

11 Power Cord
• Cord length: approx. 70.8 in. (1.8 m)

12 Power Plug

13 Wheels

14 Controller

15 Safety Precaution Label

16 Controller Holder

17 Power switch section

- See page 12.
- Lock switch is set to “open” and power switch is set to “on” prior to leaving the factory.

18 Appliance inlet

19 Lock Switch





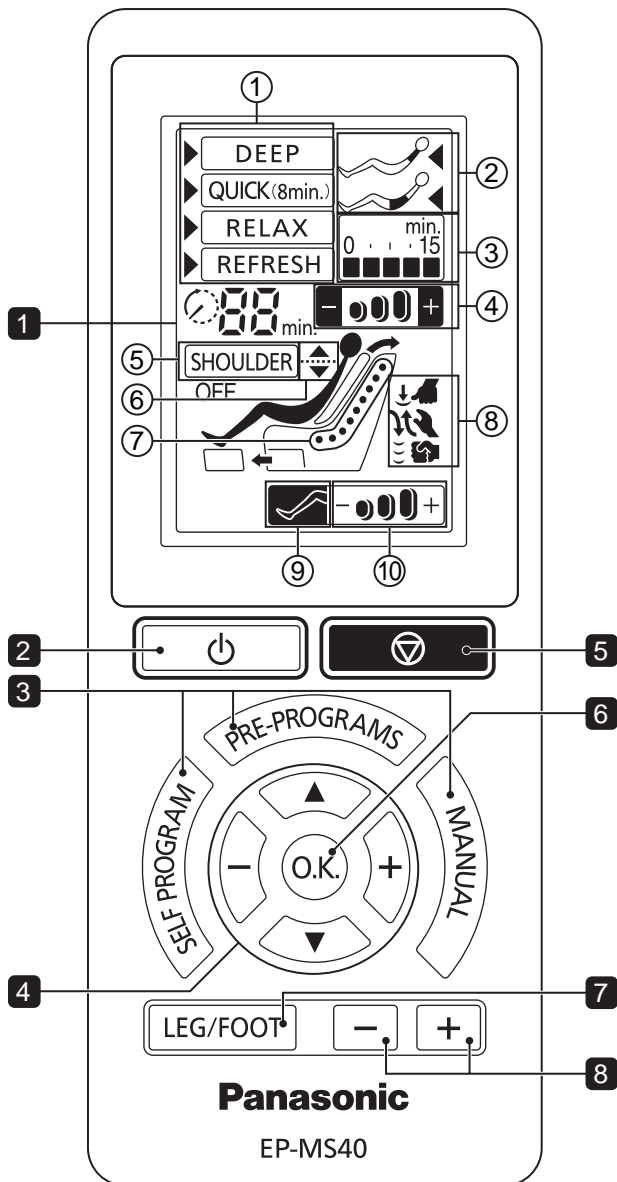

20 Power Switch

21 Lock Switch Key

22 Lock Switch Key Tag
• To prevent children from accidentally swallowing the lock switch key.



Display

- ① **Pre-Programs Display**
 - When selecting a program: The ▶ mark for the currently selected program flashes.
 - During the massage: The frame of the current program is displayed.
- ② **Self Program Display**
 - When selecting a program: The ◀ mark for the currently selected program flashes.
 - During the massage: The current program ( or ) is displayed.
- ③ **Self Program Set Time Display**
 - Displayed when the Self Program is selected.
- ④ **Program Intensity Display**
 - Displays current program intensity in 3 levels.
- ⑤ **Shoulder Checking Operation Display**
 - Flashes during a shoulder checking operation.
- ⑥ **Shoulder Position Adjustment Mode Display**
 - Only the dotted line part (.....) flashes in shoulder position adjustment mode (approximately 15 seconds).
- ⑦ **Massage Head Position Display**
 - Displays current approximate position of massage heads.
- ⑧ **Massage Operation Display**
 - Displays current massage operation.
 -  Soft shiatsu
 -  Knead upwards
 -  Knead downwards
 -  Tap
- ⑨ **Leg/Foot Massage Off/On Display**
 - Lights up when the leg/foot massage is activated.
- ⑩ **Leg/Foot Massage Intensity Display**
 - Displays intensity of current leg/foot massage in 3 levels.

1 Display

- This illustration is when all lamps are illuminated.

2 Off/On button

- Switches the controller on and off.

3 Menu selection buttons

4 Up/down/- + adjustment buttons

5 Quick Stop button

- Press this button to stop the massage immediately.

6 O.K. button

7 Leg/foot massage on/off button

8 Leg/foot massage intensity adjustment buttons

SETTING UP THE UNIT

Where to use the unit

Leg/foot massage section
Approx. 15.7" (40 cm)

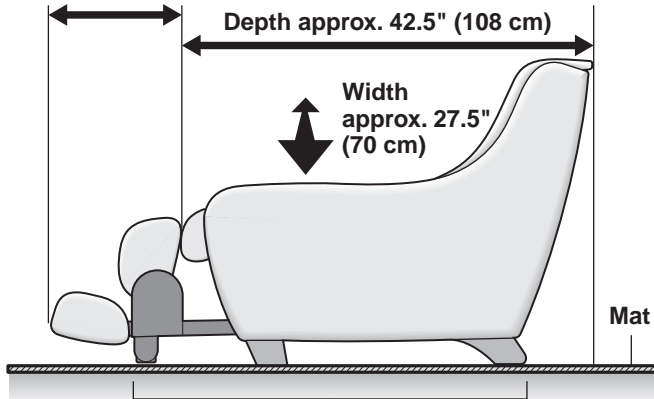

Area where the unit and leg/foot massage section touch the floor approx. 45.3" (115 cm)

- Do not expose the massage lounger to direct sunlight or high temperatures, such as in front of heating sources, because this can cause discoloration or hardening of the surface material.
- Placing a mat or cloth under the unit is recommended to prevent floor damage. The size of the mat should be sufficient [at least 25.6 in. x 45.3 in. (65 cm x 115 cm)] to cover the areas where the unit touches and where the leg/foot massage section could touch the floor.
- Set the unit near the outlet.
- Position the unit so that the back is not in contact with any other object (such contact may cause warping and lead to damage).

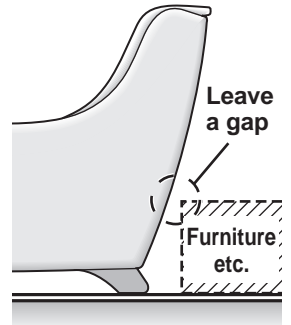

⚠ See Warning No. 10 and 11 on page 1.

1 Unpack the unit

Inspect contents of shipping container.

Main unit

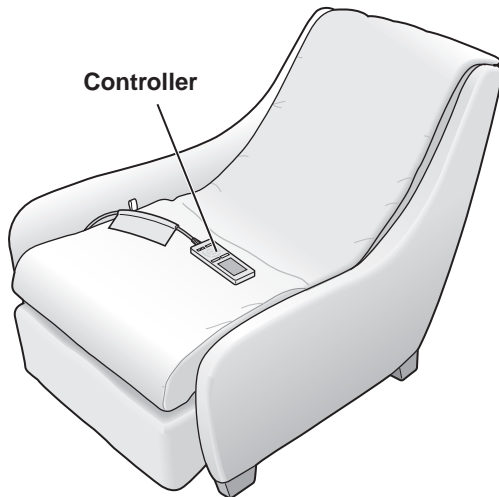

Accessories

Controller Holder

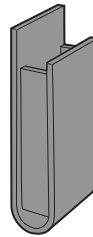

Backrest cushion

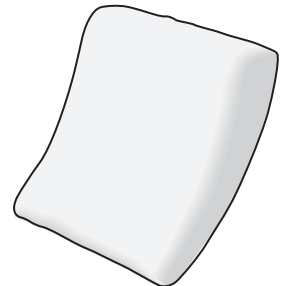

Lock Switch Key



Power cord

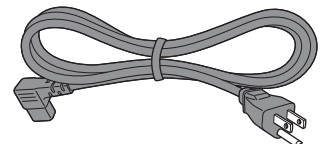

- The lock switch key has been inserted in the lock switch prior to leaving the factory.

2 How to move the unit

Since the unit is very heavy [approximately 103.4 lbs (47 kg)], be careful to avoid back injuries. (The unit must be carried by two people.)

Put the unit down slowly and carefully watch your step.

⚠ See Caution No. 13 on page 3.

Lifting the Unit

- You may damage the floor by dropping the unit if you do not hold it correctly.
- Check that the leg/foot massage section is stored away and locked.

Place the controller and power cord on the seat

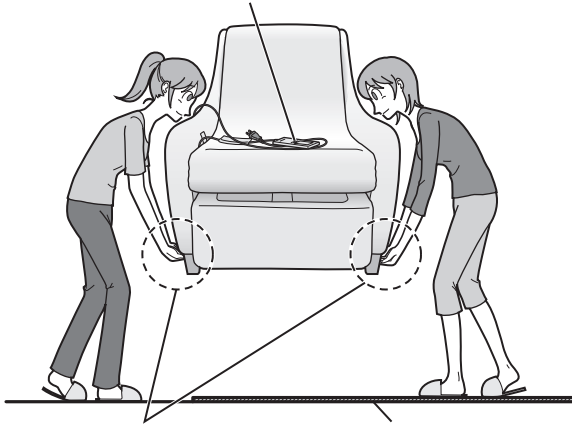

Hold the sides of the main unit

Placement area (place a mat to protect the floor)

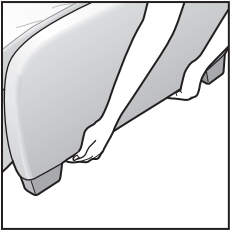

In narrow corridors etc., hold the front and rear of the main unit.

Place the controller and power cord on the seat

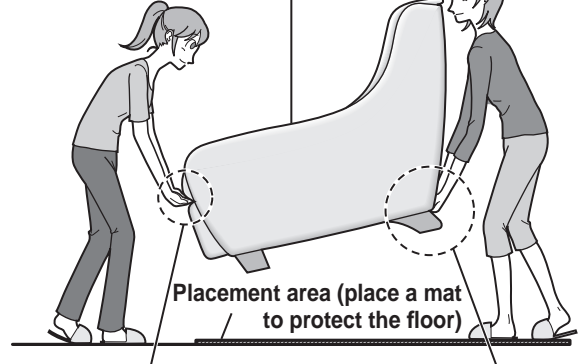

Placement area (place a mat to protect the floor)

At the front

Hold the stiff metal part within the main unit

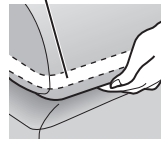

Hook your fingers on the dent under the main unit

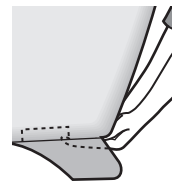

Using the wheels to move the unit

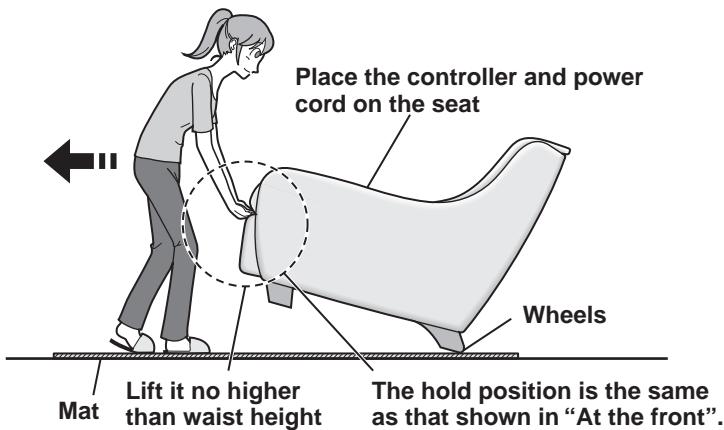

3 Attach the controller holder, and insert the controller

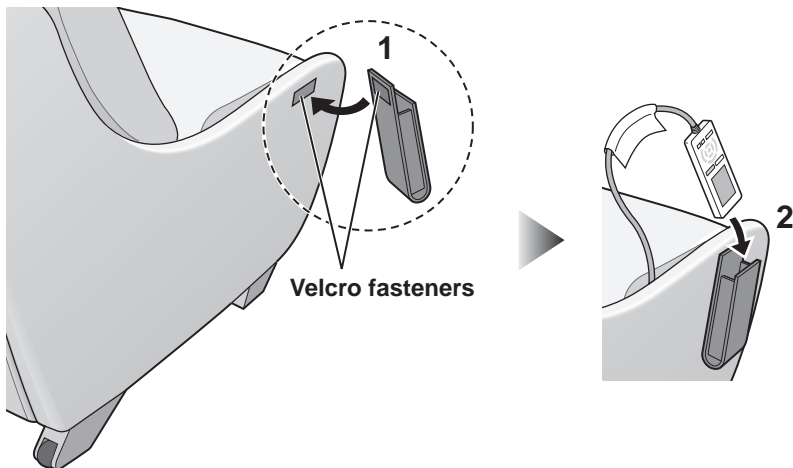

4 Put the backrest cushion in place

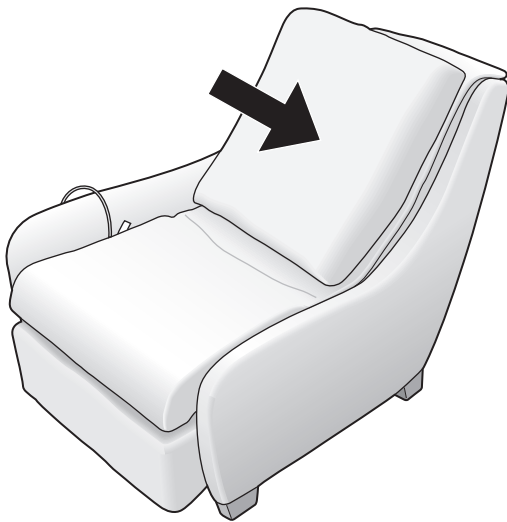

5 Connect the power cord to the unit

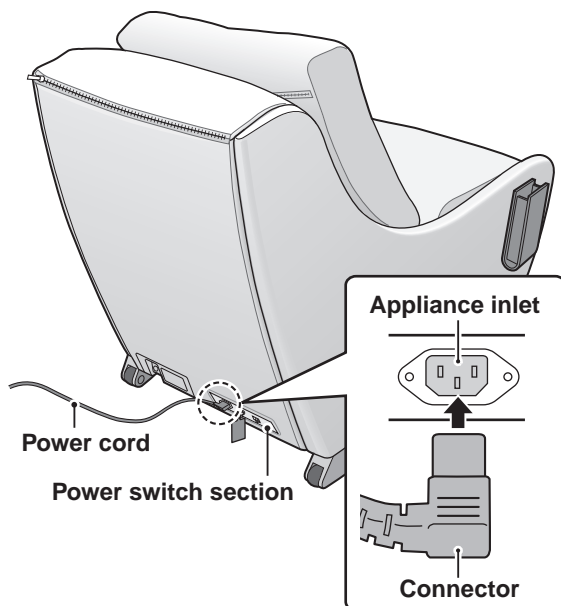

- 1** Check for dirt and damage on appliance inlet of the power switch section and the connector of the power cord.
- 2** Insert the connector into the appliance inlet.
- 3** Be sure to push the connector in all the way.

BEFORE EVERY MASSAGE (CHECK THE UNIT)

1 Remove the backrest cushion.

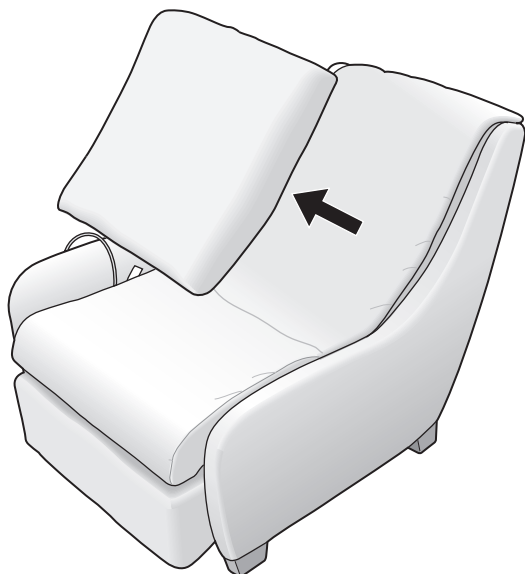

2 Make sure there are no tears or rips in the fabric.

⚠ See Caution No. 10 on page 2.

Unfasten the zippers (3 locations) and fold down the back pad

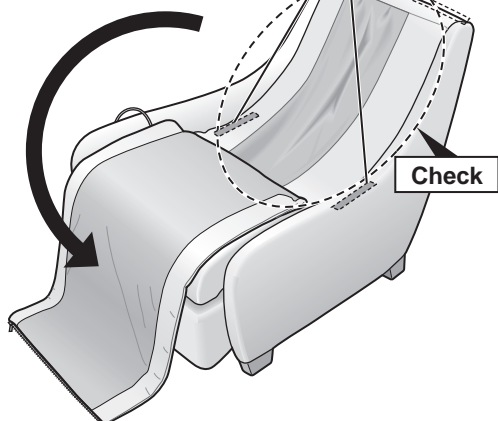
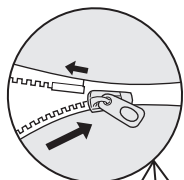

3 Make sure the massage heads are in the retracted position and then replace and fasten the back pad.

⚠ See Caution No. 3 on page 2.

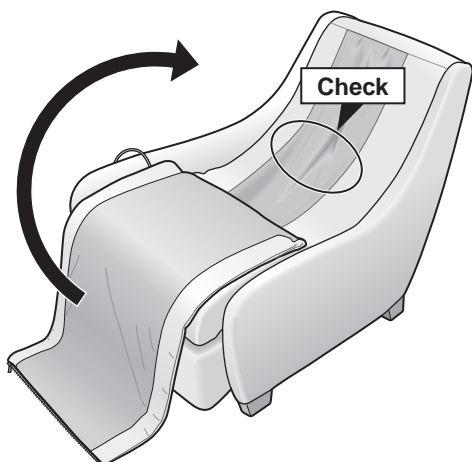

When the massage heads are not in the retracted position

- After step 7, press the  button on the controller twice to return the massage heads to the retracted position.

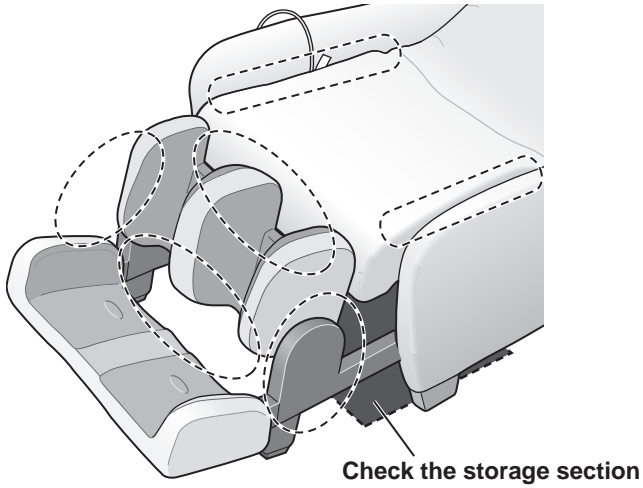

4 Make sure there is no foreign matter between the unit.

⚠ See Caution No. 11 on page 2.

Notes

How to take out and store away the leg/foot massage section

- 1 Pull up on the leg/foot massage lock release strap.
 - The leg/foot massage section is ejected halfway with the sole section closed.
- 2 Pull the leg/foot massage section as far as it goes.
- 3 Open the sole section by tilting forward.
- 4 After confirming there are no obstructions, push the leg/foot massage section under the seat with your hand.
 - Continue pushing firmly until you hear a click as it locks.

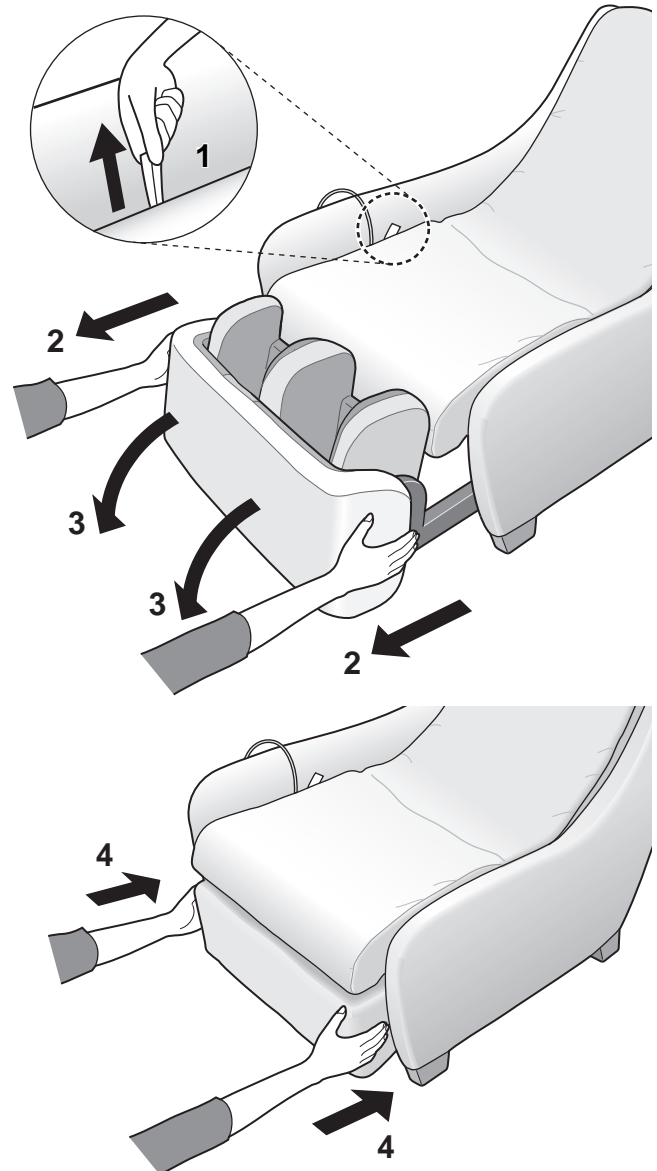

Check for damage

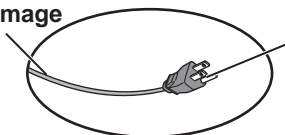

Check for dirt and damage

5 Check the power cord and the power plug.

⚠ See Warning No. 7 on page 1.

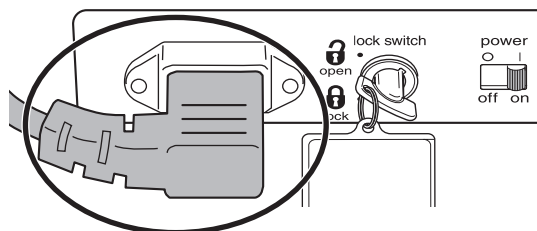

6 Be sure to push the power connector all the way into the appliance inlet.

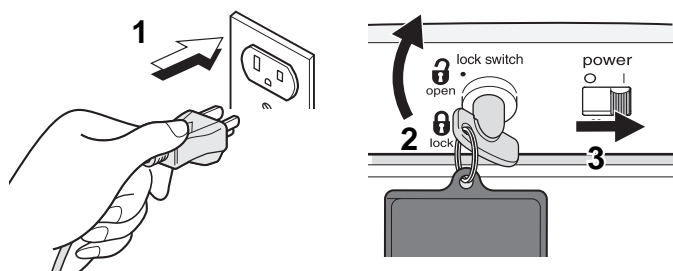

7 Switch on the power supply.

⚠ See Warning No. 1 on page 1.

- 1) Insert the power plug into an electrical outlet.
- 2) Turn the lock switch key to the “open” position.
- 3) Slide the power switch to the “on” position.

8 Sit down in a massage position.

Sit with the back of your head aligned with the upper part of the backrest.

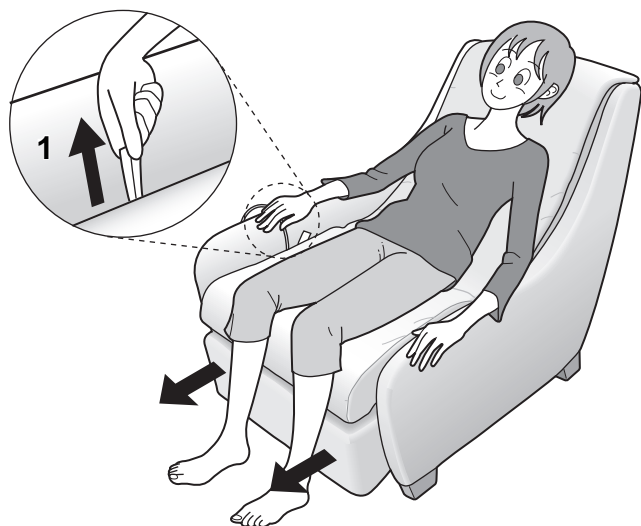

Only when using the leg/foot massage

9 Take out the leg/foot massage section and put your feet on it.

- 1) Pull up the leg/foot massage lock release strap.
 - The leg/foot massage section will extend forward slightly.
- 2) Put your feet on the sole section.
- 3) Push your feet down and forward on the sole section and the calf section will flip up.

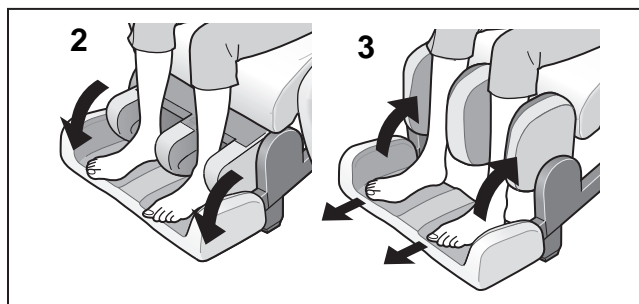

If you cannot reach the leg/foot massage section to push it forward

Try following **A** and **B**.

A Slide your body forward.

B Use the leg/foot massage section without fully extending it and with the calf section in a near vertical position.

- If the above position feels uncomfortable, use the leg/foot massage section with the calf section tilting forward. (In this case your calves will not be massaged. To enjoy a calf massage, please use the leg/foot massage section separately.)

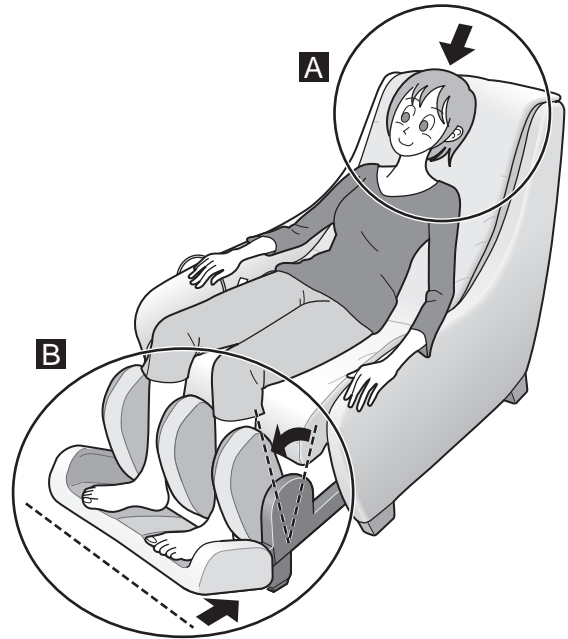

When, due to your height, your knees are held above the seat in an uncomfortable position

Do the following **A** or **B**.

A Store away the leg/foot massage section and stretch out your legs.

- Use the leg/foot massage function separately.

B Slide your body upwards so that your knees are no longer forced upwards.

- In this case, please massage your neck and shoulders separately using Self Program.

SELECTING A MENU AND STARTING THE MASSAGE

- After 15 minutes of use, we recommend that you take a 10 minute break.
 - Use the unit up to twice per day, for a total of 30 minutes.
- ⚠ See Caution No. 5 and 9 on page 2.

1 Press the  button to turn on the power.

The menu selection buttons flash.

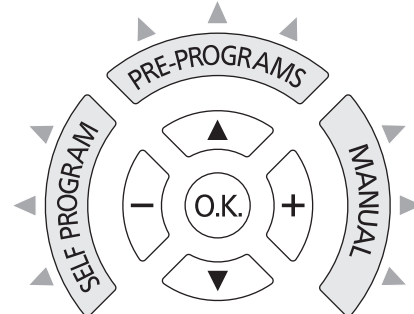

(The power will turn off automatically if you do not select a menu or start a leg/foot massage within 3 minutes after turning on the power.)

2 Upper body massage

Select a menu from among Pre-Programs, Self Program and Manual operation.



Pre-Programs

See page 15.

You can select from among 4 programs for automatically loosening from neck to lower back.



Self Program

See page 18.

You can select "neck and shoulders" or "back and lower back". You can also select the massage time (15 minutes or less).



Manual operation

See page 21.

You can concentrate the massage on desired areas.

Leg/foot massage

Press the  button.

See page 23.

Leg/foot massage can be used by itself or simultaneously with the upper body massage.

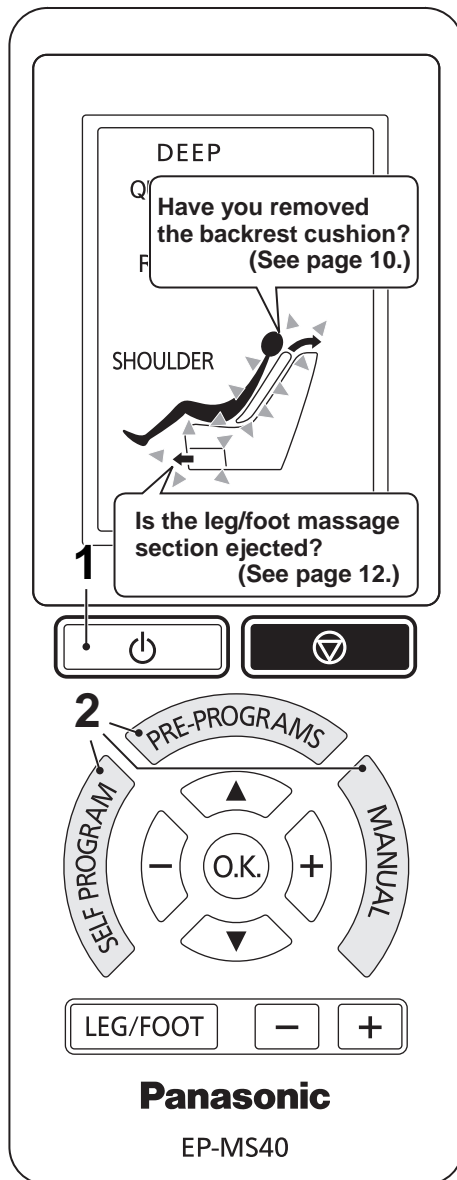

* The above display appears even when the backrest cushion has been removed and the leg/foot massage section is ejected.

USING PRE-PROGRAMS

[Program Selection Mode]

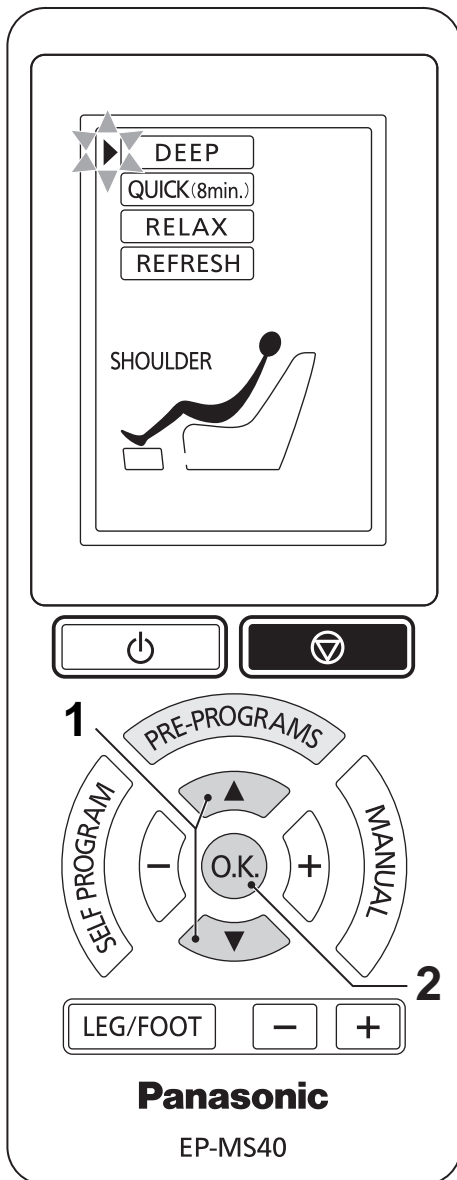

Press the **PRE-PROGRAMS** button to enter the program selection mode for Pre-Programs.

(The power will turn off automatically if no operation is performed within 3 minutes after entering the program selection mode.)

1 Press or to select a program.

Select one of "DEEP", "QUICK (8 min)", "RELAX" and "REFRESH".

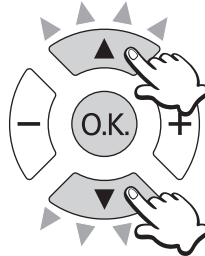

The mark for the currently selected program will flash.

2 Select a program and press the **O.K.** button.

1) Put your head on the backrest.

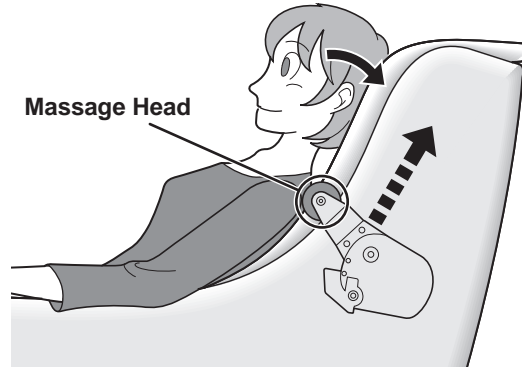

The massage heads will move slowly upwards with the unit emitting a beeping sound.

2) When the massage heads reach the top, an operation to determine your approximate shoulder position will begin. [Shoulder checking operation]

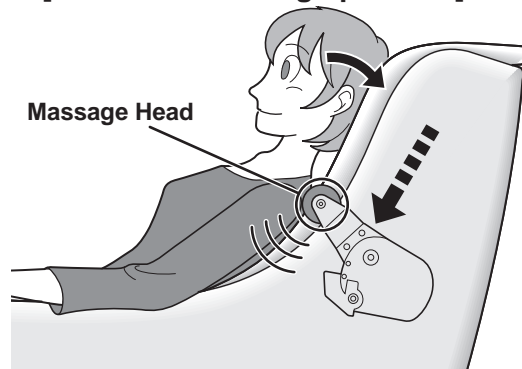

The massage heads slowly lower while performing a tapping action. (The frame of **SHOULDER** flashes.)

- For some sitting positions, the massage heads may temporarily reach a position near the lower back.

Pre-Programs characteristics

DEEP

Uses Knead, Soft Shiatsu and Tap actions to loosen up the muscles from neck to lower back.

Recommended for those with severe stiffness or who prefer a stimulating massage.

QUICK (8 min.)

Based on the DEEP program, this program concentrates on the areas which tire easily and is short at 8 minutes.

Recommended for those who want a spare-time massage.

RELAX

Uses less stimulating actions to relax your body.

Recommended for those who want to relax with a gentle massage.

REFRESH

Lowers the massage intensity gradually and then raise it to achieve refreshment.

Recommended for switching mood.

3) A double beep and the flashing of  indicate that the massage heads are being finely adjusted to the shoulder position.
[Shoulder Position Adjustment Mode]

<How to adjust>

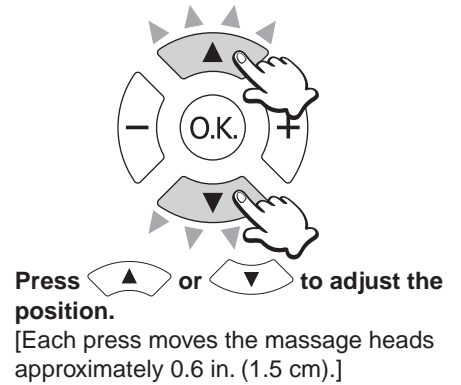
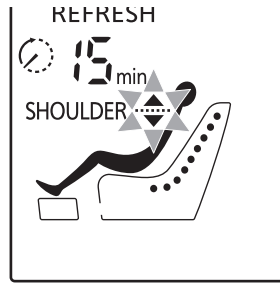

4) When the shoulder position is matched, press  to begin the program.

- The program will begin automatically after 15 seconds if the  button is not pressed.

Caution

Keep your head on the backrest while shoulder position is being determined.
 If the shoulder position cannot be correctly determined, an error message (U10) is displayed and operations are terminated.





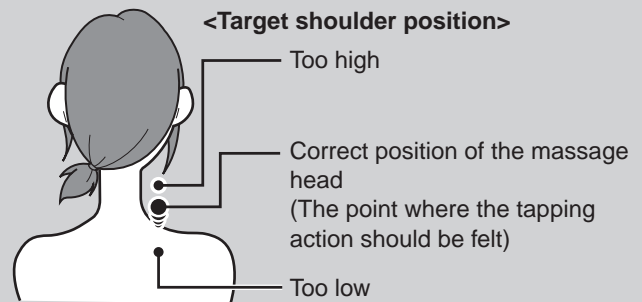

Notes

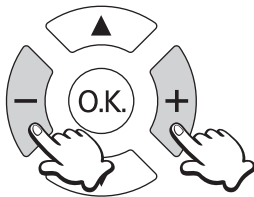

To Customize

To adjust program intensity



Content of display			
Intensity	1	2	3
Adjustment	-  +		

Press the - + adjustment buttons.

To use the leg/foot massage simultaneously

Press the  button.
 (See page 23.)

To change the content of the message

To select a different program from Pre-Programs

Press the  button, and select a different program.

Upper body massage will stop temporarily.
(See page 15.)

To change to Self Program

Press the  button and select a program.

Upper body massage will stop temporarily.
(See page 18.)

To change to Manual operation

Press the  button.

Action will start immediately.
(See page 21.)

Display during program

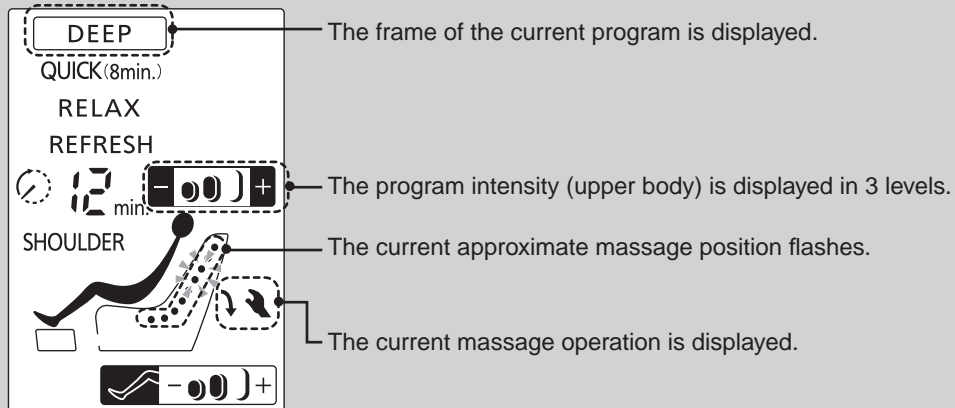

USING SELF PROGRAM

[Program Selection Mode]

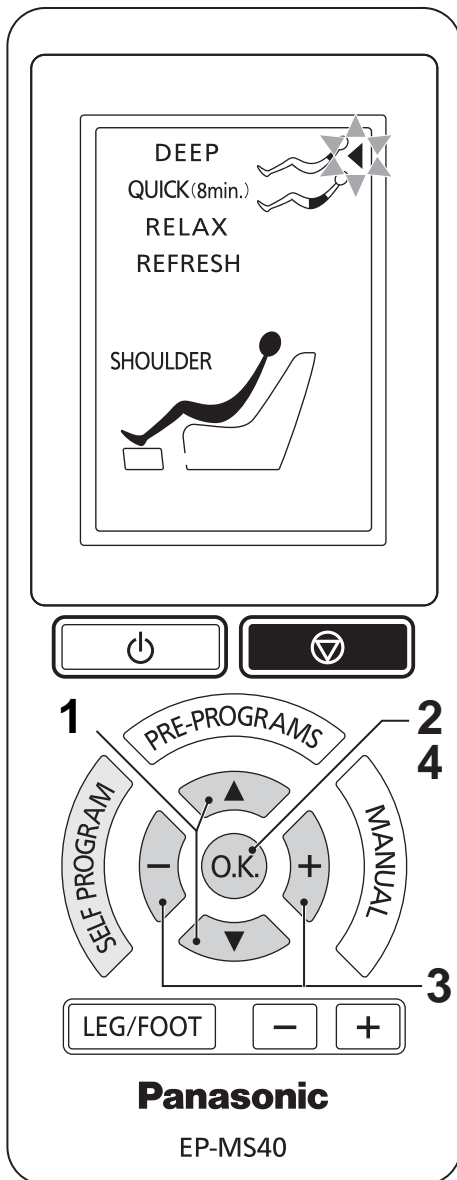

Press the **SELF PROGRAM** button to enter the program selection mode for Self Program.

(The power will turn off automatically if no operation is performed within 3 minutes after entering the program selection mode.)

1 Press or to select a program.

Select either "Neck and shoulders" or "Back and lower back".

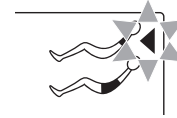
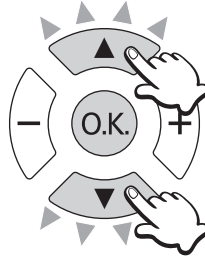

The mark for the currently selected program will flash.

2 Select a program and press the **O.K.** button.

3 Set duration of massage.

Press the - + adjustment buttons.

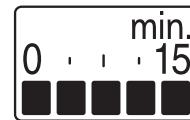
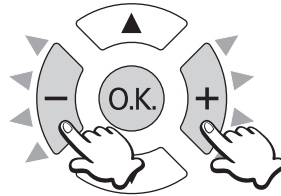

Time indicator

0 . . . 15	Approx. 15 minutes
0 . . . 15	Approx. 12 minutes
0 . . . 15	Approx. 9 minutes
0 . . . 15	Approx. 6 minutes
0 . . . 15	Approx. 3 minutes

Note: When you change to "SELF PROGRAM" halfway through another type of massage, you can make selections for the time remaining.

4 Press the **O.K.** button to complete the setting.

When you have selected “Neck and shoulders”

The operation to determine your approximate shoulder position will begin.

(See page 15.)

1 A double beep and the flashing of  indicate that the massage heads are being finely adjusted to the shoulder position.

[Shoulder Position Adjustment Mode]

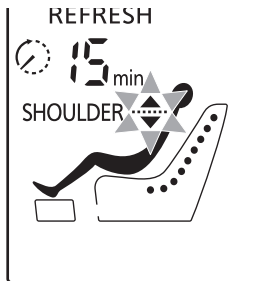

<How to adjust>

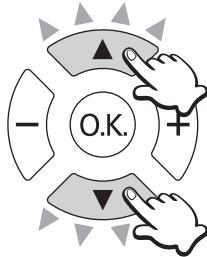

Press  or  to adjust the position.

[Each press moves the massage heads approximately 0.6 in. (1.5 cm).]

2 When the shoulder position is matched, press  to begin the program.

- The program will begin automatically after 15 seconds if the  button is not pressed.

When you have selected “Back and lower back”

The operation to check you are seated (tapping around shoulders) will begin.

When the unit has confirmed that you are seated, the massage heads move to your back or lower back and the program begins.

Caution

Keep your head on the backrest until the program starts. Otherwise an error message (U10) is displayed and operations are terminated.



To Customize

To adjust program intensity

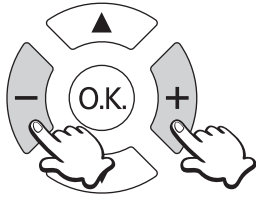

Content of display			
Intensity	1	2	3
Adjustment	- ←————→ +		

Press the – + adjustment buttons.

To use the leg/foot massage simultaneously

Press the button.

(See page 23.)

To change the content of the massage

- With Self Program, you cannot set a massage longer than the massage time you first set.

If you set a short time by mistake, end the massage, and then press the button again and enter new settings.

To select a different program from Self Program

Press the button, and select a different program.

Upper body massage will stop temporarily.
(See page 18.)

To change to Pre-Programs

Press the button and select a program.

Upper body massage will stop temporarily.
(See page 15.)

To change to Manual operation

Press the button.

Action will start immediately.
(See page 21.)

USING MANUAL OPERATION

⚠ See Caution No. 5 on page 2.

Press the  button.

1 The operation to check you are seated (tapping around shoulders) will begin.







Caution

Keep your head on the backrest until the massage begins. Otherwise an error message (U10) is displayed and operations are terminated.



2 When the unit has confirmed that you are seated, 6 types of action including Soft Shiatsu, Knead and Tap are performed sequentially.

<Sequence of massage operations>

1		Knead upwards	4		Tap
2		Soft shiatsu	5		Upward knead and tap
3		Knead downwards	6		Downward knead and tap

[Display during massage]

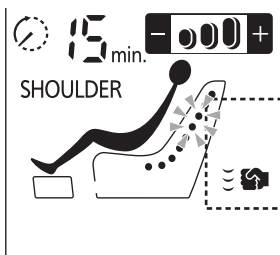

Massage Operation Display

The operations change automatically.

- When the same spot has been massaged continuously for 5 minutes, the massage position is automatically moved upwards by around 1.2 in. (3 cm).

To Customize

To adjust the position

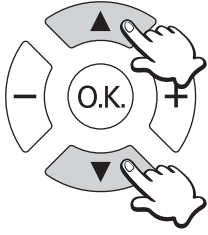

Press  or  to adjust.



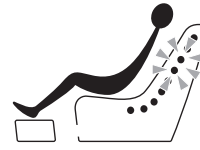

- Each press moves the massage heads approximately 0.6 in. (1.5 cm).
- When you hold down the button, the operation will continue until you release it.

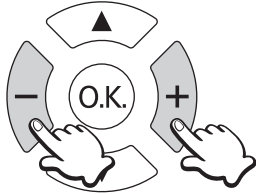

Flashing indicates the approximate current position.

To adjust program intensity



Content of display			
Intensity	1	2	3
Adjustment	—  — +		

Press the — + adjustment buttons.

To continue exclusively with a single operation such as Soft Shiatsu or Knead

Press the  button during an operation to continue the same operation only.

- To change the operation, press the  button again. The operations will then change automatically in sequence.

To use the leg/foot massage simultaneously

Press the  button.
(See page 23.)

To change the content of the massage

To change to Self Program

Press the  button and select a program.

Upper body massage will stop temporarily.
(See page 18.)

To change to Pre-Programs

Press the  button and select a program.

Upper body massage will stop temporarily.
(See page 15.)

USING LEG/FOOT MASSAGE FOR CALVES AND SOLES

Press the **LEG/FOOT** button.

The leg/foot massage begins.

- Press the **LEG/FOOT** button again to end the massage.
When you are using leg/foot massage only, terminate the massage using the  button.

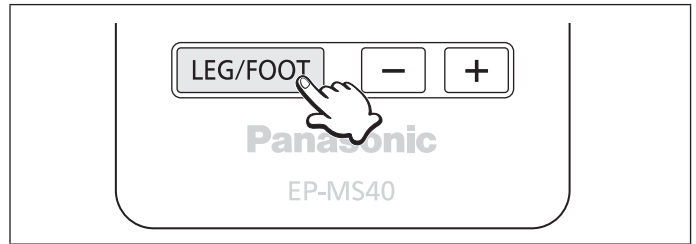

To adjust the intensity of the leg/foot massage

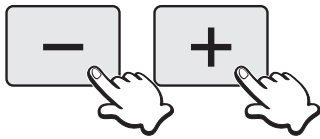

Press the leg/foot massage buttons   to adjust the intensity.

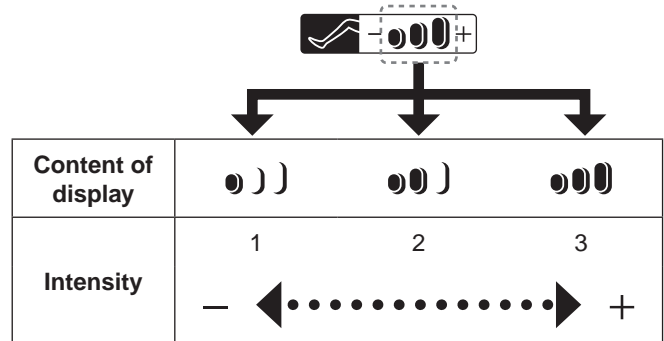

Leg/foot massage duration

To use leg/foot massage only:

The massage lasts for approximately 15 minutes.

To combine with upper body massage:

When the upper body massage ends, the leg/foot massage ends simultaneously.

Operations of leg/foot massage

Calf

Calves will be compressed by pressing against from both sides.

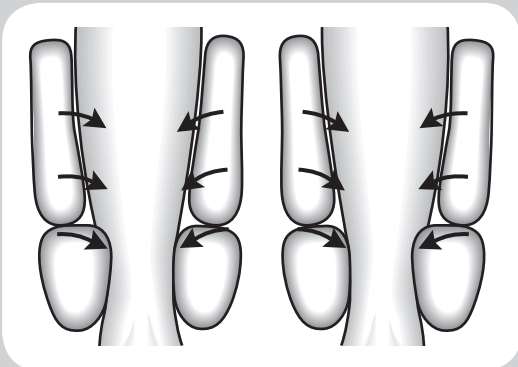

Sole

Foot will be compressed from bottom using the air.

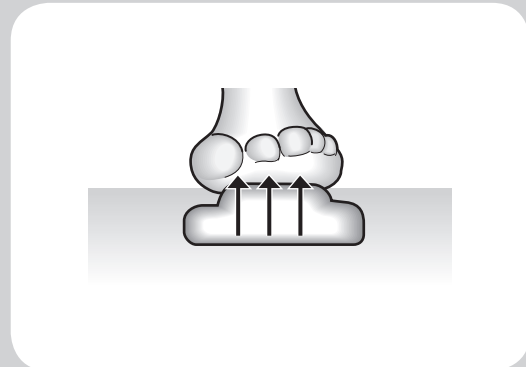

AFTER COMPLETING THE MASSAGE

Timer function

The massage will complete automatically approximately 15 minutes after the start of operations.

Interrupting the massage

Press the  button.

- The massage heads move to the retracted position.

If you experience any problems

Press the  button.

- All operations will stop immediately.
- Get off the unit carefully to prevent the unit from tipping over.

Returning to the lounge state

⚠ See Caution No. 14 and 15 on page 3.

1 Store away the leg/foot massage section.

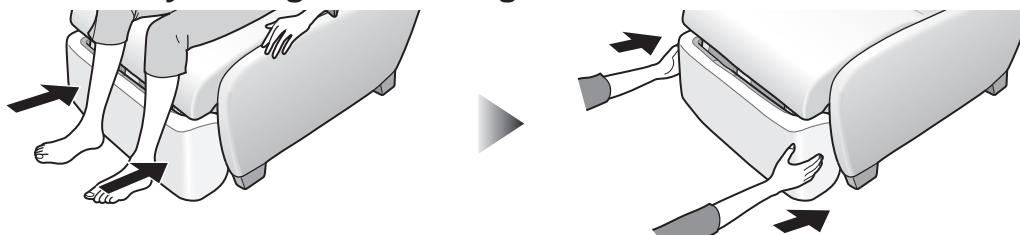

- Check for obstructions in the storage section.
- Push the leg/foot massage section under the seat with your hands.
- Continue pushing firmly until you hear a click as it locks.

2 Put the backrest cushion in place.

Disconnecting the power

⚠ See Danger No. 1 on page 1, Caution No. 2 on page 2, and No. 8 on page 3.

1 Slide the power switch to the “off” position.

2 Turn the lock switch key to the “lock” position and remove it.

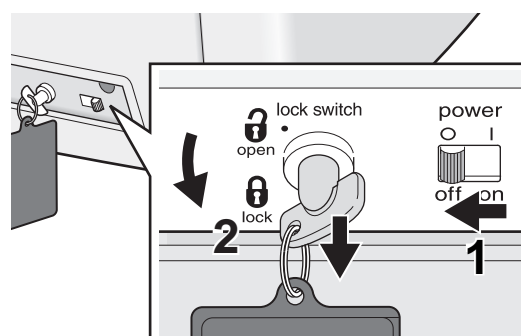

3 Remove the power plug from the electrical outlet.

4 The lock switch key must be stored out of the reach of children.

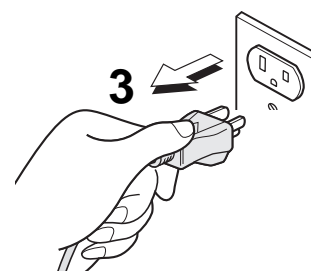

CLEANING AND MAINTENANCE

⚠ See Danger No. 1 on page 1.

Seat Fabric

- 1 Wipe the unit with a cloth moistened with mild detergent and thoroughly wrung out.**
 - Never use chemicals such as thinner, benzine, alcohol, etc.
- 2 Use water or a mild detergent and brush on areas where the seat fabric is particularly soiled.**
 - Be careful not to brush the fabric too much to avoid damage.
- 3 Wipe the unit with a cloth moistened with plain water and thoroughly wrung out.**
- 4 Allow the unit to dry naturally.**

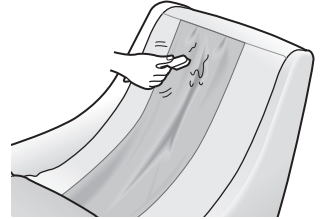

Plastic Area

- 1 Wipe the unit with a cloth moistened with mild detergent and thoroughly wrung out.**
 - Never use chemicals such as thinner, benzine, alcohol, etc.
- 2 Wipe the unit with a cloth moistened with plain water and thoroughly wrung out.**
 - Make sure to wring tightly before wiping the controller.
- 3 Allow the unit to dry naturally.**

You can remove the backrest cushion cover and back pad for washing.

Backrest cushion cover

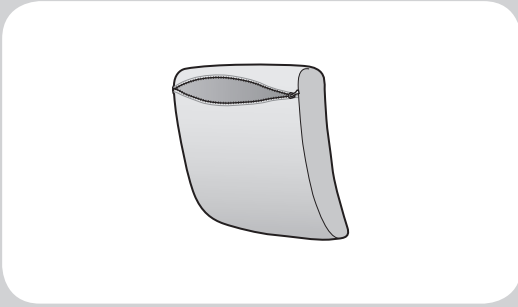

Back pad



How to wash

Cautions for washing

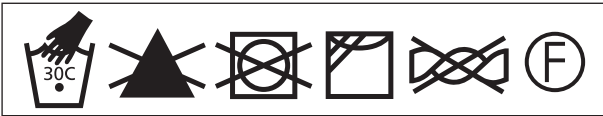

To hand wash (avoid machine washing)

Wash the backrest cushion cover with the zippers closed.

1 Immerse the cover in water of no more than 86 °F (30 °C), and wash by pushing down gently.

Caution: Use a mild detergent. Detergents including bleaching agents will bleach the cover.
Do not use such detergents.

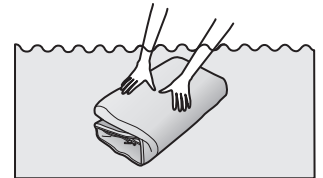

2 Rinse well.

3 Gently squeeze out the water.

Caution: Do not squeeze the cover tightly as this may damage the fabric or stretch the fiber.

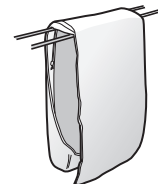

4 Gently stretch and hang dry in the shade.

Caution: Drying in direct sunlight may cause the fabric to shrink and the color to fade, and should therefore be avoided.



After washing the cover, you can iron it to eliminate fold marks.

(Caution regarding use of iron)

Back pad	Backrest cushion cover
 Pass a steam iron over the cover to shape. (Do not allow the iron to touch the fabric directly.)	 Place the iron on the fabric, and use a medium temperature with an upper limit of 302 °F (150 °C).

To dry clean

At the cleaners, ask for dry cleaning (petroleum based) and make it clear that tumble drying should not be used.

FITTING AND REMOVING THE BACKREST CUSHION COVER AND BACK PAD

Removing

Backrest cushion cover

Unfasten the rear zipper and remove the cushion.

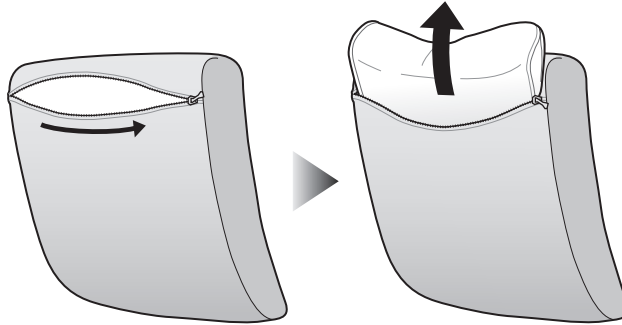

Back pad

- 1 Unfasten the zippers (3 locations).
- 2 Unfasten the velcro fastener in the bottom section of the seat, and remove the back pad.

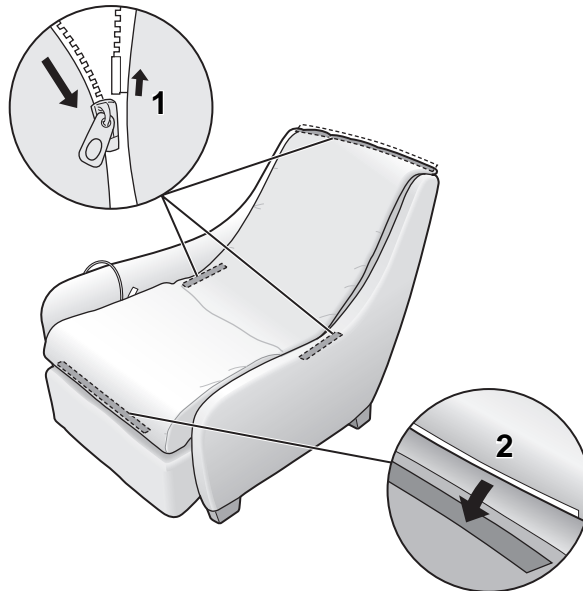

Fitting

Backrest cushion cover

- 1 Check the vertical and horizontal orientation of the cushion.
- 2 Fold the cushion forwards and insert it into the zipper opening.
- 3 Close the zipper.
- 4 To ensure the cushion is equally distributed within the cover, pat the front and rear of the cover a few times.

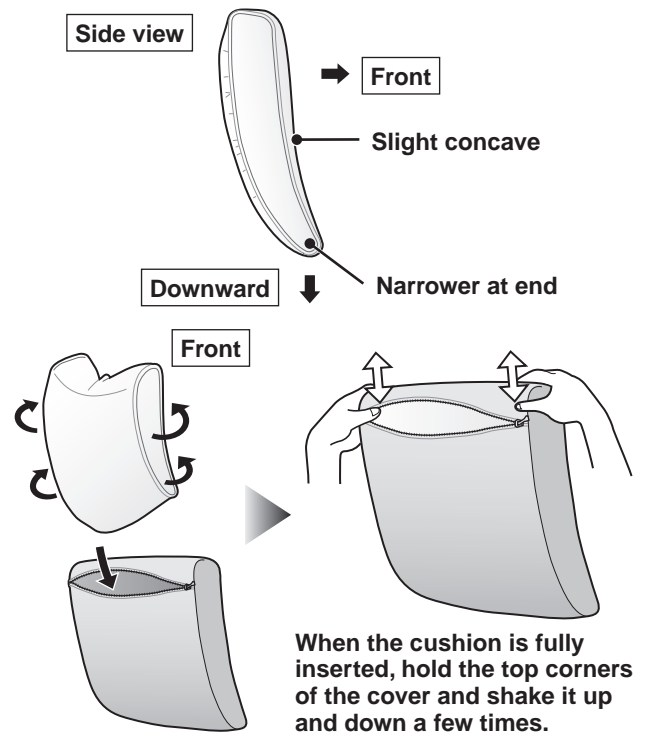

Back pad

Make sure that the leg/foot massage lock release strap is exposed.

- 1 Close the zippers located to the sides of the seat (2 locations).
- 2 Pull the cover over the corners of the cushion on the seat, and, while gently pulling forward on the cover, fasten the velcro fastener located at the bottom section of the seat.
- 3 Fasten the zipper located at the top section of the back pad.
- 4 Push the zipper covers down between the seat and the armrests.

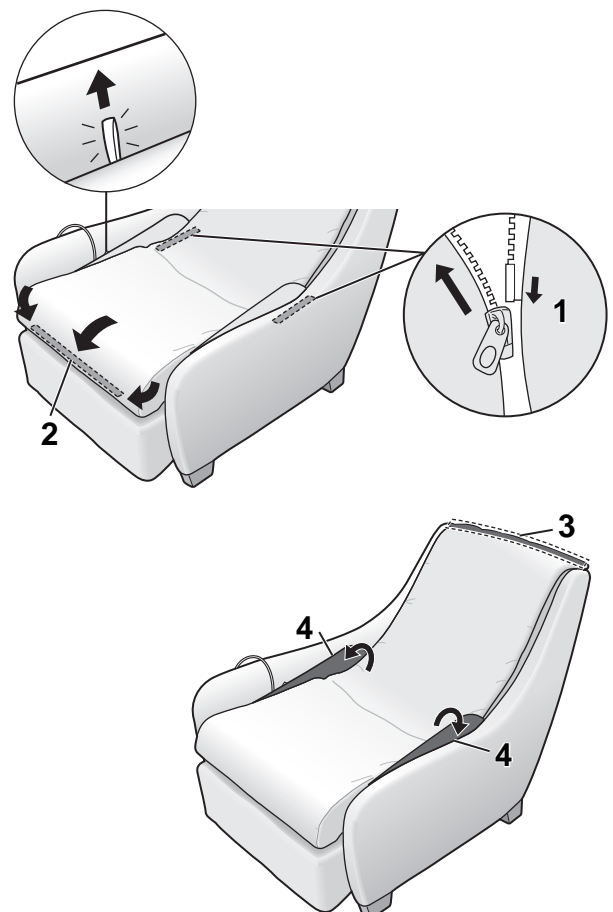

USING AS A LOUNGER

1 Put the backrest cushion in place.

The backrest cushion has a predetermined orientation.

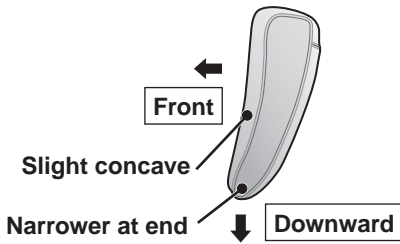

2 The leg/foot massage section should be stored away.

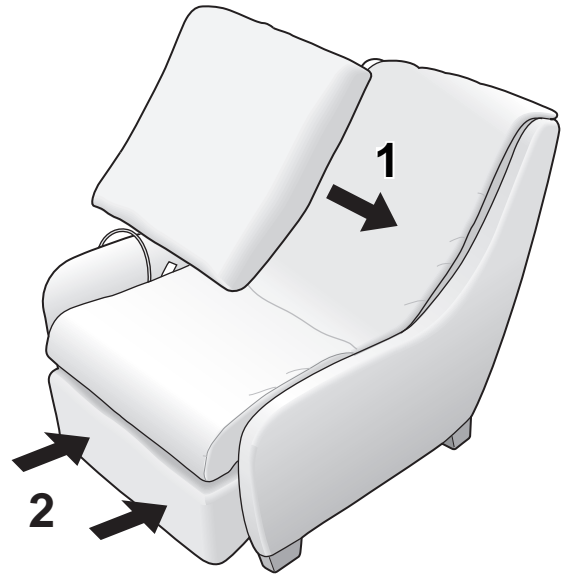

When wrinkles and sags are noticeable in the backrest cushion or back pad

Backrest cushion cover

Pat the front and rear a few times.



This will distribute the cushion more evenly and reduce amount of wrinkles.

Back pad

- 1 **Wrinkles in the back pad:** Gently rub towards the edges.
- 2 **Seat wrinkles:** Unfasten the velcro fastener, and then refasten while pulling forward on the fabric.

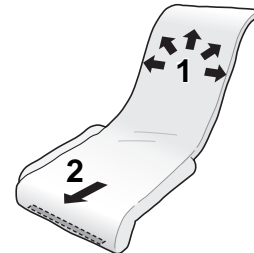

* During use, the fabric may stretch slightly, making it easier for wrinkles to form. If fold marks are noticeable, iron the cover. (See page 26.)

GENERAL CONTENT OF MASSAGE PROGRAMS

Contents of Pre-Programs

DEEP

Brief knead to loosen neck and between the shoulder blades



Soft shiatsu and kneading to loosen back and lower back



Knead to fully loosen neck and between the shoulder blades



Knead and tap to fully loosen back and lower back



Gentle knead to relax neck and between shoulder blades



Gentle knead to relax lower back

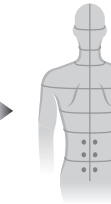

Knead all over to finish*

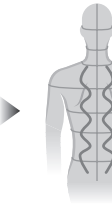

QUICK (8 min.)

Brief knead to loosen neck and between the shoulder blades



Soft shiatsu and kneading to loosen back and lower back



Knead concentrated to fully loosen neck and shoulders



Knead concentrated to fully loosen lower back



Knead all over to finish*

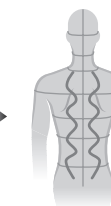

RELAX

Gentle knead all over to slowly loosen



Knead at a slightly higher speed to loosen neck and shoulders



Knead at a slightly higher speed to loosen lower back



Knead at a gradually reducing speed to loosen neck and shoulders



Gentle knead to loosen lower back

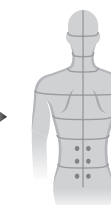

Super gentle knead for relaxation

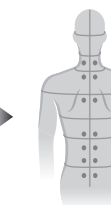

Gentle knead all over to finish*

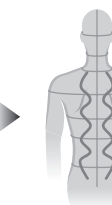

REFRESH

Tap and knead all over to stimulate rhythmically



Fast knead to loosen all over



Weakening stimulation at gradually reducing speed



Gentle knead for temporary relaxation



Tap and knead all over to stimulate rhythmically



Higher speed for higher intensity of stimulation

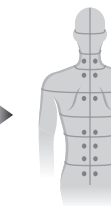

Stimulate by tapping and kneading all over to finish*

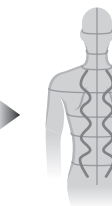

* The time which takes on "kneading all over to finish" depends on individual's height and setting intensity level of the massage.

Details regarding the program (The figures are images of the respective operations.)

SOFT SHIATSU

Gentle compressing action for left and right alternately.

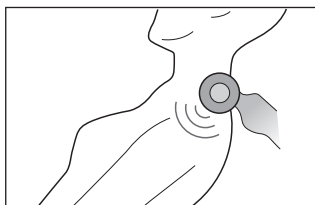

KNEAD

Deep kneading action.

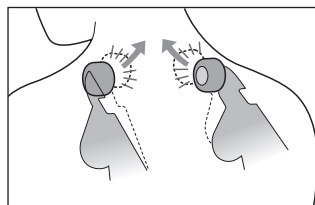

TAP

Tapping action for right and left alternately.

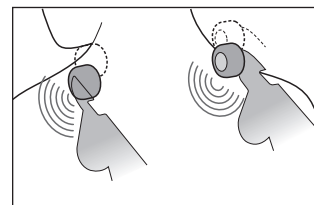

TROUBLESHOOTING

Problem

► Cause and Remedy

Motor Noises

- It sounds and feels like the massage heads are straining to get over wrinkles in the cloth.
- There is operational noise of kneading or tapping actions.
- There is a creaking noise when the massage heads are in operation.
- There is a rattling sound when the massage heads move up or down.
- The belt can be heard rotating.
- The motor groans when it comes under load.
- There is clunking or grinding sound when the massage heads move in and out.
- There is operational noise when applying air pressure.
- There is a noise of discharging air.
- There is a slipping sound when you sit back.
- There is a rubbing sound produced by the massage heads rubbing on the seat fabric.
- Leg/foot massage section rattles.

► These sounds are perfectly normal and will not have any effect on the operation of the unit.

The massage heads stop during operation.

► When excessive force is applied to the massage heads during operation, in the interests of safety the massage heads may stop moving.

If all markings and buttons on the controller start to flash, which is extremely unusual, turn off the power switch, wait for approximately 10 seconds and then turn the power switch on again. If the massage heads stop again, position yourself so that your back is not completely in contact with the backrest.

The massage heads do not come up to the shoulder or neck.

► If your head or your back does not contact the backrest, the shoulder position may be detected as lower than the actual position during the shoulder checking operation. Sit on the seat in the deepest position and put your head on the backrest, and then repeat the operations again from the start. (See Page 15.)

The height of the left and right massage heads is different.

► An alternating tapping method is employed, which means that this phenomenon will naturally occur. There is nothing wrong with the unit.

The unit will not operate at all.

- Upper body (neck to lower back) massage
- Calf and sole massage

► • The power cord has been disconnected. (See Page 12.)
 • The power switch on the unit has not been turned on.
 • A menu selection button or **LEG/FOOT** button hasn't been pressed after pressing .

Leg/foot massage section cannot be ejected.

► • Check that the bottom of the leg/foot massage section is not caught on a rug or other object.
 • Check that the leg/foot massage section has not been caught in the fabric at the front of the seat.

Sometimes the power won't turn on when is pressed again when a massage has finished.

► Approximately 5 seconds are required for program termination after a massage finishes. Wait at least 5 seconds once all movement has stopped before pressing .

The unit has been damaged.





► Stop using the unit immediately.

The power cord or power plug is abnormally hot.

► Stop using the unit immediately.

⚠ See Caution No. 4 and 11 on page 3.

Error display

Error display	Explanations
	If the shoulder position cannot be correctly determined, this error message is displayed and operations are terminated. If this error occurs even if you are seated, press  , then sit back all the way to the backrest and operate from the start again.
	Operation is terminated because there is a problem with internal communication.
	Operation is terminated because there is a problem with the massage mechanism.

* Please contact an authorized service center.
 Service and maintenance will be more efficient if the error number is communicated when contacting.

Free Manuals Download Website

<http://myh66.com>

<http://usermanuals.us>

<http://www.somanuals.com>

<http://www.4manuals.cc>

<http://www.manual-lib.com>

<http://www.404manual.com>

<http://www.luxmanual.com>

<http://aubethermostatmanual.com>

Golf course search by state

<http://golfingnear.com>

Email search by domain

<http://emailbydomain.com>

Auto manuals search

<http://auto.somanuals.com>

TV manuals search

<http://tv.somanuals.com>