

Panasonic

Reference Manual

Personal Computer

Model No. **CF-F8 Series**

CF-W8 Series

CF-T8 Series

We recommend that this Reference Manual be printed.



- In this manual, “Microsoft® Windows® XP Professional Service Pack 2 with Advanced Security Technologies” and “Microsoft® Windows® XP Tablet PC Edition 2005” are indicated as “Windows” or “Windows XP” unless otherwise indicated.
- <Only for CF-F8/CF-W8 Series>
In this manual, the following software package is described as follow:
 - “WinDVD™ 8 (OEM Version)” as “WinDVD”



Illustrations and Terminology in this Reference Manual

NOTE	NOTE provides a useful fact or helpful information.
CAUTION	CAUTION indicates a condition that may result in minor or moderate injury.
Enter	This illustration means to press the Enter key.
Fn+F5	This illustration means to press and hold the Fn key, then press the F5 key. When using with the Fn key and the Ctrl key functions interchanged, read with the Fn key and the Ctrl key reversed.
[start] - [Run]	This illustration means to click [start], then to click [Run].
→ or ⇒	These symbols indicate related pages. → : If this is clicked, it will jump to the page corresponding Reference Manual. ⇒ : Refer to the Operating Instructions.
XXXX*1	If *1 is clicked, it will jump to a related topic.

Using the Touch Pad

Use the Touch Pad to move the cursor on the screen and perform computer operations.

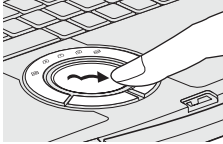
- A. Work Surface (Touch Pad)
- B. Left Button
- C. Right Button

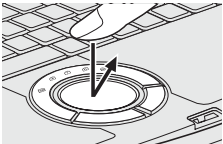
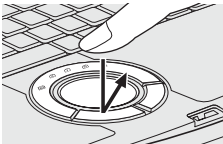
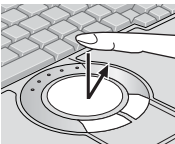
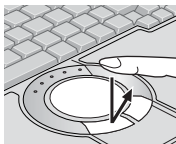

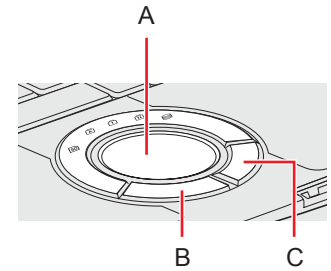

Function	Operation
Moving the Cursor	<p><CF-F8 Series></p>  <p><CF-W8/CF-T8 Series></p>  <p>Move the tip of your finger lightly over the work surface.</p>
Tapping/Clicking	<p><CF-F8 Series></p>   <p><CF-W8/CF-T8 Series></p>   <p>tapping or clicking</p> <p>To right-click: Can only be performed by clicking the right button.</p>

CF-F8 Series

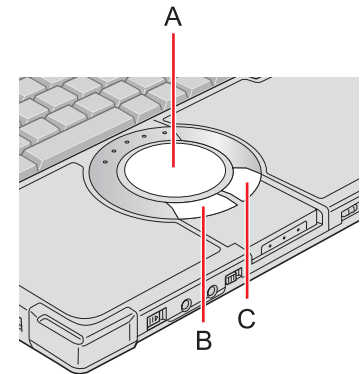

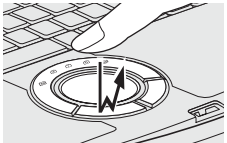
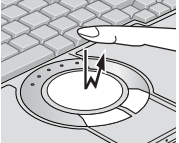
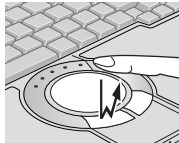
CF-W8/CF-T8 Series

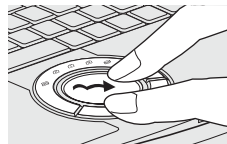

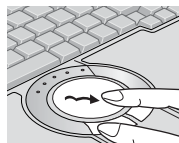
Function	Operation
<p>Double-Tapping/ Double-Clicking</p>	<p><CF-F8 Series></p>   <p><CF-W8/CF-T8 Series></p>   <p>double-tapping or double-clicking</p>
<p>Dragging</p>	<p><CF-F8 Series></p>   <p><CF-W8/CF-T8 Series></p>   <p>Two quick taps, but on the second tap leaving your finger down (applying pressure) and moving it on the work surface. or While holding down the button, moving your finger on the work surface.</p>
<p>Scroll</p>	<p>Trace a circle around the Touch Pad. (→ page 5)</p>

NOTE

- You can change the speed of the double-click or the operations of mouse buttons by clicking [start] - [Control Panel] - [Printers and Other Hardware] - [Mouse].

Scroll

There are two ways of scrolling with the Touch Pad: the Touch Pad utility, and the Virtual Scrolling Function. You cannot use both functions at the same time.

The Touch Pad utility is enabled in the default setting.

- The Touch Pad utility (below)
You can scroll continuously by tracing a circle on the Touch Pad (Start scrolling from the edge of the Touch Pad).

Vertical scroll	It can be used in the default setting.
Horizontal scroll	A setting is required to use the horizontal scroll.

- The Virtual Scrolling function (→ [page 9](#))
You can scroll vertically (or horizontally) by tracing repeatedly in the desired direction.

Vertical scroll	The Virtual Scrolling function must be set to enable.
Horizontal scroll	

You can use separate settings for each account regarding whether to use the Touch Pad utility or the Virtual Scrolling function.

Using the Touch Pad Utility

You can scroll easily by tracing a circle on the Touch Pad.

NOTE

- External mouse drivers cannot be used at the same time as the Touch Pad utility. (→ [page 76](#))

1 Make the following settings to use the horizontal scroll.

Once the settings have been made, it is not necessary to make the same settings the next time.

- Click  on the notification area, and click [Settings].

When  is not displayed:

Click [start] - [All Programs] - [Panasonic] - [Touch Pad Utility settings].

If a message appears indicating that the Touch Pad utility is not running, click

[start] - [All Programs] - [Panasonic] - [Touch Pad Utility], and display .

- Add a check mark for [Activate horizontal scroll function] in the [General settings] screen, and click [OK].

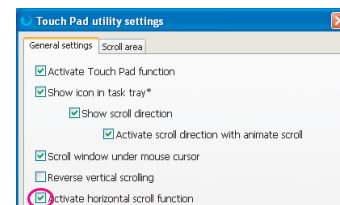



2 Display the scrollable screen.

3 Place the cursor over the area that you want to scroll, and tap (click).

4 Remove your finger from the pad, then place your finger in the appropriate area to begin scrolling.

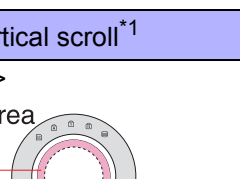
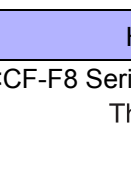
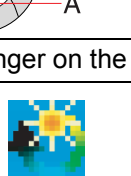
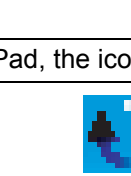

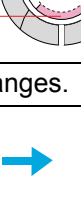

The finger position on the Touch Pad can be changed using the Touch Pad utility. (→ [page 8](#)) This explanation assumes in the default setting.

	Vertical scroll ^{*1}	Horizontal scroll
Position where finger is placed	<p><CF-F8 Series> This area</p>  <p><CF-W8/CF-T8 Series> This area</p> 	<p><CF-F8 Series> This area</p>  <p><CF-W8/CF-T8 Series> This area</p> 
Icon on the notification area	When you place your finger on the Touch Pad, the icon changes.	
		

^{*1} If the horizontal scroll function has not been enabled, the segment shown in the figure above (A) is also included in the area to begin vertical scrolling.

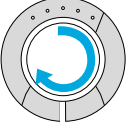
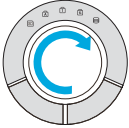
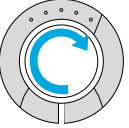
5 Trace a circle around the Touch Pad without lifting your finger from the pad.

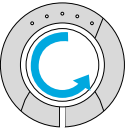
The scroll direction can be changed using [Reverse vertical scrolling] or [Reverse horizontal scrolling] in the Touch Pad utility. (→ [page 8](#))

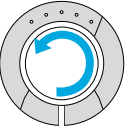
	Vertical scroll	Horizontal scroll ^{*2}
Trace clockwise	<p>To scroll down <CF-F8 Series></p>  <p><CF-W8/CF-T8 Series></p> 	<p>To scroll right <CF-F8 Series></p>  <p><CF-W8/CF-T8 Series></p> 
Trace counter-clockwise	<p>To scroll up <CF-F8 Series></p>  <p><CF-W8/CF-T8 Series></p> 	<p>To scroll left <CF-F8 Series></p>  <p><CF-W8/CF-T8 Series></p> 

^{*2} When the horizontal scroll function has not been enabled, any scrolling will be vertical scrolling.

- The screen will not scroll if you trace toward the center of the Touch Pad.
- On screens that cannot be scrolled (e.g., desktop screen), if you scroll, the computer may try to scroll the screen, causing the cursor to freeze. If this happens, remove your finger from the Touch Pad and begin again, this time starting from the center of the Touch Pad.
- For example, on a screen that will only scroll horizontally, even if you execute a vertical scroll, the screen will scroll horizontally.

6 Once scrolling has begun, continue to trace a circle on the Touch Pad without removing your finger from the pad.

- As long as you are tracing a circle, you can continue scrolling using any position on the Touch Pad.
- To scroll in the opposite direction, trace a circle in the opposite direction without removing your finger from the Touch Pad.

7 When you finish scrolling, remove your finger from the Touch Pad.

■ Change the settings for the Touch Pad utility

1 Click on the notification area, and then click [Settings].

When  is not displayed: → [page 6, step 1-①](#)

2 Change the settings.

- General settings

Activate Touch Pad function (On/Off)	If you add a check mark, you can use the Touch Pad function (screen scroll). If you remove the check mark, the Touch Pad function will be disabled, and  will be displayed on the notification area.
Show icon in task tray (On/Off)	If you add a check mark, the icon will be displayed in the notification area.
Show scroll direction (On/Off)	If you add a check mark, the icon will change while scrolling and the finger located within the region which starts scrolling.
Activate scroll direction with animate scroll (On/Off)	If you add a check mark, the icon will rotate while you are scrolling.
Scroll window under mouse cursor (On/Off)	If you add a check mark, scroll the region where the mouse cursor is located within the active window. If you remove the check mark, scroll the selected region within the active window. In either case, if the mouse cursor is outside the active window, scroll the selected region.

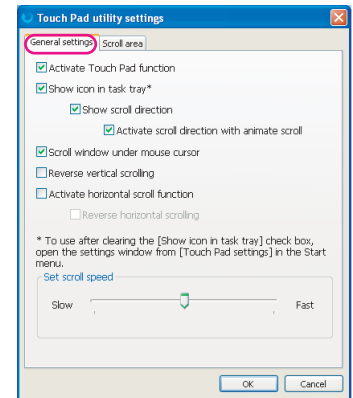

Reverse vertical scrolling (On/Off)	You can change the direction in which the screen scrolls when you trace the Touch Pad clockwise. <ul style="list-style-type: none"> • When check mark is added: Upwards • When check mark is removed: Downwards
Activate horizontal scroll function (On/Off)	If you add a check mark, you can use the horizontal scroll.
Reverse horizontal scrolling (On/Off)	When you add a check mark for [Activate horizontal scroll function], you can change the direction in which the screen scrolls when you trace the Touch Pad clockwise. <ul style="list-style-type: none"> • When check mark is added: Scroll left • When check mark is removed: Scroll right
Set scroll speed	You can change the scroll speed.

● Scroll area

A. Width of the scroll area	By dragging the inner circumference of the starting area, you can change the width of the scroll area (A) in five stages. You can also change the width by sliding the [Scroll activation area] slide bar.
B. Vertical and horizontal scroll area	You can change the scroll area (B) by dragging border of the vertical and horizontal scroll area. The maximum starting area for the horizontal scroll is half the circumference.

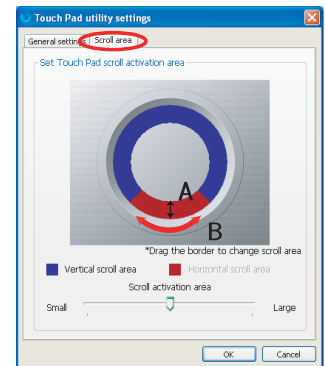

3 Click [OK].

Using the Virtual Scrolling Function

Set the Virtual Scrolling function using the following procedure. The Touch Pad utility will be disabled.

1 Click  on the notification area, and click [Settings].



When  is not displayed: → page 6, step 1-①

- 2 Remove the check mark from [Activate Touch Pad function] in [General settings], and then click [OK].
- 3 Click [start] - [Control Panel] - [Printers and Other Hardware] - [Mouse] - [Device Settings].
- 4 Click the device name (e.g., Synaptics TouchPad V6.2) in [Devices], then click [Settings].
- 5 Click [Virtual Scrolling], add a check mark for the scroll functions you want to use, then click [OK].
- 6 Click [OK] at [Mouse Properties].

NOTE

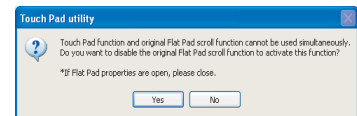
- Because the Touch Pad utility and the Virtual Scrolling function both offer scrolling functions that use the Touch Pad, these two features cannot be used simultaneously. If you try to use them at the same time, a message may be displayed asking you if you want to enable the Touch Pad utility.
 - To use the Touch Pad utility: Click [Yes]. The Virtual Scrolling function will be disabled.
 - To use the Virtual Scrolling function: Click [No].You can uninstall the Touch Pad utility using the following procedure.



- ① Click  or  on the notification area, and then click [Exit].
 - ② Click [start] - [Control Panel] - [Add or Remove Programs] - [Touch Pad Utility], and then click [Remove] to remove the program.
- To begin using the Touch Pad utility again:
 - ① Click [start] - [Control Panel] - [Add or Remove Programs].
When [Touch Pad Utility] is not displayed, perform the following procedures from step ②.
When [Touch Pad Utility] is displayed, perform the following procedures from step ③.
 - ② Input [c:\util\wheelpad\setup.exe] in [start]-[Run] and then click [OK].
Follow the on-screen instructions.
 - ③ Conduct steps 3 to 4 (above).
 - ④ Click [Virtual Scrolling], remove a check mark from [Enable vertical scrolling] and [Enable horizontal scrolling], then click [OK].
 - ⑤ Click [OK] at [Mouse Properties].
 - ⑥ Click [start] - [All Programs] - [Panasonic] - [Touch Pad Utility settings].
 - ⑦ Click [General settings], add a check mark for [Activate Touch Pad function], then click [OK].

Adjusting the Sensitivity when Touching the Touch Pad

Adjust [PalmCheck] and [Touch Sensitivity] using the following procedure:

- 1 Click [start] - [Control Panel] - [Printers and Other Hardware] - [Mouse] - [Device Settings].
- 2 Click the device name (e.g. Synaptics TouchPad) in [Devices], then click [Settings].
- 3 Double-click [Sensitivity], then click [PalmCheck] or [Touch Sensitivity].
- 4 After making the adjustment, click [OK].

■ PalmCheck™

- When operating the keyboard, if your hand touches the Touch Pad unintentionally causing the cursor to move, adjust the sensitivity using “PalmCheck™.”
 - By dragging slide bar to the [Maximum] position, you can prevent the cursor from moving unintentionally.
 - By dragging slide bar to the [Minimum] position, you can enable the cursor to move even with a light touch of the palm on the Touch Pad.

■ Touch Sensitivity

- When operating the Touch Pad, if your finger touches the Touch Pad, unintentionally causing the cursor to move; or if the cursor does not move even when you move your finger on the Touch Pad, adjust the sensitivity using the “Touch Sensitivity”.
 - By dragging slide bar to the [Heavy Touch] position, the cursor will only move with a strong touch on the Touch Pad.
 - By dragging slide bar to the [Light Touch] position, the cursor will move even with a light touch on the Touch Pad.

Handling the Touch Pad

- By design, the Touch Pad is to be used with a fingertip only. Do not place any object on the work surface or press down forcefully with sharp-pointed objects (e.g., nails) or hard objects that can leave marks (e.g., pencils and ball point pens).
- Try to avoid having any harmful substances, such as oil, come in contact with the Touch Pad. The cursor may not work properly in such cases.
- **When the Touch Pad becomes dirty:**
Wipe to remove dirt by using a dry soft cloth such as gauze or a soft cloth first applied with detergent diluted with water and then thoroughly wrung.
Do not use benzene or thinner, or rubbing alcohol. Doing so may adversely affect the surface, e.g., discoloration. In addition, do not use commercially available household cleaners and cosmetics, as they may contain components harmful to the surface.

<Only for CF-T8 Series>

Your computer is equipped with a touchscreen function allowing you to perform the same operations as the Touch Pad or mouse by touching the surface of the display with the stylus (included). The following explanation gives one example (for the default settings).

The operation settings can be changed.

CAUTION

- When using the stylus to input, avoid touching the screen with your hands, etc. at the same time. Failure to do may result in input errors.

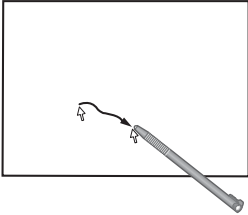
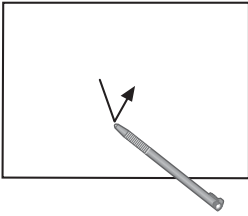
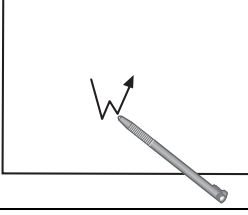
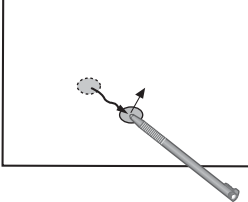
Functions	Operation
Moving the cursor	 <p>The cursor is moved to the location pointed by the stylus.</p>
Clicking (Tapping)	 <p>One tap</p>
Double-clicking (Double-tapping)	 <p>Two quick taps</p>
Dragging	 <p>Touch and hold the object (i.e. file or icon), move the stylus on the surface (dragging the object to the desired location), then release the stylus.</p>

■ To right-click

<Only for model with Windows XP Professional>

- Use on the notification area.
 - ① Click on the notification area.
 changes to .
 - ② Click the object you want to right-click.
 changes to .
- If you accidentally change the icon to , click to return to .
- appears when you restart the computer after setting up Windows.
- When needed, the above settings can be configured using the following procedure.
 - ① To Display [Touch Panel Configuration] screen.
Click [start] - [All Programs] - [Fujitsu Touch Panel (USB)] - [Touch Panel Configuration].
 - ② Make necessary changes and click [OK].

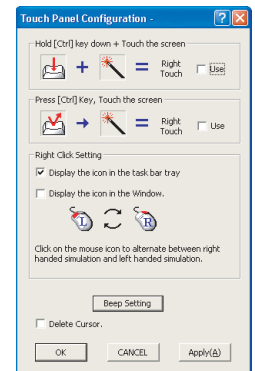

<Only for model with Windows XP Tablet PC Edition>

- ① Touch the item you want to right-click and continue touching until is completely displayed.
 - ② Move the stylus away from the surface of the display.
Moving the stylus away from the surface of the display before has not completely displayed will result in a left click.
- When needed, the above settings can be configured using the following procedure.
 - ① Click [start] - [Control Panel] - [Printers and Other Hardware] - [Tablet and Pen Settings] - [Pen Options].
 - ② Click [Press and hold] in [Pen Action] and then click [Settings].
 - ③ In [Press and Hold Settings], change the settings and then click [OK].For more information, refer to “Help” in the bottom right corner of the [Press and Hold Settings].

CAUTION

- If a change is made to the display resolution, or the cursor cannot be pointed correctly with the stylus, be sure to calibrate the Touchscreen. (→ [page 15](#))
- When mouse drivers are installed (e.g., IntelliMouse), the touchscreen function may not be used.
- When the operation of panning (only the internal LCD) is performed while the display resolution is set higher than the resolution of the internal LCD, the touchscreen function will not work properly.
- Even when only an external display is in use, the cursor will move on the external display if the surface of the internal LCD is touched when the touchscreen driver is active. Therefore, do not touch the internal LCD when only an external display is in use.
- The touchscreen function does not work in the Setup Utility, also in the “Full Screen” of [Command Prompt].

NOTE

- Do not move the stylus too quickly. If the stylus moves too quickly, the cursor may be unable to follow its movement.

<Only for model with Windows XP Professional>

■ Install the touchscreen driver

- If the touchscreen driver not installed, you can install the touchscreen driver using the following procedure.
 - 1** Set [Touchscreen Mode] to [Auto] or [Touchscreen Mode] in the [Main] menu of the Setup Utility.
 - 2** Press **F10**.
 - 3** Input [c:\util\drivers\tscreen\ftsetup.exe] in [Start] - [Run], and then click [OK].
 - Follow the on-screen instructions.
 -  appears when you restart the computer after installing the touchscreen driver.
 - 4** Perform the touchscreen calibration (→ [page 15](#)).

Calibrating the Touchscreen

When you cannot point correctly with the stylus (include), calibrate the Touchscreen by following the steps below.

NOTE

- Rotate the display to 0 degree before performing the calibration. (→ [page 18](#))

<Only for model with Windows XP Professional>

Calibrate the Touchscreen for each account created.

- 1 Run [Touch Screen Calibration Utility].**
Click [start] - [All Programs] - [Fujitsu Touch Panel (USB)] - [Touch Screen Calibration Utility].
- 2 Touch the 9 “+” target marks sequentially with the stylus, and then press Enter.**
Keep touching each “+” target mark until blinks.
- 3 Touch [Save & Exit].**

<Only for model with Windows XP Tablet PC Edition>

■ If an administrator calibrates the Touchscreen

If an administrator performs calibration once, other administrators will not need to do even if multiple user accounts are created. This does not need to be performed two times or more for one computer. However, calibrate again after you reinstall the software.

- 1 Click [start] - [Control Panel] - [Other Control Panel Options] - [Tablet Calibration].**
- 2 Touch the 9 “+” target marks sequentially with the stylus.**
- 3 Touch [OK] and restart the computer.**

■ If each user calibrates the Touchscreen

- 1 Click [start] - [Control Panel] - [Printers and Other Hardware] - [Tablet and Pen Settings].**
- 2 Set the following with [Calibration] in [Settings].**
 - ① Select [Landscape] and click [Calibrate].

- ② Touch the 4 “+” target marks sequentially with the stylus.
- ③ Click [OK].
- ④ Select [Portrait] and click [Calibrate].
- ⑤ Repeat steps ② and ③ above.

Handling the Touchscreen

- Use the stylus included with the computer. Do not use pencils, implements with sharp tips or hard objects for screen operations. The screen may be damaged as a result.
- Do not place any object on the surface or press down forcefully with sharp-pointed objects (e.g., nails), or hard objects that can leave marks (e.g., pencils and ball point pens).
- Do not apply pressure to the perimeter of the display panel. The cursor may move to the edge of the display.
- Do not operate the computer when such things as dust are on the screen. Do not allow contact with substances that could dirty the touchscreen, such as oil.
- Do not apply too much pressure when operating the touchscreen. Only a light touch is required to operate the touchscreen. Applying too much pressure may damage the surface.
- Do not touch the screen outside of the LCD display area. The touchscreen input area is defined by the LCD display screen. Touching the screen outside of the display area may result malfunctions or damage to the touchscreen.
- **When the touchscreen becomes dirty:**
 - Wipe to remove dirt by using a dry soft cloth included with the computer.
 - Do not use benzene or thinner, or rubbing alcohol.
 - For more information, refer to “Suggestions About Cleaning the LCD Surface” (→ [page 17](#)).

Handling the Stylus

- Clean the stylus tip and screen prior to operation. Foreign particles can scratch the screen and impede the operation of the stylus.
- Use the stylus only for the computer screen. Using it for any other purpose may damage the stylus and scratch the screen.

Suggestions About Cleaning the LCD Surface

To improve the outdoor visibility of the display, a low reflection coating has been added. In order to avoid scratches and peeling of this coating, an approved soft cloth has been included to wipe the LCD surface of the computer. Before using the computer, be sure to read the instructions provided below.

- Be sure to wipe the LCD display to remove fingerprints, etc., with the soft cloth.
- Do not wipe areas other than the LCD display with the soft cloth.

<How to use the soft cloth>

Use the soft cloth when it is dry. Do not apply water or solvents to the soft cloth.

- First, lightly wipe foreign particles and dust adhering to the LCD display on one side of the soft cloth. Do not use force, since the LCD surface may be damaged with the foreign particles or dust. Next, wipe off fingerprints, etc., with the other side of the soft cloth. After wiping off foreign particles and dust, wash the soft cloth (refer to the following) to remove the foreign particles and dust from the soft cloth.
- When the soft cloth becomes dirty, wash it with neutral detergent. Do not use bleach or a fabric conditioner (softener), or carry out sterilization by boiling.
- If the LCD gets wet, wipe the surface lightly with the soft cloth.
- We recommend wiping the LCD display before using the computer.



<Only for CF-T8 Series>

After Windows is started up, you can rotate the display and perform the Touch Pad and touchscreen operations in the rotated mode.

Rotating the Display

- 1 Double-click  on the notification area or press **Alt + X**.

Each time this operation is performed, the screen display switches between the landscape mode (0 degree) and the previously set angle (below).

■ To select the angle and rotate the display

- 1 Right-click  on the notification area, and then select the angle.

You can select rotation angles of 90, 180, or 270 degrees from the landscape mode.

NOTE

- Be sure to use the above procedures to rotate the display.

Changing the Settings

By using the Display Rotation Tool, you can change the settings of the display rotation.

- 1 Right-click  on the notification area, and then click [Setting...].

- 2 Change the settings.

A. Changing the key combination

B. Changing the angle
(Default: 180 degrees)

- 3 Click [OK].

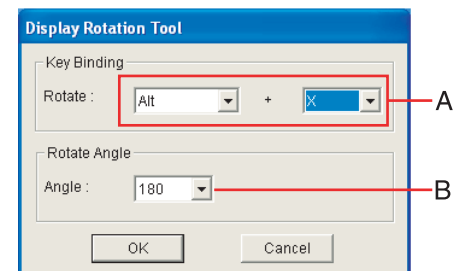





NOTE



- If you shut down Windows when you rotate the display, the Touch Pad and touchscreen do not match the display angle next time you start up Windows for a few seconds.
- The Touch Pad and the touchscreen may not match the display angle if you change display properties or Intel(R) Graphics Media Accelerator Driver for Mobile when you rotate the display. (→ [page 119](#))
- The display cannot be rotated when the [Command Prompt] is set to “Full Screen” or Setup Utility.
- When some applications are running, the display may not be rotated and the operation of the Touch Pad and the touchscreen may not match the display angle. Press **Alt + X** to rotate the display to the landscape mode. After exiting the application, rotate the display, then start up the application again.
- The computer's performance will decrease somewhat.
- While the display is rotated:
 - Do not use the Extended Desktop (The Touch Pad or touchscreen may fail to operate properly).
 - Do not calibrate the touchscreen.
 - Do not set the display resolution larger than the resolution of the internal LCD.
- If motion video is played while the display is rotated, the picture may not be displayed properly or the sound may be broken up. This problem can be corrected by rotating the display to 0 degree.
- The Touch Pad scroll function does not work while the display is rotated.
- If the display is rotated when the resolution is set to 800 x 600 pixels, depending on the Windows specifications, incorrect values may be shown for the resolution displayed in [Screen resolution] of [Display Properties]. Continue using these settings, without changing [Screen resolution].
- Exit the tool with the following procedure:
 - ① Right-click  on the notification area, and then click [Exit].
 - In the default mode, the Display Rotation Tool will start up when Windows starts up.
 - To restart the tool after exiting:
Click [start] - [All Programs] - [Panasonic] - [Display Rotation Tool].

NOTE

- Do not repeatedly press the keys in quick succession.
- Do not use the key combinations together with Touch Pad (external mouse) , touchscreen (only for CF-T8 Series) or other key operations.
- Do not use the key combinations before you log on to Windows. Wait until the hard disk drive indicator  turns off. On the Setup Utility screen, you can use the key combinations of **Fn+F1**, **Fn+F2** and **Fn+F3**. By using the key combinations of **Fn+F3**, the display is switched between the internal LCD and the external display.
- The key combinations may not work with some applications.
- The pop-up icon appears after logging on to Windows. It may not appear in some application conditions (e.g., when [Command Prompt] is set to "Full Screen").

Key	Functions	Pop-up Icon
Fn+F1 Fn+F2	LCD brightness (Fn+F1= down / Fn+F2= up) You can select a different brightness level setting for when the AC adaptor is connected and for when it is not connected. (In the default setting, the LCD brightness is set to be darker when the AC adaptor is not connected.) NOTE <ul style="list-style-type: none">● The brightness of the power indicator changes in keeping with the brightness level of the internal LCD.	

Key	Functions	Pop-up Icon
<u>Fn+F3</u>	<p>Display switching (→ page 72) (When an external display is connected) Internal LCD → Simultaneous display → External display</p> <p>↑</p> <p>NOTE</p> <ul style="list-style-type: none"> • <Only for CF-F8 Series> When an external display is connected to an optional mini port replicator (CF-VEBU08U), the display switching may work differently from the above. For further information, refer to the Operating Instructions of the mini port replicator. • When an external display is connected, refer to the External Display (→ page 71). <p>CAUTION</p> <ul style="list-style-type: none"> • Do not press any keys until the display has finished switching. • Do not use this function: <ul style="list-style-type: none"> • When an external display is not connected. • When playing motion video such as DVD or MPEG. • When using the Extended Desktop. • When showing a game screen such as pinball. 	—
<u>Fn+F4</u>	<p>Speaker on/off</p> <p>NOTE</p> <ul style="list-style-type: none"> • Beeps do not sound if you turn off the speaker sound. <p>When Win DVD's screen is chosen, the display on the screen  will not be changed even the sound is switched to on/off or the volume is adjusted by using Fn key.</p>	<p> OFF (MUTE)</p> <p> ON</p>

Key	Functions	Pop-up Icon
<u>Fn</u>+<u>F5</u> <u>Fn</u>+<u>F6</u>	<p>Volume (<u>Fn</u>+<u>F5</u>= down / <u>Fn</u>+<u>F6</u>= up)</p> <p>NOTE</p> <ul style="list-style-type: none"> When fine-tuning the sound volume, press and hold <u>Fn</u>, and press <u>F5</u> or <u>F6</u> intermittently. <p>When Win DVD's screen is chosen, the display on the screen  will not be changed even the sound is switched to on/off or the volume is adjusted by using Fn key.</p>	
<u>Fn</u>+<u>F7</u>	Activate standby (→ page 39)	—
<u>Fn</u>+<u>F9</u>	Remaining battery power	→ page 25
<u>Fn</u>+<u>F10</u>	Activate hibernation (→ page 39)	—

<Only for CF-W8/CF-T8 Series>

Key	Functions	Pop-up Icon
<u>Fn</u>+<u>NumLk</u>	<p>Run the ScrLk (Scroll Lock) function</p> <p>The functions differ depending on the application software.</p>	—
<u>Fn</u>+<u>Home</u>	Lead to the last page or move the cursor to the end of the current line (End)	—
<u>Fn</u>+<u>↑</u>	Move the back page (PgUp)	—
<u>Fn</u>+<u>↓</u>	Move the next page (PgDn)	—

Hotkey Settings

You can make two settings:

- **Fn key lock**
When you press **Fn**, the key is locked (pressed-down) until you press another key. Use this when pressing difficult key combinations.
- **Pop-up icon on/off**

1 Start up the Hotkey Settings.

Click [start] - [All Programs] - [Panasonic] - [Hotkey Settings].

2 Make the settings.



[Use Fn key lock]

- When using an **Fn** key combination
 - ① Press **Fn** once. (Locked)
 - ② Press another key. (Lock released)
- When using successive **Fn** key combinations
 - ① Press **Fn** twice. (Locked)
 - ② Press another key.
Fn key remains locked until you press **Fn** again.

[Notification]

[Make sounds when Fn key is pressed]^{*1}

[Show status on screen]: Displays the Fn key status on the notification area.

- : **Fn** is locked.
- : **Fn** is not locked.

[Disable popup]

The Pop-up icon will not be displayed.

3 Click [OK].

NOTE

- You can have different settings for each user.

^{*1} If the speakers are muted, beeps do not sound.

Tips about the Battery Pack

■ [Important Tips] (On-Line Manual)

- [Important Tips] provides information on how to maximize use of the battery pack, which is necessary for computing away from your home or office.
See [Important Tips] using one of the following methods.
 - Double-click  on the desktop.

Important Tips
 - Using the [start] menu.
 - ① Click [start] - [All Programs] - [Panasonic].
 - ② Select [On-Line Manuals] or [Battery], and click [Important Tips].

Checking the Battery Status

Battery Indicator 	Battery Status
Not lit	Battery pack is not connected or no charging.
Orange light on / flashing ^{*1*2}	Charging in progress. If [Battery Charging Indicator] in the [Main] menu of the Setup Utility is set to [Flashing], the indicator will alternately become lighter and darker (Flashing) (→ page 99).
Green ^{*1}	Fully charged.
Red	The remaining battery power is approximately 9% or less.
Blinking red ^{*1}	Battery pack or charging circuit may not be working properly. Quickly save your data and power off your computer. Remove the battery pack and disconnect the AC adaptor, then connect them again. If the problem persists, contact your technical support office. The battery pack or charging circuit may be defective.
Blinking orange ^{*1*2}	The battery cannot be charged temporarily due to the following reasons: <ul style="list-style-type: none"> ● Its internal temperature is out of the acceptable range. ● The power supply is not enough because software applications or peripheral devices are consuming a large amount of power.

CF-F8 Series

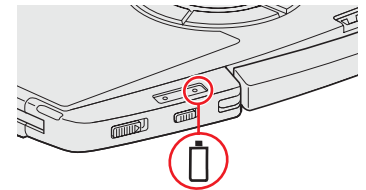

CF-W8 Series

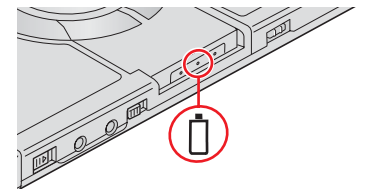

CF-T8 Series

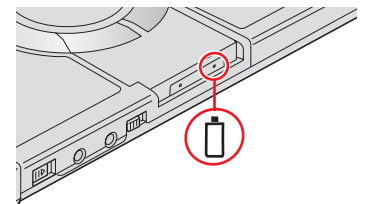

*1 When the AC adaptor is connected.

*2 The orange display light has three modes: on, flashing and blinking. Note the difference between flashing and blinking.

NOTE

- Once the battery is fully charged, the computer performs recharging only when the remaining battery power becomes less than approximately 95% (75% when Economy Mode (ECO) is enabled), so overcharging is avoided.



Checking the Remaining Battery Power

There are three methods to check the remaining battery power.

■ To check the remaining battery power on the screen

(After logging on to Windows)

- 1 Press **Fn+F9**.

Display	Condition
	When the battery pack is inserted. (example)
	When the battery pack is not inserted.
	[ECO] is displayed when Economy Mode (ECO) is enabled.

■ To check the remaining battery power and remaining time using the Windows Power Meter

(After logging on to Windows)

- 1 Double-click  on the notification area when the AC adaptor is not connected.

NOTE

- The battery display may not correspond to the actual remaining battery power in the cases as below. To correct the display, perform the Battery Recalibration (→ page 29).
 - The battery indicator remains red.
 - The battery indicator lights orange and the display shows 99% for a long time (79% when Economy Mode (ECO) is enabled).
 - Low battery warning appears soon after a short time of use.
- The battery display may not be the same as that of [Power Meter] in [Power Options Properties]. This is not a malfunction.

■ To check the remaining battery power using the battery indicator

(When the power is off or in standby or hibernation)

- 1 <CF-F8 Series>
Close the display and confirm that the latch is locked.
 <CF-W8/CF-T8 Series>
Close the display completely.
- 2 **Disconnect the AC adaptor.**
- 3 **Slide the power switch (A) and confirm the battery indicator (B).**

Battery Indicator (B)	Remaining Battery Power
Red	0 % - 4 %
Blinking orange	5 % - 19 %
Orange	20 % - 49 %
Blinking green	50 % - 94 %
Green	95 % - 100 %

CF-F8 Series

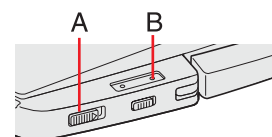

CF-W8 Series

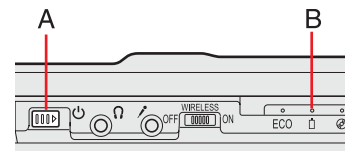

CF-T8 Series

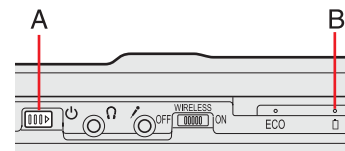

Computer behavior with low battery

The default settings are as follows.

When the remaining battery power becomes 10% [Low battery alarm]	When the remaining battery power becomes 5% [Critical battery alarm]
<ul style="list-style-type: none">● Displays a message that the remaining battery power is low. <p style="text-align: center;">↓</p>	<ul style="list-style-type: none">● Displays a message that the remaining battery power is low, and then the computer enters hibernation. <p style="text-align: center;">↓</p>
<p>Charge the battery.</p>	<p>Connect the AC adaptor or replace the battery to start up the computer.</p>
<ul style="list-style-type: none">● Connect the AC adaptor immediately. If you do not have the AC adaptor, exit the running programs and Windows, then confirm that the power indicator is off.● If you have a fully charged spare battery, turn off the computer, replace the battery and turn the computer on again.	<ul style="list-style-type: none">● Connect the AC adaptor and charge the battery.● If you have a fully charged spare battery, turn off the computer, replace the battery and turn the computer on again. <p>When the computer enters hibernation with the battery down and you resume the operation without charging the battery, Windows may not start up normally or the alarm function may not operate normally from then on.</p>
<p>Do not replace the battery pack when the computer is in standby.</p>	

We recommend that you become familiar with alarm settings to become aware when battery power is low.

- A. When making a setting for [When the alarm goes off, the computer will] in [Alarms] - [Alarm Action]:
Add a check mark for [Force stand by or shutdown even if a program stops responding].
- B. Set the value for [Critical battery alarm] to 5% or more.
This is necessary for the standby or hibernation to be completed (assuring data is saved) when the remaining battery power is low.

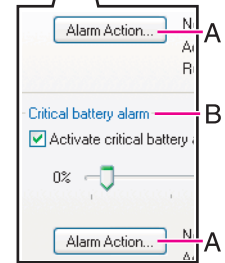
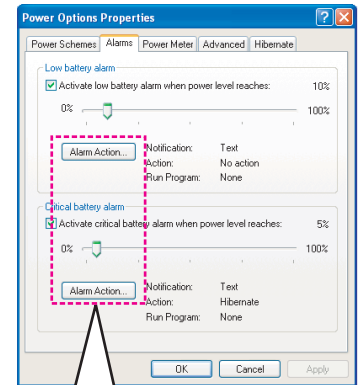

Correcting the Battery Display (Battery Recalibration)

The “Battery Recalibration” function measures and memorizes the battery capacity. To correct the battery display, use this function to fill the battery and then discharge it completely. Perform the procedure at least once immediately after purchasing the computer. Normally the interval of “Battery Recalibration” is three months. The battery display may not be correct when the battery pack deteriorates after a long time use. In this case, perform the procedure again.

1 Connect the AC adaptor.

2 Close all the applications.

3 Perform “Battery Recalibration”.

① Click [start] - [All Programs] - [Panasonic] - [Battery] - [Battery Recalibration].

② When the confirmation message appears, click [Start].

- Frequent recalibration of the battery can degrade the battery. A caution message appears when the “Battery Recalibration” is performed at the shorter interval than approximately a month. In this case, cancel the “Battery Recalibration”.

③ When the message requests shut down of Windows, click [Yes].

The “Battery Recalibration” starts.

After the battery pack is fully charged, discharging starts. When the discharging is completed, the power goes off automatically.

After the “Battery Recalibration” is finished, normal charging starts.

CAUTION

- Do not close the LCD while “Battery Recalibration” is being executed.

NOTE

- The temperature range should be 10°C to 30°C {50°F to 86°F}.
If “Battery Recalibration” is executed at low temperatures, recalibration may not be performed properly.
- The “Battery Recalibration” may take a long time due to the large battery capacity. This is not a malfunction.
<CF-F8 Series>
 - Full charge: Approximately 5 hours [MAX]
 - Complete discharge: Approximately 4 hours<CF-W8/CF-T8 Series>
When using the battery pack (CF-VZSU51W)
 - Full charge: Approximately 5 hours [MAX]
 - Complete discharge: Approximately 5 hours

When using the battery pack (CF-VZSU52W)

- Full charge: Approximately 4 hours [MAX]
- Complete discharge: Approximately 3 hours
- “Battery Recalibration” does not increase the battery’s capacity. If “Battery Recalibration” is executed frequently, deterioration of the battery may result.
- If you have two or more battery packs, perform the “Battery Recalibration” for each battery pack.
- If the computer is turned off during the “Battery Recalibration” (e.g., due to power failure, or accidental removal of the AC adaptor and battery pack), the “Battery Recalibration” will not be completed.
- You can also perform the “Battery Recalibration” with the following procedure.
 - ① Restart the computer.
 - ② Press and hold **F9** while the [Panasonic] boot screen is displayed just after the computer starts the startup procedure.
 - ③ When the remaining battery power is displayed, press **Enter**.
 - ④ Follow the on-screen instructions.

Switching between Long Battery Life and Extended Operating Time (Economy Mode (ECO) Setting Utility)

The battery pack is a consumable item, and deteriorates gradually each time it is used.

Use effective switching of the Economy Mode (ECO) to reduce battery pack deterioration, and enable the battery pack to last a little longer. Switch the Economy Mode (ECO) in accordance with the way you use your computer.



	Economy Mode (ECO)	
	Disabled	Enabled
Recommended usage	Mobile Using your computer while on the move	Desktop AC adaptor is connected most of the time
Operation time	Extended	Normal
Lifetime of battery	Normal	Extended

- Economy Mode (ECO) disabled:
In the default setting, the Economy Mode (ECO) is set to “Disabled”. Charge the battery to 100% (fully charged). We recommend that you disable the Economy Mode (ECO) if you use the battery pack frequently.
- Economy Mode (ECO) enabled:
Stop the battery recharging at 80% of fully charged. By stopping the battery recharging before 100% (fully charged), the burden on the battery is reduced and deterioration is prevented, so the lifetime of battery pack will be extended. The computer will not operate as long on the battery as when Economy Mode (ECO) is disabled.

If you often use the computer with the AC adaptor connected, and if you want to prevent deterioration of the battery pack, we recommend that you enable the Economy Mode (ECO).

Switching the Economy Mode (ECO)

1 Right-click either  (Disable) or  (Enable) on the notification area.

If  or  is not displayed, click [start] - [All Programs] - [Panasonic] - [Battery] - [Economy Mode(ECO) Setting Utility].

2 Click [Economy Mode(ECO) Enable] or [Economy Mode(ECO) Disable].

	[Economy Mode(ECO) Enable]		[Economy Mode(ECO) Disable]
	Remaining battery power: 81% or more.	Remaining battery power: 80% or less.	
Economy Mode (ECO) Indicator	Blink (During discharge)	Light	off

- If [Economy Mode(ECO) Enable] is set and remaining battery power is 81% or more
The battery will discharge until the remaining battery power is 80% or less.
- ① When the confirmation message is displayed, read the message on the screen carefully, and click [OK].
- ② Use the computer with the AC adaptor unplugged until the remaining battery power is 80% or less.
When the remaining battery power falls to 80% or less, battery discharge ends, and the Economy Mode (ECO) indicator lights.
If you continue using the computer with the AC adaptor, it may take about a day until the remaining battery power falls to 80%.
- ③ When the confirmation message is displayed, read the message on the screen carefully, and click [OK].
- ④ Connect the AC adaptor.
If you do not click [OK] at step ③, the computer will go into forced standby after about three minutes to prevent the remaining battery power from dropping.
 - The computer will go into forced standby even while application software is running or data is being sent or received, or when the hard disk is being accessed, so be sure to connect the AC adaptor.

NOTE

- After disconnecting the battery pack, if you connect it to a computer on which the Economy Mode (ECO) settings differ, the battery will either recharge or discharge until the next time the computer is turned on, giving priority to the battery pack setting on that computer.

Replacing the Battery Pack

The battery pack is a consumable item so the replacement will be necessary. If the battery operation time becomes noticeably short and not recovered even after recalibrating the battery, replace with a new battery.

CAUTION

- The battery pack is not charged when you first purchase it. Be sure to charge it before using for the first time. Charging starts automatically when the AC adaptor is connected to the computer.
- Use only the specified battery pack with your computer.
- In standby, do not remove/replace the battery pack. Otherwise your data will be lost and the computer may be damaged.

1 Turn off the computer.

- Do not use the standby function.

2 Turn your computer over and remove/insert the battery pack.

- To remove
Slide both the left and right latches to the unlocked position, and push out the battery pack in parallel with the computer.

CF-F8 Series

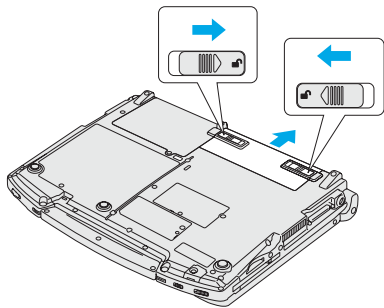

CF-W8 Series

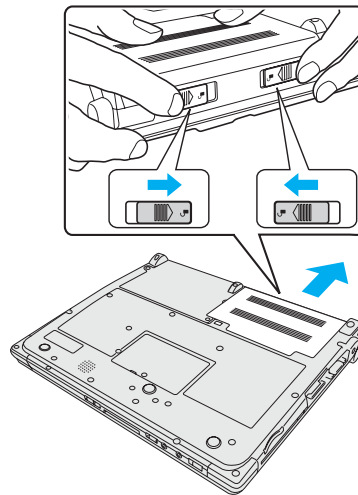

CF-T8 Series

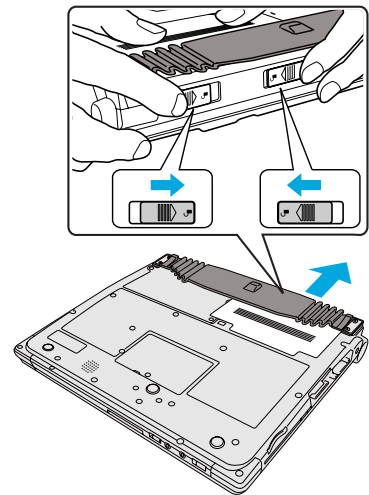

- To insert
<CF-F8 Series>

Slide the battery pack in parallel with the arrow direction and attach it so that the left and right dents (A) on the new battery pack match the projections (B) of the computer.

Be careful about the battery pack direction.

In case that the projection does not match the dents of the battery pack, detach the battery pack once, then slide it while pushing it lightly to avoid floating.

CF-F8 Series

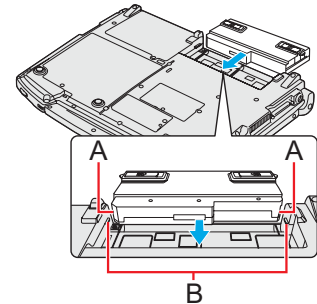

- <CF-W8/CF-T8 Series>

Slide the battery pack in parallel with the arrow direction and attach it so that the left and right projections on the new battery pack match the dents of the computer.

Be careful about the battery pack direction.

In case that the projection does not match the dents of the computer, detach the battery pack once, then slide it while pushing it lightly to avoid floating.

CF-W8 Series

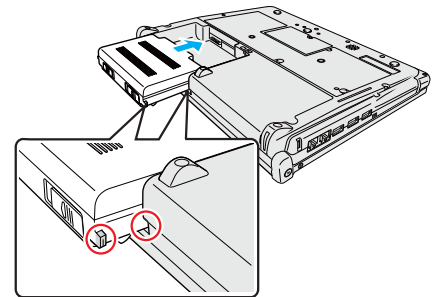

CF-T8 Series

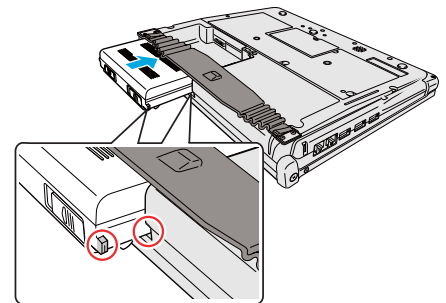

CAUTION

- Make sure the latches are securely locked, otherwise the battery pack may fall when you carry the computer.
- Do not remove the battery pack forcibly when the latches are locked. Doing so may damage the battery pack.
- Do not apply pressure from the top of the closed display when the battery pack has been removed. Doing so may damage the LCD.

In the default setting, [Power schemes] is set to [Panasonic Power Management], but you can reduce power consumption using the following method.

When using the battery, the computer can be used for a longer period of time.

Power conservation effects can be achieved even when the AC adaptor is connected.

■ Change [Power Schemes]

- Click [start] - [Control Panel] - [Performance and Maintenance] - [Power Options], and then set [Panasonic Power Management].

Power consumption can also be minimized with detailed settings; for example, by reducing the time setting for [Turn off monitor].

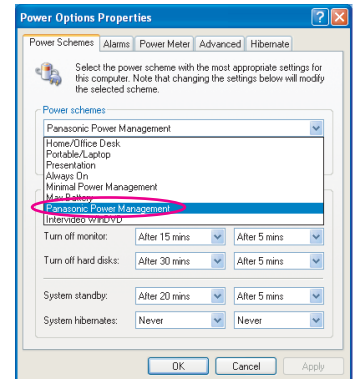

■ Use Power Saving Utility (→ page 35)

- Power Saving Utility provides additional power saving functions not available in [Power Schemes].

■ Adjust the brightness (darker) with the **Fn+F1** key (→ page 20)

■ Leave your computer off when not in use

■ Remove peripheral devices (USB devices, PC Cards, external mouse, etc.) when not in use

■ Turn off the wireless LAN when not in use (→ page 90)

■ Use Standby/Hibernation

- Press **Fn + F7** to set the computer to standby or **Fn + F10** to set it to hibernation when you have to leave the computer. This shuts down computer operation to reduce power consumption.

Disable Wake Up from wired LAN and Wake Up from wireless LAN functions when they are not needed. This reduces power consumption in Standby/Hibernation.

To confirm current settings, click [start] - [All Programs] - [Panasonic] - [Power Saving Utility] to view [Wired LAN standby power saving function] or [Wireless LAN standby power saving function].

- <Only for CF-F8/CF-W8 Series>

Minimize power consumption for the CD/DVD drive (→ [page 46](#))

■ When using this computer with the battery pack only

- We recommend against using applications that place a significant load on the CPU. Some screen saver place a large burden on the CPU even when you are not operating the computer. We recommend that you do not use a screen saver.

NOTE

- To extend the battery operation time, activate the power saving function of the USB2.0 Root Hub. In the default setting, the power saving function is activated. When the power saving function is deactivated (→ [page 77](#)), remove the check mark from [Allow the computer to turn off this device to save power.]. The battery running time will be reduced to some extent.

Using Power Saving Utility

A single setting allows you to enable all the following power saving features. Enable each of these functions to prolong battery operation time.

- **Screen display power saving function**

Refresh rate will automatically be reduced to 40 Hz, if the internal LCD brightness level is set below 20cd/m² while using the battery. When [Enable] is set, the displayed screen may be distorted.

- **Intel video driver power saving function (Intel(R) Display Power Saving Technology)**

This function adjusts video contrast, color and other factors to lower internal LCD power consumption while retaining adequate image quality.

Disable this function for work that requires subtle image and color nuances or in video editing using video editing applications.

- **Sound driver power saving function**

If you do not use sound for a specific time period, the power saving mode will automatically be engaged to reduce power consumption.

- **Wired LAN standby power saving function**

Enabling this function disables the Wake Up from wired LAN function to save power in standby/hibernation.

Disable this function if you want to use the Wake Up from wired LAN function.

- **Wireless LAN standby power saving function**

Enabling this function disables the Wake Up from wireless LAN function to save power in standby/hibernation.

Disable this function if you want to use the Wake Up from wireless LAN function.

■ Setup

1 Click [start] - [All Programs] - [Panasonic] - [Power Saving Utility].

2 Click [Enable] for each function.

Click [OK] in the confirmation screen that appears.

- **To enable “Intel video driver power saving function”**
Select [Enable], and slide the slide bar to the “Maximum Battery” end.

3 Click [OK].

Click [Restore initial settings] to return to the factory default settings, and click [OK].

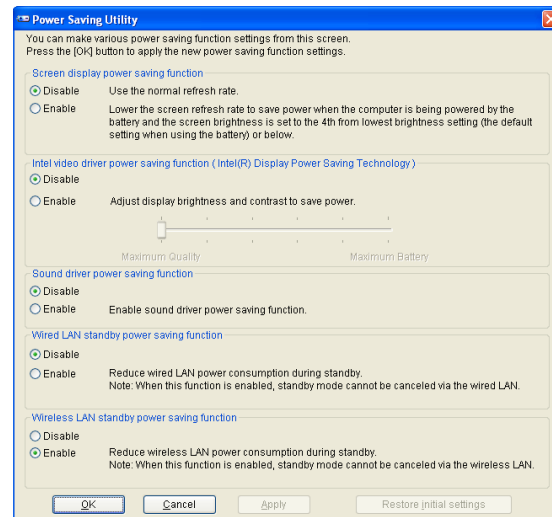

NOTE



- You can also enable the Intel video driver power saving function as follows.
 - ① Right-click the desktop, and click [Graphic Properties].
 - ② Click [Notebook], [Apply] and [OK].
 - ③ Click [Display Settings].
 - ④ Click [Power Settings].
 - ⑤ Click [Modify Settings].
 - ⑥ Click [Intel(R) Display Power Saving Technology] to add a check mark.
 - ⑦ Move the slide bar to [Maximum Battery] and click [OK].
 - ⑧ Click [OK].
 - ⑨ Click [OK].
- There is no need to reboot the computer.
- For how to enable/disable the Wake Up from wired LAN function (→ [page 85](#))
For how to enable/disable the Wake Up from wireless LAN function (→ [page 93](#))

Starting Up Your Computer Quickly

The standby or hibernation functions allow you to shut off the computer without closing programs and documents. You can quickly return to the programs and documents that you were working on before standby or hibernation.

Function	Data is saved to	Recovery time	Power supply
Standby	Memory	Short	Required. (If power is not supplied, all data will be lost.)
Hibernation	Hard disk	Rather long	Not required. (However power is slightly consumed to keep the hibernation.)

Precautions

- Connect the AC adaptor if the computer will be in standby for a long period of time. If you cannot use the AC adaptor, use hibernation instead.
- When carrying your computer, turn the computer off without using the standby or hibernation function. When the computer has been in standby for a specific period of time and the computer automatically enters hibernation depending on the setting, the computer will turn itself on temporarily. (In the default setting, [System hibernates] is set to [Never].)
- Using standby or hibernation repeatedly may cause malfunction of the computer. To stabilize computer operation, restart Windows regularly (about once a week) without using standby or hibernation.
- Save the necessary data.
- Close files you have opened from removable disks and network drives.
- The password you set in the Setup Utility is not requested at resuming. You can use the Windows password for security in standby or hibernation.
 - ① Click [start] - [Control Panel] - [User Accounts], and select the account.
 - ② Click [Create a New password] and set the password.
 - ③ Click [start] - [Control Panel] - [Performance and Maintenance] - [Power Options] - [Advanced], and add the check mark in [Prompt for password when computer resumes from standby].
- Do not enter standby or hibernation in the conditions below, otherwise the data or file may be corrupted, standby or hibernation may not work, or malfunction may occur in the computer or the peripheral devices.
 - When any of the hard disk drive indicator  and the SD Memory Card indicator  is on (accessing drive or card).
 - <Only for CF-F8/CF-W8 Series>
When the CD/DVD drive indicator is blinking (accessing drive).
 - When playing/recording audio files or displaying DVD-Video such as MPEG files.
 - When playing a DVD-Video.
 - When writing to a disc.
 - When using communication software or network function.

- When using peripheral devices.
(If peripheral devices fail to work normally, restart the computer.)
- The computer does not enter standby or hibernation immediately after resuming. Wait approximately one minute.
- When the Wake up from wired LAN function or Wake up from wireless LAN function is enabled (the function is enabled in the default setting), battery consumption will increase while in standby or hibernation.

Setting Standby or Hibernation

- 1** Click [start] - [Control Panel] - [Performance and Maintenance] - [Power Options] - [Advanced].
- 2** Click [Stand by] or [Hibernate] for [When I close the lid of my portable computer:] / [When I press the power button on my computer:], and then select [OK].

NOTE

- You do not need to make the setting if you use the Windows menu to enter standby or hibernation.

Entering/Resuming from Standby or Hibernation

■ To enter standby or hibernation

1 Close the display, or slide the power switch (A) until a beep^{*1} sounds.

Standby: The power indicator (A) blinks green.

Hibernation: The power indicator (A) goes off.

- You can alternatively use the Windows menu to enter standby or hibernation. To enter standby, click [start] - [Turn Off Computer] - [Stand By]. To enter hibernation, click [start] - [Turn Off Computer], then press and hold **Shift** and click [Hibernate].

CF-F8 Series

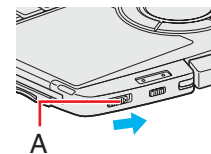

CF-W8/CF-T8 Series

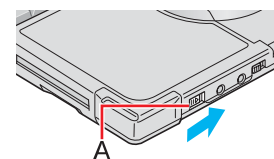

CAUTION

While the computer is entering standby or hibernation

- Do not:
 - Touch the keyboard, Touch Pad, touchscreen (only for CF-T8 Series), or power switch.
 - Use an external mouse or other peripheral devices.
 - Connect or disconnect the AC adaptor.
 - <Only for CF-F8/CF-W8 Series>
 - Operate the drive power/open switch.
 - Operate the wireless switch.
 - Close or open the display.
 - Insert and remove the SD/SDHC Memory Card.

Wait until the power indicator blinks green (standby) or goes off (hibernation).

- It may take one or two minutes to enter standby or hibernation.
- At the beep^{*1}, immediately release the power switch. After releasing the switch, do not operate it until the power indicator blinks or goes off. If you slide and hold the power switch for longer than four seconds, the computer will forcibly shut down and unsaved data will be lost even if you have set [Shut down] in [When I press the power button on my computer:] (→ [page 38](#) "Setting Standby or Hibernation").

In standby or hibernation

- Do not attach or remove a peripheral device. Doing so may cause malfunction.
- Power is consumed in standby. Power consumption may increase when a PC Card is inserted. When power is exhausted, the data retained in memory will be lost. Connect the AC adaptor when using the standby function.

^{*1} If the speakers are muted, beeps do not sound.

■ To resume from standby or hibernation

- 1 Open the display, or slide the power switch (A).

CF-F8 Series

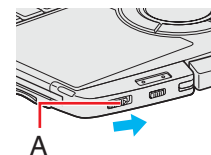

CF-W8/CF-T8 Series

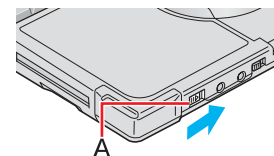

CAUTION

- Do not perform the following operations until resuming is complete. After the display is resumed, wait approximately 15 seconds (normally) or 60 seconds (when the computer is on a network).
 - Touch the keyboard (except for password input), Touch Pad, touchscreen (only for CF-T8 Series), or power switch.
 - Use an external mouse or other peripheral devices.
 - Connect or disconnect the AC adaptor.
 - Close or open the display.
 - Shut down or restart Windows.
 - Enter standby or hibernation (Wait approximately one minute).
 - <Only for CF-F8/CF-W8 Series>
 - Operate the drive power/open switch.
 - Operate the wireless switch.
 - Insert and remove the SD/SDHC Memory Card.

NOTE

- <Only for model with Bluetooth>
After resuming from sleep or hibernation, the message “TosBtMng has stopped working” may appear.
Click [Close program].
If Bluetooth connections are cut off, click [start] - [All Programs] - [Bluetooth] - [Bluetooth Settings], and connect to the Bluetooth devices again.

You can set the password and/or enable/disable some functions for security purpose.

- Another security measure
<Only for model that supports TPM>
 - Embedded Security (TPM) (→ [page 103](#)): For further information, refer to the *Installation Manual* of “Trusted Platform Module (TPM)”.

Setting the Supervisor Password/User Password

Set the Supervisor Password before setting the User Password.

- 1 Start up the Setup Utility (→ [page 97](#)).**
- 2 Select [Security].**
- 3 Select [Set Supervisor Password] or [Set User Password], and press Enter.**
- 4 Enter your password in [Create New Password] and press Enter.**
 - When the password has been set, you need to enter your password in [Enter Current Password] and press Enter.
 - To disable the password, leave the input field empty and press Enter.
- 5 Enter your password again in [Confirm New Password] and press Enter.**
- 6 Press F10, and then select [Yes] and press Enter.**

CAUTION

- Do not forget your password. If you forget your Supervisor Password, you will not be able to use your computer. Contact technical support office.
- When running the Setup Utility, do not leave and go away from your computer even for a short time, since other people may set or change the password.

NOTE

- The password will not be displayed on the screen.
- You can use up to 32 alphanumeric characters (including spaces).
 - The case (upper/lower) is ignored.
 - Use only the upper horizontal row of numeric keys to input your password.
 - You cannot use **Shift** and **Ctrl** to input a password.
- Disabling the Supervisor Password also disables the User Password.

Preventing Your Computer from Unauthorized Use

You can set a start-up password to prevent your computer from unauthorized use.

- 1 **Set the password (→ page 41), and select [Enabled] in [Password on boot] in the [Security] menu of the Setup Utility (→ page 103).**

NOTE

- If the Supervisor Password or User Password has been set, the password input screen will be displayed on starting-up of the Setup Utility even though [Password on boot] is set to [Disabled].

Preventing Your Hard Disk Data from Being Read or Written

When the [Hard Disk Lock] is set to [Enabled], it is impossible to read/write data from/to the hard disk when the hard disk is inserted in a different computer. To be able to read/write data on the original computer, the Setup Utility settings must be the same as when the hard disk was removed.

It is possible to set the hard disk lock even if [Password on boot] is set to [Disabled], but we recommend that [Password on boot] be set to [Enabled] for security reasons.

(Note that this hard disk lock does not guarantee complete protection of data.)

- 1 **Select [Enabled] in [Hard Disk Lock] in the [Security] menu of the Setup Utility (→ page 103).**

CAUTION

- When starting up the computer, if the message [Hard disk access is prohibited by “Hard Disk Lock”] appears, run the Setup Utility, and change the settings to match the details when [Hard Disk Lock] was set.
- You cannot use the hard disk lock function without setting the Supervisor Password. Set the Supervisor Password beforehand (→ page 41).
- When you have your computer repaired
 - Contact technical support office.
 - Before sending back the computer, be sure to set the [Hard Disk Lock] to [Disabled].

NOTE

- The hard disk lock function works with the built-in hard disk. It does not work with the external hard disk.

<Only for CF-F8/CF-W8 Series>

NOTE

- Connect the AC adaptor if writing operation takes a long time. If the remaining battery power becomes low and the power is not supplied, writing operation may not be completed.
- You need to use writing software to write to discs (“Using Roxio Creator LJB” → [page 61](#)).
- Ensure the disc is compatible with the selected writing speed.
- The quality of written data depends on the disc.
- <Only for CF-F8 Series>
Do not touch the handle of the computer when the CD/DVD drive is being used.

Handling Precautions

Drive handling care

- Do not expose the drive to excessive smoke that may leave a residue, e.g., oil smoke, or tobacco smoke. Doing so can shorten the life of the drive lens.
- We recommend cleaning the drive lens with an air puffer used for camera lenses.
(Do not use any spray-type of lens cleaning products.)

When opening/closing the disc cover

- When the computer is on, use the drive power/open switch. (→ [page 52](#))
- When closing the disc cover, press down the center of the disc cover (position indicated “CLOSE” for CF-F8 series, position of the arrow for CF-W8 series) to ensure that the cover is locked.
- Do not access the drive until after the disc cover is closed and the CD/DVD drive indicator changes to lighting from blinking.
- When inserting or removing a disc, be careful not to touch the lens of the drive.
- Do not leave the disc cover open and do not touch the lens.
The lens and disc can become dusty in some conditions. It may cause malfunction in reading or writing.
- The disc cover can be opened up to an angle of 60° - 70° . Do not apply excessive force to the disc cover. If you accidentally touch the disc cover causing the disc cover to open more than the degrees described above, press the cover forward slowly until the stopper returns to its original position.
- Be sure to close the display only after confirming the disc cover is closed. If the disc cover is not closed, the LCD may become damaged.
- Never insert a foreign object such as a paper clip into the drive.
Doing so may cause malfunction.
- Insert the disc securely.
If the disc cover is closed without securely inserting the disc, the disc may be damaged.

CF-F8 Series

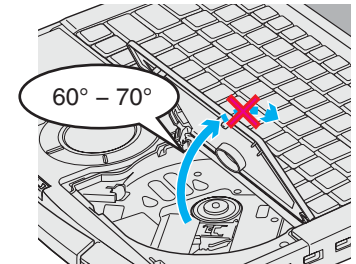
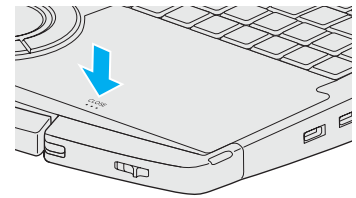

CF-W8 Series

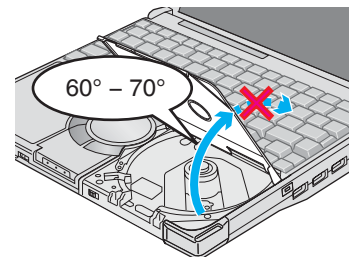
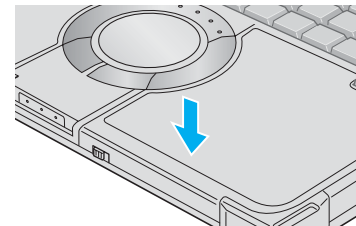

About recognition of disc

- It may take about 40 - 50 seconds for an image recorded to a rewritable media to be played back.

While the drive is being accessed

- Do not open the drive or move the computer while the drive is being accessed.
Doing so could cause the disc to shift position and this may damage the disc, or cause the drive to malfunction.
In addition, after running an application involving access to a disc, close the application before opening the disc cover.
- Do not move the computer while in the midst of writing or rewriting, as this may result in a writing failure.
- Do not apply excessive force to the disc cover.
- Do not operate the drive power/open switch.
- Do not shock the computer by removing or inserting cables and cards, etc. This may result in a read or write malfunction.

Disc handling care

- Do not use deformed, warped, or irregularly shaped discs.
Reading of disc may not be possible depending on the disc conditions (cracks, dirt, modification, data recording quality, copy protection, recording equipment/software that was used to create the disc, etc.)
- Before using a disc, carefully read the operating/handling instructions and package of the disc.
- If the discs are not handled appropriately, they may become dirty or scratched. Furthermore the writing speed may get slower and the data may not be correctly written on or read from the disc. Other damage may cause a drive failure.
- Note the following precautions.
 - Do not touch the disc surface (the side with no printing).
 - Keep the disc surface clean and free from dirt, dust, fingerprints and scratches.
 - Do not write on the surface of the disc with a ballpoint pen or other writing instrument.
 - Do not attach stickers to discs.
 - Do not drop, bend, or place heavy objects on top of discs.
 - Do not place or store discs in locations exposed to heat, direct sunlight, humidity or dust.
 - If a disc is brought from a cold to a warm location, condensation may form on the disc. For read-only discs, wipe off the condensation using a soft, dry, lint-free cloth before using the disc. For recordable/rewritable discs, wait until the condensation dries.
 - When not using discs, keep them in their protective cases or cartridges.

To clean discs

<For read-only discs>

Wipe discs with a dry, soft cloth from the center toward the edge.

If discs get very dirty, wipe with a moist, soft cloth from the center toward the edge, then wipe again with a dry cloth to take up remaining moisture.

<For recordable/rewritable discs>

It is recommended to use the Panasonic disc cleaner.

Do not use a cloth.

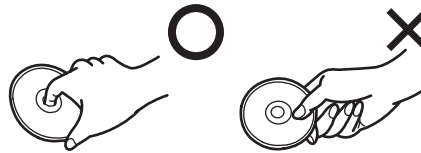
**How to hold a disc**

Turning On/Off the CD/DVD Drive

When you are not using the CD/DVD drive, you can turn the drive power off to minimize power consumption.



■ When you want to minimize power consumption (example)

- Set [Optical Drive Power] in the Setup Utility to [Off]. (→ [page 99](#))
The drive power remains off when the computer is started up.
- To use the drive, turn it on with the drive power/open switch or using [Manual Switching] in the Optical Disc Drive Power-Saving Utility.
- When finished using the drive, turn the drive power off.

NOTE

- The drive power/open switch and the Optical Disc Drive Power-Saving Utility only operates after Windows has started up.
- When the drive power is turned off, the message “The ‘Standard Dual Channel PCI IDE Controller’ device can now be safely removed from the system” will appear, but the CD/DVD drive is an internal device, so it cannot be removed.
- If the software application may not recognize the drive, exit the software application, and then start up the application once more after checking to make sure that the drive power is on.



To check the power status of the drive

Where to check	Power On	Power Off
CD/DVD drive indicator	Light on/Flashing	Off
Drive power icon in the notification area ^{*1}		

*1 When  is displayed in the notification area (below).

Turning on or off immediately

There are two methods, as follows.

- Use [Manual Switching] of the Optical Disc Drive Power-Saving Utility.
 - ① Click  or  on the notification area.
 - ② Click [On] or [Off] for [Manual Switching].
- Slide the drive power/open switch (A) to the left.
 - Each time you slide the switch, you will hear a beep and the drive power will turn on or off.
 - If you slide the switch to the right, you will hear a beep and the disc cover will open after the drive power turns on.

After you hear the beep, it may take a few moments before the drive power turns on/off, or until the cover opens. (If the speaker is muted, beeps do not sound.)

CF-F8 Series

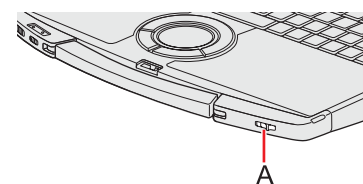

CF-W8 Series

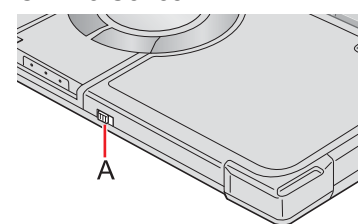





NOTE

- When  is displayed in the notification area:
 - The [Optical Drive] in the [Advanced] menu of the Setup Utility is set to [Disabled]. In this case, you cannot use the Optical Disc Drive Power-Saving Utility or the drive power/open switch.
- The Optical Disc Drive Power-Saving Utility only works with the internal CD/DVD drive in this computer. It will not work with external CD/DVD drives.
- In the following cases, it is not possible to turn off using [Manual Switching]:
 - When WinDVD is running
 - During writing or reading of a disc
- Do not slide the drive power/open switch repeatedly.

Turning off automatically after a preset time has elapsed (Optical Disc Drive Power-Saving Utility)



[Auto Off Setting] of this utility automatically turns the drive power off after the CD/DVD drive power has been turned on, or after a disc has been removed from the CD/DVD drive, if a certain period of time passes during which a disc is not set in the drive.

This utility starts up when computer is started, and  or  appears on the notification area.

- To turn the power on again after it has turned off: See “Turning on or off immediately” (→ page 47)
- To restart this utility after selecting [Exit], click [start] - [All Programs] - [Panasonic] - [Optical Disc Drive Power-Saving Utility], or restart the computer.
- When the cursor is placed over  or , pop-up text will indicate the drive status and the setting time.

[Auto Off Setting]	[Manual Switching]
1minute	On
✓ 3minutes	Version
5minutes	Exit
Disable	

■ Change the time until the power turns off

- 1 Click  or  on the notification area.
- 2 Select the desired time in [Auto Off Setting].

This setup operates only when the disk is not set





[Auto Off Setting]	[Manual Switching]
1minute	On
✓ 3minutes	Version
5minutes	Exit
Disable	

NOTE

- In the following cases, the drive power will not turn off even after the time set in [Auto Off Setting].
 - When the disc cover is open
 - When a disc is set in the drive
 - When an external CD/DVD drive is connected (Including using a virtual CD drive)
 - When WinDVD is running







Disc Information





- You can read from/write to the following discs.

CD-R	CD-RW ^{*2}		
			

DVD-RAM ^{*3*4*5}	DVD-R ^{*5*6}	DVD-RW ^{*5*6*7}	+R ^{*5*6}	+RW ^{*5*6*8}
				

- You can read from the following discs.

CD-ROM	CD DIGITAL AUDIO	CD TEXT	CD-EXTRA	Video CD	Photo CD ^{*9}
					

DVD-ROM	DVD-Video	DVD-R DL ^{*6*10}	+R DL ^{*6*10}
			

^{*2} Does not support Ultra-Speed CD-RW to write.

^{*3} Only non-cartridge type or removable cartridge type can be used.

^{*4} You can read, write or rewrite as with the hard disk using Windows Explorer, without using the writing software. After writing using Roxio Creator LJB, it will no longer be possible to write using other writing software. To write using Explorer again, you need to format the disc. Be sure to remove the check mark from [Quick format] to write using Explorer.

^{*5} To write DVD-Video mode/VR mode/+VR mode, specific software is required

^{*6} DVD-Video mode/VR mode/+VR mode: Finalize using DVD recorder (→ [page 60](#))

*7 Does not support DVD-RW Ver.1.0.

*8 <Only for CF-W8 Series>

Does not support High Speed +RW.

*9 Specific Software is required.

*10 When playing back videos recorded over both layers of a one-sided, dual-layer disc, videos or sounds are interrupted at the point where the recording layers change.

■ Recommended discs for writing

Visit the following web site: <http://pc-dl.panasonic.co.jp/itn/support/disk/diskinfo.html>

Using DVD Discs

To play DVD-Video or MPEG2 files, you need to use DVD playback software such as WinDVD (→ [page 57](#)).

■ Region code setting

DVD-Video are allocated to region codes according to where they are sold. To play a DVD-Video, the player's software and the drive must have the corresponding region code.

e.g.,

For U.S.A. and Canada: "1"

For Europe: "2"

For Southeast Asia (including Hong Kong and Taiwan): "3"

- The region code of the drive is not set at purchase. The operation depends on the DVD-Video that is first played.
 - **DVD-Video with a specific region code:**
The drive will automatically be set at the same region code as the DVD-Video.
 - **DVD-Video with multiple region codes:**
[Confirm Region] appears. Select the region code and click [OK]. Play now begins.

CAUTION

- You can change the region code setting up to five times including the initial setting. Be extremely careful because you cannot change the region code anymore after the fifth change, even if you reinstall the operating system.
 - Any problem resulting from illegal changing or altering of the region code is the user's responsibility.
-

NOTE

- [Confirm Region] appears when the DVD-Video has only one region code and the drive is set for another region code. ([Confirm Region] may not appear with some DVD-Video discs. To check the current region code and the number of remaining times of changing the code, right-click on the WinDVD screen and click [Setup] - [Region].)
-

Inserting/Removing a Disc

- 1 Turn on the computer.
- 2 Slide the drive power/open switch (A) to the right.
 - If the CD/DVD drive indicator is off (drive power is off), it will take some time for the drive power to turn on, and for the disc cover to open. Wait for a moment.

CF-F8 Series

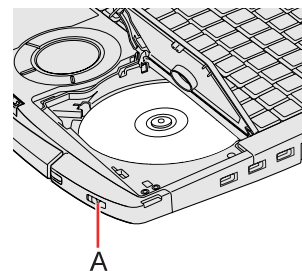

CF-W8 Series

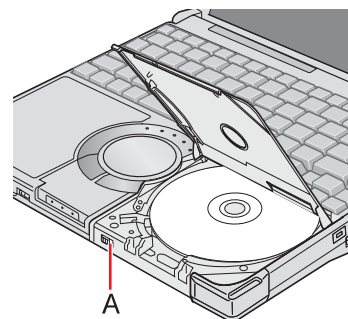

- 3 Raise the disc cover a little.
 - Do not force it open any wider than about 60° - 70°. If you accidentally do so, press the cover forward slowly until the stopper returns to its original position.
 - If the disc cover cannot open if a hand is on the disc cover or the display is closed, the drive will not be accessed correctly. In this case, open and close the disc cover once or restart the computer.

4 Insert/Remove a disc.

- To insert
 - ① With the title side of the disc (B) facing up, insert the disc under the keyboard.
 - ② Push down on the center of the disc until it clicks in place.
- To remove
 - ① Press on the center spindle (C) and carefully lift up the edge of the disc.

CF-F8 Series

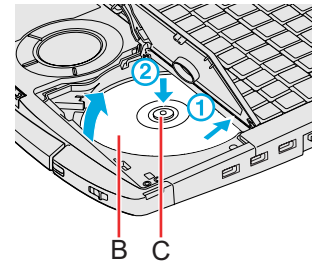

CF-W8 Series

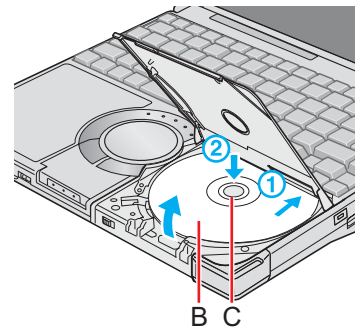

5 Close the disc cover.

Press down the center of the disc cover (position indicated “CLOSE” for CF-F8 series, position of the arrow for CF-W8 series) to ensure that the cover is locked.

CF-F8 Series

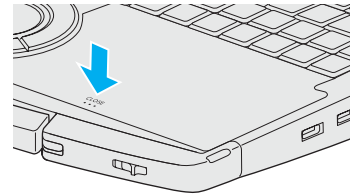

CF-W8 Series

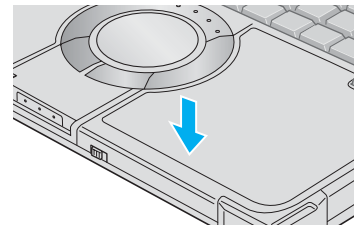

NOTE

- To remove a disc when the disc cover cannot be opened or when the computer is powered off:
 - Insert a pointed object (e.g., the bent-out tip of a paper clip, or the tip of a ballpoint pen) into the emergency hole (A), and move in the direction of the arrow.

CF-F8 Series

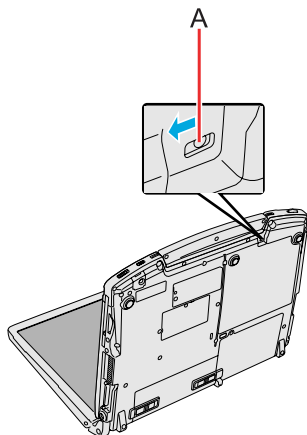

CF-W8 Series

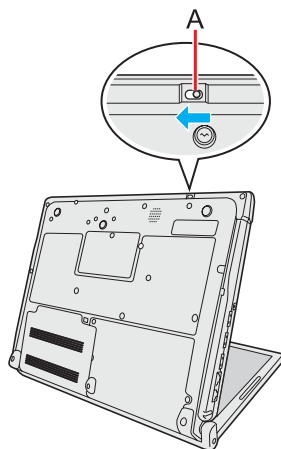

- For AutoPlay CD:
 - An AutoPlay CD may start during file access depending on the status of the disc.
- When playing back motion video from a disc, playback may not be smooth in some conditions.

Power-saving mode

If the drive is not accessed for 30 seconds, the drive motor will automatically be shut down to reduce the power consumption. When the drive is accessed again, the drive motor is turned on. In this case, reading of the disc data will take approximately 30 seconds.

Changing the Internal CD/DVD Drive Letter

You can change the drive letters for the CD/DVD drive.

- ① Log on to Windows as an administrator.
- ② Confirm whether the CD/DVD drive power is on.
If the drive power is off, turn it on.
- ③ Click [start] - [All Programs] - [Panasonic] - [Optical Disc Drive Letter-Setting Utility].
- ④ Click  in [New drive letter], click the drive letter, and click [OK].

NOTE

- If you use the Fast User Switching function to log on as a different user while Optical Disc Drive Letter-Setting Utility is running, you will not be able to start up Optical Disc Drive Letter-Setting Utility from the second user account.

<Only for CF-F8/CF-W8 Series>

WinDVD is a software application for DVD playback. For further information, refer to the software's online manual.

- DVD-Audio cannot be played back using WinDVD.

Running WinDVD

1 Double-click on the desktop.

- Alternatively click [start] - [All Programs] - [InterVideo WinDVD] - [InterVideo WinDVD for Panasonic].
- Use WinDVD as administrator.

If the AutoPlay screen is displayed after a disc is set in the CD/DVD drive, click [Play DVD movie-using InterVideoWinDVD].

■ To access the online manual

After starting WinDVD, perform either of the following procedures.

- Click "?" on the WinDVD control panel.
- Right-click on the WinDVD screen and click [Help].

SUPPORT INFORMATION

If WinDVD does not operate properly, we recommend carefully reading the online help file first for problems with the operating environment or operations.

If you still cannot troubleshoot the problem, enter the required information in the inquiry form on the homepage (<http://www.corel.com/>), and submit the form.

CAUTION

- Do not start WinDVD while the hard disk drive indicator  is blinking immediately after the computer is turned on.
- While WinDVD is running, do not:
 - Enter standby or hibernation.
 - Switch the display by pressing **Fn + F3**.
 - Turn off the CD/DVD drive power.If performing the operations described above, shut down WinDVD, then restart.
- During motion video playback, do not:
 - Eject the disc.
 - Use other applications or the Command Prompt.
 - Change the settings of the screen properties.
 - Turn off the CD/DVD drive power.If performing the operations described above, shut down WinDVD, then restart.
- Do not install another player software together with WinDVD.
Doing so may interfere with smooth playback. Some DVD-Video discs contain the player software and start installing. In

this case, cancel the installation as soon as possible. If you accidentally installed another player software and find a problem in playback, try either of the following procedures.

- Uninstall the player software by clicking [start] - [Control Panel] - [Add or Remove Programs]. (Refer to the instruction manual for the name of player software.)
- Set WinDVD as the playback software if you can select the option in the player software settings.

NOTE

- OEM version of WinDVD that has been installed does not support some of the functions in Help items.

Notes During Use

■ Use WinDVD for playing back a DVD Video.

- If the AutoPlay screen is displayed, select [Play DVD video using InterVideo WinDVD].
- If Windows® Media Player is used for playback, audio may come out neither at all nor properly since some audio codecs are not available.

■ If you maximize the video display window:

- You can return to the original window size by double-clicking over the images.

■ To adjust the volume:

- Use the WinDVD control panel.
 - While WinDVD is running, the volume setting may return to the volume adjusted with the WinDVD when you pause, fast-forward, fast-reverse or skip between chapters. Priority is given to the volume adjusted by WinDVD, even if the volume is adjusted using **Fn + F5 / F6** or the icon on the notification area.
 - After shutting down WinDVD, the volume and mute settings adjusted with the WinDVD will return to the original settings.

■ When the number of display colors is increased, a message appears and the DVD cannot be played

- Reduce the number of display colors.

■ Frame dropping may occur (images or sounds are disrupted)

- Immediately after resuming from a pause, frame dropping may occur depending on the operating environment or DVD video (images or sounds are disrupted).
- If the DVD video software other than WinDVD has been installed, the images and motion videos may not be displayed properly.

■ If you cannot play the disc contents smoothly:

- In the case of some operating environments or DVD videos, playback may not be smooth, or audio may become distorted when using fast-forward (“time stretch”).
- In the Extended Desktop or simultaneous (internal/external) display mode, there are times when images or motion video are not displayed correctly.

■ The playback screen appears to be blurred, white, and jumpy

- Change the color preset settings.
 - ① Click  on the Player Panel to display the Video Center.
 - ② Click [Color].
 - ③ Click [Custom], and on the same screen adjust the color by moving the sliders.

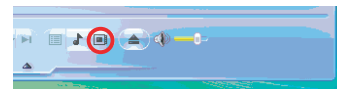

■ When battery operation time has become short:

- Click  on the Player Panel and click [Display]. Set [Deinterlace] to [Auto] in the Video Center.

■ Changing power settings

- While a video is playing on WinDVD, the [Power schemes] in [Power Options Properties] switch to [Intervideo WinDVD]. This will return to the original setting when the playback is stopped.

■ If you have uninstalled WinDVD accidentally:

- Reinstall it by following the steps below.
 - ① Log on to Windows as an administrator.
 - ② Input [c:\util\windvd\setup.exe]^{*1} in [start] - [Run] and click [OK]. Follow the on-screen instructions and install WinDVD.
 - When the [License Agreement] screen^{*1} appears, click [Yes] if you agree to the terms.

^{*1} Refer to “LIMITED USE LICENSE AGREEMENT” in the *Operating Instructions* for this computer.

DVD Discs Created Using a DVD Recorder

- Playback may not be possible depending on the DVD recorder or the discs.
- You must finalize^{*2} discs other than DVD-RAM before playback. For further information, refer to the instruction manual of the DVD recorder.
- You cannot play discs protected with copyright management technologies such as CPPM (Content Protection for Pre-recorded Media) and CPRM (Content Protection for Recordable Media).

^{*2} A process that enables the playback of the discs on other DVD players, etc.

<Only for CF-F8/CF-W8 Series>

■ Applicable Media

- Refer to the Disc Information (→ [page 50](#))
- Refer to the software's online manual (→ [page 62](#)).

About Copies

When writing to discs, make sure that you are not infringing upon any copyrights. It is illegal to copy audio CDs for non-personal use.

When backing up software, make sure that you are not infringing upon any software copyrights for that product.

Using Roxio Creator LJB

“Roxio Creator LJB” is a CD/DVD recording software application developed by Sonic Solutions. For further information, refer to the software's online manual (→ [page 62](#)).

- 1 Click [start] - [All Programs] - [Roxio Creator LJB] - [Roxio Creator LJB].

CAUTION

- **If you format a disc using Windows functions, you cannot write with Roxio Creator LJB.**
Do not format a disc using Windows functions when you write to the disc using Roxio Creator LJB. For rewritable discs (i.e. CD-RW, etc.), writing is possible using Roxio Creator LJB if all the disc contents are deleted.
- **If you set an unused disc in the CD/DVD drive, [Automatic playback] screen may appear and then Windows format screen may be displayed. Do not format the disc when you use Roxio Creator LJB.**
When you write to the disc using Roxio Creator LJB, start Roxio Creator LJB before setting the disc. Windows format screen will not be displayed, which prevents the disc from being mistakenly formatted.

■ To access the online manual

- ① After starting Roxio Creator LJB, click [Help] - [Tutotial].

Usage Precautions

■ When an external CD/DVD drive has been connected

- Do not turn the CD/DVD drive power off on this computer when writing to a disc in an external CD/DVD drive. Turning the power off may result in a malfunction, such as an interruption in the external CD/DVD drive operation.

Using DVD-RAM

■ Writing to DVD-RAM

- Logical formatting must be executed to write a file to a DVD-RAM. It is possible to write a file to a logically formatted DVD-RAM in the same way as writing a file to a floppy disk or hard disk.
If you write using Roxio Creator LJB, because the format is different, it will no longer be possible to write using applications other than Roxio Creator LJB. To enable writing, it will be necessary to select [Quick format] when formatting the disc.

Refer to [Using DVD-RAM disc]. To display:

Click [start] - [All Programs] - [DVD-RAM] - [DVD-RAM Driver] - [Using DVD-RAM disc].

When [DVD-RAM] is not displayed even if you click [start] - [All Programs], install DVD-RAM Driver.

- ① Click [start] - [Run] and input [c:\util\drivers\ramdrv\english\setup.exe] and then click [OK].
As for english folder, change to the language you install.
Follow the on-screen instructions.

■ Logical format type

There are six types of DVD-RAM formats, as shown below. We recommend that you choose the format type depending on the application.

Format	Feature
FAT32	This format is supported by Windows 95 (OSR2) / 98 / Me / 2000 / XP / Vista. DVD-RAM discs in FAT32 format cannot be used on Windows 95 (other than OSR2) / Windows NT.
UDF1.02	This format is supported by Windows 98 / Me / 2000 / XP / Vista, and compatible with the Video mode of DVD-ROM / DVD-R / DVD-RW / +R / +RW.
UDF1.50	Standard format for DVD-RAM. Data with large file sizes (video or audio data) can be written at high speed. We recommend this format when using DVD-RAM for storing data.
UDF2.00/2.01	This format is used for DVD video recorders conforming to "Video Recording Standards" as established by the DVD Forum, or for PC recording software conforming to the same standards.
UDF2.5	This format is supported by Windows Vista, and is used for Blu-ray recorders or PC recording software conforming to "Video Recording Standards" as established by the Blu-ray Disc Association. This format cannot be used for DVD recorders conforming to "Video Recording Standards" as established by the DVD Forum, or for PC recording software conforming to the same standards.

■ Logical format method

- Formatting software and drivers required to conduct each type of formatting have been installed on this computer. When formatting is executed, data recorded on the disc is erased. Back up data as required.
 - ① Log on to Windows with the administrator authority.
 - ② Set a disc in the CD/DVD drive.
 - ③ Close all applications that use DVD-RAM.
 - ④ Click [start] - [All Programs] - [DVD-RAM] - [DVD-RAM Driver] - [DVDForm].
 - When [DVD-RAM] is not displayed even if you click [start] - [All Programs], install DVD-RAM Driver. Click [start] - [Run] and input [c:\util\drivers\ramdrv\english\setup.exe] and then click [OK]. As for english folder, change to the language you install. Follow the on-screen instructions.
 - ⑤ Click  in [Format Type], and select the format type, then click [Start].
 - [Volume label]
UDF format has been selected, input the volume label. When the volume label is not input, it will be set automatically (UDF year / month / day).

- [Quick format]
Inspect all sectors on the disc, and execute replacement processing of bad sectors. Normally, it is not necessary to select this.

CAUTION

- If you have written using Roxio Creator LJB, you cannot write using other software since the format becomes different. To make this possible, you need to perform the logical format. For further information, see “Using DVD-RAM disc”. “Using DVD-RAM disc” is displayed by clicking [Start] - [All Programs] - [DVD-RAM] - [DVD-RAM driver] - [Using DVD-RAM disc].

Notes During Use

■ If you have uninstalled Roxio Creator LJB accidentally

- Reinstall it by following the steps below.
 - ① Log on to Windows as an administrator.
 - ② Click [start] - [Run] and input [c:\util\sonic\emc\setup.exe], then click [OK].
Follow the on-screen instructions.
 - The serial number has been entered beforehand. Do not change the serial number entered. If you have accidentally changed, click [Cancel] to reinstall.

SUPPORT INFORMATION

- About User Registration

Follow the steps below for user registration.

- ① While connected to the Internet, start up Roxio Creator LJB.
 - ② Click [Help] - [Register Now] and follow the on-screen instructions.
- If Roxio Creator LJB does not operate properly, we recommend carefully reading the online help file first for problems with the operating environment or operations.

If you still cannot troubleshoot the problem, contact Sonic Solutions.

URL:

English (U.S.): <http://www.roxio.jp/enu/support/default.html>

English (U.K.): <http://www.roxio.jp/eng/support/Default.html>

French: <http://www.roxio.jp/fra/support/contact/>

German: <http://www.roxio.jp/deu/support/>

Dutch: <http://www.roxio.jp/nld/support/Default.html>

You can insert the PC Card Type I (3.3 mm) or II (5.0 mm) to the PC Card slot.

NOTE

- The following types of card are not supported:
PC Card Type III, ZV card, SRAM card, FLASH ROM card (excluding ATA interface type), and other cards that require 12V of operating voltage.

Inserting/Removing the Card

CAUTION

- Do not remove a PC Card while your computer is in the standby or hibernation.
- Do not forcefully insert the card. Depending on the shape of the card, parts of the card may remain outside after insertion. The PC Card slot or the card may be damaged or become stuck if it is forced in.
- Note that the PC Card removal may not be complete, depending on the status of the PC Card or the device connected to the PC Card; this may occur when a SCSI card is used to connect an external hard disk to the computer. In such cases, turn off the power from the [start] menu, then remove the card.

■ To insert the card

- 1** Insert the PC Card with the label side up until it securely fits in the slot.
 - For further information, refer to the instruction manual of the card.
- 2** After the card is inserted, bend the eject button (A).

CF-F8 Series

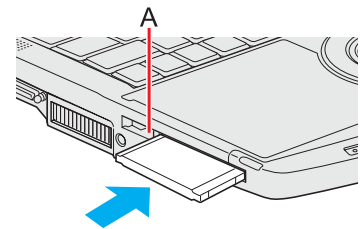

CF-W8/CF-T8 Series

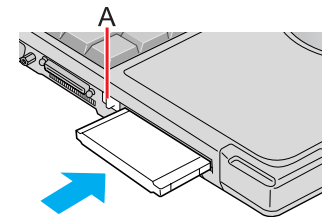

■ To remove the card

1 Disable the card function.

- ① Double-click  on the notification area and select the card, then click [Stop].
- ② Follow the on-screen instructions.
 - This step is not necessary when removing the card after turning off the computer.

2 Remove the card.

- ① Raise the bent part of the eject button.
- ② Press the eject button so the card comes out of the slot.
- ③ Draw the card straight out.

CF-F8 Series

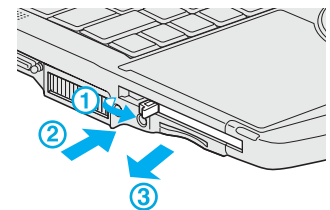

CF-W8/CF-T8 Series

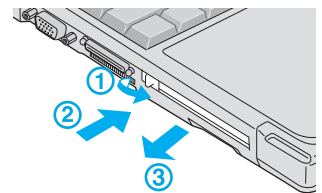

NOTE

- Check the card's specification to prevent the total operating current from exceeding the allowable limit. Otherwise malfunction may occur.
Allowable Current: 3.3 V: 400 mA, 5.0 V: 400 mA
- After repeating insertion and removal, some types of card will not be recognized. In this case, restart the computer.
- If the computer freezes after resuming from standby or hibernation, remove and reinsert the card. If the problem persists, restart the computer.
- When a card is inserted, power consumption increases. Remove the card when it is not in use, especially when operating by battery power.
- To connect peripheral devices (SCSI, IEEE1394, etc.) using a PC Card, follow the steps below (one example).
 - ① Connect the peripheral device to the card.
 - ② Turn on the power of device.
 - ③ Insert the card until it securely fits in the slot.

SD/SDHC Memory Card Information

The SD Memory Card slot on this computer only accepts SD/SDHC Memory Cards.

- When you use a miniSD Card or a microSD Card, set the card to a miniSD Card adaptor or a microSD Card adaptor, and insert/remove the card with the adaptor. Be sure not to leave the adaptor in the card slot.
- The SD/SDHC Memory Card has a copyright protection function which is compatible with content on-demand services on the Internet, etc.
- To format the SD/SDHC Memory Card on this computer, do not use [Format] of Windows, but use the SD/SDHC Memory Card format software.
You can download the software from the web site below.
http://panasonic.jp/support/global/cs/sd/download/sd_formatter.html
- To use the SD/SDHC Memory Card on other devices, format the card on the devices. For further information, refer to the instruction manual of the devices.

Handling and storage cautions

- Store the SD/SDHC Memory Card in the case after removing it from the computer.
- Do not:
 - Disassemble or modify the card.
 - Hit, bend, drop or wet the card.
 - Touch the terminals with fingers or metal object.
 - Remove the labels of the card / Attach other labels or stickers to the card.
- Do not place the card in the following locations.
 - In direct sunlight or in very hot location such as inside of a car.
 - In very dusty or humid location.
 - In location subject to corrosive gas, etc.

Data handling cautions

- Set the write-protect switch (A) to the LOCK position. Unlock the switch when recording (checkout), saving, or editing data.
- We recommend you to back up the important data to another storage medium.
- When disposing the card, we recommend you to physically destroy the card (using a hammer, etc.) to prevent personal or confidential data from being leaked.

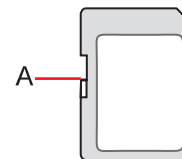

Inserting/Removing the SD/SDHC Memory Card

CAUTION



- Do not remove or insert the SD/SDHC Memory Card until Windows has completed loading.
- Do not remove the card or turn off the computer in the following cases, otherwise the data may be corrupted.
Just after the writing operation.
The computer may still continue the access to the card just after writing operation. If you remove the card before the operation is completed, the data may be damaged or the card access may no longer perform normally.
- Note that Panasonic assumes absolutely no liability for any loss of data recorded by the user, or any other damages, directly or indirectly.
- Do not forcibly draw out the card, otherwise the slot may be damaged.
- Insert the card in the correct direction, otherwise the card and the slot may be damaged.
- After resuming from standby or hibernation, do not access the SD/SDHC Memory Card for approximately 30 seconds.

■ To insert the card

- 1 **Insert the SD/SDHC Memory Card with the label side facing up and with the cut corner on top.**

■ To remove the card

Preparation

- Save the data and close all applications.
- Confirm the SD Memory Card indicator  is off.
- When SD Memory Card security function is enabled, it may be possible to remove the card even when  is blinking.

- 1 **Disable the card function.**

- ① Double-click  on the notification area and select [SD Memory Card], then click [Stop].
- ② Follow the on-screen instructions.
 - This step is not necessary when removing the card after turning off the computer.

CF-F8 Series

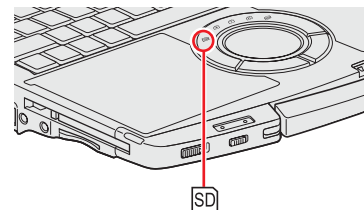

CF-W8/CF-T8 Series

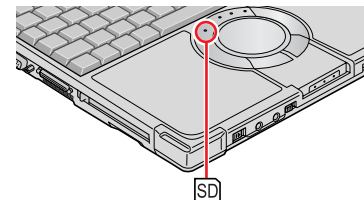

2 Remove the card.

- ① Press the card so it comes out of the slot.
- ② Draw it straight out.

CF-F8 Series

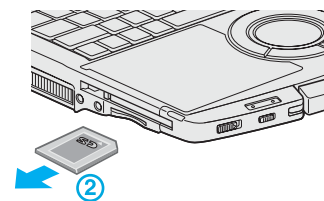

CF-W8/CF-T8 Series

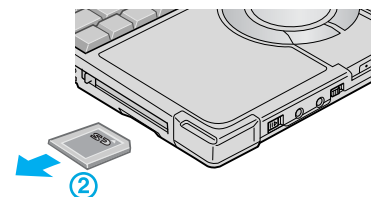

You can use an optional mini port replicator (CF-VEBU08U for CF-F8 Series, CF-VEBU05BU for CF-W8/CF-T8 Series). This device frees you from being bothered by a lot of cable connections when you carry the computer. It also allows you to connect various peripherals. Connect the mini port replicator to the mini port replicator connector (A). For further information, refer to the instruction manual of the mini port replicator.

CF-F8 Series

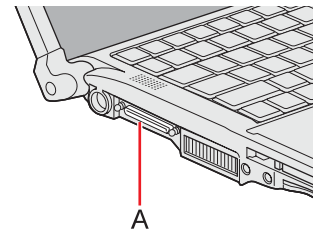

CF-W8/CF-T8 Series

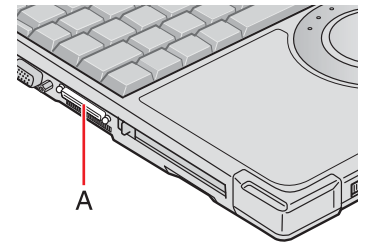

NOTE

- To use the mini port replicator, set [USB Port] setting to [Enabled] (default) in the [Advanced] menu of the Setup Utility.
- If devices connected to USB ports (2a, 2b, 2c) does not operate:
In the case of devices with consumption voltage exceeding 100 mA, or devices for which the consumption voltage cannot be confirmed, connect via USB port 1 or the computer's USB port.
For further information, refer to "When using a commercially available USB2.0 Hub". (→ [page 77](#))
- <Only for CF-F8 Series>
When the mini port replicator is connected, LAN cable and AC adaptor should be connected to the mini port replicator.
The LAN port cannot be used.
- <Only for CF-W8/CF-T8 Series>
When the mini port replicator is connected, LAN cable and External display port should be connected to the mini port replicator.
The LAN port and External display port cannot be used.
- <Only for CF-W8/CF-T8 Series>
When the mini port replicator is connected, an external display should be connected to the mini port replicator.
The external display port cannot be used.
- <Only for CF-F8 Series>
If you use an external display compatible with "DisplayPort connector", connect it to a "DisplayPort connector" on an optional mini port replicator (CF-VEBU08U) using a cable compatible with "DisplayPort connector".

You can switch the output destination to an external display.
Connect the external display to the external display port (A).

CF-F8 Series

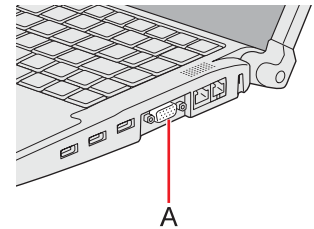

CF-W8/CF-T8 Series

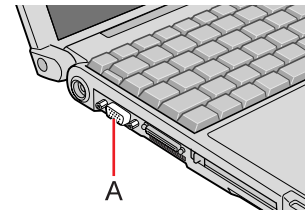

NOTE

- After resuming from hibernation or restarting the computer, the output destination may not be the same as the one selected in the previous status.
- Do not connect or remove the external display during standby or hibernation.
- It may take some time to switch between displays depending on the displays used.
- When you use high resolution displays, the display color, resolution or refresh rate may be changed, switching to [Notebook] in [Intel(R) Graphics Media Accelerator Driver for Mobile]. We recommend you to switch the output destination by pressing **Fn+F3**.
- When you change the output destination after Windows starts up, do not press any key until switching is complete.
- You cannot use the simultaneous display until Windows starts up.
- Display switching by pressing **Fn+F3** may not work when you use the Fast User Switching function to switch the user. In this case, log off all users and restart the computer.
- Simultaneous display and display switching do not work when [Command Prompt] screen is set to "Full Screen".
- When you use an external display or extended desktop, click [Display Settings] and set a suitable number of colors, resolution, or refresh rate for each display. Depending on the settings, some external displays may be distorted or displayed incorrectly. In this case, check the refresh rate setting.
- When you use the simultaneous display, DVD-Video, MPEG files and other motion image files may not be played back smoothly.
- Carefully read the instruction manual of the external display.
- When connecting an external display that does not conform to the Plug & Play standards, select the display driver accordingly in the following menu, or use the driver disc supplied with the external display.
[start] - [Control Panel] - [Appearance and Themes] - [Display] - [Settings] - [Advanced] - [Monitor] - [Properties] - [Driver] - [Update Driver]

- If a picture is not displayed normally, lower the level of [Hardware acceleration] in the following menu. [start] - [Control Panel] - [Appearance and Themes] - [Display] - [Settings] - [Advanced] - [Troubleshoot]
- If you connect an external display via the mini port replicator, you cannot use the external display port on the computer.
- <Only for CF-F8 Series>
If you use an external display compatible with “DisplayPort connector”, connect it to a “DisplayPort connector” on an optional mini port replicator (CF-VEBU08U) using a cable compatible with “DisplayPort connector”.

CAUTION

- Before disconnecting the external display, switch to the internal LCD by pressing **Fn+F3**. Otherwise the displayed image quality may become different form before disconnection (e.g., wrong resolution). In this case, press **Fn+F3** to reset the image quality.

Switching the Display

1 Press **Fn+F3**.

Each time you press the key combination:

Internal LCD → Simultaneous display → External display



NOTE

- <Only for CF-F8 Series>
When an external display is connected to an optional mini port replicator (CF-VEBU08U), the display switching may work differently from the above. For further information, refer to the instruction manual of the mini port replicator.

Extended Desktop

The extended desktop function allows you to use the working area across both the internal LCD and the external display. You can drag an object from the internal LCD to the external display and vice versa.

- 1 Click [start] - [Control Panel] - [Other Control Panel Options] - [Intel(R) GMA Driver for Mobile].
- 2 Select [Extended Desktop] in [Operating Mode], and select the settings for [Primary Device] and [Secondary Device].
- 3 Click [Display Settings] and set the display color and resolution etc.
- 4 Click [OK].

NOTE

- Always change the settings in the manner described.
- It may not be possible to use the extended desktop with some software applications.
- When you click the maximize button, the window is displayed on one of the displays. You cannot move the maximized window to the other display.
- You cannot switch the display by pressing **Fn+F3** when using the extended desktop.
- **When the application running is not shown on the display:**

When the application is in the external display or after the application is closed in the external display, there are times the application will not be shown in the display when executed the next time if the position of the extended display is changed or the Extended Desktop is closed.

When there is no display after the position of the extended display is changed:
The application running is displayed at the position of the extended display before the change. Return the position of the extended display to the condition before the change. Move the application to the internal LCD, and then correct the position of the extended display.

When there is no display when the Extended Desktop is disabled:
The application running is being displayed in the external display. Set the Extended Desktop again, move the application from the external display to the internal LCD and then disable the Extended Desktop.
- When the display domain for the Extended Desktop is changed, the wallpaper and icons may become displaced.
- **When an animated pointer is used for the mouse pointer:**

An error may occur when resuming from the standby or hibernation. In such cases, change the mouse pointer to the standard pointer with the following procedure:

 - ① Click [start] - [Control Panel] - [Printers and Other Hardware] - [Mouse].
 - ② Click [Pointers].
 - ③ Click [(None)] in [Scheme], then click [OK].
- <Only for CF-T8 Series>

Set the internal LCD to the primary device when using the touchscreen. The cursor will move on the primary device when you touch the internal LCD.

Connecting/Removing USB Devices

■ To connect the device

- 1 Connect the USB device to one of the USB ports (A).**
For further information, refer to the instruction manual of the USB device.

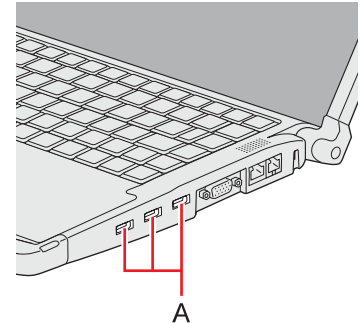

CF-F8 Series

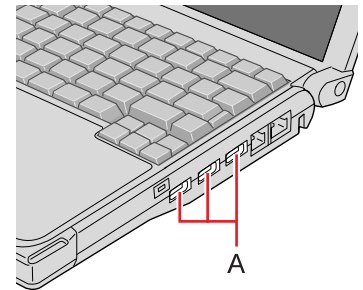

CF-W8/CF-T8 Series



■ To remove the device

- 1 Disable the USB device.**
 - ① Double-click  on the notification area and select the USB device, then select [Stop].
 - ② Follow the on-screen instructions.
 - This step is not necessary when;
 - Removing the device after turning off the computer.
 -  is not displayed.
 - The device does not appear in the list in step ①.

- 2 Remove the USB device.**

CAUTION

- Do not remove a USB device while your computer is in the standby or hibernation.
- Save important data and close all applications.

NOTE



- You may need to install the driver for the USB device. Follow the on-screen instructions or refer to the instruction manual of the USB device.
- You may need to install the driver again when connecting the device to another port.
- When a USB device is connected, standby and hibernation may not function normally. If the computer does not start up normally, remove the USB device and restart the computer.
- Some devices will not operate when connected to a USB HUB. These devices must be connected directly to the USB port on your computer.
- When the USB device is removed and then inserted while the computer is on,  may appear in the Device Manager and the device may not be correctly recognized. In this case, remove and connect the device again, or restart the computer.
- When a USB device is connected, power consumption increases. Remove the USB device when it is not in use, especially when operating by battery power.

When Using an External Mouse

Before installing an external mouse driver, first uninstall the Touch Pad driver. In this case, you will be unable to use the Touch Pad scroll function.

CAUTION

- Before uninstalling the driver, save important data and close each application.

- 1** Click  or  on the notification area, and then click [Exit].
- 2** Click [start] - [Control Panel] - [Add or Remove Programs] - [Touch Pad Utility], and then click [Remove] to remove the program.
 - Following the on-screen instructions.
 - If the message [Locked File Detected] is displayed, click [Reboot].
- 3** Click [start] - [Control Panel] - [Add or Remove Programs] - [Synaptics Pointing Device Driver], and then click [Remove] to uninstall the driver.
- 4** After following the on-screen instructions to uninstall the driver, click [start] - [Turn Off Computer] - [Turn Off].
- 5** Turn on the computer and start Windows.
- 6** Install the mouse driver according to the instructions manual of the mouse driver.

NOTE

- If you do not use an external mouse and use the Touch Pad Scroll function again, follow the procedure for “When using the Touch Pad Utility”. (below)

■ When using the Touch Pad Utility

- 1** Click [start] - [Control Panel] - [Add or Remove Programs] to remove the external mouse driver.
 - For further information, refer to the instructions manual of the mouse driver.
- 2** After the driver is removed, turn off the computer.
 - If an external mouse is connected, disconnect it after turning off the computer.

- 3 Turn on the computer.**
- 4 Click [start] - [Run] and input [c:\util\drivers\mouse\setup.exe] and then click [OK].**
 - Follow the on-screen instructions.
 - At [Setup complete], confirm that [Yes, I want to restart my computer now] is set and click [Finish].
- 5 Restart the computer, and if [Synaptics Pointing Device Settings] is displayed, remove the check mark from [Show this screen at startup] and click [Close].**
- 6 Click [start] - [Run] and input [c:\util\wheelpad\setup.exe], and then click [OK].**
 - Follow the on-screen instructions.
 - If the message [Touch Pad function and original Flat Pad scroll function cannot be used simultaneously] is displayed after completing the installation, click [Yes].

When using a commercially available USB2.0 Hub

A commercially available USB2.0 Hub connected to your computer may stop functioning if a USB2.0 printer is disconnected from another port. This phenomenon may occur when a USB2.0 printer is connected to the USB port 1 on the mini port replicator (CF-VEBU08U for CF-F8 Series, CF-VEBU05BU for CF-W8/CF-T8 Series).

Perform one of the following procedures.

- Connect the USB2.0 printer to the USB2.0 Hub.
- Connect the USB2.0 printer to the USB port (2a, 2b, 2c) on the mini port replicator (CF-VEBU08U for CF-F8 Series, CF-VEBU05BU for CF-W8/CF-T8 Series).
- Deactivate the power saving function of the USB2.0 Root Hub.

When you deactivate the power saving function, you can select two methods.

- Manually deactivate the power saving function of the USB2.0 Root Hub: Perform the following procedure
- Deactivate automatically the power saving function of the USB2.0 Root Hub: ([→ page 78](#))

Manually deactivate the power saving function of the USB2.0 Root Hub

- 1 Click [start] - [Control Panel] - [Performance and Maintenance] - [System].**
- 2 Click [Hardware] - [Device Manager].**
- 3 On the Device Manager display, click [View] - [Devices by connection].**
- 4 Click  for the following items in order.
[ACPI Multiprocessor PC] - [Microsoft ACPI-Compliant System] - [PCI bus] - [Intel(R) ICH9 Family USB2 Enhanced Host Controller-293A].**

- 5** Right-click [USB Root Hub] under [Intel(R) ICH9 Family USB2 Enhanced Host Controller-293A] and then click [Properties].
- 6** Click [Power Management] and remove the check mark from [Allow the computer to turn off this device to save power].
- 7** Click [OK].
- 8** Restart the computer.

NOTE

- If a mini port replicator is connected, remove the check mark from this item. If the check mark is added, it may be impossible to use the USB ports (2a, 2b, 2c) on the mini port replicator. If this occurs, remove the check mark, then restart the computer.

Deactivate automatically the power saving function of the USB2.0 Root Hub

Install the “Selective Suspend Mode Changer Utility” with the following procedure. The power saving function will be deactivated with the USB2.0 Hub and activated without the Hub automatically.

- 1** Click [start] - [Run] and input [c:\util\selsusch\setup.exe] and then click [OK].
- 2** Click [Next].
- 3** Click [Yes, I want to restart my computer now] and then click [Finish].

Installation is completed when your computer restarts.

USB Floppy Disk Drive

Note the following when using an optional USB floppy disk drive. The performance is confirmed by Pana-sonic USB floppy disk drive (optional: CF-VFDU03U).

- Avoid the followings while the floppy disk drive is being accessed. Doing any of these may damage the data on the floppy disk and render it useless.
 - Power off your computer
 - Remove the floppy disk drive
 - Touch the floppy disk drive eject button
- Use care when handling floppy disks.

To protect the data on your floppy disks or to prevent a floppy disk from becoming stuck in your computer, avoid the following:

 - Manually sliding the shutter on the floppy disk

- Exposing the disk to a magnetic field
- Storing the disk in locations prone to high temperatures, low pitched noise, dampness, or dust
- Applying more than one label on the disk
- Confirm the contents of a floppy disk before formatting it.
Confirm that no important data is left on the floppy disk, because all data will be erased.
- Use the write-protect tab (A).
This is a must for preserving important data. This prevents your data from being erased or overwritten.
- The USB floppy disk drive cannot be used at the same time as other floppy disk drives.
- Do not directly open application files (e.g., Microsoft Word, Microsoft Excel) which are stored on the floppy disk.
First copy the files to the hard disk, then open the copied files from the hard disk.

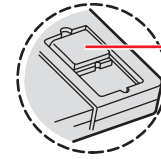

Write Enable

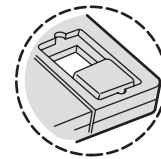

Write Disable

CAUTION

- Be sure to connect the telephone cable into the modem port, not into the LAN port.
- Use a surge protector since the modem may be damaged by a sudden high voltage surge that may occur in the event of a lightning strike.

- 1 Connect the computer and the telephone jack (A) using the telephone cable (included: B).**
 - Hold the cable so that the shape of the connector (C) matches the port, and insert fully until it clicks.
- 2 Click [start] - [Control Panel] - [Printers and Other Hardware] - [Phone and Modem Options] and change the settings as necessary.**

CF-F8 Series

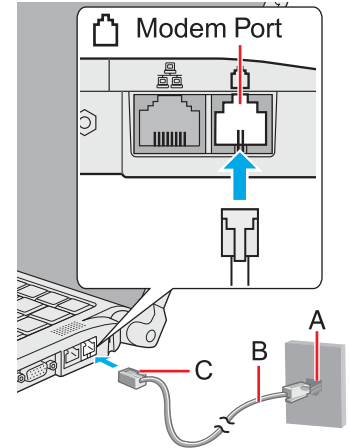

CF-W8/CF-T8 Series

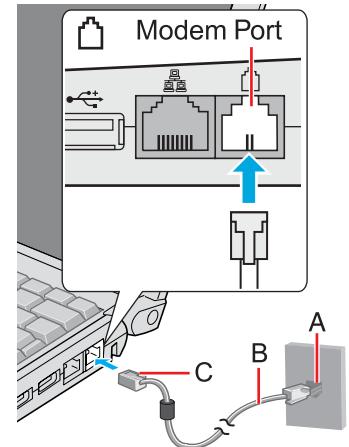

NOTE

- Do not enter standby or hibernation during communications.
- To remove the cable, press and hold the lever and pull out.

Ring Resume Function

The computer automatically resumes from standby when the telephone connected to the modem rings. You will need software to keep the computer in an idle state waiting for a phone call, and if you prefer, to turn the computer to standby again afterward. For further information, refer to the instruction manual of the software application.

- 1** Click [start] - [Printers and Faxes].
- 2** Click [Set up faxing] in the [Printer Tasks] area on the left.
 - This operation is not necessary next time.
- 3** Right-click the fax icon and then click [Properties].
- 4** Click [Devices] - [Properties].
- 5** Click [Receive], and then add the check mark for [Enable device to receive] and click [OK].
- 6** Click [Device Manager] in [start] - [Control Panel] - [Performance and Maintenance] - [System] - [Hardware].
- 7** Double-click [Modems], and then double-click the internal modem.
- 8** Click [Power Management], add the check mark for [Allow this device to bring the computer out of standby], then click [OK].

■ To set the time to return the computer to standby

The computer will enter standby after the set time even when the communication is not completed. You can avoid such uncompleted communication if you select [Never], but the computer does not return to standby after resuming by a phone call.

- ① Click [start] - [Control Panel] - [Performance and Maintenance] - [Power Options] - [Power Schemes].
- ② Set the expected communication time.

NOTE

- This function does not work when the computer is off or is in hibernation.
- Connect the AC adaptor.
- The screen remains dark after the computer resumes from standby. The previous screen display will be restored when you touch the keyboard, Touch Pad or touchscreen (only for CF-T8 Series).
- The computer cannot resume if the telephone is not connected to the internal modem (e.g., you cannot use a PC Card modem).
- The computer needs some time to respond, so set the calling time longer than normal. If this is not possible on the transmission side, reduce the number of rings before answering on the software that you are using to keep the computer in idle waiting for the call.

CAUTION

- To ensure proper network operations, use a twisted pair cable (category 5 or higher) less than 100 m in length.
- Do not use the standby or hibernation during communications (except when the Wake up from wired LAN function is in use), as this may cause an error in data transmission or reception. The timeout function may engage even during data transmissions, causing the computer to automatically go into standby or hibernation. When not using the Wake up from wired LAN function, we recommend disabling the timeout function using the following menu.
[start] - [Control Panel] - [Performance and Maintenance] - [Power Options] - [Power Schemes]

1 Turn off your computer.

- Do not use standby or hibernation.

2 Connect the cable.

Connect the LAN port (A) and the network system (server, HUB, etc.) using a LAN cable.

3 Turn on the computer.

CF-F8 Series

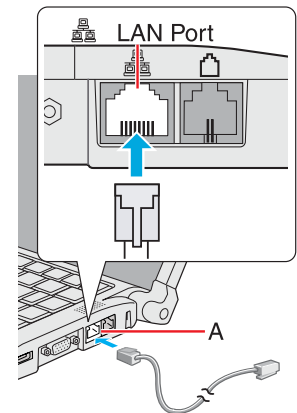

CF-W8/CF-T8 Series

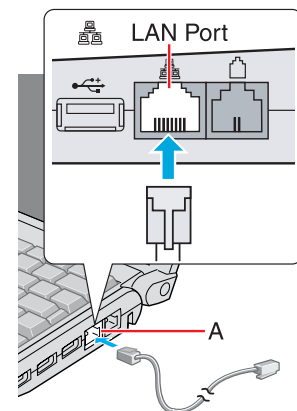

Power On by LAN/Wake Up from Wired LAN

NOTE

- Even when a password is set in the Setup Utility and [Password on boot] is set to [Enabled], entering the password is unnecessary for turning on or resuming the computer.
- Connect the AC adaptor.
- The Power On by LAN function is off under the following conditions:
 - When you turn the computer off by sliding the power switch for four seconds or longer (e.g., after a hung-up).
 - When you reattach the AC adaptor and battery pack to the computer after removing them.
- The screen remains dark after the computer resumes from standby. The previous screen display will be restored when you touch the keyboard, touch pad or touchscreen (only for CF-T8 Series).

Enabling the Power On by LAN function

The computer automatically turns from off to on when the computer is accessed from the network server via the internal LAN port.

- 1** Select [Allow] in [Power On by LAN] in the [Advanced] menu of the Setup Utility (→ [page 100](#)).
- 2** In [Caution], press **Enter**.
- 3** Press **F10**, and then select [Yes] and press **Enter**.
- 4** Log on to Windows as an administrator.
- 5** Click [start] - [Control Panel] - [Performance and Maintenance] - [System] - [Hardware] - [Device Manager], and double-click [Network adapters] and double-click [Intel(R) 82567LM Gigabit Network Connection], and then click [Advanced].
- 6** Click [Enable PME] in [Property] and select [Enabled] in [Value].
 - The computer may accidentally turn on if the linkage status is changed. To prevent the accidental startup, make the following setting.
Click [Wake on Settings] in [Property] and select [Wake on Magic Packet] in [Value].
- 7** Click [OK].

Enabling/Disabling the Wake Up from wired LAN function

When the Wake Up from wired LAN function is enabled, the computer automatically resumes from standby or hibernation when the computer is accessed from the network server via the internal LAN port. (Default setting)

The Wake Up from wired LAN function can be switched to enable/disable by performing the following procedure.

- 1** Click [start] - [Control Panel] - [Performance and Maintenance] - [System] - [Hardware] - [Device Manager] and double-click [Network adapters] and double-click [Intel(R) 82567LM Gigabit Network Connection], and then click [Power Management].
- 2** Add check marks for [Allow the computer to turn off this device to save power.] and [Allow this device to bring the computer out of standby].
We recommend you to make the above two settings ON/OFF simultaneously.
 - The computer may resume when another computer in the network makes unintentional access.
Using the following procedure, you can prevent accidental startup by unintentional access.
Add a check mark for [Only allow management stations to bring the computer out of standby].
- 3** Click [OK].

<Only for model with wireless LAN, Bluetooth, and/or wireless WAN>

There are four ways of disabling and enabling wireless communication.

- The Wireless Switch on the front of the computer (below)
- Wireless switch utility (below)
- Settings in the [Advanced] menu of the Setup Utility (→ [page 100](#))
- Settings in the Wireless Connection Disable Utility (→ [page 88](#))

The Wireless Switch

■ To disable all wireless communication

- 1 Switch to OFF.

■ To enable wireless communication

- 1 Switch to ON.
 - In the default setting, the wireless switch enables all wireless devices when it is set to ON.

CF-F8 Series

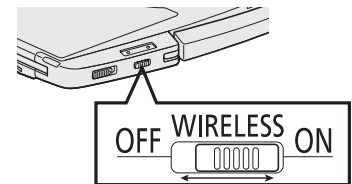

CF-W8/CF-T8 Series

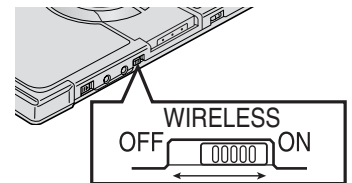



Wireless Switch Utility

This utility allows you to control the function of the wireless switch. This utility also allows you to enable or disable wireless devices from a pop-up menu in the notification area. In the default setting, all wireless devices are enabled.

■ The Wireless Switch Utility icon

The Wireless Switch Utility icon appears in the notification area when the computer is turned ON. It shows the status of wireless devices.

-  : Indicates that the wireless devices are enabled.
-  : Indicates that the wireless devices are off.

-  : Indicates that the wireless devices have been disabled in the Setup Utility.

■ To enable or disable particular wireless devices

- 1 Click the **Wireless Switch Utility** icon to show the pop-up menu.
- 2 Select **ON** or **OFF** for the device you want to enable or disable.

■ To change the function of the Wireless switch

In the default setting, the on/off settings that were selected for each device at the time you last turned off the wireless switch are restored when you set the wireless switch to ON again. You can change this function.

- 1 Click the **Wireless Switch Utility** icon on the notification area and click **[Settings]**.

- 2 Select the setting you want to assign to the wireless switch.

[Selects the device for which to turn the device status on each time with the dialog box.]

Display a dialog each time you set the Wireless switch to ON so you can choose which wireless device to enable.

[Turns on the following device.]

Only selected devices are enabled when you set the Wireless Switch to ON.

[Turns on the device that was on immediately before the wireless switch was turned off the last time.] (default)

When you turn on the wireless switch, the on/off settings that were selected when you last turned off the wireless switch will be restored.

- 3 Click **[OK]**.

■ To check the wireless communication status

- 1 Place the cursor over the Wireless Switch Utility icon ( or ) on the notification area.

NOTE

- Do not turn on/off the switch repeatedly at too short intervals.
- Do not restart, log off, or enter standby or hibernation immediately after turning on/off the switch.
- Do not turn on/off the switch while Windows is starting up.
- To use wireless communication, set the wireless devices ([Wireless LAN] / [Bluetooth] / [Wireless WAN]) to [Enabled] (default) in the [Advanced] menu of the Setup Utility.
- It may take some time to turn off wireless communication after switching the wireless switch off.
- If the IEEE802.11a setting is changed in [Device Manager], the display will be changed accordingly.

Wireless Connection Disable Utility

You can automatically disable the wireless LAN connection when a LAN cable is connected to your computer. You need to install the Wireless Connection Disable Utility to use this function.

Installing the utility

- 1 Log on to Windows as an administrator.
- 2 Click [start] - [Run] and input [c:\util\wdisable\setup.exe], and click [OK].
- 3 Follow the on-screen instructions to install the Wireless Connection Disable Utility.

Checking the status of the Wireless Connection

NOTE

- The Wireless Switch Utility should also be installed so that the Wireless Connection Disable Utility works.
- The utility does not automatically disable the Bluetooth connection.

■ Status indication

After installation, the Wireless Connection Disable Utility is automatically started after a user is logged in. An icon appears on the notification area.



: Indicates that

- the utility is enabled, and
- the wireless connection is disabled since a LAN cable is connected.



: Indicates that

- the utility is enabled, and
- the wireless connection is enabled since no LAN cable is connected.



: Indicates one of the following statuses;

- the utility does not monitor the LAN port status,
- the Wireless Switch Utility has not been started, or
- the built-in wired LAN device is not detected (in case of [LAN] is set [Disabled] in the Setup Utility) or disabled with the device manager.

■ Menu

Right-clicking the utility icon in the notification area opens a menu as follows.

- **Monitoring LAN Cable: ON**

Enables the Wireless Connection Disable Utility to monitor the LAN port and disable wireless connection when a LAN cable is connected.

- **Monitoring LAN Cable: OFF**

Disables the Wireless Connection Disable Utility, and enables wireless connection regardless of whether a LAN cable is connected or not.

- **Exit**

Exits the Wireless Connection Disable Utility and enables wireless connection.

<Only for model with wireless LAN>

CAUTION

- **To avoid unauthorized access to the computer through wireless LAN**

We recommend you to make security settings such as encryption before using wireless LAN. Otherwise the hard disk data such as the shared files can be exposed to the risk of unauthorized access.

NOTE

- Communication is established through the wireless LAN antenna (A). Do not block the antenna area with your hand or body.
- Do not use the Fast User Switching function. The wireless LAN cannot perform.
- The transmission rate will be lower when a microwave oven is used.
- If IEEE802.11a is enabled or disabled while the computer is connected to an IEEE802.11b/g access point, the connection will be temporarily interrupted.

CF-F8 Series

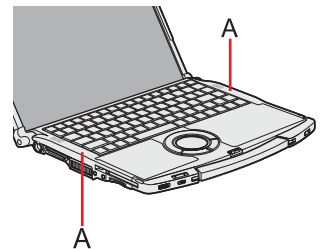

CF-W8/CF-T8 Series

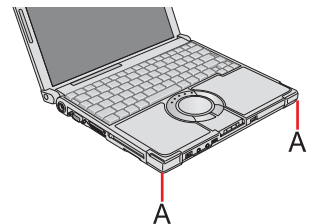

Using the Wireless LAN Function

Before using a wireless LAN, turn the wireless LAN communication on.

Turning on/off the wireless LAN communication

1 Slide the wireless switch to turn on/off wireless LAN. (→ page 86)

- When turning on wireless LAN
If you cannot turn on wireless LAN using the wireless switch, confirm the Wireless Switch Utility setting (→ page 86).



NOTE

- It may take some time to turn off wireless LAN after switching the wireless switch to off.

Setting the profiles

Preparation

Follow the instruction manual of the wireless LAN access point to make settings for the access point to recognize the computer.

- 1 Slide the wireless switch to the right to turn on the wireless LAN.**
- 2 Double-click  /  /  on the notification area.**
The [Intel® PROSet/Wireless] screen appears.
- 3 Click [Profiles] and click [Add].**
- 4 Enter the profile name and wireless network name (SSID), and make other necessary changes, then click [Next].**
- 5 Make necessary settings and click [OK].**
- 6 Select the profile you set and click [Connect].**
- 7 Click [Close].**



NOTE

- You need to set the profile for each user.
- The settings depend on the network environment. For further information, ask the system administrator or the person in charge of the network.
- For further information of Intel® PROSet/Wireless software, refer to [Help] in the menu bar.

Setting the Wireless LAN Standard IEEE802.11a (802.11a)

- 1 Click  or  on the notification area.
- 2 Click [802.11a Disabled] or [802.11a Enabled].

NOTE

- In some countries, communication using IEEE802.11a (5 GHz wireless LAN) standard is restricted by law.
- The Wireless Switch Utility icon ( or ) indicates the on/off status of wireless LAN and/or Bluetooth and/or wireless WAN, not the setting of IEEE802.11a.
- If IEEE802.11a is enabled or disabled while the computer is connected to an IEEE802.11b/g access point, the connection will be temporarily interrupted.
- You can also change the IEEE802.11a setting in [Device Manager].
 - ① Click [start] - [Control Panel] - [Performance and Maintenance] - [System] - [Hardware] - [Device Manager].
 - ② Click [Network adapters] and double-click [Intel(R) WiFi Link xxxx].
 - ③ Click [Advanced], and then click [Wireless Mode] in [Property].
 - ④ Remove the check mark from [Use default value] in [Value], and select the settings (e.g., [802.11a/g]).
 - ⑤ Click [OK].

If you turn on/off 802.11a using the popup menu of Wireless Switch Utility, the setting in [Device Manager] will be accordingly changed as below.

Settings in Device Manager	Settings in Wireless Switch Utility	
	When 802.11a is enabled	When 802.11a is disabled
[802.11a, 802.11b and 802.11g] [802.11a and 802.11g]	a+b+g is enabled	b+g is enabled
[802.11g only] [802.11a and 802.11g]	a+g is enabled	g is enabled
[802.11a only] [802.11b only]	a is enabled	b is enabled

Wake Up from Wireless LAN

NOTE

- Even when a password is set in the Setup Utility and [Password on boot] is set to [Enabled], entering the password is unnecessary for turning on or resuming the computer.
- Connect the AC adaptor.
- The Power On by LAN function is off under the following conditions:
 - When you turn the computer off by sliding the power switch for four seconds or longer (e.g., after a hung-up).
 - When you reattach the AC adaptor and battery pack to the computer after removing them.
- The screen remains dark after the computer resumes from standby. The previous screen display will be restored when you touch the keyboard, touch pad or touchscreen (only for CF-T8 Series).

Enabling the Wake Up from Wireless LAN function

The computer automatically resumes from standby or hibernation when the computer is accessed from the network server via the wireless LAN.

- 1** Click [start] - [Control Panel] - [Performance and Maintenance] - [System] - [Hardware] - [Device Manager] and double-click [Network adapters], and double-click [Intel(R) WiFi Link xxxx], and then click [Power Management].
- 2** Add check marks for [Allow the computer to turn off this device to save power.] and [Allow this device to bring the computer out of standby.], and click [OK].

CAUTION

- Even if the Wake Up from wireless LAN function is enabled, it will be disabled once the communication stops for even a moment (for example, when there is heavy signal traffic or the computer is taken out of the communication range of the access point).
The Wake Up from wireless LAN function will also be disabled if the wireless switch (→ [page 86](#)) at the ON position is set to OFF.





NOTE

- The computer may resume when another computer in the network makes unintentional access. Using the following procedure, you can prevent accidental startup by unintentional access.
 - ① Click [start] - [Control Panel] - [Performance and Maintenance] - [System] - [Hardware] - [Device Manager] and double-click [Network adapters], and double-click [Intel(R) WiFi Link xxxx], and then click [Power Management].
 - ② Add a check mark for [Only allow management stations to bring the computer out of standby], and click [OK].
- If the wireless switch is set to ON, and the Wake Up from wireless LAN function is enabled, the computer consumes electricity, even in the standby/hibernation mode.
- The Wake Up from wireless LAN function does not work when network connection is established in ad hoc mode.

To check the wireless LAN network status

- ① Place the cursor over the Wireless Switch Utility icon ( or ) on the notification area. A tooltip appears.

NOTE

- The Wireless Switch Utility icons ( and ) indicate the on/off status of wireless communication, not the IEEE802.11a setting.
- If the IEEE802.11a setting is changed in [Device Manager], the display will be changed accordingly.
- Perform either of the following procedures to check the status in Intel® PROSet/Wireless Software.
 - Double-click  ,  or  on the notification area.
 - Click [start] - [All Programs] - [Intel PROSet Wireless] - [WiFi Connection Utility].

Exchanging Data between Computers Using the Wireless LAN

To communicate between two computers using the wireless LAN and without using an access point, make the following settings on each computer.

- Set the network to be accessed as [Device to Device (ad hoc)].
- Set the network names to the same name.
- Set the network authentication to the same authentication.
- When using encryption, set the same encryption and the same network key on both computers.

<Only for model with Bluetooth>

NOTE

- Communication is established through the Bluetooth antenna (A). Do not block the antenna area with your hand.
- When Bluetooth is installed, [Bluetooth] is displayed in the [Advanced] menu of Setup Utility. To use Bluetooth, set [Bluetooth] to [Enabled] (default) in the [Advanced] menu of the Setup Utility.
- The transmission rate will be lower when a microwave oven is used nearby.
- It may take some time to turn off Bluetooth after switching the wireless switch to off.
- When you uninstall the Bluetooth driver, turn Bluetooth off.

CF-F8 Series

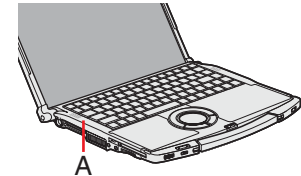

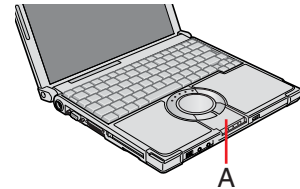

CF-W8/CF-T8 Series



Using the Bluetooth Function

Before using Bluetooth, turn the Bluetooth communication on.

1 Slide the wireless switch to turn on/off Bluetooth.

- The Wireless Switch Utility icon appears in the notification area when the computer is turned ON. It shows the status of Bluetooth.
 -  : Indicates that Bluetooth is on.
 -  : Indicates that Bluetooth is off.
 -  : Indicates that Bluetooth has been disabled in the Setup Utility.
- When you also use other wireless functions, refer to “Disabling/Enabling Wireless Communication” (→ [page 86](#)) .

CF-F8 Series

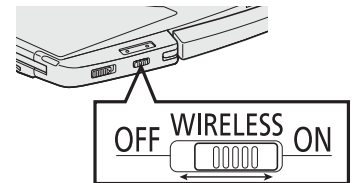

CF-W8/CF-T8 Series

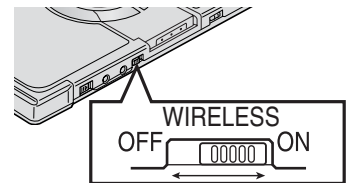

■ To check the Bluetooth communication status

- ① Place the cursor over the Wireless Switch Utility icon on the notification area.
A tooltip appears.

■ To access the online manual

- ① Click [start] - [All Programs] - [Bluetooth] - [User's Guide].

■ Fast User Switching Function

When switching to a different user with the Fast User Switching function, Bluetooth may not be used. In this case, log off all users without using Fast User Switching function and perform the operation once more. If the problem persists, restart the computer.

NOTE

- To turn on/off particular wireless devices
 - ① Click the Wireless Switch Utility icon to show the pop-up menu.
 - ② Select On or Off for the device you want to turn on/off.
- The Wireless Connection Disable Utility does not automatically disable the Bluetooth connection.

You can make the settings of the computer's operating environment (password settings, startup drive selection, etc.)

Starting the Setup Utility

- 1 Turn on or restart the computer.
- 2 Press **F2** or **Del** while [Panasonic] boot screen is displayed soon after the computer starts the startup procedure.

When [Enter Password] is displayed, enter your password.

When you start the Setup Utility with Supervisor Password

- You can make the settings of all items of the Setup Utility.

When you start the Setup Utility with User Password

- Note the following:
 - In the [Advanced] and [Boot] menus, you cannot make the settings of all items.
 - In the [Security] menu, you can change only the User Password when [User Password Protection] is set to [No Protection]. You cannot delete the User Password.
 - In the [Exit] menu, you cannot make the setting of [Load Default Values] and [Boot Override].
 - **F9** (Setup Defaults) does not function.

Information Menu

Underlined items are the factory presets.

Language	<u>English</u> Japanese
----------	----------------------------

Product Information

Model No. Serial No.	Computer information (cannot be changed.)
-------------------------	--

System Information

Processor Type Processor Speed Memory Size Available Memory Hard Disk	Computer information (cannot be changed.)
---	--

BIOS Information

BIOS Embedded Controller Accumulative Operating Time Access Level	Computer information (cannot be changed.)
--	--

Main Menu

Underlined items are the factory presets.

System Date <ul style="list-style-type: none"> Day of the <u>Week</u>/Month/Day/Year. You can use <u>Tab</u> to move the cursor. 	[xxx xx/xx/xxxx]
System Time <ul style="list-style-type: none"> 24-hr. style. You can use <u>Tab</u> to move the cursor. 	[xx:xx:xx]

Main Configuration

Touch Pad	Disabled <u>Enabled</u>
Touchscreen Mode <ul style="list-style-type: none"> Only for CF-T8 Series 	Touchscreen Mode Tablet Mode <u>Auto</u>
Current Status <ul style="list-style-type: none"> Only when [Touchscreen Mode] is set to [Auto]. 	Depending on the touch-screen mode setting, either "Touchscreen Mode" or "Tablet Mode" is displayed.
Fn/Ctrl Key <ul style="list-style-type: none"> Select whether to switch <u>Fn</u> with <u>Ctrl</u> functions, and vice versa on the internal keyboard. Do not attempt to replace the markings on the keys, or the keys themselves. 	Normal Replace
Display <ul style="list-style-type: none"> The display during the Windows start-up process. When an external display is not connected, the information appears on the internal LCD even though [External Monitor] is set. 	<u>External Monitor</u> Internal LCD
Optical Drive Power <ul style="list-style-type: none"> Only for CF-F8/CF-W8 Series You can set the drive power to [On] or [Off] when the computer is started up. When set to [Off]. <ul style="list-style-type: none"> From the next time you start the computer, you will be unable to start up from CD/DVD drive. The disc cover cannot be opened until Windows has started. To start up from the CD/DVD drive, set this to [On]. If operations are resumed from hibernation while a disc is set, it may take about 20 seconds for operations to resume. 	Off <u>On</u>
Battery Charging Indicator	On Continuous <u>Flashing</u>

LED Brightness <ul style="list-style-type: none"> You can set the brightness of the power indicator. ([Auto]: The brightness varies according to brightness of the internal LCD. [Dimmer]: The brightness remains dark and does not vary.) 	<u>Auto</u> Dimmer
--	-----------------------

Advanced Menu

CPU Configuration

Underlined items are the factory presets.

Execute-Disable Bit Capability <ul style="list-style-type: none"> [Enabled] indicates that this computer supports hardware-based Data Execution Prevention (DEP). 	Disabled <u>Enabled</u>
Core Multi-Processing	Disabled <u>Enabled</u>
Intel(R) Virtualization Technology	Disabled <u>Enabled</u>
Intel(R) Trusted Execution Technology	Disabled <u>Enabled</u>

Peripheral Configuration

Optical Drive <ul style="list-style-type: none"> Only for CF-F8/CF-W8 Series 	Disabled <u>Enabled</u>
LAN	Disabled <u>Enabled</u>
Power On by LAN <ul style="list-style-type: none"> Can be changed only when [LAN] is set to [Enabled]. To use [Power On by LAN], make additional settings in [Device Manager] (→ page 84) 	<u>Deny</u> Allow
Wireless LAN <ul style="list-style-type: none"> Only for model with wireless LAN 	Disabled <u>Enabled</u>
Wireless WAN <ul style="list-style-type: none"> Only for model with wireless WAN 	Disabled <u>Enabled</u>
Bluetooth <ul style="list-style-type: none"> Only for model with Bluetooth 	Disabled <u>Enabled</u>
Modem	Disabled <u>Enabled</u>
PC Card Slot	Disabled <u>Enabled</u>
SD Slot	Disabled <u>Enabled</u>

USB Port	Disabled <u>Enabled</u>
Legacy USB Support <ul style="list-style-type: none"> CF-F8/CF-W8 Series Select whether to use the function that makes the computer recognize, USB keyboard and USB floppy disk drive ([Enabled]) or not ([Disabled]) before starting Windows. CF-T8 Series Select whether to use the function that makes the computer recognize USB keyboard, USB floppy disk drive and USB CD/DVD drive ([Enabled]) or not ([Disabled]) before starting Windows. 	Disabled <u>Enabled</u>

Boot Menu

Boot Option Priorities

<CF-F8/CF-W8 Series>

<Default order>

Boot Option #1	USB Floppy Disk* ¹
Boot Option #2	Hard Disk
Boot Option #3	CD/DVD Drive
Boot Option #4	LAN
Boot Option #5	USB Hard Disk
Boot Option #6	USB CD/DVD Drive

<CF-T8 Series>

<Default order>

Boot Option #1	USB Floppy Disk* ¹
Boot Option #2	Hard Disk
Boot Option #3	USB CD/DVD Drive
Boot Option #4	LAN
Boot Option #5	USB Hard Disk

■ To change the boot order

- Press **Enter** on the boot device you want to change and select the boot device from the following menu.
 - When a selected boot device in the following menu already exists in either of the [Boot Option (#1 to #6)] (for CF-F8/CF-W8 Series) or [Boot Option (#1 to #5)] (for CF-T8 Series), the boot device appears at the newly selected position by switching the positions with the original boot device that existed before at the position.
 - When you select [Disabled] in the following menu, the disabled [Boot Option] is ignored and the boot device in the next [Boot Option] operates.

Hard Disk
CD/DVD Drive <Only for CF-F8/CF-W8 Series>
LAN
USB Floppy Disk* ¹
USB Hard Disk
USB CD/DVD Drive
Disabled

*¹ The performance is confirmed by Panasonic USB floppy disk drive (optional: CF-VFDU03U) when the computer boots from the USB Floppy Disk.

Security Menu

Boot Prompt Configuration

Underlined items are the factory presets.

<p>Setup Utility Prompt</p> <ul style="list-style-type: none"> When [Setup Utility Prompt] is set to [Disabled], the message “Press F2 for Setup / F12 for LAN” is not displayed on [Panasonic] boot screen. However, F2 and F12 will work even if the message is not displayed. 	<p>Disabled <u>Enabled</u></p>
<p>Password on boot</p>	<p>Disabled <u>Enabled</u></p>
<p>Set Supervisor Password</p>	<p>Enter the sub-menu.</p>
<p>Hard Disk Lock</p> <ul style="list-style-type: none"> Can be changed only when [Set Supervisor Password] is set. 	<p><u>Disabled</u> Enabled</p>
<p>User Password Protection</p>	<p><u>No Protection</u> Protected</p>
<p>Set User Password</p> <ul style="list-style-type: none"> Can be changed only when [Set Supervisor Password] is set. 	<p>Enter the sub-menu.</p>
<p>▶ Embedded Security (TPM)</p> <ul style="list-style-type: none"> Only for model that supports TPM For information on TPM, refer to the <i>Installation Manual</i> of “Trusted Platform Module (TPM)”. Click [start], input “c:\util\drivers\tpm\readme.pdf” in [Start Search], and press <u>Enter</u>. 	<p>Enter the sub-menu.</p>
<p>▶ Fingerprint Security</p> <ul style="list-style-type: none"> Only for model with Fingerprint Reader 	<p>Enter the sub-menu.</p>
<p>▶ AMT Configuration</p> <ul style="list-style-type: none"> Only for model that supports AMT 	<p>Enter the sub-menu.</p>

Exit Menu

Save Values and Reboot	To reboot the system after saving the changes.
Reboot Without Saving Changes	To reboot the system without saving the changes.

Save Options

Save Current Values	To save the changes for all Setup options.
Load Previous Values	To load previous values for all Setup options.
Load Default Values	To return the settings to the default values.

Boot Override

(Device Information)	To select a boot device which operates only in the next booting.
----------------------	--

▶ Diagnostic Utility	To start Diagnostic Utility.
----------------------	------------------------------

You can enlarge the screen items such as characters, icons, title bars and cursor.

CAUTION

- “Icon Enlarger” will not start up if the display resolution is set lower than 1024 x 768 dots.

NOTE

- A part of the enlarged menu or some screen items may be hidden. In this case, overlay the cursor to display pop-ups, scroll the screen, or use other functions to display the hidden items.
- The Icon Enlarger setting affects the website characters displayed by Internet Explorer and the e-mail characters in Outlook Express. Some characters of website and e-mail may not be enlarged.

Preparation

Close all of the applications before using “Icon Enlarger”.

- 1** Click [start] - [All Programs] - [Panasonic] - [Icon Enlarger].
- 2** Select the size.
- 3** Click [OK].

The screen will be displayed in the selected size.

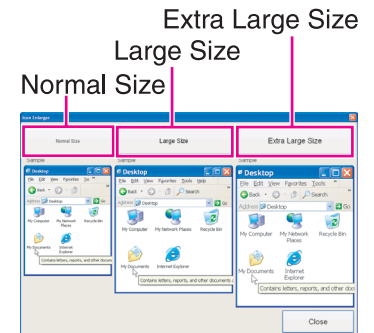



You can magnify the specific part of the screen.

Activating the Loupe Utility

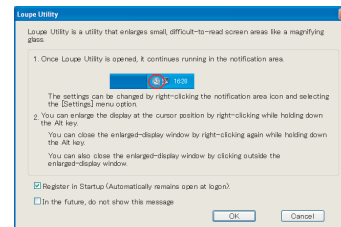
- 1 Click [start] - [All Programs] - [Panasonic] - [Loupe Utility].
- 2 Click [OK].
 -  appears on the notification area.



Using the Loupe Utility

- 1 Point the cursor  at the part of the screen you want to magnify.
- 2 Press and hold **Alt**, and right-click.
 - The part pointed by the cursor is magnified.
 - Alternatively you can double-click , or right-click  and click [Show Loupe].
- 3 Drag the loupe window (A) to move the magnified part.
 - To hide the loupe window, click the Hide button (B).
 - Alternatively you can click any part out of the loupe window, or press and hold **Alt** and right-click.
 - To change the loupe window size, drag the bottom-right corner (C).
The size range you can enlarge/shrink depends on the screen's resolution.

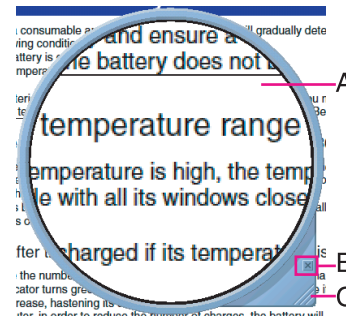

NOTE

- If you execute the scroll operation while the loupe window is displayed, the window directly below the loupe window will scroll vertically. The loupe window will not be displayed during vertical scrolling. When vertical scrolling stops, the loupe window will be displayed in the same position where it appeared before scrolling began.
- Not compatible with the horizontal scroll function in the Touch Pad utility. (→ page 5)

- The magnified text or image in the loupe window is fixed at the moment that the part is magnified (e.g., at the moment you press and hold **Alt** and right-click). To reflect the change you made on the original screen to the loupe window, click the loupe window.
- The Loupe Utility does not work with some applications.

Setting the Loupe Utility

1 Right-click  on the notification area.



2 Click [Settings].

[Show/hide shortcuts assignment]

- When using the external mouse/Touch Pad
 - ① Click [Mouse/Touch pad]
 - ② Click a combination of **Ctrl**, **Alt**, and **Shift**, and add the check mark. (Multiple keys can be combined; for example, **Ctrl + Alt**)
 - ③ Select either [Right click] or [Left click] to use in combination with the key(s) selected in step ② above.
- When using the keyboard
 - ① Click [Keyboard].
 - ② Click the text box and then press the key used for the shortcut. (e.g., **Alt + Z**, **Ctrl + Alt + Z**, etc.)

[Window shape]

Select the shape of the loupe window.

[Autorun]

Add a check mark to run the Loupe Utility when Windows starts up.

3 Click [OK].

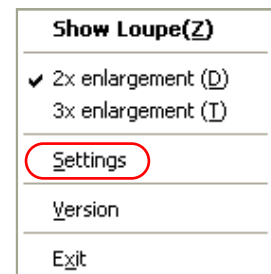

Problems with Starting Up, Shutting Down and Standby and Hibernation

To log on with an Administrator user account

- If you create a user account after Windows setup, the Administrator account used during Windows setup does not appear on the log on screen.
To log on with the Administrator account, in the log on screen, press **Ctrl + Alt + Del** twice, enter “Administrator” in [User name], and enter the password if one is set, then click [OK].

Cannot boot from a floppy disk

- Depending on the floppy disk you are using, the computer may not boot properly. The performance is confirmed by Panasonic USB floppy disk drive (optional: CF-VFDU03U) when the computer boots from the floppy disk.
- Check that the boot disk is correctly inserted.
- Run the Setup Utility, and confirm the following settings.
 - [USB Port] and [Legacy USB Support] are set to [Enable] in the [Advanced] menu. (→ [page 101](#))
 - [USB Floppy Disk] is the first device shown in [Boot Option #1] in the [Boot] menu. (→ [page 101](#))
- Turn off the computer, and reconnect the external floppy disk drive.

Windows startup is slow

- This problem may be eliminated by adding external memory.*1
- If you install resident software after purchasing this computer, disable the resident software.
- Defragment the disk with the Disk Defragmenter.
Disk Defragmenter may take some time. (The time required will depend on the disk capacity.)
 - About the defragmentation
When files have been repeatedly written or rewritten to the hard disk, some files may become segmented and saved in fragments. If this fragmentation continues, it may take some time to read from or write to the hard disk. The Disk Defragmenter is a function that sorts these fragmented files in the most efficient order and enables you to read from and write to the hard disk quickly.
 - How to defragment disks:
 - ① Click [start] - [All Programs] - [Accessories] - [System Tools] - [Disk Defragmenter].
 - ② Click the drive (volume) you want to defragment and click [Analyze].
 - ③ Click [Defragment] on the [Disk Defragmenter] screen.
Defragmentation begins. Wait for a moment.
 - ④ When “Defragmentation is complete...” is displayed, click [Close].

*1 The processing speed depends on the application software used, so this operation may not cause the processing speed to increase.

The computer does not enter standby or hibernation

- If a peripheral is connected, first remove the peripheral, and then enter the standby or hibernation. If the computer still fails to enter standby or hibernation, restart the computer.
- It may take a minute or two to enter standby or hibernation. Wait for a moment.
- The computer may not enter standby properly and seems to be frozen in the mode that the computer is communicating via the modem. When you cannot execute operations, slide the power switch for four seconds or more to forcibly turn your computer off.
- When the display is closed, the computer may not enter system standby or system hibernation.*²
In order to activate standby or hibernation, set [Touch Pad] to [Disabled] in the [Main] menu of the Setup Utility.
(→ [page 99](#))

*² Functions that cause the computer to automatically enter standby or hibernation after a certain time interval has passed.

The computer does not power off (Windows does not shut down)

- If a peripheral is connected, disconnect it, and then shut down.
If it is possible to shut down when the peripheral is disconnected, then there may be a problem with the peripheral. Consult the peripheral manufacturer.
- Also check the items in “No response”. (→ [page 114](#))
- If it is no longer possible to shut down Windows after installing application software, click [start] - [Control Panel] - [Add or Remove Programs], and remove the installed application.
If it is possible to shut down when the application is removed, then consult the application software manufacturer.
- Check a disk error using the following procedure:
 - ① Remove all peripheral devices (including an external display).
 - ② Click [start] - [My Computer], right-click [Local Disk(C:)] and click [Properties].
 - ③ Click [Tools] - [Check Now].
 - ④ In [Check disk options], add the check mark for [Automatically fix file system errors] and [Scan for and attempt recovery of bad sectors], and click [Start].
The time taken to check the disk depends on the settings in [Check disk options].

If the disk check does not solve the problem, perform the reinstallation procedure and return the hard disk to its condition in the default setting. (⇒ *Supplementary Instructions for Windows XP*)

The computer does not resume

- If you slide and hold the power switch for four seconds or longer, the power will be turned off forcibly and the computer will not resume. In this case, all unsaved data will be lost.
- You disconnected the AC adaptor and the battery pack while the computer was in standby mode. If the computer's power supply is disconnected in standby mode, unsaved data will be lost and the computer will not resume.
- The battery is exhausted. Standby and hibernation consume some power.

When resuming from the standby or hibernation, [Enter Password] does not appear





- Even when a password has been set in the [Security] menu of the Setup Utility, and [Password on boot] is set to [Enabled], [Enter Password] does not appear when the computer resumes from the standby or hibernation.
Set the Windows password with the following procedure, and make input of the Windows password required.
 - ① Click the account to change in [start] - [Control Panel] - [User Accounts] and set the password.
 - ② Add the check mark for [Prompt for password when computer resumes from standby] in [Control Panel] - [Performance and Maintenance] - [Power Options] - [Advanced].

The date and time are incorrect

- Click [start] - [Control Panel] - [Date, Time, Language, and Regional Options] - [Date and Time], and correct the date and time.
- If you continue to experience problems, the internal battery maintaining the clock may need to be replaced. Contact your technical support office.
- When the computer is connected to a LAN, confirm the date and time of the server.
- This computer will not correctly recognize the date and time starting from the year 2100 A.D.

<Only for CF-T8 Series>

When you logged on Windows, an Internet Explorer script error message is displayed

- Click  to close the displayed window. Close all other windows displayed after that by clicking on . This phenomenon occurs during logon when  is touched with the stylus.
- During the logon process, try not to touch  with the stylus.

Problems with Passwords and Messages

When the administrator password is forgotten

- Check whether you have created a password reset disk.
 - If you have:
A message is displayed when you fail to correctly enter the password. Follow the message's instructions and set the password again.
 - If you have not:
Perform the reinstallation procedure and return the hard disk to its condition in the default setting. (⇒ *Supplementary Instructions for Windows XP*), then set up Windows and reset the password.



Problems with Operation during Use

Windows operation is slow

- Also check the items in "Windows startup is slow". (→ [page 108](#))

Cannot scroll with the Touch Pad

- Click [start] - [All Programs] - [Panasonic] - [Touch Pad utility] to start up the Touch Pad utility.
- Click [start] - [All Programs] - [Panasonic] - [Touch Pad utility settings] - [General settings], and check that the check mark is added for [Activate Touch Pad function].
- If horizontal scrolling is not possible, in the above sequence, check that the check mark is added for [Activate horizontal scroll function] in [General settings].
- If a message appears indicating that "Flat Pad communication failed, so cannot start up Touch Pad utility," check the following, and make the appropriate settings.
 - If an external mouse is connected:
External mouse applications and drivers cannot be used at the same time as the Touch Pad utility. Use either the Touch Pad or an external mouse.

When using an external mouse	When using the Touch Pad
<ul style="list-style-type: none">● Uninstall the Touch Pad utility using the following procedures.<ol style="list-style-type: none">① Click  /  on the notification area, and click [Exit].② Click [start] - [Control Panel] - [Add or Remove Programs].③ Click [Touch Pad Utility], and click [Remove] to remove the program.	<ul style="list-style-type: none">● Uninstall the external mouse application and driver. (→ page 76)● Check to ensure that [Touch Pad] is set to [Enabled] in the [Main] menu of the Setup Utility.● Use the following procedures to confirm that the Touch Pad driver has been installed.<ol style="list-style-type: none">① Click [start] - [Control Panel] - [Performance and Maintenance] - [System] - [Hardware] - [Device Manager].② Double-click [Mice and other pointing devices]. Confirm that [Synaptics PS/2 Port TouchPad] is in this list.● Disconnect the external mouse and restart your computer.

- If the error message continues to appear even after confirming the above items, or if there is no external mouse connected:
 - ① If an application with a high CPU usage rate is running, exit this application, and click [start] - [All Programs] - [Panasonic] - [Touch Pad Utility].
 - ② Uninstall and then reinstall the Synaptics TouchPad driver and Touch Pad utility. (→ [page 76](#))
- If [Touch Pad utility settings] does not appear when you click [start] - [All Programs] - [Panasonic], click [start] - [Control Panel] - [Add or Remove Programs], and check that [Touch Pad Utility] appears.
 - If it does not appear:

It is necessary to install the Touch Pad utility.
Click [start] - [Run] and input “c:\util\wheelpad\setup.exe”, then click [OK].
Follow the on-screen instructions for the installation.
 - If it does appear:

Click [Touch Pad Utility], and click [Remove] to remove the program. Then follow the procedure under “If it does not appear” above to reinstall.
- If an application has a screen in which only one of horizontal and vertical scrolling is possible, then regardless of the Touch Pad operation, scrolling only occurs in the permitted direction. (For example, in a screen permitting only horizontal scrolling, a vertical scroll operation results in horizontal scrolling.)

Some applications may not work properly

- When switching to a different user with the Fast User Switching function, the following problems may occur:

- Some applications may not work properly.
- Key combination with the **Fn** may not work.
- It may not be possible to set the settings of the display.
- Personal Secure Drive function of Security Platform (TPM) may not work (only for models that supports TPM).
- The wireless LAN cannot be used. (only for models with wireless LAN)

In this case, log off all users without using Fast User Switching function, and try the operation once more. If the problem persists, restart the computer.

- Some software applications installed after the time of purchase are not compatible with Windows XP Service Pack 2 or Windows XP Tablet PC Edition 2005. Refer to application software manufacturer homepage or other sources.

No response

- Is there an input screen (e.g., password input screen at startup) hidden behind another window? Use the **Alt+Tab** to check for other windows being displayed.
- Press the **Ctrl+Shift+Esc** to open Task Manager and close the software application which is not responding.
- After sliding the power switch for at least four seconds to turn off the computer, turn on again.
If Windows runs correctly, but the application software does not start, click [start] - [Control Panel] - [Add or Remove Programs] and remove the failing application software, then reinstall the application software.

Cannot play movies with the Windows® Media Player

- When you try to play a movie, is [Codec required] displayed?
Some video files use a Codec that is not installed as a standard. In these instances, if you play back the video file after connecting to the Internet, the Codec may be downloaded automatically, allowing you to play back the file.

[Files Needed] is displayed

- When you add-on Windows components, etc, the screen shown on the right will be displayed. Input "c:\windows\i386", then click [OK].

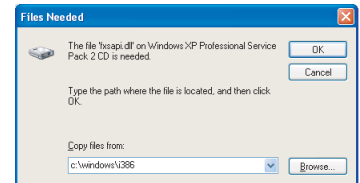

Problems with Battery

The battery indicator lights red

- The remaining battery power is very low (the charge is approx. 9% or less). Connect the AC adaptor. You can use the computer when the battery indicator light is orange. If you do not have an AC adaptor, save your data and power off your computer. After replacing the battery pack with a fully charged one, turn your computer on again.

The battery indicator is blinking

- If blinking red:
Quickly save your data and power off your computer. Remove the battery pack and disconnect the AC adaptor, then connect them again. If the problem persists, contact your technical support office. The battery pack or charging circuit may be defective.
- If blinking orange:
 - Battery cannot be recharged temporarily because the internal temperature of the battery pack is outside the acceptable temperature range for recharging. Your computer can be used normally in this state. Once the range requirement is satisfied, charging begins automatically.
 - Software applications and peripheral devices (USB devices, etc.) are consuming too much power. Exit the software applications currently running, and remove all peripherals. Once the range requirement is satisfied, charging begins automatically.

The battery indicator is flashing

- The battery is recharging.
If [Battery Charging Indicator] in [Main] menu of the Setup Utility is set to [Flashing], the indicator will alternately become lighter and darker.

To increase the lifetime of the battery

- You can prevent deterioration of the battery pack and extend the lifetime of the battery by setting Economy Mode (ECO) to “Enabled” in the Economy Mode (ECO) setting utility. (→ [page 30](#))
However, when Economy Mode (ECO) is set to “Enable”, the battery pack stops charging at 80% of fully charged, so the battery operation time is shorter.
To enable/disable the Economy Mode (ECO), refer to “Switching the Economy Mode (ECO)”. (→ [page 31](#))

Problems with Cursor

The cursor cannot be controlled properly

- Sensitivity when touching the Touch Pad can be adjusted. (→ [page 11](#))
 - Make sure [Touch Pad] is set to [Enabled] on the [Main] menu of the Setup Utility. (→ [page 99](#))
 - With the following procedure, check that no external mouse driver is installed. If it is installed, it may not possible to use the Touch Pad.
 - ① Click [start] - [Control Panel] - [Performance and Maintenance] - [System] - [Hardware] - [Device Manager].
 - ② Double-click [Mice and other pointing devices].
If a name other than [Synaptics PS/2...] is displayed, then an external mouse driver is installed. Delete it, then restart the computer.
 - Restart the computer by using the keyboard.
Press **Windows**, **U**, and select [Restart] with **→ ← ↑ ↓**, then press **Enter**.
If the computer does not respond to keyboard commands, read “No response”. (→ [page 114](#))
- <Only for CF-T8 Series with Windows XP Tablet PC Edition>
- Click [start] - [Control Panel] - [Add or Remove Programs], and check that [FCL USB Pen Tablet] is displayed.
 - If it is not displayed:
It is necessary to install the touchscreen driver.
Click [start] - [Run], and input “c:\util\drivers\tscreen\TPSetup.exe”, then click [OK].
Follow the on-screen instructions to complete installation.

The cursor moves randomly

- Adjust the touch sensitivity.
To adjust the sensitivity, refer to “Adjusting the Sensitivity when Touching the Touch Pad” (→ [page 11](#)).
- Check that no external mouse driver is installed. (Refer to steps ① and ② under “The cursor cannot be controlled properly” above.)
- <Only for CF-T8 Series>
Do not press the area around the display. The cursor may move to the edges of the screen.

The cursor cannot be moved with a connected mouse

- Check that the mouse is correctly connected.
- Install the driver for the connected mouse.
If the external mouse driver is installed, the Touch Pad may not be used. Refer to “When Using an External Mouse” (→ [page 76](#)).
For details of the mouse driver, consult the mouse manufacturer.
(In some cases, later versions may be available.)
If operation is not correct even after installing the driver, set [Touch Pad] to [Disabled] in the [Main] menu of the Setup Utility.
(→ [page 99](#))

Problems with Display

Screen is too dark or becomes darker

- Press **Fn+F2**. This makes the screen lighter.
- If the screen becomes darker after disconnecting the AC adaptor:
The computer has different set brightness levels for when the AC adaptor is connected and for when it is not connected. Based on the settings in the default setting, the screen will become darker when the AC adaptor is removed. If you press **Fn+F2** to increase the brightness when the AC adaptor is not connected, this brightness is maintained, and determines the brightness next time the AC adaptor is disconnected.
(Making the display brighter shortens the battery operating time.)

There are red, green, or blue dots on the screen, or display defects (always-on pixels or always-off pixels)

- This is not a malfunction.
High-precision and advanced technologies are necessary for the production of color liquid crystal displays (color LCDs). Therefore, if 0.002% or less of the picture elements either fail to light or remain constantly lit (that is, more than 99.998% of elements are functioning properly), this is not considered a defect.

Nothing is displayed on the screen

- Check if the power-saving mode is active.
 - If the power indicator is lit:
The display is turned off. Press a key with no independent effect, such as **Ctrl** or **Shift**.
Do not use a key that may make a selection (**Enter**, **Space**, **Esc**, **Y**, **N**, numeric keys, and so on).

- If the power indicator is blinking or is not lit:
The standby or hibernation is entered. Slide the power switch.
- Disconnect the external display before checking a disk error (→ [page 109](#)) or before using commercially available partitioning software. If you run this software with the external display still connected, in some cases, nothing will be displayed on the screen. If this occurs, wait until the process is complete and the screen display returns.
- The display destination may be set to the external display.
Try changing the display destination by pressing **Fn+F3**.
If you want to switch the display destination repeatedly by pressing **Fn+F3**, make sure that the display destination has switched completely each time before pressing **Fn+F3** again.
- The screen may become darker. Press **Fn+F2** to make the screen brighter.
- The screen remains dark, if the computer is resumed through either USB device, wired LAN or wireless LAN.
Press a key with no independent effect, such as **Ctrl** or **Shift**.
Do not use a key that may make a selection (**Enter**, **Space**, **Esc**, **Y**, **N**, numeric keys, and so on).
- <Only for CF-T8 Series>
When the display is rotated and the screen saver starts, the screen may go black for approximately 1 minute, depending on the type of screen saver. Change the type of screen saver.

There is an afterimage

- Display a different screen.
If the same screen is displayed for a long time, this may leave an afterimage.

The screen becomes disordered

- The screen display may become distorted if the resolution or number of colors is changed, or if an external display is connected or disconnected while the computer is operating. Restart the computer.

Switching between internal and external displays does not work

- The display destination cannot be switched while a video such as an MPEG file and a DVD Video are playing. Stop playing the video before switching the display destination.

<Only for CF-F8/CF-W8 Series>

A blue background appears on the screen with the MPEG image or DVD Video

- Did you open the CD/DVD drive or remove the disc while it was operating?
Insert the removed disc, and close the disc cover.

<Only for CF-T8 Series>

The display cannot be changed and the operation of the Touch Pad and the touchscreen do not match the display angle

- When some applications are running, the display may not be rotated and the operation of the Touch Pad and the touchscreen may not match the display angle. Press the **Alt + X** key to rotate the display to the landscape mode. After exiting the application, rotate the display, then start up the application again.
- If the problem persists, restart the computer.

The LCD brightness changes a number of times when the AC adaptor is disconnected

- Intel video driver power saving function (Intel(R) Display Power Saving Technology) (→ [page 35](#)) is active and automatically changes the LCD brightness.

Image colors are not reproduced as expected when displaying photographs or other images

- We recommend disabling the [Intel video driver power saving function (Intel(R) Display Power Saving Technology)]. (→ [page 35](#))

Nothing appears on the external display, or the display is not correct

- Check that the external display cables are correctly connected.
- Check that the external display is turned on.
- Check that the external display settings are correct.
- When an external display not compatible with the power-saving mode is used with the computer, the display may not function correctly when the computer enters the power-saving mode. In this case, turn on the external display again. However, in the case of some external displays, the screen display may be distorted or the mouse cursor may not be properly displayed depending on the settings. In this case, try setting the number of colors, screen area (resolution), and refresh rate to smaller values.

Problems with Input

Pressing a letter key produces a number

- The computer may be in ten-key mode.
If NumLk indicator  lights up, press **NumLk**, to disable the ten-key mode, and then input.

Only capital letters are being input

- The computer may be in Caps Lock mode.
If Caps Lock indicator  lights up, press **Caps Lock**, to disable the Caps Lock mode, and then input.

How to input European characters (ß, à, ç etc.), symbols or Euro currency symbol is unclear

- With the following procedure, enter a character using the code table.
 - ① Click [start] - [All Programs] - [Accessories] - [System Tools] - [Character Map].
 - ② Point to the desired font name, such as European fonts, and select it.

Combined key operations with the Fn key do not work

- Check whether [Fn/Ctrl Key] is set to [Replace] in the [Main] menu of the Setup Utility. (→ [page 99](#)).
Change the setting back to [Normal], or if continuing with [Replace] selected, use **Ctrl** in place of **Fn**.

<Only for CF-T8 Series>

Cannot input by touching the display

- When mouse drivers are installed (i.e. IntelliMouse), the touchscreen is unable to be used. Install the touchscreen driver again. (→ [page 14](#))
- Has the touchscreen driver been properly installed?

<Only for CF-T8 Series>

Cannot input using the touchscreen

<Only for model with Windows XP Professional>

- Set [Touchscreen Mode] to [Auto] or [Touchscreen Mode] in the [Main] menu of the Setup Utility. (→ [page 99](#))

<Only for model with Windows XP Tablet PC Edition>

- Set [Touchscreen Mode] to [Auto] or [Tablet Mode] in the [Main] menu of the Setup Utility. (→ [page 99](#))



<Only for CF-T8 Series>

Cannot point the correct position using the included stylus

- Perform the touchscreen calibration. (→ [page 15](#))
- Install the touchscreen driver again. (→ [page 14](#))

<Only for CF-T8 Series with Windows XP Tablet PC Edition>

When you want to use the input panel

- Click  on the taskbar. For information about how to use it, click  on the input panel and click [Help Topics] or [Tutorial].

Problems with Disc and Drive

Unable to read/write to the hard disk

- Your drive or file may not have been properly set.
- Check if there is sufficient space on the hard disk.
- Check that the account with which you are logged on has read and write permissions.
- Your hard disk content may be corrupted. Contact your technical support office.

To check an internal hard disk error

- Disconnect all peripheral devices, including the external display, and check a disk error. (→ [page 109](#))

<Only for CF-F8/CF-W8 Series>

Cannot boot from internal CD/DVD drive

- Check to make sure that the bootable disc is set properly.
- Start up the Setup Utility, and confirm the following settings.
 - [Optical Drive] is set to [Enabled] in the [Advanced] menu. (→ [page 100](#))
 - [Optical Drive Power] is set to [On] in the [Main] menu. (→ [page 99](#))
 - [CD/DVD Drive] is the first device shown in [Boot Option #1] in the [Boot] menu. (→ [page 101](#))
- When an external CD/DVD drive is connected, you cannot boot from the internal CD/DVD drive.

<Only for CF-F8/CF-W8 Series>

Cannot play back TV programs recorded on a commercial DVD recorder

- In order to play media other than DVD-RAM, they must be finalized using the DVD recorder.
- Check whether the DVD is supported in this computer. (→ [page 50](#))

<Only for CF-F8/CF-W8 Series>

The CD/DVD drive indicator does not light/blink

- Check that the disc is inserted correctly.
- The drive power may be turned off.

The drive power can be turned on with the following methods.

 - Slide the drive power/open switch and open the disc cover.
 - Right-click the  on the notification area, and click [On] in [Manual Switching].
- In the Setup Utility, is [Optical Drive Power] set to [Off]? (→ [page 99](#))

If this is set to off, unless Windows is running, it is not possible to turn on the drive.

<Only for CF-F8/CF-W8 Series>

Disc playback and writing is not possible

- Make sure the inserted disc is a compatible media type. For more about compatible media types, see “Disc Information” (→ [page 50](#)).
- You may need to clean the disc.
 - Cleaning the disc (→ [page 46](#))
- Check whether the disc is distorted, damaged, or dirty.
- When inserting a disc, follow the procedure below. Make sure the disc is inserted securely.
 - ① Slide the drive power/open switch, and open the disc cover.
 - ② Slide the disc into the drive under the keyboard with the label side up.
 - ③ Press firmly on the center of the disc until you hear it click into place.

<Only for CF-F8/CF-W8 Series>

When a disc is inserted, it is not played automatically

- Remove the disc and reinsert it.
 - If an AutoPlay CD does not start after the computer resumes from the standby or hibernation, remove the disc from the drive, then reinsert the disc again after a 15 second wait.
If the problem persists, refer to the disc’s operating instructions or other sources to play the disc.
- In the CD/DVD drive properties, click [AutoPlay], and when [Take no action] is set under [Select an action to perform], select the items to be played automatically.

<Only for CF-F8/CF-W8 Series>

If the CD/DVD drive vibrates excessively or is noisy

- Is the disc bent or labeled?
- Check to see if the disc is inserted correctly, and is in good condition.
- When writing to CD-R/RW using Roxio Creator LJB, you can minimize vibration while writing by using the writing speed at [8x] or less.

<Only for CF-F8/CF-W8 Series>

The CD/DVD drive cannot be turned on or off

- After turning off the CD/DVD drive, did you try to turn it on again immediately?
After turning off, you must wait for about 20 seconds until it is possible to turn on (or open the disc cover).
 - If the drive does not automatically power off after ejecting the disc, use [Manual Switching] to turn it off.

- In the following cases, it is not possible to turn off using [Manual Switching] of the Optical Disc Drive Power-Saving Utility:
 - When WinDVD is running
 - During writing or reading of a disc
 - When the drive is being used by an application such as Roxio Creator LJB





<Only for CF-F8/CF-W8 Series>

Cannot eject disc

- Check that the computer is turned on.
The drive power/open switch works only when the computer's power is on.
When [Optical Drive Power] is set to [Off] in the Setup Utility, it is not possible to open the disc cover unless Windows is running.
- Press the center of the disc cover to confirm that the disc cover is locked firmly.
The disc cover will only open if it is in the firmly locked position.
- To remove a disc when the computer is turned off, insert a pointed object (e.g., the bent-out tip of a paper clip, or the tip of a pencil or ballpoint pen) into the emergency hole on the bottom, and then move (→ [page 55](#)).

Problems with Sound

The sound is not heard

- Try changing the mute by pressing **Fn+F4** or **Fn+F5/Fn+F6**.
- With the following procedure, check that the Windows sound function is operating.
(If it is not operating, pressing **Fn+F5** or **Fn+F6** displays the pop-up icon shown on the right, but there is no sound.)
 - ① Click [start] - [Control Panel] - [Performance and Maintenance] - [System] - [Hardware] - [Device Manager].
 - ② Double-click [Sound, video, and game controllers] and check if  is displayed.
If  is displayed, click the driver for which  is shown, press **Del**, and click [OK] in the confirm deletion screen.
Then restart the computer.

To change the volume

- Press **Fn+F5** (to lower the volume) or **Fn+F6** (to increase the volume).

The audio is distorted

- During audio playback, operating a key with **Fn** may cause distortion of the sound. Stop playing and start again.

Cannot change the volume/Cannot increase the volume



- After making WinDVD's screen inactive (by clicking the desktop etc.) press **Fn+F6**.
- Click  in the notification area, and then drag the slide bar to the upper side (to the bigger sounds).

When Win DVD's screen is chosen, the display on the screen  will not be changed even the sound is switched to on/off or the volume is adjusted by using Fn key.

Also, maximizing the volume of WinDVD by pressing **Fn+F6** does not increase the volume more than as it is set by the operating system.

Problems with Peripherals

Your peripheral does not work

- Check that the drivers are installed for the connected devices.
 - ① Click [start] - [Control Panel] - [Performance and Maintenance] - [System] - [Hardware] - [Device Manager].
 - ② Check whether  is shown for the devices.
If  is shown:
Try removing and inserting the device once more. If the problem persists, restart the computer.
- Check the peripheral manufacturer's homepage or other sources to see if a driver update is available.
- After installing the driver, be sure to restart the computer.
- Depending on the device connected, the computer may not recognize when the device is connected or disconnected, or the device may not operate properly.
Use the following procedure:
 - ① Click [start] - [Control Panel] - [Performance and Maintenance] - [System] - [Hardware] - [Device Manager].
 - ② Select the applied device, and remove the check mark for [Allow the computer to turn off this device to save power] in [Power Management]. (This item may be unavailable for some types of devices.)
- When operation resumes from the standby or hibernation, devices such as an external mouse, modem or PC Cards may not function properly. In such cases, restart your computer.
- If it still does not work after checking the above items, consult the peripheral manufacturer.

An error occurs while installing the driver

- Check that the driver is supported by the operating system. If you use an incompatible driver, malfunction may occur.
- Set the [Execute-Disable Bit Capability] to [Disabled] in the [Advanced] menu of the Setup Utility. If the error is not resolved, it is possible that the driver being used is not compatible with the Data execution prevention function. For a driver, consult the peripheral manufacturer.

The device will not operate properly if a different mouse driver is installed

- When you install a different mouse driver, such as IntelliPoint for Microsoft's IntelliMouse, the mouse driver currently installed in the computer may need to be uninstalled.
For information on how to uninstall the driver, refer to "When Using an External Mouse". (→ [page 76](#))
- If not using the Touch Pad, and using an external mouse only, set [Touch Pad] to [Disable] in the [Main] menu of the Setup Utility. (→ [page 99](#)) And uninstall the mouse driver that is installed on this computer.

A PC Card does not work

- Confirm that the card conforms to the PC Card Standard.
- Make sure the card is properly inserted (→ [page 65](#)).
- Check that the proper port settings have been made.
 - ① Click [start] - [Control Panel] - [Performance and Maintenance] - [System] - [Hardware] - [Device Manager].
 - ② Double-click [PCMCIA adapters], and double-click the relevant device.
In [Resources], if [Conflicting device list] shows [No conflicts], there is no conflict.
- Read the instructions supplied with the PC Card, or consult the PC Card manufacturer.
- Check that you are using a driver supported by the operating system.

You do not know the available RAM module

- Refer to *Operating Instructions* "Expanding Memory" or "Specifications".

To check if the additional RAM module has been installed successfully

- If the installation is successful, the main memory and total RAM module size appears in the [Information] menu of the Setup Utility (→ [page 98](#)).
- If the RAM module is not confirmed:
 - Turn the computer off and reinsert the RAM module.
 - Confirm the recommended specifications.
Regarding the RAM module, refer to *Operating Instructions* "Expanding Memory" or "Specifications."

The address map for IRQ, I/O port address, etc. is unclear

- You can check with the following procedure.
 - ① Click [start] - [Control Panel] - [Performance and Maintenance] - [System] - [Hardware] - [Device Manager].
 - ② In the [View] menu, click [Resources by type].

A device connected to a PC Card does not operate correctly (e.g. unstable video images when writing videos to a DV camera using IEEE1394 PC Card)

- This may occur because of performance degradation as a result of the CPU power-saving function. Execute the following operations after logging on to Windows as an administrator.
 - ① Input [c:\util\cpupower\setup.exe] in [start] - [Run], and then click [OK].
Follow the on-screen instructions.
 - ② Click [start] - [All Programs] - [Panasonic] - [CPU Idle Setting].
 - ③ Click [Performance], click [OK] and then click [Yes].
The computer will be restarted automatically.
 - If these phenomena occur even with the above settings, click [start] - [Control Panel] - [Performance and Maintenance] - [Power Options] - [Power Schemes], click [Always On] from [Power schemes], and click [OK].
 - These operations will be helpful in easing the performance losses resulting from CPU power-saving functions, but will not be effective against the phenomena resulting from other causes. (e.g., noise generated during periods of exceptionally high load on the CPU, such as during video playback)
 - When these operations are performed, the battery running time will be reduced to some extent. We thus recommend that when these phenomena do not occur, you should select [Battery (Windows XP Standard)] in [CPU Idle Setting], and return [Power schemes] in [Power Options] to [Panasonic Power Management].
As a result of the LAN communications speed being extremely low, or a wireless LAN connection being lost, if the CPU power-saving setting is set, then when the LAN or whatever is not used, it is recommended to return to the above settings.

When a USB device is connected, an acoustic noise can be heard from the computer

- Using the following procedure, set the USB power save function to [Disabled] in the “USB Power Save Mode Switching Utility”.
When it is set to [Disabled], the computer will not operate as long on the battery.
 - ① Click [start] - [Control Panel] - [Add or Remove Programs].
When [USB Power Save Mode Switching Utility] is not displayed, perform the following procedures from step ②.
When [USB Power Save Mode Switching Utility] is displayed, perform the following procedures from step ⑤.
 - ② Click [start] - [Run] and input [c:\util\usbpower\setup.exe] and then click [OK].
 - ③ Click [Next] and click [Install].
 - ④ Click [Finish].
 - ⑤ Click [start] - [All Programs] - [Panasonic] - [USB Power Save Mode Switching Utility].
 - ⑥ Click [Disabled], and click [OK].
 - ⑦ Click [OK].
 - ⑧ Restart the computer.

Problems with General Network

Unable to connect to a network

- Check that the network you are using ([Modem], [LAN], [Wireless LAN], [Wireless WAN] or [Bluetooth]) is set to [Enabled] in the [Advanced] menu of the Setup Utility (→ [page 100](#)).
- Restart the computer.
- When using the computer as a network computer, some additional settings may have to be made depending on the usage conditions. We recommend asking your system administrator or the person in charge of the network.
- If the hub unit link lamp does not light up, one of the following problems may have occurred.
 - A problem or failure in the hub unit
 - Incorrect cable type or incorrect connection
 - A break in the cable

The communications speed is low

- Setting [CPU Idle Setting] to [Performance] may improve the communication speed. See “A device connected to a PC Card does not operate correctly” (→ [page 127](#)).



Cannot check the computer's MAC address

- Check the computer's MAC address using the following procedure:
 - ① Check that the LAN or wireless LAN is not disabled in the Setup Utility or the Device Manager.
 - ② Click [start] - [All Programs] - [Accessories] - [Command Prompt].
 - ③ Input [ipconfig /all], and press **Enter**.
 - ④ Wireless LAN's MAC address:
Make a note of the 12-digit string of alphanumeric displayed on the wireless LAN's “Physical Address” line.
LAN's MAC address:
Make a note of the 12-digit string of alphanumeric displayed on the LAN's “Physical Address” line.
 - ⑤ Enter “exit”, and press **Enter**.

Problems with Wireless LAN (only for models with wireless LAN)

Access point is not detected

- Shorten the distance between the computer and the access point, and try the detection again.
- It may take some time before the access point is displayed in [Available Networks]. Wait for a moment.
- Confirm the following settings:
 - [Wireless LAN] in the [Advanced] menu of the Setup Utility
Confirm that [Wireless LAN] is set to [Enabled]. (→ [page 100](#))
 - Wireless device off:

Confirm that  /  /  is displayed on the notification area.

Confirm whether the Intel® PROSet/Wireless Software is installed using the following menu.
[start] - [Control Panel] - [Add or Remove Programs].

If it has not been installed, input [c:\util\drivers\wlan\WiFi\XP\x32\Install\install.bat] in [start] - [Run] to install.

- Wireless LAN power supply

If  is displayed on the notification area, slide the wireless switch to the right (ON).

- IEEE802.11a settings

Even if the wireless LAN is on, IEEE802.11a may be set to disable. If IEEE802.11a is to be used, change this setting to enable. (→ [page 92](#))

- This computer uses channels 1 through 11^{*3} when using IEEE802.11b/g. Check the channel being used by the access point.

^{*3} In the case of wireless communications, the frequency band being used can be divided into segments, so that different communications can be conducted on each band segment. A “Channel” refers to the individual frequency bandwidth divisions.

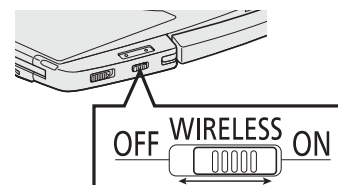

CF-F8 Series

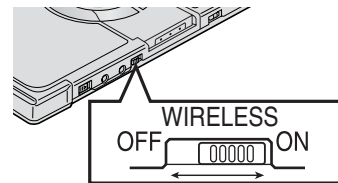

CF-W8/CF-T8 Series



Cannot communicate with the access point

- Using the following procedure, confirm whether the computer's protocol settings are correct (only when using TCP/IP).
 - ① When  is displayed on the notification area:
Right-click , and click [Open Network Connections].
When  is not displayed on the notification area:
Click [start] - [Control Panel] - [Network and Internet Connections] - [Network Connections].
 - ② Right-click [Wireless Network Connection], and click [Properties] - [General] - [Internet Protocol (TCP/IP)] - [Properties].
 - ③ Confirm the protocol settings, such as IP address, and do the settings properly again.
- Depending on the access point and settings, access may not be accepted unless the computer's MAC address is registered beforehand. In this case, check the computer's MAC address (→ [page 128](#)) and register it according to the operating instructions of the access point.

The communications speed is low

- Communication speed may decrease if, aside from the access point to which this computer is connected, there is another access point nearby using the same channel or a similar channel. Change the channel on the connection access point, and check to see if the speed recovers. Confirm method for changing channels using the access point manual.
- The communications speed may be reduced for the following reasons. Shorten the distance between the computer and the access point.
 - IEEE802.11g or IEEE802.11b may be affected by a microwave oven or similar, reducing the communications speed while the microwave oven is in operation.
 - IEEE802.11a is more susceptible to interference than IEEE802.11g or IEEE802.11b, and therefore the communications speed may be reduced if there is a wall between the computer and the access point or if the computer is further away.
- When using a wireless LAN in an environment that combines both IEEE802.11g and IEEE802.11b, communication speed when using IEEE802.11g may decrease.
- Using the CPU Idle Setting to set to [Performance] may improve this problem.
See "A device connected to a PC Card does not operate correctly" (→ [page 127](#)).

Communications with access point are cut off

- Shorten the distance between the computer and the access point, and try the detection again.
- If there are multiple access points aside from the access point to which this computer is connected, confirm that different channels have been set for each access point.
- Using the CPU Idle Setting to set to [Performance] may improve this problem.
See “A device connected to a PC Card does not operate correctly” (→ [page 127](#)).

Cannot set wireless LAN to [Enabled] or [Disabled]

- It may become impossible to set the wireless LAN to [Enabled] or [Disabled] if these settings are changed repeatedly on the [Network Connections] screen. In this case, restart the computer.
- Press **F9** in the Setup Utility. This will restore the Setup Utility's settings to their default values (except the password settings).



is not displayed (or has disappeared)

- To display , perform the following procedure.
 - ① Click [start] - [Control Panel] - [Network and Internet Connections] - [Network Connections].
 - ② Right-click [Wireless Network Connection], and click [Properties].
 - ③ Add a check mark for [Show icon in notification area when connected], and then click [OK].

You can use the PC Information Viewer to check the computer's usage status, and use this information when calling your technical support office for advice.

NOTE

- This computer periodically records the management information of the hard disk, etc. The maximum data volume for each record is 1024 bytes.
This information is only used for estimating the cause when the hard disk goes down by any possibility. They are never sent to outside via network nor used for any other purpose except for the purpose described the above.
To disable the function, add the check mark for [Disable the automatic save function for management information history] in [Hard Disk Status] of PC Information Viewer, and click [OK].
 - When you disable the function, information on how to use the hard disk of PC Information Popup (→ [page 134](#)) is not displayed.
- As long as it is activated, the PC Information Viewer will appear in front of all other screens.
- If you are not an administrator, [Not Found] is displayed and some information is not displayed.

■ Running PC Information Viewer

- ① Click [start] - [All Programs] - [Panasonic] - [PC Information Viewer] - [PC Information Viewer].
Click the items to display detailed information for each item.

■ Save information to a file

Displayed information can be saved to a text file (.txt).

- ① Run the PC Information Viewer and display the information you wish to save.
- ② Click [Save].
 - To save the item that is displayed.
Click [Save only the information displayed] and click [OK].
Some of the hidden information on the screen, which cannot be shown without scrolling the screen, will be saved, too.
 - To save all items.
Click [Save all the information] and click [OK].
If automatic saving of the management information record has not been disabled, the records already recorded are also saved.
- ③ Select the folder, input the file name, and then click [Save].

■ Save a copy of the screen to a file

You can save a copy of the screen currently being displayed to a file in bitmap format (.bmp).

- ① Display the screen you want to save.
- ② Press **Ctrl+Alt+F7**.
- ③ When the message "The copy of the screen was saved..." is displayed, click [OK].
[pcinfo.bmp] file will be saved in [My Documents] folder. If [pcinfo.bmp] file already exists, it will be overwritten. (If [pcinfo.bmp] file is set as a "Read-only" or "Hidden" file, the new file cannot be saved.)
 - To display the extension of the file, click [Tools] - [Folder Options] - [View] from Explorer, and remove the check mark for [Hide extensions for known file types] under the [Advanced settings] section.

NOTE

- You can also save a copy of the screen to a file using the following procedure:
Click [start] - [All Programs] - [Panasonic] - [PC Information Viewer] - [Screen Copy].
- At the time of purchase, the computer is set so that a copy of the screen can be saved to a file by pressing **Ctrl+Alt+F7**. Only an administrator can change this setting using the following procedure:
 - ① Log on to Windows as an administrator.
 - ② Click [start] - [All Programs] - [Panasonic] - [PC Information Viewer].
 - ③ Right-click [Screen Copy], and then click [Properties] - [Shortcut].
 - ④ Move the cursor to [Shortcut key], press the key to be used for the shortcut, and then click [OK].
- Pictures are saved in 256 colors.
- When using an Extended Desktop:
A copy of the screen displayed on the primary device will be saved.

Using PC Information Popup, you can display information on how to use the hard disk.

Enable the automatic display function

When you log on to Windows for the first time, the screen to enable the automatic display function of PC Information Popup appears. Perform the following steps.

- ① Click [1 Notification From Panasonic].



- ② Click [Yes] on the confirmation screen.
The function is enabled and automatically inform you of the information on how to use the hard disk.
This function checks periodically if there is any information on how to use the hard disk.

NOTE

- The confirmation screen to enable the automatic display function also appears when you log on to Windows for the first time using the newly made user account.

Confirm the information on how to use the hard disk

Although this computer is designed to minimize the effects of vibration and shock, the internal hard disk is a precision instrument that is susceptible to damage. Strong vibration or shock to the hard disk may result in malfunctions such as data read errors. However, you can reduce the risk of hard disk deterioration or data loss by observing the precautions regarding the operating environment and handling.

When the automatic display function for the PC Information Popup is enabled, the small popup screen, [x Notifications About Hard Disk Usage] is displayed in the following cases.

Although the information of the hard disk is confirmed regularly, it is not always displayed at the same time as entering the corresponding state. Also, you cannot predict malfunctions of hard disk using this function.

- If the time before the computer enters hibernation is too short
- If the temperature in the usage environment is not appropriate
- If the computer was exposed to impacts/vibrations repeatedly
- If the hard disk has been powered on for 24 hours or more

When the small popup screen is displayed, follow the steps below to confirm the information on how to use the hard disk.

- ① Click [x Notifications About Hard Disk Usage].
- ② Confirm the detail.

NOTE

- To display information on how to use the hard disk, do not add a check mark for [Disable the automatic save function for management information history] in [Hard Disk Status] of PC Information Viewer.
If you add a check mark, a screen to enable the automatic display function will appear in the following cases.
 - When you click PC Information Popup icon
 - When you click [Hard Disk Usage] on [Notification settings - PC Information Popup]If the screen is displayed, take the following steps.
 - ① Click [OK].
 - ② When the [Notification settings - PC Information Popup] screen is displayed, click [OK].
- Hard Disk Handling can be displayed with the following steps as well.
Click [start] - [All Programs] - [Panasonic] - [On-Line Manuals] - [Hard Disk Handling].

■ Confirm information on how to use the hard disk

- ① Right-click PC Information Popup icon on the notification area and click [Check for information now].
- ② Click [x Notifications About Hard Disk Usage].

■ Change the settings



You can change the display conditions for information on how to use the hard disk, or disable the function to display information.

- ① Right-click PC Information Popup icon on the notification area and click [Notification settings...].
- ② Click [General] or [Hard Disk Usage] and make the necessary settings.

■ Status indication

PC information Popup is automatically started after a user is logged in. You can check information using the icons displayed on the notification area.

Normally,  is displayed.

 or  is displayed in the following cases.



: When there is information on how to use the hard disk. (The icon changes according to the timing to display.)
When the small popup screen disappears after the screen appears and certain time passes.

: When the check mark is added for [Disable the automatic save function for management information history] of PC Information Viewer. This indication only appears when [Hard Disk Usage] is enabled.

NOTE

- When the icon is not displayed, click [start] - [All Programs] - [Panasonic] - [PC Information Viewer] - [PC Information Popup].

A computer virus propagates through infections from one computer to another. Some viruses are highly malicious, destroying computer data, or preventing the computer from starting up properly.

The first time you start up Windows, the message [Your computer might be at risk] will be displayed from the Security Center icon  on the notification area. Click , and take the appropriate measures.

■ Use antivirus software (commercially available)

- Update virus definition files frequently, and conduct virus checks regularly.

■ Do not use disks or programs of unknown origin

- Run a virus check on new programs before executing them.

■ Use Windows Firewall

■ Update Windows

In an Internet-connected environment, execute the Windows Update, and use the latest Windows service pack or patch program to update Windows on your computer to its latest version. This update is also an effective measure for preventing viruses and other forms of computer attack.

- In the default setting, the automatic Windows Update in the [Windows Security Center] has not been set. For details of the Security Center's automatic Update functions, refer to Window's Help.

- 1 Log on to Windows as an administrator.**
- 2 Click [start] - [All Programs] - [Windows Update].**

Do not apply "Driver Updates" even if a message to update a driver appears. If a driver update is required, contact your technical support office.

NOTE

- Be sure to perform Windows Update after reinstallation.

■ How to confirm installed patch programs

Click [start] - [Control Panel] - [Add or Remove Programs], and add a check mark for [Show updates].

- Some patch programs are not displayed.
- Of the programs displayed, programs marked as “Hotfix” contain security-related patch programs. Be careful not to erase these by mistake.

When Using the Files on the Retail Version of the Windows CD-ROM

The Windows files included in the Retail Version of the Windows CD-ROM for each OS are contained in the following folders:
c:\windows\docs, c:\windows\dotnetfx, c:\windows\i386, c:\windows\support\tools, c:\windows\valueadd

Network Connections and Communications Software

Close the communications software before using the power saving function.

- If the power saving function (standby or hibernation) is activated while communications software is used, the network connection may be interrupted, or the performance may be adversely affected. In this case, restart the computer.
- In a network environment, set the [System standby] and [System hibernates] settings to [Never].
Click [start] - [Control Panel] - [Performance and Maintenance] - [Power Options] - [Power Schemes].

- Copyright
 - © Panasonic Corporation 2009
- Disclaimer

Computer specifications and manuals are subject to change without notice. Panasonic Corporation assumes no liability for damage incurred directly or indirectly from errors, omissions or discrepancies between the computer and the manuals.
- Trademarks
 - Microsoft, Windows, Windows Vista, IntelliMouse and the Windows logo are registered trademarks or trademarks of Microsoft Corporation of the United States and/or other countries.
 - Intel, Core, Centrino and PROSet are either registered trademarks or trademarks of Intel Corporation.
 - SDHC Logo is a trademark. 
 - Adobe, the Adobe logo and Adobe Reader are either registered trademarks or trademarks of Adobe Systems Incorporated in the United States and/or other countries.
 - Bluetooth™ is a trademark owned by Bluetooth SIG, Inc., U.S.A. and licensed to Panasonic Corporation.
 - PS/2® is a registered trademark of International Business Machines Corporation.
 - Corel, InterVideo, WinDVD™, the InterVideo logo and the Corel logo are trademarks or registered trademarks of Corel Corporation and/or its subsidiaries in Canada, the United States and/or other countries.
 - Sonic, Roxio and Roxio Creator are trademarks or registered trademarks of Sonic in the United States and/or other countries.
 - Names of products, brands, etc., appearing in this manual are trademarks or registered trademarks of their respective own companies.

PCE0272B_XP/T

Free Manuals Download Website

<http://myh66.com>

<http://usermanuals.us>

<http://www.somanuals.com>

<http://www.4manuals.cc>

<http://www.manual-lib.com>

<http://www.404manual.com>

<http://www.luxmanual.com>

<http://aubethermostatmanual.com>

Golf course search by state

<http://golfingnear.com>

Email search by domain

<http://emailbydomain.com>

Auto manuals search

<http://auto.somanuals.com>

TV manuals search

<http://tv.somanuals.com>