



OPERATING INSTRUCTIONS

Personal Computer

Model No. **CF-T2 Series**

Contents

	Page
Getting Started	
Read Me First	3
Names and Functions of Parts	8
First-time Operation	12

Getting Started

Operation

Starting Up/Shutting Down	16
Touch Pad	19
Reference Manual	20
RAM Module	21
Useful Information	24

Operation

Troubleshooting

List of Error Codes	28
Dealing with Problems (Summary)	29
Reinstalling Software	34

Troubleshooting

Appendix

LIMITED USE LICENSE AGREEMENT	36
Hard Disk Backup Function	38
Hard Disk Data Erase Utility	42
Specifications	43
LIMITED WARRANTY	45

Appendix

XP

[Additional Manual]

Reference Manual

This manual can be accessed on your computer. Refer to page 20 on how to access the Reference Manual.

Customer's Record

Model No. *1	Dealer's Name
Serial No.	
or	
Code No.	Dealer's Address
Date of Purchase	

*1 For the Model No., insert the 12 digit number (for example, CF-T2FWATZBM) located on the bottom of the computer.

Introduction

Thank you for purchasing the Panasonic computer. Read the operating instructions thoroughly for proper operation of your new computer.

Illustrations and Terminology in this Manual

NOTE:



NOTE provides a useful fact or helpful information.

CAUTION:

CAUTION indicates a condition that may result in minor or moderate injury.

 :

This illustration means to press the [Enter] key.

 +  :

This illustration means to press and hold the [Fn] key, then press the [F5] key.

When using with the [Fn] and [Ctrl] functions interchanged, read with [Fn] and [Ctrl] reversed ( Reference Manual "Using the Fn Key").

[start] - [Run]:

This illustration means to click [start], then to click [Run].

 :

Where to go for referred information.

 Reference Manual :

This illustration means to refer to the Reference Manual, which is available on your computer.

Refer to page 20 on how to access this manual.

- Some of the illustrations in this manual may differ slightly in shape from the actual items in order to make the explanation easier to understand.
- In this manual, "Microsoft® Windows® XP Professional Service Pack 2 with Advanced Security Technologies" is indicated as "Windows" or "Windows XP".
- If the user has logged on without the administrator authority, some functions may not be executable, and some screens may not be displayed as shown in this manual. If this happens, log on with the administrator authority to enable these functions.
- Confirm the latest information on optional products in catalogs, etc.

Copyright

This manual is copyrighted by Matsushita Electric Industrial Co., Ltd. with all rights reserved. No part of this manual may be reproduced in any form without the prior written permission of Matsushita Electric Industrial Co., Ltd. No patent liability is assumed with respect to the use of the information contained herein.

© 2005 Matsushita Electric Industrial Co., Ltd. All Rights Reserved.

Disclaimer

Computer specifications and manuals are subject to change without notice. Matsushita Electric Industrial Co., Ltd. assumes no liability for damage incurred directly or indirectly from errors, omissions or discrepancies between the computer and the manuals.

Trademarks

Microsoft, Windows and the Windows logo are registered trademarks of Microsoft Corporation of the United States and/or other countries.

Intel, Pentium and PROSet are either registered trademarks or trademarks of Intel Corporation.

SD Logo is a trademark. 

Adobe, the Adobe logo and Adobe Reader are either registered trademarks or trademarks of Adobe Systems Incorporated in the United States and/or other countries.

Panasonic is a registered trademark of Matsushita Electric Industrial Co., Ltd.

Names of products, brands, etc., appearing in this manual are trademarks or registered trademarks of their respective owner companies.

Read Me First

For U.S.A.

Federal Communications Commission Radio Frequency Interference Statement

Note: This equipment has been tested and found to comply with the limits for a Class B digital device, pursuant to Part 15 of the FCC Rules. These limits are designed to provide reasonable protection against harmful interference in a residential installation. This equipment generates, uses and can radiate radio frequency energy and, if not installed and used in accordance with the instructions, may cause harmful interference to radio communications. However, there is no guarantee that interference will not occur in a particular installation. If this equipment does cause harmful interference to radio or television reception, which can be determined by turning the equipment off and on, the user is encouraged to try to correct the interference by one or more of the following measures:

- Reorient or relocate the receiving antenna.
- Increase the separation between the equipment and receiver.
- Connect the equipment into an outlet on a circuit different from that to which the receiver is connected.
- Consult the Panasonic Service Center or an experienced radio/TV technician for help.

Warning

To assure continued compliance, use only shielded interface cables when connecting to a computer or peripheral. Also, any changes or modifications not expressly approved by the party responsible for compliance could void the user's authority to operate this equipment.

FCC RF Exposure Warning:

- This equipment complies with FCC radiation exposure limits set forth for an uncontrolled environment.
- This equipment must be installed and operated in accordance with provided instructions and minimum 1.5 cm spacing must be provided between antenna and all person's body (excluding extremities of hands, wrist and feet) during wireless modes of operation.
- This transmitter must not be co-located or operated in conjunction with any other antenna or transmitter.
- This computer is provided with a PC Card slot that could be used with wireless transmitter(s), which will be specifically recommended, when they become available. Other third-party wireless transmitter(s) have not been RF exposure evaluated for use with this computer and may not comply with FCC RF exposure requirements.

This product is restricted to indoor use due to its operation in the 5.15 to 5.25 GHz frequency range.

FCC requires this product to be used indoors for the frequency range 5.15 to 5.25 GHz to reduce the potential for harmful interference to co-channel Mobile Satellite systems.

High power radars are allocated as primary users of the 5.25 to 5.35 GHz and 5.65 to 5.85 GHz bands. These radar stations can cause interference with and /or damage this product.

This device complies with Part 15 of the FCC Rules. Operation is subject to the following two conditions:

- (1) This device may not cause harmful interference, and
- (2) This device must accept any interference received, including interference that may cause undesired operation.

Responsible Party: Panasonic Corporation of North America
One Panasonic Way
Secaucus, NJ 07094
Tel No: 1-800-LAPTOP5 (1-800-527-8675)

FCC Regulation Notice for modem This equipment contains a FCC approved modem.

FC Tested To Comply
With FCC Standards
FOR HOME OR OFFICE USE

1. This equipment complies with CFR47 Part 68 rules. On the computer is a label that contains, among other information, the FCC registration number and ringer equivalence number (REN) for this equipment. If required, this information must be provided to the telephone company.
2. An FCC compliant telephone cord and modular plug is provided with this equipment. This equipment is designed to be connected to the telephone network or premises wiring using a compatible modular jack which is Part 68 compliant. See Installation Instructions for details.
3. The REN is used to determine the quantity of devices which may be connected to the telephone line. Excessive RENs on the telephone line may result in the devices not ringing in response to an incoming call. In most, but not all area, the sum of RENs should not exceed five (5.0). To be certain of the number of devices that may be connected to a line, as determined by the total RENs, contact the local telephone company.
4. If your telephone equipment cause harm to the telephone network, the telephone company will notify you in advance that temporary discontinuance of service may be required. But if advance notice isn't practical, the telephone company will notify the customer as soon as possible. Also, you will be advised of your right to file a complaint with the FCC if you believe it is necessary.
5. The telephone company may take changes in its facilities, equipment, operations or procedures that could affect the operation of the equipment. If this happens the telephone company will provide advance notice in order for you to make necessary modifications to maintain uninterrupted service.
6. If trouble is experienced with this equipment, for repair or warranty information, please contact Panasonic Corporation of North America at DIAL TOLL FREE 1-800-LAPTOP5 (1-800-527-8675). If the equipment is causing harm to the telephone network, the telephone company may request that you disconnect the equipment until the problem is resolved.
7. There are no user serviceable parts contained in this equipment.
8. This equipment may not be used on coin service provided by the telephone company. Connection to party lines is subject to state tariffs.

Read Me First

9. The Telephone Consumer Protection Act of 1991 makes it unlawful for any person to use a computer or other electronic device to send any message via a telephone fax machine unless such message clearly contains in a margin at the top or bottom of each transmitted page or on the first page of the transmission, the date and time it is sent and an identification of the business or other entry, or other individual sending the message and the telephone number of the sending machine or such business, other entity, or individual. In order to program this information into your fax software, you should refer to the manual of the Fax software being used.
10. According to the FCC's electrical safety advisory, we recommend that you may install an AC surge arrester in the AC outlet to which this equipment is connected. Telephone companies report that electrical surges, typically lightning transients, are very destructive to customer terminal equipment connected to AC power sources and that this is a major nationwide problem.

“Caution: To reduce the risk of fire, use only No.26 AWG or larger telecommunication line cord.”

“ATTENTION: Pour réduire le risque d'incendie, utiliser uniquement des conducteurs de télécommunications 26 AWG ou de section supérieure.”

Notice for the products using LCD

This product uses one or more fluorescent lamps containing a small amount of mercury. It also contains lead in some components. Disposal of these materials may be regulated in your community due to environmental considerations. For disposal or recycling information please contact your local authorities, or the Electronics Industries Alliance: <<http://www.eiae.org/>>

For Canada

Industry Canada (IC) Notice for modem

This equipment contains an Industry Canada approved modem unit. The Industry Canada label is affixed on the modem unit.

EQUIPMENT ATTACHMENT LIMITATIONS

“NOTICE: The Industry Canada label identifies certified equipment. This certification means that the equipment meets telecommunications network protective, operational and safety requirements as prescribed in the appropriate Terminal Equipment Technical Requirements document(s). The Department does not guarantee the equipment will operate to the user's satisfaction.

Before installing this equipment, users should ensure that it is permissible to be connected to the facilities of the local telecommunications company. The equipment must also be installed using an acceptable method of connection. The customer should be aware that compliance with the above conditions may not prevent degradation of service in some situations.

Repairs to certified equipment should be coordinated by a representative designated by the supplier. Any repairs or alterations made by the user to this equipment, or equipment malfunctions, may give the telecommunications company cause to request the user to disconnect the equipment.

Users should ensure for their own protection that the electrical ground connections of the power utility, telephone lines and internal metallic water pipe system, if present, are connected together. This precaution may be particularly important in rural areas. Caution: Users should not attempt to make such connections themselves, but should contact the appropriate electric inspection authority, or electrician, as appropriate.”

“NOTICE: The Ringer Equivalence Number (REN) assigned to each terminal device provides an indication of the maximum number of terminals allowed to be connected to a telephone interface. The termination on an interface may consist of any combination of devices subject only to the requirement that the sum of the Ringer Equivalence Numbers of all the devices does not exceed 5.”

REN: See bottom of the computer

RESTRICTIONS CONCERNANT LE RACCORDEMENT DE MATÉRIEL

“AVIS: L'étiquette d'Industrie Canada identifie le matériel homologué. Cette étiquette certifie que le matériel est conforme aux normes de protection, d'exploitation et de sécurité des réseaux de télécommunications, comme le prescrivent les documents concernant les exigences techniques relatives au matériel terminal. Le Ministère n'assure toutefois pas que le matériel fonctionnera à la satisfaction de l'utilisateur.

Avant d'installer ce matériel, l'utilisateur doit s'assurer qu'il est permis de le raccorder aux installations de l'entreprise locale de télécommunication. Le matériel doit également être installé en suivant une méthode acceptée de raccordement. L'abonné ne doit pas oublier qu'il est possible que la conformité aux conditions énoncées ci-dessus n'empêche pas la dégradation du service dans certaines situations.

Les réparations de matériel homologué doivent être coordonnées par un représentant désigné par le fournisseur. L'entreprise de télécommunications peut demander à l'utilisateur de débrancher un appareil à la suite de réparations ou de modifications effectuées par l'utilisateur ou à cause de mauvais fonctionnement.

Pour sa propre protection, l'utilisateur doit s'assurer que tous les fils de mise à la terre de la source d'énergie électrique, des lignes téléphoniques et des canalisations d'eau métalliques, s'il y en a, sont raccordés ensemble. Cette précaution est particulièrement importante dans les régions rurales. Avertissement: L'utilisateur ne doit pas tenter de faire ces raccordements lui-même; il doit avoir recours à un service d'inspection des installations électriques, ou à un électricien, selon le cas.”

“AVIS: L'indice d'équivalence de la sonnerie (IES) assigné à chaque dispositif terminal indique le nombre maximal de terminaux qui peuvent être raccordés à une interface. La terminaison d'une interface téléphonique peut consister en une combinaison de quelques dispositifs, à la seule condition que la somme d'indices d'équivalence de la sonnerie de tous les dispositifs n'excède pas 5.”

IES: Voir sous le fond de l'ordinateur

Industry Canada

This product complies with RSS210 Industry Canada. Operation is subject to the following two conditions;
(1) this device may not cause interference, and
(2) this device must accept any interference, including interference that may cause undesired operation of the device.

This product (local network devices) for the band 5150-5250 MHz is only indoor usage to reduce potential for harmful interference to co-channel Mobile Satellite systems. High power radars are allocated as primary users (meaning they have priority) of 5250-5350 MHz and 5650-5850 MHz and these radars could cause interference and/or damage to LELAN devices.

Important Safety Instructions / Importantes Mesures De Sécurité

When using your telephone equipment, basic safety precautions should always be followed to reduce the risk of fire, electric shock and injury to persons, including the following:

1. Do not use this product near water, for example, near a bath tub, washbowl, kitchen sink or laundry tub, in a wet basement or near a swimming pool.
2. Avoid using a telephone (other than a cordless type) during an electrical storm. There may be a remote risk of electric shock from lightning.
3. Do not use the telephone to report a gas leak in the vicinity of the leak.
4. Use only the power cord and batteries indicated in this manual. Do not dispose of batteries in a fire. They may explode. Check with local codes for possible special disposal instructions.

SAVE THESE INSTRUCTIONS

Certaines mesures de sécurité doivent être prises pendant l'utilisation de matériel téléphonique afin de réduire les risques d'incendie, de choc électrique et de blessures. En voici quelquesunes:

1. Ne pas utiliser l'appareil près de l'eau, p.ex., près d'une baignoire, d'un lavabo, d'un évier de cuisine, d'un bac à laver, dans un sous-sol humide ou près d'une piscine.
2. Éviter d'utiliser le téléphone (sauf s'il s'agit d'un appareil sans fil) pendant un orage électrique. Ceci peut présenter un risque de choc électrique causé par la foudre.
3. Ne pas utiliser l'appareil téléphonique pour signaler une fuite de gaz s'il est situé près de la fuite.
4. Utiliser seulement le cordon d'alimentation et le type de piles indiqués dans ce manuel. Ne pas jeter les piles dans le feu: elles peuvent exploser. Se conformer aux règlements pertinents quant à l'élimination des piles.

CONSERVER CES INSTRUCTIONS

Information to the User

This product and your Health

This product, like other radio devices, emits radio frequency electromagnetic energy. The level of energy emitted by this product however is far much less than the electromagnetic energy emitted by wireless devices like for example mobile phones.

Because this product operates within the guidelines found in radio frequency safety standards and recommendations, we believe this product is safe for use by consumers. These standards and recommendations reflect the consensus of the scientific community and result from deliberations of panels and committees of scientists who continually review and interpret the extensive research literature. In some situations or environments, the use of this product may be restricted by the proprietor of the building or responsible representatives of the organization. These situations may for example include:

- Using this product on board of airplanes, or
- In any other environment where the risk of interference to other devices or services is perceived or identified as harmful.

If you are uncertain of the policy that applies on the use of wireless devices in a specific organization or environment (e.g. airports), you are encouraged to ask for authorization to use this product prior to turning on the product.

Regulatory Information

We are not responsible for any radio or television interference caused by unauthorized modification of this product. The correction of interference caused by such unauthorized modification will be the responsibility of the user. We and its authorized resellers or distributors are not liable for damage or violation of government regulations that may arise from failing to comply with these guidelines.

Lithium Battery

Lithium Battery!

This computer contains a lithium battery to enable the date, time, and other data to be stored. The battery should only be exchanged by authorized service personnel.

Warning! A risk of explosion from incorrect installation or misapplication may possibly occur.

Pile au lithium!

Le micro-ordinateur renferme une pile au lithium qui permet de sauvegarder certaines données, notamment la date et l'heure. La pile ne doit être remplacée que par un technicien qualifié.

Danger! Risque d'explosion en cas de non respect de cette mise en garde!

Read Me First

Precautions

● Usage

Avoid Extreme Heat and Cold

Do not store or use the computer in locations exposed to heat, direct sunlight, or extreme cold. Avoid moving the computer between locations with large temperature difference.

Operation: 5 °C to 35 °C {41 °F to 95 °F}

Storage: -20 °C to 60 °C {-4 °F to 140 °F}



Avoid Direct Sunlight on the LCD Panel

The LCD panel should not be exposed to direct sunlight or ultraviolet light.



Avoid Humidity, Liquids and Dust

Do not store or use the computer in locations exposed to high humidity, liquids (including rain) or dust.



Prevent Shock

Avoid subjecting the computer to severe vibrations or impact. Do not place the computer inside a car trunk.

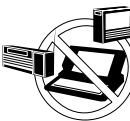

Avoid Radio Frequency Interference

Do not place the computer near a television or radio receiver.



Avoiding Low-temperature Burns

Avoid more than casual contact with any heat producing area of the notebook computer, AC adaptor, and any option or accessory you use with it. Even low heat, if warmer than body temperature, can cause a burn, if the skin is exposed to the heat source for a long period of time.



Do not touch the computer and cable when it starts thundering



Keep SD memory cards and MultiMedia Cards (both sold separately) away from infants and small children

Accidental swallowing will result in bodily injury. In the event of accidental swallowing, see a doctor immediately.



Do not connect a telephone line, or a network cable other than the one specified, into the LAN port

If the LAN port is connected to a network such as the ones listed below, a fire or electric shock may result.

- Networks other than 100BASE-TX or 10BASE-T
- Phone lines (Telephone lines, internal phone lines (on-premise switches), digital public phones, etc.).

● Handling



Avoid Magnetic Fields

Keep the computer away from magnets. Data stored on the hard disk may be lost.



Avoid Stacking

Do not place heavy objects on top of the computer.



Keep Small Objects Away

Do not insert paper clips or other small objects into the computer.



Do Not Disassemble the Computer

Do not attempt to disassemble your computer.



Avoid Excessive Force on the Display

Do not apply excessive downward force on the display.

Precautions (Battery Pack)

- Care should be exercised with regard to the following in order to avoid the possibility of overheating, fire or damage.



Avoid Heat

Do not throw the battery pack into a fire or expose it to excessive heat.



Keep Articles Away

Do not place the battery pack together with articles such as necklaces or hairpins when carrying or storing.



Do Not Disassemble

Do not insert sharp objects into the battery pack, expose it to bumps or shocks, deform, disassemble, or modify it.



Do Not Short

Do not short the positive (+) and negative (-) contacts.



Avoid Extreme Heat, Cold and Direct Sunlight

Do not charge, use or leave the battery pack for extended periods where it will be exposed to direct sunlight, in a hot place (in a car on a sunny day, for example), or in a cold place.



Do Not Use With Any Other Computer

The battery pack is rechargeable and was intended for the specified computer. Do not use it with a computer other than the one for which it was designed.



Do not use this computer with a battery pack other than the one specified (the one included with the computer or the specified battery pack sold separately)



Do Not Put into a Microwave

Do not put the battery pack into a microwave oven or a pressurized chamber.



Stop Using

Should the battery emit an abnormal odor, become hot to the touch, become discolored, change shape, or become in any way different from normal, remove it from the computer and stop using it.

- Do not touch the terminals on the battery pack. The battery pack may no longer function properly if the contacts are dirty or damaged.
- Do not expose the battery pack to water, or allow it to become wet.
- If the battery pack will not be used for a long period of time (a month or more), charge or discharge (use) the battery pack until the remaining battery level becomes 30% to 40% and store it in a cool, dry place.
- This computer prevents overcharging of the battery by recharging only when the remaining power is less than approx. 95% of capacity.
- The battery pack is not charged when the computer is first purchased. Be sure to charge it before using it for the first time. When the AC adaptor is connected to the computer, charging begins automatically.
- Should the battery leak and the fluid get into your eyes, do not rub your eyes. Immediately flush your eyes with clear water and see a doctor for medical treatment as soon as possible.

NOTE

- The battery pack may become warm during recharging or normal use. This is completely normal.
- Recharging will not commence if internal temperature of the battery pack is outside of the allowable temperature range (0 °C to 55 °C {32 °F to 131 °F}). (☞ Reference Manual "Battery Power") Once the allowable range requirement is satisfied, charging begins automatically. Note that the recharging time varies based on the usage conditions. (Recharging takes longer than usual when the temperature is 10 °C {50 °F} or below.)
- If the temperature is low, the operating time is shortened. Only use the computer within the allowable temperature range.
- The battery pack is a consumable item. If the amount of time the computer can be run by using a particular battery pack becomes dramatically shorter and repeated recharging does not restore its performance, the battery pack should be replaced with a new one.
- When transporting a spare battery inside a package, briefcase, etc., it is recommended that it be placed in a plastic bag so that its contacts are protected.
- Always power off the computer when it is not in use. Leaving the computer on when the AC adaptor is not connected will exhaust the remaining battery capacity.

Names and Functions of Parts

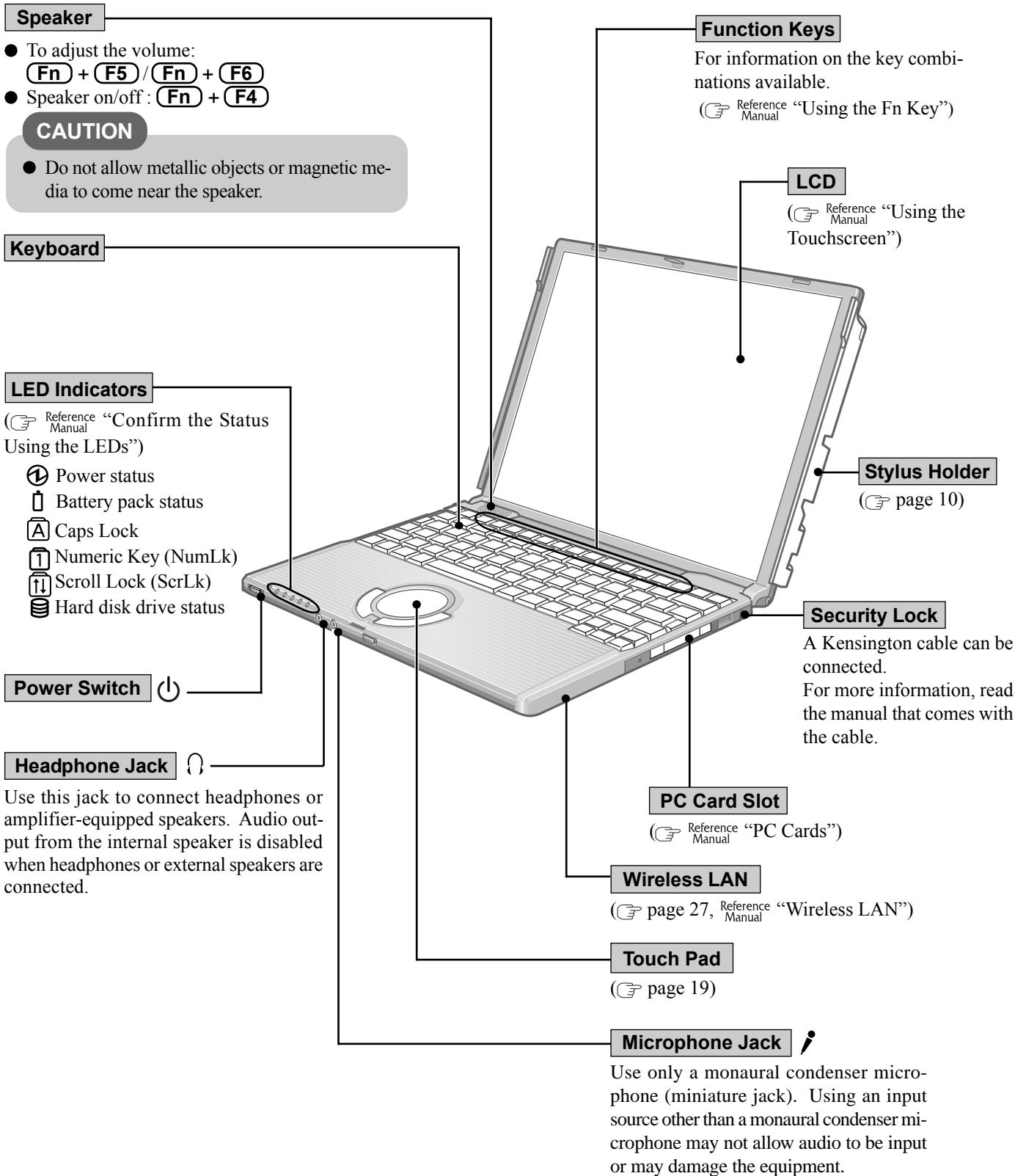

Wireless LAN

(☞ page 27, Reference Manual “Wireless LAN”)

DC-IN Jack  DC IN 16V

External Display Port 

(☞ Reference Manual “External Display”)

USB Ports 

(☞ Reference Manual “USB Devices (External Mouse etc.)”)

LAN 

(☞ Reference Manual “LAN”)

CAUTION

- Do not connect the modem telephone cable into the LAN port.

Modem 

(☞ Reference Manual “Modem”)

CAUTION

- Do not allow metallic objects or magnetic media to come near this area.

SD Memory Card Slot

 SD memory card status
 (☞ Reference Manual “SD Memory Card/MultiMedia Card”)

Battery Pack

(☞ Reference Manual “Battery Power”)

Hand Strap (☞ page 17)

RAM Module Slot
 (☞ page 21)

CAUTION

- Do not cover the computer with a thick cloth, such as a blanket.



A lithium ion battery that is recyclable powers the product you have purchased. Please call 1-800-8-BATTERY for information on how to recycle this battery.

L'appareil que vous vous êtes procuré est alimenté par une batterie au lithium-ion. Pour des renseignements sur le recyclage de la batterie, veuillez composer le 1-800-8-BATTERY.

Names and Functions of Parts

Using the Tether

The tether prevents the stylus (included) from falling accidentally. It can be attached to the stylus holder (☞ page 11).

Attaching the Tether

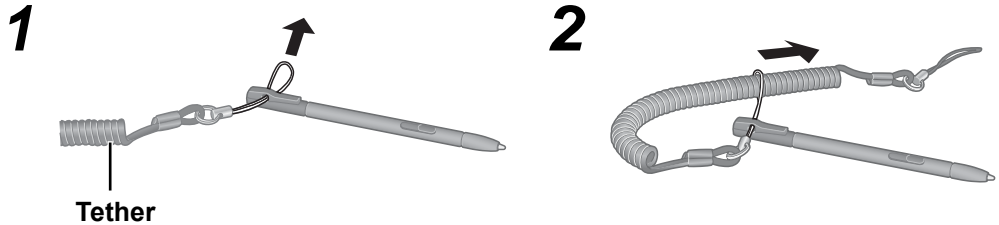

CAUTION

- Do not carry the computer by gripping the tether.

Before Using the Stylus

The computer is supplied with the stylus holder attached to the right side of the internal display. If you want to attach the stylus holder to the left side of the display, use the following method.

Attaching or Removing the Stylus Holder

CAUTION

- Do the following before attaching or removing the stylus holder.
 - Turn off the computer.
 - Remove the battery pack and AC adaptor.
 - Remove the stylus from the stylus holder.
- When attaching or removing the stylus holder, work in a level place.
- To attach or remove the stylus holder, use a no. 0 precision Phillips screwdriver.

Open the display slightly, and stand the computer on its side. (Refer to the illustration on the left.)

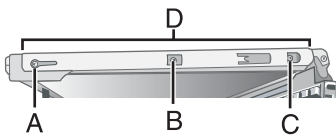
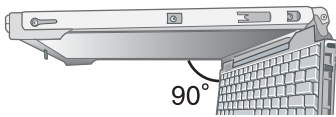

Using the screwdriver, remove the screws (A, B, C) from the right side of the display. This detaches the stylus holder (D).

Reattach the screws (A, B, C) to the right side of the display.

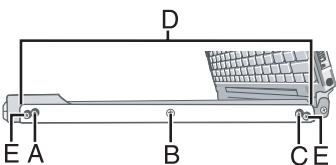

Turn the computer over, so that the left side of the display is at the top.

Using the screwdriver, remove the screws (A, B, C) from the left side of the display.

- Be careful not to remove the screw (E).

Attach the stylus holder (D) removed in step to the left side of the display, and fasten the screws (A, B, C).

Attaching and Stowing the Stylus

At the time of purchase, the stylus is not attached to the stylus holder.

With the stylus holder attached, use the following method to attach the supplied stylus to the stylus holder.

Thread the stylus strap of the tether (a) from (A) in the direction of the arrow, and fasten it to the hook (B) using a pointed object (e.g., the bent-out tip of a paper clip).

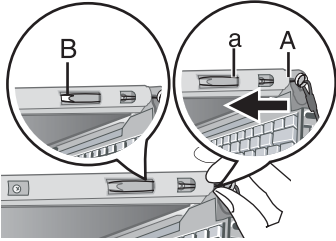

To store the stylus, push the end into (C).

Push in the stylus so that the part (b) is aligned with (D).

CAUTION

- Do not carry the computer by gripping the stylus holder.

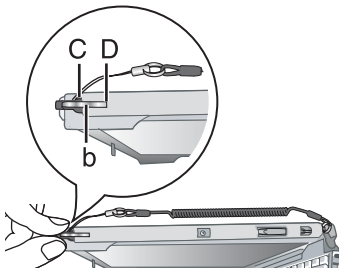





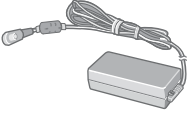
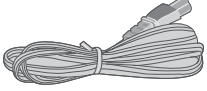

First-time Operation

Read the steps below to help you learn what parts are included, and to gain an understanding of some basic computer-related operations.

1 Confirm the inclusion of all parts.

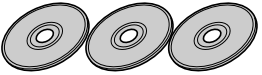
Make sure the parts shown in the figure have been supplied. If any of these items are missing or is not working properly, contact your technical support office (☎ page 45).

AC adaptor 1  Model No : CF-AA1623A	AC Cord 1 	Battery Pack 1  Model No : CF-VZSU24B
Soft Cloth 1 	Stylus 1  <small>(☞ Reference Manual "Using the Touchscreen")</small>	Tether 1  <small>(☞ page 10)</small>
Product Recovery CD-ROM 3 	Modem Telephone Cable 1 	Operating Instructions (This book) 1 Windows® Book 1

Refer to page 24 for details on the carrying cloth for protecting the keyboard.

2 Read the LIMITED USE LICENSE AGREEMENT. (☞ page 36)

Be sure to read the LIMITED USE LICENSE AGREEMENT before breaking the seal on the computer's packaging.

3 Turn the computer over and insert the battery pack.

Make sure the battery pack is facing the correct direction, slide it in the direction of the arrow, and then check to ensure that the battery pack is held firmly by the latches on the left and right sides.

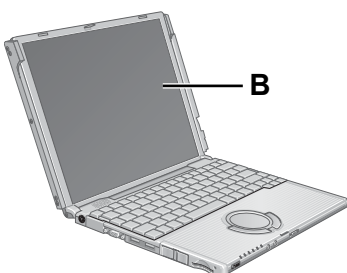
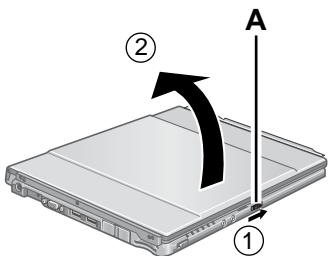
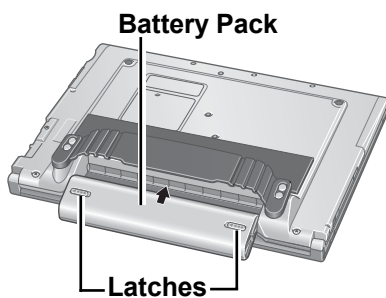

CAUTION

- Confirm that the latch is properly locked. If it is not, the battery pack may come off while you are carrying around the computer.
- Do not touch the terminals on the battery pack and the computer. The battery pack may no longer function properly if the contacts are dirty or damaged. Also, the computer may not operate properly.
- Before using the battery pack, carefully read "Precautions (Battery Pack)" (☞ page 7).

4 Open the display.

- ① Slide the latch (A) located at the front.
- ② Lift open the display.

CAUTION

- Do not open the display wider than necessary (160° or more).
- Do not apply excessive pressure to the LCD (B). Also, do not hold the LCD when opening or closing the display.

5 Connect your computer to a power outlet.

The battery pack will be charged automatically.

Charging Time: Approx. 3 hours

(Varies depending on the usage conditions.)

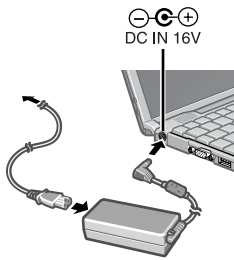

CAUTION



- Be sure the AC adaptor is connected until completing the first-time use operation.
- When using the computer for the first time, do not connect any peripheral device except the battery pack and AC adaptor to the computer.

Handling the AC adaptor

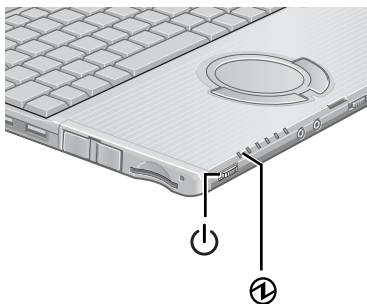
- Do not twist or pull the AC power cord forcefully. Doing so may damage the connections.
- Use only the specified AC adaptor with your computer. Using an AC adaptor other than the one supplied might damage the battery and/or the computer.
- When the DC plug is not connected to the computer, disconnect the AC cord from your AC wall outlet.
- Problems such as sudden voltage drops may arise during periods of thunder and lightning. Since this could adversely affect your computer, an uninterruptible power source (UPS) is highly recommended unless running from the battery pack alone.





6 Turn your computer on.

Slide the power switch  and hold it for approximately one second until the power indicator  turns on before releasing it.

CAUTION

- Do not slide the power switch and hold it for more than four seconds; this will cause the power to be turned off forcibly.
- Do not slide the power switch repeatedly.
- Once the computer is powered off, you must wait at least ten seconds before powering it on again.

7 Setup Windows.

Moving the cursor  or clicking buttons can be performed with the touch pad ( page 19).

CAUTION

- Do not press any keys, or touch the touch pad or touchscreen until [Windows XP Professional Setup] is displayed.

- ① At [Welcome to the Windows XP Setup Wizard], click [Next].
- ② After reading the agreement, click [I accept this agreement] or [I don't accept this agreement], then click [Next].

NOTE

- If [I don't accept this agreement] is selected, the Windows setup will be aborted.

- ③ Select settings for your region, then click [Next].
- ④ Enter your name and organization and then click [Next].

First-time Operation

- Enter your computer name and administrator password and then click [Next].

CAUTION

- Remember this password! If the password is forgotten, Windows cannot be operated.

- Set the correct date, time and the time zone, then click [Next].

NOTE

- It may take some time before the computer restarts and the screen of step 7 is displayed. Wait, and do not press any keys, or touch the touch pad or touchscreen, etc.
If the keyboard or the touch pad etc. are operated, a message will appear indicating that there is no response on the screen, or some screens may appear white. In such cases, also wait until the next screen is displayed.

The computer will restart.

- Enter your administrator password and click .

NOTE

- When Windows setup is completed, the following message will be displayed at the bottom right of the screen: "Your computer might be at risk." Continue to the next step.
The message is generated by the [Security Center] function in [Control Panel], and does not indicate an error or malfunction. For more information about [Security Center]:  page 26

8 Create a new account.

- Click [start] - [Control Panel] - [User Accounts] - [Create a new account].
- Enter a new name for the new account, then click [Next].
- Select [Computer administrator], then click [Create Account].
- <When you want to create a password for the new account>
Select the new account you have created and click [Create a password].
Follow the instructions on the screen to create a password.
- Click [start] - [Turn Off Computer] - [Restart] to restart the computer.

CAUTION

- Remember this password! If the password is forgotten, Windows cannot be operated. You can create a password reset disk beforehand ( page 15).

NOTE

- **When creating a new user account:**

- If you make mail settings, create password reset disks (☞ below), or conduct other related operations before creating the user account, you will be unable to use any previous mail history or settings.
- When you create the first new account, you can only select [Computer administrator].

Once a “Computer Administrator” account has been created, you can create additional limited user accounts.

Note also that only the added user account will be displayed in the Welcome screen. The account for the administrator created during Windows setup will not be displayed.

- The message “Your computer might be at risk,” which is displayed at the bottom right of the screen, is generated by the “Security Center” function in Windows XP, and does not indicate an error or malfunction. To prevent this message from being displayed, refer to “Security of the Computer” (☞ page 26).
- To improve the security of the computer, be sure to refer to “Security of the Computer” (☞ page 26) and “Windows Update” (☞ page 27).
- **About the Icon Enlarger:**
 - If the characters or icons on the screen are too small and difficult to see, after completing step 8, click [start] - [All Programs] - [Panasonic] - [Icon Enlarger]. This will allow you to magnify the display of characters and icons on the screen. (☞ Reference Manual “Icon Enlarger”)
 - The [Icon Enlarger] can be set separately for each account.
- You can also use [Loupe Utility], which enlarges a part of the screen. (☞ Reference Manual “Loupe Utility”)
- If the cursor can not be pointed correctly with the stylus, perform [Calibration] in [start] - [Control Panel] - [Printers and Other Hardware] - [Mouse] - [TouchScreen].
- If you use the wireless LAN, be sure to refer to “Wireless LAN” (☞ page 27).

This concludes the first-time use operation guidelines.

Information for Windows XP

- Depending on the Windows settings, installed applications, and drivers, menus and other displays may differ, or some functions (such as use of the password reset disk) may be inoperable. Check with your system administrator for details.
- You can select Classic view for the Control Panel or select the Classic Start menu. You can also change the way a user logs on or off. The procedure in this manual uses the method or view of the Windows XP default setting (not Classic view nor Classic Start menu etc.).
- **Resetting the password**
Windows XP has a function to reset a forgotten password. To use this function, you need to create a password reset disk beforehand following the steps below.
 - 1 Connect the USB floppy disk drive (optional: CF-VFDU03) to your computer.
 - 2 Click [start] - [Control Panel] - [User Accounts].
 - 3 Click [Prevent a forgotten password] from [Related Tasks] menu of the account you used to logon and create a password reset disk following the on-screen instructions. Store the password reset disk in a safe place.
 - Only the logon password for each account can be reset. The password set in the Setup Utility cannot be reset.

Starting Up/Shutting Down

Starting Up

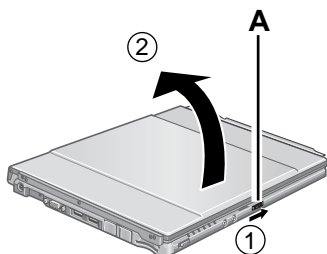

1 Open the display.



- ① Slide the latch (A) located at the front.
- ② Lift open the display.

CAUTION

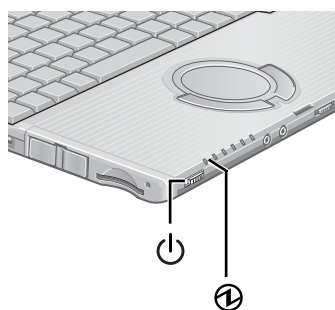
- Do not open the display wider than necessary (160° or more).
- Do not apply excessive pressure to the LCD. Also, do not hold the LCD when opening or closing the display.





2 Turn your computer on.

Slide the power switch  and hold it for approximately one second until the power indicator  turns on before releasing it.

CAUTION

- Do not slide the power switch and hold it for more than four seconds; this will cause the power to be turned off forcibly.
- While booting, avoid the following until the hard disk drive indicator  has turned off.
 - Connecting or disconnecting the AC adaptor.
 - Touching the power switch.
 - Performing any keyboard, touch pad, touchscreen or external mouse operations.
 - Closing the display.
- Do not slide the power switch repeatedly.
- Once the computer is powered off, you must wait at least ten seconds before powering it on again.
- When the CPU temperature rises, the computer may not power on to prevent the CPU from overheating. Should this happen, allow the computer to cool down then switch the power on again.
If the computer still does not power on, contact your technical support office.
(☞ page 45)

3 Log on to Windows.

After confirming that the hard disk drive indicator  has turned off, select the user and input the password, then select . Until the correct password is entered, the computer will not operate.

4 Select your application.

You are able to start working on your computer.

NOTE

- The power saving function is factory set, so if there is no input from a key, the touch pad, touchscreen or an external mouse (when one is connected) for a certain interval of time, the power to the LCD and hard disk may be turned off. The LCD will resume operation when the touch pad, touchscreen or an external mouse (when one is connected) is used or a key is pressed.
The power to the LCD may be turned off even when an application software is being installed. In this case, because it is conceivable that a selection dialog box will be shown, do not press **Space** or **Enter** to attempt to resume from this condition as doing so may trigger a selection, but instead, press a key unrelated to the direct triggering of a selection, like **Ctrl**.
In addition, when the computer is left alone, it automatically enters the standby or hibernation mode (☞ Reference Manual “Standby/Hibernation Functions”). The computer will resume by sliding the power switch.
- You may hear a mechanical “click” shortly after the hard disk indicator has turned off when there has been no input from a key or device operation, when the computer enters the standby or hibernation mode, or when Windows is shut down. This is the sound of the head shifting positions, to reduce power consumption or to protect the hard disk from shocks. This sound does not indicate a malfunction.

Enter Password

● If the screen on the left is displayed immediately after you turn on the power...

A password has been set to ensure the computer's security.

Enter your password*¹ and press **Enter**. (☞ Reference Manual “Security Measures”)

- When the correct password is input, the computer will start.
- When three incorrect password attempts or nothing is input for one minute, the computer will power off.

*¹ Supervisor Password or User Password set in the Setup Utility (not the Windows password).

How to Use the Hand Strap

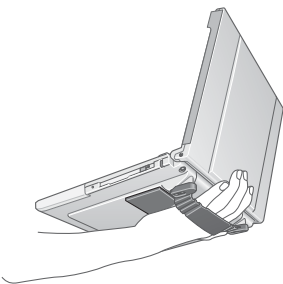

The hand strap is convenient for computing while standing.

To carry the computer, put your hand between the computer and the hand strap to prevent it from falling, and firmly hold the computer when using it.

Starting Up/Shutting Down

Shutting Down (power off your computer)

1 Save important data and close each application.





2 Click [start] - [Turn Off Computer].

3 Click [Turn Off].

Your computer will power off automatically.

- Restarting your computer (without shutting down):
Click [Restart].

- To shut down using the keyboard:

Press , **U**, and select [Turn Off] with    , then press **Enter**.

CAUTION

- Do not do the following during the shutdown/restart procedure.
 - Connecting or disconnecting the AC adaptor.
 - Touching the power switch.
 - Performing any keyboard, touch pad, touchscreen or external mouse operations.
 - Closing the display.

- **When you leave the computer or interrupt your work...**



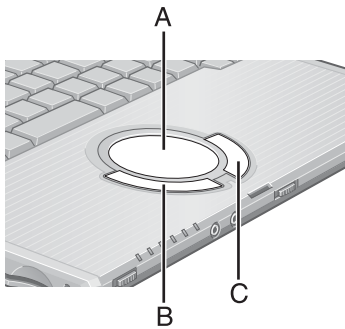

If you use the “Standby” or “Hibernation” function, then when you turn on the power next time, the application software and files you were using before will be displayed, and you can restart the same operations. (☞ Reference Manual “Standby/Hibernation Functions”)

Touch Pad

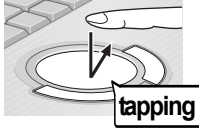
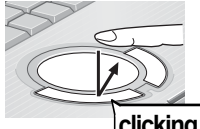
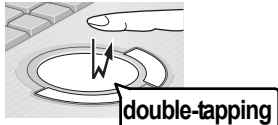

Use the touch pad to move the cursor on the screen and perform computer operations.

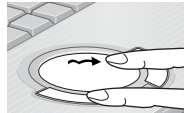
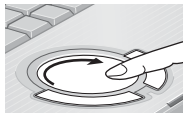
- A. Work Surface (Touch Pad)
- B. Left Button
- C. Right Button

Function	Operation
Moving the Cursor	 <p>Move the tip of your finger lightly over the work surface.</p>
Tapping/Clicking	 <p>tapping</p> <p>or</p>  <p>clicking</p> <p>To right-click: Can only be performed by clicking the right button.</p>
Double-Tapping/ Double-Clicking	 <p>double-tapping</p> <p>or</p>  <p>double-clicking</p>
Dragging	 <p>Two quick taps, but on the second tap leaving your finger down (applying pressure) and moving it on the work surface.</p> <p>or</p>  <p>While holding down the button, moving your finger on the work surface.</p>
Vertical Scroll	 <p>or</p>  <p>Trace a circle around the touch pad.</p>
Horizontal Scroll	<p>Trace a circle around the touch pad. (☞ <small>Reference Manual</small> "Using the Touch Pad")</p> <p>The setup is required before using this function. (☞ <small>Reference Manual</small> "Using the Touch Pad")</p>

Operation

NOTE

- Refer to [Mouse Properties] for information on basic operations other than the above. To display [Mouse Properties], click [start] - [Control Panel] - [Printers and Other Hardware] - [Mouse].
- When using the touch pad, keep the following in mind.
 - By design the touch pad is to be used with a finger tip only. Do not place any object on the work surface or press down forcefully with sharp-pointed objects (e.g., nails) or hard objects that can leave marks (e.g., pencils and ball point pens).
 - Try to avoid having any harmful substances, such as oil, come in contact with the touch pad. The cursor may not work properly in such cases.

Reference Manual

Reference Manual / Important Tips

Contents of the Reference Manual

- Reference Manual (Cover)
- Chapter 1: About the Reference Manual
 - Read Me First
 - How to Use this Reference Manual
- Chapter 2: Getting Started (Basic Operation)
 - Using the Touch Pad
 - Using the Touchscreen
 - Display Rotation
 - Using the Fn Key
 - Confirm the Status Using the LEDs
 - Battery Power
 - Computing on the Road
 - Standby/Hibernation Functions
 - Security Measures
- Chapter 3: Using Cards and Peripheral Devices
 - PC Cards
 - SD Memory Card/MultiMedia Card
 - SD Memory Card Security Function
 - External Display
 - USB Devices (External Mouse etc.)
 - Printer
- Chapter 4: Communications
 - Modem
 - LAN
 - Wireless LAN
- Chapter 5: Changing for the Computer's Status
 - Setup Utility
 - Icon Enlarger
 - Loupe Utility
- Chapter 6: Troubleshooting
 - Problems with Starting Up, Shutting Down, and Standby and Hibernation Mode
 - Problems with Passwords and Messages
 - Problems with Operation during Use
 - Problems with Battery
 - Problems with Cursor
 - Problems with Display
 - Problems with Notification Area
 - Problems with Input
 - Problems with Disk
 - Problems with Sound
 - Problems with Peripherals
 - Problems with General Network
 - Problems with Wireless LAN
 - Check the Computer's Usage Status
 - Information for Installed Applications
- Chapter 7: Important Information
 - Protecting Your Computer from Viruses
 - To Update this Computer to its Latest Version
- Chapter 8: Useful Information
 - Windows-related Information
 - To View the System Configuration (CMI Viewer)
 - Glossary

The Reference Manual and the Important Tips can be accessed on your computer. When a printer is connected, these manuals can also be printed.

● Reference Manual

The Reference Manual explains functions for you to make greater use of the computer, such as how to add peripheral devices, how the Setup Utility works, and other useful information.

● How to access the Reference Manual

Click [Reference Manual] in [start].

● Important Tips

Important Tips provides information on how to maximize use of the battery pack, which is necessary for computing away from your home or office.

It also offers helpful explanations on how to use the touchscreen more effectively.

● How to access the Important Tips

Double-click  on the desktop.

Important Tips can also be accessed from [start] - [All Programs] - [Panasonic] - [On-Line Manuals] - [Important Tips].

When the Reference Manual or Important Tips is accessed for the first time, the License Agreement of the Adobe Reader may be displayed. If it is displayed, after reading the agreement, click [Accept] to access the Reference Manual or Important Tips.

Refer to Adobe Reader Help to use the Adobe Reader.

NOTE

- Illustrations may be difficult to view depending on the magnification. If the illustration is too small, magnify the display.
- If a printer is connected, we recommend printing the pages required. The illustrations and display samples may not be printed with a high quality.

RAM Module

Use a RAM module meeting the RAM module specifications below. If a module is used that does not meet the specifications, there are cases in which data may become unusable or the computer may not operate properly.

- RAM module specifications: (☞ page 43)
172 pins, Micro DIMM, 2.5 V, DDR SDRAM, PC2100
Contact your technical support office to confirm recommended RAM module.
Do not use non-recommended RAM modules. Non-recommended RAM modules may not operate properly, and may cause damage to your computer. Some non-recommended RAM modules may overheat, causing the cover to warp.
- Matsushita Electric Industrial Co., Ltd. shall bear no responsibility whatsoever for failures or damage caused by the use of non-recommended RAM modules, or by incorrect installation or removal of such modules. Before installing a RAM module, confirm the product type and the correct installation method.

CAUTION

- RAM modules are extremely sensitive to static electricity. There are cases where static electricity generated by the human body has adversely affected such modules. When inserting or removing a RAM module, do not touch the terminals or internal components, insert objects other than the module, or allow foreign particles to enter. Doing so has been known to cause damage, fire or electric shock.

Inserting / Removing the RAM Module

CAUTION

- If the RAM module is difficult to insert or difficult to press down, do not force it. Check once more to ensure that the module is positioned correctly.
- Use the proper size screw driver to insure that the screw does not get stripped.

1 Power off your computer. (☞ page 18)

Do not shut down using the standby or hibernation function.
Disconnect the AC adaptor.

2 Turn the computer over and remove the battery pack and the screw (A), then remove the cover (B). (☞ page 9)

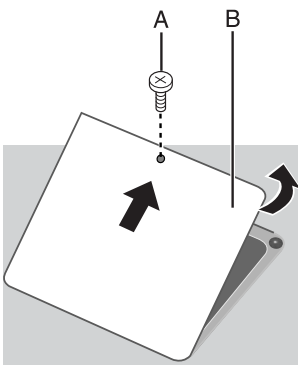

3 Insert/Remove RAM module.

- Inserting the RAM module
 - ① Check direction of a RAM module (C).
Hold the RAM module in the direction that the notch (E) of the RAM module suits to the protrusion (D) of the slot.

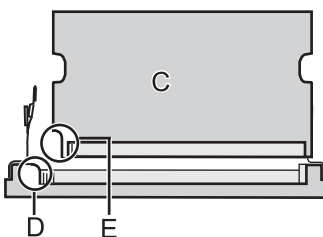

RAM Module

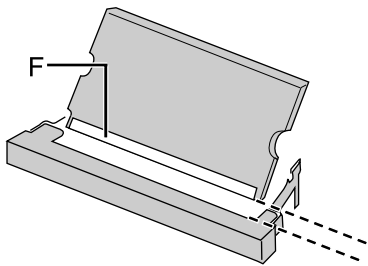

- ② Place the RAM module lightly in parallel with a slot.
(The gold terminals (F) are visible)

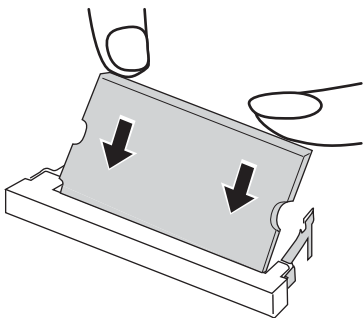
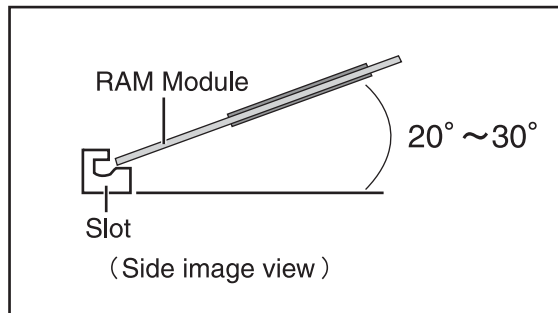

- ③ Insert the module parallel to the slot and press firmly until the gold terminals are no longer visible.
- The slot may be damaged if the following procedure is performed without inserting the module firmly.

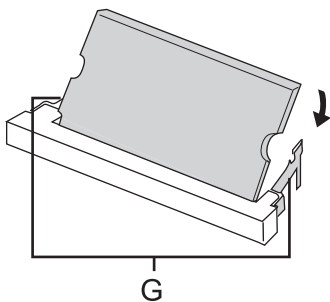

- ④ Press the RAM module down until the right and left hooks (G) lock into place.
- When pressing down the module, the right and left hooks will open slightly and will return after locking.

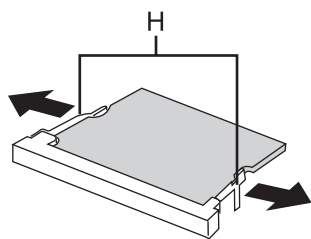

- Removing the RAM module
- ① Gently open the left and right hooks (H).
The RAM module will be raised at an angle.

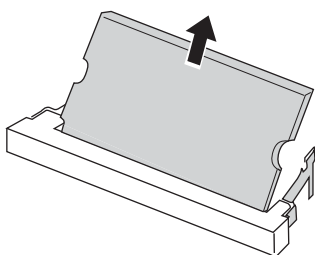

- ② Gently remove the RAM module from the slot.

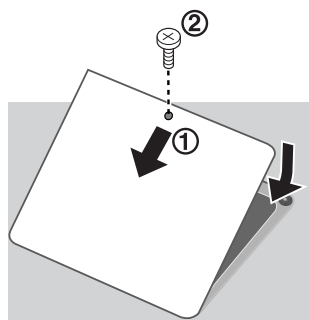

4 Put the cover back in place.

- ① Insert the cover at an angle, then fit it into place.
- ② Fasten the screw.

NOTE

- If the RAM module has not been inserted properly, or if a RAM module other than one matching the specifications has been inserted, a beep will sound and the message “Extended RAM Module Failed” will be displayed when turning the power on. In this case, turn the power off, confirm that the RAM module meets the specifications, and reinsert it.
- Whether the RAM module is properly recognized or not can be confirmed in [Information] menu of the Setup Utility ( Reference Manual “Setup Utility”).

Useful Information

Usage Environment

● Environment

- Place the computer on a flat stable surface. Do not place the computer upright or allow it to tip over. When the computer receives extremely strong shock after falling, the hard disk may become inoperable.
- Operation: Temperature: 5 °C to 35 °C {41 °F to 95 °F}
Humidity : 30% to 80% RH (No condensation)
- Storage: Temperature: -20 °C to 60 °C {-4 °F to 140 °F}
Humidity : 30% to 90% RH (No condensation)

Even within the temperature and humidity ranges noted above, using the computer for long periods of time in an environment with exceptionally low or high temperatures or high humidity may result in deterioration of the product, which can lead to a reduction in product life.

● Places not to use your computer

- Such areas may result in damage to the computer.

Areas with electronic equipment

These areas may interfere with your display or cause your computer to produce strange sounds.

Areas with extremely high/low temperatures

- Do not leave things near the computer that are sensitive to heat. During operation, the computer may become warm.

Handling

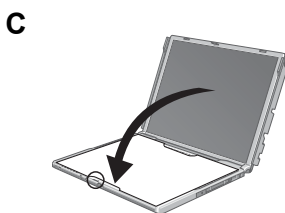
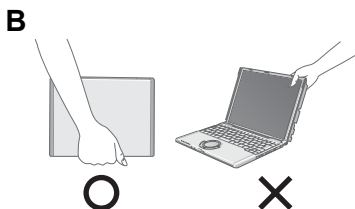
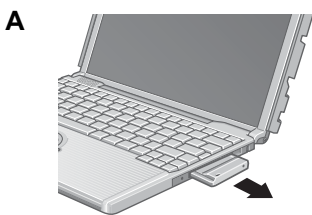

This computer has been designed so as to minimize shock to the LCD and hard disk drive, etc., but no warranty is provided against such trouble. Therefore, as a precision instrument, be extremely careful when handling.

When carrying the computer, be sure to keep to the following:

- Turn off the computer.
- Remove all external devices, cables, PC Cards protruding from the computer (see figure A), SD memory cards, and MultiMedia Cards before transporting the computer.
- Close the display, and ensure that the latch is positioned correctly in the slot.
- Do not carry the computer by gripping the display or the cabinet around the display (see figure B).
- Lay the carrying cloth that comes with the computer across the keyboard (see figure C), and close the display gently. When closing the display, take care to ensure that the carrying cloth does not get caught in the panel switch, and check that the latch on the computer body (☞ page 12) is properly aligned.
- Do not drop or hit the computer against solid objects.
- If the computer is being carried in a soft bag when the battery pack has been removed, be careful to avoid undue pressure on the body of the computer in a crowded place, etc., as this may result in damage to the LCD.
- When taking an airplane, always carry your computer with you. Never check it in with luggage. Before using the computer inside an airplane, we recommend asking the airlines regarding their policy on this issue.
- When transporting a spare battery pack inside a package, briefcase, etc., it is recommended that it be placed in a plastic bag in order to protect its contacts.

We recommend the following:

- Preparing a fully charged battery pack.
- Making backup copies on disks and carrying them with you.

Maintenance

Display (LCD)

Use the soft cloth included with the computer. (For more information, refer to “Suggestions About Cleaning the LCD Surface” that comes with the soft cloth.)

If the Protective Film becomes damaged, it may be time to replace your Protective Film. The Protective Film is a disposable item. To find out the model number of your Protective Film, contact your technical support office. (For more information, refer to the “Operating Instructions” that come with the Protective Film.)



When areas excluding the display/the touch pad become dirty:

Wipe these areas with a soft cloth, after applying water or detergent diluted with water to the soft cloth and firmly wringing out excess water.

CAUTION

- Do not touch or use a touchscreen before you re-attach a Protective Film, as you may leave a mark or a scratch on the touchscreen.
- Do not use benzene, thinner, or rubbing alcohol. Doing so may adversely affect the surface, e.g., discoloration. In addition, do not use commercially-available household cleaners and cosmetics, as they may contain components harmful to the surface.
- Do not directly add or spray water or detergent. If liquid enters the inside of the computer, it may cause it to work improperly or be damaged.

Saving Data on the Hard Disk

- **Do not expose your computer to shock.**
Use care when handling your computer, shock may damage your hard disk or make your software applications and data unusable.
- **Do not power off your computer while software applications are running or hard disk drive indicator  is on.**
Properly shut Windows down to avoid problems.
- **Save all valuable data to disks.**
Backing up data to disks will limit damage should trouble occur to your computer or should you inadvertently change or erase data.
- **Use the security function for all important data.** ( Reference Manual “Security Measures” and “SD Memory Card Security Function”)

Hard Disk Lock

When the Hard Disk Lock is set to [Enable], it is impossible to read/write data from/to the hard disk when the hard disk is installed in a different computer. When the hard disk is returned to the original computer, you can read/write data as before. In this case, however, make the settings in the Setup Utility exactly the same as they were before the hard disk was removed. (Note that this Hard Disk Lock does not guarantee the complete protection of data.) ( Reference Manual “Security Measures”)

When Using Peripheral Devices

Pay strict attention to the following points to avoid damage to the computer, peripheral devices, cables, etc. Also, in addition to following this manual and the Reference Manual, carefully read the instruction manuals for the peripheral devices being used.

- Use only peripheral devices that conform to the computer’s specifications.
- Connect the devices properly, paying close attention to the condition and position of the connectors.
- If a connection cannot be made easily, do not apply undue force; check once more to confirm the condition and position of the connector (alignment of pins, etc.) .
- If the connector has holding screws, fasten the screws firmly.
- Do not carry the computer with cables attached, and do not pull on the cables forcefully.

When Disposing of or Transferring Ownership of This Device

When disposing of or transferring ownership of this device, erase all data on the hard disk in order to prevent the theft of hard disk data. Even if you delete data or initialize the hard disk through normal Windows commands, data can still be read using special software. In order to erase all data, either have the data erased by a specialist (at a charge) or use the hard disk data erase utility (included) ( page 42). (Note that this hard disk data erase utility does not guarantee that data will be completely erased.)

Also, note that if you transfer ownership of this device without deleting commercial software that you have installed to the hard disk, you may be in violation of the licensing agreement for that software.

Useful Information

When Changing Hard Disk Partitions

When using the hard disk backup function, divide the hard disk into partitions when a backup area is created (☞ page 38). If you divide the hard disk into partitions before creating the backup area, the backup area cannot be created.

Security of the Computer

Use the Windows Security Center function to protect Windows from damage by computer viruses, etc.

Windows Security Center

● What is Windows Security Center?

The Windows Security Center allows centralized management of Windows security information, and monitors antivirus measures and other Windows security settings to ensure optimum safety.

Use the Windows Security Center function to protect your computer from damage by viruses, etc.

Click [start] - [Control Panel] - [Security Center] to display the current settings for the following security functions.

● Windows Firewall

A security system for protecting the computer from unauthorized access via the Internet or other external networks.

The firewall regulates the data exchanged between the computer and the external network, so that only approved data can pass through.

At the time of purchase, the Windows Firewall is set to be enabled.

● Automatic Updates

If your computer is connected to the Internet, this function regularly checks whether security updates and other important updates for Windows have been made available, and automatically installs these updates in their latest conditions.

● Virus Protection

This function regularly checks whether antivirus software has been installed in the computer, and whether the version of that software is the latest version available.

NOTE

- Some network-related software and some online network games do not operate normally if the Windows Firewall is enabled. Ask the software manufacturer about the Windows Firewall in the case of using such software.
- For further details on the Windows Firewall, see the help displayed by the following methods:
 - ① Click [start] - [Help and Support] and input [Windows Firewall] into [Search].
 - ② Click [Windows Firewall overview].

If the message "Your computer might be at risk" is displayed

Read the message, click the 🚫 (red) on the notification area, and make the appropriate settings.

This message, which the Windows Security Center displays to confirm the security-related settings regularly, will be displayed until the settings are made more properly.

NOTE

- This message does not indicate an error. You can use the computer while the message is displayed. However, in order to operate the computer more safely, we recommend making the appropriate measures to reduce damage from virus and other attacks, thus avoiding the appearance of this message.

The Pop-up Blocker

In Windows XP, security functions have been strengthened with regard to Web contents.

One of these is the "Pop-up Blocker," which may prevent some Web pages from being displayed.

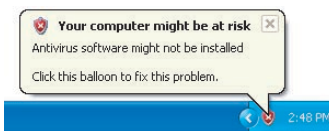
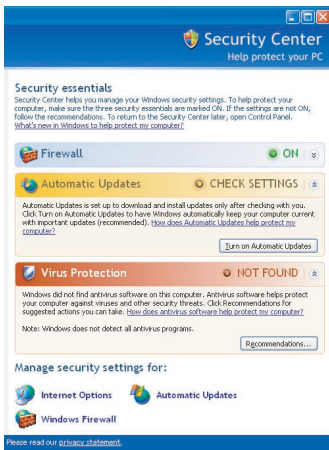

Computer Viruses

Users are advised to purchase the latest versions of virus protection software and use them regularly.

We recommend you run the software:

- When booting your computer.
- After receiving data.

We recommend that you check data received on disks or from external sources, such as data downloaded from the Internet, e-mail, etc. (For compressed files, uncompress them before running a check).





Windows Update

You can use the latest patches and service packs for Windows with the following menus.

Do not apply "Driver Updates" even if a message to update a driver appears. If a driver update is required, contact your technical support office (☎ page 45).



[start] - [All programs] - [Windows Update].



Wireless LAN

- **To prevent theft of data or unauthorized access to the hard disk via a wireless LAN.**
If you plan to use wireless LAN functions, we recommend that you do so only after making the appropriate security settings, such as for encryption.
- **For instructions on settings for wireless LAN and cautions during use, click [start]-[Reference Manual], and refer to "Wireless LAN".**
- **Before using a wireless LAN, turn the wireless LAN on using the following method (at the time of purchase, the wireless LAN is set to [Wireless Off]).**
 - 1 Double-click  (When the wireless LAN is off) on the notification area.
 - 2 Click  and click [Wireless On].
The icon will turn to  (yellow icon) /  (red icon) /  (green icon).
- Do not use wireless LAN on airplanes, in hospitals, or in other locations where wireless LAN signals may affect the operation of devices in the vicinity.
Abide by instructions regarding use in airplanes and hospitals.

Enable/disable wireless LAN standard IEEE802.11a (802.11a)

In some countries, communication using IEEE802.11a (5 GHz wireless LAN) standard is restricted by law. Comply with the laws in the country concerned. (☎ page 3)

- 1 Click the  icon (when the wireless LAN is on) or the  icon (when the wireless LAN is off) on the notification area.
- 2 To disable 802.11a:
 - Click [Disable 802.11a].To enable 802.11a:
 - Click [Enable 802.11a].

Even when 802.11a is enabled or disabled,  or  will not change.

List of Error Codes

When turning on the computer, if one of the following error codes or messages is displayed, follow the instructions shown below. If the problem persists, or if the error code or message displayed is not shown here, contact your technical support office (☎ page 45).

Error Code/Message	Action
0211: Keyboard error	<ul style="list-style-type: none"> ● If an external keyboard is connected, disconnect these devices.
0251: System CMOS checksum bad - Default configuration used	<p>An error has occurred in the memory that stores the Setup Utility settings. This error occurs when the memory content is changed through some inadvertent operation by a program or other function.</p> <ul style="list-style-type: none"> ● Run the Setup Utility and load the default values, then change the settings to the appropriate values as needed. ● If the problem persists, the internal clock battery may need to be replaced. Contact your technical support office.
0271: Check date and time settings	<p>The date and time setting are incorrect.</p> <ul style="list-style-type: none"> ● Run the Setup Utility and set the date and time correctly. ● If the problem persists, the internal clock battery may need to be replaced. Contact your technical support office.
0280: Previous boot incomplete - Default configuration used	<p>Startup has failed repeatedly, so the Setup Utility settings have been returned to their default values, and the computer has been booted.</p> <ul style="list-style-type: none"> ● Run the Setup Utility and load the default values, then change the settings to the appropriate values as needed.
Press <F2> to Setup	<ul style="list-style-type: none"> ● Write down the error details and press (F2) to run the Setup Utility. Confirm the settings, and change the settings to the appropriate values as needed.
Operating System not found	<p>The OS is not properly installed on the floppy disk or the hard disk that you are trying to boot from.</p> <ul style="list-style-type: none"> ● If the computer cannot be booted from the floppy disk, check the floppy disk drive to ensure that the disk is in fact bootable, and change it to another if not. ● If the computer cannot be booted from the hard disk, confirm whether the hard disk is properly recognized in [Information] menu of the Setup Utility. <ul style="list-style-type: none"> • If the hard disk is recognized, perform the reinstallation procedure. • If not, contact your technical support office. ● If a device is connected to the USB port, disconnect the device, or run the Setup Utility and set [Legacy USB Support] in [Advanced] menu to [Disable].
Extended RAM Module Failed	<ul style="list-style-type: none"> ● If the RAM module has not been inserted properly, or if a RAM module other than one matching the specifications has been inserted, a beep will sound and the message “Extended RAM Module Failed” will be displayed when turning the power on. In this case, turn the power off, confirm that the RAM module meets the specifications, and reinsert it.

● How to run the Setup Utility

- 1 Restart the computer.
- 2 Press **(F2)** while [Panasonic] boot screen is displayed soon after the computer begins the startup procedure.

Dealing with Problems (Summary)

When a problem occurs, refer to this page. The “Reference Manual” also contains detailed information. If a problem appears to be related to a software application, read the software related manual. If you still cannot troubleshoot the problem, contact your technical support office (☞ page 45). You can use the PC Information Viewer to check the computer’s usage status. (☞ ^{Reference Manual} “Troubleshooting”)

● Starting Up

The power indicator or battery indicator is not lit	<ul style="list-style-type: none"> ● Check the cable connection for the AC adaptor. ● Check to see if a fully charged battery is properly inserted. ● Remove the battery pack and disconnect the AC adaptor, then connect them again.
The computer does not operate when a USB device is connected	<ul style="list-style-type: none"> ● The computer may not operate when certain USB devices are connected. Disconnect the USB device, or set [Legacy USB Support] to [Disable] in the [Advanced] menu of the Setup Utility.
[Enter Password] is displayed	<ul style="list-style-type: none"> ● Input your Supervisor Password or User Password. If you have forgotten it, contact your technical support office (☞ page 45).
POST Startup Error(s) is displayed	☞ page 28
Windows startup, or an operation is extremely slow	<ul style="list-style-type: none"> ● Press (F9) in the Setup Utility (☞ ^{Reference Manual} “Setup Utility”). This will restore the Setup Utility’s settings to their default values (except the password settings, System Date, and System Time). Then, the Setup Utility must be run once again for you to input the appropriate operating environment settings. (The processing speed depends on the application software used, so this operation may not cause the processing speed to increase.) ● If operations slow down during streaming playback, try changing the number of colors of the display. ● If you install resident software after purchasing this computer, disable that resident software.
The date and time are incorrect	<ul style="list-style-type: none"> ● You can set the date and time using the following menu: [start] - [Control Panel] - [Date, Time, Language, and Regional Options] - [Date and Time] ● If you continue to experience problems, the internal battery maintaining the clock may need to be replaced. Contact your technical support office (☞ page 45). ● When the computer is connected to a LAN, confirm the date and time of the server. ● This computer will not correctly recognize the date and time starting from the year 2100 A.D.
When resuming from the standby or hibernation mode, [Enter Password] does not appear even if a password has been set in the Setup Utility	<ul style="list-style-type: none"> ● Even when a password has been set in the [Security] menu of the Setup Utility, [Enter Password] does not appear when the computer resumes from the standby or hibernation mode. If you want to use the security function when using the standby or hibernation mode, use the Windows password as follows: <ol style="list-style-type: none"> 1 Click the account to change in [start] - [Control Panel] - [User Accounts] and set the password. 2 Add the check mark for [Prompt for password when computer resumes from standby] in [Control Panel] - [Performance and Maintenance] - [Power Options] - [Advanced].
When “Remove disks or other media. Press any key to restart” (or a similar message) is displayed	<ul style="list-style-type: none"> ● This means a floppy disk that does not contain system startup information has been left in the floppy disk drive. Remove the floppy disk, and press any key. ● This message may appear when certain USB devices are connected. Remove the USB device, or set [Legacy USB Support] in the [Advanced] menu of the Setup Utility to [Disable]. ● If the message still appears even after trying the above measures, this may be an indication that some type of hard disk failure has occurred. Contact your technical support office.
When the administrator password is forgotten	<ul style="list-style-type: none"> ● If you have created a password reset disk (☞ page 15), a message is displayed when you fail to correctly enter the password. Follow the message’s instructions and set the password again by using the password reset disk. If you have not created a password reset disk, after reinstalling, setup Windows and then set the password again.

Dealing with Problems (Summary)

Starting Up (continued)

<p>When the previous item is not the cause</p>	<ul style="list-style-type: none"> ● Press (F9) in the Setup Utility (☞ <small>Reference Manual</small> “Setup Utility”). This will restore the Setup Utility’s settings to their default values (except the password settings). ● Try removing all peripheral devices. ● Check a disk error using the following procedure. <ol style="list-style-type: none"> 1 Display [Local Disk (C:) Properties]. Click [start] - [My Computer], right-click [Local Disk(C:)] and click [Properties]. 2 Click [Tools] - [Check Now]. 3 Click [Start] after selecting required items in [Check disk options]. ● At startup, hold down (F8) when [Panasonic] boot screen disappears*¹, and release your finger when the Windows Advanced Option Menu is displayed. Start the computer in Safe Mode, and confirm the details of the error. <p style="margin-left: 20px;">*¹ When [Password on boot] is set to [Enable], [Enter Password] appears after the [Panasonic] boot screen disappears. Hold down (F8) soon after inputting the password and pressing (Enter).</p>
---	--

Display

<p>No display after powering on</p>	<ul style="list-style-type: none"> ● When there is no display to an external display, <ul style="list-style-type: none"> • Check your cable connection to the external display. • Confirm your display is powered on. • Check the settings for your external display. ● The display destination may be set to the external display. Try changing the display destination by pressing (Fn) + (F3). If you want to switch the display destination repeatedly by pressing (Fn) + (F3), make sure that the display destination has switched completely each time before pressing (Fn) + (F3) again. ● Press (Fn) + (F2) and adjust the brightness.
<p>The power has not been turned off, but after a certain period of time, there is no display</p>	<ul style="list-style-type: none"> ● Has the computer been set to the power-saving mode? To resume operation of your computer from the condition the power of the display is off (for energy conservation purposes), press any key unrelated to the direct triggering of a selection, like (Ctrl). ● To save power, your computer may have automatically entered the standby mode (power indicator blinks green) or hibernation mode (power indicator turns off). In such cases, slide the power switch.
<p>When the battery pack is used, the screen is darker than when the AC adaptor is connected</p>	<ul style="list-style-type: none"> ● Press (Fn) + (F2) and adjust the brightness. Note, however, that when the brightness is increased, the battery running time will become shorter. Brightness can be set to separate levels for when the AC adaptor is connected and when it is disconnected.
<p>An afterimage appears (e.g., green, red, and blue dots remain on the display) or there are dots not displaying the correct colors</p>	<ul style="list-style-type: none"> ● If an image is displayed for a prolonged period of time, an afterimage may appear. This is not a malfunction. The afterimage will disappear when a different screen is displayed. ● High-precision and advanced technologies are necessary for the production of color liquid crystal displays (color LCDs). Therefore, if 0.002% or less of the picture elements either fail to light or remain constantly lit (that is, more than 99.998% of elements are functioning properly). This is not considered a defect.
<p>The screen becomes disordered</p>	<ul style="list-style-type: none"> ● The screen display may become distorted if the resolution or number of colors is changed, or if an external display is connected or disconnected while the computer is operating. Restart the computer.

● Display (continued)

<p>The external display no longer displays properly</p>	<ul style="list-style-type: none"> ● When an external display not compatible with the power saving mode is used with the computer, the display may not function correctly when the computer enters the power saving mode. In such cases, turn off the power to the external display. However, in the case of some external displays, the screen display may be distorted or the mouse cursor may not be properly displayed depending on the settings. In this case, try setting the number of colors, screen area (resolution), and refresh rate to smaller values.
<p>When you want to display the fonts or icons at a larger size</p>	<ul style="list-style-type: none"> ● Change the size of the icons, etc. using “Icon Enlarger” (Reference Manual “Icon Enlarger”). ● You can also change the settings as follows (for more details, refer to the Windows Help). <ol style="list-style-type: none"> 1 Click [start] - [Control Panel] - [Appearance and Themes] - [Display] - [Appearance]. 2 Select the font size in [Font size], and click [Effects] and then add the check mark for [Use large icons] to increase the icon size. 3 Click [OK], then click [OK]. ● To enlarge a part of the screen, use Loupe Utility (Reference Manual “Loupe Utility”).
<p>When an MPEG file is being played with or Windows® Media Player, the display destination cannot be switched using (Fn) + (F3)</p>	<ul style="list-style-type: none"> ● The display destination cannot be switched while a video such as an MPEG file is playing. Stop playing the video before switching the display destination.
<p>During simultaneous display, if one of the screens malfunctions</p>	<ul style="list-style-type: none"> ● Try changing the display by pressing (Fn) + (F3). ● If you continue to experience problems, try changing the display destination as follows: [start] - [Control Panel] - [Other Control Panel Options] - [Intel(R) Extreme Graphics] - [Devices] ● When [Command Prompt] is set to “Full Screen” by pressing (Alt) + (Enter), the screen is displayed on one of the displays only. When the window display is restored by pressing (Alt) + (Enter), the screen is exhibited on both displays. ● Simultaneous display cannot be used until Windows startup is complete (during Setup Utility, etc.). When (Fn) + (F3) is pressed, the screen is displayed on the external display or internal LCD.
<p>The notification area icons on the bottom right of the screen are hidden and cannot be seen</p>	<ul style="list-style-type: none"> ● Click the  icon on the notification area to display the hidden icons. ● If you want all icons to be displayed constantly, right-click on the notification area, click [Properties], and remove the check mark from [Hide inactive icons] in [Taskbar].

● Shutting Down

<p>Windows cannot be shut down or restarted</p>	<ul style="list-style-type: none"> ● If a USB device is connected, try removing it.
---	--

● Standby / Hibernation Function

<p>Unable to enter standby or hibernation mode</p>	<ul style="list-style-type: none"> ● If a USB device is connected to the computer (note: only for some USB devices), remove the USB device temporarily. If the problem persists, restart the computer. ● It may take a minute or two to enter standby or hibernation mode. ● The computer may not enter standby mode properly and seems to be frozen in the case that the computer is communicating via the modem. When you cannot execute operations, slide the power switch for four seconds or more to forcibly turn your computer off.
<p>Unable to automatically enter standby or hibernation mode</p>	<ul style="list-style-type: none"> ● If a peripheral is connected to the computer, disconnect the device. ● When the internal LCD is closed, the computer may not enter standby or hibernation mode. In order to activate standby or hibernation automatically while using the computer with the internal LCD closed, set the [Touch Pad] to [Disable] in the [Main] menu of the Setup Utility.

Dealing with Problems (Summary)

● Standby / Hibernation Function (continued)

The computer does not resume	<ul style="list-style-type: none">● Did you disconnect the AC adaptor or the battery pack while the computer was in standby mode? If the computer's power supply is disconnected while the computer is in standby mode, all unsaved data will be lost.● Did you slide the power switch and hold it for four seconds or more? If you slide the power switch and hold it for four seconds or more, the power will be turned off forcibly. In this case, all unsaved data will be lost.
-------------------------------------	---

● Battery Indicator

The red indicator lights	<ul style="list-style-type: none">● The battery level is very low (the charge is approx. 9% or less). Connect the AC adaptor. You can use the computer when the battery indicator light is orange. If you do not have an AC adaptor, save your data and power off your computer. After replacing the battery pack with a fully charged one, turn your computer on again.
The red indicator blinks	<ul style="list-style-type: none">● Quickly save your data and power off your computer. Remove the battery pack and disconnect the AC adaptor, then connect them again. If the problem persists, contact your technical support office (☎ page 45). The battery pack or charging circuit may be defective.
The orange indicator blinks	<ul style="list-style-type: none">● Battery cannot be recharged temporarily because the internal temperature of the battery pack is outside of the acceptable temperature range for recharging. Once the allowable range requirement is satisfied, charging begins automatically. Your computer can be used normally in this state.

● Reference Manual

The Reference Manual is not displayed	<ul style="list-style-type: none">● Is Adobe Reader installed? If you have uninstalled Adobe Reader, install using the following procedures.<ol style="list-style-type: none">1 Log on to Windows with the administrator authority.2 Click [start] - [Run], input [c:\util\reader\AdbeRdr60_enu_full.exe], then click [OK]. Install Adobe Reader by following the instructions on the screen.3 Update Adobe Reader to its latest version. If your computer is connected to the Internet, start up Adobe Reader and click [Help] - [Updates]. If your computer is not connected to the Internet, click [start] - [Run], input [c:\util\reader\Acro-Reader_6.0.2_Update.exe], then click [OK].
--	--

● Touch Pad

Cannot scroll	<ul style="list-style-type: none">● Confirm that the check mark is added to [Use Touch Pad function] in [start] - [All Programs] - [Panasonic] - [Touch Pad utility settings] - [General settings].● When a screen cannot scroll horizontally, add a check mark for [Use horizontal scroll function] in the [General settings] screen described above, and click [OK].● On screens that can only scroll in one direction, either vertical or horizontal, the scroll function will only work in that direction regardless of the operation of the touch pad. (For example, on a screen that will only scroll horizontally, even if you execute a vertical scroll, the screen will scroll horizontally.)
----------------------	--

● SD Memory Card

Cannot log-on Windows with the SD memory card	<ul style="list-style-type: none">● Windows log-on user name and password are not set in the SD memory card correctly. Enter the Windows user name and password without using the SD memory card. After logging on, set the same user name and the password on the SD memory card and Windows, using one of the following operations.<ul style="list-style-type: none">• Change the setting of the SD memory card side by [SD Card Setup].• Change the setting of the Windows side by [Control Panel].
--	---

● Fast User Switching Function

<p>Some applications may not work properly</p>	<ul style="list-style-type: none"> ● When switching to a different user with the Fast User Switching function, the following problems may occur. <ul style="list-style-type: none"> • Some applications may not work properly. • Key combination with Fn may not work. • It may not be possible to set the settings of the display. • The wireless LAN cannot be used. <p>In this case, log off all users without using Fast User Switching function, and try the operation once more. If the problem persists, restart the computer.</p>
--	--

● RAM Module

<p>You do not know the available RAM module</p>	<p>☞ page 21</p>
<p>Cannot tell whether the RAM module has been correctly installed</p>	<ul style="list-style-type: none"> ● You can check whether the RAM module is recognized using [Information] menu in the Setup Utility. If the RAM module is not recognized, turn the computer off and reinsert the RAM module.
<p>The RAM module has not been recognized</p>	<ul style="list-style-type: none"> ● Make sure the RAM module has been properly inserted. ● Use the RAM module that supports the recommended specifications (☞ page 21).

● Others

<p>No response</p>	<ul style="list-style-type: none"> ● Press Ctrl + Shift + Esc to open Task Manager and close the software application which is not responding. ● Is there an input screen (e.g., password input screen at startup) hidden behind another window? Use the Alt + Tab key to check for other windows being displayed. ● After shutting down by sliding the power switch for more than four seconds, slide the power switch to power on and open the application again. If the program no longer works normally, delete the program using the following menu. [start] - [Control Panel] - [Add or Remove Programs]
<p>When trying to play back video files using Windows® Media Player, the message [Codec required] appears, and the file cannot be played back</p>	<ul style="list-style-type: none"> ● Some video files use a Codec that is not installed as a standard. In these cases, if you play back the video file after connecting to the Internet, the Codec may be downloaded automatically, allowing you to play back the file.
<p>Cannot operate Fn key</p>	<ul style="list-style-type: none"> ● In the [Main] menu of the Setup Utility, is [Fn / Ctrl key] set to [Replace]? Return the setting to [Normal], or press Ctrl instead of Fn if you want to leave the setting in [Replace].

Reinstalling Software

When reinstallation procedure is performed, the contents of the hard disk will be erased. Be sure to back up any critical data on your hard disk to another media or to an external hard disk before running the reinstallation procedure.

The reinstallation procedure will return the computer to its original condition.

Even if a hard disk backup area has been created, this backup area will be erased, and all the backed up data will be lost. (This is not the case when Windows is reinstalled in the first partition.)

- If you have created partitions for data, the data may be erased or become corrupt as a result of the reinstallation procedure.

Before Reinstallation

● Preparing

- Product Recovery CD-ROM (included)
- Panasonic DVD-ROM & CD-R/RW drive (optional: CF-VDRRT1M, CF-VDRRT2W, CF-VDRRT3W)

● Important

- Before the reinstallation procedure, remove all peripherals (except for the DVD-ROM & CD-R/RW drive).
- Be sure the AC adaptor is connected until the reinstallation procedure is completed.

Reinstalling

1 Turn off the computer and connect the DVD-ROM & CD-R/RW drive to the computer.

2 Turn on the computer, and press **(F2)** while [Panasonic] boot screen is displayed.

The Setup Utility will start up.

If the password has been set, enter the Supervisor Password.

3 Write down all of the contents of the Setup Utility and then press **(F9)**.

At the confirmation message, select [Yes] and press **(Enter)**.

4 Select [Boot] menu, then select [USB CD/DVD Drive] and press **(F6)** until [USB CD/DVD Drive] is at the top of the [Boot] menu.

5 Place the disc number one of the recovery CDs into the DVD-ROM & CD-R/RW drive.

6 Press **(F10)**.

At the confirmation message, select [Yes] and press **(Enter)**.

The computer will restart and this screen should appear.

```
-----
Select a number
-----
1. [ Recovery ] Reinstall Windows.
2. [ Erase HDD ] Erase the whole data on HDD for security.
3. [ Backup   ] Enable the Backup function.
0. [ Cancel   ] Cancel.
-----
```

<When the hard disk backup function has been enabled>
When the message [The Backup function has been enabled. If [Recovery] or [Erase HDD] is executed, the Backup function will be disabled, and your Backup data will be lost.] appears, press **(Y)**.

7 Press **(1)** to execute [1. [Recovery]].
(You can cancel this operation by pressing **(0)**.)
The License Agreement screen should appear.

8 Press **(1)** to select [1. Yes, I agree to the provisions above and wish to continue!].

This screen should appear.

```
-----
Select a number
-----
Reinstalling : Windows(R) XP Professional

1. Reinstall Windows to the whole HDD to factory default.
2. Make two partitions, for the operating system and data. And reinstall
   Windows to the operating system partition.
   (All existing partitions on HDD will be lost.)
3. Reinstall Windows to the first partition.
0. Cancel
-----
```

9 Make a selection from the menu.

NOTE

- When [2] is selected, the hard disk backup function cannot be enabled because the hard disk has been divided into partitions.

- When selecting [2], enter the basic partition size for the operating system installation and press **(Enter)**.
(The data partition size is the remainder after subtracting the basic partition size.)

- To select [3], the first partition size must be 6 GB or more of the hard disk size. Reinstallation cannot be performed with a small partition size.

<When the hard disk backup function has been enabled>
If you select [1] or [2], the message [The Backup function has been enabled. If [Recovery] is executed, the Backup function will be disabled, and your Backup data will be lost.] appears. In this case, press **(Y)**.

If the message [Computer must be rebooted in order to execute [Recovery.]] appears, press **(R)**.

10 At the confirmation message, press **(Y)**.

The operation of reinstallation for the hard disk starts automatically. (The operations take about an hour.)

CAUTION

- Do not interrupt the reinstallation procedure before completion, for example by turning off the computer or pressing **(Ctrl) + (Alt) + (Del)**, as this may prevent Windows from starting up, or may cause data to be lost so that the reinstallation procedure cannot be executed.
- When a message appears instructing you to insert the next CD, insert the recovery CD showing the next number in the sequence, and then select **[OK]**. If the message [The media does not contain the correct file] appears, select **[OK]**. A message will appear instructing you to insert the next CD. Confirm that the proper recovery CD has been inserted by opening the cover of the DVD-ROM & CD-R/RW drive and then close the cover, then select **[OK]**.

After the reinstallation procedure completes, this screen should appear.

```
-----  
[Recovery] is complete.  
Windows(R) XP Professional install wizard will start after reboot.  
Please remove the Product Recovery CD-ROM.  
After turning off the power, disconnect the CD/DVD-ROM drive, and turn the  
power on again.  
-----
```

11 Remove the recovery CD and press any key to shut down the computer, then remove the DVD-ROM & CD-R/RW drive.

12 Turn on the computer, and press **(F2)** while [Panasonic] boot screen is displayed.
The Setup Utility will start up.
If the password has been set, enter the Supervisor Password.

13 Press **(F9)**.
At the confirmation message, select **[Yes]** and press **(Enter)**. (The Setup Utility settings will return to their default values. Even the security settings with the exception of the password(s) will return to their default values.)

14 Press **(F10)**.
At the confirmation message, select **[Yes]** and press **(Enter)**.

15 Perform the setup procedure for Windows by following the instructions on the screen (☞ page 13 -14).

16 Run the Setup Utility and change the settings where necessary.

17 If you can connect to the Internet, perform Windows Update.

LIMITED USE LICENSE AGREEMENT

THE SOFTWARE PROGRAM(S) (“PROGRAMS”) FURNISHED WITH THIS PANASONIC® PRODUCT (“PRODUCT”) ARE LICENSED ONLY TO THE END-USER (“YOU”), AND MAY BE USED BY YOU ONLY IN ACCORDANCE WITH THE LICENSE TERMS DESCRIBED BELOW. YOUR USE OF THE PROGRAMS SHALL BE CONCLUSIVELY DEEMED TO CONSTITUTE YOUR ACCEPTANCE OF THE TERMS OF THIS LICENSE.

Matsushita Electric Industrial Co., Ltd. (“MEI”) has developed or otherwise obtained the Programs and hereby licenses their use to you. You assume sole responsibility for the selection of the Product (including the associated Programs) to achieve your intended results, and for the installation, use and results obtained therefrom.

LICENSE

- A. MEI hereby grants you a personal, non-transferable and non-exclusive right and license to use the Programs in accordance with the terms and conditions stated in this Agreement. You acknowledge that you are receiving only a LIMITED LICENSE TO USE the Programs and related documentation and that you shall obtain no title, ownership nor any other rights in or to the Programs and related documentation nor in or to the algorithms, concepts, designs and ideas represented by or incorporated in the Programs and related documentation, all of which title, ownership and rights shall remain with MEI or its suppliers.
- B. You may use the Programs only on the single Product which was accompanied by the Programs.
- C. You and your employees and agents are required to protect the confidentiality of the Programs. You may not distribute or otherwise make the Programs or related documentation available to any third party, by time-sharing or otherwise, without the prior written consent of MEI.
- D. You may not copy or reproduce, or permit to be copied or reproduced, the Programs or related documentation for any purpose, except that you may make one (1) copy of the Programs for backup purposes only in support of your use of the Programs on the single Product which was accompanied by the Programs. You shall not modify, or attempt to modify, the Programs.
- E. You may transfer the Programs and license them to another party only in connection with your transfer of the single Product which was accompanied by the Programs to such other party. At the time of such a transfer, you must also transfer all copies, whether in printed or machine readable form, of every Program, and the related documentation, to the same party or destroy any such copies not so transferred.
- F. You may not remove any copyright, trademark or other notice or product identification from the Programs and you must reproduce and include any such notice or product identification on any copy of any Program.

YOU MAY NOT REVERSE ASSEMBLE, REVERSE COMPILE, OR MECHANICALLY OR ELECTRONICALLY TRACE THE PROGRAMS, OR ANY COPY THEREOF, IN WHOLE OR IN PART.

YOU MAY NOT USE, COPY, MODIFY, ALTER, OR TRANSFER THE PROGRAMS OR ANY COPY THEREOF, IN WHOLE OR IN PART, EXCEPT AS EXPRESSLY PROVIDED IN THE LICENSE.

IF YOU TRANSFER POSSESSION OF ANY COPY OF ANY PROGRAM TO ANOTHER PARTY, EXCEPT AS PERMITTED IN PARAGRAPH E ABOVE, YOUR LICENSE IS AUTOMATICALLY TERMINATED.

TERM

This license is effective only for so long as you own or lease the Product, unless earlier terminated. You may terminate this license at any time by destroying, at your expense, the Programs and related documentation together with all copies thereof in any form. This license will also terminate effective immediately upon occurrence of the conditions therefor set forth elsewhere in this Agreement, or if you fail to comply with any term or condition contained herein. Upon any such termination, you agree to destroy, at your expense, the Programs and related documentation together with all copies thereof in any form.

YOU ACKNOWLEDGE THAT YOU HAVE READ THIS AGREEMENT, UNDERSTAND IT AND AGREE TO BE BOUND BY ITS TERMS AND CONDITIONS. YOU FURTHER AGREE THAT IT IS THE COMPLETE AND EXCLUSIVE STATEMENT OF THE AGREEMENT BETWEEN US, WHICH SUPERSEDES ANY PROPOSAL OR PRIOR AGREEMENT, ORAL OR WRITTEN, AND ANY OTHER COMMUNICATIONS BETWEEN US, RELATING TO THE SUBJECT MATTER OF THIS AGREEMENT.

About Intel® software products

The enclosed software products and documentation were developed at private expense, and are provided with “RESTRICTED RIGHTS.” Use, duplication or disclosure by the government is subject to restrictions as set forth in FAR 52.227-14 and DFARS 252.227-7013 et. seq. or its successor. The use of this product by the government constitutes acknowledgment of Intel's proprietary rights in the product.

Contrat de licence d'usage limité

Le(s) logiciel(s) (les "Logiciels") fournis avec ce produit Panasonic® (le "Produit") sont exclusivement concédés en licence à l'utilisateur ultime ("vous"), et ils ne peuvent être utilisés que conformément aux clauses contractuelles ci-dessous. En utilisant les logiciels, vous vous engagez de manière définitive à respecter les termes, clauses et conditions des présentes.

Matsushita Electric Industrial Co., Ltd. ("MEI") a mis au point ou obtenu les Logiciels et vous en concède l'utilisation par les présentes. Vous assumez l'entière responsabilité du choix de ce Produit (y compris des Logiciels associés) pour obtenir les résultats escomptés, ainsi que de l'installation, de l'utilisation et des résultats obtenus.

Licence

- A. MEI vous octroie par les présentes le droit et la licence personnels, non cessibles et non exclusifs d'utiliser les Logiciels conformément aux termes, clauses et conditions de ce Contrat. Vous reconnaissez ne recevoir qu'un droit limité d'utiliser les Logiciels et la documentation les accompagnant et vous vous engagez à n'obtenir aucun droit de titre, propriété ni aucun autre droit vis-à-vis des Logiciels et de la documentation les accompagnant ni vis-à-vis des algorithmes, concepts, dessins, configurations et idées représentés par ou incorporés dans les Logiciels et la documentation les accompagnant, dont les titres, propriété et droits resteront tous à MEI ou à leurs propriétaires.
- B. Vous ne pouvez utiliser les Logiciels que sur le Produit unique qui est accompagné par les Logiciels.
- C. Vous et vos employés ou agents êtes requis de protéger la confidentialité des Logiciels. Vous ne pouvez ni distribuer ni mettre les Logiciels et la documentation les accompagnant à la disposition d'un tiers, par partage de temps ou de quelque autre manière que ce soit, sans l'autorisation écrite préalable de MEI.
- D. Vous ne pouvez ni copier ni reproduire ni permettre la copie ni la reproduction des Logiciels ni de la documentation les accompagnant pour quelque fin que ce soit, à l'exception d'une (1) copie des Logiciels à des fins de sauvegarde uniquement pour soutenir votre utilisation des Logiciels sur le Produit unique qui est accompagné par les Logiciels. Vous ne pouvez ni modifier ni tenter de modifier les Logiciels.
- E. Vous ne pouvez céder les Logiciels et en octroyer la licence à une autre partie qu'en rapport avec votre cession du Produit unique qui est accompagné par les Logiciels à cette autre partie. Au moment de cette cession, vous devez céder également toutes les copies, que ce soit sous forme imprimée ou lisible par la machine, de tous les Logiciels ainsi que de la documentation les accompagnant, à la même partie ou détruire les copies non cédées.
- F. Vous ne pouvez retirer aucune marque de droits d'auteur, marque ou autre ni aucune identification de produit des Logiciels et vous devez reproduire et inclure toutes ces notices ou identifications de produit sur toutes les copies des Logiciels.

Vous ne pouvez assembler en sens inverse, compiler en sens inverse ni retracer les Logiciels ni aucune de leurs copies, de façon électronique ou mécanique, en tout ou en partie.

Vous ne pouvez utiliser, copier, modifier, altérer ni céder les Logiciels ni aucune de leurs copies, en tout ou en partie, à l'exception de ce qui est expressément stipulé dans ce contrat.

Si vous cédez la possession de toute copie ou de tout Logiciel à une autre partie, à l'exception de ce qui est autorisé au paragraphe E ci-dessus, votre licence est automatiquement résiliée.

Termes, clauses et conditions

Cette licence n'est effective que pour la durée de possession ou de crédit-bail du Produit, à moins d'une résiliation antérieure. Vous pouvez résilier cette licence à tout moment en détruisant, à vos frais, les Logiciels et la documentation les accompagnant avec toutes leurs copies, sous quelque forme que ce soit. Cette licence sera également résiliée, avec application immédiate, si les conditions de résiliation définies ailleurs dans ce contrat se sont réalisées ou si vous ne respectez pas les termes, clauses et conditions qui y sont contenues. Au moment de la résiliation, vous acceptez de détruire, à vos frais, les Logiciels et la documentation les accompagnant avec toutes leurs copies, sous quelque forme que ce soit.

Vous reconnaissez avoir lu ce contrat, en avoir compris toute la substance et avoir accepté de respecter ses termes, clauses et conditions. Vous reconnaissez en outre qu'ils sont la description complète et exclusive du contrat conclu entre nous, contrat qui remplace et annule toute proposition ou contrat précédent, écrit ou oral, et toute autre communication entre nous, relativement à l'objet du présent contrat.

Hard Disk Backup Function

The hard disk backup function creates a backup area (storage area) on the hard disk. This area is to back up (store) hard disk contents or restore backed up contents to their original locations.

By backing up the data on your hard disk to a backup area, you can protect your data from loss or damage resulting from operational errors or other factors. Also, you can back up or restore hard disk contents using this computer alone, without having to use other media or peripheral devices.

At the time of purchase, the hard disk backup function is disabled. If you follow the procedure below to create a backup area, the hard disk backup function will be enabled, and you will be able to back up your data. Note, that once the backup function has been enabled, you will have to perform the reinstallation procedure to disable it again (☞ page 34).

The hard disk backup function cannot back up or restore data properly if there is a problem with the hard disk when the data is backed up or restored. Note that if an error occurs while data is being restored, whether as a result of an unexpected malfunction, incorrect operation, or other reason, the data in the hard disk (data before restoration) may be lost.

Matsushita Electric Industrial Co., Ltd. will bear no responsibility for any damages suffered by the user (including loss of data) as a result of the use of this function.

Preparing

- Product Recovery CD-ROM (included)
- Panasonic DVD-ROM & CD-R/RW drive (optional: CF-VDRRT1M, CF-VDRRT2W, CF-VDRRT3W)

Before Using a Hard Disk Backup Function

- Disconnect or remove all peripheral devices (except for the DVD-ROM & CD-R/RW drive), SD memory cards, and MultiMedia Cards. Take care to disconnect the USB floppy disk drive, as the backup area may not be created properly while these devices are connected.
- Be sure the AC adaptor is connected to the computer.
- A backup area cannot be created if the hard disk is already divided into several partitions. Return the computer to its condition at the time of purchase (one partition only), and create the backup area.
- To divide the partition, make the selection when the backup area is created (☞ page 39 step 8).
- If the partition configuration is changed (partitions created, size changed, etc.) after the backup area has been created, it will no longer be possible to execute the backup function. To change the configuration, it is necessary to return the computer to its condition at the time of purchase, and then create the backup area again.
- The hard disk backup function will only work for the internal hard disk. This function does not work with an external hard disk.
- Backup and restore functions will not operate if the hard disk has been damaged.
- Do not use the NTFS file system compression function, as this may result in insufficient capacity of the backup area.
- If the hard disk malfunctions, it will be impossible to read the data stored on it. We recommend that you also back up important data to a location other than the hard disk (an external hard disk or other media).
- Execute a disk error check using the following procedure.
 - 1 Display [Local Disk (C:) Properties].
Right-click [Local Disk(C:)] in [start] - [My Computer], and click [Properties].
 - 2 Click [Check Now] from [Tools].
 - 3 In [Check Disk Local Disk (C:)], click [Start] without adding a check mark beside any of the items.
If a message is displayed indicating that there is an error in the disk, display [Check Disk Local Disk (C:)], and add a check mark for [Automatically fix file system errors] and [Scan for and attempt recovery of bad sectors], click [Start], and check for disk errors again.
- The hard disk backup function does not accommodate dynamic disks. Do not convert the hard disk to a dynamic disk.

NOTE

- Regarding backup area
 - Requires availability of at least half of the entire hard disk. Without sufficient space available, the backup area cannot be created.
 - When the backup area is created, the usable hard disk capacity will be reduced to less than half.
 - The backup area cannot be accessed from Windows. For this reason, backed up data cannot be copied to CD-R or other removable disk media.
 - When the hard disk backup function is executed, data in the backup area will be overwritten. If newly created or edited data is backed up later, data stored previously in the backup area will be lost.

Create a Backup Area

- 1 Turn off the computer and connect the DVD-ROM & CD-R/RW drive to the computer.
- 2 Turn the computer on, and press **(F2)** while [Panasonic] boot screen is displayed. The Setup Utility will start up.
If a password has been set, enter the Supervisor Password.
You cannot register [Boot] menu with a User Password.
- 3 Select the [Boot] menu, then select [USB CD/DVD Drive] and press **(F6)** until [USB CD/DVD Drive] is at the top of the [Boot] menu.
- 4 Place disc number one of the recovery CDs into the DVD-ROM & CD-R/RW drive.
- 5 Press **(F10)**.
At the confirmation message, select [Yes] and press **(Enter)**.
The computer will restart. If [Enter Password] is displayed during the following procedures, input the Supervisor Password or the User Password.
This screen should appear.

```
-----  
Select a number  
-----  
1. [ Recovery ] Reinstall Windows.  
2. [ Erase HDD ] Erase the whole data on HDD for security.  
3. [ Backup ] Enable the Backup function.  
-----  
0. [ Cancel ] Cancel.  
-----
```

- 6 Press **(3)** to execute [3. [Backup]].

CAUTION

- When dividing the hard disk into partitions
Do not execute [1. [Recovery]] to divide the hard disk into partitions. The hard disk backup function cannot be enabled after the hard disk has been partitioned. Use step 8 to divide the hard disk.

- 7 At the confirmation message, press **(Y)**.
- 8 Select how to divide the hard disk from the menu.
<To create a backup area and enable the backup function without dividing the hard disk>
Select [1].

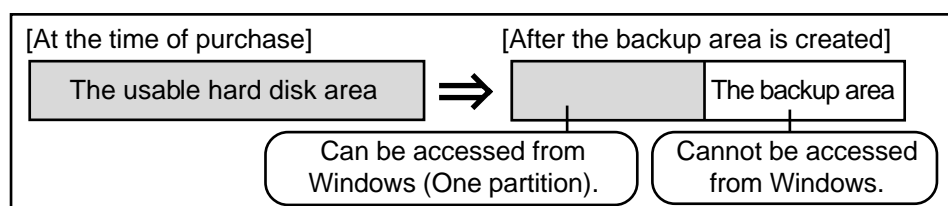

Hard Disk Backup Function

<To create a backup area and divide hard disk into two partitions, for OS and data>
Select [2], enter the partition size (GB), and press **Enter**.

- You can cancel this operation by pressing **0**.
- The data partition size will be the maximum settable size less the number entered above. The maximum settable size will differ depending on models.

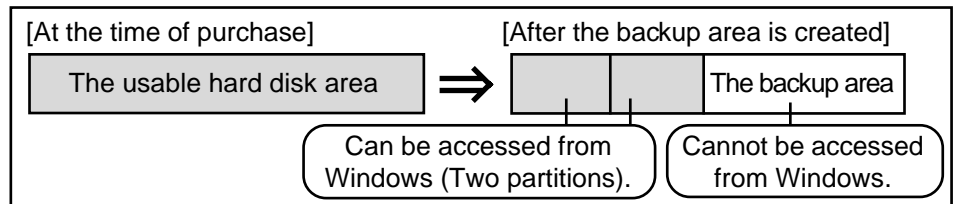

- 9 At the confirmation message, press **Y**.
The backup area is then created.
- 10 When the message [You must reboot in order to enable the Backup function.] appears, remove the recovery CD-ROM, and press any key to restart the computer. The computer is restarted, then the backup process will begin.
- 11 When the message [[Backup] is complete] appears, press **Ctrl** + **Alt** + **Del** to restart the computer.

CAUTION

- Do not press **Ctrl** + **Alt** + **Del** until the message is displayed.

- 12 After logging on to Windows, a message will appear advising that a new device has been installed and that the computer must be restarted to enable the settings. Select [Yes] to restart the computer.

NOTE

- The [Boot] menu in the Setup Utility is set to start up from the DVD-ROM & CD-R/RW drive. Change this setting if necessary.
- The next time the backup or restore functions are executed, follow the procedure for [Backing Up and Restoring Data] (☞ below).

Backing Up and Restoring Data

CAUTION

- Before executing the backup function, execute a disk error check (☞ page 38).
- Do not interrupt the backup or restore functions before completion, for example by turning off the power or pressing **Ctrl** + **Alt** + **Del**, as this may prevent Windows from starting up, or may cause data to be lost so that the backup and restore functions cannot be executed.

- 1 Turn the computer on, and press **F2** while [Panasonic] boot screen is displayed.
The Setup Utility will start up.
If a password has been set, enter the Supervisor Password or the User Password.
- 2 Select [Exit] menu, then select [Hard Disk Backup / Restore] and press **Enter**.
At the confirmation message, select [Yes], and press **Enter**.
- 3 Select the operation to be executed from the menu.
<To back up hard disk contents to the backup area>
 - 1 Press **1** to execute [1. [Backup]].
(When dividing the hard disk into two partitions, select the backup method at next screen.)
 - 2 At the confirmation message, press **Y**.
The backup process will begin.
<To restore backed up contents to the hard disk>
 - 1 Press **2** to execute [2. [Restore]].
(When data is backed up in two partitions, select the restore method at next screen.)
 - 2 At the confirmation message, press **Y**.
The restore process will begin.

NOTE

- The time required to complete the backup or restore process differs depending on the data volume.

- 4 When the message [[Backup] is complete] or [[Restore] is complete] is displayed, press **Ctrl** + **Alt** + **Del** to restart the computer.
- If the backup or restore process was interrupted before completion, for example if the power was turned off, execute the process again.
 - When a new device is installed and a message appears advising that the computer must be restarted to enable the settings, select [Yes] to restart the computer.

CAUTION

- When the hard disk backup function has been enabled, the backed up data will not be erased even if a commercial data erasing utility or similar software is used to erase all data from user-accessible area. You can use the hard disk data erase utility included in this computer (☞ page 42) to erase all data on the hard disk, including backed up data. Use this hard disk data erase utility before disposing of or transferring ownership of this computer.
- Occasionally, the message [#1805 cannot write image file] will be displayed, and the backup function will be interrupted. If this error occurs, execute the backup function again. After this, if the backup function is completed properly, then there is no problem in the hard disk.
- **To disable the hard disk backup function**
Perform the reinstallation procedure. All data in the backup area and the hard disk will be erased. Conduct steps **1-8** for [Reinstalling Software] (☞ page 34). Select [1] or [2] to execute the reinstallation at the screen for executing the reinstallation.
 - When [1] is selected, the hard disk backup function can be disabled.
 - When [2] is selected, the hard disk backup function can be disabled, but in this case, because the hard disk has been divided into partitions, the hard disk backup function cannot be re-enabled (☞ page 26).
 - When [3] is selected, the hard disk backup function cannot be disabled.

<When the hard disk backup function has been enabled>

If you select [3] in step **9** (☞ page 34) and execute reinstallation, the drive letter for the second partition (data partition) may be switched with that of the SD memory card. You can still use the drives after the letters have been switched, but you can also return the drive letters to their original state using the following procedures.

(The following procedure assumes that before reinstallation, the second partition (data partition) was Drive D:, and the SD memory card was Drive E:)

- 1** Disable the drive letter for the second partition (data partition).
 - ① Click [start] - [Control Panel] - [Performance and Maintenance] - [Administrative Tools] and double click [Computer Management].
 - ② Click [Disk Management] from [Storage].
 - ③ Right click on the partition for which [E:] is displayed and click [Change Drive Letter and Paths...].
 - ④ Click [Remove].
 - ⑤ At the confirmation message, click [Yes].
- 2** Change the SD memory card drive letter to [E:].
Use the SD drive letter change tool to change the SD memory card to the E: drive. (☞ Reference Manual "SD Memory Card/ MultiMedia Card")
- 3** Set the drive letter for the second partition (data partition) as [D:].
 - ① Click [start] - [Control Panel] - [Performance and Maintenance] - [Administrative Tools] and double click [Computer Management].
 - ② Click [Disk Management] from [Storage].
 - ③ Right click on the partition for which the drive letter is not displayed, and click [Change Drive Letter and Paths...].
 - ④ Click [Add...], assign [D:] as the drive letter, and click [OK].

Hard Disk Data Erase Utility

This computer is equipped with a utility for erasing hard disk data.

When disposing of or transferring ownership of this device, erase all data on the hard disk in order to prevent the theft of hard disk data by following the steps below.

The hard disk data erase utility erases data using an overwriting method, but there is a possibility that due to malfunctions or other operational errors, data may not be completely erased. There are also specialized devices that may be able to read data that has been erased using this method. If you need to erase highly confidential data, we recommend that you contact a company that specializes in this process. Matsushita Electric Industrial Co., Ltd. will bear no responsibility for losses or damages suffered as a result of the use of this utility.

Preparing

- Product Recovery CD-ROM (included)
- Panasonic DVD-ROM & CD-R/RW drive (optional: CF-VDRRT1M, CF-VDRRT2W, CF-VDRRT3W)

NOTE

- Be sure the AC adaptor is connected until the procedure is completed.
- This utility can only be used for internal hard disk. It cannot be used to erase data from external hard disks.
- This utility cannot erase data from damaged disk.
- This utility cannot erase data for specific partitions.
- After executing this utility, the computer cannot be booted from the hard disk.
- The backup area and the data in the backup area will be erased.

Procedure

- 1 Turn off the computer.
- 2 Connect the DVD-ROM & CD-R/RW drive to the computer.
- 3 Turn the computer on, and press **(F2)** while [Panasonic] boot screen is displayed.
The Setup Utility will start up.
If the password has been set, enter the Supervisor Password.
- 4 Select the [Boot] menu, then select [USB CD/DVD Drive] and press **(F6)** until [USB CD/DVD Drive] is at the top of the [Boot] menu.
- 5 Place the disc number one of the recovery CDs into the DVD-ROM & CD-R/RW drive.
- 6 Press **(F10)**.
At the confirmation message, select [Yes] and press **(Enter)**.
The computer will restart, and this screen should appear.

```
-----  
Select a number  
-----  
1. [ Recovery ] Reinstall Windows.  
2. [ Erase HDD ] Erase the whole data on HDD for security.  
3. [ Backup ] Enable the Backup function.  
  
0. [ Cancel ] Cancel.  
-----
```

<When the hard disk backup function has been enabled>
<When the message [The Backup function has been enabled].
If [Recovery] or [Erase HDD] is executed, the Backup function will be disabled, and your Backup data will be lost.] appears, press **(Y)**.
- 7 Press **(2)** to execute [2. [Erase HDD]].
(You can cancel this operation by pressing **(0)**.)
<When the hard disk backup function has been enabled>
When the message [The Backup function has been enabled.
If [Erase HDD] is executed, the Backup function will be disabled, and your Backup data will be lost.] appears, press **(Y)**.
When the message [Computer must be rebooted in order to execute [Erase HDD.]] appears, press **(R)**.
- 8 At the confirmation message, press **(Y)**.
- 9 When [Start menu] is displayed, press **(Enter)**.
- 10 The approximate time required for erasing data will be displayed.
Press **(Space)**.
- 11 At the confirmation message, press **(Enter)**. The operation of erasing the hard disk will start.
(If necessary, the "hard disk data erase" operation can be cancelled after it has begun by pressing **(Ctrl) + (C)**.
If the operation is cancelled before being completed, a part of data will not be erased.)
- 12 After the operation is complete:
Under normal conditions, the message [Hard disk data has been deleted.] will be displayed.
If a problem occurred during the operation, an error message will be displayed.
- 13 Remove the recovery CD, and then press any key to turn off the computer.
- 14 Remove the DVD-ROM & CD-R/RW drive.

Specifications

● Main Specifications

Model No.		CF-T2FWATZBM	
CPU/Cache		Intel® Pentium® M Processor 753 (1.20 GHz, 2 MB* ¹ L2 cache, 400 MHz FSB)	
Memory		256 MB* ¹ (768 MB* ¹ Max.), DDR SDRAM	
Video Memory		UMA (64 MB* ¹ Max.)* ²	
Hard Disk Drive		Approx. 40 GB* ³	
LCD	Type	12.1 XGA type (TFT) with Touchscreen	
	Displayed Colors*⁴	65,536/16,777,216 colors (1024 × 768 dots)	
External Display		65,536/16,777,216 colors (800 × 600 dots/1024 × 768 dots/1280 × 1024 dots/1600 × 1200 dots)* ⁵	
Slots	PC Card Slot	One Type I or Type II	
	Allowable current	3.3 V: 400 mA, 5 V: 400 mA	
	RAM Module Slot*⁶	172-pin, 2.5 V, Micro DIMM, DDR SDRAM, PC2100 Compliant* ⁷	
	SD Memory Card Slot*⁸	SD memory card/MultiMedia Card	
Interface	External Display Port	Mini Dsub 15-pin female	
	Microphone Jack	Miniature jack, 3.5 DIA	
	Headphone Jack	Miniature jack, 3.5 DIA	
	USB Ports	4-pin × 2, USB 2.0	
	Modem	RJ-11 jack, Data: 56 kbps (V.92) FAX: 14.4 kbps	
	LAN	RJ-45 jack, IEEE 802.3 10Base-T, IEEE 802.3u 100Base-TX	
	Wireless LAN	Built in Intel® PRO/Wireless 2915 ABG (☞ page 44)	
Keyboard/Pointing Device		85 keys/Touch Pad, Touchscreen (stylus (included) touch capable)	
Sound		WAVE and MIDI playback, Monaural Speaker (built in)	
Battery Pack		Li-ion 7.4 V, 4.8 Ah	
	Operating Time*⁹	Approx. 2.5 hours - 5 hours* ¹⁰ (Approx. 3.5 hours* ¹¹)	
	Charging Time*¹²	Approx. 3 hours	
	Clock Battery	Coin type lithium battery 3.0 V	
AC Adaptor*¹³	Input	100 V - 240 V AC, 50 Hz/60 Hz	
	Output	16 V DC, 2.5 A	
Power Consumption*¹⁴		Approx. 35 W* ¹⁵ /Approx. 40 W (Maximum when recharging in the ON state)	
Environment	Operation	Temperature	5 °C to 35°C {41 °F to 95 °F}
		Humidity	30% to 80% RH (No condensation)
	Storage	Temperature	-20 °C to 60 °C {-4 °F to 140 °F}
		Humidity	30% to 90% RH (No condensation)
Physical Dimensions (W × H × D)		284.2 mm × 28.3 mm (at the front)/46.7 mm (at the rear) × 210 mm (excluding protrusion){11.2 " × 1.2 " / 1.9 " × 8.3 "}	
Weight		Approx. 1250 g {2.8 lb.} (excluding the stylus and tether)	
Operating System		Microsoft® Windows® XP Professional Service Pack 2 with Advanced Security Technologies (NTFS File System)	
Utility Programs		Adobe Reader, Intel® PROSet/Wireless Software, SD Utility, Icon Enlarger, Loupe Utility, Touch Pad Utility, DMI Viewer, PC Information Viewer, Display Rotation Tool, Hotkey Settings, Wireless LAN Switch Setup Utility, Hard Disk Data Erase Utility* ¹⁶ , Hard Disk Backup Utility* ¹⁶	

*¹ 1 MB = 1,048,576 bytes

*² A segment of the main memory is allotted automatically depending on the computer's operating status. The size of the Video Memory cannot be set by the user.

*³ 1 GB = 1,000,000,000 bytes. Operating system or some application software will report as fewer GB.

*⁴ A 16,777,216 color display is achieved by using the dithering function.

*⁵ Maximum resolution depends on the specifications of the external display.

*⁶ Options: CF-BAU0256U (256 MB), CF-BAU0512U (512 MB) Contact your technical support office. (☞ page 45)

*⁷ A PC2700-compliant RAM module added to this computer, operates at the same speed as a PC2100-compliant RAM module.

*⁸ Operation has been confirmed for Panasonic SD memory cards with up to 1 GB capacity.

*⁹ Varies depending on the usage conditions, CPU speed, etc.

*¹⁰ Measured using BatteryMark™ Version 4.0.1 (LCD brightness: Maximum - Minimum)

*¹¹ Measured using MobileMark™ 2002 (LCD brightness: 60 cd/m²)

*¹² Varies depending on the usage conditions, CPU speed, etc.

It may take a long time to charge a fully discharged battery.

*¹³ <Only for North America>

The AC adaptor is compatible with power sources up to 240 V AC adaptor. The computer is supplied with a 125 V AC compatible AC cord.

*¹⁴ Approx. 1.5 W when the battery pack is fully charged (or not being charged) and the computer is off.

*¹⁵ Rated power consumption.

*¹⁶ The Product Recovery CD-ROM is required.

Specifications

● Wireless LAN

Data Transfer Rates	IEEE802.11a: 54/48/36/24/18/12/9/6 Mbps (automatically switched)* ¹
	IEEE802.11b: 11/5.5/2/1 Mbps (automatically switched)* ¹
	IEEE802.11g: 54/48/36/24/18/12/9/6 Mbps (automatically switched)* ¹
Standards Supported	IEEE802.11a/IEEE802.11b/IEEE802.11g
Transmission Method	OFDM system, DSSS system
Wireless Channels Used	IEEE802.11a: channels 36/40/44/48/52/56/60/64/149/153/157/161/165
	IEEE802.11b/IEEE802.11g: Channels 1 to 11
RF Frequency Band	IEEE802.11a: 5.18~5.32 GHz, 5.745~5.825 GHz
	IEEE802.11b/IEEE802.11g: 2412~2462 MHz

*¹ These are speeds specified in IEEE802.11a+b+g standards. Actual speeds may differ.

LIMITED WARRANTY

For U.S.A.

PANASONIC PERSONAL COMPUTER AND PERIPHERALS LIMITED WARRANTY

Panasonic Computer Solutions Company (referred to as "Panasonic") will repair this product (other than software, which is covered by a separate warranty) with new or rebuilt parts, free of charge in the U.S.A. for three (3) years from the date of original purchase in the event of a defect in materials or workmanship. This warranty includes the AC adaptor but excludes the batteries and all other options and accessories which are covered for a period of one (1) year from the date of purchase.

This warranty is extended solely to the original purchaser. A purchase receipt or other proof of date of original purchase will be required before warranty performance is rendered.

This warranty only covers failures due to defects in materials or workmanship which occur during normal use. It does not cover damage which occurs in shipment or failures which are caused by products not supplied by Panasonic, or failures which result from alteration, accident, misuse, introduction of liquid or other foreign matter into the unit, abuse, neglect, installation, maladjustment of consumer controls, improper maintenance, modification or service by anyone other than a Factory Service Center or authorized Panasonic Service Dealer, or damage that is attributable to acts of God.

Limits and Exclusions:

There are no other express warranties except as listed below.

PANASONIC SHALL NOT BE LIABLE FOR LOSS OF DATA OR OTHER INCIDENTAL OR CONSEQUENTIAL DAMAGES RESULTING FROM THE USE OF THIS PRODUCT, OR ARISING OUT OF ANY BREACH OF THIS WARRANTY. ALL EXPRESS AND IMPLIED WARRANTIES, INCLUDING THE WARRANTIES OF MERCHANTABILITY AND FITNESS FOR A PARTICULAR PURPOSE ARE LIMITED TO THE APPLICABLE WARRANTY PERIOD SET FORTH ABOVE. Some states do not allow the exclusion or limitation of incidental or consequential damages, or limitations on how long an implied warranty lasts, so the above limitations or exclusions may not apply to you.

This limited warranty gives you specific legal rights, and you may also have other rights which vary from state to state. If a problem with your product develops during or after the warranty period, you may contact our representatives at 1-800-LAPTOP5. If the problem is not handled to your satisfaction, then write to the Consumer Affairs Division at the address indicated below.

SOFTWARE LIMITED WARRANTY

Panasonic Computer Solutions Company (referred to as "Panasonic") warrants to you only that the disk(s) or other media on which the Programs are furnished will be free from defects in materials and workmanship under normal use for a period of sixty (60) days from the date of delivery thereof to you, as evidenced by your purchase receipt.

This is the only warranty Panasonic makes to you. Panasonic does not warrant that the functions contained in the Programs will meet your requirements or that the operation of the Programs will be uninterrupted or error free.

Panasonic's entire liability, and your exclusive remedy under this warranty shall be limited to the replacement, in the United States, of any defective disk or other media which is returned to Panasonic's Authorized Service Center, together with a copy of the purchase receipt, within the aforesaid warranty period.

Anything in the foregoing to the contrary notwithstanding, Panasonic shall have no obligation for any defects in the disk(s) or other media on which the Programs are furnished resulting from your storage thereof, or for defects that have been caused by operation of the disk(s) or other media otherwise than on the Product or in environmental conditions other than those specified by Panasonic by alteration, accident, misuse, abuse, neglect, mishandling, misapplication, installation, maladjustment of consumer controls, improper maintenance, modification of damage that is attributable to acts of God. In addition, Panasonic shall have no obligation for any defects in the disk(s) or other media if you have modified, or attempted to modify any Program.

DURATION OF IMPLIED WARRANTIES, IF ANY, IS LIMITED TO SIXTY (60) DAYS.

PANASONIC ASSUMES NO RISK OF AND SHALL NOT IN ANY CASE BE LIABLE FOR ANY DAMAGES, INCLUDING, WITHOUT LIMITATION, ANY SPECIAL, INCIDENTAL, CONSEQUENTIAL, OR PUNITIVE DAMAGES ARISING FROM BREACH OF WARRANTY OR CONTRACT, NEGLIGENCE OR ANY OTHER LEGAL THEORY, INCLUDING, WITHOUT LIMITATION LOSS OF GOODWILL, PROFITS OR REVENUE, LOSS OF USE OF THE PROGRAMS OR PRODUCTS OR ANY ASSOCIATED EQUIPMENT, COST OF CAPITAL, COST OF ANY SUBSTITUTE EQUIPMENT, FACILITIES, SERVICES, DOWNTIME COSTS, OR CLAIMS OF ANY PARTY DEALING WITH YOU FOR SUCH DAMAGES.

Some states do not allow the exclusion or limitation of incidental or consequential damages, or limitations on how long an implied warranty lasts, so the above limitations or exclusions may not apply to you.

This limited warranty gives you specific legal rights, and you may also have other rights which vary from state to state.

This Limited Warranty will be governed by the laws the State of New York, without regard to its conflict-of-laws rules.

* * *

To obtain service or technical assistance within the continental U.S.A. and Alaska.

DIAL TOLL FREE: 1-800-LAPTOP5

Correspondence requesting product information should be sent to:
Panasonic Computer Solutions Company
50 Meadowlands Parkway, Panazip 2F-5, Secaucus, NJ 07094

LIMITED WARRANTY

For Canada

PANASONIC COMPUTER AND PERIPHERALS LIMITED WARRANTY

Coverage – Panasonic Canada Inc. ("PCI") warrants to you, the first end user customer, this computer product (excluding software media), when purchased from PCI or from a PCI authorized reseller, to be free from defects in materials and workmanship under normal use, subject to the terms set forth below, during the period of warranty coverage specified.

Scope of Coverage	Period of Coverage	Type of Failure Coverage
Whole Product (except Batteries), AC adaptor and CD-ROM (if factory installed)	Three (3) Years from Date of Original End User Customer Purchase	Defective Materials or Workmanship
Batteries, CD-ROM (unless factory installed), Port Replicator, Extra Memory Modules and all other Peripherals, Options and Accessories	One (1) Year from Date of Original End User Customer Purchase	Defective Materials or Workmanship

Remedy – In the event of a warranty claim, contact PCI's representatives within the applicable warranty period, identifying the nature of the defect claimed, at 1-800-668-8386 between 9:00 A.M. and 5:00 P.M., Eastern Time Zone, Mon. – Fri. (excluding holidays) for instructions on how to obtain service. A purchase receipt or other proof of date of original purchase is required before warranty service is performed. Defective parts covered by this Limited Warranty will be repaired or replaced with new or comparable rebuilt parts on an exchange basis. Warranty replacement or repair is subject to the terms of this Limited Warranty for the balance of the original period of warranty coverage.

No Coverage – This Limited Warranty does not cover products purchased outside Canada. Neither does it cover damage to, failure of, or defects in a product or accessory through mishandling, improper installation, abnormal use, misuse, neglect, accident, introduction of liquid or other foreign matter into the product, alteration or servicing by anyone not authorized by PCI, or act of God.

IF YOU SHIP THE PRODUCT FOR WARRANTY SERVICE

Carefully pack the product, preferably in the original carton. Include details of defect claimed and proof of date of original purchase. No liability is assumed for loss or damage to the product while in transit, if you chose your own transportation carrier.

SOFTWARE MEDIA LIMITED WARRANTY

Coverage – Panasonic Canada Inc. ("PCI") warrants to you, the first end user customer, that the disk(s) or other media on which software program(s) is/are supplied will be free from defects in materials and workmanship under normal use in Canada for a period of sixty (60) days from date of receipt as evidenced by your purchase receipt for your Panasonic Computer product.

THIS IS THE ONLY WARRANTY THAT PCI MAKES RESPECTING THE SOFTWARE MEDIA. PCI does not warrant the software. Please refer to the software licensor's written warranty (accompanying the copy of the software) for any software warranty claim.

Claim Procedure – In the event of a defect in material or workmanship in the media during the sixty (60) day warranty period, and you return it, transportation costs prepaid, to Panasonic Canada Inc., Computer Products Marketing, at the above address, within the warranty period, together with a copy of your purchase receipt, and an explanation of the suspected defect, PCI will replace in Canada the defective disk(s) or other media.

Remedy – PCI's entire liability, and your only remedy for any breach of this software media warranty is limited to replacement of the media only. It does not cover any other damages, including, but not limited to, loss of use or profit loss, or special, indirect or consequential damages, or other claims, whether or not of similar character.

No Coverage – This limited warranty does not apply if the disk(s) or other media has been used in other than a Panasonic product, or in environmental conditions other than those specified by PCI or the manufacturer, or if subjected to misuse, neglect, mishandling, modification or attempted modification of the program, or if damaged by accident or act of God. PCI is not responsible for damage to or loss of any program, data or removable storage media.

GENERAL

NO OTHER WARRANTIES – PCI DISCLAIMS ALL OTHER WARRANTIES, EITHER EXPRESS OR IMPLIED, INCLUDING, BUT NOT LIMITED TO, IMPLIED WARRANTIES OF MERCHANTABILITY AND FITNESS FOR A PARTICULAR PURPOSE, WITH RESPECT TO THE SOFTWARE, SOFTWARE MEDIA, COMPUTER PRODUCT, OPTIONS AND ACCESSORIES.

NO LIABILITY FOR CONSEQUENTIAL DAMAGES – IN NO EVENT SHALL PCI BE LIABLE FOR ANY SPECIAL, INDIRECT OR CONSEQUENTIAL DAMAGES ARISING FROM ANY BREACH OF THE LIMITED WARRANTIES SET OUT IN THIS DOCUMENT, OR FROM THE USE OF THE COMPUTER PRODUCT, INCLUDING, WITHOUT LIMITATION, LOSS OF DATA, BUSINESS, PROFIT OR GOODWILL.

IN ANY EVENT, PCI'S MAXIMUM LIABILITY FOR ANY BREACH SHALL NOT EXCEED THE AMOUNT ACTUALLY PAID BY YOU FOR THE COMPUTER PRODUCT.

NO ACTION, REGARDLESS OF ITS BASIS, MAY BE BEGUN AGAINST PCI MORE THAN TWO (2) YEARS AFTER THE CAUSE OF ACTION AROSE.

Statutory Warranties – Some jurisdictions do not allow these limitations or exclusions, so they may not apply to you.

Memo



As an ENERGY STAR® Partner, Matsushita Electric Industrial Co., Ltd. has determined that this product meets the ENERGY STAR® guidelines for energy efficiency.

Outline of the International ENERGY STAR® Office Equipment Program

The international ENERGY STAR® Office Equipment Program is an international program that promotes energy saving through the use of computers and other office equipment. The program backs the development and dissemination of products with functions that effectively reduce energy consumption. It is an open system in which business proprietors can participate voluntarily. The targeted products are office equipment such as computers, displays, printers, facsimiles, and copiers. Their standards and logos are uniform among participating nations.

Panasonic Computer Solutions Company

50 Meadowlands Parkway, Panazip 2F-5,
Secaucus, NJ 07094

Panasonic Canada Inc.

5770 Ambler Drive Mississauga,
Ontario L4W 2T3



Free Manuals Download Website

<http://myh66.com>

<http://usermanuals.us>

<http://www.somanuals.com>

<http://www.4manuals.cc>

<http://www.manual-lib.com>

<http://www.404manual.com>

<http://www.luxmanual.com>

<http://aubethermostatmanual.com>

Golf course search by state

<http://golfingnear.com>

Email search by domain

<http://emailbydomain.com>

Auto manuals search

<http://auto.somanuals.com>

TV manuals search

<http://tv.somanuals.com>