

Panasonic

Portable DVD/Video CD/CD Player Operating Instructions

Model No.

DVD-L50A

DVD-L50PM



The "DVD-L50A" denotes the model for Australia and N.Z.

The "DVD-L50PM" denotes the model for Latin America.



Dear Customers

May we take this opportunity to thank you for purchasing this Panasonic Portable DVD/Video CD/CD Player.

We strongly recommend that you carefully study the Operating Instructions before attempting to operate the player and that you note the listed precautions.



Before attempting to connect, operate or adjust this player, please read these instructions completely. Please save this manual.

VQT8343

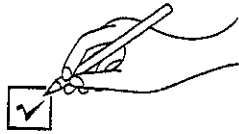
Accessories

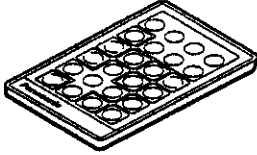

Please check and identify the supplied accessories.

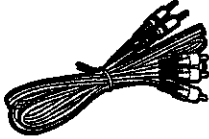
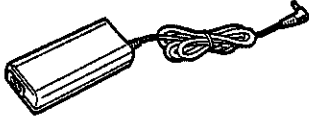
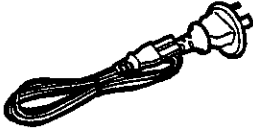
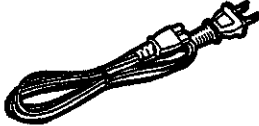
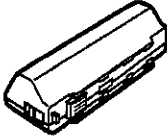
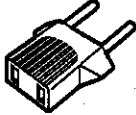
	DVD-L50A	DVD-L50PM
	<input type="checkbox"/> Remote control unit . . . 1 (Part No. VEQ2294)	<input type="checkbox"/> Remote control unit . . . 1 (Part No. VEQ2293)
	<input type="checkbox"/> Button-type battery . . . 1 for remote control unit (Part No. CR2025)	<input type="checkbox"/> Button-type battery . . . 1 for remote control unit (Part No. CR2025)
	<input type="checkbox"/> Audio/video cable 1 (Part No. VJA1065)	<input type="checkbox"/> Audio/video cable 1 (Part No. VJA1065)
	<input type="checkbox"/> AC adaptor 1 (Part No. VSK0576)	<input type="checkbox"/> AC adaptor 1 (Part No. VSK0576)
	<input type="checkbox"/> AC cord 1 (Part No. VJA0754)	/
		
	<input type="checkbox"/> Battery pack 1 (Model No. DY-DB50EX)	<input type="checkbox"/> Battery pack 1 (Model No. DY-DB50EX)
		<input type="checkbox"/> Power plug adaptor . . . 1 (Part No. VJS1993)
	<input type="checkbox"/> Operating Instructions manual 1 <input type="checkbox"/> Warranty 1 <input type="checkbox"/> Optional Warranty 1	<input type="checkbox"/> Operating Instructions manual 1 <input type="checkbox"/> Setup Guide (Spanish) 1

Optional accessories:

- Battery pack (Model No. DY-DB50EX)
- S video cable
- Optical digital audio cable

Player

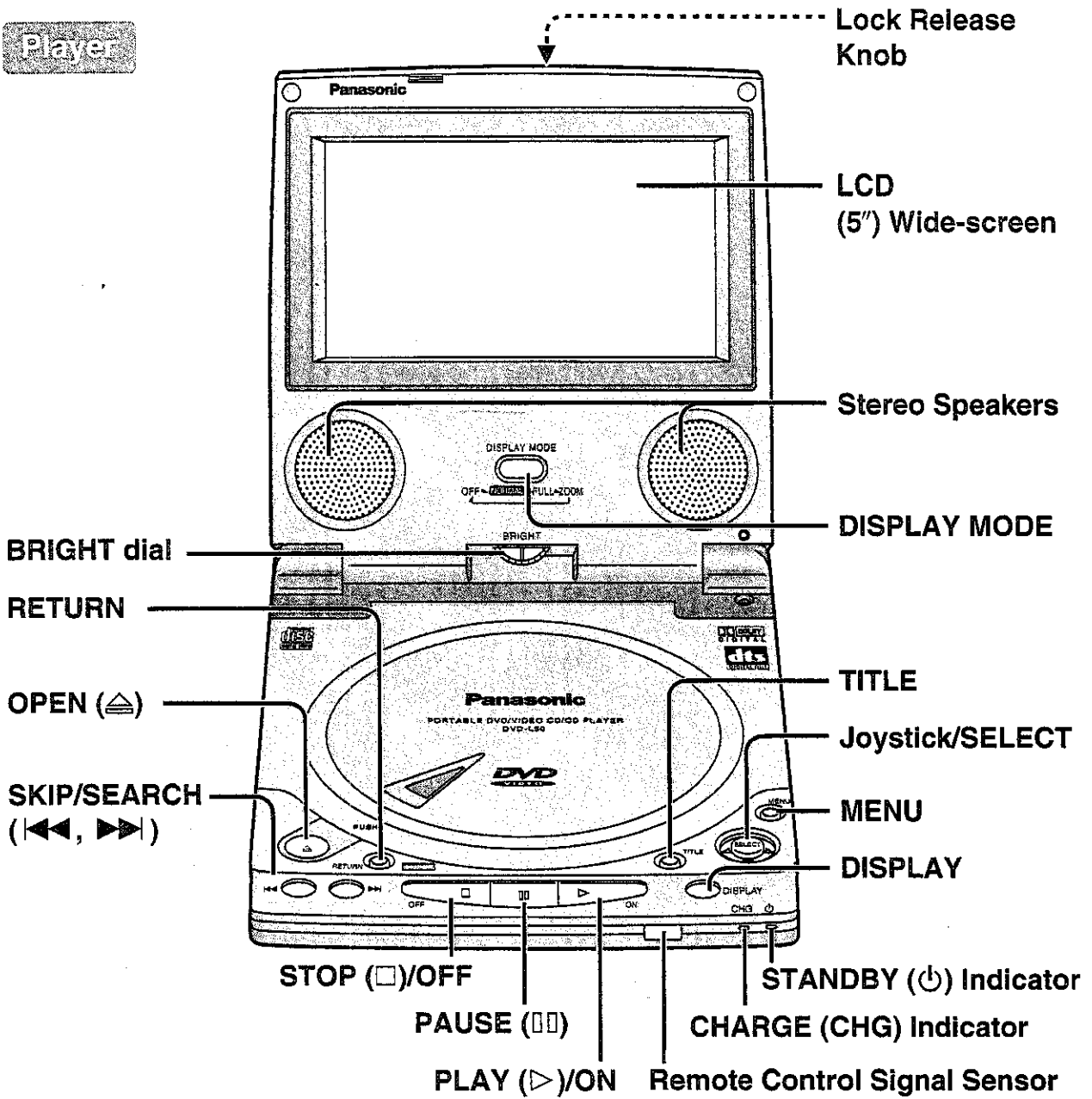

Remote control unit

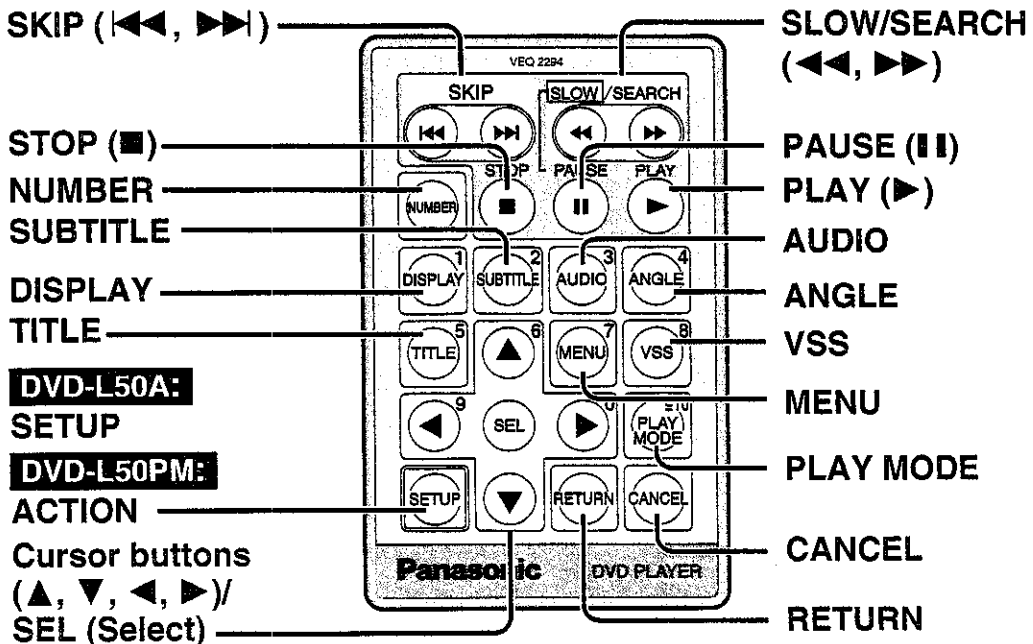

Safety information

Note:

This player can be used only where the power supply is AC 100–240 V, 50/60 Hz. It cannot be used elsewhere.

CAUTION:

THE PORTABLE DVD/VIDEO CD/CD PLAYER IS A CLASS 1 LASER PRODUCT. IT USES A VISIBLE/INVISIBLE LASER BEAM THAT COULD EXPOSE YOU TO HARMFUL LASER RADIATION IF THE PRODUCT IS NOT USED CORRECTLY IN ACCORDANCE WITH THE OPERATING INSTRUCTIONS.

WHEN THIS PORTABLE DVD/VIDEO CD/CD PLAYER IS CONNECTED TO THE WALL OUTLET OR BATTERY PACK DO NOT PLACE YOUR EYES CLOSE TO THE OPENING OF THE INNER COVER AND OTHER OPENINGS TO LOOK INTO THE INSIDE OF THIS PLAYER.

USING THE PRODUCT IN A MANNER, OTHER THAN THE PROCEDURES SPECIFIED IN THE OPERATING INSTRUCTIONS, MAY RESULT IN THE EXPOSURE TO HAZARDOUS RADIATION.

DO NOT OPEN COVERS AND DO NOT REPAIR YOURSELF. REFER SERVICING TO QUALIFIED PERSONNEL.

Marking sign is located on bottom of the AC adaptor.

Marking sign is located on bottom of the Portable DVD/Video CD/CD Player.

WARNING:

TO REDUCE THE RISK OF FIRE OR ELECTRIC SHOCK, DO NOT EXPOSE THIS PLAYER TO RAIN OR MOISTURE.

TO REDUCE THE RISK OF FIRE OR ELECTRIC SHOCK, AND ANNOYING INTERFERENCE, USE THE RECOMMENDED ACCESSORIES ONLY.

THIS PLAYER IS INTENDED FOR CONTINUOUS OPERATION!



CLASS 1
LASER PRODUCT

(Bottom of player)

CAUTION	— VISIBLE AND INVISIBLE LASER RADIATION WHEN OPEN. AVOID EXPOSURE TO BEAM.
ATTENTION	— RAYONNEMENT LASER VISIBLE ET INVISIBLE EN CAS D'OUVERTURE. EXPOSITION DANGEREUSE AU FAISCEAU.
VORSICHT	— SICHTBARE UND UNSICHTBARE LASERSTRAHLUNG, WENN ABDECKUNG GEÖFFNET. NICHT DEM STRAHL AUSSETZEN.
ADVARSEL	— SYNLIG OG USYNLIG LASERSTRÅLING VED ÅBNING. UNNGÅ UDSÆTTELSE FOR STRÅLING.
ADVARSEL	— SYNLIG OG USYNLIG LASERSTRÅLING NÅR DEKSEL ÅPNES. UNNGÅ EKSPONERING FOR STRÅLEN.
VARNING	— SYNLIG OCH OSYNLIG LASERSTRÅLNING NÅR DENNA DEL ÄR ÖPPNAD. STRÅLEN ÄR FARLIG.
VARO!	— AVATTAESSA OLET ALTTIINA NÄKYVÄÄ JA NÄKYMÄTÖN LASERSÄTEILYLLE. ÄLÄ KATSO SÄTEESEEN.
注意	— 打开时有可见及不可见激光辐射, 避免激光束照射。

(Bottom of player)

⚠ DANGER

■ Caution regarding the battery pack

- Do not use the battery pack with equipment other than the specified player.
- Use this player to recharge the battery pack.
- Do not drop, impact, disassemble, remodel, or press the battery pack.
- Do not throw the battery pack into fire, or heat it.
- Do not store the battery pack in temperature over 60°C.
- Keep the battery pack away from areas exposed to direct sunlight or in close to a flame.
- Do not touch the plug terminals (⊕ or ⊖) with metal objects.
- Do not use, charge, or leave the battery pack in locations where there is static electricity.
- Do not get the terminals dirty or wet.
- Do not get dirt, sand, or other foreign matter on the terminals.
- Do not use the player outside if it is snowing or raining. (This battery pack is not waterproof.)

■ Caution regarding disposing of the battery pack and the button-type battery

- Check, and follow, your local regulations before disposal.

■ Caution regarding the button-type battery

- Danger of explosion if battery is incorrectly replaced. Replace only with the same or equivalent type recommended by the equipment manufacturer. Discard used batteries according to manufacturer's instructions.
- Do not disassemble, remodel (solder, e.g.), press, heat or throw the battery into fire.
- Keep the button-type battery out of reach of children.
- Make sure you insert the battery with its poles aligned.
- Do not touch the plug terminals (⊕ or ⊖) with metal objects.

■ Countermeasure against electrolyte leaking from the battery pack or the button-type battery

- If any electrolyte should come into contact with your hands or clothes, wash it off thoroughly with water.
- If any electrolyte should come into contact with your eyes, never rub the eyes. Rinse eyes thoroughly with water, and then consult a doctor.

Open the facing page when using the operating instructions.

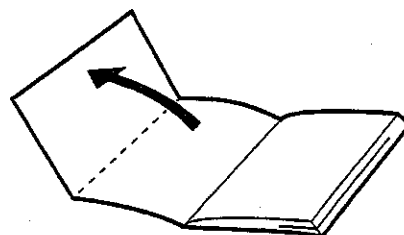

Table of contents

Getting Started:

Accessories	2
Safety information	4

Features	8
● Disc formats supported by this player	9
Safety precautions	10

Preparations:

Remote control unit preparations ...	15
● Button-type battery (included) installation	15
● Notes regarding the button-type battery	15

● Remote control operation range	15
● Remote control operational notes	15
Powering the player using the AC adaptor	16

Basic Operations:

Basic play	20
● Stopping play	22
● Skipping ahead or back	22
● Rapid advance (Rapid reverse)	23

● Still picture (Pause)	23
● Frame advance (Frame reverse) [DVD/Video CD]	23

Advanced Operations:

Operations using the GUI screens ...	25
● Detailed descriptions of each icon (Screen for disc information)	26
● Detailed descriptions of each icon (Screen for player information)	27
● Detailed descriptions of each icon (Shuttle screen)	28

Program play	29
Random play	30
Using the multi-functions	30
● Viewing from another angle (Multi-angle function)	30
● Changing audio soundtrack language (Multi-audio function)	31

For Your Reference:

Changing the initial settings	34
● When "1 Disc Languages" is selected	34
● When "2 Ratings" is selected (Parental lock function)	35
● When "3 Menu Language" is selected	37
● When "4 On-Screen Messages" is selected	37
● When "5 TV Aspect" is selected	38

● When "6 Digital Audio Output" is selected	38
● When "9 Other Settings" is selected	40
● Display modes of the LCD	41
● Recommended setting of "6 Digital Audio Output"	42
Connection	43
● Connecting to a stereo TV set	43
● Connecting to audio equipment	44

Operating precautions	12
● Handling precautions	12

Disc handling and maintenance	14
● Maintenance of the player	14
● Maintenance of the LCD	14

Powering the player using the battery pack (included)	17
● Attaching the battery pack	17
● Detaching the battery pack	17
● Charging the battery pack	18

Inserting/Removing discs	19
● Inserting discs	19
● Removing discs	19

● Slow-motion play [DVD/Video CD]	24
---	----

● Enjoying Video CDs with playback control without using menus [Video CD]	24
---	----

● Changing subtitle language (Multi-subtitle function)	31
Using a menu	32
● Using a title menu	32
● Using a DVD menu	32

Reproducing an Advanced Virtual Surround Sound (VSS) effect [Dolby Digital (AC-3) DVD (2 channel and above)]	33
---	-----------

● Enjoying digital audio output from the audio input/output (optical digital audio output) connector	45
● Connecting to a decoder with Dolby Digital (AC-3) or dts (digital theater systems) processing	46
● Playback from a video camera	47
● Connecting headphones	47
Troubleshooting	48
● Self-diagnosis display function	53

● When the STANDBY (⏻) indicator or the CHARGE (CHG) indicator flashes	54
Language code list	55
Definition of terms	56
Specifications	Back cover

Features

5-inch LCD Wide-screen* with stereo speakers

*This player provides a 280,000-pixel high-resolution LCD wide-screen. This lets you enjoy sharp images.

Portable type for the user on the go

The player's compact size, measuring 140 mm wide, 151.5 mm deep and 37.7 mm high, and light weight of only 640 g, make it easy for you to carry it around.

Approximately three-hour continuous playing capability with battery pack

[included or optional (model No.: DY-DB50EX)] (See page 17.)

Advanced Virtual Surround Sound (VSS) function

(See page 33.)

Dolby Digital (AC-3)/dts (digital theater systems) digital output

(See page 46.)

Dialogue Enhancer

(See pages 20 and 27.)

Graphical User Interface (GUI) screens (See page 25.)

DVD-L50A only:

Compatible with PAL DVD (Video CD) and NTSC DVD (Video CD)

To enjoy both PAL DVD (Video CD) and NTSC DVD (Video CD) on an external TV, the player must be connected to a PAL TV which is capable of receiving PAL 525/60 system.

Versatile DVD features

- Multi-angle function (See page 30.)
- Multi-audio function (See page 31.)
- Multi-subtitle function (See page 31.)
- Parental lock function (See page 35.)

This product incorporates copyright protection technology that is protected by method claims of certain U.S. patents and other intellectual property rights owned by Macrovision Corporation and other rights owners. Use of this copyright protection technology must be authorized by Macrovision Corporation, and is intended for home and other limited viewing uses only unless otherwise authorized by Macrovision Corporation. Reverse engineering or disassembly is prohibited.

■ Important information on playing DVDs and Video CDs

Some DVDs and Video CDs are played in a certain predetermined way based on the specifications of the software designer. When you insert a disc of this type, the player may not function according to the commands you enter (see the examples below) because the disc will be played according to the specifications of the software designer. For further information, see the manual provided with your disc.

Examples:

- You may press the SKIP button to go to the beginning of the next track, but instead of skipping, the player displays the  mark (indicating a prohibited action).
- Some functions such as the RESUME function and the A-B repeat play do not work with an interactive DVD or during menu play of a Video CD with playback control.

Disc formats supported by this player

The player can play back discs bearing any of the following marks:



DVD
[8 cm disc/12 cm disc]



Video CD
[8 cm disc/12 cm disc]



CD
[8 cm disc/12 cm disc]

Discs which cannot be played with this player

- DVD with Region No. other than "4" or "ALL"
- DVD-ROM
- CD-ROM
- CDV
- CD-RW
- CVD
- CD-R
- Divx Video Disc
- DVD-R/DVD-RAM
- VSD
- CD-G
- DVD+RW
- SVCD
- Photo CD

DVD-L50PM only:

- Discs of PAL system etc.

Region Management Information

This player is designed and manufactured to respond to the Region Management Information that is recorded on a DVD disc. The Region number of this player is "4". If the Region number described on the DVD disc does not correspond to the Region number of this player, this player cannot play this disc. This player will play DVD discs made for "ALL" Regions.

This player will play DVD discs marked with labels containing the Region number "4" or "ALL":

Example:



or



Marks used in these instructions (pages 21-41)



...This gives details on a function which can be enjoyed with DVD.



...This gives details on a function which can be enjoyed with Video CD.



...This gives details on a function which can be enjoyed with CD.



...This gives details on a function which can be operated by the player's function buttons.



...This gives details on a function which can be operated by the remote control unit's function buttons.

Safety precautions

Please read these precautions before operating this player.

■ AC cord and AC adaptor protection

To avoid any malfunctions of the player, and to protect against electric shock, fire or personal injury, please observe the following:

- Use only the AC adaptor provided.
- Do not use the player above the established ratings of the AC outlet and power distributor or do not supply an AC voltage outside the 100–240 V range.
- Hold the plug firmly when connecting or disconnecting the AC cord.
- Do not connect or disconnect the AC cord when your hands are wet.
- Keep the AC cord and AC adaptor away from heating appliances.
- Never put any heavy object on the AC cord and AC adaptor.
- Do not attempt to repair or reconstruct the AC cord and AC adaptor in any way.
- Remove dust, dirt, etc. on the plug at regular intervals.
- If liquids or foreign objects have been spilled into the player or AC adaptor, set the player to the standby mode and disconnect the AC cord.
- If the player has been dropped or otherwise damaged, set the player to the standby mode and disconnect the AC cord.
- If smoke, malodors or noises are emitted from the player or AC adaptor, set the player to the standby mode and disconnect the AC cord.
- If the case of the AC adaptor or the AC cord is damaged, set the player to the standby mode and disconnect the AC cord.
- If the AC adaptor is not going to be used for a long time, disconnect the AC cord for safety.

- Do not touch the plug, the AC adaptor, battery pack or the metal part of the player during a thunderstorm.
- Do not scratch or mark the AC adaptor, AC cord and power plug, rework them, place them in proximity to a heating appliance, forcibly bend them, twist them, pull them, place heavy objects on top of them, bunch them together with other wires or units, or put a cloth over them.
- Insert the power plug securely until its prongs are completely housed inside the AC outlet.

■ Do NOT disassemble or remodel this player.

■ Placement

Avoid placing the player or AC adaptor in areas of:

- direct sunlight or heating radiators, or closed automobiles
- high temperature (over 35°C) or high humidity (over 90%)
- excessive dust or oily smoke
- vibration, impact or where the surface is tilted
- in a poorly ventilated location as the internal parts may be seriously damaged.

■ No fingers or other objects inside

- Touching internal parts of this player is dangerous, and may cause serious damage to the player. Do not attempt to disassemble the player.
- Do not put any foreign object inside the player or AC adaptor.
- Do not insert metal or inflammable objects inside the player or AC adaptor.
- Take care not to catch your fingers when you close the inner cover.

-
- **To avoid injuries from accidents caused by inattention, do not use this player in the front seat of a moving vehicle, or when walking.**

 - **Keep away from water and magnets.**
 - Keep the player or AC adaptor away from flower vases, tubs, sinks, etc. If liquids are spilled into the player or AC adaptor, serious damage could occur.
 - Keep magnetic objects such as speakers, at a distance from this player.

 - **Do not use cracked or warped discs.**

 - **Do not use the car's cigarette lighter socket to supply power to the player.**
 - Doing so may cause a malfunction.

 - **Do not position your eyes near the lens, and do not look at the laser light.**
 - Doing so may be harmful to your vision.

 - **Do not operate the player for an extended period of time on your lap, etc.**
 - When this player is used for an extended period of time, the bottom of the player can become hot enough to cause minor burns.

Operating precautions

Handling precautions

■ If there is noise interference on the TV while a broadcast is being received

Depending on the reception condition of the TV, interference may appear on the TV screen while you are watching a TV broadcast and the player is left on. This is not a malfunction of the player or the TV. To watch a TV broadcast, set the player to the standby mode.

■ When installing the player

- Avoid shelves and other high locations.
- Place the player in a horizontal position, and do not place anything heavy on it.

■ When operating the player

- Do not expose the player to the sprays from volatile insecticides, etc. (Doing so may deform the external cabinet or cause the paint to peel off.)
- Do not push the LCD screen downward, especially using an object with a pointed end.
- After the player is used for many hours, the surface of the player or AC adaptor becomes hot; this is normal, not a malfunction.
- Do not touch the pickup unit (the lens in particular) inside the inner cover with your hands or other objects. (Doing so may cause a malfunction.)
- Do not insert objects into the opening hole area of the pickup unit. (Doing so may cause a malfunction.)
- Do not push the inner cover downward during playback. (Doing so may damage the disc inside.)
- Do not subject the player to impact during playback. (Doing so may damage the disc inside.)
- Do not set the player down on a sofa for operation. (Doing so may increase the temperature inside the player and cause damage to the player.)

■ When using the player outdoors

- Do not use the player in areas where it may get wet. (If the player gets wet, it may be damaged.)
- Do not use the player in sandy or dusty locations (such as a beach). (Sand and dust may find their way inside the player and cause a malfunction.)

■ Condensation

Moisture may form on the lens in the following conditions...

- immediately after a heater has been turned on.
- in a steamy or very humid room.
- when the player is moved from a cold environment to a warm one.

If moisture forms inside this player, it may not operate properly. In this case, turn on the power and wait about 1 to 2 hours for the moisture to evaporate.

■ When bringing the player on board an aircraft

- The electromagnetic waves emitted by the player may interfere with the aircraft's instruments. Follow the instructions given by the flight attendants.

■ When bringing the player into a hospital

- The electromagnetic waves emitted by the player may interfere with the medical equipment in the hospital. Follow the instructions given by the medical personnel.

■ When bringing the player inside a car

- Do not use the car's cigarette lighter socket to supply power to the player. (Doing so may cause a malfunction.)
- The exclusive battery pack [included or optional (model No. DY-DB50EX)] must always be used. (See pages 17 and 18.)
- Do not leave the player in areas of extremely high temperature (over approx. 60°C) such as inside of the car in hot summer or in the car trunk or of extremely low temperature (under approx. -10°C). (Doing so may cause the outer case deformation, or adversely affect battery pack performance and quality.)

■ When moving or transporting the player

- When moving the player, remove the disc if one is inside, and disconnect the AC adaptor and other cords.
- When transporting the player for relocation, place the player in its original packing carton.
- Do not drop the player or bump it into objects when moving or transporting it.

■ When the player is not going to be used for a long time

- To conserve power, set the player to the standby mode, and disconnect the AC adaptor from the AC outlet. (Even when the player is set to the standby mode, power equivalent to about 2.0 W will be consumed unless the AC adaptor is disconnected.)
- Be sure to close the inner cover. (Dust may attach to the lens or other parts, which may cause a malfunction.)

Do not place the player on amplifiers or other equipment which may become hot.

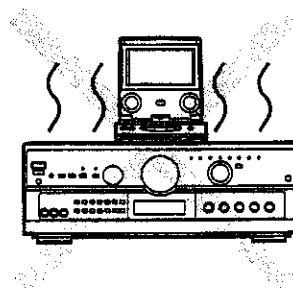

Disc handling and maintenance

■ Handling precautions

- Hold the disc by the edges so the surface will not be soiled with fingerprints. Fingerprints, dirt and scratches can cause skipping and distortion.

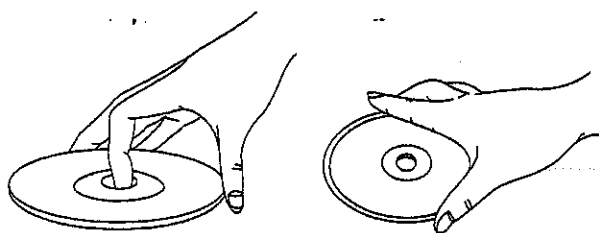

- Do not write on the label side with a ball-point pen or other writing instruments.
- Do not use record cleaning sprays, benzene, thinner, static electricity prevention liquids or any other solvent.
- Be careful not to drop or bend the disc.
- Do not install more than 1 disc.
- Do not try to close the inner cover when the disc is not installed properly.
- Be sure to store the disc in its exclusive case when not in use.

■ If the surface is soiled

Wipe gently with a soft, damp (water only) cloth.

When wiping discs, always move the cloth from the center hole toward the outer edge.

(If you wipe the discs using a circular motion, circular scratches are likely to occur, which will cause noise.)

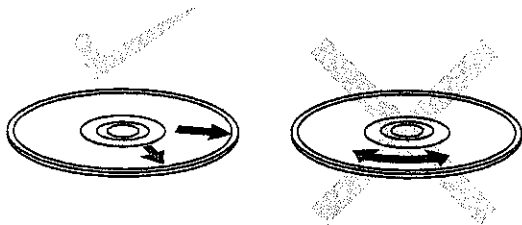

■ If the disc is brought from a cold to a warm environment, moisture may form on the disc

Wipe this moisture off with a soft, dry, lint-free cloth before using the disc.

■ Improper disc storage

You can damage discs if you store them in the following places:

- Areas exposed to direct sunlight
- Humid or dusty areas
- Areas directly exposed to a heat outlet or heating appliance

Maintenance of the player

- Be sure to press and hold STOP (□) to set the player to the standby mode and disconnect the AC adaptor before maintaining the player.
- Wipe this player with a dry, soft cloth. If the surfaces are extremely dirty, wipe clean with a cloth which has been dipped in a weak soap-and-water solution and wrung out thoroughly, and then wipe again with a dry cloth.
- Never use alcohol, benzene, thinner, cleaning fluid or other chemicals. And do not use compressed air to remove dust.

■ Maintenance of the lens

- If dust is attached to the lens, remove dust carefully with an air blower for camera lenses. Be careful not to touch the lens with your fingers.

Maintenance of the LCD

- Wipe the LCD screen with a dry, soft cloth.
- Drops of water spilled on the LCD screen may cause discoloration: wipe them dry immediately.

Remote control unit preparations

Button-type battery (included) installation

- 1** While sliding the release knob to the left, pull out the holder.
- 2** With the \oplus mark facing upwards, insert the battery.
- 3** Insert the holder.

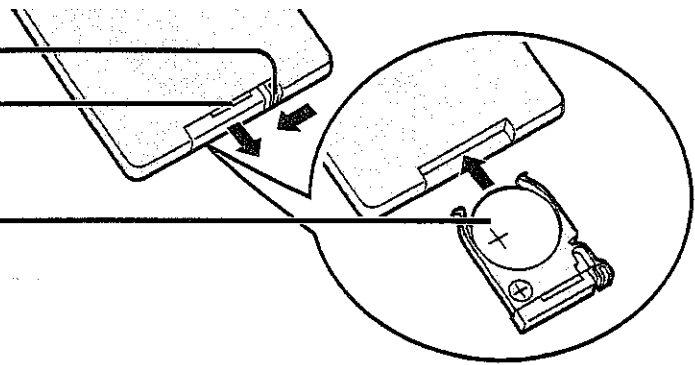

■ Service life of the battery

- The button-type battery (Lithium battery) normally lasts for about one year although this depends on how often, and for what operations, the remote control unit is used.
- If the remote control unit fails to work even when it is operated near the player, replace the battery.
- Use **CR2025** battery.

Notes regarding the button-type battery

- **Keep the button-type battery out of the reach of children.**
- Make sure you insert the battery with its poles aligned.
- Do not attempt to recharge, short-circuit, disassemble, heat or throw the battery into a fire.
- Wipe away any electrolyte leaking inside the remote control unit, and install new battery.
- If any electrolyte should come into contact with parts of your body, wash it off thoroughly with water.

Remote control operation range

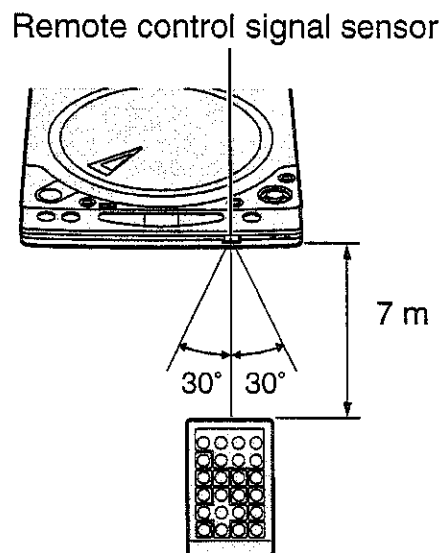

Remote control operational notes

- Do not drop, step on or otherwise impact the remote control unit. This may damage the parts or lead to malfunction.
- If the remote control unit is not going to be used for a long time, remove the battery. Otherwise, electrolyte may leak which may lead, not only to malfunction, but also, to burns if contact is made with the electrolyte.
- Do not point bright lights at the remote control sensor.
- Do not place objects between the remote control unit and the remote control sensor.
- Do not use this remote control unit while simultaneously operating the remote control unit of any other equipment.

Powering the player using the AC adaptor

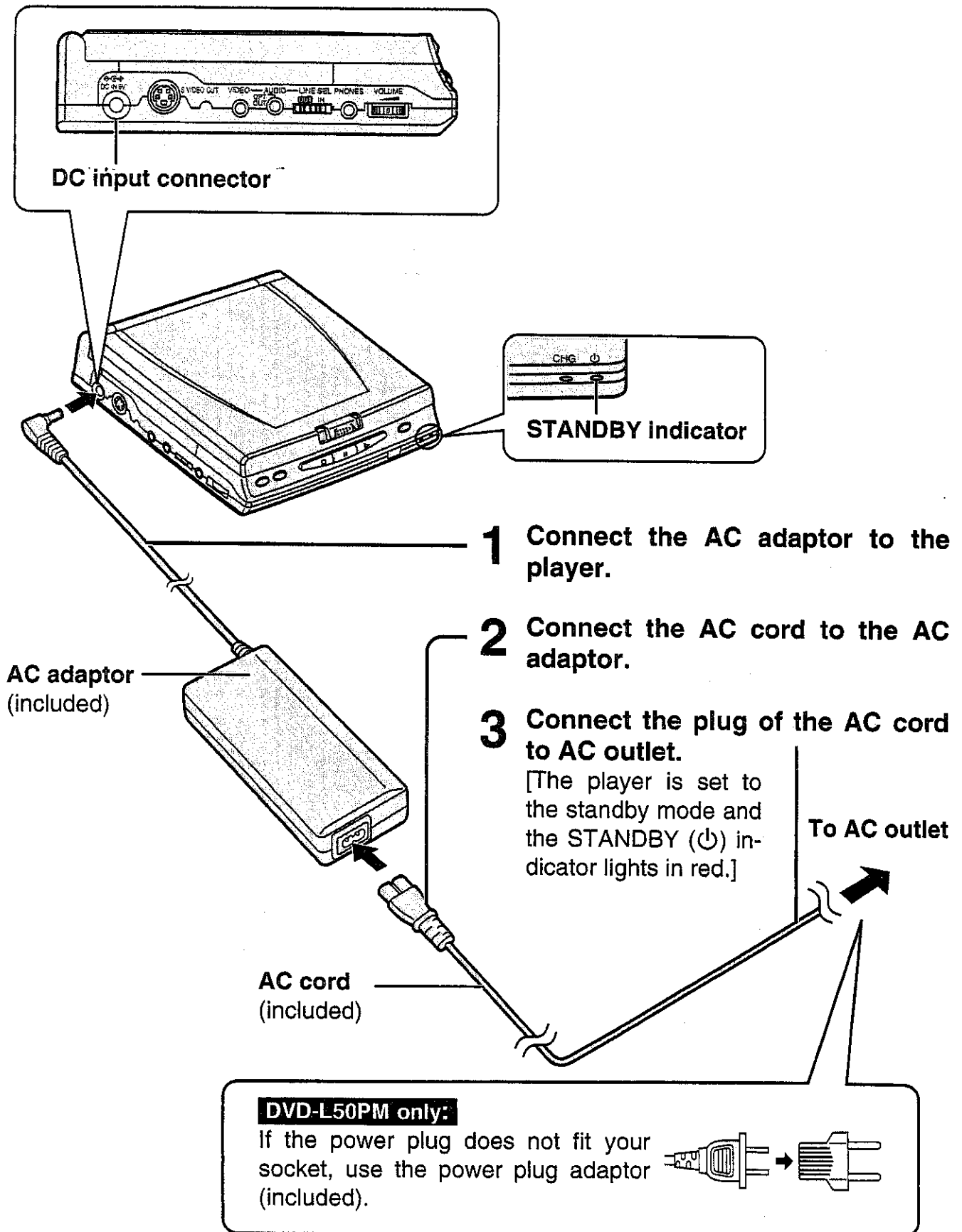

Standby mode:

This refers to a condition in which the AC adaptor is connected to the AC outlet and the player is consuming a small amount of power (approx. 2.0 W).

Powering the player using the battery pack (included)

Attaching the battery pack

- 1 Align the mark on the battery pack with the one on the player.

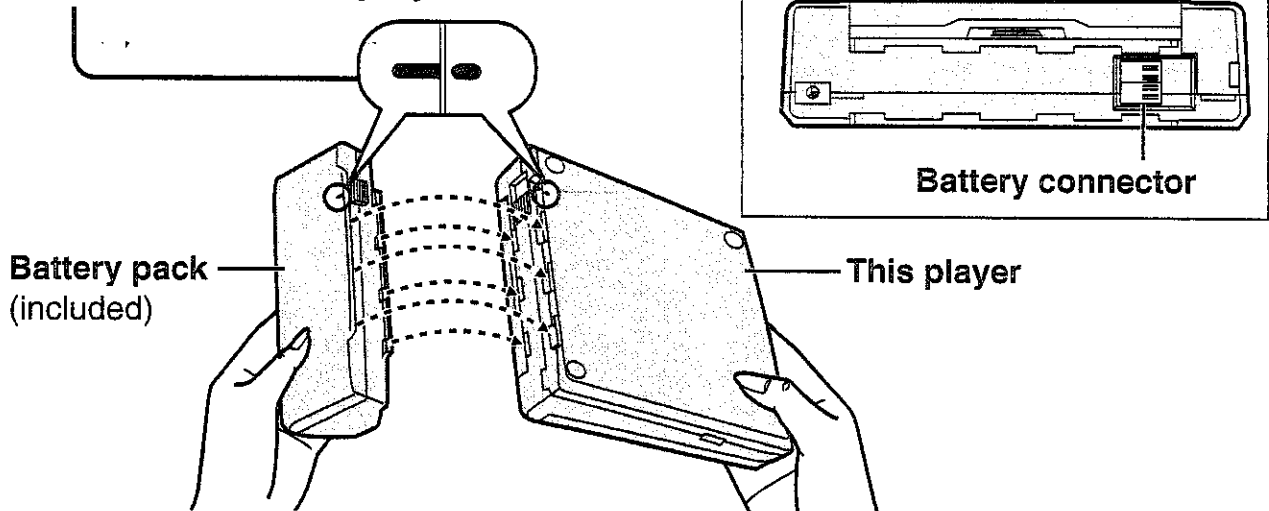

- 2 Slide the battery pack in the direction indicated by the arrow until the release knob clicks.
(The battery pack is attached.)

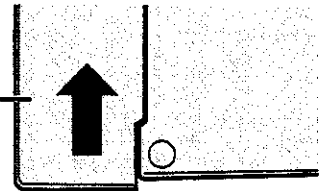

Note:

- Be careful not to touch the battery connector terminals. (Doing so may cause the terminals to become misshapen.)
- Do not allow any metallic object to come into contact with the terminals. (Doing so could damage the player.)

Detaching the battery pack

- 1 While pulling the release knob in the direction of the arrow, slide the battery pack in the direction of the arrow.

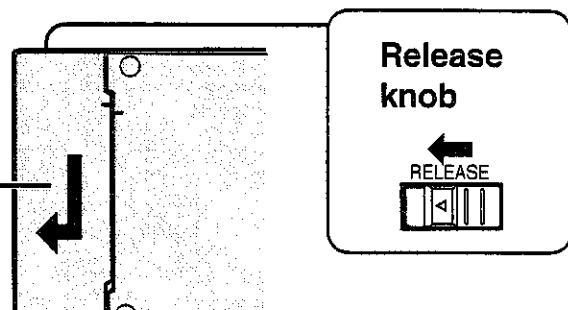

For your reference:

- If the battery pack is not going to be used for a long time, it must be detached from the player. (If it is left attached, a low level of current will still flow even though the player is turned off.) If it is left in this state, it may excessively discharge, rendering it unusable even after it has been recharged.
(Recharge the battery pack before use because the battery pack is discharging even when it is detached from the player.)
- The AC adaptor is equipped with an overcharge-prevention circuit. However, to protect the battery pack, be sure to detach it from the player upon completion of the charging.

Powering the player using the battery pack (included)

Charging the battery pack

- 1 Connect the battery pack to the player. (See page 17.)**
- 2 Connect AC adaptor to the player and to AC outlet. (See page 16.)**

[Charging starts and the CHARGE (CHG) indicator lights in red.]

For your reference:

- This product is a rechargeable **lithium ion battery pack**. It generates electrical energy through an internal chemical reaction. This chemical reaction is easily affected by temperature and humidity conditions. The effects become more severe as the temperature increases or decreases. In locations where the temperature is low, the battery pack may not fully charge, or the CHARGE (CHG) indicator may flash about 5 minutes after you start using it. At higher temperatures, a protector circuit may be activated, making the battery pack inoperative.
- The battery pack will not be charged when the player is ON (during play or in the stop mode). Charging will start when the STOP (□) button is pressed and held for approximately 2 seconds to set the player to the standby mode.
- The CHARGE (CHG) indicator goes off when charging is completed. Disconnect the AC adaptor and the AC cord after confirming the CHARGE (CHG) indicator is OFF.
- In the case where charging fails to start, refer to the notes on page 48.
- It takes about 6 hours (at 20°C) to charge the battery pack and, once fully charged, the battery will be good for approximately 3 hours of continuous playback (with the BRIGHT dial set to the center position). (See page 20.) However, usage time will differ depending on the operating condi-

tion. (If the brightness is set higher, the battery operating time will be shorter.)

- The battery pack has a service life of approximately 300 charge-discharge cycles. (It may depend on the operating condition.) The charging time or operating time on one full charge will be gradually shorter. If the time becomes noticeably shorter than it used to be, the battery pack has reached the end of its service life and should be replaced.

■ Notes when charging the battery pack

- When the battery pack is to be used for the first time, charge it fully before use.
- Upon completion of the charging, be sure to disconnect the power plug from the AC outlet. (If it is left connected, up to about 2.0 W of power will be consumed.)

■ Notes when using the battery pack

- For battery pack protection, do not charge an already fully-charged battery pack.

■ Notes when storing the battery pack

- Store the battery pack in areas where temperature is at 15°C–25°C.
- Do not store the battery pack in areas of extremely cold or high temperature, high humidity or excessive oily smoke.
- When storing the battery pack for a long period of time, discharge and fully recharge it once a year and store it again.

■ Notes when disposing of the battery pack

- Check, and follow, your local regulations before disposal.

Inserting/Removing discs

Inserting discs

- 1 While sliding the lock release knob to the right, open the outer cover.

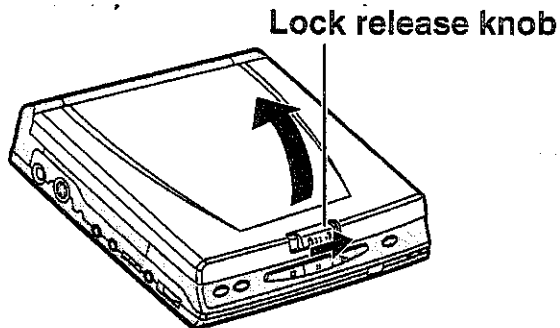

- 2 Press OPEN (\triangle) and open the inner cover.

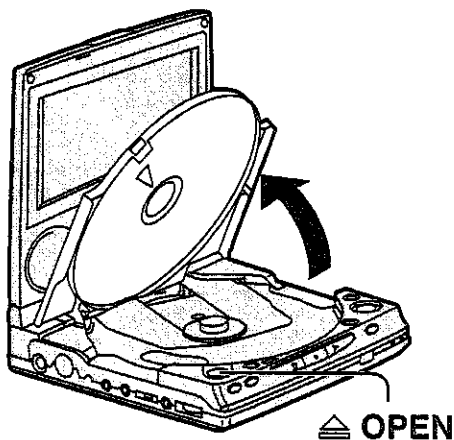

- 3 With the label side to be played facing upwards (if the disc has a label), place the disc in position, using your fingers to push down on the area around the center hole. (A click is heard.)

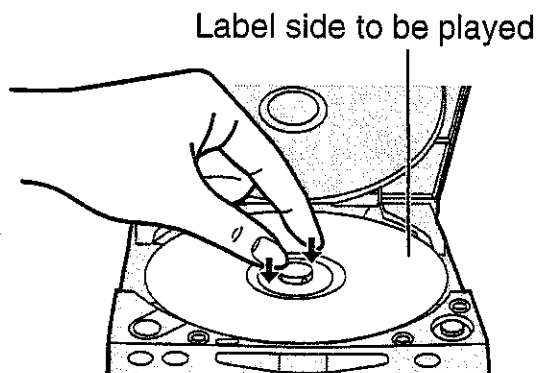

- 4 Close the inner cover.

Removing discs

- 1 If a disc is currently playing, press STOP (\square).
- 2 Press OPEN (\triangle) and open the inner cover.

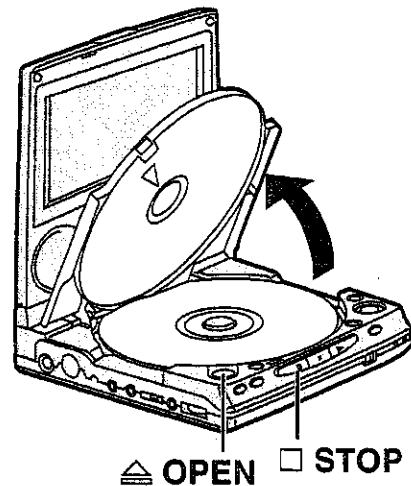

- 3 Using the groove for removing, remove the disc.
 - Do not touch the disc surface when removing.

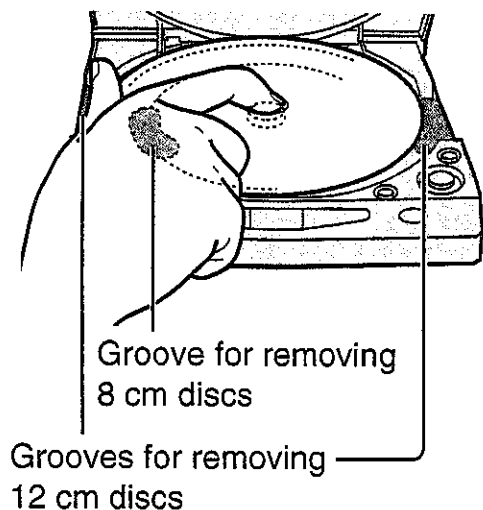

- 4 Close the inner cover.

Notes:

- Do not install more than 1 disc.
- Be sure to keep the inner cover closed except while inserting/removing discs. This will reduce the risk of malfunction caused by dust entering the inside of the player.

Basic play

Confirm that the disc is loaded. (See page 19.)

- 1 Press PLAY (▶).**
(The player is turned on and play begins automatically.)

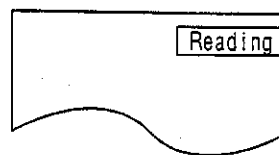

■ **When a menu appears on the screen**

In case of many movie DVDs, an interactive DVD or a Video CD with playback control (see page 56), a menu appears on the screen.

Perform steps 2 and 3 to start play.

- 2 Tilt/press the joystick/cursor buttons (▲, ▼, ◀, ▶) to select the preferred item.**

- The NUMBER button on the remote control is also effective for selecting the item. When the item is selected using the NUMBER button, step 3 is not necessary.
- The joystick and cursor buttons are not effective for selecting items for Video CDs. Select the item using the NUMBER button.

- 3 Press SELECT.**
(Play of the selected item now begins.)

■ **After operation**

When the player is not in use, to save power, press and hold STOP (□) to set the player to the standby mode. The player is automatically set to the standby mode after approx. 15 minutes have elapsed in the stop mode (**Auto power-off function**). (If the player is powered by the battery pack, the power will automatically be turned off after approx. 5 minutes have elapsed.)

■ **Adjusting the brightness of the screen**

Turn the BRIGHT dial to adjust the brightness of the screen.

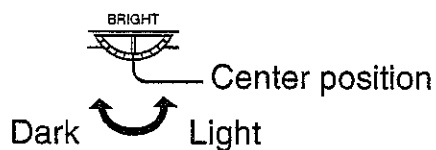

■ **Raising the volume but only for the dialogue**

—*While watching the movie program*—

The volume for the dialogue only can be raised by displaying the GUI screen (for player information) and setting “Dialogue Enhancer” to ON. (See page 27.)

[This setting takes effect only for discs which are recorded with Dolby Digital (AC-3) 5.1ch and with the dialogue contained in the center channel.]



Before enjoying DVD/Video CD/CD

The On-Screen menu language of your player has been factory preset to English.

DVD-L50A:

If you would like to change the menu language to French, German, Italian or Spanish, please refer to "When '3 Menu Language' is selected" on page 37.

DVD-L50PM:

If you would like to change the menu language to French or Spanish, please refer to "When '3 Menu Language' is selected" on page 37.

In the explanations given below it is assumed that English has been selected as the menu language.

Note:

- The disc continues to rotate while the menu is displayed even after the player has finished playing a particular item. When no further selections are to be played, be sure to press STOP (□) to clear the menu display.

For your reference:

- When the menu continues onto another screen, pressing SKIP/SEARCH (◀◀, ▶▶) or SKIP will show the next screen. (The buttons may not work depending on the disc used. For operation, refer also to the jacket of the disc concerned.)

- To return to the menu screen, press TITLE, MENU or RETURN (for DVD), or RETURN (for Video CD). (The buttons may not work depending on the disc used.)
- When ⊘ appears on the screen while a button is being operated, it means that the corresponding operation is prohibited by the player or the disc.
- Closing the outer cover or turning the LCD display screen to OFF while playing music CDs reduces power consumption. These measures also conserve battery power when operating off the battery pack. (Under these conditions, the battery pack provides 4.5 hours of continuous playback when playing music CDs.)

■ Entering the number

Press NUMBER to change to number input mode, then press the button corresponding to the desired number.

Example: Entering "6"

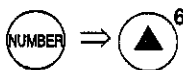

Example: Entering "16"

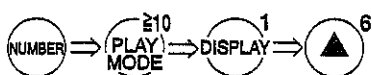

- To exit number input mode during the input process:
Press NUMBER.

■ HOLD function

When the HOLD switch is slid toward the "HOLD" direction, even when a function button is inadvertently pressed while the player is being carried, the function corresponding to the button will not be acknowledged. (It prevents the function buttons from being pressed during operation, so as not to interrupt playback.)

HOLD switch

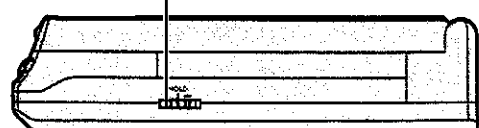

Basic play

Stopping playback

Press STOP (□) during play.

RESUME function:

The player records the point where STOP (□) was pressed during play (**RESUME function**). ("▶" flashes on the screen when this function is activated.)

- Press PLAY (▷) again while "▶" flashes, and play will resume from this point.
- When the inner cover is opened or STOP (□) is pressed again while "▶" flashes, the RESUME function will be cleared.

This feature will not be cleared when the player is turned off and then turned back ON.

Chapter review (preview) function (DVD only):

When PLAY (▷) is pressed while "▶" flashes, the message shown below is briefly displayed.

DVD-L50A:

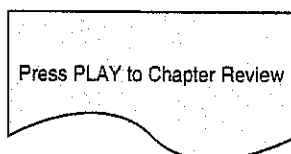

DVD-L50PM:

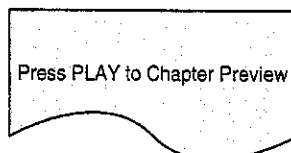

When PLAY (▷) is pressed again while the above message is displayed on the screen, the first few seconds of each chapter from the beginning of the title up to the point where operation was stopped will be played. This makes it possible to review previously viewed chapters. Normal playback will commence from the point where operation was stopped.

Note:

- Cancelling the RESUME function will also clear the chapter review (preview) function.

Skipping ahead or back

On the player

Press SKIP/SEARCH (◀◀, ▶▶) during play.

With the remote control unit

Press SKIP during play.

◀◀: Reverse

▶▶: Forward

- A chapter (DVD) or a track (Video CD/CD) is skipped each time the button is pressed.
- When SKIP/SEARCH (◀◀) or SKIP (▶▶) is pressed once midway through a chapter/track, play returns to the start of that chapter/track. When it is pressed again, a chapter/track is skipped each time the button is pressed.

Position being played back

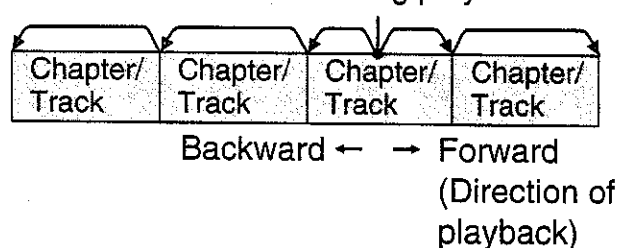

For your reference:

- When SKIP/SEARCH (◀◀, ▶▶) or SKIP is pressed during menu play of Video CDs with playback control, a menu screen may sometimes be recalled.

Rapid advance (Rapid reverse)

On the player

Press and hold **SKIP/SEARCH** (◀◀, ▶▶) during play.

- The speed will be retained even after the button is released.

With the remote control unit

Press **SLOW/SEARCH** during play.

- The speed of advance (reverse) is relatively slow at first. When the button is pressed again, the speed becomes faster. (Each time the button is pressed, the speed increases up to 5 steps.)

◀◀, ◀◀: Reverse
▶▶, ▶▶: Forward

- Normal play is resumed when **PLAY** (▷) is pressed.

For your reference:

- For DVDs and Video CDs, audio will be heard during scanning at the initial scan speed. (See page 40.) For CDs, audio will be heard during scanning at every scan speed (1 to 5).
- When **SKIP/SEARCH** (◀◀, ▶▶) or **SLOW/SEARCH** is pressed during menu play of Video CDs with playback control, a menu screen may sometimes be recalled.

Still picture (Pause)

Press **PAUSE** (⏸) during play.

- The player will be placed in the still picture mode (for DVD/Video CD) or in the pause mode (for CD).
- Normal play is resumed when **PLAY** (▷) is pressed.

For your reference:

- It is possible to show the picture type (I/P/B) on the screen in the still picture mode (DVD only). (See "5 Still Picture Display" on page 40. For details of the picture type, see page 57.)

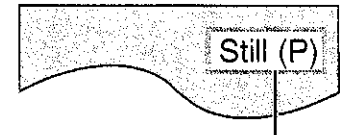

Example: P-Picture

Frame advance (Frame reverse) [DVD/Video CD]

Tilt/press the joystick/cursor buttons (◀, ▶) in the still picture mode.

◀: Reverse
▶: Forward

- The disc is advanced (reversed) by one frame each time the joystick is tilted or the cursor buttons are pressed.
- When the joystick is kept tilted or the cursor buttons are pressed, consecutive frame advance (reverse) works.
- Normal play is resumed when **PLAY** (▷) is pressed.

Notes:

- For Video CDs, frame reverse is not possible.
- If the GUI screen (Shuttle screen) is displayed, tilting/pressing the joystick/cursor buttons in the still picture mode activates slow-motion play, and frame advance/frame reverse does not work. (See page 28.)

For your reference:

- Pressing **PAUSE** (⏸) also activates frame advance.
- Whether the pictures are advanced by a "Frame" or "Field" is automatic. (See page 40.)



DVD

VCD

Slow-motion play [DVD/Video CD]

On the player

Press and hold **SKIP/SEARCH** (**◀◀**, **▶▶**) in the still picture mode.

- The speed will be retained even after the button is released.

With the remote control unit

Press **SLOW/SEARCH** in the still picture mode.

- The speed of slow-motion is slow at first. When the button is pressed again, the speed becomes faster. (Each time the button is pressed, the speed increases up to 5 steps.)

◀◀, **◀◀**: Reverse

▶▶, **▶▶**: Forward

- Normal play is resumed when **PLAY** (**▷**) is pressed.

Note:

- For Video CDs, slow-motion playback in reverse direction is not possible.

Enjoying Video CDs with playback control without using menus [Video CD]

1 Press **STOP** (**□**) after the menu screen appears.

2 Press **SKIP/SEARCH** (**◀◀**, **▶▶**) or **SKIP** to select the preferred track and press **PLAY** (**▷**).

(Play begins.)

- Refer to the jacket etc. of the disc concerned for the track numbers.
- Select "track 1" to start play from the beginning of the disc.
- The **NUMBER** button on the remote control can also be used for entering the track numbers. (See page 21 for information on entering numbers.)

When the number is selected using the **NUMBER** button, pressing **PLAY** (**▷**) is not necessary.

■ To return to menu play

Press **STOP** (**□**) twice to stop playback and press **PLAY** (**▷**).

(The menu is resumed on the screen.)

Perform steps 2 and 3 on page 20.

Operations using the GUI screens



This player features GUI (Graphical User Interface) screens providing various functions, a "banner" will be displayed on the screen by pressing the DISPLAY button. Operating the joystick/cursor buttons/SELECT button will show disc information (title/chapter/track number, elapsed playing time, audio/subtitle language, and angle) and player information (repeat play, play mode, marker, Virtual Surround Sound, etc.).

Some icons allow the settings to be changed.

1 Press DISPLAY during play or in the stop mode.

(GUI screen is displayed.)

- Each time the button is pressed, the icons change as shown below.
- The icons may differ depending on the disc contents.

Example: DVD

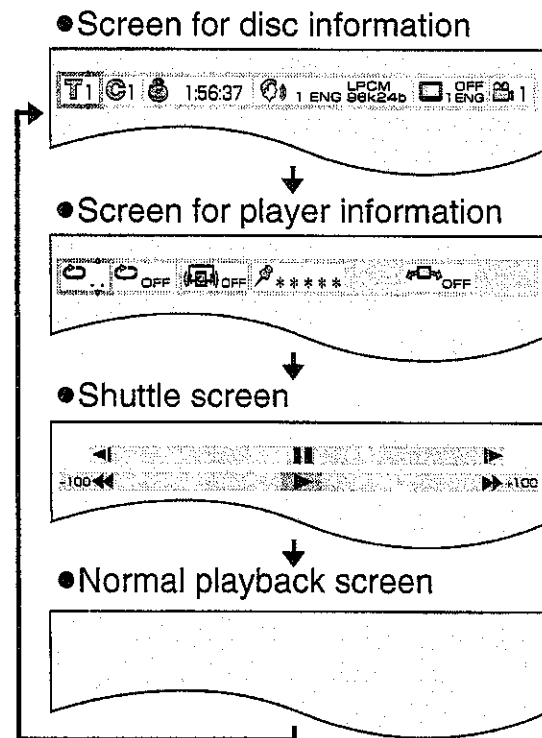

2 Tilt/press the joystick/cursor buttons (◀, ▶) to select the preferred item.

(The currently selected item is indicated by the yellow frame on the GUI screens.)

3 Tilt/press the joystick/cursor buttons (▲, ▼) to select the preferred setting.

For your reference:

- When playback of a CD starts, the GUI screen (for disc information) will automatically be displayed. Then, the icons can be changed using steps 2 and 3.
- Press RETURN or CANCEL to clear the GUI screens.
- For some functions, the setting will be registered immediately; for others, SELECT or PLAY (▷) must be pressed. Some functions cannot be accessed from the stop mode.
- When numbers are displayed (e.g. title No.), the NUMBER button on the remote control is also effective for setting instead of the joystick/cursor buttons (▲, ▼). (See page 21 for information on entering numbers.) When the number is selected using the NUMBER button, press SELECT to register the setting.
- If a TV set is connected to the player, depending on the type of the DVD software and a TV with automatic picture zoom function enabled, the GUI screens may not be displayed or only partially displayed on the TV screen. In this case, change the position of the GUI screens in "4 On-Screen Messages" of the initial settings. (See page 37.)
- The color (blue, violet or green) of the GUI screens can be changed. (See page 37.)

Operations using the GUI screens

Detailed descriptions of each item (Screen for disc information)

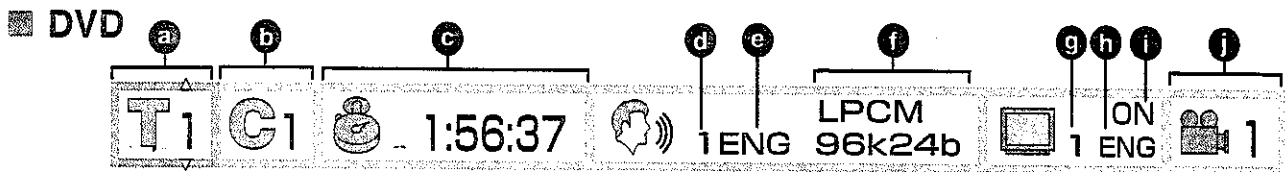

a Title No.

Change with the joystick/cursor buttons (▲, ▼) and press SELECT.

b Chapter No.

Change with the joystick/cursor buttons (▲, ▼) and press SELECT.

c Elapsed playing time

(hour: minute: second)

Change with the NUMBER button and appropriate buttons on the remote control, and press SELECT. (See page 21 for information on entering numbers.)

Example: To specify "1 hour 56 min. 37 sec.", enter "15637".

(This function does not work with some discs.)

d Audio soundtrack language No.

Change with the joystick/cursor buttons (▲, ▼).

e Audio soundtrack language

ENG: English	POR: Portuguese
FRA: French	RUS: Russian
DEU: German	JPN: Japanese
ITA: Italian	CHI: Chinese
ESP: Spanish	KOR: Korean
NLD: Dutch	MAL: Malay
SVE: Swedish	VIE: Vietnamese
NOR: Norwegian	THA: Thai
DAN: Danish	*: Others

f Audio attribute

LPCM: Linear PCM
(96k or 48k) (16b, 20b or 24b)
("k" stands for kHz and "b" stands for bit.)

DD: Dolby Digital (AC-3) (1–5.1ch)

DTS: dts (1–5.1ch)

Vocal: --- (OFF) or ON

[DVD Karaoke (Solo)]

Vocal: --- (OFF), V1+V2, V1 or V2

[DVD Karaoke (Duet)]

DVD-L50A only:

MPEG: MPEG (1–7.1ch)

g Subtitle language No.

Change with the joystick/cursor buttons (▲, ▼).

h Subtitle language

See the table on the left (under the item e).

i Subtitle on/off

Select "ON" or "OFF" with the joystick/cursor buttons (▲, ▼).

OFF: Subtitle is cleared.

ON: Subtitle is displayed.

j Angle No.

Change with the joystick/cursor buttons (▲, ▼).

Notes:

- It is not possible to turn playback control ON or OFF using the GUI screen.
- It is not possible to change the play mode using the GUI screen.

For your reference:

- "▲ ▼" around the icon means that the item can be changed using the joystick/cursor buttons (▲, ▼).
- All the markers are cleared when the player is set to the standby mode or turned off, or the inner cover is opened.



■ Video CD/CD

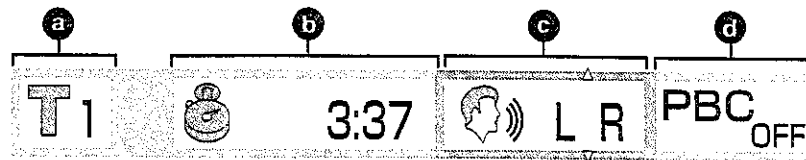

a Track No.

Change with the joystick/cursor buttons (▲, ▼) and press SELECT.

b Elapsed playing time (minute: second)

During CD play, display is changed each time the joystick/cursor button (▲) is tilted/pressed.

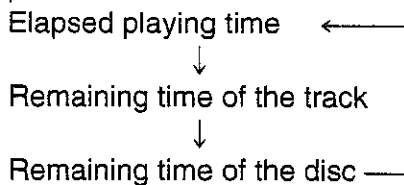

c Audio mode [Video CD]

Change with the joystick/cursor buttons (▲, ▼).

LR: Left channel sound is output from the speaker (L), and right channel sound from the speaker (R).

L: Left channel sound only is output.

R: Right channel sound only is output.

d Playback control [Video CD]

(See page 56.)

OFF: Menu play is not ON.

ON: Menu play is ON.

Detailed descriptions of each icon (Screen for player information)

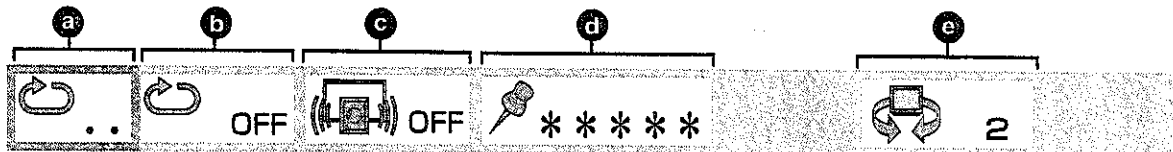

a A-B repeat play

Press SELECT during play to store location A and press SELECT again to store location B and to start repeat play between the specified two locations. Press SELECT again to return to normal play.

b Repeat play

Select the mode during play with the joystick/cursor buttons (▲, ▼).

[DVD]

OFF: Normal play

C: Chapter repeat play

T: Title repeat play

[Video CD/CD]

OFF: Normal play

T: Track repeat play

A: Disc repeat play

c Dialogue Enhancer [DVD]

(See page 20.)

Select the mode during play with the joystick/cursor buttons (▲, ▼).

OFF: Normal volume

ON: Louder volume

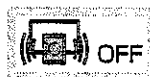

Play mode [Video CD/CD]

(See pages 29 and 30.)

PRG: Program play

RND: Random play

---: Normal play

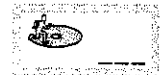

d Marker

Press SELECT during play and press SELECT again at the preferred point to store a marker. Press/tilt the cursor button/joystick (▶) and press SELECT to store the next marker. (Up to 5 markers can be stored in the memory. Marker no. is displayed instead of “*”).

•To recall a marker, select the marker no. with the joystick/cursor buttons (◀, ▶) and enter the selection with the joystick/cursor button (▲).

•To clear a marker, select the marker no. with the joystick/cursor buttons (◀, ▶) and press CANCEL on the remote control.

e Virtual Surround Sound (VSS) [DVD]

(See page 33.)

Select the mode during play with the joystick/cursor buttons (▲, ▼).

OFF: VSS off

1: VSS natural effect

2: VSS emphasized effect



Detailed descriptions of each item (Shuttle screen)

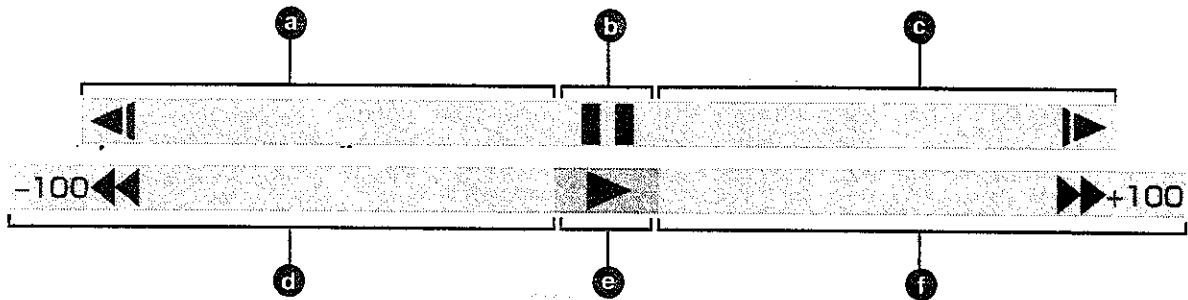

- a Slow-motion play (Backward)**
[DVD]
Tilt/press the joystick/cursor button (◀).
- b Still/pause**
Tilt/press the joystick/cursor button (▬).
- c Slow-motion play (Forward)**
[DVD/Video CD]
Tilt/press the joystick/cursor button (▶).
- d Rapid reverse**
Tilt/press the joystick/cursor button (◀◀).
- e Play**
Tilt/press the joystick/cursor button (▾).
- f Rapid advance**
Tilt/press the joystick/cursor button (▶▶).

For your reference

■ Chapter/Title repeat play (DVD)

Position being played back

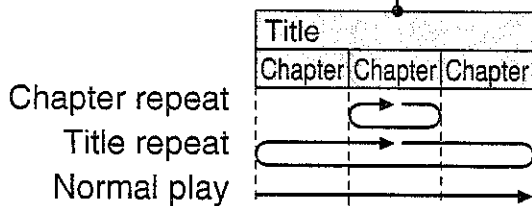

■ Track/Disc repeat play (Video CD/CD)

Position being played back

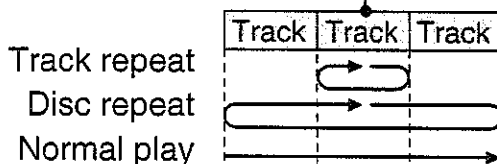

■ A-B repeat play

Starting location A End location B

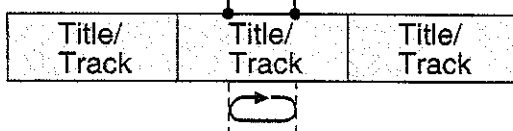

■ To enjoy program repeat play

Select the preferred repeat play mode by the "Repeat play" procedure on page 27 during program play (see page 29).

- ⏮ OFF: Cancel repeat mode
- ⏮ T: Repeat of programmed track being played
- ⏮ A: Repeat of all programs

For your reference:

- Each time the joystick/cursor buttons (◀, ▶) is tilted/pressed, the speed of rapid advance/reverse and slow-motion play increases up to 5 steps.
- The figures appearing at both ends of the shuttle screen stand for the maximum speeds of rapid advance/reverse.
 - DVD: +100/-100
 - Video CD: +40/-40
 - CD: +50/-50

1 Press PLAY MODE in the stop mode.

(The program playback screen is displayed.)

Example: a disc including 17 tracks

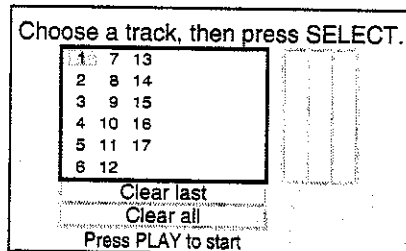

- To exit the screen
Press PLAY MODE twice.

2 Press/tilt the cursor buttons/joystick (▲, ▼, ◀, ▶) to select the preferred track number.

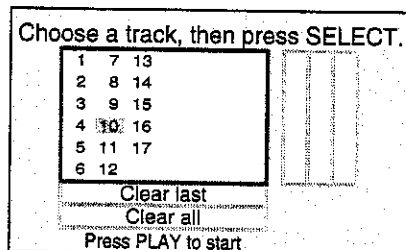

3 Press SELECT.

(The selected track is stored in the memory.)

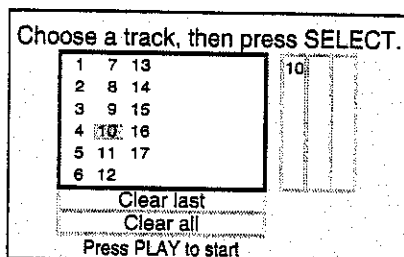

- Repeat steps 2 and 3 to select another track.
- Up to 18 tracks can be programmed.

4 Press PLAY.

(Play now begins in the programmed sequence.)

For your reference:

- The NUMBER button is also effective for selecting the track. (See page 21 for information on entering numbers.) When the number is selected using the NUMBER button, step 3 is not necessary.

■ After playback

Play is stopped and the program playback screen is displayed.

■ To return to normal play

Press STOP to stop program play, and then press PLAY MODE twice.

When PLAY is pressed, normal play begins from the beginning of the disc.

(The content of the program is still retained in the memory.)

■ To clear tracks one by one

Press STOP twice during program play or press PLAY MODE once in the stop mode to display the program playback screen. Each time CANCEL is pressed, the last track is cancelled.

Selecting "Clear last" using the cursor buttons/joystick and pressing SELECT also clears the last track.

■ To clear all tracks

The tracks are cleared when the player is set to the standby mode or turned off, or the inner cover is opened.

Selecting "Clear all" using the cursor buttons/joystick and pressing SELECT also clears all the tracks.

Random play



- 1 Press **PLAY MODE** twice in the stop mode.
(The random playback screen is displayed.)

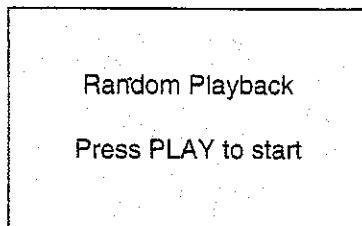

- To exit the screen
Press **PLAY MODE** once.

- 2 Press **PLAY**.
(Play now begins in random order.)

■ After playback

Play is stopped and the random playback screen is displayed.

■ To return to normal play

Press **STOP** to stop random play, and then press **PLAY MODE** once.

When **PLAY** is pressed, normal play begins from the beginning of the disc.

Using the multi-functions

Viewing from another angle (Multi-angle function)

Some DVDs contain scenes shot simultaneously from different angles. The same scene can be viewed from these different angles using the **ANGLE** button. (The angles depend on the disc used.)

- 1 Press **ANGLE** during play.
(Number of angle is displayed.)

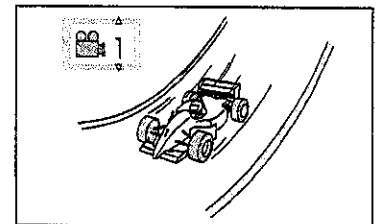

- 2 Press/tilt the cursor buttons/
joystick (**▲**, **▼**) to select an angle.

- Press **ANGLE** or **SELECT** to clear the display.

Note:

- This function only works for titles having scenes recorded at different angles.

■ Switching vocals ON or OFF for Karaoke discs



1. Press **AUDIO** during play of Karaoke discs.
2. Press/tilt the cursor buttons/joystick until the preferred setting is selected.

- DVD Karaoke (Solo)** (**◀**, **▶**)

"---" (OFF) ↔ "ON"

- DVD Karaoke (Duet)** (**◀**, **▶**)

↔ "1+2" (ON) ↔
↔ "V2" (ON) ↔ "V1" (ON) ↔

- Video CD** (**▲**, **▼**)

"LR" ↔ "L" ↔ "R"

- Press **AUDIO** or **SELECT** to clear the display.
- This operation does not work with CDs.

Changing audio soundtrack language (Multi-audio function)

It is possible to change the audio soundtrack language to a different language from the one selected at the initial settings. (If available. See page 34.)

- 1 Press AUDIO during play.**
(Number of the audio soundtrack language is displayed.)

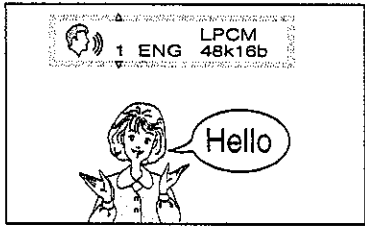

- 2 Press/tilt the cursor buttons/joystick (▲, ▼) to select a language.**

■ To clear/display the subtitles



Press/tilt the cursor buttons/joystick (◀, ▶) to select OFF or ON at step 2.

- Note:**
- The above operations work only with discs on which multiple audio soundtrack languages or subtitle languages are recorded.

Changing subtitle language (Multi-subtitle function)

It is possible to change the subtitle language to a different language from the one selected at the initial settings. (If available. See page 34.)

- 1 Press SUBTITLE during play.**
(Number of the subtitle language is displayed.)

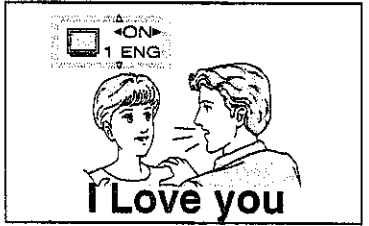

- 2 Press/tilt the cursor buttons/joystick (▲, ▼) to select a language.**

- For your reference:**
- When the power is turned on, or the disc is removed, the audio soundtrack language or subtitle language is the one selected at the initial settings. If this language is not recorded on the disc, the disc's main language will be selected.
 - When no audio soundtrack or subtitles are recorded, "—" or "— —" will be displayed instead of the language number.
 - Press AUDIO or SUBTITLE again, or press SELECT to clear the display.

DVD-L50PM only:

- Note:**
- When a disc supporting closed captions is played, the subtitles and the closed captions may overlap each other. In this case, turn the subtitle off.



Using a title menu

- 1 Press TITLE during play.**
(A list of the titles is displayed.)
 - Pressing TITLE again resumes play from the scene when TITLE was first pressed.

Example:

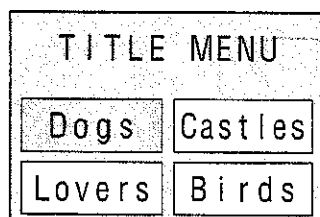

- 2 Tilt/press the joystick/cursor buttons (▲, ▼, ◀, ▶) to select the preferred title and press SELECT or PLAY (▷).**
(The selected title plays.)

Using a DVD menu

- 1 Press MENU during play.**
(The disc's menu is displayed.)
 - Pressing MENU again resumes play from the scene when MENU was first pressed.

Example:

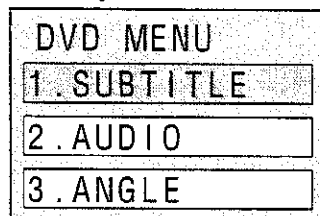

- 2 Tilt/press the joystick/cursor buttons (▲, ▼, ◀, ▶) to select the preferred item and press SELECT.**
(The selected item is now executed.)
 - To display the menu screen one after another, repeat step 2.

For your reference:

- The NUMBER button on the remote control is also effective for selecting the title or item. (See page 21 for information on entering numbers.)
When the title or item is selected using the NUMBER button, pressing SELECT or PLAY (▷) is not necessary.

■ Title menu

If the DVD has multiple titles recorded on it, it is possible to select the preferred title from the title menu to start playback.

■ DVD menu

Some DVDs have unique menus. For example, these menus can be for language selection, audio output selection and/or subtitle language selection, etc. These menus are called "DVD menus". Although the DVD menu's contents and operation differ from disc to disc, the explanations on the left show basic operation when this feature is used.

Reproducing an Advanced Virtual Surround Sound (VSS) effect [Dolby Digital (AC-3) DVD (2 channel and above)]

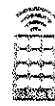

Use this function when external speakers are used to produce a surround-like effect when playing Dolby Digital DVDs. The speakers must be stereo and the Dolby Digital must be 2 channel or over.

Press VSS during play.

(The GUI screen is displayed and changes as follows each time the button is pressed.)

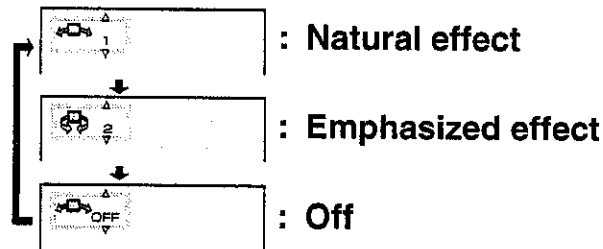

For your reference:

- For optimum effect, it is recommended that the distance between the player and the listening position be about 3 or 4 times the distance between the right and left front speakers.

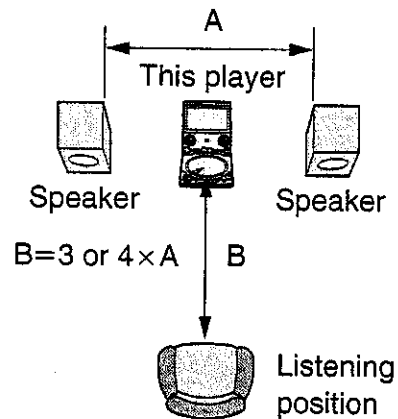

Notes:

- The stereo speakers in this player are not adequate for reproduction of the virtual surround sound effect. External speakers should be connected to the player.
- When the player is connected to a TV set with surround effect, turn off the surround effect on the TV set to operate the virtual surround sound effect of the player.

Difference between "VSS 1" and "VSS 2"

	VSS 1	VSS 2
Dolby Digital DVD (2ch)	The front speakers sound like they are further apart.	The front speakers sound like they are even further apart than in VSS 1.
Dolby Digital DVD (3–5.1ch) (Surround signal recorded)	Surround sound seems to come from the left and right of the listening position.	Surround sound seems to come from the left and right of the listening position and the front speakers sound like they are even further apart than in VSS 1.

Changing the initial settings

The initial settings (factory settings) can be changed. For example, the audio soundtrack language can be changed to French by changing the setting at "1 Disc Languages".

(The settings will be retained in the memory, until the settings are changed, even after switching to standby mode.)

1 **DVD-L50A:**
Press **MENU** or **SETUP** in the stop mode.

DVD-L50PM:
Press **MENU** or **ACTION** in the stop mode.

(The initial settings screen is displayed.)

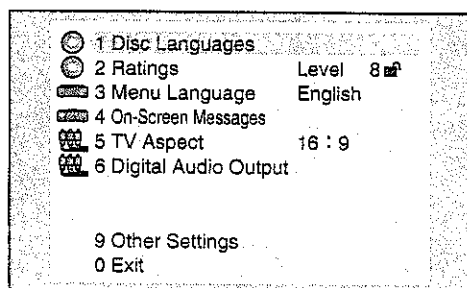

2 Tilt/press the joystick/cursor buttons (**▲**, **▼**) to select the item and press **SELECT**.

- "1 Disc Languages" See at right.
- "2 Ratings" See page 35.
- "3 Menu Language" See page 37.
- "4 On-Screen Messages" See page 37.
- "5 TV Aspect" See page 38.
- "6 Digital Audio Output" See page 38.
- "9 Other Settings" See page 40.
- "0 Exit" Exit the initial settings.

■ **To return to the previous menu**
Press **RETURN**.

■ **To finish the initial settings**

DVD-L50A:

Press **MENU** or **SETUP** at the initial settings screen illustrated in step 1.

DVD-L50PM:

Press **MENU** or **ACTION** at the initial settings screen illustrated in step 1.

Notes:

- There are no No. 7 and 8 in the initial settings menu of this player.
- It is not possible to select the item of the initial settings using the **NUMBER** button. Select the item using the joystick/cursor buttons.
- When the **MENU** button is pressed during play, the disc menu will be displayed and if pressed in the stop mode, the initial settings screen will be displayed.

When "1 Disc Languages" is selected

This is to select the audio soundtrack language, subtitle language and the language used in title menus or DVD menus which will always be used for every disc to be played back. (If the language selected is not available on the disc, the language designated by each disc will be selected.)

See left for steps 1 and 2.

3 Tilt/press the joystick/cursor buttons (**▲**, **▼**) to select the item and press **SELECT**.

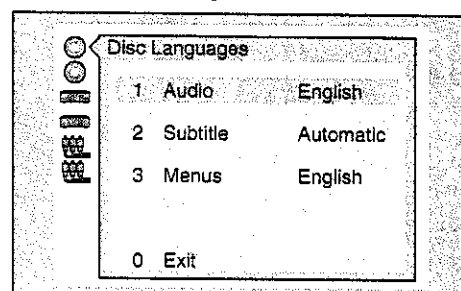



4 Tilt/press the joystick/cursor buttons (▲, ▼) to select the language and press SELECT.

■ When "1 Audio" is selected

DVD-L50A:

- 1 English (Factory preset)/
- 2 French/3 German/4 Italian/
- 5 Spanish
- 6 Original:

The original language of each disc will be selected.

7 Other ****:

Another language can be selected. (Input a 4-digit language code shown on page 55. Press CANCEL on the remote control if an incorrect code is entered.) (See page 21 for information on entering numbers.)

DVD-L50PM:

- 1 English (Factory preset)/
- 2 French/3 Spanish/
- 4 Original/5 Other ****

■ When "2 Subtitle" is selected

DVD-L50A:

1 Automatic (Factory preset):

Subtitle language is selected in accordance with the audio soundtrack language.

- If the language selected for "1 Audio" is used during playback, the subtitles will not appear.
- If another language is used during playback, the subtitles will appear in the language selected at the setup "1 Audio".

- 2 English/3 French/
- 4 German/5 Italian/6 Spanish
- 7 Other ****:

See item 7 at the setup "1 Audio".

DVD-L50PM:

- 1 Automatic (Factory preset)/
- 2 English/3 French/4 Spanish/
- 5 Other ****

■ When "3 Menu" is selected

DVD-L50A:

- 1 English (Factory preset)/
- 2 French/3 German/4 Italian/
- 5 Spanish
- 6 Other ****:

See item 7 at the setup "1 Audio".

DVD-L50PM:

- 1 English (Factory preset)/
- 2 French/3 Spanish/
- 4 Other ****

Setting is finished and the screen illustrated in step 3 on page 34 is displayed.

When "2 Ratings" is selected (Parental lock function)

This is to disable play of DVDs unsuitable for some audiences. Some discs may not be encoded with specific rating level information though its disc jacket says that it is for "adults". For those discs, the age restriction will not work. It is possible to prohibit playback of all DVDs.

When the player is not locked (Level 8)

See page 34 for steps 1 and 2.

3 Tilt/press the joystick/cursor buttons (▲, ▼) to select the level and press SELECT.

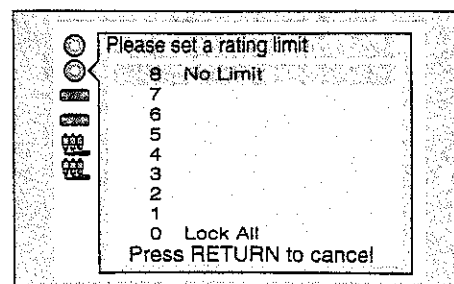

(Continued on the next page)

Changing the initial settings

Level 8 (Factory preset):

All DVDs (for adults/general audiences/children) can be played back.

Level 7 to 2:

DVDs for general audiences/children can be played back.

(DVDs for adults are prohibited.)

Level 1:

DVDs for children can be played back.

(DVDs for adults/general audiences are prohibited.)

Level 0:

Playback of all DVDs is prohibited (e.g. to prohibit playback of DVDs for adults which are not encoded with rating level information).

4 When level 7 or lower is selected, input a 4-digit password by using NUMBER and press SELECT.

(See page 21 for information on entering numbers.)

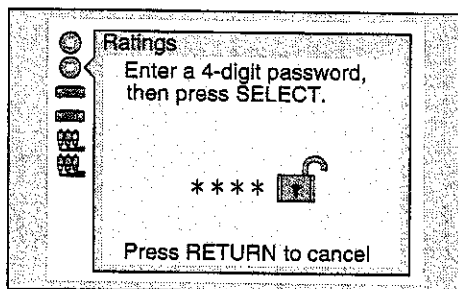

5 Press SELECT.

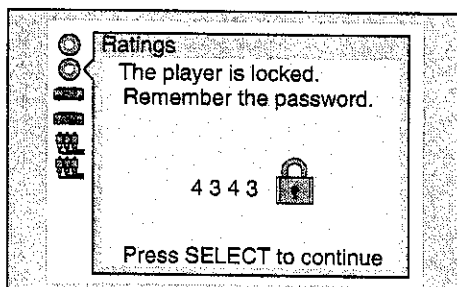

Setting is finished and the initial settings screen illustrated in step 1 on page 34 is displayed.

When the player is locked
(Level 0 to 7)

See page 34 for steps 1 and 2.

3 Input a 4-digit password by using NUMBER and press SELECT.

(See page 21 for information on entering numbers.)

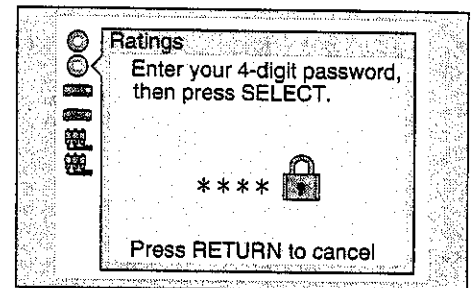

4

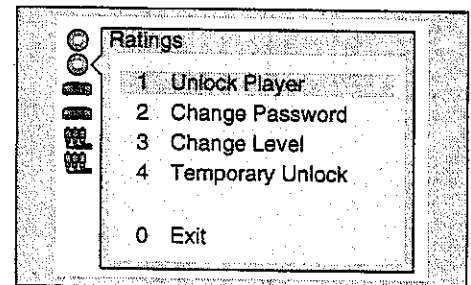

■ To unlock the player

1. Select "1" using the joystick/cursor buttons (▲, ▼) and press SELECT.

2. Press SELECT again.

■ To change the password

1. Select "2" using the joystick/cursor buttons (▲, ▼) and press SELECT.

2. Input the password by using NUMBER and press SELECT.

3. Press SELECT again.

■ To change the rating level

1. Select "3" using the joystick/cursor buttons (▲, ▼) and press SELECT.

2. Select a new level using the joystick/cursor buttons (▲, ▼) and press SELECT.



■ **To unlock the player temporarily**

1. Select "4" using the joystick/cursor buttons (▲, ▼) and press SELECT.

2. Press SELECT again.

- The rating is unlocked only temporarily and will be locked again when the inner cover is opened, or the player is set to the standby mode or turned off.

■ **To finish setting without changing the rating level**

Select "0" using the joystick/cursor buttons (▲, ▼) and press SELECT.

Setting is finished and the initial settings screen illustrated in step 1 on page 34 is displayed.

Note:

- When the rating is locked, settings cannot be changed unless the password is entered. Do not forget your password.

When "3 Menu Language" is selected

Select the language used in the On-Screen Display menus.

See page 34 for steps 1 and 2.

3 Tilt/press the joystick/cursor buttons (▲, ▼) to select the language and press SELECT.

DVD-L50A:

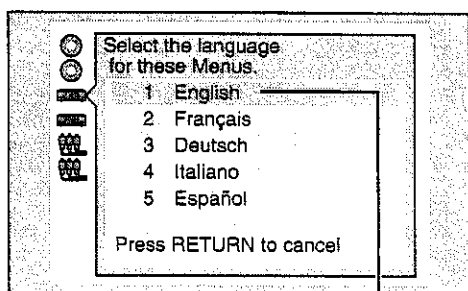

Factory preset

DVD-L50PM:

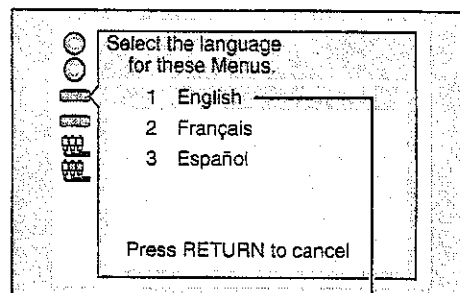

Factory preset

Setting is finished and the initial settings screen illustrated in step 1 on page 34 is displayed.

When "4 On-Screen Messages" is selected

Select whether "Play", "Still" and other displays will be displayed or not, and the color and position of "Play", "Still" and other displays as well as GUI screens.

See page 34 for steps 1 and 2.

3 Tilt/press the joystick/cursor buttons (▲, ▼) to select the item and press SELECT.

DVD-L50A:

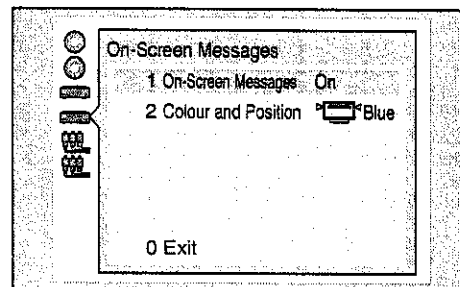

DVD-L50PM:

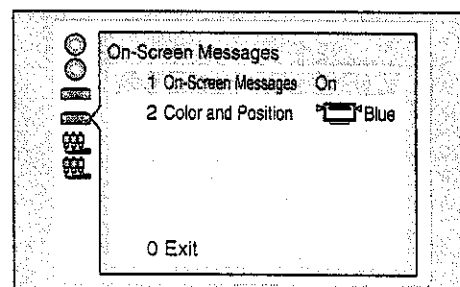

(Continued on the next page)

For Your Reference

Changing the initial settings

1 On-Screen Messages:

To select whether "Play", "Still" and other displays are displayed or not.

DVD-L50A:

2 Colour and Position:

DVD-L50PM:

2 Color and Position:

To select the color (Blue/Violet/Green) and position (above/slightly below) of "Play", "Still" and other displays as well as GUI screens.

4 Tilt/press the joystick/cursor buttons (▲, ▼) to select the setting and press SELECT.

■ When "1 On-Screen Messages" is selected







1 On (Factory preset)/2 Off

DVD-L50A:

■ When "2 Colour and Position" is selected

DVD-L50PM:

■ When "2 Color and Position" is selected

- | | | | | | |
|---|---|------------------|---|---|--------|
| 1 |  | Blue | 4 |  | Blue |
| | | (Factory preset) | | | |
| 2 |  | Violet | 5 |  | Violet |
| 3 |  | Green | 6 |  | Green |

Setting is finished and the screen illustrated in step 3 on page 37 is displayed.

For your reference:

- When  is selected, "Play", "Still", and other displays as well as GUI screens will be displayed lower than the factory setting. Choose this setting if the screen is only partially displayed.

When "5 TV Aspect" is selected

Select the appropriate TV aspect (4:3 or 16:9).

See page 34 for steps 1 and 2.

3 Tilt/press the joystick/cursor buttons (▲, ▼) to select the TV aspect and press SELECT.

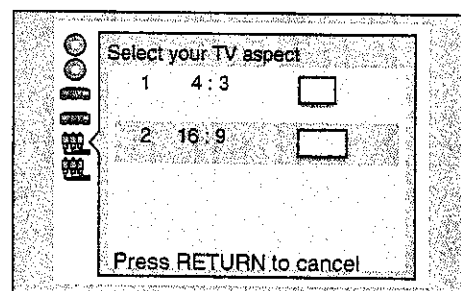

1 4:3:

Select when a conventional TV set is connected.

2 16:9 (Factory preset):

Select when a wide-screen TV set is connected or when the player's LCD is used.

Setting is finished and the initial settings screen illustrated in step 1 on page 34 is displayed.

Note:

- The setting for "5 TV Aspect" also affects the LCD screen of the player. (See page 41.) Select "2 16:9" when using the player's LCD.

When "6 Digital Audio Output" is selected

Select the digital output to be output from the audio input/output (optical digital audio output) connector of the player. (See page 46 for connection details.)



See page 34 for steps 1 and 2.

3 Tilt/press the joystick/cursor buttons (▲, ▼) to select the item and press SELECT.

DVD-L50A:

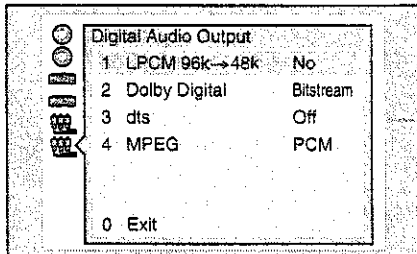

DVD-L50PM:

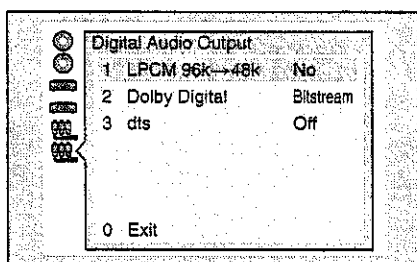

1 LPCM 96k→48k:

To select digital audio output during playback of DVDs recorded in 96 kHz Linear PCM. (In the case of the DVD recorded in 48 kHz Linear PCM, digital audio converted to 48 kHz/16 bit is output irrespective of the setting.)

2 Dolby Digital:

To select digital audio output during playback of the DVD recorded in Dolby Digital (AC-3).

3 dts:

To select digital audio output during playback of the DVD recorded in dts.

DVD-L50A only:

4 MPEG:

To select digital audio output during playback of the DVD recorded in MPEG audio.

4 Tilt/press the joystick/cursor buttons (▲, ▼) to select the setting and press SELECT.

■ When "1 LPCM 96k→48k" is selected

1 No (Factory preset):

- Digital audio of 48 kHz/16 bit is output in case of 48 kHz Linear PCM.
- No digital audio is output in case of 96 kHz Linear PCM.
- Audio will be output using the original audio recording system in case of DVDs not copyright-protected.

2 Yes:

During playback of DVDs recorded in 48 kHz or 96 kHz Linear PCM, digital audio converted to 48 kHz/16 bit is output.

(Digital output of PCM audio is restricted to 48 kHz/16 bit or below for copyright protection.)

■ When "2 Dolby Digital" is selected

1 Bitstream (Factory preset):

Dolby Digital (AC-3) bitstream (1ch–5.1ch) is output.

2 PCM:

Digital audio converted to 48 kHz/16 bit PCM (2ch) is output.

■ When "3 dts" is selected

1 Off (Factory preset):

No digital audio is output.

2 Bitstream:

dts bitstream is output.

DVD-L50A only:

■ When "4 MPEG" is selected

1 PCM (Factory preset):

Digital audio converted to 48 kHz/16 bit PCM (2ch) is output.

2 Bitstream:

MPEG audio bitstream (1ch–7.1ch) is output.

Setting is finished and the screen illustrated in step 3 is displayed.

Note:

- See page 42 for the recommended setting of "6 Digital Audio Output".

Changing the initial settings

When "3 Other Settings" is selected

Adjust other settings such as dynamic range compression, TV mode, etc.

See page 34 for steps 1 and 2.

3 Tilt/press the joystick/cursor buttons (▲, ▼) to select the item and press SELECT.

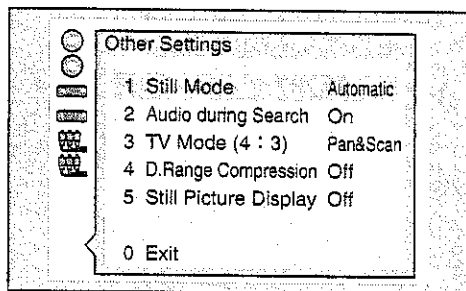

4 Tilt/press the joystick/cursor buttons (▲, ▼) to select the setting and press SELECT.

■ When "1 Still Mode" is selected

1 Automatic (Factory preset):

"Field still" and "Frame still" are automatically selected in the still picture mode.

2 Field:

"Field still" is always selected. Select this setting when jittering occurs in the pictures even when "1 Automatic" is selected.

3 Frame:

"Frame still" is always selected. Select this setting when small text or fine patterns cannot be seen clearly even when "1 Automatic" is selected.

■ When "2 Audio during Search" is selected

1 On (Factory preset):

Audio will be heard during search at the initial scan speed. (When audio during search at the initial scan speed is not desired, select "Off".)

2 Off:

Select this setting when audio during search at the initial scan speed is not desired.

■ When "3 TV Mode (4:3)" is selected

1 Pan & Scan (Factory preset):

The video material for a wide-screen will be played back in the Pan & Scan style on a conventional size TV. Video material not formatted in the Pan & Scan style will be played back in the letterbox style.

2 Letterbox:

The video material for a wide-screen will be played back in the letterbox style on a conventional size TV.

■ When "4 D. (Dynamic) Range Compression" is selected

1 Off (Factory preset):

Normal audio range is selected.

2 On:

Select this setting to enjoy listening to dynamic sound even on a low volume.

Dynamic range is the difference in volume between the quietest and loudest sounds heard. Dynamic Compression limits level for listening at low volume. This is useful late at night, for example.

[This function only works with Dolby Digital (AC-3) DVD.]

■ When "5 Still Picture Display" is selected

1 Off (Factory preset):

The picture type (I/P/B) (see page 57) will not be displayed on the screen in the still picture mode.

2 On:









The picture type (I/P/B) will be displayed on the screen in the still picture mode.

Setting is finished and the screen illustrated in step 3 is displayed.



Display modes of the LCD

Each time DISPLAY MODE is pressed, the display mode of the LCD changes as follows:

Type of software Mode	Software for wide-screen	Software (4:3)	Software (4:3, Letterbox)
NORMAL*	<p>Full screen</p> 	<p>Screen with black bands on the right and left.</p> 	<p>Letterbox</p> 
FULL	<p>Full screen</p> 	<p>The above screen is horizontally enlarged.</p> 	<p>The above screen is horizontally enlarged (with black bands at top and bottom).</p> 
ZOOM	<p>Top and bottom edges are cut off.</p> 	<p>Top and bottom edges of the above full screen are cut off.</p> 	<p>Full screen</p> 
OFF	Off	Off	Off

*Factory preset

Note:

- It is recommended to set the display mode to "OFF" to conserve power or to prevent battery consumption when an external TV set is connected.

For your reference:

- Turning the LCD display screen to OFF while playing music CDs reduces power consumption. This measure also conserves battery power when operating off the battery pack. (Under these conditions, the battery pack provides 4.5 hours of continuous playback when playing music CDs.)
- Horizontal lines may appear on the screen when the display mode is set to "ZOOM": this is normal.

Changing the initial settings

Recommended setting of the Digital Audio Output

Make settings as shown in table below, depending on the kind of equipment that is connected to the audio input/output (optical digital audio output) connector, using the optical digital audio cable.

Type of equipment to be connected	Recommended setting			
	1 LPCM 96k→48k	2 Dolby Digital	3 dts	4 MPEG*1
No equipment is connected	<u>1 No</u>	<u>1 Bitstream</u>	<u>1 Off</u>	<u>1 PCM</u>
Dolby Digital (AC-3) decoder (See page 46.)	2 Yes*2	<u>1 Bitstream</u>	<u>1 Off</u>	<u>1 PCM</u>
Dolby Digital (AC-3)/ dts decoder (See page 46.)	2 Yes*2	<u>1 Bitstream</u>	2 Bitstream	<u>1 PCM</u>
DVD-L50A only: Dolby Digital (AC-3)/ dts/MPEG audio decoder (See page 46.)	2 Yes*2	<u>1 Bitstream</u>	2 Bitstream	2 Bitstream

• Underlined items are a factory preset.

Note:

DVD-L50A:

- Do not connect to the digital audio input of an amplifier that does not have Dolby Digital (AC-3)/dts/MPEG audio decoder; if such an amplifier should be connected to the player with "Bitstream" selected at the "2 Dolby Digital", "3 dts" and/or "4 MPEG", any attempt to play DVD may cause such a high level of noise that it may be harmful to your ears and damage your speakers.

DVD-L50PM:

- Do not connect to the digital audio input of an amplifier that does not have Dolby Digital (AC-3)/dts decoder; if such an amplifier should be connected to the player with "Bitstream" selected at the "2 Dolby Digital" and/or "3 dts", any attempt to play DVD may cause such a high level of noise that it may be harmful to your ears and damage your speakers.

*1 "4 MPEG" setting is only for DVD-L50A.

*2 96 kHz LPCM sound is converted to 48 kHz 16 bit sound when this player is connected with an optical digital audio cable.

Do the following if you wish to take advantage of high quality 96 kHz sound.

Select "1 No" and connect this player's audio input/output (optical digital audio output) connector to an amplifier's audio input connector with the audio/video cable (included) or an audio cable (see page 44).

Note that LPCM, Dolby Digital, dts and MPEG signals will all be output in 2 channel, analog form.

Connection

- Ensure that this player and other equipment to be connected are set to the standby mode or off, and disconnect the AC cords, before commencing connection.
- Do not block ventilation holes of any of the equipment and arrange them so that air can circulate freely.
- Read through the instructions before connecting other equipment.
- Peripheral equipment and cords sold separately unless otherwise indicated.
- Ensure that you observe the color coding when connecting audio and video cables.
- During DVD play, TV volume may be a lower than during TV broadcasts, etc. If this is the case, adjust the volume to the desired level.
- The built-in stereo speakers may not provide satisfactory volume and sound quality depending on the disc. In this case, connect headphones or external speakers. (See pages 44, 46 and 47.)
- Select the appropriate screen type at the initial setting "5 TV Aspect" according to your TV set (4:3/16:9). (See page 38.)

Connecting to a stereo TV set

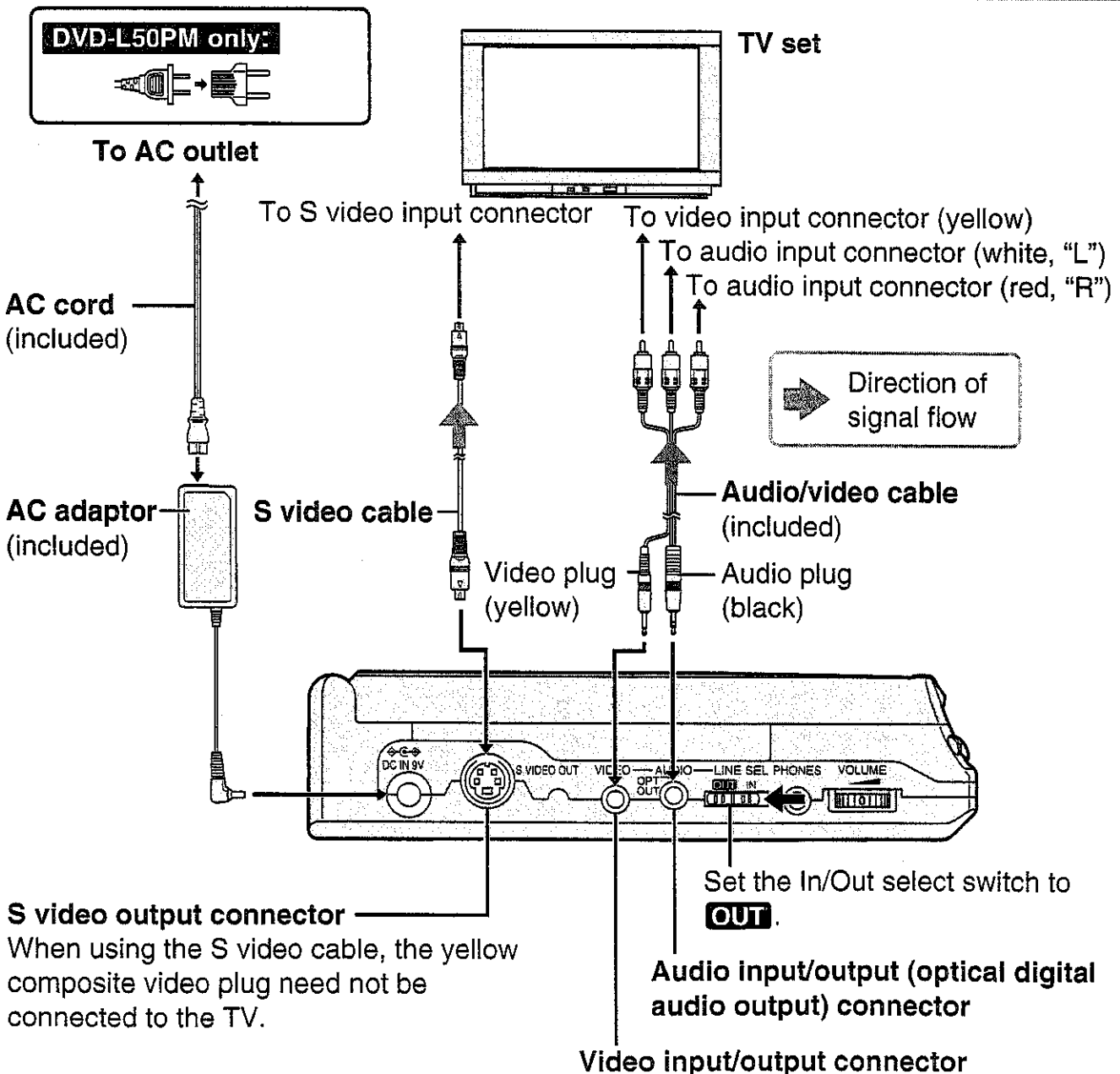

Connection

Connect Your Portable DVD/Video CD/CD Player Directly To Your TV Set.

If the player is connected to the TV through a video cassette recorder, the picture may not be played back normally with some DVDs. So we strongly recommend you not to connect the player to your video cassette recorder when setting up your home entertainment system.

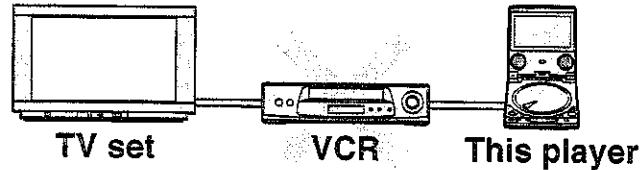

Regarding In/Out select switch [LINE SEL **OUT** IN]

OUT: Select when sending video or audio signals to an external device (such as a stereo or TV set) from the video input/output connector and audio input/output (optical digital audio output) connector. Normally, this setting should be used. (See pages 43, 44 and 46.)

IN: Select when sending video or audio signals from an external device such as a video camera to the video input/output connector and audio input/output (optical digital audio output) connector so that the images appear on the screen. (See page 47.)
(Be sure to return to the **OUT** position in normal playback.)

Connecting to audio equipment

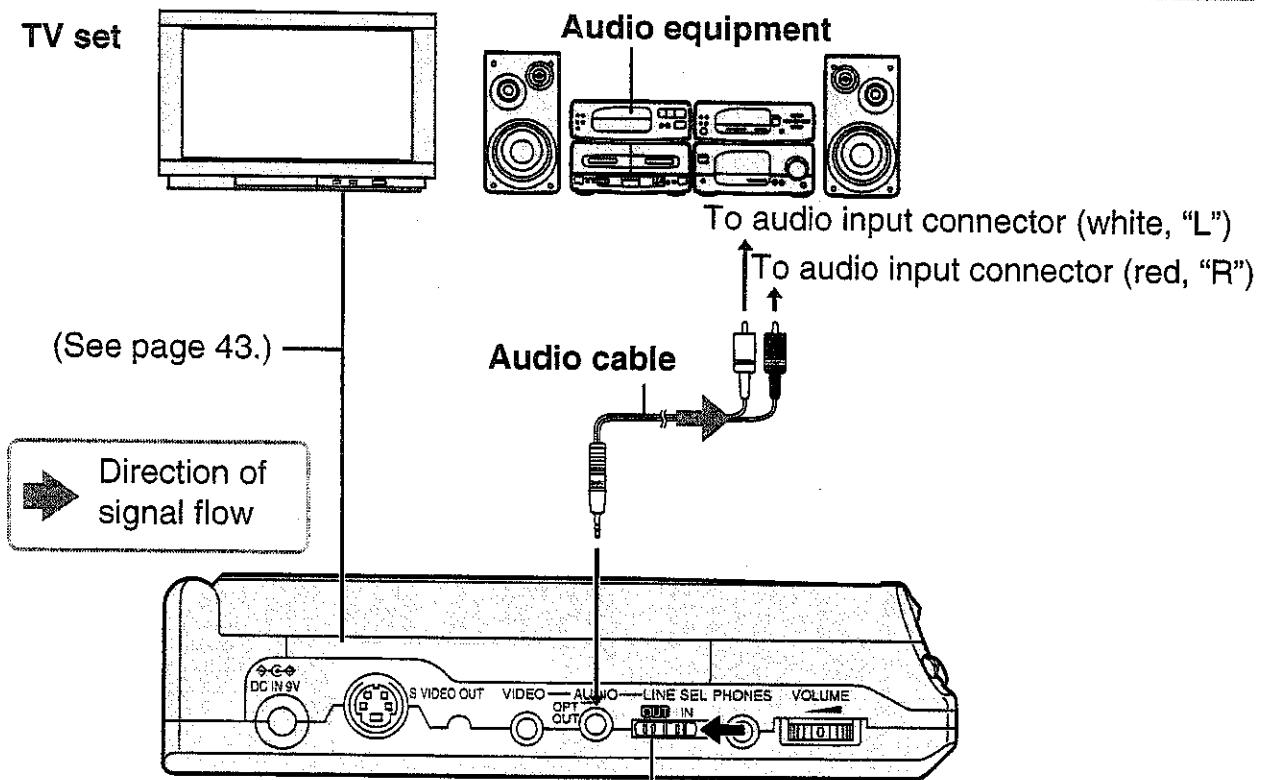

Set the In/Out select switch to **OUT**.

Note:

- If this connection is used, LPCM, Dolby Digital, dts (and MPEG) signals will all be output in 2 channel, analog form.

Ensure you select "1 No" in "1 LPCM 96k→48k" in "6 Digital Audio Output" (see pages 38 and 42) before playing DVDs recorded with 96 kHz LPCM.

Enjoying digital audio output from the audio input/output (optical digital audio output) connector

■ Concerning the audio output from the player's audio input/output (optical digital audio output) connector

When the optical digital audio cable is connected to the audio input/output (optical digital audio output) connector, digital audio is output as follows:

Disc	Sound recording format	Optical digital audio output from connector
DVD	Dolby Digital (AC-3)	<ul style="list-style-type: none"> ● Dolby Digital (AC-3) bitstream (1–5.1ch) ● PCM (48 kHz/16 bit) (2ch)*1 *2
	Linear PCM (48/96 kHz 16/20/24 bit)	<ul style="list-style-type: none"> ● Linear PCM (2ch) (48 kHz sampling/16 bit only) ● No output*2
	dts	<ul style="list-style-type: none"> ● dts bitstream (1–5.1ch) ● No output*2
	DVD-L50PM only: MPEG audio	<ul style="list-style-type: none"> ● PCM (2ch) (48 kHz/16 bit)*1 ● MPEG audio bitstream (1–7.1ch)*2
Video CD	MPEG 1	PCM (44.1 kHz sampling)*1
CD	Linear PCM	Linear PCM (44.1 kHz sampling)

*1 Compressed sound converted to PCM will be output.

*2 The type of audio output from the connector can be selected by "6 Digital Audio Output" of the initial settings. (See page 38.)

Note:

- Some dts decoders which do not support DVD-dts interface may not work properly with the player.

For your reference:

- If you have a Dolby Pro Logic Surround decoder, you will obtain the full benefit of Pro Logic from the same DVD movies that provide full 5.1-channel Dolby Digital soundtracks, as well as from titles with the Dolby Surround mark.

Caution for the audio input/output (optical digital audio output) connector:

DVD-L50A:

- Do not connect to the digital audio input of an amplifier that does not have Dolby Digital (AC-3)/dts/MPEG audio decoder.

DVD-L50PM:

- Do not connect to the digital audio input of an amplifier that does not have Dolby Digital (AC-3)/dts decoder.
- If such an amplifier should be connected to the player with "Bitstream" selected at the "2 Dolby Digital", "3 dts" (and/or "4 MPEG") (see page 38), any attempt to play DVD may cause such a high level of noise that it may be harmful to your ears and damage your speakers.
- Video CDs and CDs can be played as they would normally be played.

Connection

Connecting to a decoder with Dolby Digital (AC-3) or dts (digital theater systems) processing

When DVDs recorded in Dolby Digital or dts are played, Dolby Digital bitstream or dts bitstream is output from the player's audio input/output (optical digital audio output) connector. When the player is connected to a Dolby Digital decoder or dts decoder using the optical digital audio cable, you can enjoy theater-quality audio in your home.

DVD-L50A only:

- An MPEG audio decoder can also be connected to the player using the connection below. When DVDs recorded in MPEG audio are played, MPEG audio bitstream is output from the player's audio input/output (optical digital audio output) connector and you can enjoy theater-quality audio in your home.

Audio input/output (optical digital audio output) connector

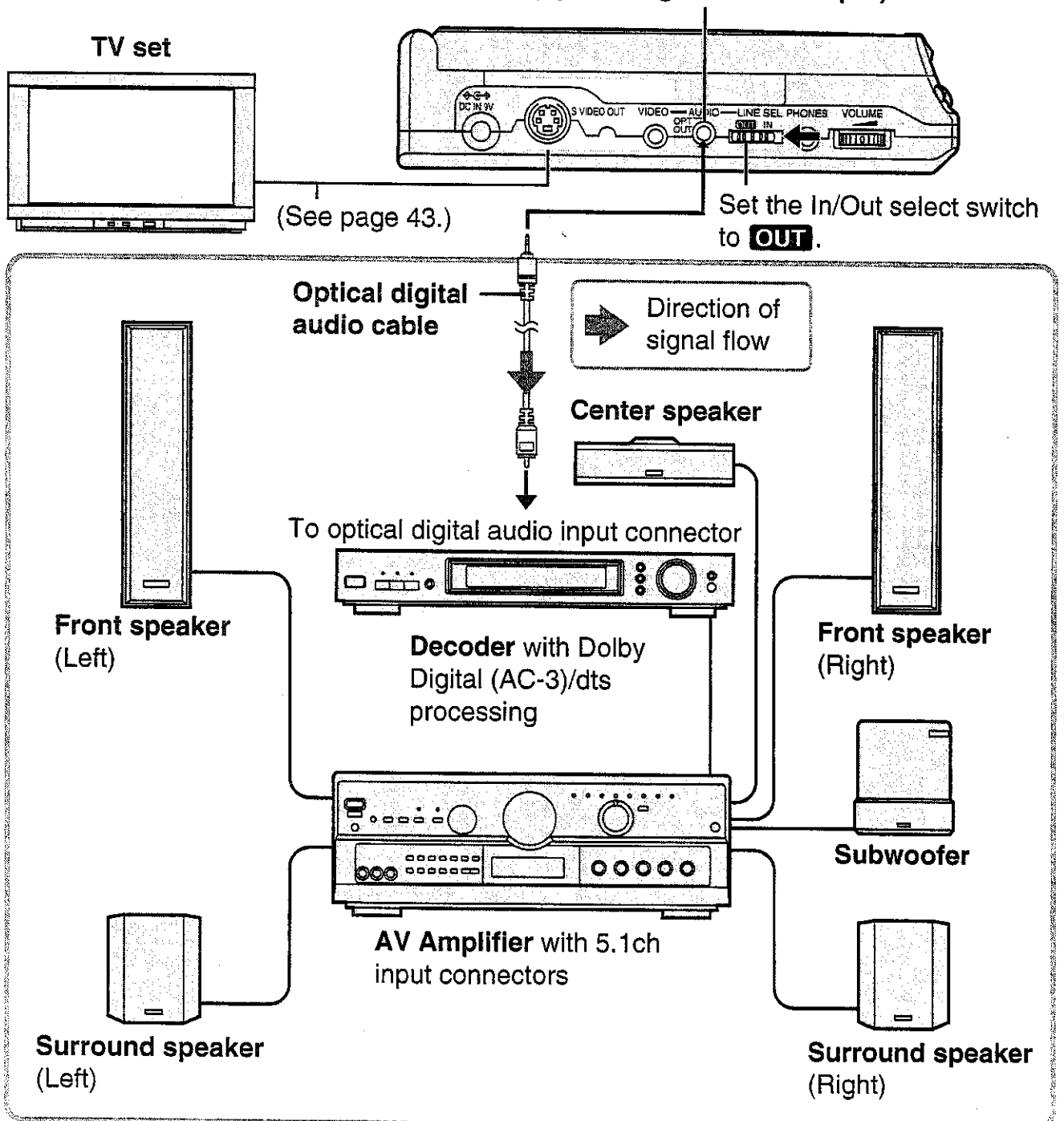

Playback from a video camera

The player's LCD screen and stereo speakers can be used to enjoy playback from a video camera.

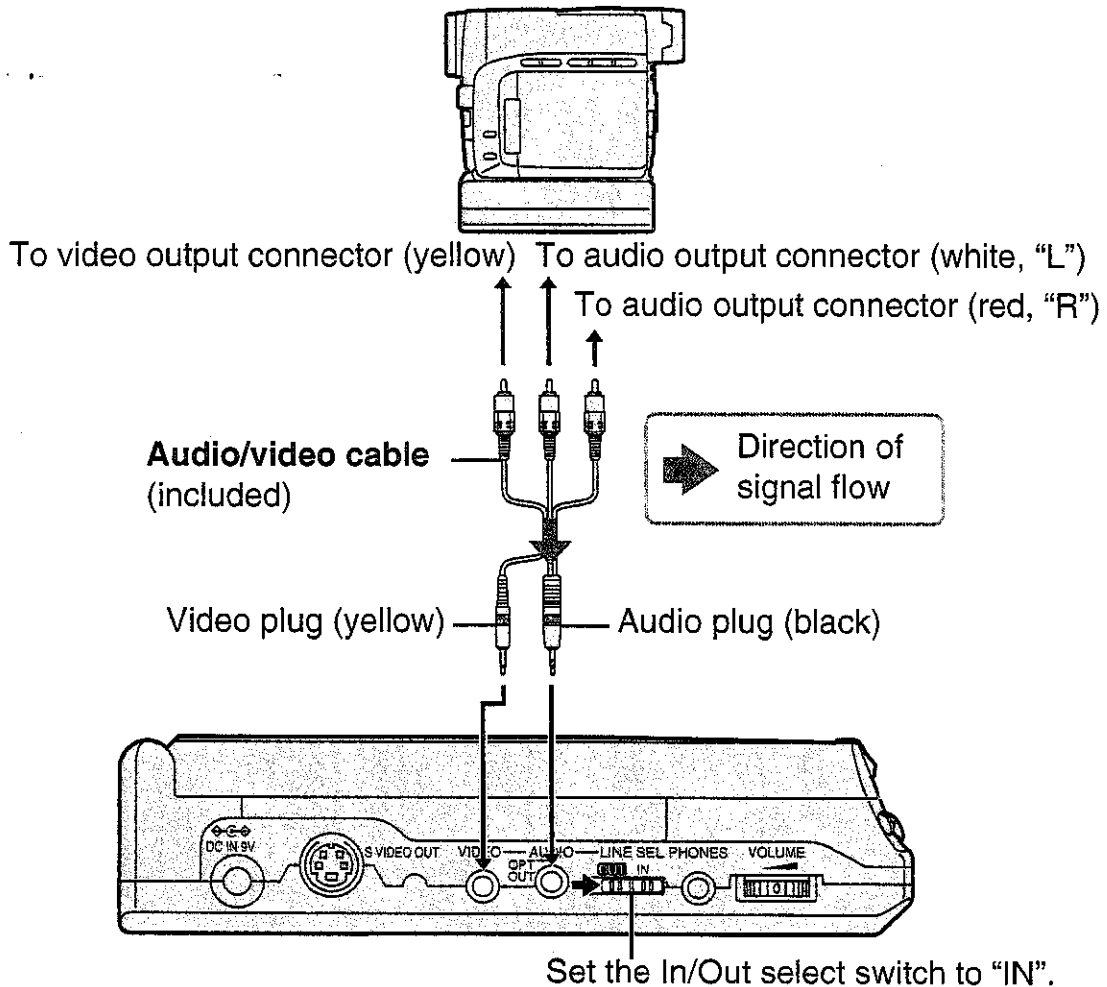

Connecting headphones

- Headphones with a 3.5 mm stereo plug can be connected.
- Turn down the volume level before connection, and then adjust the level.

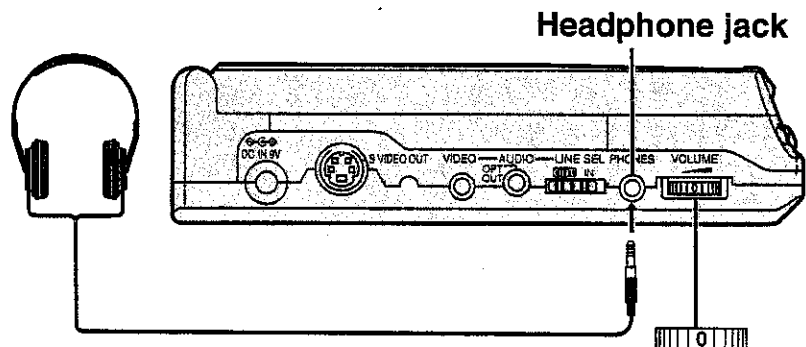

Caution:

- Avoid listening to the sound at levels which may be harmful to your ears.

For your reference:

- When the headphones are connected, no sound will be output from the player's stereo speakers.

Volume level [VOLUME]

Turn to adjust the volume level output from the headphones as well as from the built-in stereo speakers.

0: No sound is heard

10: Maximum

Troubleshooting

Before requesting service for this player, check the chart below for a possible cause of the problem you are experiencing. Some simple checks or a minor adjustment on your part may eliminate the problem and restore proper operation.

If you are in doubt about some of the check points, or if the remedies indicated in the chart do not solve the problem, consult your dealer for instructions.

■ Power

Symptom	Remedy	Reference page
No power.	<ul style="list-style-type: none"> ● Connect to the AC adaptor or the battery pack. ● The HOLD switch on the player's right-side panel is set to the "HOLD" position. Turn off the HOLD function. ● It is impossible to turn on the player with the PLAY (▶) button on the remote control unit if the player is powered by the battery pack. 	16, 17 21 —
The player is automatically set to the standby mode or the power turns itself off.	<ul style="list-style-type: none"> ● To conserve power or prevent battery consumption, the player is automatically set to the standby mode after approx. 15 minutes in the stop mode when powered by the AC adaptor, or after approx. 5 minutes when powered by the battery pack (Auto power-off function). Turn the power back to ON. 	—

■ Battery pack

Symptom	Remedy	Reference page
Charging is impossible.	<ul style="list-style-type: none"> ● Set the player to the standby mode, then start charging. (The battery pack cannot be charged while the player is ON.) 	18
	<ul style="list-style-type: none"> ● If the battery pack is warm, charging may take longer than usual or it may not be possible at all. Wait for the battery pack to cool before charging. 	18
The CHARGE (CHG) indicator does not light.	<ul style="list-style-type: none"> ● Detach the battery pack, and then attach it again. Alternatively, attach the battery pack to the player, use it for 10 to 20 minutes or so and then charge the battery pack again. 	17
The player cannot be operated using the battery pack.	<ul style="list-style-type: none"> ● If the battery pack overheats, its protective circuit may be activated, making it no longer possible to use the battery pack. 	—

■ Playback or other operation is impossible.

Symptom	Remedy	Reference page
No menu play of Video CD.	<ul style="list-style-type: none"> ● This function works only with Video CDs with playback control. 	56
No key operation (by the player and/or the remote control unit) is effective.	<ul style="list-style-type: none"> ● Some operations may be prohibited by the disc. ● The HOLD switch on the player's right-side panel is set to the "HOLD" position. Turn off the HOLD function. ● Press and hold STOP (□) to set the player to the standby mode and then back to ON. Alternatively, press and hold STOP (□) to set the player to the standby mode, disconnect the AC adaptor, and then re-connect it. (The player may not be operating properly due to lightning, static electricity or some other external factor.) 	— 21 —
<ul style="list-style-type: none"> ● Play fails to start even when PLAY (▷) is pressed. ● Play starts but then stops immediately. 	<ul style="list-style-type: none"> ● Condensation has formed: wait about 1 to 2 hours to allow the player to dry out. ● This player cannot play disc other than DVD, Video CD and CD. ● The disc may be dirty and may require cleaning. ● Ensure that the disc is installed with the label side to be played facing upwards. 	— 9 14 19
No operations can be performed with the remote control unit.	<ul style="list-style-type: none"> ● Check if the button-type battery is installed with the correct polarities (⊕ and ⊖). ● The button-type battery is depleted: replace it with a new one. ● Point the remote control unit at the remote control signal sensor and operate. ● Operate the remote control unit at a distance of not more than 7 meters from the remote control signal sensor. ● Remove the obstacles between the remote control unit and remote control signal sensor. ● The HOLD switch on the player's right-side panel is set to the "HOLD" position. Turn off the HOLD function. 	15 15 15 15 15 21
A-B repeat play does not work.	<ul style="list-style-type: none"> ● A-B repeat play works only within a title (DVD) or a track (Video CD/CD). (If the title/track is completed before B is specified, the end point of the title/track serves as B.) 	—

Troubleshooting

■ Playback or other operation is impossible.

Symptom	Remedy	Reference page
None of the initial settings can be changed.	<ul style="list-style-type: none"> ● After the player is set to the "Lock All" setting in "2 Ratings", none of the initial settings, including "2 Ratings", can be changed if the DVD disc is left inside the player. In this case, remove the disc, and unlock the player. 	35

■ No sound

Symptom	Remedy	Reference page
No sound from the external speakers of the stereo system or other equipment.	<ul style="list-style-type: none"> ● Ensure that the player is connected properly. ● Ensure that the input settings for the TV and stereo system are correct. ● The In/Out select switch on the player's left-side panel is set to "IN". Set it to "OUT". 	43-46 — 44
No sound from the stereo speakers.	<ul style="list-style-type: none"> ● When the outer cover of the player is closed, sound from the stereo speakers automatically turns off to conserve power and battery consumption. ● The volume level is set to "0" (No sound). 	— 47

■ No image or distorted image

Symptom	Remedy	Reference page
No image on the LCD screen.	<ul style="list-style-type: none"> ● Ensure that the In/Out select switch on the player's left-side panel is set properly. <ul style="list-style-type: none"> — To display the image from an external device such as a video camera, set it to "IN". — To play discs, set it to "OUT". ● The display mode of the LCD is set to "OFF". Select a mode other than "OFF". 	44 41
No image on the TV screen.	<ul style="list-style-type: none"> ● Ensure that the player is connected properly. ● Ensure that the input setting for the TV is "Video". ● The In/Out select switch on the player's left-side panel is set to "IN". Set it to "OUT". 	43 — 44

■ No image or distorted image

Symptom	Remedy	Reference page
No image is displayed on the LCD screen when a video camera or other device is connected to the player.	<ul style="list-style-type: none"> • Ensure that the player is connected properly. • Ensure that the video camera is turned on. • The In/Out select switch on the player's left-side panel is set to "OUT". Set it to "IN". • The display mode of the LCD is set to "OFF". Select a mode other than "OFF". 	47 — 44 41
The LCD screen is dark.	<ul style="list-style-type: none"> • Adjust the brightness of the LCD. 	20
Picture is distorted during rapid advance or rapid reverse.	<ul style="list-style-type: none"> • The picture will be somewhat distorted at times: this is normal. 	—
No 4:3 (16:9) picture on the TV screen.	<ul style="list-style-type: none"> • Choose the correct setup "5 TV Aspect" item which matches the TV set used. 	38
GUI screens not displayed or only partially displayed on the screen.	<ul style="list-style-type: none"> • Change the position of the GUI screens using "2 Colour and Position" ("2 Color and Position" only for DVD-L50PM) in a "4 On-Screen Messages" of the initial settings. 	37

■ DVD-specific functions (Title, Audio soundtrack, Subtitle)

Symptom	Remedy	Reference page
Play does not start even when title is selected.	<ul style="list-style-type: none"> • Confirm the "2 Ratings" setting. 	35
Alternative audio soundtrack (or subtitle) languages fail to be selected.	<ul style="list-style-type: none"> • An alternative language is not selected with discs which do not contain more than one language. • In the case of some discs, the alternative language cannot be selected by operating the AUDIO or SUBTITLE button. Try selecting it from the DVD menu if one is available. 	— 32

Regarding the LCD screen

This player provides a 280,000-pixel high-resolution LCD wide-screen, which lets you enjoy sharp images. However, a very small number of pixels may be luminous in black or in other colors: this results from a characteristic of the pixel and is not a malfunction.

Troubleshooting

■ DVD-specific functions

(Audio soundtrack, Subtitle, Angle, VSS, Menu language, Ratings)

Symptom	Remedy	Reference page
Audio soundtrack and/or subtitle language is not the one selected at the initial settings.	<ul style="list-style-type: none"> ● If the audio soundtrack and/or subtitle language does not exist on the disc, the language selected at the initial settings will not be seen/heard. 	—
No subtitles.	<ul style="list-style-type: none"> ● Subtitles appear only with discs which contain them. ● Subtitles are cleared from the screen. Perform the steps on page 31 to display the subtitles. ● Some subtitles recorded around point A or B may fail to appear during A–B repeat play. ● Some subtitles recorded around the marker may fail to appear. 	— 31 — —
The subtitle language does not change to the selected one immediately.	<ul style="list-style-type: none"> ● In some cases, the subtitle language is not changed to the selected one immediately. 	—
Angle cannot be changed.	<ul style="list-style-type: none"> ● This function is dependent on software availability. Even if a disc has a number of angles recorded, these angles may be recorded for specific scenes only. 	—
VSS function does not work.	<ul style="list-style-type: none"> ● This function does not work with DVD Karaoke discs. ● This function may not work with some Dolby Digital 2.1ch or 3.1ch DVDs. Additionally, this effect may not work properly with some Dolby Digital DVDs other than 2.1ch or 3.1ch, depending on the software. 	— —
The menu is not displayed in the preferred language.	<ul style="list-style-type: none"> ● Confirm the setting at the “3 Menu” of “1 Disc Languages”. 	34
The password for rating level has been forgotten. <ul style="list-style-type: none"> ● Reset all the settings to Factory Preset. 	<ul style="list-style-type: none"> ● While the player is in the stop mode, press and hold the player’s SKIP/SEARCH (◀◀) button and the PAUSE (⏸) button down simultaneously and then press and hold PLAY (▶) for longer than 3 seconds (until “Initialized” disappears from the screen). All initial settings will return to the default values. If you have selected “Lock All” in “2 Ratings”, you must remove the DVD from the player before performing this operation. (See the first remedy on page 50.) 	—

■ Others

Symptom	Remedy	Reference page
During playback of a CD, the GUI screen do not appear automatically.	●If play is stopped after the GUI screen have been cleared from the screen, the GUI screen will not appear automatically when play is resumed.	25
No On-Screen Display.	●The "Off" setting is selected for "1 On-Screen Messages" in "4 On-Screen Messages": select "On".	37
Shock-proof function (for preventing jumps in the sound during CD play) fails to work.	●Shock-proof function does not work when the optical digital audio cable is connected to the audio input/output (optical digital audio output) connector of the player's left-side panel.	—

Self-Diagnosis display function

When an error or trouble is detected during operation, a service number appears on the screen.

When a service number appears, check out the details given below.





Service number	Player status	Remedy
U11	●Disc is dirty.	●Wipe the disc clean.
H□□ □□ stands for a number.	●Trouble is likely to have occurred. The number following "H" depends on the status of the player.	●Press and hold STOP (□) to set the player to the standby mode and then back to ON. Alternatively, press and hold STOP (□) to set the player to the standby mode, disconnect the AC adaptor, and then re-connect it.

- If the service number fails to clear even when the remedial action is taken, ask a service technician to repair the player.

The following symptoms may be found during play or during charging of the battery pack: these are normal.

- The player or AC adaptor heats up during use.
- When the battery pack is detached and then re-attached during charging, the CHARGE (CHG) indicator goes off for an instant.
- Transmission noises are heard inside the AC adaptor during charging.
- The battery pack heats up after charging or during use.

When the STANDBY (⏻) indicator or the CHARGE (CHG) indicator flashes

STANDBY (⏻) indicator	
<p>The indicator flashes slowly.</p> 	<ul style="list-style-type: none"> •The LCD is closed when the player is ON. •The display mode of the LCD is set to "OFF" when the player is ON. •Even though the In/Out select switch is set to "IN", there is no video plug (yellow) connected to the video input/output connector.
<p>The indicator flashes quickly.</p> 	<ul style="list-style-type: none"> •A function button is pressed when the HOLD switch is set to the "HOLD" position. •A function button is pressed when the In/Out select switch is set to "IN".
CHARGE (CHG) indicator	
<p>The indicator flashes slowly.</p> 	<ul style="list-style-type: none"> •The remaining charge is low. [The power will soon be cut off (after a time period ranging from several minutes to about ten minutes.)]
<p>The indicator flashes quickly.</p> 	<ul style="list-style-type: none"> •The battery pack has overheated during charging. (Wait for the battery pack to cool off, then start charging.)
<p>The indicator flashes quickly.</p> 	<ul style="list-style-type: none"> •Though the battery pack has been charged for more than 12 hours, it cannot be fully charged for some reason. (Try charging again.)

 refers to the period when the indicator is ON.

Language code list

Code	Language
6565	Afar
6566	Abkhazian
6570	Afrikaans
6577	Ameharic
6582	Arabic
6583	Assamese
6588	Aymara
6590	Azerbaijani
6665	Bashkir
6669	Byelorussian
6671	Bulgarian
6672	Bihari
6678	Bengali; Bangla
6679	Tibetan
6682	Breton
6765	Catalan
6779	Corsican
6783	Czech
6789	Welsh
6865	Danish
6869	German
6890	Bhutani
6976	Greek
6978	English
6979	Esperanto
6983	Spanish
6984	Estonian
6985	Basque
7065	Persian
7073	Finnish
7074	Fiji
7079	Faroese
7082	French
7089	Frisian
7165	Irish
7168	Scots Gaelic
7176	Galician
7178	Guarani
7185	Gujarati
7265	Hausa
7273	Hindi
7282	Croatian
7285	Hungarian

Code	Language
7289	Armenian
7365	Interlingua
7378	Indonesian
7383	Icelandic
7384	Italian
7387	Hebrew
7465	Japanese
7473	Yiddish
7487	Javanese
7565	Georgian
7575	Kazakh
7576	Greenlandic
7577	Cambodian
7578	Kannada
7579	Korean
7583	Kashmiri
7585	Kurdish
7589	Kirghiz
7665	Latin
7678	Lingala
7679	Laotian
7684	Lithuanian
7686	Latvian, Lettish
7771	Malagasy
7773	Maori
7775	Macedonian
7776	Malayalam
7778	Mongolian
7779	Moldavian
7782	Marathi
7783	Malay
7784	Maltese
7789	Burmese
7865	Nauru
7869	Nepali
7876	Dutch
7879	Norwegian
7982	Oriya
8065	Punjabi
8076	Polish
8083	Pashto, Pushto
8084	Portuguese
8185	Quechua

Code	Language
8277	Rhaeto-Romance
8279	Romanian
8285	Russian
8365	Sanskrit
8368	Sindhi
8372	Serbo-Croatian
8373	Singhalese
8375	Slovak
8376	Slovenian
8377	Samoaan
8378	Shona
8379	Somali
8381	Albanian
8382	Serbian
8385	Sundanese
8386	Swedish
8387	Swahili
8465	Tamil
8469	Telugu
8471	Tajik
8472	Thai
8473	Tigrinya
8475	Turkmen
8476	Tagalog
8479	Tonga
8482	Turkish
8484	Tatar
8487	Twi
8575	Ukrainian
8582	Urdu
8590	Uzbek
8673	Vietnamese
8679	Volapük
8779	Wolof
8872	Xhosa
8979	Yoruba
9072	Chinese
9085	Zulu

Definition of terms

Title, Chapter (DVD)

DVDs are divided into large sections (titles) or small sections (chapters). Each section is numbered; these numbers are called "Title number" or "Chapter number".

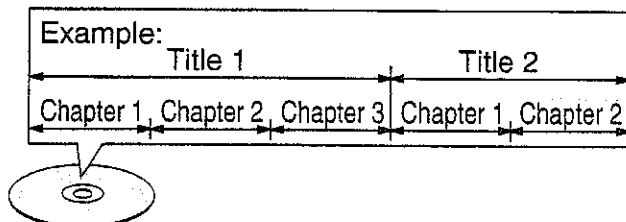

Track (Video CD/CD)

Video CDs or CDs are divided into sections (tracks). Each section is numbered; these numbers are called "Track number".

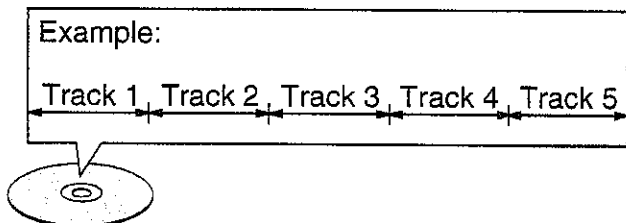

Interactive DVD

An interactive DVD is a DVD which includes multiple angles, multiple plot endings, etc.

Playback control (Video CD)

If the Video CD has "With Playback Control" written on the disc surface or on the jacket, the scenes or information to be viewed (or listened to) can be selected interactively with a menu.

In these instructions, playback using the menu screen is referred to as the "menu play" for Video CDs. This player supports Video CDs with playback control.

Frame

Individual images in a video or on the TV are called frames.

Frame still

Two fields are displayed, alternately, on the screen, so the image is blurry. Image quality is better than field images.

Field

Half of the video information (video signal) in a frame is called a field. With conventional TV systems, a signal frame (a single screen) consists of two fields.

Field still

Only one field (half of the video information) is displayed on the screen, so the apparent resolution is low. However, there is no blurring on the screen.

Pan & Scan screen

This refers to a screen on which part of the wide-screen picture (either at both sides or one side of the screen) is automatically eliminated so that the picture fills the whole screen.

Letterbox

This refers to a screen on which the playback picture of wide-screen DVDs or Video CDs appears with black bands inserted at the top and bottom of the screen to fill in the gaps where the size of the picture is smaller than the screen.

S video output connector

The S (separate) video output connector separates the color (C) and luminance (Y) signals before transmitting them to the TV set in order to achieve a sharper picture. Use the S video cable when connecting the player to a TV set equipped with an S video input connector for the best picture clarity possible.

Picture type (I/P/B)

The MPEG 2 standard adopted for DVD uses the following 3 picture types for the coding of each picture (frame) on the screen.

I: I-Picture (Intra coded picture)

This is the standard picture type, and each picture is coded separately. Since it features the best picture quality, it is recommended that the screen be frozen with I-Picture when the picture quality is to be adjusted.

P: P-Picture (Predictive coded picture)

This picture type is computed on the basis of a past I-Picture or P-Picture.

B: B-Picture (Bidirectionally-predictive coded picture)

This picture type is computed by comparing the previous and subsequent I-Picture or P-Picture. It has the lowest volume of information.

General Picture type

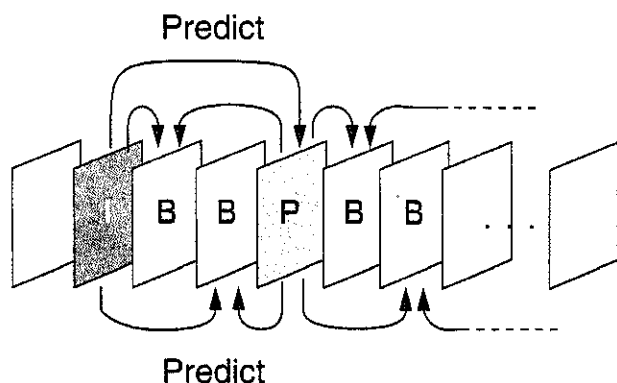

Digital audio output connector (Optical)

The digital audio output connector (optical) converts electrical signals into optical signals and transfers them to the amplifier. Consequently, it has a number of features including its immunity from electrical interference from external sources and its ability to prevent the generation of noise and its minimal effect on the external environment.

Dolby Digital (AC-3)

Dolby Digital (AC-3) is a digital sound compression technique developed by the Dolby Laboratories, Inc.

Supporting 5.1-channel surround sound, as well as stereo (2-channel) sound, this technique enables a large quantity of sound data to be efficiently recorded on a disc.

Manufactured under license from Dolby Laboratories. "Dolby", "AC-3", "Pro Logic" and the double-D symbol are trademarks of Dolby Laboratories. Confidential Unpublished Works. © 1992-1997 Dolby Laboratories, Inc. All rights reserved.

Dolby Pro Logic Surround decoder

This is a unit which uses the Dolby Surround (Pro Logic) system to restore 4-channel signals which were recorded on 2 channels back to the signals of 4 separate channels during playback. Compared with Dolby Digital (AC-3)/5.1 channel surround sound, the channel separation is not as good and surround signals can be reproduced only up to a frequency of 7 kHz.

dts (digital theater systems)

The digital theater systems (dts) is a 5.1-channel surround sound system, which is widely used in movie theaters around the world. It allows the bit rate to be increased in order to provide good sound quality without excessively compressing the data.

Linear PCM audio (LPCM)

This refers to a signal recording format used in a CD.

While a CD is recorded in 44.1 kHz/16 bit, a DVD is recorded in 48 kHz/16 bit up to 96 kHz/24 bit, thus achieving higher quality audio than that of a CD.

Specifications

Power source: DC 9.0 V (AC adaptor connector)/ DC 7.2 V (Exclusive battery connector) Power consumption: 16 W (10 W: Player only) (Approx. 2.0 W when power is off using the player or the remote control) [when the exclusive AC adaptor (included) is connected]	AC adaptor Part No. VSK0576 Power source: AC 100–240 V, 50/60 Hz Power consumption: 24 W DC output: 9 V, 2 A
--	---

Signal system:
DVD-L50A: PAL 625/50, PAL 525/60
DVD-L50PM: NTSC
Weight: 640 g
Dimensions: 140 (W)×151.5 (D)×37.7 (H) mm
 (when the LCD screen is closed,
 excluding protrusions)
Operating temperature range: +5 to +35°C
Operating humidity range: 5 to 90% RH
 (no condensation)
Discs played:
 (1) DVD-VIDEO disc
 12 cm single-sided, single-layer
 12 cm single-sided, dual-layer
 12 cm double-sided, single-layer
 8 cm single-sided, single-layer
 8 cm single-sided, dual-layer
 8 cm double-sided, single-layer
 (2) Compact disc (CD-DA, VIDEO CD)
 12 cm disc
 8 cm disc
LCD screen: 5" α -Si, TFT wide-screen LCD
S video output:
 Y output level: 1 Vp-p (75 Ω)
 C output level:
DVD-L50A: 0.3 Vp-p (75 Ω)
DVD-L50PM: 0.286 Vp-p (75 Ω)
 Output connector: S terminal (1 system)

Video output/input:
 Output/input level: 1 Vp-p (75 Ω)
 Output/input connector: Mini-jack
 (1 system, Output/Input selectable)
Audio output/input:
 Output/input level: 1.5 Vrms (1 kHz, 0 dB)
 Output/input connector: Stereo mini-jack
 (1 system, Output/Input selectable)
Audio signal output characteristics:
 (1) Frequency response:
 •DVD (linear audio):
 4 Hz–22 kHz (48 kHz sampling)
 4 Hz–44 kHz (96 kHz sampling)
 •CD audio: 4 Hz–20 kHz
 (2) S/N ratio:
 •CD audio: 115 dB
 (3) Dynamic range:
 •CD audio: 97 dB
Digital audio output:
 Optical digital output: Mini optical connector
 (Also used for audio output/input)
Pickup:
 Wave length: 660 nm/780 nm
 Laser power: CLASS 2/CLASS 3A

Specifications are subject to change without notice.
 Weight and dimensions are approximate.

Matsushita Electric Industrial Co., Ltd.
 Osaka 542-8588, Japan

© Matsushita Electric Industrial Co., Ltd. 1999

Printed in Japan

VQT8343
 F0799HH0(D)

Free Manuals Download Website

<http://myh66.com>

<http://usermanuals.us>

<http://www.somanuals.com>

<http://www.4manuals.cc>

<http://www.manual-lib.com>

<http://www.404manual.com>

<http://www.luxmanual.com>

<http://aubethermostatmanual.com>

Golf course search by state

<http://golfingnear.com>

Email search by domain

<http://emailbydomain.com>

Auto manuals search

<http://auto.somanuals.com>

TV manuals search

<http://tv.somanuals.com>