

Panasonic®

Operating Instructions

Portable DVD/CD Player

Model No. **DVD-LS865**
DVD-LS855



Dear customer

Thank you for purchasing this product.
For optimum performance and safety, please read these instructions carefully.
Before connecting, operating or adjusting this product, please read the instructions completely. Please keep this manual for future reference.

If you have any questions contact
1-800-211-PANA(7262)



Region number

The player plays DVD-Video marked with labels containing the region number "1" or "ALL".

Example:



The warranty can be found on page 19.

Unless otherwise indicated, illustrations in these operating instructions are of DVD-LS865.

IMPORTANT SAFETY INSTRUCTIONS

Read these operating instructions carefully before using the unit. Follow the safety instructions on the unit and the applicable safety instructions listed below. Keep these operating instructions handy for future reference.

- 1) Read these instructions.
- 2) Keep these instructions.
- 3) Heed all warnings.
- 4) Follow all instructions.
- 5) Do not use this apparatus near water.
- 6) Clean only with dry cloth.
- 7) Do not block any ventilation openings.
Install in accordance with the manufacturer's instructions.
- 8) Do not install near any heat sources such as radiators, heat registers, stoves, or other apparatus (including amplifiers) that produce heat.
- 9) Do not defeat the safety purpose of the polarized or grounding-type plug. A polarized plug has two blades with one wider than the other. A grounding-type plug has two blades and a third grounding prong. The wide blade or the third prong are provided for your safety. If the provided plug does not fit into your outlet, consult an electrician for replacement of the obsolete outlet.
- 10) Protect the power cord from being walked on or pinched particularly at plugs, convenience receptacles, and the point where they exit from the apparatus.
- 11) Only use attachments/accessories specified by the manufacturer.
- 12) Use only with the cart, stand, tripod, bracket, or table specified by the manufacturer, or sold with the apparatus. When a cart is used, use caution when moving the cart/apparatus combination to avoid injury from tip-over.
- 13) Unplug this apparatus during lightning storms or when unused for long periods of time.
- 14) Refer all servicing to qualified service personnel. Servicing is required when the apparatus has been damaged in any way, such as power-supply cord or plug is damaged, liquid has been spilled or objects have fallen into the apparatus, the apparatus has been exposed to rain or moisture, does not operate normally, or has been dropped.



WARNING:

TO REDUCE THE RISK OF FIRE, ELECTRIC SHOCK OR PRODUCT DAMAGE,

- DO NOT EXPOSE THIS APPARATUS TO RAIN, MOISTURE, DRIPPING OR SPLASHING AND THAT NO OBJECTS FILLED WITH LIQUIDS, SUCH AS VASES, SHALL BE PLACED ON THE APPARATUS.
- USE ONLY THE RECOMMENDED ACCESSORIES.
- DO NOT REMOVE THE COVER (OR BACK); THERE ARE NO USER SERVICEABLE PARTS INSIDE. REFER SERVICING TO QUALIFIED SERVICE PERSONNEL.

CAUTION!

DO NOT INSTALL OR PLACE THIS UNIT IN A BOOKCASE, BUILT-IN CABINET OR IN ANOTHER CONFINED SPACE. ENSURE THE UNIT IS WELL VENTILATED. TO PREVENT RISK OF ELECTRIC SHOCK OR FIRE HAZARD DUE TO OVERHEATING, ENSURE THAT CURTAINS AND ANY OTHER MATERIALS DO NOT OBSTRUCT THE VENTILATION VENTS.

CAUTION!

THIS PRODUCT UTILIZES A LASER. USE OF CONTROLS OR ADJUSTMENTS OR PERFORMANCE OF PROCEDURES OTHER THAN THOSE SPECIFIED HEREIN MAY RESULT IN HAZARDOUS RADIATION EXPOSURE. DO NOT OPEN COVERS AND DO NOT REPAIR YOURSELF. REFER SERVICING TO QUALIFIED PERSONNEL.

The socket outlet shall be installed near the equipment and easily accessible.

The mains plug of the power supply cord shall remain readily operable.

To completely disconnect this apparatus from the AC Mains, disconnect the power supply cord plug from AC receptacle.

Product Identification Marking is located on the bottom of units.

FCC Note:

This equipment has been tested and found to comply with the limits for a Class B digital device, pursuant to Part 15 of the FCC Rules. These limits are designed to provide reasonable protection against harmful interference in a residential installation. This equipment generates, uses and can radiate radio frequency energy and, if not installed and used in accordance with the instructions, may cause harmful interference to radio communications. However, there is no guarantee that interference will not occur in a particular installation. If this equipment does cause harmful interference to radio or television reception, which can be determined by turning the equipment off and on, the user is encouraged to try to correct the interference by one or more of the following measures:

- Reorient or relocate the receiving antenna.
- Increase the separation between the equipment and receiver.
- Connect the equipment into an outlet on a circuit different from that to which the receiver is connected.
- Consult the dealer or an experienced radio/TV technician for help.

Any unauthorized changes or modifications to this equipment would void the user's authority to operate this device.

This device complies with Part 15 of the FCC Rules. Operation is subject to the following two conditions: (1) This device may not cause harmful interference, and (2) this device must accept any interference received, including interference that may cause undesired operation.

Responsible Party:

Panasonic Corporation of North America
One Panasonic Way Secaucus, NJ 07094

Support Contact:

Panasonic Consumer Electronics Company
Telephone No.: 1-800-211-7262

The following mark and symbols are located on bottom of the unit.



CAUTION: TO REDUCE THE RISK OF ELECTRIC SHOCK, DO NOT REMOVE SCREWS. NO USER-SERVICEABLE PARTS INSIDE. REFER SERVICING TO QUALIFIED SERVICE PERSONNEL.



The lightning flash with arrowhead symbol, within an equilateral triangle, is intended to alert the user to the presence of uninsulated "dangerous voltage" within the product's enclosure that may be of sufficient magnitude to constitute a risk of electric shock to persons.



The exclamation point within an equilateral triangle is intended to alert the user to the presence of important operating and maintenance (servicing) instructions in the literature accompanying the appliance.

Listening caution



Do not play your headphones or earphones at a high volume. Hearing experts advise against continuous extended play.

If you experience a ringing in your ears, reduce volume or discontinue use.

Do not use while operating a motorized vehicle. It may create a traffic hazard and is illegal in many areas.

You should use extreme caution or temporarily discontinue use in potentially hazardous situations.

Even if your headphones or earphones are the open-air type designed to let you hear outside sounds, don't turn up the volume so high that you can't hear what's around you.

Sound can be deceiving. Over time your hearing "comfort level" adapts to higher volumes of sound. So what sounds "normal" can actually be loud and harmful to your hearing.

Guard against this by setting your equipment at a safe level BEFORE your hearing adapts.

To establish a safe level:

- Start your volume control at a low setting.
- Slowly increase the sound until you can hear it comfortably and clearly, and without distortion.

Once you have established a comfortable sound level:

- Leave it there.

Table of contents

Getting started

IMPORTANT SAFETY INSTRUCTIONS	2
Accessories	3
Preparations	
① Attaching the battery	4
② Recharging the battery	4
③ Adjusting the LCD angle	4
Discs that can be played	5

Playback

Playing discs	6
Useful functions	7
Playing CD using menus	7
Playing programs/playlists	7
Playing HighMAT™ discs	8
Playing WMA/MP3, JPEG and MPEG4/DivX	8
About DivX VOD content	9
Tips for making data discs	9

Settings

Using On-Screen Menus	10
Changing the player settings	13

Enjoying in various situations

Enjoying in a car	14
Using this unit with other equipment	15

Reference

Troubleshooting guide	16
Frequently asked questions	17
Maintenance	18
Specifications	18
Limited Warranty	19
Product Service	19
Index	Back cover

Accessories



Use numbers indicated in parentheses when asking for replacement parts.
(Product numbers correct as of February 2008. These may be subject to change.)

To order accessories, refer to "Accessory Purchases" on page 19.

- 1 **Audio/video cable** (K2KC4CB00026) **DVD-LS865**
- 1 **AC adaptor** (RFEA218C)
 - For use with this unit only. Do not use it with other equipment. Also, do not use cords for other equipment with this unit.
- 1 **Car DC Adaptor** (RFEC204M-AB)
- 1 **Headrest Mounting Bracket** (RXQ1405A)
- 1 **Rechargeable battery pack**

	Included	Optional
DVD-LS865	CGR-H712	CGR-H701
DVD-LS855	CGR-H711	CGR-H712

- Depending on the battery pack, playback time may differ. [→ 4, Approximate recharging and play times (Hours)]
- **DVD-LS855** CGR-H711 is not available as option. When purchasing a replacement, request one of the optional batteries listed above.

To prevent damage

Avoid the following:

- Spraying flammable insecticides near the unit.
- Pressing the LCD.
- Touching the lens and other parts of the laser pickup.

Do not use the unit in the following places:

- Sandy places such as beaches.
 - On top of cushions, sofas, or hot equipment such as amplifiers.
- Do not leave in an unventilated automobile or exposed to direct sunlight and high temperatures.

WARNING

DRIVER MUST NOT OPERATE OR VIEW THIS UNIT WHILE OPERATING THE VEHICLE.

Doing so will distract the driver and could cause a collision resulting in serious injury or property damage.

Do not rest the unit on your lap for a long time while using it. The unit can become hot and cause burns.

Batteries

1 Battery pack (Lithium ion battery pack)

- Use the specified unit to recharge the battery pack.
- Do not use the battery pack with equipment other than the specified unit.
- Do not use the player outside if it is snowing or raining. (The battery pack is not waterproof.)
- Do not get dirt, sand, liquids, or other foreign matter on the terminals.
- Do not touch the plug terminals (+ and -) with metal objects.
- Do not disassemble, remodel, heat or throw into fire.
- Do not heat or expose to flame.
- Do not leave the battery pack in an automobile exposed to direct sunlight for a long period of time with doors and windows closed.

If any electrolyte should come into contact with your hands or clothes, wash it off thoroughly with water.

If any electrolyte should come into contact with your eyes, never rub the eyes.

Rinse eyes thoroughly with water, and then consult a doctor.

2 Disposing of the batteries

Check and follow your local regulations before disposal.

A lithium ion battery that is recyclable powers the product you have purchased. Please call 1-800-8-BATTERY for information on how to recycle this battery.



AC adaptor

This AC adaptor operates on AC between 100 V and 240 V. But

- In the U.S.A. and Canada, the AC adaptor must be connected to a 120 V AC power supply only.
- When connecting to an AC supply outside of the U.S.A. or Canada, use a plug adaptor to suit the AC outlet configuration.

CAUTION-LASER RADIATION WHEN OPEN AND INTERLOCK DEFEATED. DO NOT STARE INTO BEAM. FDA 21 CFR / Class II

CAUTION-CLASS 1M VISIBLE AND INVISIBLE LASER RADIATION WHEN OPEN AND INTERLOCKS DEFEATED. DO NOT VIEW DIRECTLY WITH OPTICAL INSTRUMENTS.

IEC60825-1 +A2/ Class 1M

ATTENTION-RAYONNEMENT LASER VISIBLE ET INVISIBLE, CLASSE 1M, EN CAS D'OUVREURE ET LORSQUE LA SÉCURITÉ EST NEUTRALISÉE. NE PAS REGARDER DIRECTEMENT À L'AIDE D'INSTRUMENTS D'OPTIQUE.

(Bottom of product)

Warning

Risk of fire, explosion and burns. Do not disassemble, heat above 60°C (140°F) or incinerate.

CAUTION

Danger of explosion if battery is incorrectly replaced. Replace only with the same or equivalent type recommended by the manufacturer. Dispose of used batteries according to the manufacturer's instructions.

Preparations

1 Attaching the battery

(When the unit is off)

The illustrations shown are of CGR-H712; however the steps for CGR-H711 (included with [DVD-LS855](#)) or CGR-H701 (optional) are the same.

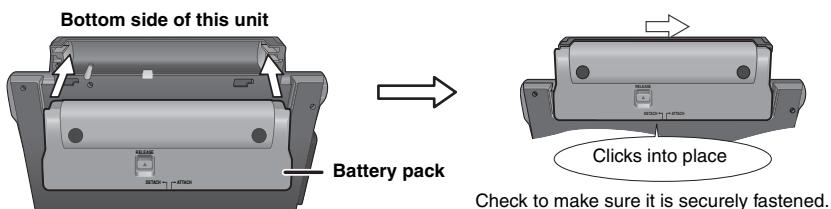

■ Detaching

- Turn the unit off before detaching the battery pack.

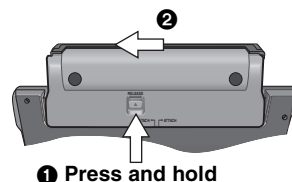

When not using for long periods of time

- Remove the battery pack (→ above).
(Even when the unit is turned off, there is a small amount of voltage running through the unit, and this may result in a malfunction.)
- Recharge the battery for re-use.

2 Recharging the battery

The battery is not charged at the time of purchase. Charge before initial use.

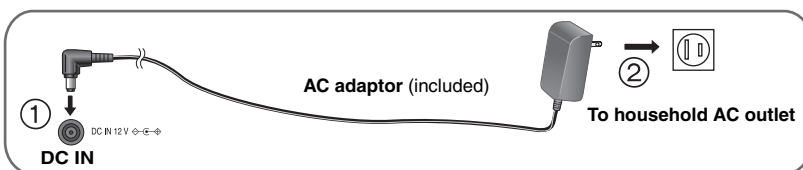

The unit is in the standby condition (the [⏻] indicator lights) when the AC adaptor is connected. The primary circuit is always "live" as long as the AC adaptor is connected to an electrical outlet.

To conserve power

This unit consumes 0.4 W of power even when turned off. When the unit is not going to be used for a long time, disconnect the AC adaptor from the household AC outlet.

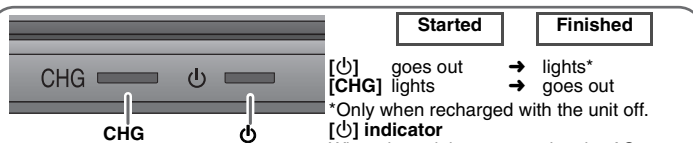
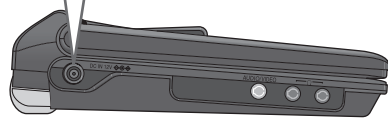

- You can also use this unit without charging while connecting the AC adaptor.
- You can also use this unit without charging while connecting Car DC Adaptor. (→ 15, Connecting the included Car DC Adaptor)

Recharging time:

→ below, Approximate recharging and play times (Hours)
When finished, disconnect the AC adaptor.

3 Adjusting the LCD angle

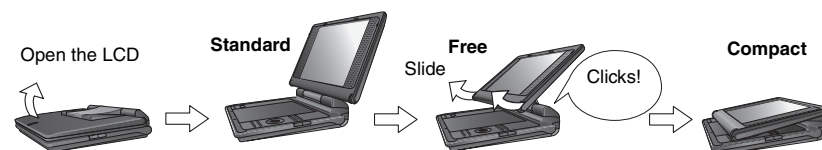

- When moving the unit : Close the LCD. Don't hold by the LCD.
- Functions operated by buttons on the unit will not work when the LCD is closed.

Approximate recharging and play times (Hours)

Battery pack	Recharging (When the unit is off) [at 20 °C (68 °F)]	Play (at room temperature using headphones)			
		LCD brightness level			LCD Off
		-5	0	5	
CGR-H711*1	4	6	3.5	2.5	8
CGR-H712*2	7	13	7	5	16
CGR-H701 (option)	4	5.5	3	2	7

*1 included with [DVD-LS855](#) (not available as option)

*2 included with [DVD-LS865](#)

- The times indicated on the left may differ depending on use.
- To change the LCD brightness (→ 7, When selecting "USER MODE").

Checking the remaining battery charge

When the unit is on (→ 6) and powered by the battery pack

Press [DISPLAY] to check on the LCD (Displays for a few seconds).

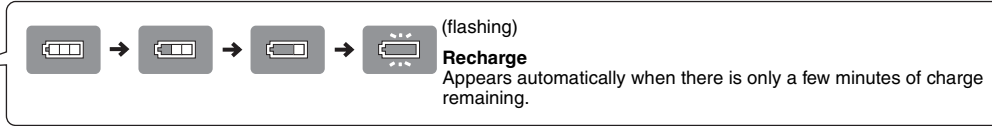
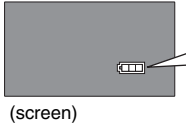

Discs that can be played

Commercial discs

Disc Logo	Indicated in these instructions by	Remarks
	DVD-V	High quality movie and music discs
	VCD	Music discs with video Including SVCD (Conforming to IEC62107)
	CD	Music discs

Discs that cannot be played

Blu-ray, HD DVD, discs recorded with AVCHD format, DVD-Audio, Version 1.0 of DVD-RW, DVD-ROM, CD-ROM, CDV, CD-G, SACD, Photo CD, DVD-RAM that cannot be removed from their cartridges, 2.6-GB and 5.2-GB DVD-RAM, PAL discs and "Chaoji VCD" available on the market including CVD, DVCD and SVCD that do not conform to IEC62107.

Recorded disc (○: Available —: Not available)

Disc Logo	Recorded on a DVD recorder, etc.		Recorded on a personal computer, etc.					Necessity of finalize*4
	DVD-VR *2	DVD-V *3	WMA	MP3	JPEG	MPEG4	DivX	
	○	—	—	○	○	○	○	Not Necessary
	○	○	—	○	○	○	○	Necessary
	○	○	—	—	—	—	—	Necessary
+R/+RW	—	(○)	—	—	—	—	—	Necessary
+R DL	—	(○)	—	—	—	—	—	Necessary
CD-R/RW*1	—	—	○	○	○	○	○	Necessary*5

• It may not be possible to play the above discs in all cases due to the type of discs, the condition of the recording, the recording method and how the files were created (→ 9, Tips for making data discs).

*1 This unit can play CD-R/RW recorded with CD-DA or Video CD format. (WMA MP3 JPEG This unit also plays HighMAT discs.)

*2 Discs recorded on DVD recorders, DVD video cameras, etc. using Version 1.1 of the Video Recording Format (a unified video recording standard).
For DVD-R DL: Discs recorded on DVD recorders or DVD video cameras, etc. using Version 1.2 of the Video Recording Format (a unified video recording standard).

*3 Discs recorded on DVD recorders or DVD video cameras, etc. using DVD-Video Format.

For +R/+RW and +R DL: Discs recorded using a format different from DVD-Video Format, therefore some functions cannot be used.

*4 A process that allows play on compatible equipment. To play a disc that is displayed as "Necessary" on this unit, the disc must first be finalized on the device it was recorded on.

*5 Closing the session will also work.

Note about using a DualDisc

- The digital audio content side of a DualDisc does not meet the technical specifications of the Compact Disc Digital Audio (CD-DA) format so play may not be possible.
- Do not use a DualDisc in this unit as it may not be possible to insert it correctly and it may get scratched or scraped.

Playing discs

Headphone terminals [🔊]
 ⌀ 3.5 mm (1/8") stereo mini jack

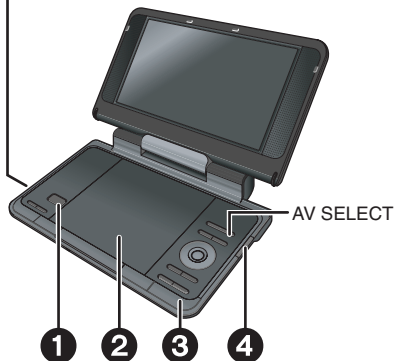

1



Open the lid.

2



Insert a disc and close the lid.

- Load double-sided discs so the label for the side you want to play is facing up.
- **DVD-RAM**: Remove discs from their cartridges before use.
- Some discs start to play automatically when the unit is on.

3



Press and hold.

The unit turns on and play begins.

- When "AUX" is displayed, press [AV SELECT] to select "DISC". (→ 15, Watching video from other equipment)

4



Adjust the volume.

When using headphones, turn down the volume before connection.

- To change the language on the display (→ 13, Menu Language)
- To play audio (**MP3**), picture (**JPEG**) or video (**MPEG4 DivX**) on DVD-RAM with recorded titles (**DVD-VR**), select "Play as Data Disc" (→ 12, Other Menu).
- While stopped, the unit automatically turns off once about 15 minutes (about 5 minutes when using the battery pack) have elapsed.
- Total title number may not be displayed properly on +R/+RW.
- If you are experiencing problems, refer to troubleshooting guide (→ 16).

Note

DISCS CONTINUE TO ROTATE WHILE MENUS ARE DISPLAYED. Press [■ -OFF] when you finish to preserve the unit's motor.

Operations

	Turn unit on/play	When the unit is off: Press and hold and the power comes on and play begins. When the unit is on: Press and play begins.
	Pause	Press [▶ ON] to restart play.
	Stop	The position is memorized when "Press PLAY to resume play" appears on the screen. • Press [▶ ON] to resume. (Resume play) Opening the disc lid or pressing [■ -OFF] while "Press PLAY to resume play" is displayed on the screen cancels the memorized position.
	Turn unit off	Press and hold until "OFF" is displayed.
	Skip	Press [◀◀, ▶▶]. DVD-VR Can also skip to the markers.
	Search	Press and hold [◀◀, ▶▶] (up to 5 steps). Press [▶ ON] to return to normal play.
	Slow play	DVD-VR DVD-V VCD Press and hold [◀◀, ▶▶] (up to 5 steps) while paused. Press [▶ ON] to return to normal play. VCD [▶▶] only
	Top menu	DVD-V
	Playing programs	DVD-VR (→ 7)
	Playback Menu	WMA MP3 JPEG MPEG4 DivX (→ 8)
	Menu	DVD-V
	Playing playlists	DVD-VR (→ 7)
	Navigation Menu	WMA MP3 JPEG MPEG4 DivX (→ 8)
	Return	Returns to the previous screen. VCD (with playback control) Returns to the menu.
	Menu operation	Press [▲ ▼ ◀ ▶] to select an item and press [ENTER] to confirm.
	Number Select	VCD (with playback control) ① While the disc menu is displayed, press [DISPLAY] to display On-Screen Menus. ② Press [▲ ▼] to select "Number Select". ③ Press [▶] then [▲ ▼] to enter number. • Press and hold [▲ ▼] to alter faster. ④ Press [ENTER].
	Frame-by-frame	DVD-VR DVD-V VCD While paused, press [◀ ▶]. VCD [▶] only
	Group skip	WMA MP3 JPEG MPEG4 DivX Press [▲ ▼]. • Does not work while paused.

Useful functions

Selecting how to show 4:3 aspect pictures on the LCD



- MONITOR NORMAL:** Normal
MONITOR FULL: Stretched horizontally
MONITOR OFF: No picture
- If you are not using the LCD on this unit, select "MONITOR OFF" to conserve power. (The [O] indicator flashes.)
 - The LCD turns off automatically if you close it.

Press to change.

Selecting the picture quality on the LCD



- DAYLIGHT:** Displays the picture a bit brighter.
MOONLIGHT: Displays the picture a bit darker.
USER MODE: → below

Press to change.

When selecting "USER MODE"

Press [▲ ▼] to select the item, and [◀ ▶] to change the setting.

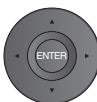

- BRIGHT:** Adjusts the brightness of the picture (-5 to 5)
COLOR: Adjusts the shade of the picture's color (-5 to 5)
- To exit the screen: Press [RETURN].

Displaying current playback condition (Quick OSD)

Basics



Press twice.

e.g. DVD-V

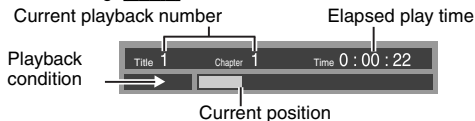

Details



Press three times.

e.g. DVD-V

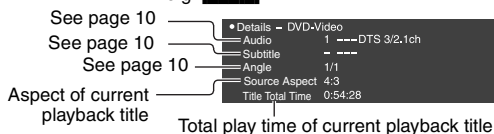

- **MPEG4 DivX** Video and audio information is not displayed during search.
- To exit the screen: Press [RETURN].

Repeat play

(Only when the elapsed play time can be displayed. **JPEG**: you can use even if there is no elapsed time display.)



During play, press several times to select the content to be repeated.



Playing CD using menus

CD

Titles appear with CD text playback.

1

e.g. CD text

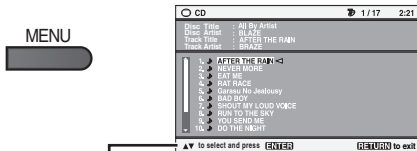

Press [DISPLAY] to switch between guide messages and the playback condition indicator.

2

Press [▲ ▼] to select the track and press [ENTER].

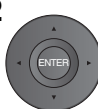

- To exit the screen: Press [RETURN].

Playback

Playing programs/playlists

DVD-VR

- Titles appear only if they have been entered.
- You cannot edit playlists and titles.

1

To play programs:

To play playlists:

- Only when the disc contains a playlist.

TOP MENU

MENU

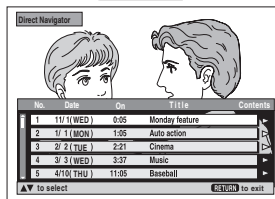

2

Press [▲ ▼] to select the program or playlist and press [ENTER].

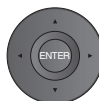

- Press [▶] to show the contents of the program (only when playing the program).
- To exit the screen: Press [RETURN].

Playing HighMAT™ discs

WMA MP3 JPEG

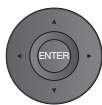

While the menu is displayed
Press [**▲ ▼ ◀ ▶**] to select items and press [**ENTER**].



Menu:
Takes you to the next menu which shows playlists or another menu.



Playlist:
Play starts.

- To return to the menu screen, press [**TOP MENU**] then press [**RETURN**] several times.
- To change the menu background, press [**DISPLAY**]. The background changes to the one recorded on the disc.
- To display/exit the screen: press [**TOP MENU**].

Selecting from the list

1. Press [**MENU**].
2. Press [**◀**] then [**▲ ▼**] to switch among "Playlist", "Group" and "Content" lists.
3. Press [**▶**] then [**▲ ▼**] to select an item and press [**ENTER**].

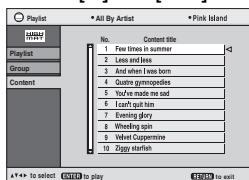

- To exit the screen: Press [**MENU**].

Playing WMA/MP3, JPEG and MPEG4/DivX

WMA MP3 JPEG MPEG4 DivX

- Select "Play as Data Disc" (→ 12, Other Menu) in the following cases:
- To play HighMAT discs without using the HighMAT function
 - To play audio (**MP3**), picture (**JPEG**) or video (**MPEG4 DivX**) on DVD-RAM with recorded titles (**DVD-VR**)
 - To return to playing titles (**DVD-VR**), select "Play as DVD-VR" in "Other Menu" (→ 12).

Playing items in order (Playback Menu)

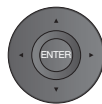

While the menu is displayed
Press [**▲ ▼**] to select "All", "Audio", "Picture" or "Video" and press [**ENTER**].

- To display/exit the screen: Press [**TOP MENU**].

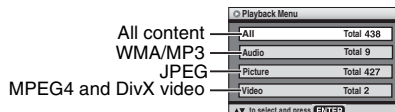

Playing from the selected item (Navigation Menu)

1

MENU
Press once.

2

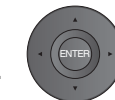

Press [**▲ ▼ ◀ ▶**] to select the group and press [**ENTER**].

- To play content in the group in order: Press [**ENTER**].
- To start play from the selected content: Press [**▲ ▼**] to select and press [**ENTER**].

Group and content number currently playing

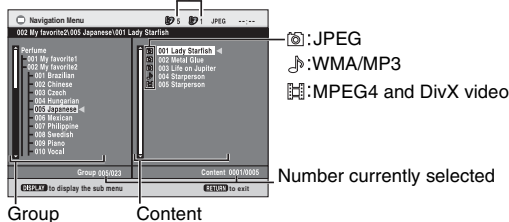

- To listen to WMA/MP3 while showing a JPEG image on the screen
Select a JPEG file first, and then select WMA/MP3. (The opposite order is not effective.)
- To exit the screen: Press [**MENU**].

Using the submenu

While the navigation menu (→ see above) is displayed.

- 1 Press [**DISPLAY**].
- 2 Press [**▲ ▼**] to select the sub menu and press [**ENTER**].

Submenu

✓ Multi	Groups and content
List	Content only
Tree	Groups only
Thumbnail	Thumbnail images JPEG
Next group	To the next group
Previous group	To the previous group
✓ All	All content
Audio	WMA/MP3 only
Picture	JPEG only
Video	MPEG4 and DivX video only
✓ Help display	To switch between guide messages and the playback condition indicator
Find	To search by group or content title (→ 9)

■ Searching by a group or content title

Press [◀ ▶] to highlight a group title to search a group, or a content title to search its content.

- 1 Select "Find" and press [ENTER]. (→ 8, Using the submenu)



- 2 Press [▲ ▼] to select a character and press [ENTER].
 - Repeat to enter another character.
 - Lower case is also searched.
 - Press and hold [◀▶] to skip between A, E, I, O and U.
 - Press [◀] to erase a character.
 - Erase the asterisk (*) to search for titles starting with that character.
- 3 Press [▶] to select "Find" and press [ENTER].
The search result screen appears.
- 4 Press [▲ ▼] to select the group or content and press [ENTER].

About DivX VOD content

DivX Video-on-Demand (VOD) content is encrypted for copyright protection. In order to play DivX VOD content on this unit, you first need to register the unit.

Follow the on line instructions for purchasing DivX VOD content to enter the unit's registration code and register the unit. For more information about DivX VOD, visit www.divx.com/vod.

Display the unit's registration code

(→ 13, DivX Registration)



- We recommend that you make a note of this code for future reference.
- After playing DivX VOD content for the first time, another registration code is then displayed in "DivX Registration". Do not use this registration code to purchase DivX VOD content. If you use this code to purchase DivX VOD content, and then play the content on this unit, you will no longer be able to play any content that you purchased using the previous code.
- If you purchase DivX VOD content using a registration code different from this unit's code, you will not be able to play this content. ("Authorization Error" is displayed.)

Regarding DivX content that can only be played a set number of times

Some DivX VOD content can only be played a set number of times. When you play this content, the remaining number of plays is displayed. You cannot play this content when the number of remaining plays is zero. ("Rental Expired" is displayed.)

When playing this content

- The number of remaining plays is reduced by one if
 - you turn off the unit or display "Setup" menu.
 - you press [■] twice.
 - you press [◀▶] (Skip or search) etc. and arrive at another content.

Tips for making data discs

Format: **WMA**

Disc: CD-R/RW

Extension: ".WMA", ".wma"

Reference:

- Compatible compression rate: between 48 kbps and 320 kbps
- You cannot play WMA files that are copy protected.
- This unit is not compatible with Multiple Bit Rate (MBR: a file that contains the same content encoded at several different bit rates).

Format: **MP3**

Disc: DVD-RAM, DVD-R/RW, CD-R/RW

Extension: ".MP3", ".mp3"

Reference:

- Sampling frequency:
DVD-RAM, DVD-R/RW : 11.02, 12, 22.05, 24, 44.1 and 48 kHz
CD-R/RW : 8, 11.02, 12, 16, 22.05, 24, 32, 44.1 and 48 kHz
- Compatible compression rate: between 32 kbps and 320 kbps
- This unit is not compatible with ID3 tags.

Format: **JPEG**

Disc: DVD-RAM, DVD-R/RW, CD-R/RW

Extension: ".JPG", ".jpg", ".JPEG", ".jpeg"

Reference:

- JPEG files taken on a digital camera that conform to DCF (Design rule for Camera File system) Standard Version 1.0 are displayed.
 - Files that have been altered, edited or saved with computer picture editing software may not be displayed.
- This unit cannot display moving pictures, MOTION JPEG and other such formats, still pictures other than JPEG (e.g. TIFF) or play pictures with attached audio.

Format: **MPEG4**

Disc: DVD-RAM, DVD-R/RW, CD-R/RW

Extension: ".ASF", ".asf"

Reference:

- You can play MPEG4 data [conforming to SD VIDEO specifications (ASF standard)/MPEG4 (Simple Profile) video system/G.726 audio system] recorded with the Panasonic SD multi cameras or DVD recorders with this unit.
- The recording date may differ from that of the actual date.

Format: **DivX**

Disc: DVD-RAM, DVD-R/RW, CD-R/RW

Extension: ".DIVX", ".divx", ".AVI", ".avi"

Reference:

- Plays all versions of DivX video (including DivX®6) [DivX video system/MP3, Dolby Digital or MPEG audio system] with standard playback of DivX® media files.
 - Functions added with DivX Ultra are not supported.
- DivX files greater than 2 GB or have no index may not play properly on this unit.
- This unit supports all resolutions up to maximum of 720 × 480.
- You can select up to 8 types of audio and subtitles on this unit.

- If groups were created away from the root like "002 group" in the illustration below, the eighth one and onwards is displayed on the same vertical line in the menu screen.
- There may be differences in the display order on the menu screen and computer screen.
- This unit cannot play files recorded using packet writing.

Naming folders and files on data discs

(Files are treated as contents and folders are treated as groups on this unit.)

At the time of recording, prefix folder and file names. This should be with numbers that have an equal number of digits, and should be done in the order you want to play them (this may not work at times).

e.g. **MP3**
root

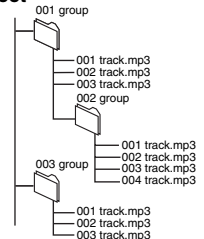

DVD-RAM

- Discs must conform to UDF 2.0.



DVD-R/RW



- Discs must conform to UDF bridge (UDF 1.02/ISO9660).
- This unit is not compatible with multi-session. Only the default session is played.

CD-R/RW

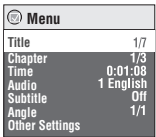
- Discs must conform to ISO9660 level 1 or 2 (except for extended formats).
- This unit is compatible with multi-session but if there are a lot of sessions it takes more time for play to start. Keep the number of sessions to a minimum to avoid this.

Using On-Screen Menus

- 1**  Press once.
- e.g. 
- 2** 
- ① Press [**▲ ▼**] to select the menu.
 - ② Press [**ENTER**] to go to the next menu and [**▲ ▼**] to select the item.
 - ③ Press [**ENTER**] to confirm.
- Repeat steps if necessary.
- Items shown differ depending on the type of software.
 - Some items can be changed by pressing [**▶**] instead of [**ENTER**].
 - Some functions only work during playback.
 - Press [**◀**] to go to the previous menu. If this is not possible, exit the screen (→ below) and repeat the above steps to go to the previous menu.
 - To exit the screen: Press [**RETURN**].

Main menu	
Program, Group, Title Chapter, Track, Playlist Content	<p>To start from a specific item</p> <ul style="list-style-type: none"> • Press [▲ ▼] to select and press [ENTER]. • Press and hold [▲ ▼] to alter faster.
Time	<p>To skip incrementally or decrementally (Time Slip for play only) DVD-VR DVD-V (Except +R/+RW) DivX</p> <ol style="list-style-type: none"> 1. Press [ENTER] twice to show Time Slip indicator. 2. Press [▲ ▼] to select the time and press [ENTER]. <ul style="list-style-type: none"> • Press and hold [▲ ▼] to alter faster. <p>To change remaining/elapsed time display</p>
Video	<p>To display pixel number DivX fps (frame per second) is also displayed.</p>
Audio	<p>To change soundtracks (Motion pictures) DVD-VR DivX "L", "R" or "L R" can be selected.</p> <p>VCD "L", "R", "L R" or "L + R" can be selected.</p> <p>DVD-V (Karaoke discs) ① Press [▲ ▼] to select "Vocal". ② Press [ENTER] then [▲ ▼] to select the item. ③ Press [ENTER]. Read the disc's instructions for details.</p> <p>Signal type/data LPCM/DD Digital/DTS/MP3/MPEG: Signal type kHz (Sampling frequency)/bit/ch (Number of channels) Example: 3/2 .1ch</p> <ul style="list-style-type: none"> .1: Low frequency effect (not displayed if there is no signal) 0: No surround 1: Mono surround 2: Stereo surround (left/right) 1: Center 2: Front left+ Front right 3: Front left+ Front right+ Center 
Number Select VCD (with playback control)	<p>To enter number (→ 6)</p> <ul style="list-style-type: none"> • Press and hold [▲ ▼] to alter faster.
Thumbnail	<p>To show thumbnail images</p>
Subtitle	<p>To change subtitles (Discs with subtitles)</p> <ol style="list-style-type: none"> ① Press [ENTER] then [▲ ▼] to select "Off" or "On" and the subtitle language. ② Press [ENTER]. <ul style="list-style-type: none"> • On +R/+RW, a subtitle number may be shown for subtitles that are not displayed. • DVD-VR (with subtitle on/off information) <ul style="list-style-type: none"> – On or Off only can be selected. – Subtitle on/off information cannot be recorded using Panasonic DVD Recorders. 
Marker (VR)	<p>To recall a marker recorded on DVD recorders</p>
Angle	<p>To select angles DVD-V with multiple angles</p>
Rotate Picture	<p>To rotate the picture ("Right" or "Left")</p>
Slideshow	<p>To turn on/off slideshow To change the slideshow timing ("1 Fast" to "5 Slow")</p> <ul style="list-style-type: none"> • When using Slideshow, Skip/Rotate picture may not work correctly depending on the play position.
Other Settings	<p>(→ 11)</p>

Other Settings

Play Speed	DVD-VR DVD-V Normal ×0.6 to ×1.4 (in 0.1 units)	
	<ul style="list-style-type: none"> Press [▶ ON] to return to normal play. After you change the speed, H.Bass, Advanced Surround and Sound Enhancement (→ below) do not work. This may not work depending on the disc's recording. 	

Play Menu (Only when the elapsed play time can be displayed.)

JPEG: The Repeat function can be used.)

Repeat	Select an item to be repeated.	
A-B Repeat Repeating a specified section	Except DVD-VR (still picture part) MPEG4 DivX and JPEG Press [ENTER] at the starting and ending points. <ul style="list-style-type: none"> Press [ENTER] again to cancel. 	

Advanced Disc Review Reviewing titles/programs to play	DVD-VR DVD-V (Except +R/+RW) Press [▶ ON] when you find a title/program to play.	
	<ul style="list-style-type: none"> You can also review each 10 minutes. Select "Interval Mode" (→ 13, "Advanced Disc Review" in "Disc" tab). This may not work depending on the play position. DVD-VR Does not work: <ul style="list-style-type: none"> with still picture part. when playing a playlist. 	

Picture Menu

Picture Mode <ul style="list-style-type: none"> Providing the suitable picture quality for enjoying movies (Cinema1/Cinema2) Reducing noise in pictures (Depth Enhancer/MPEG DNR) 	Normal: Normal images Cinema1: Mellows images and enhances detail in dark scenes. Cinema2: Sharpens images and enhances detail in dark scenes. User: Picture Adjustment (→ below)	
	<ul style="list-style-type: none"> This feature may not work depending on the disc's recording. 	

Picture Adjustment

- Depth Enhancer:** Reduces the rough noise in the background to give a greater feeling of depth.
- MPEG DNR:** Smooths block noise and reduces the smudging that appears around contrasting sections of the picture

- Press [▲ ▼] to select "Picture Adjustment" and press [ENTER].
- Press [▲ ▼] to select "Depth Enhancer" or "MPEG DNR".
- Press [◀ ▶] to change the setting. (Depth Enhancer: 0 to +4, MPEG DNR: 0 to +3)

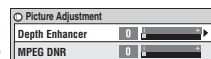

- This feature may not work depending on the disc's recording.

Source Select	DivX	
	When you select "Auto" the constructing method of the DivX contents is automatically distinguished and output. If the picture is distorted, select "I (Interlace)" or "P (Progressive)" depending on which constructing method was used when the contents were recorded to disc.	
	Auto, I (Interlace), P (Progressive)	

Audio Menu

H.Bass Enjoying heavy bass with the speakers	DVD-V DVD-VR On ↔ Off	
	<ul style="list-style-type: none"> This is effective on 5.1 channel DVD-Video and DVD-VR discs. This is also effective on some portions of 2 channel discs as well. If the sound is distorted or there is noise, set to "Off". This feature may not work depending on the disc's recording. 	

Advanced Surround Enjoying virtual surround	Motion pictures with 2 or more channels "SP 1 Natural", "SP 2 Enhanced", "HP 1 Natural" or "HP 2 Enhanced" A surround sound effect can be made using 2 speakers (on other equipment).	
	<ul style="list-style-type: none"> When using headphones, press to select "HP 1 Natural" or "HP 2 Enhanced". When using discs recorded with surround sound, sound seems to come from speakers on either side of you. Optimum seating position is 3 to 4 times the distance between the front left and right speakers or the width of the television if using the television's speakers. This does not work when H.Bass (→ above) is on. Do not use in combination with surround effects on other equipment. 	

Dialogue Enhancer Making the dialogue in movies easier to hear	DVD-V (Dolby Digital, DTS, 3-channel or over, with the dialogue recorded in the center channel)	
	DivX (Dolby Digital, 3-channel or over, with the dialogue recorded in the center channel) On ↔ Off	

Sound Enhancement Enjoying comfortable, analog-like sound	DVD-VR DVD-V (recorded with 48 kHz only) VCD CD	
	WMA MP3 (recorded with other than 8 kHz, 16 kHz or 32 kHz) On ↔ Off	
	<ul style="list-style-type: none"> This feature does not work with MP3 on DVD-RAM or DVD-R/RW. This does not work when H.Bass or Advanced Surround (→ above) is on. This may not work depending on the disc's recording. 	

(Continued on the next page)

Using On-Screen Menus

(Continued)
Display Menu

Information	On \longleftrightarrow Off
Subtitle Position	0 to -60 (in 2 units)
Subtitle Brightness	Auto, 0 to -7
Just Fit Zoom	<p>Motion pictures To expand the letterbox picture to fit the screen. Press [\blacktriangle \blacktriangledown] to select the preset aspect ratio or "Auto". DVD-VR DVD-V IVCD Auto \longleftrightarrow 4:3 Standard \longleftrightarrow European Vista \longleftrightarrow 16:9 Standard \uparrow \rightarrow Cinemascope2 \longleftrightarrow Cinemascope1 \longleftrightarrow American Vista \longleftrightarrow • Depending on the disc, the preset aspect ratio may not be displayed. MPEG4 DivX Standard \longleftrightarrow Original \uparrow \rightarrow Full \longleftrightarrow</p>
Manual Zoom	<p>Motion pictures Press [\blacktriangle \blacktriangledown] for fine adjustments. (Press and hold to alter faster.) - from $\times 1.00$ to $\times 1.60$ (in 0.01 units) - from $\times 1.60$ to $\times 2.00$ (in 0.02 units) MPEG4 DivX only - from $\times 2.00$ to $\times 4.00^*$ (in 0.05 units) *It may not be possible to zoom up to $\times 4.00$ depending upon the connected television and its settings or recording conditions.</p>
Bit Rate Display	Motion pictures On \longleftrightarrow Off
GUI See-through	Off, On, Auto (Switches on automatically when the images appear on the display.)
Other Menu	
Setup	(\rightarrow 13)
Play as DVD-VR Play as HighMAT or Play as Data Disc	<p>Select "Play as Data Disc" in the following cases: - To play HighMAT discs without using the HighMAT function - To play audio (MP3), picture (JPEG) or video (MPEG4 DivX) on DVD-RAM with recorded titles (DVD-VR) • To return to playing titles (DVD-VR), select "Play as DVD-VR".</p>

Language code list

Abkhazian: 6566	Bulgarian: 6671	French: 7082	Italian: 7384	Malay: 7783	Quechua: 8185	Spanish: 6983	Urdu: 8582
Afar: 6565	Burmese: 7789	Frisian: 7089	Japanese: 7465	Malayalam: 7776	Rhaeto-Romance: 8385	Sundanese: 8385	Uzbek: 8590
Afrikaans: 6570	Byelorussian: 6669	Galician: 7176	Javanese: 7487	Maltese: 7784	Swahili: 8387	Swahili: 8387	Vietnamese: 8673
Albanian: 8381	Cambodian: 7577	Georgian: 7565	Kannada: 7578	Maori: 7773	Romanian: 8279	Swedish: 8386	Volapük: 8679
Ameharic: 6577	Catalan: 6765	German: 6869	Kashmiri: 7553	Marathi: 7792	Russian: 8285	Tagalog: 8476	Welsh: 6789
Arabic: 6582	Chinese: 9072	Greek: 6976	Kazakh: 7575	Moldavian: 7779	Samoan: 8377	Tajik: 8471	Wolof: 8779
Armenian: 7289	Corsican: 6779	Greenlandic: 7576	Kirghiz: 7589	Mongolian: 7778	Sanskrit: 8365	Tamil: 8465	Xhosa: 8872
Assamese: 6583	Croatian: 7282	Guarani: 7178	Korean: 7579	Nauru: 7865	Scots Gaelic: 7168	Tatar: 8484	Yiddish: 7473
Aymara: 6589	Czech: 6783	Gujarati: 7185	Kurdish: 7585	Nepali: 7869	Serbian: 8382	Telugu: 8469	Yoruba: 8979
Azerbaijani: 6590	Danish: 6865	Hausa: 7265	Laotian: 7679	Norwegian: 7879	Serbo-Croatian: 8372	Thai: 8472	Zulu: 9085
Bashkir: 6665	Dutch: 7876	Hebrew: 7387	Latin: 7665	Oriya: 7982	Shona: 8378	Tibetan: 6679	
Basque: 6985	English: 6978	Hindi: 7273	Latvian, Lettish: 7686	Pashto, Pushto: 8083	Sindhi: 8368	Tigrinya: 8473	
Bengali, Bangla: 6678	Esperanto: 6979	Hungarian: 7285	Lingala: 7678	Persian: 7065	Sinhalese: 8373	Tonga: 8479	
Bhutanian: 6890	Estonian: 6984	Icelandic: 7383	Lithuanian: 7684	Polish: 8076	Slovak: 8375	Turkish: 8482	
Bihari: 6672	Farose: 7079	Indonesian: 7378	Macedonian: 7775	Portuguese: 8084	Slovenian: 8376	Turkmen: 8475	
Breton: 6682	Fiji: 7074	Interlingua: 7365	Malagasy: 7771	Punjabi: 8065	Somali: 8379	Twi: 8487	
	Finnish: 7073	Irish: 7165				Ukrainian: 8575	

Manufactured under license from Dolby Laboratories. Dolby and the double-D symbol are trademarks of Dolby Laboratories.

"DTS" is a registered trademark of DTS, Inc. and "DTS 2.0" is a trademark of DTS, Inc.

U.S. Patent Nos. 6,836,549; 6,381,747; 7,050,698; 6,516,132; and 5,583,936.

This product incorporates copyright protection technology that is protected by U.S. patents and other intellectual property rights. Use of this copyright protection technology must be authorized by Macrovision, and is intended for home and other limited viewing uses only unless otherwise authorized by Macrovision. Reverse engineering or disassembly is prohibited.

This product is licensed under the MPEG-4 Visual patent portfolio license for the personal and non-commercial use of a consumer for (i) encoding video in compliance with the MPEG-4 Visual Standard ("MPEG-4 Video") and/or (ii) decoding MPEG-4 Video that was encoded by a consumer engaged in a personal and non-commercial activity and/or was obtained from a video provider licensed by MPEG LA to provide MPEG-4 Video. No license is granted or shall be implied for any other use. Additional information including that relating to promotional, internal and commercial uses and licensing may be obtained from MPEG LA, LLC. See <http://www.mpegla.com>.

HighMAT and the HighMAT logo are trademarks or registered trademarks of Microsoft Corporation in the United States and/or other countries.



Windows Media and the Windows logo are trademarks or registered trademarks of Microsoft Corporation in the United States and/or other countries.

This product is protected by certain intellectual property rights of Microsoft Corporation and third parties. Use or distribution of such technology outside of this product is prohibited without a license from Microsoft or an authorized Microsoft subsidiary and third parties.

WMA is a compression format developed by Microsoft Corporation. It achieves the same sound quality as MP3 with a file size that is smaller than that of MP3.

Official DivX® Certified product.
Plays all versions of DivX® video (including DivX®6) with standard playback of DivX® media files.
DivX, DivX Certified, and associated logos are trademarks of DivX, Inc. and are used under license.



Changing the player settings

- Referring to the table below, change as required.
 - Underlined items are the factory presets.
 - Items shown differ depending on the type of software.
- The settings remain intact even if you switch the unit to standby.

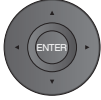
- 1 **DISPLAY**
Press once.
- 2 
- ① Press [**▲ ▼**] to select "Other Settings".
- ② Press [**ENTER**] then [**▲ ▼**] to select "Other Menu".
- ③ Press [**ENTER**] then [**▲ ▼**] to select "Setup".
- ④ Press [**ENTER**].

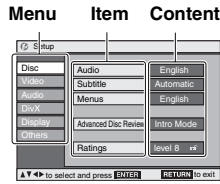

- Press [**▲ ▼ ◀ ▶**] to select the menu, item, content and press [**ENTER**].
- To enter number: press [**▲ ▼**] to select and press [**ENTER**].
- To return to the previous screen: press [**RETURN**].
- To exit the screen: Press [**RETURN**] several times.

"Disc" tab

Audio	<ul style="list-style-type: none"> • English • French • Spanish • Original (The original language designated on the disc is selected) • Other*****
Subtitle	<ul style="list-style-type: none"> • Automatic [If the language selected for "Audio" is not available, subtitles appear in that language (If available on the disc).] • English • French • Spanish • Other*****
Menus	<ul style="list-style-type: none"> • English • French • Spanish • Other*****
Advanced Disc Review Select how to review (→ 11).	<ul style="list-style-type: none"> • Intro Mode: Reviews each title/program. • Interval Mode: Reviews each 10 minutes.
Ratings Set a ratings level to limit DVD-Video play. • Follow the on-screen instructions.	<p>Setting ratings (When level 8 is selected)</p> <ul style="list-style-type: none"> • 8 No Limit • 1 to 7: To prohibit play of DVD-Video with corresponding ratings recorded on them. • 0 Lock All: To prevent play of discs without ratings levels. When setting a ratings level, a password screen is shown. Follow the on-screen instructions. <p>Do not forget your password. A message screen will be shown if a DVD-Video exceeding the ratings level is inserted in the unit. Follow the on-screen instructions.</p>

*Input a code number referring to the table on page 12.

"Video" tab

TV Aspect Choose the setting to suit your television and preference.	<ul style="list-style-type: none"> • 4:3 Pan&Scan: Regular aspect television (4:3) The sides of the widescreen picture are cut off so it fills the screen (unless prohibited by the disc). • 4:3 Letterbox: Regular aspect television (4:3) Widescreen picture is shown in the letterbox style. • 16:9: Widescreen television Use the television's screen modes to change the way the picture is shown. 	
Still Mode Specify the type of picture shown when paused.	<ul style="list-style-type: none"> • Automatic • Field: The picture is not blurred, but picture quality is lower. • Frame: Overall quality is high, but the picture may appear blurred. 	

"Audio" tab

Dynamic Range Compression	<ul style="list-style-type: none"> • Off • On: Adjusts for clarity even when the volume is low through compressing the range of the lowest sound level and the highest sound level. Convenient for late night viewing. (Only works with Dolby Digital.)
----------------------------------	---------------------------------------------------------------------------------------------------------------------------------------------------------------------------------------------------------------------------------------------------------------------------------

"DivX" tab

DivX Registration	You need this registration code to purchase and play DivX Video-on-Demand (VOD) content. (→ 9)
--------------------------	------------------------------------------------------------------------------------------------

"Display" tab

Menu Language	<ul style="list-style-type: none"> • English • Français • Español
On-Screen Messages	<ul style="list-style-type: none"> • On • Off
Background during Play Select background during JPEG, MPEG4 and DivX video playback.	<ul style="list-style-type: none"> • Black • Gray

"Others" tab

Re-initialize Setting This returns all values in the Setup menus to the default settings.	<ul style="list-style-type: none"> • Yes: The password screen is shown if "Ratings" (→ above) is set. Please enter the same password and press [ENTER]. When "Initialized" appears on the screen, wait for about 10 seconds. Press [ENTER] and turn the unit off and on again. • No
-----------------------------------------------------------------------------------------------------	---------------------------------------------------------------------------------------------------------------------------------------------------------------------------------------------------------------------------------------------------------------------------------------------------------------------------

Enjoying in a car

- Do not leave the unit on a surface that may become hot such as a dashboard. The unit is not heat-resistant so may malfunction.
- DRIVER MUST NOT OPERATE OR VIEW THIS UNIT WHILE OPERATING THE VEHICLE.
Doing so will distract the driver and could cause a collision resulting in serious injury or property damage.

Enjoying video in the back seat with the Headrest Mounting Bracket

You can enjoy video in the back seat attaching the unit to the back of the front seat.

- Please insert the disc before attaching the unit to the headrest mounting bracket.

- Do not attach or detach the unit or the bracket while the car is moving.
- Do not attach the unit in the following locations:
 - anywhere other than the back of the front seat
 - where it can be viewed or operated by the driver
 - where it interferes with the driver's operation of the vehicle
 - where it interferes with the operation of an airbag
- Ensure that the bracket belt is securely fastened and check the lock on the unit. Refer to installation instructions.
- In the event of an accident, sudden acceleration or braking, the unit could become loose and cause injury or property damage.
- Only use the Panasonic bracket supplied to attach the unit to the car seat.

1 Attach the headrest mounting bracket to the front seat.

- Adjust the headrest so there is an open space of about 3 cm.

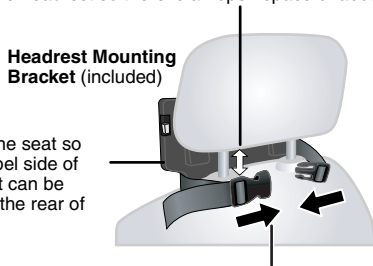

Attach to the seat so that the label side of the bracket can be seen from the rear of the seat.

- Close the buckle and adjust the belt until it fits tightly around the headrest.

Side view
DO **DO NOT**

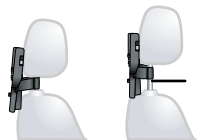

If this space is larger than 3 cm, the unit could become loose and cause injury in the event of an accident etc.

2 Adjust the monitor.

Rotate the monitor backwards so the screen is facing out. (→ 4, Adjusting the LCD angle)



3 Attach the unit to the bracket.

While holding the unit with both hands, line up the protruding sections on the bracket. Press the unit down about 4 to 5 mm so that the protrusions on the bracket fit into the holes on the bottom of the unit.

- Please check the following points before use.
 - The bracket is securely fastened to the unit.
 - The unit is not loose and cannot be lifted upwards.

Line up the protruding sections here.

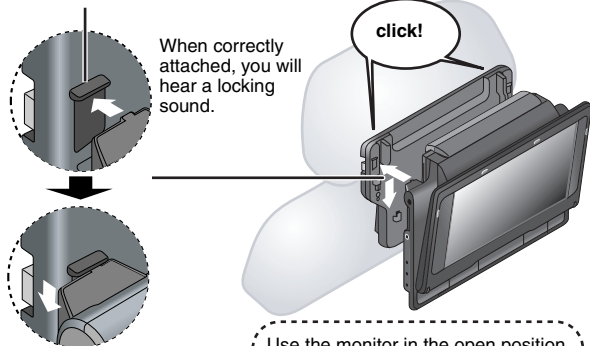
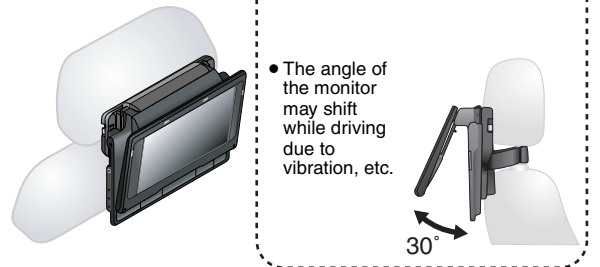

Diagram of the attached bracket and unit

Use the monitor in the open position as shown in the illustration below to prevent abnormal audio or damage resulting from vibrations in the car. The angle of the monitor can be adjusted up to about 30°.



- Depending on the type of headrest, you may not be able to attach the bracket.

DO **DO NOT**

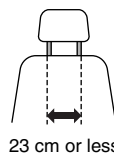

23 cm or less

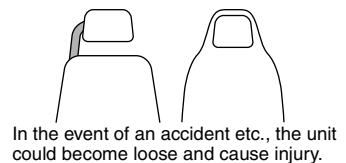

In the event of an accident etc., the unit could become loose and cause injury.

Releasing the unit from the bracket

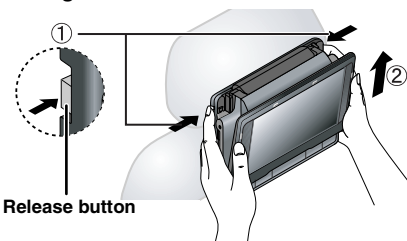

- Press the release buttons (left and right) in towards the center of the bracket.
 - Lift the unit up to release it.
- Do not press the release buttons any time other than when detaching the unit from the bracket.

Connecting the included Car DC Adaptor

Before connection, consult your car owner's manual or your dealer.

- Connect to the cigarette lighter socket of a vehicle that has a 12 V battery. It is not compatible with a vehicle that has a 24 V battery.
- This is a special negative grounded Car DC Adaptor. Using this Car DC Adaptor with a plus grounded car can cause malfunction and lead to fire.

Car DC Adaptor (included)

DC IN
Left side of this unit
Place the unit on a stable surface.

To the cigarette lighter socket

Replacing the fuse

Replace only with the specified 125 V/250 V, 2.5 A fuse. Use of any other type can cause fire.

2 Replace the fuse (125 V/250 V, 2.5 A type)

1 Open

3 Close

Cautions

• To avoid draining your car battery

- Disconnect the Car DC Adaptor from the cigarette lighter after use. The Car DC Adaptor continues to consume some power even if it is not being used, and if a battery pack is attached to this unit, it will start recharging which uses more power.
- Do not use the Car DC Adaptor for long periods when the engine is not running.
- Turn the unit off before stopping the engine while using Car DC Adaptor, otherwise resume play (→ 6) may not work.
- Leave some slack in the cord.
- No responsibility will be taken for damage that occurs due to faulty installation.



Left side of this unit

You can enjoy audio through your car audio system by connecting a car stereo cassette adaptor (not included) to the headphone jack on the left side of this unit.

Using this unit with other equipment

Turn off all equipment before connecting and read the appropriate operating instructions.

Enjoying stereo audio

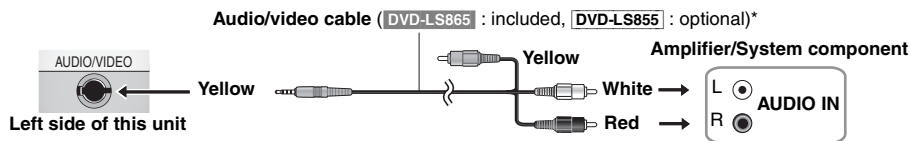

Enjoying with a television

Connect the video output from this unit directly to the television.

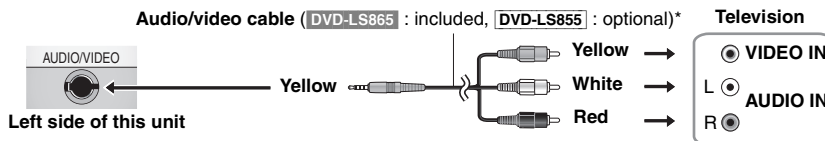

- The unit's speakers do not have magnetic shielding. Do not place the unit near televisions, personal computers or other devices easily influenced by magnetism. Do not keep this unit and magnetized cards (bank cards, commuter passes, etc.) close together.
- If you raise the volume on the television while playing this unit, the volume may abruptly become very loud when you switch to a television broadcast. Return the volume to its normal level before changing.

Watching video from other equipment

1 Connect the equipment to this unit.

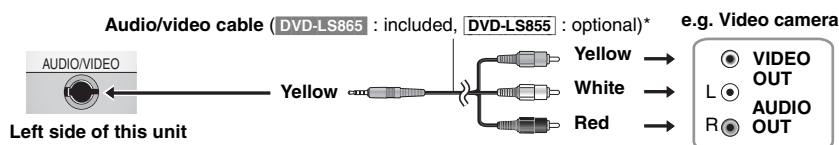

2 Press [AV SELECT] to switch to "AUX".

"AUX" lights on the unit's display.

- Operate playback using the connected equipment. (Please read the operating instructions for the connected equipment)
- The unit does not turn off automatically while "AUX" mode is on. Turn the unit off when you have finished using it.

*To order this audio/video cable, refer to "Accessory Purchases" on page 19. (Part No.: K2KC4CB00026)

Troubleshooting guide

Before requesting service, make the following checks. If you are in doubt about some of the check points, or if the solutions indicated in the chart do not solve the problem, refer to "Customer Services Directory" on page 19. (Reference pages are shown in parentheses.)

The following do not indicate malfunction.

- Sound from the AC adaptor during recharging.
- The battery pack warming up when recharging or during use.
- The surface and area around the unit becoming warm when used for long periods.

Power

No power.	<ul style="list-style-type: none"> ● Check connections to the AC adaptor or battery pack. (4) ● The unit has protection circuitry that is activated if it becomes too hot or too cold. The unit will not work if this occurs. Use the unit between 5 °C (41 °F) and 35 °C (95 °F).
Unit turns off automatically.	<ul style="list-style-type: none"> ● The unit turns off after it has been stopped for about 15 minutes (about 5 minutes when the unit is powered by the battery pack) to conserve power. Turn the unit on again.
Cannot charge or the [CHG] indicator fails to light.	<ul style="list-style-type: none"> ● The charging time increases when the temperature is too hot or too cold, and charging may not be possible under some circumstances. ● Check connections to the AC adaptor or battery pack. (4)
Play time dramatically reduced after recharging.	<ul style="list-style-type: none"> ● The battery pack has reached the end of its service life (It can be recharged about 300 times).

No operation

No response when any buttons pressed.	<ul style="list-style-type: none"> ● This unit cannot play discs other than the ones listed in these operating instructions. (5) ● The unit may not be operating properly due to lightning, static electricity or some other external factor. Turn the unit off and then back to ON. Alternatively, turn the unit off, disconnect the power source (AC or battery pack), and then reconnect it. ● Condensation has formed: Wait 1 to 2 hours for it to evaporate. ● Please insert the disc correctly. (6)
You have forgotten your ratings password.	<ul style="list-style-type: none"> ● While stopped, press and hold [◀◀] and [] on the unit and then also press and hold [▶ ON] on the unit until "Initialized" disappears from the screen. Turn the unit off and on again. All settings will return to the default values.
No picture or sound.	<ul style="list-style-type: none"> ● Check that the disc has something recorded on it.

Specific operation impossible or incorrect

It takes time before play starts.	<ul style="list-style-type: none"> ● Play may take time to begin when an MP3 track has still picture data. Even after the track starts, the correct play time will not be displayed; however, this is normal. ● This is normal on DivX video.
Menu doesn't appear. [VCD] (with playback control)	<ul style="list-style-type: none"> ● Press [■ -OFF] twice and then press [▶ ON].
Subtitle position is wrong.	<ul style="list-style-type: none"> ● Adjust the position. ("Subtitle Position" in Display Menu) (12)
No subtitles	<ul style="list-style-type: none"> ● Display the subtitles. (10)
The subtitles overlap closed captions recorded on discs.	<ul style="list-style-type: none"> ● Clear the subtitles. (10)
In A-B repeat, point B is automatically set.	<ul style="list-style-type: none"> ● If you have set only the starting point (point A), the end of an item becomes point B when it is reached.
Play doesn't start.	<ul style="list-style-type: none"> ● This unit may not play WMA and MPEG4 that contains still picture data. ● If playing DivX VOD content, refer to the homepage where you purchased the DivX VOD content. (Example: www.divx.com/vod) ● If a disc contains CD-DA and other formats, proper playback may not be possible.

Picture incorrect

Picture distorted.	<ul style="list-style-type: none"> ● There may be some video distortion during search, but this is normal. ● Picture quality may worsen or some frames may be skipped when viewing MPEG4, but this is normal. ● [DivX] Change "Source Select" in Picture Menu. (11)
Picture stops.	<ul style="list-style-type: none"> ● Picture may stop if the DivX files are greater than 2 GB.
No picture on the LCD.	<ul style="list-style-type: none"> ● Check connections. (4) ● Select a LCD-SIZE other than "MONITOR OFF" (No picture). (7, Selecting how to show 4:3 aspect pictures on the LCD)
The LCD is dark.	<ul style="list-style-type: none"> ● Select "DAYLIGHT" or adjust the brightness. (7)
LCD pixels turn black or radiate different colors.	<ul style="list-style-type: none"> ● The LCD is constructed with precision technology so 99.99 % of the pixels are active, but of the remaining of 0.01 %, there are pixels that may be black or emit light constantly. This phenomenon is not a malfunction.
Picture doesn't appear on the television (or the size of the picture seems wrong).	<ul style="list-style-type: none"> ● Check connections. (15) ● Check that the television is on. ● Check that the input mode on the television is correct. ● Check the settings of "TV Aspect" in "Video" tab. (13) ● Turn off the zooming feature on your television if you are using Zoom. (12) ● Ensure that the unit is connected directly to the television, and is not connected through a video cassette recorder. (15) ● Use the television to change the aspect. ● Adjust "Just Fit Zoom" in Display Menu. (12)
Menu not displayed correctly.	<ul style="list-style-type: none"> ● Restore the zoom ratio to ×1.00. (12) ● Set "Subtitle Position" in Display Menu to "0". (12)
Auto zoom function does not work well.	<ul style="list-style-type: none"> ● Turn off the zooming feature on your television. ● Use the other preset aspect ratios or manual adjustment. (12) ● Zoom function may not work well, especially in dark scenes and may not work depending on the type of disc.

Sound incorrect

Sound distorted.	<ul style="list-style-type: none"> Select "Off" in "Advanced Surround". (11) Move unit away from mobile phones. Noise may occur when playing WMA or MPEG4 files.
Effects do not work.	<ul style="list-style-type: none"> Some audio effects do not work or have less effect with some discs. H.Bass, Advanced Surround and Sound Enhancement do not work if you have changed the play speed.
No sound from the unit's speaker.	<ul style="list-style-type: none"> The speaker is off if the LCD is closed or headphones are connected. Turn up the volume. (6)
No sound from other speakers.	<ul style="list-style-type: none"> Check all connections and settings. (15)
No sound when you change the play speed.	<ul style="list-style-type: none"> There may be a pause in sound. This is not a malfunction.
No sound.	<ul style="list-style-type: none"> DivX Audio may not be output due to how files were created. (9)

Displays

"⊘"	<ul style="list-style-type: none"> The operation is prohibited by the unit or disc.
No On-Screen display.	<ul style="list-style-type: none"> Select "On" for "On-Screen Messages" in "Display" tab. (13)
"Check the disc."	<ul style="list-style-type: none"> Clean the disc. (18)
"U11"	<ul style="list-style-type: none"> You inserted a disc that has not been finalized. (5)
" ERROR 01"	<ul style="list-style-type: none"> A problem has occurred with the battery pack. Consult your dealer.
" ERROR 02"	<ul style="list-style-type: none"> The battery pack has been recharging for 20 hours but has failed to recharge for some reason. Recharge again.
" ERROR 03"	<ul style="list-style-type: none"> You are recharging in a location that is too hot or too cold. Recharge at normal temperature [+5 to +35 °C (+41 to +95 °F)].
"H □□"	<ul style="list-style-type: none"> Trouble has occurred. The number appearing after "H" depends on the problem. Turn the unit off and on again. Alternatively, turn the unit off, disconnect the power source (AC or battery pack), reconnect the power and turn the unit on again.
□□ stands for a number.	<ul style="list-style-type: none"> If the service numbers fail to clear, note the service numbers and consult your dealer.
"Cannot display group xx, content xx"	<ul style="list-style-type: none"> You are trying to play incompatible groups or content. (9)
"Authorization Error"	<ul style="list-style-type: none"> You are trying to play the DivX VOD content that was purchased with a different registration code. You cannot play the content on this unit. (9)
"Rental Expired"	<ul style="list-style-type: none"> The DivX VOD content has zero remaining plays. You cannot play it. (9)

[⏻] and [CHG] indicators

The [⏻] indicator flashes rapidly.	<ul style="list-style-type: none"> The unit has malfunctioned. Consult your dealer.
The [⏻] indicator flashes slowly.	<ul style="list-style-type: none"> The unit is on and the LCD is closed or the LCD-SIZE is set to "MONITOR OFF" (No picture). Turn the unit off when you have finished.
The [CHG] indicator flashes rapidly.	<ul style="list-style-type: none"> There is a problem with the battery pack. Turn the unit on and check the message on the LCD. (above)
The [CHG] indicator flashes slowly.	<ul style="list-style-type: none"> Battery pack charge is low. The unit will turn off automatically after a few minutes.

Frequently asked questions

Reference pages are shown in parentheses.

Can I play a DVD-Video bought in another country?	You can play if the region number includes "1" or "ALL" and the video standard is NTSC. Check the disc jacket. (Cover)
Can I use on an airplane or in a hospital?	Electromagnetic waves that are emitted from this unit may affect equipment on an airplane or in a hospital. Please obey the rules and/or instructions indicated by the hospital or airline.
Can I use in a car?	<ul style="list-style-type: none"> You can use this unit by connecting with the included Car DC Adaptor for power. Damage may occur if you do not use the specified car adaptor. (15) You can enjoy video in the back seat with the included Headrest Mounting Bracket. (14)
Can I connect with a computer?	You can enjoy use of the computer as a television monitor when connecting with the AV input terminal on a computer. However, you cannot operate this unit as peripheral equipment.

Maintenance

To clean this unit, wipe with a soft, dry cloth.

- Use eyeglass cleaner to remove stubborn dirt from the LCD.
- Never use alcohol, paint thinner or benzine to clean this unit.

Maintenance of the lens

- Remove dust carefully with an air blower for camera lenses (optional).
- Recommended product:
Lens cleaner kit (SZZP1038C) (Available from Panasonic dealers.)
- You cannot use a CD type lens cleaner.
- Be careful not to touch the lens with your fingers.

To clean discs

- Wipe with a damp cloth and then wipe dry.



Disc handling precautions

- Do not attach labels or stickers to discs (This may cause disc warping, rendering it unusable).
- Do not write on the label side with a ball-point pen or other writing instrument.
- Do not use record cleaning sprays, benzine, thinner, static electricity prevention liquids or any other solvent.
- Do not use scratch-proof protectors or covers.
- Do not drop stack, or impact discs. Do not place objects on them.
- To protect discs from scratches and dirt, return them to their cases or cartridges when you are not using them.
- Do not use the following discs:
 - Discs with exposed adhesive from removed stickers or labels (rented discs etc.).
 - Discs that are badly warped or cracked.
 - Irregularly shaped discs, such as heart shapes.

Specifications

Operating temperature range: +5 to +35 °C (+41 to +95 °F)

Operating humidity range: 5 to 85 % RH (no condensation)

Discs played [8 cm (3") or 12 cm (5")]:

- (1) DVD (DVD-Video, DivX^{®6,8})
- (2) DVD-RAM (DVD-VR⁹, JPEG^{*4,6,7}, MP3^{*2,6}, MPEG4^{*5,6}, DivX^{*6,8})
- (3) DVD-R (DVD-Video, DVD-VR⁹, JPEG^{*4,6,7}, MP3^{*2,6}, MPEG4^{*5,6}, DivX^{*6,8})
- (4) DVD-R DL (DVD-Video, DVD-VR⁹)
- (5) DVD-RW (DVD-Video, DVD-VR⁹, JPEG^{*4,6,7}, MP3^{*2,6}, MPEG4^{*5,6}, DivX^{*6,8})
- (6) +R/RW (Video)
- (7) +R DL (Video)
- (8) CD, CD-R/RW [CD-DA, Video CD, SVCD^{*1}, MP3^{*2,6}, WMA^{*3,6}, JPEG^{*4,6,7}, MPEG4^{*5,6}, DivX^{*6,8}, HighMAT Level 2 (Audio and Image)]

Signal system: NTSC

LCD screen: 8.5" α-Si, TFT wide-screen LCD (480×234×RGB)

AUDIO/VIDEO output/input:

Output/input terminal: ϕ 3.5 mm (1/8") mini jack

Number of terminals: 1 system (output/input selectable)

Composite-video:

Output/input level: 1 Vp-p (75 Ω)

Audio:

Output/input level: 1.5 Vrms (1 kHz, 0 dB, 10 kΩ)

Audio performance:

(1) Frequency response:

- DVD (linear audio): 4 Hz to 22 kHz (48 kHz sampling)

4 Hz to 44 kHz (96 kHz sampling)

- CD audio: 4 Hz to 20 kHz

(2) S/N ratio: 100 dB

(3) Dynamic range: 90 dB

(4) Total harmonic distortion: 0.01 %

Speaker:

Output: 0.5 W+0.5 W (10 % Distortion)

Headphone output:

Output: ϕ 3.5 mm (1/8") stereo mini jack

Number of terminals: 2 systems

Pickup:

Wave length: 655 nm/790 nm (DVD/CD)

Laser power: CLASS II/CLASS I (DVD/CD)

Power supply:

DC 12 V (DC IN terminal)/DC 7.2 V (Exclusive battery terminal)

Power consumption

(using included AC adaptor): 14 W (Unit only: 12 W)

Power consumption in Standby mode

(using included AC adaptor): **approx. 0.4 W**

Power consumption in Recharge mode

(using included AC adaptor): 12 W

AC adaptor:

Power source: AC 100 to 240 V, 50/60 Hz

Power consumption: 22 W

DC output: 12 V, 1.3 A

Car DC Adaptor:

DC output: 12 V, 1.5 A

(Vehicle with 12 V battery only)

Battery pack (lithium ion)

DVD-LS865 CGR-H712 (included):

Voltage: 7.2 V

Capacity: 4500 mAh

DVD-LS855 CGR-H711 (included):

Voltage: 7.2 V

Capacity: 2250 mAh

Dimensions (W×H×D) (excluding protrusions and battery):

242.6 mm (W)×46.0* mm (H)×173.5 mm (D)

(9 9/16"×1 13/16"×6 27/32")

*23.9 mm (13/16") at lowest point

DVD-LS865 (H=51.5 mm (2 1/32") including battery)

(D=179.3 mm (7 1/16") including battery)

DVD-LS855 (H=46.6 mm (1 27/32") including battery)

(D=173.5 mm (6 27/32") including battery)

Mass (Weight):

(including battery):

DVD-LS865 approximately 1109 g (39.13 oz)

DVD-LS855 approximately 1020 g (35.98 oz)

(without battery): approximately 876 g (30.90 oz)

Note

Specifications are subject to change without notice.

^{*1} Conforming to IEC62107

^{*2} MPEG-1 Layer 3, MPEG-2 Layer 3

^{*3} Windows Media Audio Ver 9.0 L3

Not compatible with Multiple Bit Rate (MBR)

^{*4} Exif Ver 2.1 JPEG Baseline files

Picture resolution: between 160×120 and 6144×4096 pixels (Sub sampling is 4:0:0, 4:2:0, 4:2:2 or 4:4:4)

^{*5} MPEG4 data recorded with the Panasonic SD multi cameras or DVD recorders

Conforming to SD VIDEO specifications (ASF standard)/MPEG4 (Simple Profile) video system/G.726 audio system

^{*6} The total combined maximum number of recognizable audio, picture and movie contents and groups: 4000 audio, picture and movie contents and 400 groups.

^{*7} Extremely long and slender pictures may not be displayed.

^{*8} Plays all versions of DivX[®] video (including DivX^{®6}) with standard playback of DivX[®] media files. Certified to the DivX[®] Home Theater Profile.

^{*9} CPRM doesn't cope with it.

Limited Warranty

**Panasonic Consumer Electronics Company,
Division of Panasonic Corporation of North America**
One Panasonic Way Secaucus, New Jersey 07094

Panasonic Puerto Rico, Inc.
Ave. 65 de Infantería, Km. 9.5
San Gabriel Industrial Park, Carolina,
Puerto Rico 00985

Panasonic DVD Player Limited Warranty

Limited Warranty Coverage

If your product does not work properly because of a defect in materials or workmanship, Panasonic Consumer Electronics Company or Panasonic Puerto Rico, Inc. (collectively referred to as "the warrantor") will, for the length of the period indicated on the chart below, which starts with the date of original purchase ("Limited Warranty period"), at its option either (a) repair your product with new or refurbished parts, or (b) replace it with a new or a refurbished product. The decision to repair or replace will be made by the warrantor.

Product or Part Name	Parts	Labor
DVD Player	One (1) Year	Ninety (90) Days
Rechargeable Batteries (in exchange for defective item)	Ten (10) Days	Not Applicable
Headrest mounting bracket, Headphones, Accessories (in exchange for defective item)	Ninety (90) Days	Not Applicable

During the "Labor" Limited Warranty period there will be no charge for labor. During the "Parts" warranty period, there will be no charge for parts. You must mail-in your product during the warranty period. If non-rechargeable batteries are included, they are not warranted. This Limited Warranty only applies to products purchased and serviced in the United States or Puerto Rico. This Limited Warranty is extended only to the original purchaser and only covers product purchased as new. A purchase receipt or other proof of original purchase date is required for Limited Warranty service.

Mail-In Service

For assistance in the continental U.S.A. in obtaining repairs please ship the product to:

Panasonic Service and Technology Company
Customer Servicenter
Suite B
4900 George McVay Drive
McAllen, TX 78503

For assistance in Puerto Rico call Panasonic Puerto Rico, Inc. (787)-750-4300 or fax (787)-768-2910.

When shipping the unit carefully pack and send it prepaid, adequately insured and preferably in the original carton. Include a letter detailing the complaint and provide a day time phone and/or email address where you can be reached.

IF REPAIR IS NEEDED DURING THE LIMITED WARRANTY PERIOD THE PURCHASER WILL BE REQUIRED TO FURNISH A SALES RECEIPT/PROOF OF PURCHASE INDICATING DATE OF PURCHASE, AMOUNT PAID AND PLACE OF PURCHASE. CUSTOMER WILL BE CHARGED FOR THE REPAIR OF ANY UNIT RECEIVED WITHOUT SUCH PROOF OF PURCHASE.

Limited Warranty Limits And Exclusions

This Limited Warranty ONLY COVERS failures due to defects in materials or workmanship, and DOES NOT COVER normal wear and tear or cosmetic damage. The Limited Warranty ALSO DOES NOT COVER damages which occurred in shipment, or failures which are caused by products not supplied by the warrantor, or failures which result from accidents, misuse, abuse, neglect, mishandling, misapplication, alteration, faulty installation, set-up adjustments, misadjustment of consumer controls, improper maintenance, power line surge, lightning damage, modification, or commercial use (such as hotel, office, restaurant, or other business), rental use of the product, or service by anyone other than a Factory Servicenter or other Authorized Servicer, or damage that is attributable to acts of God.

THERE ARE NO EXPRESS WARRANTIES EXCEPT AS LISTED UNDER "LIMITED WARRANTY COVERAGE". THE WARRANTOR IS NOT LIABLE FOR INCIDENTAL OR CONSEQUENTIAL DAMAGES RESULTING FROM THE USE OF THIS PRODUCT, OR ARISING OUT OF ANY BREACH OF THIS WARRANTY. (As examples, this excludes damages for lost time, cost of having someone remove or re-install an installed unit if applicable, travel to and from the servicer, loss of or damage to media or images, data or other recorded content. The items listed are not exclusive, but are for illustration only.)

ALL EXPRESS AND IMPLIED WARRANTIES, INCLUDING THE WARRANTY OF MERCHANTABILITY, ARE LIMITED TO THE PERIOD OF THE LIMITED WARRANTY.

Some states do not allow the exclusion or limitation of incidental or consequential damages, or limitations on how long an implied Limited Warranty lasts, so the exclusions may not apply to you.

This Limited Warranty gives you specific legal rights and you may also have other rights which vary from state to state. If a problem with this product develops during or after the Limited Warranty period, you may contact your dealer or Servicenter. If the problem is not handled to your satisfaction, then write to the warrantor's Consumer Affairs Department at the addresses listed for the warrantor.

PARTS AND SERVICE, WHICH ARE NOT COVERED BY THIS LIMITED WARRANTY, ARE YOUR RESPONSIBILITY.

Customer Services Directory

Obtain Product Information and Operating Assistance; locate your nearest Dealer or Servicenter; purchase Parts and Accessories; or make Customer Service and Literature requests by visiting our Web Site at:

<http://www.panasonic.com/consumersupport>

or, contact us via the web at:

<http://www.panasonic.com/contactinfo>

You may also contact us directly at:

1-800-211-PANA (7262),

Monday-Friday 9 am-9 pm; Saturday-Sunday 10 am-7 pm, EST.

For hearing or speech impaired TTY users, TTY: 1-877-833-8855

Accessory Purchases

Purchase Parts, Accessories and Instruction Books online for all Panasonic Products by visiting our Web Site at:

<http://www.pstc.panasonic.com>

or, send your request by E-mail to:

npcparts@us.panasonic.com

You may also contact us directly at:

1-800-332-5368 (Phone) 1-800-237-9080 (Fax Only)

(Monday – Friday 9 am to 9 pm, EST.)

Panasonic Service and Technology Company

20421 84th Avenue South, Kent, WA 98032

(We Accept Visa, MasterCard, Discover Card, American Express, and Personal Checks)

For hearing or speech impaired TTY users, TTY : 1-866-605-1277

Service in Puerto Rico

Panasonic Puerto Rico, Inc.

Ave. 65 de Infantería, Km. 9.5, San Gabriel Industrial Park,

Carolina, Puerto Rico 00985

Phone (787)750-4300, Fax (787)768-2910

As of January 2007

Product Service

- 1 Damage requiring service**—The unit should be serviced by qualified service personnel if:
 - (a) The AC power supply cord or AC adaptor has been damaged; or
 - (b) Objects or liquids have gotten into the unit; or
 - (c) The unit has been exposed to rain; or
 - (d) The unit does not operate normally or exhibits a marked change in performance; or
 - (e) The unit has been dropped or the cabinet damaged.
- 2 Servicing**—Do not attempt to service the unit beyond that described in these operating instructions. Refer all other servicing to authorized servicing personnel.

- 3 Replacement parts**—When parts need replacing ensure the servicer uses parts specified by the manufacturer or parts that have the same characteristics as the original parts. Unauthorized substitutes may result in fire, electric shock, or other hazards.
- 4 Safety check**—After repairs or service, ask the servicer to perform safety checks to confirm that the unit is in proper working condition.

Product information

For product information or assistance with product operation: Refer to Customer Services Directory above.

Download from www.Somanuals.com. All Manuals Search And Download.

Index

A A-B Repeat	11	F Finalize	5	P Play Speed	11
Advanced Disc Review	11	H H.Bass	11	Playback Menu	8
Advanced Surround	11	Headrest Mounting Bracket	14	Playlists	7
Angle	10	HighMAT	8	Programs	7
Audio	10	J JPEG	8, 9	Q Quick OSD	7
AV SELECT	6	Just Fit Zoom	12	R Re-initialize Setting	13
B BRIGHT-LCD	7	L LCD-SIZE	7	Repeat	7, 11
C Car DC Adaptor	15	M Manual Zoom	12	Resume play	6
CD text playback	7	MENU	6, 7, 8	Rotate Picture	10
Cinema1/Cinema2	11	MP3	8, 9	S Setup	13
D Depth Enhancer	11	MPEG DNR	11	Sound Enhancement	11
Dialogue Enhancer	11	MPEG4	8, 9	Subtitle	10
DISPLAY	7, 10	N Navigation Menu	8	T Time Slip for play only	10
DivX	8, 9	Number Select	6, 10	TOP MENU	6, 7, 8
Dolby Digital	10	O On-Screen Menus	10	W WMA	8, 9
DTS	10				

Notice:
 This product has a fluorescent lamp that contains mercury.
 Disposal may be regulated in your community due to environmental considerations. For disposal or recycling information, please contact your local authorities, or the Electronic Industries Alliance:
 <<http://www.eiae.org>>

–If you see this symbol–



Information on Disposal in other Countries outside the European Union
 This symbol is only valid in the European Union.
 If you wish to discard this product, please contact your local authorities or dealer and ask for the correct method of disposal.

User memo:

DATE OF PURCHASE _____

DEALER NAME _____

DEALER ADDRESS _____

TELEPHONE NUMBER _____

The model number and serial number of this product can be found on either the back or the bottom of the unit. Please note them in the space provided below and keep for future reference.

MODEL NUMBER _____

SERIAL NUMBER _____

Panasonic Consumer Electronics Company,
Division of Panasonic Corporation of North America
 One Panasonic Way Secaucus, New Jersey 07094
<http://www.panasonic.com>

Panasonic Puerto Rico, Inc.
 Ave. 65 de Infantería, Km. 9.5
 San Gabriel Industrial Park, Carolina, Puerto Rico 00985



Free Manuals Download Website

<http://myh66.com>

<http://usermanuals.us>

<http://www.somanuals.com>

<http://www.4manuals.cc>

<http://www.manual-lib.com>

<http://www.404manual.com>

<http://www.luxmanual.com>

<http://aubethermostatmanual.com>

Golf course search by state

<http://golfingnear.com>

Email search by domain

<http://emailbydomain.com>

Auto manuals search

<http://auto.somanuals.com>

TV manuals search

<http://tv.somanuals.com>