

# Panasonic

## Portable DVD/Video CD/CD Player Operating Instructions

### DVD-L50D



This manual was printed with soy based ink.

**PalmTheater** 



### *Dear Customers*

May we take this opportunity to thank you for purchasing this Panasonic Portable DVD/Video CD/CD Player.

We strongly recommend that you carefully study the Operating Instructions before attempting to operate the player and that you note the listed precautions.

Before attempting to connect, operate or adjust this player, please read these instructions completely. Please save this manual.

VQT8141

# Safety information

## Note:

Use only the AC adaptor provided. This player can be used only where the power supply is under the following conditions.

•U.S.A. and Canada:

AC 120 V, 60 Hz

•Foreign: AC 100–240 V, 50/60 Hz  
It cannot be used elsewhere.

## CAUTION:

PORTABLE DVD/VIDEO CD/CD PLAYER IS A CLASS I LASER PRODUCT. HOWEVER THIS PORTABLE DVD/VIDEO CD/CD PLAYER USES A VISIBLE/INVISIBLE LASER BEAM WHICH COULD CAUSE HAZARDOUS RADIATION EXPOSURE IF DIRECTED. BE SURE TO OPERATE THE PORTABLE DVD/VIDEO CD/CD PLAYER CORRECTLY AS INSTRUCTED.

WHEN THIS PORTABLE DVD/VIDEO CD/CD PLAYER IS PLUGGED TO THE WALL OUTLET, DO NOT PLACE YOUR EYES CLOSE TO THE OPENING OF THE INNER COVER AND OTHER OPENINGS TO LOOK INTO THE INSIDE OF THIS PLAYER.

USE OF CONTROLS OR ADJUSTMENTS OR PERFORMANCE OF PROCEDURES OTHER THAN THOSE SPECIFIED HEREIN MAY RESULT IN HAZARDOUS RADIATION EXPOSURE.

DO NOT OPEN COVERS AND DO NOT REPAIR YOURSELF. REFER SERVICING TO QUALIFIED PERSONNEL.

## WARNING:

TO REDUCE THE RISK OF FIRE OR ELECTRIC SHOCK, DO NOT EXPOSE THIS PLAYER TO RAIN OR MOISTURE.

TO REDUCE THE RISK OF FIRE OR ELECTRIC SHOCK, AND ANNOYING INTERFERENCE, USE THE RECOMMENDED ACCESSORIES ONLY.

THIS PLAYER IS INTENDED FOR CONTINUOUS OPERATION!

## CAUTION:

TO PREVENT ELECTRIC SHOCK, DO NOT USE THIS (POLARIZED) PLUG WITH AN EXTENSION CORD, RECEPTACLE OR OTHER OUTLET UNLESS THE BLADES CAN BE FULLY INSERTED TO PREVENT BLADE EXPOSURE.

Marking sign is located on bottom of the AC adaptor.

Marking sign is located on bottom of the Portable DVD/Video CD/CD Player.

CAUTION -LASER RADIATION WHEN OPEN.  
DO NOT STARE INTO BEAM.

ATTENTION-RAYONNEMENT LASER EN CAS D'OUVERTURE.  
NE PAS REGARDER DANS LE FAISCEAU.

(Bottom of player)



**CAUTION**  
RISK OF ELECTRIC SHOCK  
DO NOT OPEN



**CAUTION:** TO REDUCE THE RISK OF ELECTRIC SHOCK, DO NOT REMOVE COVER (OR BACK). NO USER-SERVICEABLE PARTS INSIDE. REFER SERVICING TO QUALIFIED SERVICE PERSONNEL.



The lightning flash with arrowhead symbol, within an equilateral triangle, is intended to alert the user to the presence of uninsulated "dangerous voltage" within the product's enclosure that may be of sufficient magnitude to constitute a risk of electric shock to persons.



The exclamation point within an equilateral triangle is intended to alert the user to the presence of important operating and maintenance (servicing) instructions in the literature accompanying the appliance.

**FCC NOTE:** (U.S.A. Only)

This equipment has been tested and found to comply with the limits for a Class B digital device, pursuant to Part 15 of the FCC Rules. These limits are designed to provide reasonable protection against harmful interference in a residential installation. This equipment generates, uses and can radiate radio frequency energy and, if not installed and used in accordance with the instructions, may cause harmful interference to radio communications. However, there is no guarantee that interference will not occur in a particular installation. If this equipment does cause harmful interference to radio or television reception, which can be determined by turning the equipment off and on, the user is encouraged to try to correct the interference by one or more of the following measures:

- Reorient or relocate the receiving antenna.
- Increase the separation between the equipment and receiver.
- Connect the equipment into an outlet on a circuit different from that to which the receiver is connected.
- Consult the dealer or an experienced radio/TV technician for help.

**FCC Caution:** To assure continued compliance, follow the attached installation instructions and use only shielded cables when connecting to other devices. Also, any changes or modifications not expressly approved by the party responsible for compliance could void the user's authority to operate this equipment.

### **IMPORTANT SAFETY INSTRUCTIONS**

**SAVE THESE INSTRUCTIONS.**

**DANGER:**

TO REDUCE THE RISK OF FIRE OR ELECTRIC SHOCK, CAREFULLY FOLLOW THESE INSTRUCTIONS.

- For connection to a supply in the U.S.A. and Canada, the provided AC cord must be connected to 120 V AC supply only.
- Confirm the voltage available at each country location before using this player though the provided AC Adaptor operates on 100–240 V AC.
- For connection to a supply not in the U.S.A. and Canada, use an attachment plug adapter of the proper configuration for the AC outlet.
- For connection to supply which is greater than AC 125 V, use an AC cord set which is suitable for the voltage of the AC outlet and the rated current of the supplied AC adaptor. The AC cord set must be certified by the appropriate testing agencies according to the applicable national regulations.
- Contact either a local or foreign electrical parts distributor for assistance in selecting an alternate AC plug or a proper AC cord set.

# Accessories



Please check and identify the supplied accessories.

**(For U.S.A.)** To order accessories, call PASC Accessory Dept. 1-888-PANA-DVD (1-888-726-2383).

**(For Canada)** To order accessories, call the dealer from whom you have made your purchase.

**Remote control unit . . . 1**  
(Part No. VEQ2293)

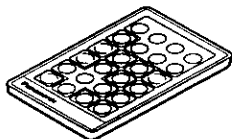

**Button-type battery . . . . . 1**  
for remote control unit  
(Part No. CR2025)



**Audio/video cable . . . 1**  
(Part No. VJA1065)

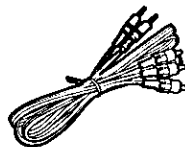

**AC adaptor . . . . . 1**  
(Part No. VSK0555)

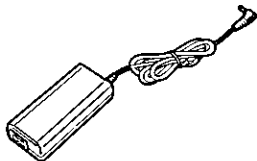

**AC cord . . . . . 1**  
(Part No. VJA1095)

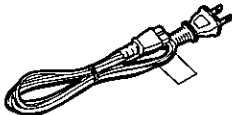

**Battery pack . . . . . 1**  
(Model No. DY-DB50EX)

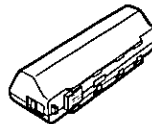

- Service Center list . . . . . 2**
- Warranty card . . . . . 2**
- Safety Instructions card . . . . . 1**
- Product information card . . . . . 1**
- Operating Instructions manual . . . . 2**

**Optional accessories:**

- Battery pack (Model No. DY-DB50EX)
- S video cable
- Optical digital audio cable

The model number and serial number of this player can be found on either the back or the bottom of the player. Please note them in the space provided below and retain this booklet as a permanent record of your purchase to aid identification in the event of theft.

MODEL NUMBER \_\_\_\_\_  
SERIAL NUMBER \_\_\_\_\_

**□ Marks used in these instructions (pages 31–49)**

**DVD** . . . This gives details on a function which can be enjoyed with DVD.

**VCD** . . . This gives details on a function which can be enjoyed with Video CD.

**CD** . . . This gives details on a function which can be enjoyed with CD.

# Table of contents

## Getting Started:

Safety information . . . . .	2	• Disc formats supported by this player . . . . .	10
Accessories . . . . .	5	Safety precautions . . . . .	11
Features . . . . .	8		

## Preparation:

Remote control unit preparations . . . . .	22	• Remote control operation range . . . . .	23
• Button-type battery (supplied) installation . . . . .	22	• Remote control operational notes . . . . .	23
• Notes regarding the button-type battery . . . . .	23	Powering the player using the AC adaptor . . . . .	24

## Basic Operations:

Basic play . . . . .	30	• Still picture (Pause) . . . . .	34
• Stopping play . . . . .	32	• Frame advance (Frame reverse) [DVD/Video CD] . . . . .	34
• Skipping ahead or back . . . . .	33		
• Rapid advance (Rapid reverse) . . . . .	33		

## Advanced Operation:

Operations using the On-Screen Menu Icons . . . . .	36	Using a menu . . . . .	43
• Detailed descriptions of each icon (Icons for disc information) . . . . .	38	• Using a title menu . . . . .	43
• Detailed descriptions of each icon (Icons for player information) . . . . .	40	• Using a DVD menu . . . . .	43
• Detailed descriptions of each icon (Shuttle screen) . . . . .	40	Playing tracks in an order you specify or in random order (Program play/Random play) . . . . .	44
		• Playing tracks in an order you specify (Program play) . . . . .	44

## For Your Reference:

Changing the initial settings . . . . .	50	• When "6 Digital Audio Output" is selected . . . . .	60
• When "1 Disc Languages" is selected . . . . .	52	• Recommended setting of "6 Digital Audio Output" . . . . .	62
• When "2 Ratings" is selected . . . . .	54	• When "9 Other Settings" is selected . . . . .	63
• When "3 Menu Language" is selected . . . . .	56	Connection . . . . .	66
• When "4 On-Screen Messages" is selected . . . . .	57	• Connecting to a stereo TV set . . . . .	66
• When "5 TV Aspect" is selected . . . . .	58	• Connecting to audio equipment . . . . .	67
• Display modes of the LCD . . . . .	59		

<b>Operating precautions</b> . . . . .	<b>13</b>	●Maintenance of the main unit . . . . .	<b>15</b>
●Handling precautions . . . . .	<b>13</b>	●Maintenance of the LCD . . . . .	<b>15</b>
<b>Disc handling and maintenance</b> . . . . .	<b>15</b>	<b>Control reference guide</b> . . . . .	<b>16</b>

Getting Started

<b>Powering the player using the battery pack (supplied)</b> . . . . .	<b>25</b>	●Regarding the battery pack . . . . .	<b>27</b>
●Attaching the battery pack . . . . .	<b>25</b>	<b>Inserting/Removing discs</b> . . . . .	<b>28</b>
●Detaching the battery pack . . . . .	<b>25</b>	●Inserting discs . . . . .	<b>28</b>
●Charging the battery pack . . . . .	<b>26</b>	●Removing discs . . . . .	<b>29</b>

Preparation

●Slow-motion play [DVD/Video CD] . . . . .	<b>35</b>	●Enjoying Video CDs with playback control without using menus [Video CD] . . . . .	<b>35</b>
--	-----------	--	-----------

Basic Operations

●Playing tracks in random order (Random play) . . . . .	<b>45</b>	●Viewing from another angle (Multi-angle function) . . . . .	<b>48</b>
<b>Using the multi-functions</b> . . . . .	<b>46</b>	<b>Reproducing an Advanced Virtual Surround Sound effect [Dolby Digital (AC-3) DVD]</b> . . . . .	<b>49</b>
●Changing audio soundtrack language (Multi-audio function) . . . . .	<b>46</b>		
●Changing subtitle language (Multi-subtitle function) . . . . .	<b>47</b>		

Advanced Operation

●Enjoying digital audio output from the audio input/output (optical digital audio output) connector . . . . .	<b>68</b>	●Self-diagnosis display function . . . . .	<b>77</b>
●Connecting to a decoder with Dolby Digital (AC-3) or dts (digital theater systems) processing . . . . .	<b>69</b>	●When the STANDBY (⏻) indicator or the CHARGE (CHG) indicator flashes . . . . .	<b>78</b>
●Playback from a video camera . . . . .	<b>70</b>	<b>Language code list</b> . . . . .	<b>79</b>
●Connecting headphones (optional) . . . . .	<b>70</b>	<b>Definition of terms</b> . . . . .	<b>80</b>
<b>Troubleshooting</b> . . . . .	<b>71</b>	<b>Specifications</b> . . . . .	<b>82</b>
		<b>Index</b> . . . . .	<b>83</b>

For Your Reference

# Features

## 5-inch LCD Wide-screen with stereo speakers

This portable DVD/Video CD/CD player includes an LCD screen and stereo speakers so that you can enjoy video and music without connecting to a TV set or other device. You can display video and listen to sounds recorded with a video camera using the LCD screen and stereo speakers.

- This player provides a 280,000-pixel high-resolution LCD wide-screen. This lets you enjoy sharp images.

## Portable type for the user on the go

The player's compact size, measuring 5 $\frac{5}{8}$ " (140 mm) wide, 6" (151.5 mm) deep and 1 $\frac{1}{2}$ " (37.7 mm) high, and light weight of only 1.4 lbs. (640 g), make it easy for you to carry it around.

## Approximately three-hour continuous playing capability\* with battery pack

[supplied or optional (model No.: DY-DB50EX )] (See page 25.)

A newly developed lithium ion battery provides about three hours of continuous playing capability.

\*This length of time varies depending on the player's operating conditions.

Continuous playing time of music CD is about 4.5 hours (when the outer cover is closed or the LCD is set to OFF).

## Easier to use and carry

(See pages 17, 20 and 21.)

Nearly all functions can be accessed using the function buttons on the player. The compact, card-type remote control is easy to carry and useful for remotely controlling the player.

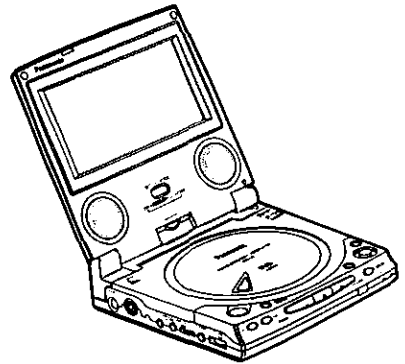

## Advanced Virtual Surround Sound (VSS) function

(See page 49.)

If the player is connected to external speakers, even when just two front speakers are being used, the user can simply press the VSS (Virtual Surround Sound) button during playback of a Dolby Digital DVD (2 channel and above) to provide a rear surround effect. (This does not work with DVD Karaoke discs. In addition, this effect may differ depending on the kind of DVD used.)

## Dolby Digital (AC-3)/dts (digital theater systems) digital output

(See page 69.)  
By connecting a Dolby Digital (AC-3)/dts (digital theater systems) decoder or an amplifier incorporating a Dolby Digital/dts decoder, you can enjoy high quality digital surround sound from Dolby Digital/dts discs.



## Dialogue Enhancer

(See pages 32 and 41.)

During playback of Dolby Digital/5.1 channel software, this function will boost the sound level of the center channel so that it is easier to hear the dialogue on movie software.

## On-Screen Menu Icons

(See page 36.)

By simply pressing the DISPLAY button, information on the player and disc can be displayed on the screen for easy identification. The player's operations and settings can be easily accessed by operating the joystick/cursor buttons while monitoring the screen.

The color and position of the On-Screen Menu Icons can be changed.

(See page 57.)

**Example: in the case of the DVD**

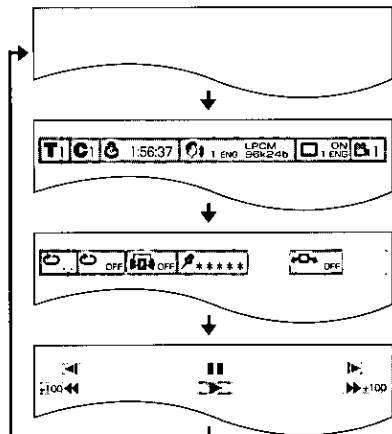

## Versatile DVD features

● **Multi-audio function** (See page 46.)

The audio soundtrack can be heard in up to 8 languages. (The number of languages depends on the software.)

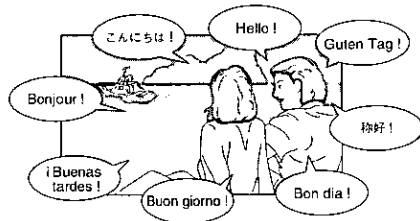

● **Multi-subtitle function** (See page 47.)

Subtitles may be displayed in one of a maximum of 32 languages. (The number of languages depends on the software.)



● **Multi-angle function** (See page 48.)

This function allows you to choose the viewing angle of scenes which were shot from a number of different angles. (Limited to DVDs recorded with multiple camera angles.)

● **Parental lock function**

(See page 54.)

This function can prevent playback of DVD software unsuitable for some audiences (especially for children). (Limited to DVDs encoded with specific rating level.)

# Features

## Disc formats supported by this player

The player can play back discs bearing any of the following marks:



**DVD**  
[3"(8 cm) disc/  
5"(12 cm) disc]



**Video CD**  
[3"(8 cm) disc/  
5"(12 cm) disc]



**CD**  
[3"(8 cm) disc/  
5"(12 cm) disc]

## Discs which cannot be played with this player

- DVD with Region No. other than "1" or "ALL"
  - Disc of PAL system
  - DVD-ROM
  - DVD-R/DVD-RAM
  - CD-ROM
  - VSD
  - CDV
  - CD-G
  - CD-RW
  - DVD+RW
  - CVD
  - SVCD
  - Divx Video Disc
  - CD-R
  - Photo CD
- etc.

## Region Management Information

This player is designed and manufactured to respond to the Region Management Information that is recorded on a DVD disc. The Region number of this player is "1". If the Region number described on the DVD disc does not correspond to the Region number of this player, this player cannot play this disc. This player will play DVD discs made for "ALL" Regions. This player will play DVD discs marked with the following symbols:



or



## Important information on playing DVDs and Video CDs

Some DVDs and Video CDs are played in a certain predetermined way based on the specifications of the software designer. When you insert a disc of this type, the player may not function according to the commands you enter (see the examples below) because the disc will be played according to the specifications of the software designer. For further information, see the manual provided with your disc.

### Examples:

- You may press the SKIP button to go to the beginning of the next track, but instead of skipping, the player displays the  mark (indicating a prohibited action).
- Some functions such as the RESUME function and the A-B repeat play do not work with an interactive DVD or during menu play of a Video CD with playback control.

# Safety precautions

Please read these precautions before operating this player.

## □ AC cord and AC adaptor protection

To avoid any malfunctions of the player, and to protect against electric shock, fire or personal injury, please observe the following:

- Use only the AC adaptor provided.
- Do not use the player above the established ratings of the AC outlet and power distributor or do not supply an AC voltage other than 120 V in U.S.A. and Canada. (Refer to "IMPORTANT SAFETY INSTRUCTIONS" on page 4.)
- Hold the plug firmly when connecting or disconnecting the AC cord.
- Do not connect or disconnect the AC cord when your hands are wet.
- Keep the AC cord and AC adaptor away from heating appliances.
- Never put any heavy object on the AC cord and AC adaptor .
- Do not attempt to repair or reconstruct the AC cord and AC adaptor in any way.
- Remove dust, dirt, etc. on the plug at regular intervals.
- If liquids or foreign objects have been spilled into the player or AC adaptor, set the player to the standby mode and disconnect the AC cord.
- If the player has been dropped or otherwise damaged, set the player to the standby mode and disconnect the AC cord.
- If smoke, malodors or noises are emitted from the player or AC adaptor, set the player to the standby mode and disconnect the AC cord.
- If the case of the AC adaptor or the AC cord is damaged, set the player to the standby mode and disconnect the AC cord.
- If the AC adaptor is not going to be used for a long time, disconnect the AC cord for safety.

- Do not touch the plug, the AC adaptor, battery pack or the metal part of the player during a thunderstorm.
- Do not scratch or mark the AC adaptor, AC cord and power plug, rework them, place them in proximity to a heating appliance, forcibly bend them, twist them, pull them, place heavy objects on top of them, bunch them together with other wires or units, or put a cloth over them.
- Insert the power plug securely until its prongs are completely housed inside the AC outlet.

- Do NOT disassemble or remodel this player.

## □ Placement

Avoid placing the player or AC adaptor in areas of:

- direct sunlight or heating radiators, or closed automobiles
- high temperature [over 95°F (35°C)] or high humidity (over 90%)
- excessive dust or oily smoke
- vibration, impact or where the surface is tilted
- in a poorly ventilated location as the internal parts may be seriously damaged.

## □ No fingers or other objects inside

- Touching internal parts of this player is dangerous, and may cause serious damage to the player. Do not attempt to disassemble the player.
- Do not put any foreign object inside the player or AC adaptor.
- Do not insert metal or inflammable objects inside the player or AC adaptor.
- Take care not to catch your fingers when you close the inner cover.

# Safety precautions

- ❑ **Keep away from water and magnets.**
  - Keep the player or AC adaptor away from flower vases, tubs, sinks, etc. If liquids are spilled into the player or AC adaptor, serious damage could occur.
  - Keep magnetic objects such as speakers, at a distance from this player.
- ❑ **Do not use cracked or warped discs.**
- ❑ **To avoid injuries from accidents caused by inattention, do not use this player in the front seat of a moving vehicle, or when walking.**
- ❑ **Do not use the car's cigarette lighter socket to supply power to the player. (Doing so may cause a malfunction.)**
- ❑ **Do not position your eyes near the lens, and do not look at the laser light.**
  - Doing so may be harmful to your vision.
- ❑ **Do not operate the player for an extended period of time on your lap, etc.**

■ **When this player is used for an extended period of time, the bottom of the player can become hot enough to cause minor burns.**

## **DANGER**

- ❑ **Caution regarding the battery pack.**
  - Do not use the battery pack with equipment other than the specified player.
  - Use this player to recharge the battery pack.
  - Do not drop, impact, disassemble, remodel, or press the battery pack.
  - Do not throw the battery pack into the fire, or heat it.
  - Keep the battery pack away from areas exposed to direct sunlight or in close proximity to a flame.
  - Do not touch the plug terminals (⊕ or ⊖) with metal objects.
  - Do not use, charge, or leave the battery pack in locations where there is static electricity.
  - Do not get the terminals dirty or wet.
  - Do not get dirt, sand, or other foreign matter on the terminals.
  - Do not use the player outside if it is snowing or raining. (This battery pack is not waterproof.)
- ❑ **Caution regarding disposing of the battery pack and the button-type battery**
  - Check, and follow, your local regulations before disposal.
- ❑ **Caution regarding the button-type battery**
  - Do not disassemble, remodel (solder, e.g.), press, heat or throw the battery into the fire.
  - Keep the button-type battery out of the reach of children.
  - Make sure you insert the battery with its poles aligned.
  - Do not touch the plug terminals (⊕ or ⊖) with metal objects.
- ❑ **Countermeasure against electrolyte leaking from the battery pack or the button-type battery**
  - If any electrolyte should come into contact with your hands or clothes, wash it off thoroughly with water.
  - If any electrolyte should come into contact with your eyes, never rub the eyes. Rinse eyes thoroughly with water, and then consult a doctor.

# Operating precautions

## Handling precautions

### □ If there is noise interference on the TV while a broadcast is being received

Depending on the reception condition of the TV, interference may appear on the TV screen while you are watching a TV broadcast and the player is left on. This is not a malfunction of the player or the TV. To watch a TV broadcast, set the player to the standby mode.

### □ When installing the player

- Avoid shelves and other high locations.
- Place the player in a horizontal position, and do not place anything heavy on it.
- Do not place the player on amplifiers or other equipment which may become hot.

### □ When operating the player

- Do not expose the player to the sprays from volatile insecticides, etc. (Doing so may deform the external cabinet or cause the paint to peel off.)
- Do not push the LCD screen downward, especially using an object with a pointed end.
- After the player is used for many hours, the surface of the player becomes hot; this is normal, not a malfunction.
- Do not touch the pickup unit (the lens in particular) inside the inner cover with your hands or other objects. (Doing so may cause a malfunction.)
- Do not insert objects into the opening hole area of the pickup unit. (Doing so may cause a malfunction.)
- Do not push the inner cover downward during playback. (Doing so may damage the disc inside.)
- Do not subject the player to impact during playback. (Doing so may damage the disc inside.)

- Do not set the player down on a sofa for operation. (Doing so may increase the temperature inside the player and cause damage to the player.)

### □ When using the player outdoors

- Do not use the player in areas where it may get wet. (If the player gets wet, it may be damaged.)
- Do not use the player in sandy or dusty locations (such as a beach). (Sand and dust may find their way inside the player and cause a malfunction.)

### □ Condensation

Moisture may form on the lens in the following conditions...

- immediately after a heater has been turned on.
- in a steamy or very humid room.
- when the player is moved from a cold environment to a warm one.

If moisture forms inside this player, it may not operate properly. In this case, turn on the power and wait about 1 to 2 hours for the moisture to evaporate.

### □ When bringing the player on board an aircraft

- The electromagnetic waves emitted by the player may interfere with the aircraft's instruments. Follow the instructions given by the flight attendants.

### □ When bringing the player into a hospital

- The electromagnetic waves emitted by the player may interfere with the medical equipment in the hospital. Follow the instructions given by the medical personnel.

# Operating precautions

---

## Handling precautions

### □ When bringing the player inside a car

- Do not use the car's cigarette lighter socket to supply power to the player. (Doing so may cause a malfunction.)
- The exclusive battery pack [supplied or optional (model No.: DY-DB50EX)] must always be used. (See pages 25–27.)
- Do not leave the player in areas of extremely high temperature [over approx. 140°F (60°C)] such as inside of the car in hot summer or in the car trunk or of extremely low temperature [under approx. 14°F (-10°C)]. (Doing so may cause the outer case deformation, or adversely affect battery pack performance and quality.)

### □ When moving or transporting the player

- When moving the player, remove the disc if one is inside, and disconnect the AC adaptor and other cords.
- When transporting the player for relocation, place the player in its original packing carton.
- Do not drop the player or bump it into objects when moving or transporting it.

### □ When the player is not going to be used for a long time

- To conserve power, set the player to the standby mode, and disconnect the AC adaptor from the AC outlet. (Even when the player is set to the standby mode, power equivalent to about 2.0 W will be consumed unless the AC adaptor is disconnected.)
- Be sure to close the inner cover. (Dust may attach to the lens or other parts, which may cause a malfunction.)

# Disc handling and maintenance

## □ Handling precautions

- Hold the disc by the edges so the surface will not be soiled with fingerprints. Fingerprints, dirt and scratches can cause skipping and distortion.

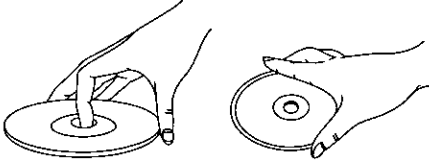

- Do not write on the label side with a ball-point pen or other writing instruments.
- Do not use record cleaning sprays, benzine, thinner, static electricity prevention liquids or any other solvent.
- Be careful not to drop or bend the disc.
- Do not install more than 1 disc.
- Do not try to close the inner cover when the disc is not installed properly.
- Be sure to store the disc in its exclusive case when not in use.

## □ If the surface is soiled

Wipe gently with a soft, damp (water only) cloth.

When wiping discs, always move the cloth from the center hole toward the outer edge.

(If you wipe the discs using a circular motion, circular scratches are likely to occur, which will cause noise.)

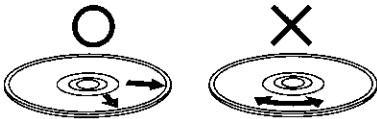

## □ If the disc is brought from a cold to a warm environment, moisture may form on the disc

Wipe this moisture off with a soft, dry, lint-free cloth before using the disc.

## □ Improper disc storage

You can damage discs if you store them in the following places:

- Areas exposed to direct sunlight
- Humid or dusty areas
- Areas directly exposed to a heat outlet or heating appliance

## Maintenance of the main unit

- Be sure to press and hold STOP (□) to set the player to the standby mode and disconnect the plug of the AC adaptor before maintaining the player.
- Wipe this player with a dry, soft cloth. If the surfaces are extremely dirty, wipe clean with a cloth which has been dipped in a weak soap-and-water solution and wrung out thoroughly, and then wipe again with a dry cloth.
- Never use alcohol, benzine, thinner, cleaning fluid or other chemicals. And do not use compressed air to remove dust.

## □ Maintenance of the lens

- If dust is attached to the lens, remove dust carefully with an air blower for camera lenses (optional). Be careful not to touch the lens with your fingers.

## Maintenance of the LCD

- Wipe the LCD screen with a dry, soft cloth.
- Drops of water spilled on the LCD screen may cause discoloration: wipe them dry immediately.

# Control reference guide

## Player (Front view)

### Lock release knob

Slide the knob to the right and then open the outer cover. (See page 28.)

### DISPLAY MODE button

#### [DISPLAY MODE]

Press to select the display mode of the LCD. (When the player is turned ON, **NORMAL** will be selected.) (See page 59.)

### Stereo speakers\*1

### BRIGHT dial [BRIGHT]

Turn to adjust the brightness of the screen.

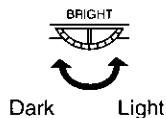

### Remote control signal sensor

Point the remote control unit at the sensor when operating the player. (See page 23.)

### CHARGE indicator [CHG]

- Illuminates during charging.
- Goes off when charging is completed or when the battery is charged.
- Refer to the page 78 about flashing.

### STANDBY indicator [⏻]

- Illuminates in the standby mode.
- Goes off when the player is turned on.
- Refer to the page 78 about flashing.

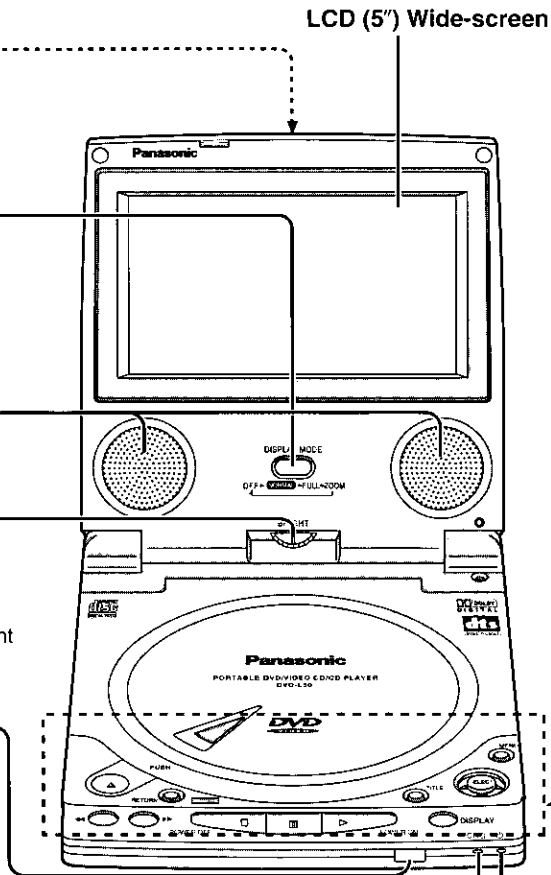

\*1The built-in stereo speakers may not provide satisfactory sound volume and sound quality depending on the disc. In this case, it is recommended to connect headphones (optional) or external speakers. (See pages 67–70.)



## Function buttons

### SKIP/SEARCH buttons [◀◀, ▶▶]

Press for skipping ahead/back or rapid advance/reverse (see page 33) or for slow-motion play (see page 35).

◀◀: Reverse direction

▶▶: Forward direction

### MENU button [MENU]

When pressed during play, the DVD menu recorded on the disc will be displayed. (See page 43.)

When pressed in the stop mode, the initial settings screen will be displayed. (See page 51.)

### RETURN button [RETURN]

Press to return to the previous menu.

### Joystick/SELECT button [SELECT]

Make the selection by tilting the joystick forwards, backwards or to the left or right, and then press SELECT to enter the selection. (See page 31.)

### OPEN button [⏏]

Press to open the inner cover. (See page 28.)

### TITLE button [TITLE]

Press to show the title menu recorded on the disc. (See page 43.)

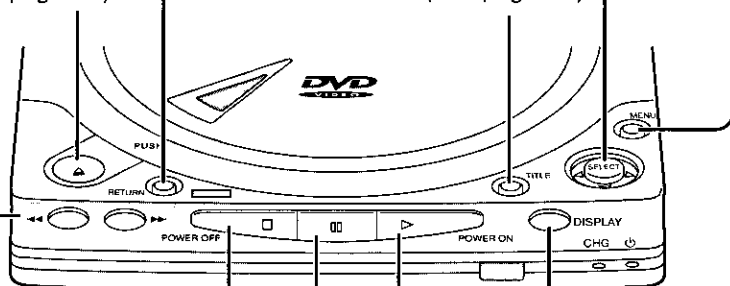

### STOP [◻]/POWER OFF [POWER OFF] button

Press to stop playback. (See page 32.) If this button is kept pressed when the player is ON, the player will be set to the standby mode (if the AC adaptor is used) or the player will be turned off (if the battery pack is used).

### PAUSE button [▢▢]

Press to place the player in the still picture/pause mode. (See page 34.)

### DISPLAY button [DISPLAY]

Press to show the On-Screen Menu Icons. (See page 37.)

### PLAY [▶]/POWER ON [POWER ON] button

Press to start playback. (See page 31.) If this button is pressed in the standby mode (if the AC adaptor is used) or when the player is OFF (if the battery pack is used), the player will be turned on. When the disc is loaded, playback starts automatically.

# Control reference guide

## Player (Left-side view)

### DC input connector [DC IN 9V]

Connect the AC adaptor (supplied). (See pages 24 and 26.)

### S video output connector [S VIDEO OUT]

For connection of an S video cable (optional) to an external monitor. (See page 66.)

### Video input/output connector [VIDEO]

For connection of the audio/video cable (supplied) to an external monitor. (See pages 66 and 70.)

### Volume level [VOLUME]

Turn to adjust the volume level output from the built-in stereo speakers or the headphones.

0: No sound is heard  
10: Maximum

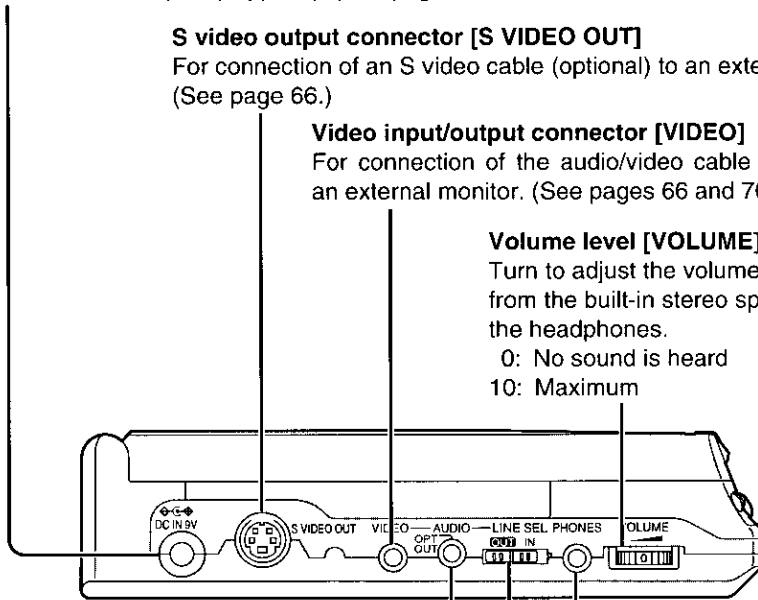

### Audio input/output (optical digital audio output) connector [AUDIO/OPT OUT]

For connection of the audio/video cable (supplied) or optical digital audio cable (optional) to an external audio system. The type of the output signal will be automatically selected according to the cord or cable to be connected. (See pages 66–70.)

### Headphone jack [PHONES]

For connection of the headphones (optional) with a 1/8" (3.5 mm) stereo plug. (See page 70.)

### In/Out select switch [LINE SEL **OUT** IN]

**OUT**: Select this setting when sending video or audio signals to an external device (such as a stereo or TV set) from the video input/output connector and audio input/output (optical digital audio output) connector. Normally, this setting should be used. (See pages 66, 67 and 69.)

**IN**: Select this setting when sending video or audio signals from an external device such as a video camera to the video input/output connector and audio input/output (optical digital audio output) connector so that the images appear on the screen. (See page 70.)  
(Be sure to return to the **OUT** position in normal playback.)

## Player (Right-side view)

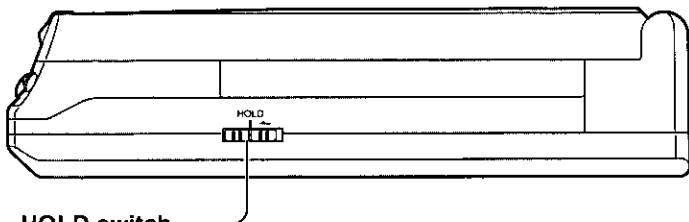

### HOLD switch

When this switch is slid toward the "HOLD" direction, the HOLD function (for preventing errors in operation) is activated. (If a function button is pressed when the HOLD function is ON, "HOLD" is displayed on the screen and the STANDBY indicator flashes.)

## Player (Rear view)

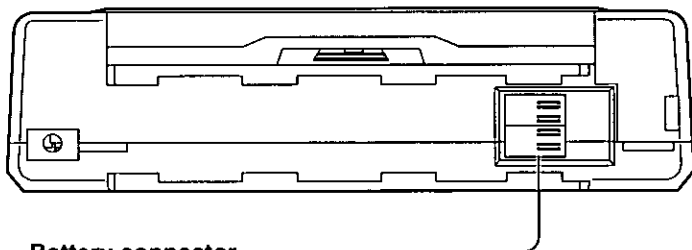

### Battery connector

Connect the battery pack [supplied or optional (model No.: DY-DB50EX)]. (See page 25.)

### Note:

- Be careful not to touch the battery connector terminals. (Doing so may cause the terminals to become misshapen.)  
Do not allow any metallic object to come into contact with the terminals. (Doing so could damage the player.)

### HOLD function:

The hold function ensures that even when a function button is inadvertently pressed while the player is being carried, the function corresponding to the button will not be acknowledged. (It prevents the function buttons from being pressed during operation, so as not to interrupt playback.)

# Control reference guide

## Remote control unit

### Buttons used for basic operations

#### PLAY button

Press to start playback.  
(See page 31.)  
If this button is pressed in the standby mode (if the AC adaptor is used), the player will be turned on. When the disc is loaded, playback starts automatically. (It is impossible to turn on the player with the remote control unit if the player is powered by the battery pack.)

#### PAUSE button

Press to place the player in the still picture/pause mode.  
(See page 34.)

#### STOP button

Press to stop playback.  
(See page 32.)  
If this button is kept pressed when the player is ON, the player will be set to the standby mode (if the AC adaptor is used) or the player will be turned off (if the battery pack is used).

#### DISPLAY button

Press to show the On-Screen Menu Icons. (See page 37.)

#### TITLE button

Press to show the title menu recorded on the disc.  
(See page 43.)

#### Cursor buttons/SELECT button

Make the selection by pressing the cursor buttons (▲, ▼, ◀, ▶), and then press SELECT to enter the selection. (See page 31.)

#### SKIP buttons

Press for skipping ahead/back.  
(See page 33.)  
◀◀: Reverse direction  
▶▶: Forward direction

#### SLOW/SEARCH buttons

Press for rapid advance/reverse (see page 33) or for slow-motion play (see page 35).  
◀◀: Reserve direction  
▶▶: Forward direction

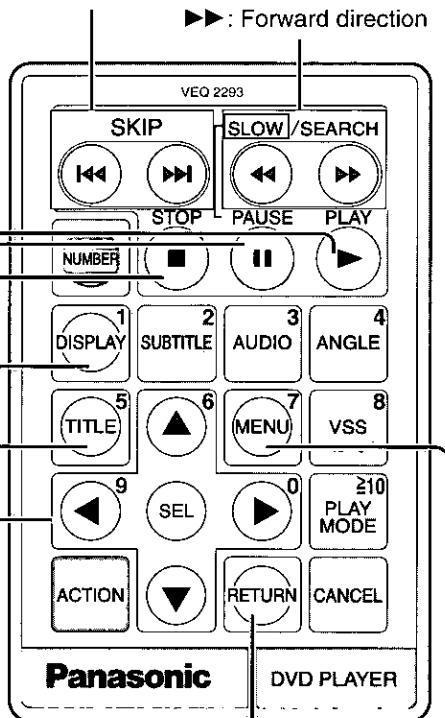

#### RETURN button

Press to return to the previous menu.

#### MENU button

When pressed during play, the DVD menu recorded on the disc will be displayed.  
(See page 43.)

When pressed in the stop mode, the initial settings screen will be displayed.  
(See page 51.)

## Buttons used for advanced operations

### NUMBER button

Press to change to number input mode, then press the button corresponding to the desired number.

#### • Entering numbers

Example: Entering "6"

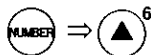

Example: Entering "16"

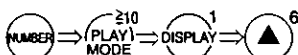

#### • To exit number input mode during the input process:

Press NUMBER.

### AUDIO button

Press to change the audio soundtrack language for DVD, to switch the vocal mode for DVD Karaoke, or to select "LR", "L" or "R" for Video CD. (See page 46.)

### ACTION button

Press to show the initial settings screen. (See page 51.)

### Virtual Surround Sound button [VSS]

Press to activate the Virtual Surround Sound effect. [This effect works only during playback of DVDs recorded in Dolby Digital Surround Sound (2ch and above).] (See page 49.)

### SUBTITLE button

Press to change the subtitle language. (See page 47.)

### ANGLE button

Press to view from another angle. (See page 48.)

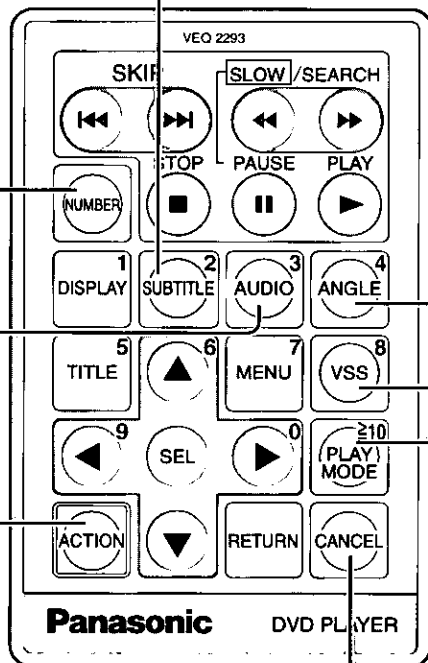

### CANCEL button

Press to clear the entered numbers.

### PLAY MODE button

Press to select "Normal play", "Program play" or "Random play". (See pages 44 and 45.)

# Remote control unit preparations

## Button-type battery (supplied) installation

**1** While sliding the release knob to the left, pull out the holder.

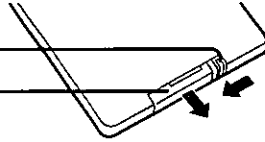

**2** With the ⊕ mark facing upwards, insert the battery.

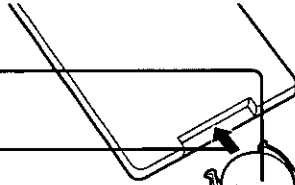

**3** Insert the holder.

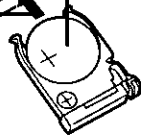

### □ Service life of the battery

- The button-type battery (Lithium battery) normally lasts for about one year although this depends on how often, and for what operations, the remote control unit is used.
- If the remote control unit fails to work even when it is operated near the player, replace the battery.
- Use CR2025 battery.

## Notes regarding the button-type battery

- Keep the button-type battery out of the reach of children.
- Make sure you insert the battery with its poles aligned.
- Do not attempt to recharge, short-circuit, disassemble, heat or throw the battery into a fire.
- Wipe away any electrolyte leaking inside the remote control unit, and install new battery.
- If any electrolyte should come into contact with parts of your body, wash it off thoroughly with water.

## Remote control operation range

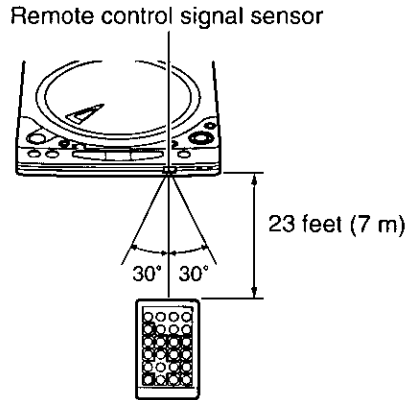

Preparation

## Remote control operational notes

- Do not drop, step on or otherwise impact the remote control unit. This may damage the parts or lead to malfunction.
- If the remote control unit is not going to be used for a long time, remove the battery. Otherwise, electrolyte may leak which may lead, not only to malfunction, but also, to burns if contact is made with the electrolyte.
- Do not point bright lights at the remote control sensor.
- Do not place objects between the remote control unit and the remote control sensor.
- Do not use this remote control unit while simultaneously operating the remote control unit of any other equipment.

# Powering the player using the AC adaptor

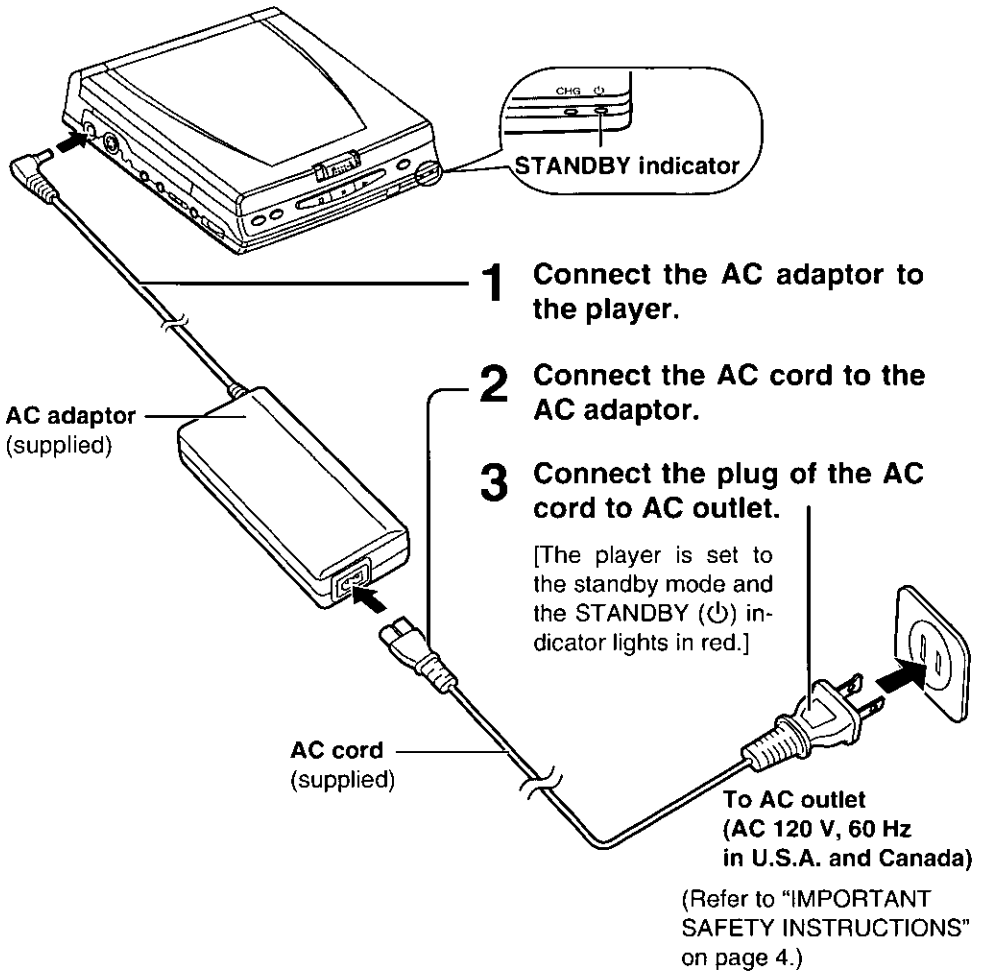

## Standby mode:

This refers to a condition in which the AC adaptor is connected to the AC outlet and the player is consuming a small amount of power (approx. 2.0 W).



# Powering the player using the battery pack (supplied)

## Attaching the battery pack

- 1 Align the mark on the battery pack with the one on the player.

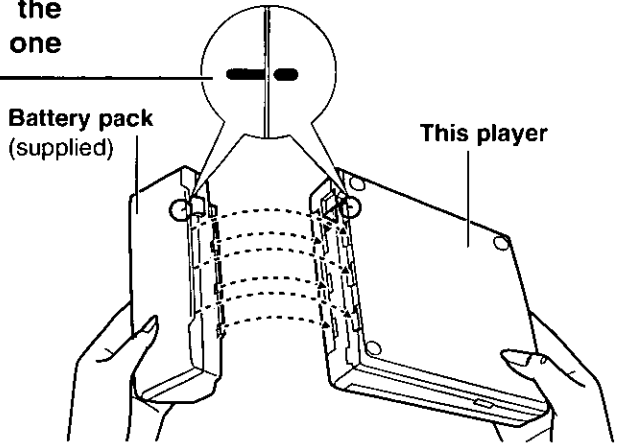

- 2 Slide the battery pack in the direction indicated by the arrow until the release button clicks.

(The battery pack is attached.)

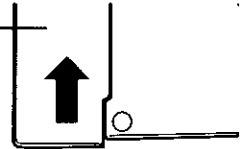

Preparation

## Detaching the battery pack

- 1 While pulling the release knob in the direction of the arrow, slide the battery pack in the direction of the arrow.

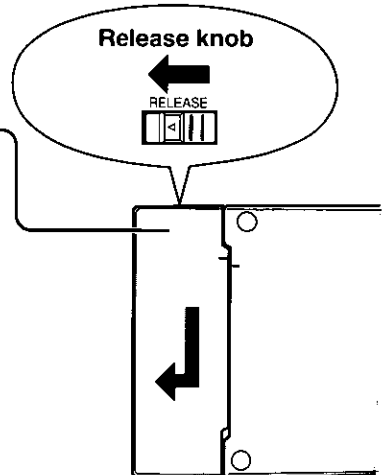

# Powering the player using the battery pack (supplied)

## Charging the battery pack

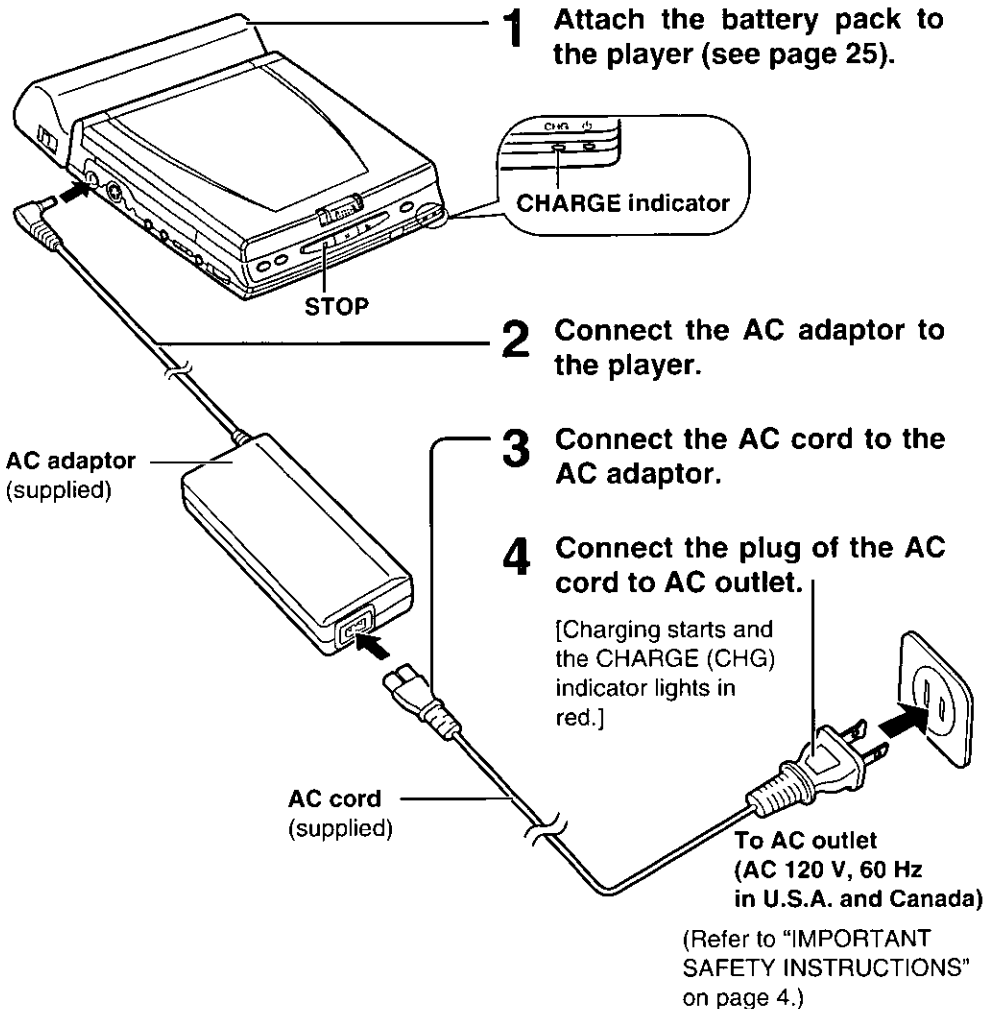

### For your reference:

- The battery pack will not be charged when the player is ON (during play or in the stop mode). Charging will start when the STOP (□) button is pressed and held for approximately two seconds to set the player to the standby mode.
- The CHARGE (CHG) indicator goes off when charging is completed. Disconnect the AC adaptor and the AC cord after confirming the CHARGE (CHG) indicator is OFF.
- In the case where charging fails to start, refer to the notes on page 71.

## Regarding the battery pack

### For your reference:

- This product is a rechargeable **lithium ion battery pack**. It generates electrical energy through an internal chemical reaction. This chemical reaction is easily affected by temperature and humidity conditions. The effects become more severe as the temperature increases or decreases. In locations where the temperature is low, the battery pack may not fully charge, or the CHARGE (CHG) indicator on the player may flash about 5 minutes after you start using it. At higher temperatures, a protector circuit may be activated, making the battery pack inoperative.
- It takes about 6 hours [at 68°F (20°C)] to charge the battery pack and, once fully charged, the battery will be good for approximately 3 hours of continuous playback (with the BRIGHT dial set to the center position). However, usage time will differ depending on the operating condition. (If the brightness is set higher, the battery operating time will be shorter.)



Center position

- The battery pack has a service life of approximately 300 charge-discharge cycles. (It may depend on the operating condition.) The charging time or operating time on one full charge will be gradually shorter. If the time becomes noticeably shorter than it used to be, the battery pack has reached the end of its service life and should be replaced.
- If the player is powered by the battery pack and is left in the STOP mode, the player will automatically turn off after approximately 5 minutes to conserve battery consumption (**Auto power-off function**).

### □ Notes when charging the battery pack

- When the battery pack is to be used for the first time, charge it fully before use.
- Upon completion of the charging, be sure to disconnect the power plug from the AC outlet. (If it is left connected, up to about 2.0 W of power will be consumed.)

### □ Notes when using the battery pack

- If the battery pack is not going to be used for a long time, it must be detached from the player. (If it is left attached, a low level of current will still flow even though the player is turned off.) If it is left in this state, it may excessively discharge, rendering it unusable even after it has been recharged.  
(Recharge the battery pack before use because the battery pack is discharging even when it is detached from the player.)
- The AC adaptor is equipped with an overcharge-prevention circuit. However, to protect the battery pack, be sure to detach it from the player upon completion of the charging.
- For battery pack protection, do not charge an already fully-charged battery pack.

### □ Notes when storing the battery pack

- Store the battery pack in areas where temperature is at 59°F–77°F (15°C–25°C).
- Do not store the battery pack in areas of extremely cold or high temperature, high humidity or excessive oily smoke.
- When storing the battery pack for a long period of time, discharge and fully recharge it once a year and store it again.

### □ Notes when disposing of the battery pack

- Check, and follow, your local regulations before disposal.

# Inserting/Removing discs

## Inserting discs

- 1** While sliding the lock release knob to the right, open the outer cover.

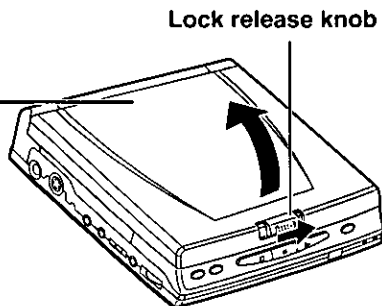

- 2** Press OPEN () and open the inner cover.

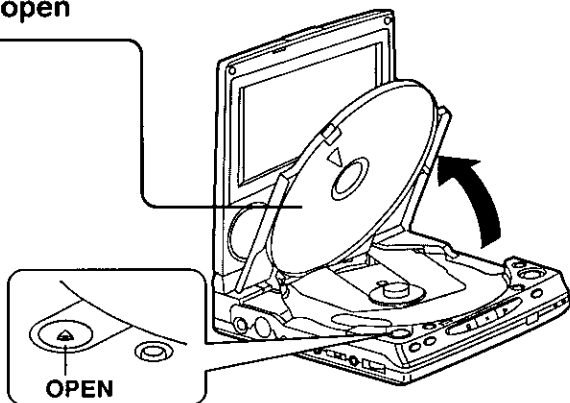

- 3** With the label side to be played facing upwards, (if the disc has a label) place the disc in position, using your fingers to push down on the area around the center hole. (A click is heard.)

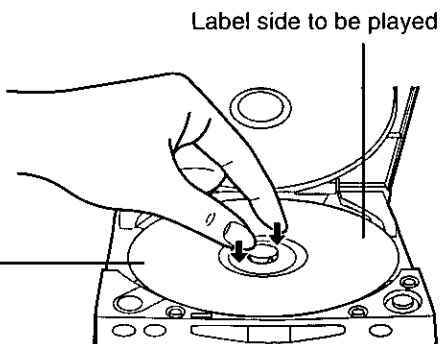

- 4** Close the inner cover.

### Note:

- Do not install more than 1 disc.

## Removing discs

- 1 If a disc is currently playing, press STOP (□).

- 2 Press OPEN (△) and open the inner cover.

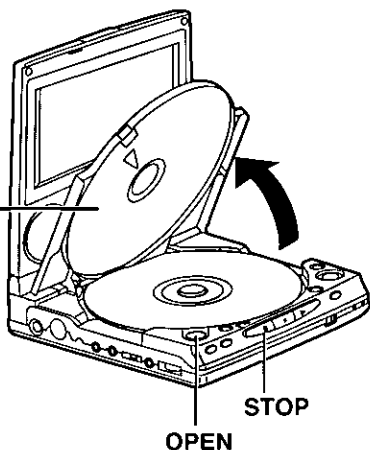

- 3 Using the groove for removing, remove the disc.

- Do not touch the disc surface when removing.

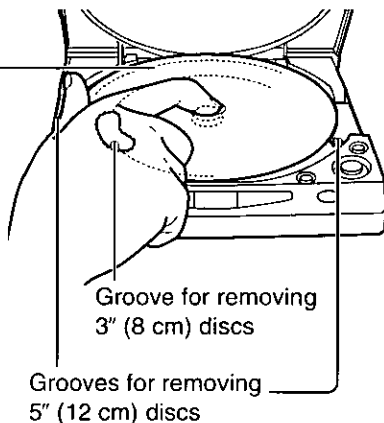

- 4 Close the inner cover.

### Note:

- Be sure to keep the inner cover closed except while inserting/removing discs. This will reduce the risk of malfunction caused by dust entering the inside of the player.

# Basic play

Confirm that the disc is loaded. (See page 28.)

## Before enjoying DVD/Video CD/CD

The On-Screen menu language of your player has been factory preset to English. If you would like to change the menu language to French or Spanish, please refer to "When '3 Menu Language' is selected" on page 56.

In the explanations given below it is assumed that English has been selected as the menu language.

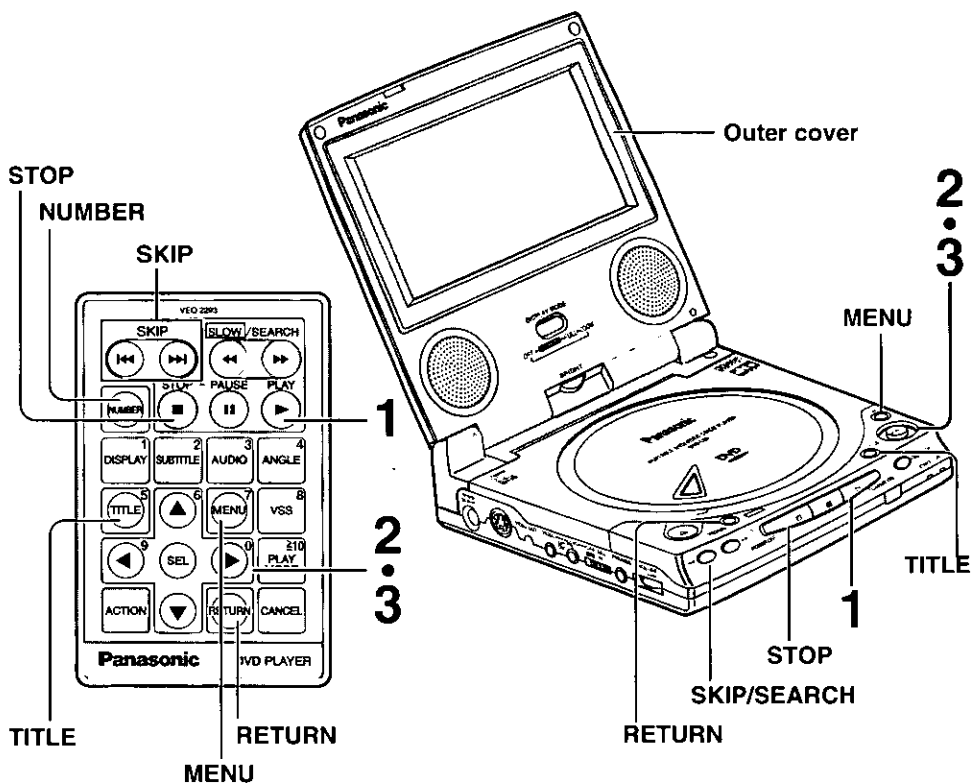

### Note:

- The disc continues to rotate while the menu is displayed even after the player has finished playing a particular item. When no further selections are to be played, be sure to press STOP (□) to clear the menu display.

### For your reference:

- In the case of the remote control, select the item using the cursor buttons instead of the joystick.
- When the menu continues onto another screen, pressing SKIP/SEARCH (◀◀, ▶▶) (in the case of the remote control, SKIP) will show the next screen. (The buttons may not work depending on the disc used. For operation, refer also to the jacket of the disc concerned.)

# 1 Press PLAY (▷).

(The player is turned on and play begins automatically.)

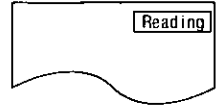

## □ When a menu appears on the screen

In case of many movie DVDs, an interactive DVD or a Video CD with play-back control (see page 80), a menu appears on the screen. Perform steps 2 and 3 to start play.

**Example:**  
Interactive DVD

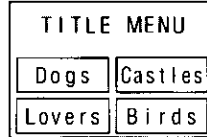

**Example:**  
Video CD with play-back control



# 2 Tilt the joystick (▲, ▼, ◀, ▶) to select the preferred item.

- The NUMBER button on the remote control is also effective for selecting the item. (See page 21 for information on entering numbers.)  
When the item is selected using the NUMBER button, step 3 is not necessary.

**Example: DVD**  
When "Birds" is selected

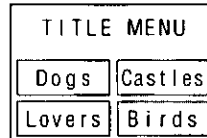

- The joystick is not effective for selecting items for Video CDs. Select the item using the NUMBER button.

# 3 Press SELECT.

(Play of the selected item now begins.)

## □ After operation

When the player is not in use, to save power, press and hold STOP (□) to set the player to the standby mode. The player is automatically set to the standby mode after approx. 15 minutes have elapsed in the stop mode (**Auto power-off function**). (If the player is powered by the battery pack, the power will automatically be turned off after approx. 5 minutes have elapsed.)

- To return to the menu screen, press TITLE, MENU or RETURN (for DVD), or RETURN (for Video CD). (The buttons may not work depending on the disc used.)
- When Ⓞ appears on the screen while a button is being operated, it means that the corresponding operation is prohibited by the player or the disc.
- Closing the outer cover or turning the LCD display screen to OFF while playing music CDs reduces power consumption. These measures also conserve battery power when operating off the battery pack. (Under these conditions, the battery pack provides 4.5 hours of continuous playback when playing music CDs.)

# Basic play

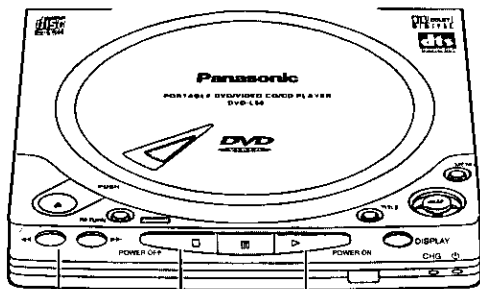

SKIP/SEARCH

STOP

PLAY

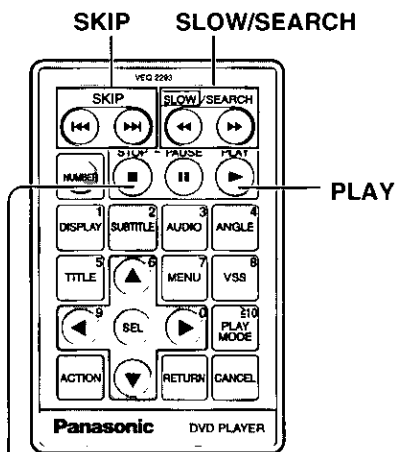

SKIP

SLOW/SEARCH

PLAY

STOP

## Additional operation

—While watching the movie program—

### □ Raising the volume but only for the dialogue

The volume for the dialogue only can be raised by displaying the On-Screen Menu Icons (for player information) and setting "Dialogue Enhancer" to "ON". (See page 41.)

[This setting takes effect only for discs which are recorded with Dolby Digital (AC-3) 5.1ch and with the dialogue contained in the center channel.]

## Stopping play

On the player or on the remote control unit,  
press STOP (□) during play.

### RESUME function:

The player records the point where STOP (□) was pressed during play (RESUME function). ("▶" flashes on the screen when this function is activated.)

- Press PLAY (▷) again while "▶" flashes, and play will resume from this point.
- When the inner cover is opened or STOP (□) is pressed again while "▶" flashes, the RESUME function will be cleared.

This feature will not be cleared when the player is turned off and then turned back ON.

### Chapter preview function (DVD only):

When PLAY (▷) is pressed while "▶" flashes, the message shown below is briefly displayed.

Press PLAY to Chapter Preview

When PLAY (▷) is pressed again while the above message is displayed on the screen, the first few seconds of each chapter from the beginning of the title up to the point where operation was stopped will be played. This makes it possible to review previously viewed chapters. Normal playback will commence from the point where operation was stopped.

### Note:

- Cancelling the RESUME function will also clear the chapter preview function.



## Skipping ahead or back

### On the player

Press **SKIP/SEARCH** (◀◀, ▶▶) during play.

- ◀◀: Reverse direction
- ▶▶: Forward direction

### With the remote control unit

Press **SKIP** during play.

- ◀◀: Reverse direction
- ▶▶: Forward direction

- A chapter (DVD) or a track (Video CD/CD) is skipped each time the button is pressed.
- When **SKIP/SEARCH** (◀◀) [in the case of the remote control, **SKIP** (◀◀)] is pressed once midway through a chapter/track, play returns to the start of that chapter/track. When it is pressed again, a chapter/track is skipped each time the button is pressed.

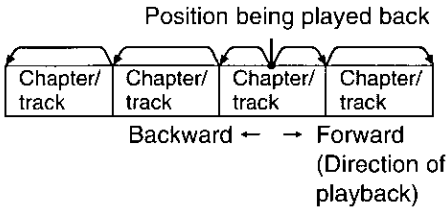

- When **SKIP/SEARCH** (◀◀, ▶▶) (in the case of the remote control, **SKIP** or **SLOW/SEARCH**) is pressed during menu play of Video CDs with playback control, a menu screen may sometimes be recalled.

## Rapid advance (Rapid reverse)

### On the player

Press and hold **SKIP/SEARCH** (◀◀, ▶▶) during play.

- ◀◀: Reverse direction
- ▶▶: Forward direction

- The speed will be retained even after the button is released.

### With the remote control unit

Press **SLOW/SEARCH** during play.

- ◀◀: Reverse direction
- ▶▶: Forward direction

- The speed of advance (reverse) is relatively slow at first. When the button is pressed again, the speed becomes faster. (Each time the button is pressed, the speed increases up to 5 steps.)

- Normal play is resumed when **PLAY** (▷) is pressed.

### For your reference:

- For DVDs and Video CDs, audio will be heard during scanning at the initial scan speed. (See page 64.) For CDs, audio will be heard during scanning at every scan speed (1 to 5).

# Basic play

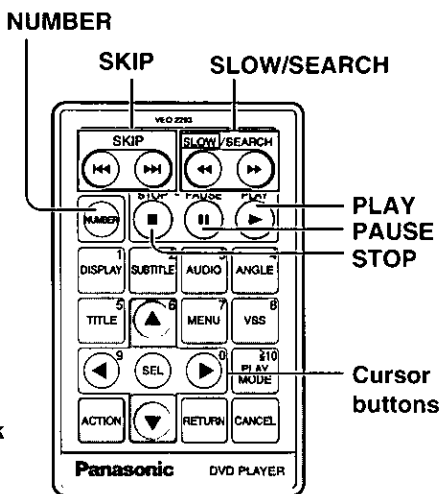
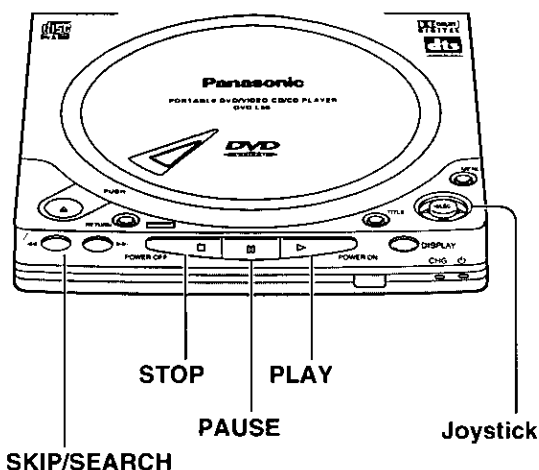

## Still picture (Pause)

On the player or on the remote control unit, press **PAUSE** (⏸) during play.

- The player will be placed in the still picture mode (for DVD/Video CD) or in the pause mode (for CD).
- Normal play is resumed when **PLAY** (▶) is pressed.

## Frame advance (Frame reverse) [DVD/Video CD]

Tilt the joystick (◀, ▶) in the still picture mode.

- ◀: Reverse direction
- ▶: Forward direction

- The disc is advanced (reversed) by one frame each time the joystick is tilted.
- When the joystick is kept tilted, consecutive frame advance (reverse) works.
- Normal play is resumed when **PLAY** (▶) is pressed.

### Notes:

- For Video CDs, frame reverse is not possible.
- If the On-Screen Menu Icons (Shuttle screen) are displayed, tilting the joystick in the still picture mode activates slow-motion play, and frame advance/frame reverse does not work. (See page 40.)

### For your reference:

- Pressing **PAUSE** (⏸) also activates frame advance.
- Pressing the cursor buttons (◀, ▶) will also activate frame advance/frame reverse.
- Whether the pictures are advanced by a "Frame" or "Field" is automatic. (See page 64.)

## Slow-motion play (DVD/Video CD)

### On the player

Press and hold **SKIP/SEARCH** (◀◀, ▶▶) in the still picture mode.

- ◀◀: Reverse direction
- ▶▶: Forward direction

- The speed will be retained even after the button is released.

### With the remote control unit

Press **SLOW/SEARCH** in the still picture mode.

- ◀◀: Reverse direction
- ▶▶: Forward direction

- The speed of slow-motion is slow at first. When the button is pressed again, the speed becomes faster. (Each time the button is pressed, the speed increases up to 5 steps.)

- Normal play is resumed when **PLAY** (▷) is pressed.

#### Note:

- For Video CDs, slow-motion playback in reverse direction is not possible.

## Enjoying Video CDs with playback control without using menus (Video CD)

**1** Press **STOP** (□) after the menu screen appears.

**2** Press **SKIP/SEARCH** (◀◀, ▶▶) to select the preferred track and press **PLAY** (▷).

- In the case of the remote control, press **SKIP** to select the preferred track and press **PLAY**. (Play begins.)

- Refer to the jacket etc. of the disc concerned for the track numbers.
- Select "track 1" to start play from the beginning of the disc.
- The **NUMBER** button on the remote control unit can also be used for entering the track numbers. (See page 21 for information on entering numbers.)  
When numbers are entered by the **NUMBER** button, pressing **PLAY** (▷) is not necessary.

**□ To return to menu play**

Press **STOP** (□) twice to stop playback and press **PLAY** (▷).

(The menu is resumed on the screen.)  
Perform steps 2 and 3 on page 31.

# Operations using the On-Screen Menu Icons

This player features On-Screen Menu Icons providing various functions, a "banner" will be displayed on the screen by pressing the DISPLAY button. Operating the joystick/cursor buttons/SELECT button will show disc information (title/chapter/track number, elapsed playing time, audio/subtitle language, and angle) and player information (repeat play, play mode, marker, Virtual Surround Sound, etc.). Some icons allow the settings to be changed.

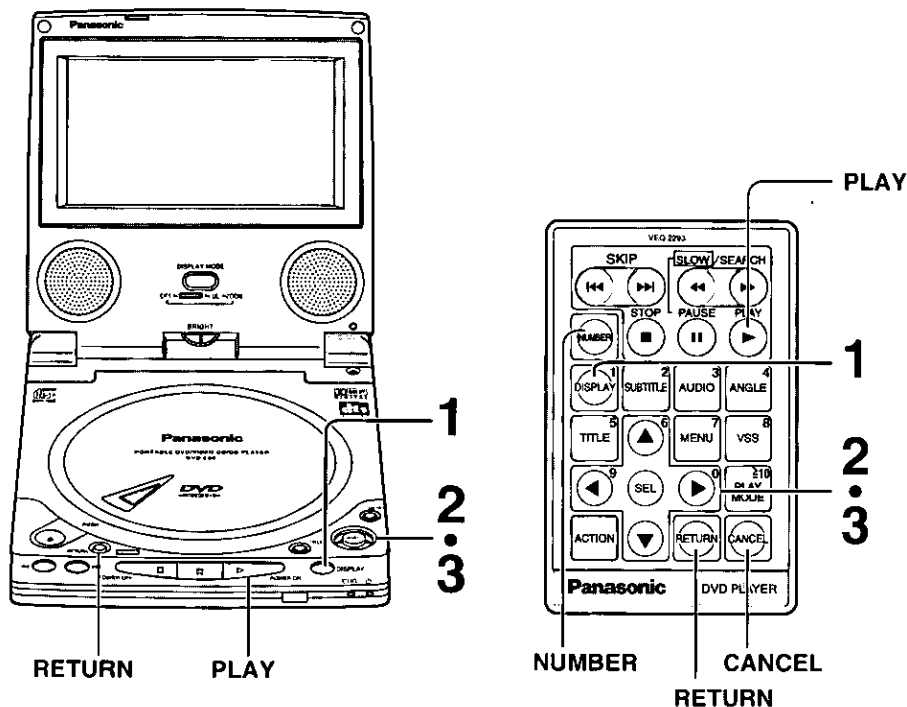

## For your reference:

- When playback of a CD starts, the On-Screen Menu Icons (for disc information) will automatically be displayed. Then, the icons can be changed using the procedures on page 37.
- In the case of the remote control, select the item using the cursor buttons instead of the joystick.
- Press RETURN or CANCEL to clear the On-Screen Menu Icons.
- For some functions, the setting will be registered immediately; for others, SELECT or PLAY (▷) must be pressed. Some functions cannot be accessed from the stop mode.
- When numbers are displayed (e.g. title No.), the NUMBER button on the remote control unit is also effective for setting instead of the joystick (▲, ▼). (See page 21 for information on entering numbers.) When numbers is entered using the NUMBER button, press SELECT to register the setting.

**1 Press DISPLAY during play or in the stop mode.**  
(On-Screen Menu Icons are displayed.)

- Each time the button is pressed, the icons change as shown in the right.
- The icons may differ depending on the disc contents.

**Example: DVD**

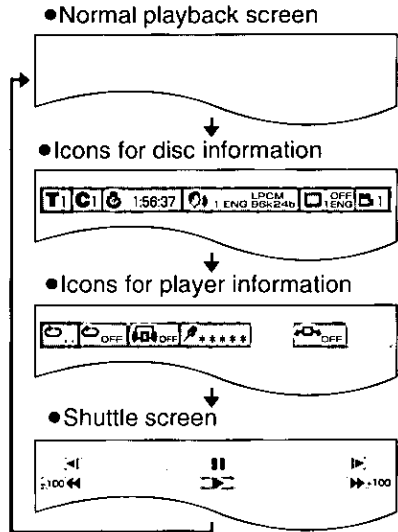

**2 Tilt the joystick (◀, ▶) to select the preferred item.**  
(The currently selected item is indicated by the yellow frame on the On-Screen Menu Icons.)

**3 Tilt the joystick (▲, ▼) to select the preferred setting.**

• If a TV set is connected to the player, depending on the type of the DVD software and a TV with automatic picture zoom function enabled, the On-Screen Menu Icons may not be displayed or only partially displayed on the TV screen. In this case, change the position of the On-Screen Menu Icons in "4 On-Screen Messages" of the initial settings. (See page 57.)

• The color (blue, violet or green) of the On-Screen Menu Icons can be changed. (See page 57.)

# Operations using the On-Screen Menu Icons

## Detailed descriptions of each icon (Icons for disc information)

### □ DVD

**Title No.** Change the title No. by using the joystick (▲, ▼) and press SELECT.

**Elapsed playing time**  
(hour: minute: second)

Change the time by using the NUMBER button and appropriate buttons, and press SELECT. (See page 21 for information on entering numbers.)  
Example: To specify "1 hour 56 min. 37 sec.", enter "15637". (This function does not work with some discs.)



**Chapter No.**

Change the chapter No. by using the joystick (▲, ▼) and press SELECT.

### □ Video CD/CD

**Track No.** Change the track No. by using the joystick (▲, ▼) and press SELECT.

**Elapsed playing time**  
(minute: second)

During CD play, display is changed each time the joystick (▲) is tilted.

Elapsed playing time → Remaining time of the track

← Remaining time of the disc ←



**Playback control**  
(Video CD only)  
(See page 80.)

OFF

Menu play is not ON.

ON

Menu play is ON.

<b>Subtitle language No.</b>	Change the No. by using the joystick (▲, ▼).	
<b>Subtitle language</b>	ENG: English FRA: French DEU: German ITA: Italian ESP: Spanish NLD: Dutch SVE: Swedish NOR: Norwegian DAN: Danish	POR: Portuguese RUS: Russian JPN: Japanese CHI: Chinese KOR: Korean MAL: Malay VIE: Vietnamese THA: Thai *: Others
<b>Subtitle on/off</b>	Select "ON" or "OFF" by using the joystick (▲, ▼).	
	OFF	Subtitle is cleared.
	ON	Subtitle is displayed.
<b>Angle No.</b>	Change the No. by using the joystick (▲, ▼).	

<b>Audio soundtrack language No.</b>	Change the No. by using the joystick (▲, ▼).			
<b>Audio soundtrack language</b>	ENG: English FRA: French DEU: German ITA: Italian ESP: Spanish NLD: Dutch SVE: Swedish NOR: Norwegian DAN: Danish	POR: Portuguese RUS: Russian JPN: Japanese CHI: Chinese KOR: Korean MAL: Malay VIE: Vietnamese THA: Thai *: Others		
<b>Audio attribute</b>	LPCM	96k or 48k	16b or 20b or 24b Linear PCM ("k" stands for kHz and "b" stands for bit.)	
		DD	1-5.1ch Dolby Digital (AC-3)	
	DTS	1-5.1ch	dds	
	Vocal	--- (OFF)		DVD Karaoke (Solo)
		ON		
	Vocal	--- (OFF)		DVD Karaoke (Duet)
V1+V2				
V1				
	V2			

<b>Audio mode</b> (Video CD only)	Change the mode by using the joystick (▲, ▼).	
	LR	Left channel sound is output from the speaker (L), and right channel sound from the speaker (R).
	L	Left channel sound only is output.
	R	Right channel sound only is output.

**Note:**

• It is not possible to turn playback control ON or OFF using the On-Screen Menu Icons.

**For your reference:**

- In the case of the remote control, the items can be changed using the cursor buttons instead of the joystick.
- "▲ ▼" around the icon means that the item can be changed using the joystick (cursor buttons) (▲, ▼).

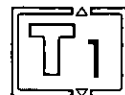

# Operations using the On-Screen Menu Icons

## Detailed descriptions of each icon (Icons for player information)

<b>Repeat play</b>	Select the preferred mode during play by using the joystick (▲, ▼).		DVD	
	OFF	Normal play		
	C	Chapter repeat play		
	T	Title repeat play		
	OFF	Normal play		Video CD/ CD
	T	Track repeat play		
A	Disc repeat play			

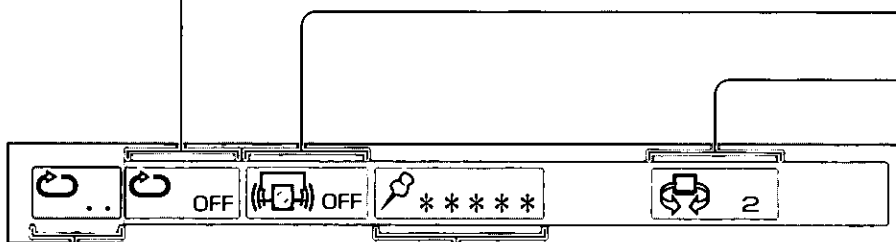

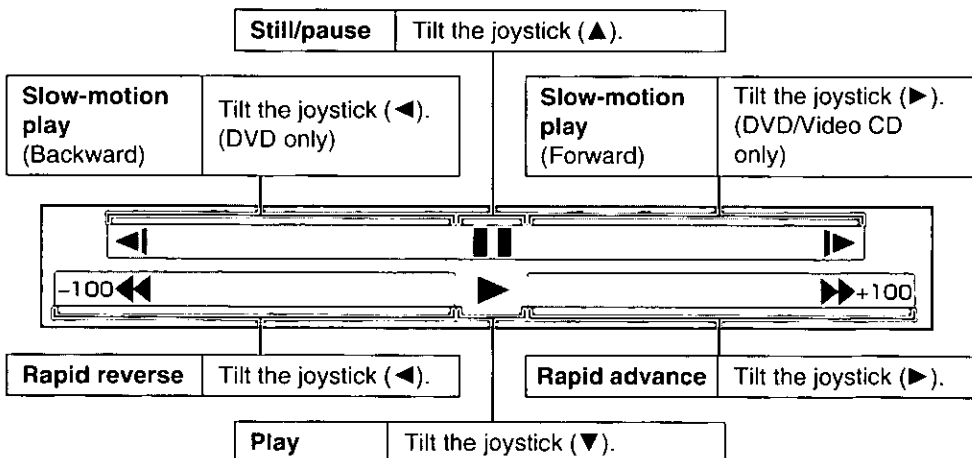

<b>A-B repeat play</b>	Press SELECT during play to store location A and press SELECT again to store location B and to start repeat play between the specified two locations. Press SELECT again to return to normal play.
------------------------	--

## Detailed descriptions of each icon (Shuttle screen)





<p>● <b>DVD Dialogue Enhancer</b> (See page 32.)</p> 	Select the preferred mode during play by using the joystick (▲, ▼).	
	OFF	Normal volume
<p>● <b>Video CD/CD Play mode</b> (See pages 44 and 45.)</p> 	PRG	Program play
	RND	Random play
	---	Normal play

<p><b>Virtual Surround Sound (VSS)</b> (DVD only) (See page 49.)</p>	Select the preferred mode during play by using the joystick (▲, ▼).	
	OFF	VSS off
	1	VSS natural effect
	2	VSS emphasized effect

<p><b>Marker</b></p>	<p>Press SELECT during play and press SELECT again at the preferred point to store a marker. (Up to 5 markers can be stored in the memory.) (Marker no. is displayed instead of "※".)</p> <ul style="list-style-type: none"> <li>● To recall a marker, select the preferred marker no. by using the joystick (◀, ▶) and enter the selection by using the joystick (▲).</li> <li>● To clear a marker, select the preferred marker no. by using the joystick (◀, ▶) and press CANCEL on the remote control.</li> </ul>
----------------------	--

**Note:**

- It is not possible to change the play mode using the On-Screen Menu Icons.

**For your reference:**

- In the case of the remote control, the items can be changed using the cursor buttons instead of the joystick .
- All the markers are cleared when the player is set to the standby mode or turned off, or the disc is removed.
- Each time the joystick (◀, ▶) is tilted or the cursor button (◀, ▶) is pressed, the speed of rapid advance/reverse and slow-motion play increases up to 5 steps.
- The figures appearing at both ends of the shuttle screen stand for the maximum speeds of rapid advance/reverse.

(DVD: +100/-100, Video CD: +40/-40, CD: +50/-50)

## Additional operation

VCD CD

### To enjoy program repeat play

Select the preferred mode by following the "Repeat play" procedure on page 40 during program play (see page 44).

- Program play
- Icons for disc information
- Cancel repeat mode
- Repeat of programmed track being played
- Repeat of all programs

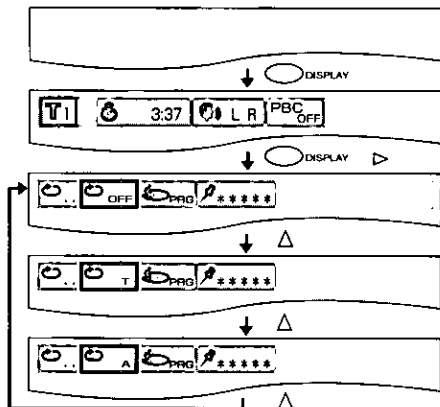

Program play is resumed when "OFF" is selected.

## For your reference

### Chapter/Title repeat play (DVD)

Position being played back

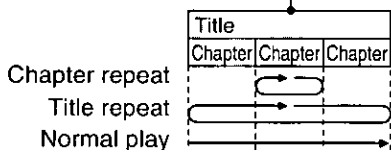

### Track/Disc repeat play (Video CD/CD)

Position being played back

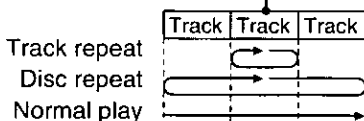

### A-B repeat play

Starting location A    End location B

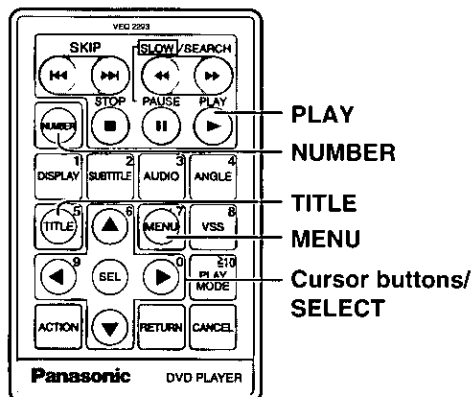
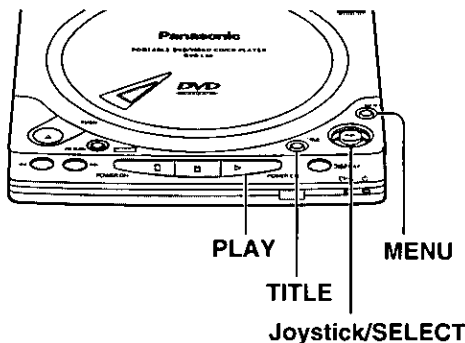
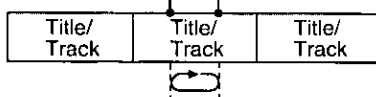

## Using a title menu

**1 Press TITLE during play.**  
(A list of the titles on the disc is now displayed.)

- Pressing TITLE again resumes play from the scene when TITLE was first pressed.

Example:

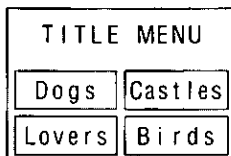

**2 Tilt the joystick (▲, ▼, ◀, ▶) to select the preferred title and press SELECT or PLAY (▷).**  
(The selected title now starts playing.)

## Using a DVD menu

**1 Press MENU during play.**  
(The DVD menu available on the disc is now displayed.)

- Pressing MENU again resumes play from the scene when MENU was first pressed.

Example:

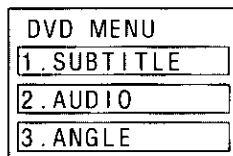

**2 Tilt the joystick (▲, ▼, ◀, ▶) to select the preferred item and press SELECT.**  
(The selected item is now executed.)

- To display the menu screen one after another, repeat step 2.

### For your reference:

- In the case of the remote control, select the item using the cursor buttons instead of the joystick.
- The NUMBER button on the remote control unit is also effective for selecting the title or item. (See page 21 for information on entering numbers.)  
When the title or item is selected using the NUMBER button, pressing SELECT or PLAY(▷) is not necessary.

### □ Title menu

If the DVD has multiple titles recorded on it, it is possible to select the preferred title from the title menu to start playback.

### □ DVD menu

Some DVDs have unique menus. For example, these menus can be for language selection, audio output selection and/or subtitle language selection, etc. These menus are called "DVD menus". Although the DVD menu's contents and operation differ from disc to disc, the above procedures explain basic operation when this feature is used.

# Playing tracks in an order you specify or in random order (Program play/Random play)

## Playing tracks in an order you specify (Program play)

The player plays the tracks on the disc in an order you specify.

### 1 Press PLAY MODE in the stop mode.

(The program playback screen is displayed.)

Example: a disc including 17 tracks

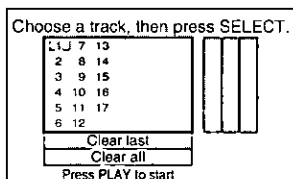

- To exit the screen  
Press PLAY MODE twice.

### 2 Press the cursor buttons (▲, ▼, ◀, ▶) to select the preferred track number.

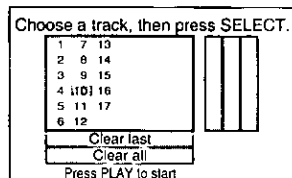

- The NUMBER button is also effective for selecting the item. (See page 21 for information on entering numbers.) When the number is selected using the NUMBER button, step 3 is not necessary.

### 3 Press SELECT.

(The selected track is stored in the memory.)

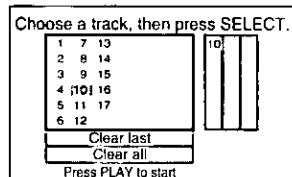

- Repeat steps 2 and 3 to select another track.
- Up to 18 tracks can be programmed.

### 4 Press PLAY.

(Play now begins in the programmed sequence.)

NUMBER STOP PLAY

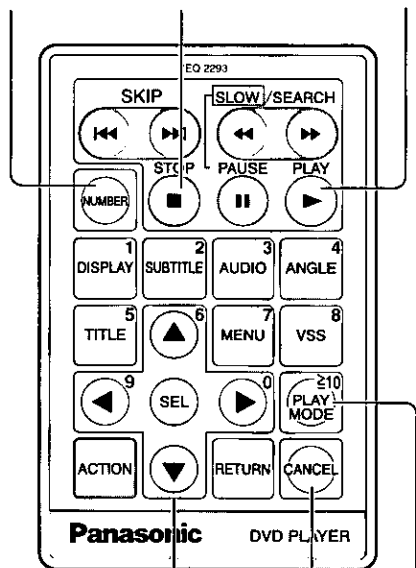

Cursor buttons/  
SELECT

CANCEL  
PLAY MODE

## Playing tracks in random order (Random play)

The player plays the tracks on the disc in random order.

### 1 Press PLAY MODE twice in the stop mode.

(The random playback screen is displayed.)

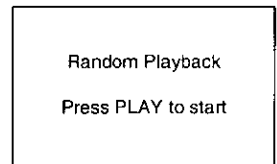

#### •To exit the screen

Press PLAY MODE once.

### 2 Press PLAY.

(Play now begins in random order.)

#### □ After playback

Play is stopped and the program playback screen is displayed.

#### □ To return to normal play

Press STOP to stop program play, and then press PLAY MODE twice.

When PLAY is pressed, normal play begins from the beginning of the disc.

(The content of the program is still retained in the memory.)

#### □ To clear the last program one by one

Press STOP twice during program play or press PLAY MODE once in the stop mode to display the program playback screen. Each time CANCEL is pressed, the last program is cancelled.

Selecting "Clear last" using the cursor buttons and pressing SELECT also clears the last program.

#### □ To clear all the programs

The programs are cleared when the player is set to the standby mode or turned off, or the inner cover is opened.

Selecting "Clear all" using the cursor buttons and pressing SELECT also clears all the programs.

#### □ After playback

Play is stopped and the random playback screen is displayed.

#### □ To return to normal play

Press STOP to stop random play, and then press PLAY MODE once.

When PLAY is pressed, normal play begins from the beginning of the disc.

# Using the multi-functions

## Changing audio soundtrack language (Multi-audio function)

It is possible to change the audio soundtrack language to a different language from the one selected at the initial settings. (If available. See page 52.)

(This operation works only with discs on which multiple audio soundtrack languages are recorded.)

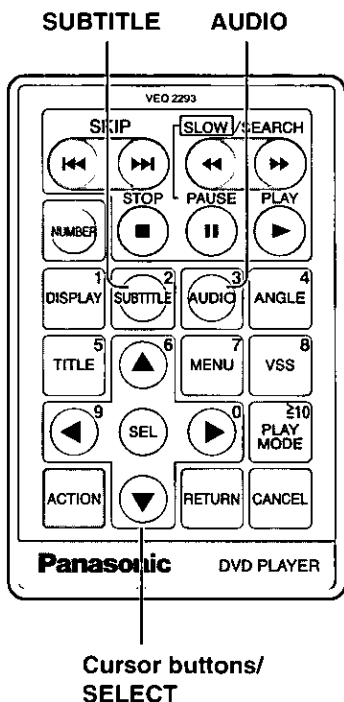

- 1 Press AUDIO during play.**  
(Number of the audio soundtrack language being played back is displayed.)

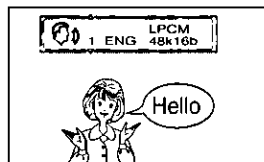

- When no audio soundtrack is recorded, "—" will be displayed instead of the language number.

- 2 Press the cursor buttons (▲, ▼) until the preferred language is selected.**

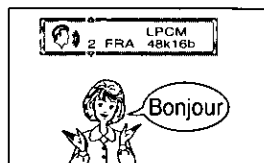

- Press AUDIO or SELECT to clear the display.

### For your reference:

- When the power is turned on, or the disc is removed, the language heard is the one selected at the initial settings. If this language is not recorded on the disc, only the available language on the disc will be heard.

## Changing subtitle language (Multi-subtitle function)

It is possible to change the subtitle language to a different language from the one selected at the initial settings. (If available. See page 52.)

(This operation works only with discs on which multiple subtitle languages are recorded.)

### 1 Press **SUBTITLE** during play.

(Number of the subtitle language being played back is displayed.)



- When no subtitles are recorded, "— —" will be displayed instead of the language number.

### 2 Press the cursor buttons (**▲**, **▼**) until the preferred language is selected.



- Press **SUBTITLE** or **SELECT** to clear the display.

#### Note:

- When a disc supporting the closed caption is played, the subtitle and the closed caption may overlap each other on the screen. In this case, turn the subtitle off.

## Additional operations

### Switching vocals ON or OFF for Karaoke discs



Press **AUDIO** during play of Karaoke discs.

- Press **AUDIO** or **SELECT** to clear the display.
- This operation does not work with CDs.

#### •DVD Karaoke (Solo)

"—" (OFF) or "ON" of vocals can be selected by pressing the cursor buttons (**◀**, **▶**).

#### •DVD Karaoke (Duet)

"—" (OFF), "1+2" (ON), "V1" (ON) or "V2" (ON) of vocals can be selected by pressing the cursor buttons (**◀**, **▶**).

#### •Video CD

"LR", "L" or "R" can be selected by pressing the cursor buttons (**▲**, **▼**).

### To clear/display the subtitles



Press the cursor buttons (**◀**, **▶**) to select ON or OFF at step 2.

#### For your reference:

- When the power is turned on, or the disc is removed, subtitles appear in the language selected at the initial settings. If this language is not recorded on the disc, they appear in the disc's priority language.

## Viewing from another angle (Multi-angle function)

Some DVDs may contain scenes which have been shot simultaneously from a number of different angles. For these discs, the same scene can be viewed from each of these different angles using the ANGLE button. (The recorded angles differ depending on the disc used.)

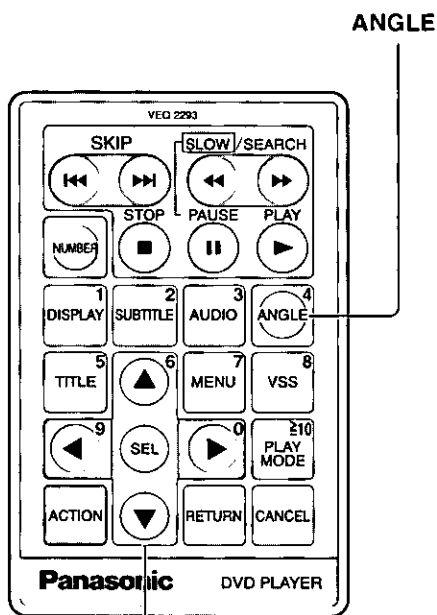

Cursor buttons/  
SELECT

- 1 Press ANGLE during play.**  
(Number of angle being played back is displayed.)

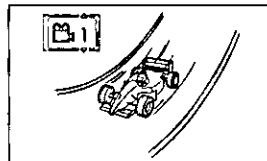

- 2 Press the cursor buttons (▲, ▼) until the preferred angle is selected.**

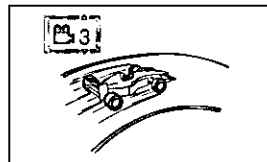

- Press ANGLE or SELECT to clear the display.

### For your reference:

- This function only works for titles having scenes recorded at different angles.



# Reproducing an Advanced Virtual Surround Sound effect [Dolby Digital (AC-3) DVD]



If the player is connected to external speakers, the player can reproduce a virtual surround sound effect which provides sound as if heard from the front speakers located at the horizontally further position or heard from non-existent speakers even when only a 2-channel stereo system is connected [for playback of Dolby Digital DVD software (2ch and above) only].

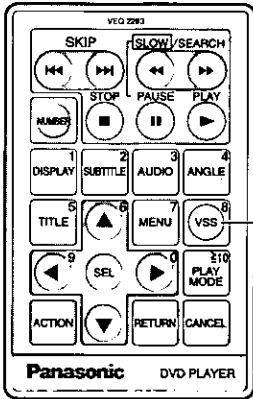

- Press VSS during play.**  
(The On-Screen Menu Icon is displayed and changes as follows each time the button is pressed.)

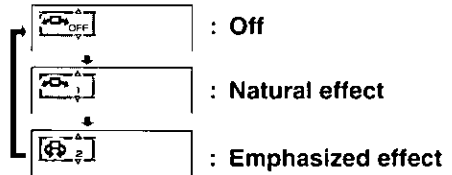

## Notes:

- The stereo speakers in this player are not adequate for reproduction of the virtual surround sound effect. External speakers should be connected to the player.
- When the player is connected to a TV set with surround effect, turn off the surround effect on the TV set to operate the virtual surround sound effect of the player.

## For your reference:

- For optimum effect, it is recommended that the distance between the player and the listening position be about 3 or 4 times the distance between the right and left front speakers.

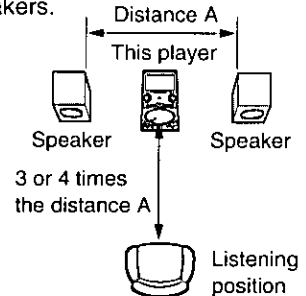

Advanced Operation

## Difference between "VSS 1" and "VSS 2"

	VSS 1	VSS 2
Dolby Digital DVD (2ch)	It sounds as if sound were heard from the front speakers located in a horizontal position.	It emphasizes the audio as if sound were heard from the front speakers located in a further horizontal position.
Dolby Digital DVD (3-5.1ch) (Surround signal recorded)	It sounds as if sound were heard from non-existent surround speakers.	In addition to the effect described on the left, it emphasizes the audio as if sound were heard from the front speakers located in a further horizontal position.

# Changing the initial settings

The initial settings (factory settings) can be changed. For example, the audio soundtrack language can be changed to French by changing the setting at "1 Disc Languages". (The settings will be retained in the memory, until the settings are changed, even after switching to standby mode.)

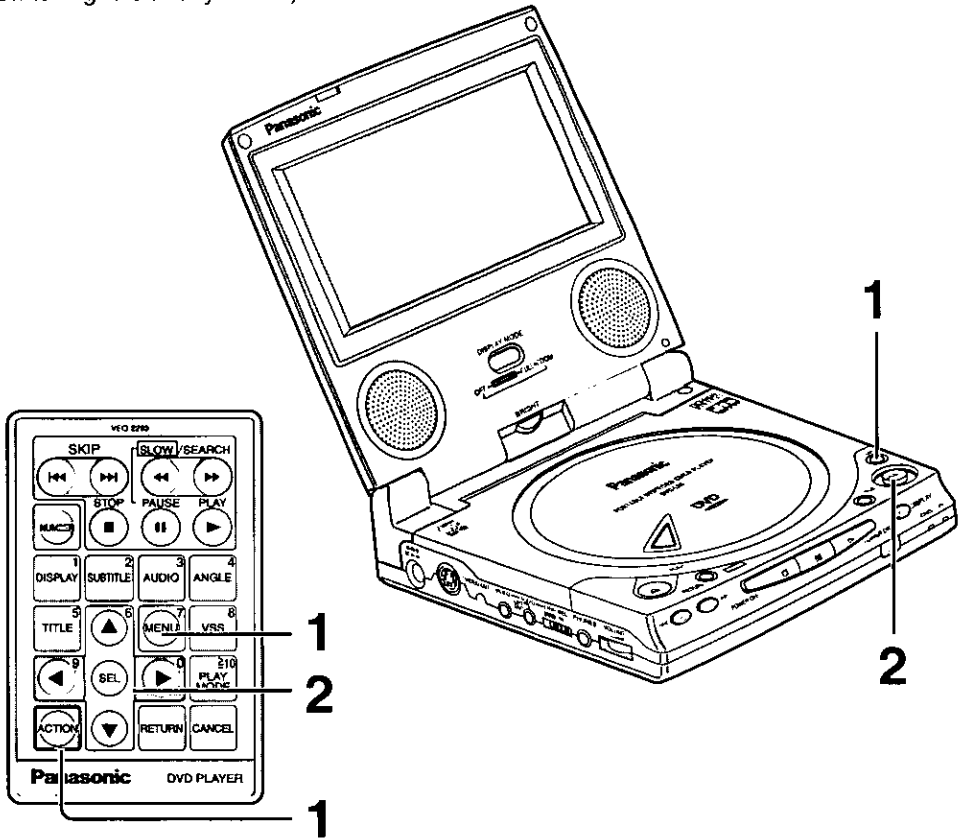

## Notes:

- There are no No. 7 and 8 in the initial settings menu of this player.
- In the case of the remote control, select the item using the cursor buttons instead of the joystick.
- It is not possible to select the item of the initial settings using the NUMBER button. Select the item using the joystick or the cursor buttons.
- When the MENU button is pressed during play, the disc menu will be displayed and if pressed in the stop mode, the initial settings screen will be displayed.

# 1 Press MENU in the stop mode.

- In the case of the remote control, press ACTION or MENU.

(The initial settings screen is displayed.)

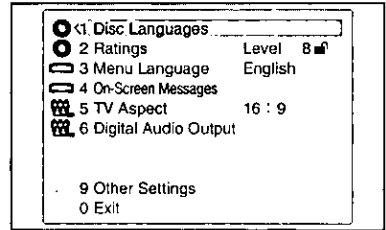

## 1 Disc Languages

This is to select the audio soundtrack language, subtitle language and the language used in title menus or DVD menus which will always be used for every disc to be played back. (If the language selected is not available on the disc, the language designated by each disc will be selected.)

## 2 Ratings

This is to disable the playing of some DVDs which are unsuitable for some audiences, for example, children. Some discs may not be encoded with specific rating level information though its disc jacket says that it is for "adults". For those discs, the age restriction will not work. It is possible to prohibit playback of all DVDs.

## 3 Menu Language

This is to select the language to be used in the On-Screen Display menus which the player will show on the screen.

## 4 On-Screen Messages

This is to select whether "Play", "Still" and other displays will be displayed or not, and the color and position of "Play", "Still" and other displays as well as On-Screen Menu Icons.

## 5 TV Aspect

This is to select the appropriate TV aspect (4:3 or 16:9) that the player is connected to.

## 6 Digital Audio Output

This is to select the digital output to be output from the audio input/output (optical digital audio output) connector of the player.

## 9 Other Settings

This is to adjust other settings such as dynamic range compression, TV mode, etc.

## 0 Exit

This is to finish the initial settings.

# 2 Tilt the joystick (▲, ▼) to select the preferred item and press SELECT.

- When "1 Disc Languages" is selected (See page 52.)
- When "2 Ratings" is selected (See page 54.)
- When "3 Menu Language" is selected (See page 56.)
- When "4 On-Screen Messages" is selected (See page 57.)
- When "5 TV Aspect" is selected (See page 58.)
- When "6 Digital Audio Output" is selected (See page 60.)
- When "9 Other Settings" is selected (See page 63.)

# Changing the initial settings

## When "1 Disc Languages" is selected

See page 51 for steps 1 and 2.

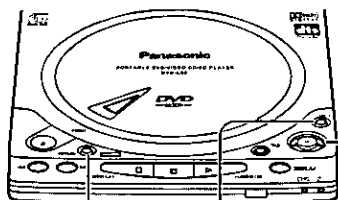

RETURN MENU

3  
•  
4

**3** Tilt the joystick (▲, ▼) to select the preferred item and press **SELECT**.

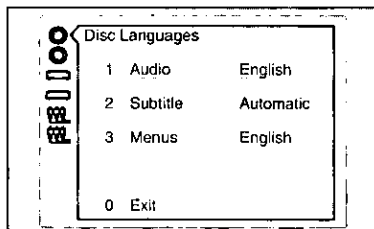

### 1 Audio:

To select the audio soundtrack language.

### 2 Subtitle:

To select the subtitle language.

### 3 Menus:

To select the language used in title menus or DVD menus.

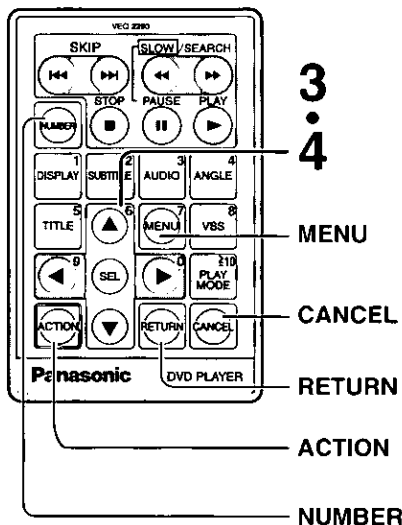

### For your reference:

● In the case of the remote control, the items can be selected using the cursor buttons instead of the joystick.

### □ To return to the previous menu

Press RETURN.

### □ To finish the initial settings

Press MENU at the initial settings screen illustrated in step 1 on page 51. (In the case of the remote control, press ACTION or MENU.)

## 4 Tilt the joystick (▲, ▼) to select the preferred language and press SELECT.

### □ When "1 Audio" is selected

#### 1 English (Factory preset):

English is selected.

#### 2 French/3 Spanish:

Each language is selected.

#### 4 Original:

The original language of each disc will be selected.

#### 5 Other \*\*\*\*:

Another language can be selected. (Input a 4-digit language code referring to the language codes on page 79. Press CANCEL if an incorrect language code is entered.) (See page 21 for information on entering numbers.)

### □ When "2 Subtitle" is selected

#### 1 Automatic (Factory preset):

Subtitle language will automatically be selected in accordance with the audio soundtrack language.

● If the language selected for the "1 Audio" is actually used during playback, the subtitles will not appear.

● If another language is used during playback, the subtitles will appear in the language selected at the setup "1 Audio".

#### 2 English/3 French/4 Spanish:

Each language is selected.

#### 5 Other \*\*\*\*:

Another language can be selected. (Input a 4-digit language code referring to the language codes on page 79. Press CANCEL if an incorrect language code is entered.) (See page 21 for information on entering numbers.)

### □ When "3 Menus" is selected

#### 1 English (Factory preset):

English is selected.

#### 2 French/3 Spanish:

Each language is selected.

#### 4 Other \*\*\*\*:

Another language can be selected. (Input a 4-digit language code referring to the language codes on page 79. Press CANCEL if an incorrect language code is entered.) (See page 21 for information on entering numbers.)

Setting is finished and the screen illustrated in step 3 is displayed.

# Changing the initial settings

## When "2 Ratings" is selected

See page 51 for steps 1 and 2.

When the player is not locked (Level 8)

**3** Tilt the joystick ( $\blacktriangle$ ,  $\blacktriangledown$ ) to select the preferred level and press SELECT.

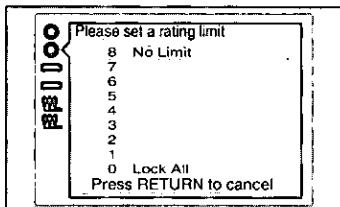

### Level 8 (Factory preset):

All DVDs (for adults/general audiences/children) can be played back.

### Level 7 to 2:

DVDs for general audiences/children can be played back.

(DVDs for adults are prohibited.)

### Level 1:

DVDs for children can be played back.

(DVDs for adults/general audiences are prohibited.)

### Level 0:

Playback of all DVDs is prohibited (e.g. to prohibit playback of DVDs for adults which are not encoded with rating level information).

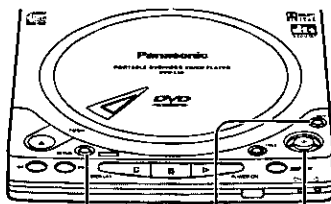

RETURN MENU

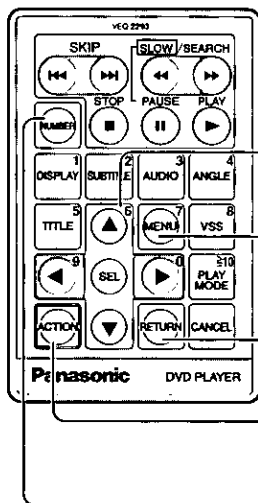

Cursor buttons/  
SELECT

MENU

RETURN

ACTION

NUMBER

**4** When level 7 or lower is selected, input a 4-digit password by using NUMBER and press SELECT.

(See page 21 for information on entering numbers.)

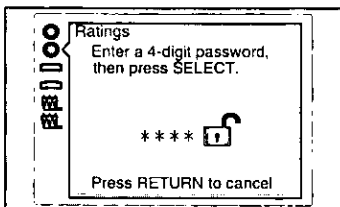

**5** Press SELECT.

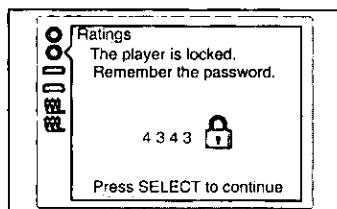

Setting is finished and the initial settings screen illustrated in step 1 on page 51 is displayed.

When the player is locked (Level 0 to 7)

- 3** Input a 4-digit password by using **NUMBER** and press **SELECT**.  
(See page 21 for information on entering numbers.)

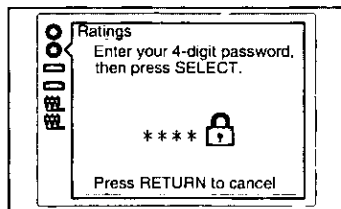

- 4**  **To unlock the player**  
1. Select "1 Unlock Player" using the joystick (▲, ▼) and press SELECT.  
2. Press SELECT again.

**To change the password**

1. Select "2 Change Password" using the joystick (▲, ▼) and press SELECT.  
2. Input the password by using NUMBER and press SELECT.  
3. Press SELECT again.

**To change the rating level**

1. Select "3 Change Level" using the joystick (▲, ▼) and press SELECT.  
2. Select a new level using the joystick (▲, ▼) and press SELECT.

**To unlock the player temporarily**

1. Select "4 Temporary Unlock" using the joystick (▲, ▼) and press SELECT.  
2. Press SELECT again.

•The rating is unlocked only temporarily and will be locked again when the inner cover is opened, or the player is set to the standby mode or turned off.

**To finish setting without changing the rating level**

- Select "0 Exit" using the joystick (▲, ▼) and press SELECT.

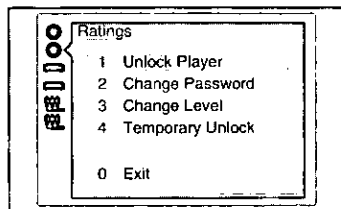

Setting is finished and the initial settings screen illustrated in step 1 on page 51 is displayed.

**Note:**

- When the rating is locked, the settings cannot be changed unless the correct password is entered. Therefore, do not forget your password.

**For your reference:**

- In the case of the remote control, the items can be selected using the cursor buttons instead of the joystick.

**To return to the previous menu**

Press RETURN.

**To finish the initial settings**

Press MENU at the initial settings screen illustrated in step 1 on page 51. (In the case of the remote control, press ACTION or MENU.)

# Changing the initial settings



Joystick/SELECT

RETURN MENU

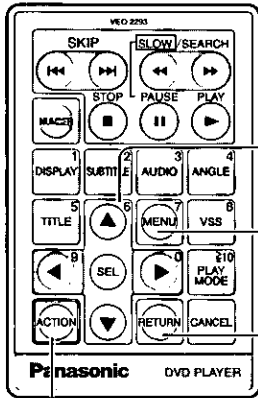

Cursor buttons/  
SELECT

MENU

RETURN

ACTION

When "3 Menu Language"  
is selected

See page 51 for steps 1 and 2.

**3** Tilt the joystick (▲, ▼) to select the preferred language and press SELECT.

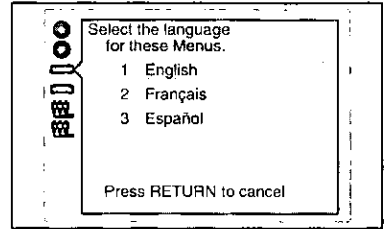

- 1 English (Factory preset):**  
English is selected.
- 2 Français/3 Español:**  
Each language is selected.

Setting is finished and the initial settings screen illustrated in step 1 on page 51 is displayed.

## For your reference:

● In the case of the remote control, the items can be selected using the cursor buttons instead of the joystick.

**To return to the previous menu**

Press RETURN.

**To finish the initial settings**

Press MENU at the initial settings screen illustrated in step 1 on page 51. (In the case of the remote control, press ACTION or MENU.)



## When "4 On-Screen Messages" is selected

See page 51 for steps 1 and 2.

- 3** Tilt the joystick (▲, ▼) to select the preferred item and press **SELECT**.

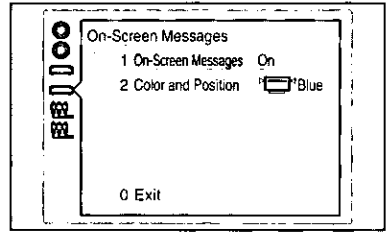

**1 On-Screen Messages:**

To select whether "Play", "Still" and other displays are displayed or not.

**2 Color and Position:**

To select the color (Blue/Violet/Green) and position (above/slightly below) of "Play", "Still" and other displays as well as On-Screen Menu Icons.

- 4** Tilt the joystick (▲, ▼) to select the preferred setting and press **SELECT**.

When "1 On-Screen Messages" is selected

**1 On (Factory preset):**

"Play", "Still" and other displays will always appear on the screen.

**2 Off:**

"Play", "Still" and other displays will not appear on the screen.

When "2 Color and Position" is selected

The colors and positions are set as follows.

1  Blue      4  Blue

(Factory preset)

2  Violet      5  Violet

3  Green      6  Green

Setting is finished and the screen illustrated in step 3 is displayed.

**For your reference:**

- When  is selected, "Play", "Still" and other displays as well as On-Screen Menu Icons will be displayed at a little lower position than the factory setting. It is recommended to choose this setting in such a case that the screen is only partially displayed.

# Changing the initial settings

When "5 TV Aspect" is selected

See page 51 for steps 1 and 2.

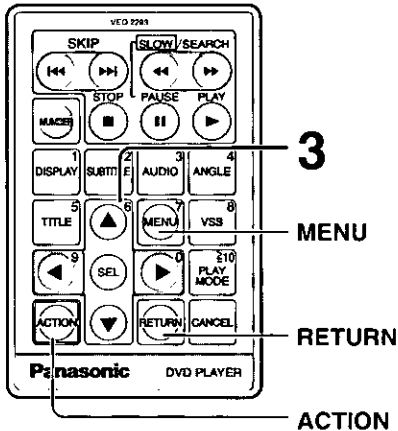
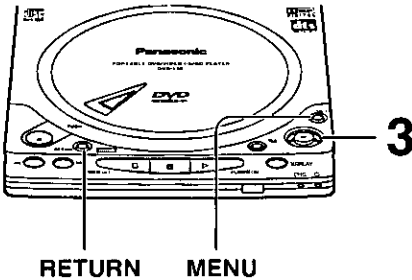

**3** Tilt the joystick (▲, ▼) to select the TV aspect and press SELECT.

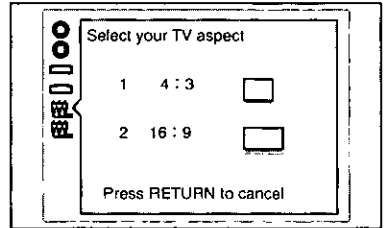

**1 4:3:**

Select when a conventional TV set is connected.

**2 16:9 (Factory preset):**

Select when a wide-screen TV set is connected or when the player's LCD is used.

Setting is finished and the initial settings screen illustrated in step 1 on page 51 is displayed.

## Note:

- The setting for "5 TV Aspect" also affects the LCD screen of the player. (See page 59.) Select "2 16:9" when using the player's LCD without connecting a TV set.

## For your reference:

- In the case of the remote control, the items can be selected using the cursor buttons instead of the joystick.

**To return to the previous menu**









Press RETURN.

**To finish the initial settings**

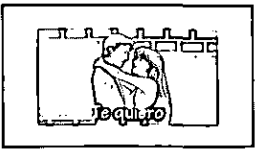
Press MENU at the initial settings screen illustrated in step 1 on page 51. (In the case of the remote control, press ACTION or MENU.)

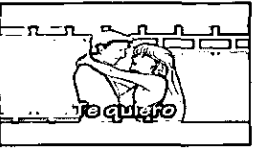
## Display modes of the LCD

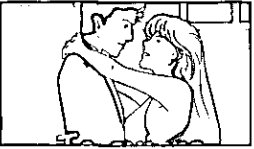
Each time DISPLAY MODE is pressed, the display mode of the LCD changes as follows:

Type of software Mode	Software for wide-screen	Software (4:3)	Software (4:3, Letterbox)
<b>NORMAL</b>	<p>Full screen</p> 	<p>Screen with black bands on the right and left</p> 	<p>Letterbox</p> 
<b>FULL</b>	<p>Full screen</p> 	<p>The above screen is horizontally enlarged.</p> 	<p>The above screen is horizontally enlarged (with black bands at top and bottom).</p> 
<b>ZOOM</b>	<p>Top and bottom edges are cut off.</p> 	<p>Top and bottom edges of the above full screen are cut off.</p> 	<p>Full screen</p> 
<b>OFF</b>	Off	Off	Off

### Note:

- It is recommended to set the display mode to "OFF" to conserve power or to prevent battery consumption when an external TV set is connected.

### For your reference:

- Turning the LCD display screen to OFF while playing music CDs reduces power consumption. This measure also conserves battery power when operating off the battery pack. (Under these conditions, the battery pack provides 4.5 hours of continuous playback when playing music CDs.)
- Horizontal lines may appear on the screen when the display mode is set to "ZOOM": this is normal.

# Changing the initial settings

## When "6 Digital Audio Output" is selected

See page 51 for steps 1 and 2.

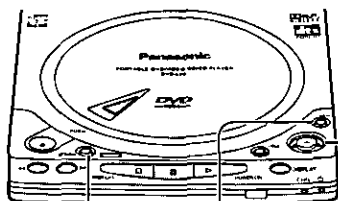

RETURN MENU

3  
4

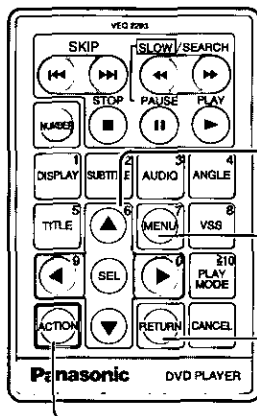

MENU

RETURN

ACTION

- 3** Tilt the joystick (**▲**, **▼**) to select the preferred item and press **SELECT**.

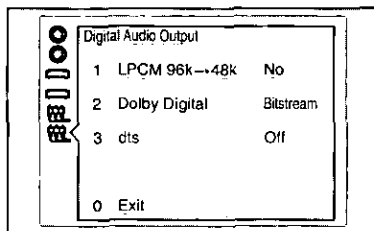

### 1 LPCM 96k→48k:

To select whether digital audio converted to 48 kHz/16 bit is output from the audio input/output (optical digital audio output) connector or no digital audio is output during playback of the DVD recorded in Linear PCM of 96 kHz.

(In the case of the DVD recorded in Linear PCM of 48 kHz, digital audio converted to 48 kHz/16 bit is output irrespective of the setting.)

### 2 Dolby Digital:

To select the signal format (Bitstream or PCM) to be output from the audio input/output (optical digital audio output) connector during playback of the DVD recorded in Dolby Digital (AC-3).

### 3 dts:

To select whether dts bitstream is output from the audio input/output (optical digital audio output) connector or no digital audio is output during playback of the DVD recorded in dts.

## **4** Tilt the joystick (**▲**, **▼**) to select the preferred setting and press **SELECT**.

### When "1 LPCM 96k→48k" is selected

#### **1 No (Factory preset):**

- Digital audio of 48 kHz/16 bit is output during playback of the DVD recorded in Linear PCM of 48 kHz.
- No digital audio is output during playback of the DVD recorded in Linear PCM of 96 kHz.
- However, audio will be output using the original audio recording system in case of the DVD which has not been copyright-protected.

#### **2 Yes:**

During playback of the DVD recorded in Linear PCM of 48 kHz or 96 kHz, digital audio converted to 48 kHz/16 bit is output.  
(Digital output of PCM audio is restricted to 48 kHz/16 bit or below for copyright protection.)

### When "2 Dolby Digital" is selected

#### **1 Bitstream (Factory preset):**

Dolby Digital (AC-3) bitstream (1ch–5.1ch) is output during playback of the DVD recorded in the Dolby Digital (AC-3).  
Select this setting when the player is connected to the Dolby digital (AC-3) decoder.

#### **2 PCM:**

Digital audio converted to PCM (2ch) of 48 kHz/16 bit is output during playback of the DVD recorded in the Dolby Digital (AC-3).

### When "3 dts" is selected

#### **1 Off (Factory preset):**

No digital audio is output during playback of the DVD recorded in dts.

#### **2 Bitstream:**

dts bitstream is output during playback of the DVD recorded in dts. Select this setting when the player is connected to the dts decoder.

Setting is finished and the screen illustrated in step 3 is displayed.

### **For your reference:**

- See page 62 for the recommended setting of "6 Digital Audio Output".
- In the case of the remote control, the items can be selected using the cursor buttons instead of the joystick.

### **To return to the previous menu**

Press RETURN.

### **To finish the initial settings**

Press MENU at the initial settings screen illustrated in step 1 on page 51.  
(In the case of the remote control, press ACTION or MENU.)

# Changing the initial settings

## Recommended setting of "6 Digital Audio Output"

Make settings as shown in table below, depending on the kind of equipment that is connected to the audio input/output (optical digital audio output) connector, using the optical digital audio cable.

Type of equipment to be connected	Recommended setting		
	1 LPCM 96k→48k	2 Dolby Digital	3 dts
No equipment is connected	<u>1 No</u>	<u>1 Bitstream</u>	<u>1 Off</u>
AV amplifier (with digital audio input connector) without Dolby Digital/dts decoder	2 Yes* <sup>1</sup>	2 PCM* <sup>2</sup>	<u>1 Off</u> * <sup>2</sup>
Dolby Digital (AC-3) decoder (See page 69.)	2 Yes* <sup>1</sup>	<u>1 Bitstream</u>	<u>1 Off</u>
Dolby Digital (AC-3) decoder/dts decoder (See page 69.)	2 Yes* <sup>1</sup>	<u>1 Bitstream</u>	2 Bitstream

• Underlined items are a factory preset.

\*<sup>1</sup> In the case of a DVD recorded in Linear PCM of 96 kHz, audio output from the player's audio input/output (optical digital audio output) connector is converted to 48 kHz if the player is connected using the optical digital audio cable.

To enjoy high quality sound at 96 kHz, connect the amplifier or decoder to the audio input/output (optical digital audio output) connector using the audio/video cable (supplied), not the optical digital audio cable. (Select "1 No" at the "1 LPCM 96k→48k".)

\*<sup>2</sup> When connecting an amplifier (with an optical digital input connector) which does not contain the Dolby Digital (AC-3) or dts decoder, be sure to select "2 PCM" at the "2 Dolby Digital" and "1 Off" at the "3 dts". If "Bitstream" is selected, any attempt to play DVDs may cause such a high level of noise that it may be harmful to your ears and damage your speakers.

## When "9 Other Settings" is selected

See page 51 for steps 1 and 2.

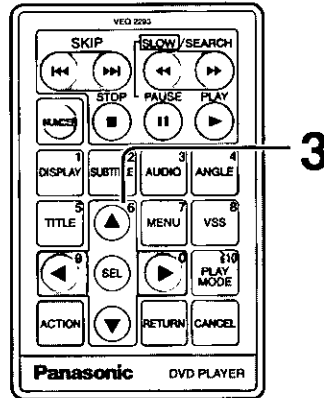

**3** Tilt the joystick (▲, ▼) to select the preferred item and press **SELECT**.

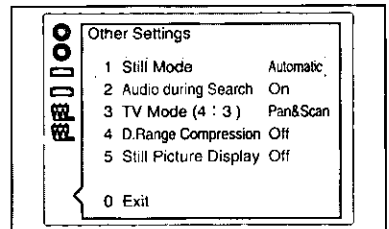

### 1 Still Mode:

To select "Field still" or "Frame still" prevents jittering and improves the video quality of small text or fine patterns in the still picture mode.

### 2 Audio during Search:

To select whether audio is heard during search at the initial scan speed or not.

### 3 TV Mode (4:3):

To select whether the video material for a wide-screen will be played back in the Pan & Scan style or in the Letterbox style on a conventional size TV.

### 4 D. (Dynamic) Range Compression:

To select the dynamic range during playback.

### 5 Still Picture Display:

To select whether the picture type (I/P/B) is displayed on the screen in the still picture mode or not.

(Continued on the next page)

# Changing the initial settings

## When "9 Other Settings" is selected

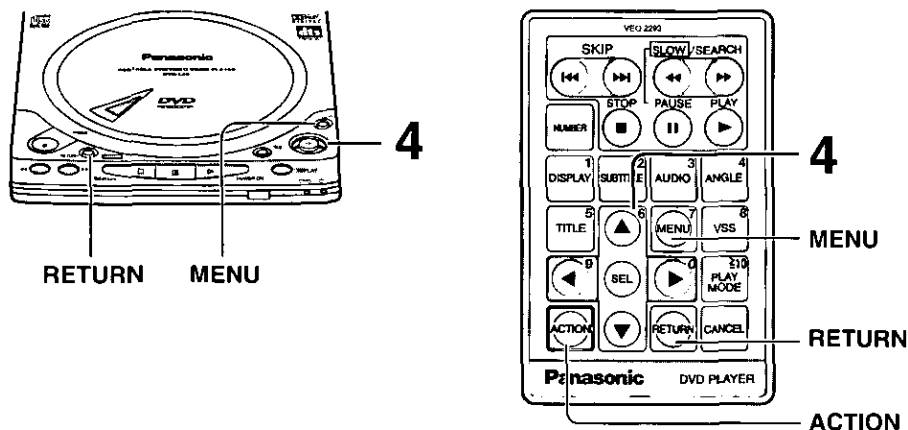

## 4 Tilt the joystick ( $\blacktriangle$ , $\blacktriangledown$ ) to select the preferred setting and press SELECT.

### □ When "1 Still Mode" is selected

#### 1 Automatic (Factory preset):

"Field still" and "Frame still" are automatically selected in the still picture mode.

#### 2 Field:

"Field still" is always selected. Select this setting when jittering occurs in the pictures even when "1 Automatic" is selected.

#### 3 Frame:

"Frame still" is always selected. Select this setting when small text or fine patterns cannot be seen clearly even when "1 Automatic" is selected.

### □ When "2 Audio during Search" is selected

#### 1 On (Factory preset):

Audio will be heard during search at the initial scan speed.

(When audio during search at the initial scan speed is not desired, select "Off".)

#### 2 Off:

Select this setting when audio during search at the initial scan speed is not desired.



□ **When “3 TV Mode (4:3)” is selected**

**1 Pan & Scan (Factory preset):**

The video material for a wide-screen will be played back in the Pan & Scan style on a conventional size TV. Video material not formatted in the Pan & Scan style will be played back in the letterbox style.

**2 Letterbox:**

The video material for a wide-screen will be played back in the letterbox style on a conventional size TV.

□ **When “4 D. (Dynamic) Range Compression” is selected**

**1 Off (Factory preset):**

Normal audio range is selected.

**2 On:**

Select this setting to enjoy listening to dynamic sound even on a low volume. Dynamic range is the difference in volume between the quietest and loudest sounds heard. Dynamic Compression limits level for listening at low volume. This is useful late at night, for example.

[This function only works with Dolby Digital (AC-3) DVD.]

□ **When “5 Still Picture Display” is selected**

**1 Off (Factory preset):**

The picture type (I/P/B) will not be displayed on the screen in the still picture mode.

**2 On:**

The picture type (I/P/B) will be displayed on the screen in the still picture mode.

---

Setting is finished and the screen illustrated in step 3 is displayed.

---

**For your reference:**

- In the case of the remote control, the items can be selected using the cursor buttons instead of the joystick.
- When the “2 On” is selected at the “5 Still Picture Display”, the following screen is displayed in the still picture mode;

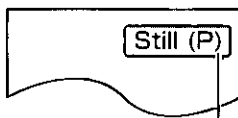

Example: in the case of the P-Picture

□ **To return to the previous menu**

Press RETURN.

□ **To finish the initial settings**

Press MENU at the initial settings screen illustrated in step 1 on page 51. (In the case of the remote control, press ACTION or MENU.)

# Connection

- Ensure that this player and other equipment to be connected are set to the standby mode or off, and disconnect the AC cords, before commencing connection.
- Do not block ventilation holes of any of the equipment and arrange them so that air can circulate freely.
- Read through the instructions before connecting other equipment.
- Ensure that you observe the color coding when connecting audio and video cables.
- During DVD play, the TV volume may be at a lower level than during TV broadcasts, etc. If this is the case, adjust the volume to the desired level.
- Select the appropriate screen type at the initial setting "5 TV Aspect" according to your TV set (4:3/16:9). (See page 58.)

## Connecting to a stereo TV set

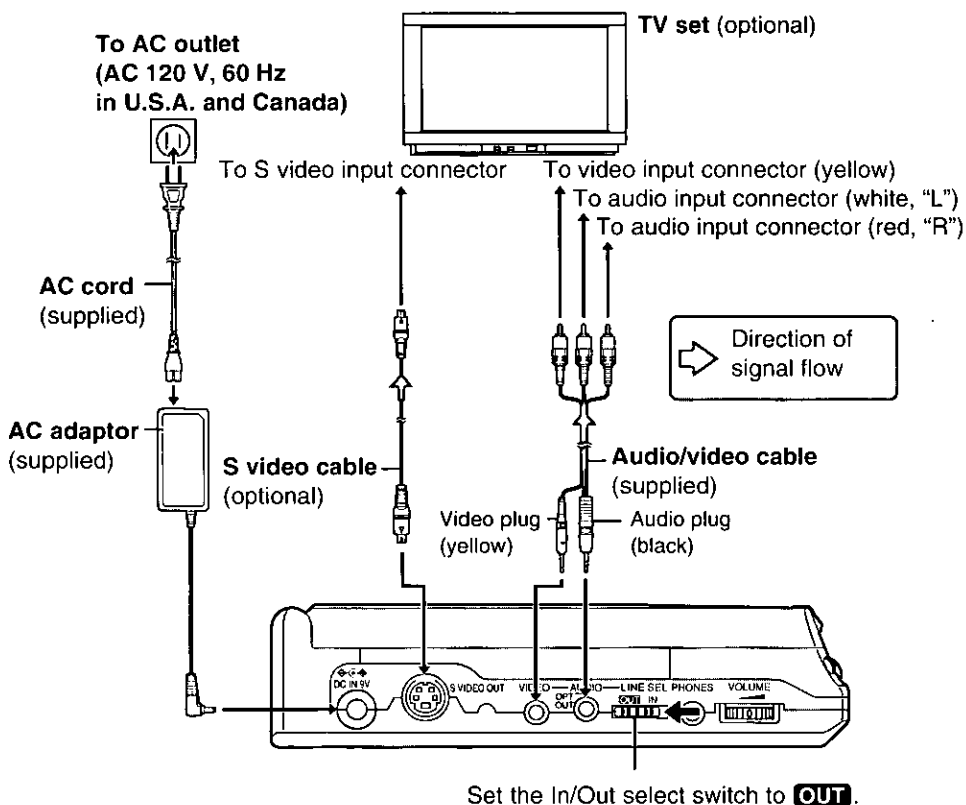

### S video output connector:

Use the S video cable (optional) when connecting the player to a TV set equipped with an S video input connector for the best picture clarity possible. When using the S video cable, the yellow composite video plug need not be connected to the TV.

## Connecting to audio equipment

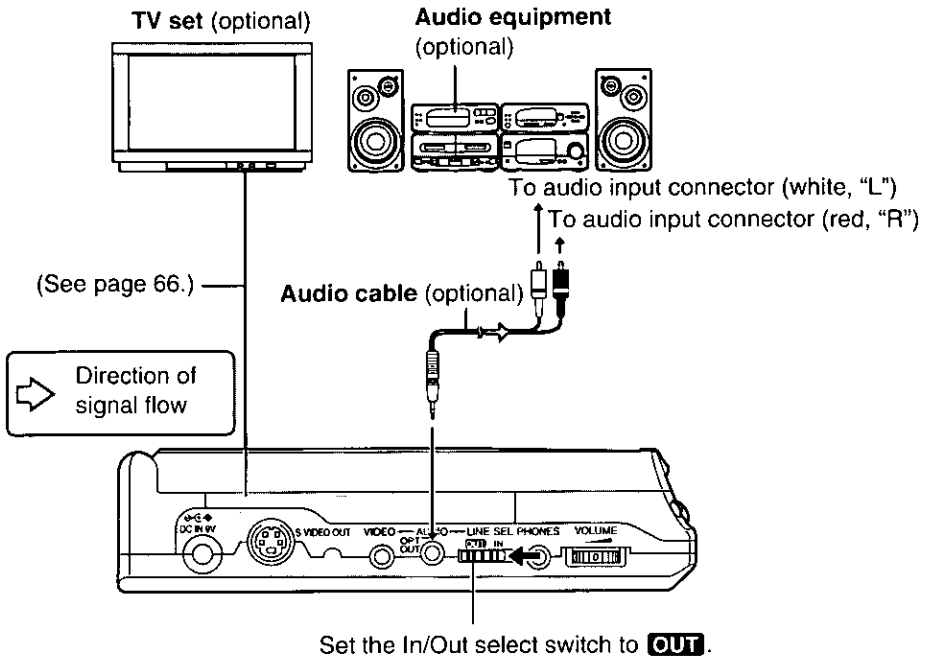

### Connect Your Portable DVD/Video CD/CD Player Directly To Your TV Set.

If the player is connected to the TV through a video cassette recorder, the picture may not be played back normally with some DVDs. So we strongly recommend you not to connect the player to your video cassette recorder when setting up your home entertainment system.



**Do not place the player on amplifiers or other equipment which may become hot.**

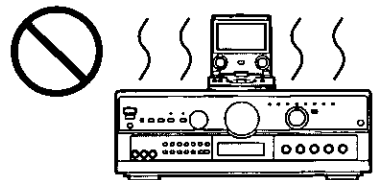

# Connection

## Enjoying digital audio output from the audio input/output (optical digital audio output) connector

- Concerning the audio output from the player's audio input/output (optical digital audio output) connector

Disc	Sound recording format	Optical digital audio output from connector
DVD	Dolby Digital (AC-3)	●Dolby Digital (AC-3) bitstream (1–5.1ch) ●PCM (48 kHz/16 bit) (2ch) *1 *2
	Linear PCM (48/96 kHz 16/20/24 bit)	●Linear PCM (2ch) (48 kHz sampling/16 bit only) ●No output*2
	dts	●dts bitstream (1–5.1ch) ●No output *2
Video CD	MPEG 1	PCM (44.1 kHz sampling) *1
CD	Linear PCM	Linear PCM (44.1 kHz sampling)

\*1 Compressed sound converted to PCM will be output.

\*2 The type of audio output from the connector can be selected by "6 Digital Audio Output" of the initial settings.

### Note:

- Some dts decoders which do not support DVD-dts interface may not work properly with the portable DVD/Video CD/CD player.

### For your reference:

- If you have a Dolby Pro Logic Surround decoder, you will obtain the full benefit of Pro Logic from the same DVD movies that provide full 5.1-channel Dolby Digital soundtracks, as well as from titles with the Dolby Surround mark.

### Caution for the audio input/output (optical digital audio output) connector:

- When connecting an amplifier (with an optical digital input connector) which does not contain the Dolby Digital (AC-3) or dts decoder, be sure to select "PCM" at "2 Dolby Digital" and "Off" at "3 dts" of the initial setting "6 Digital Audio Output". (See page 60.)
- Otherwise any attempt to play DVDs may cause such a high level of noise that it may be harmful to your ears and damage your speakers.
- Video CDs and CDs can be played as they would normally be played.

## Connecting to a decoder with Dolby Digital (AC-3) or dts (digital theater systems) processing

When DVDs recorded in Dolby Digital or dts are played, Dolby Digital bitstream or dts bitstream is output from the player's audio input/output (optical digital audio output) connector. When the player is connected to a Dolby Digital decoder or dts decoder using the optical digital audio cable (optional), you can enjoy theater-quality audio in your home.

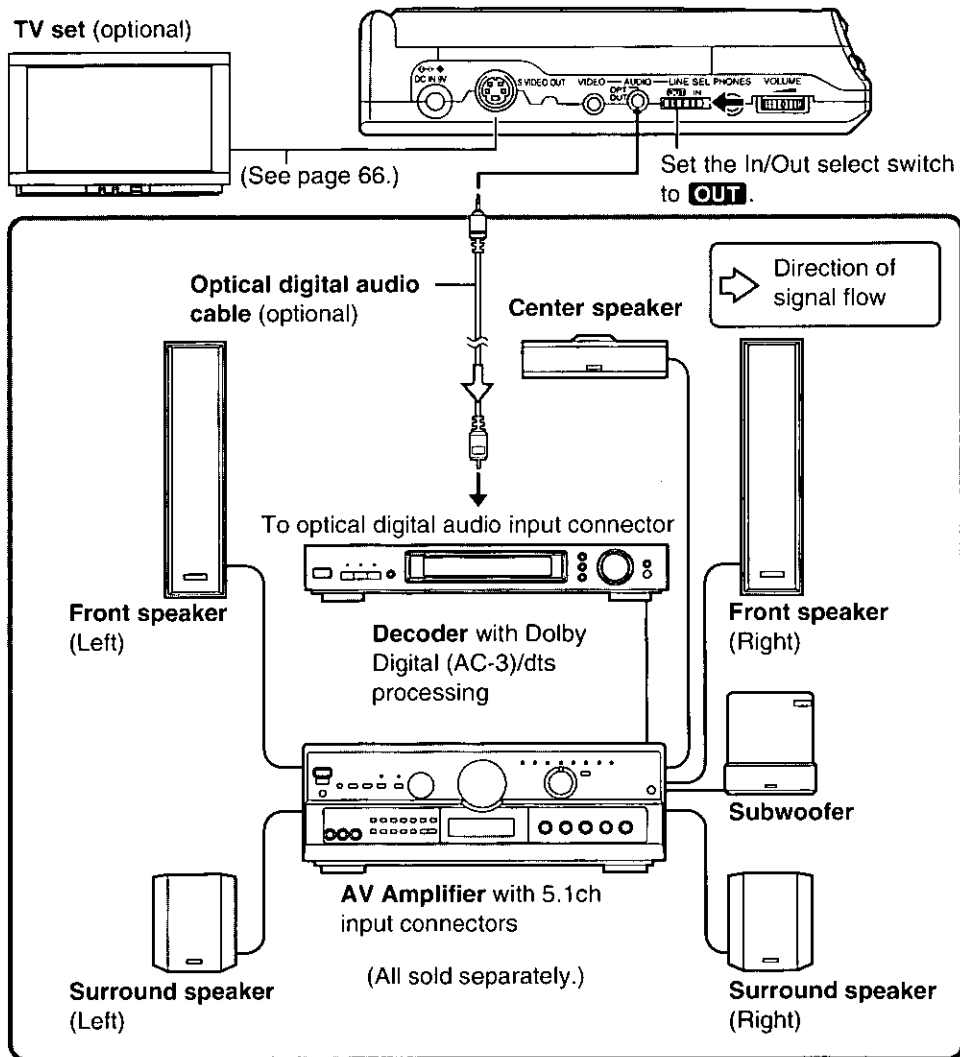

For Your Reference

# Connection

## Playback from a video camera

The portable DVD/Video CD/CD player's LCD screen and stereo speakers can be used to enjoy playback from a video camera.

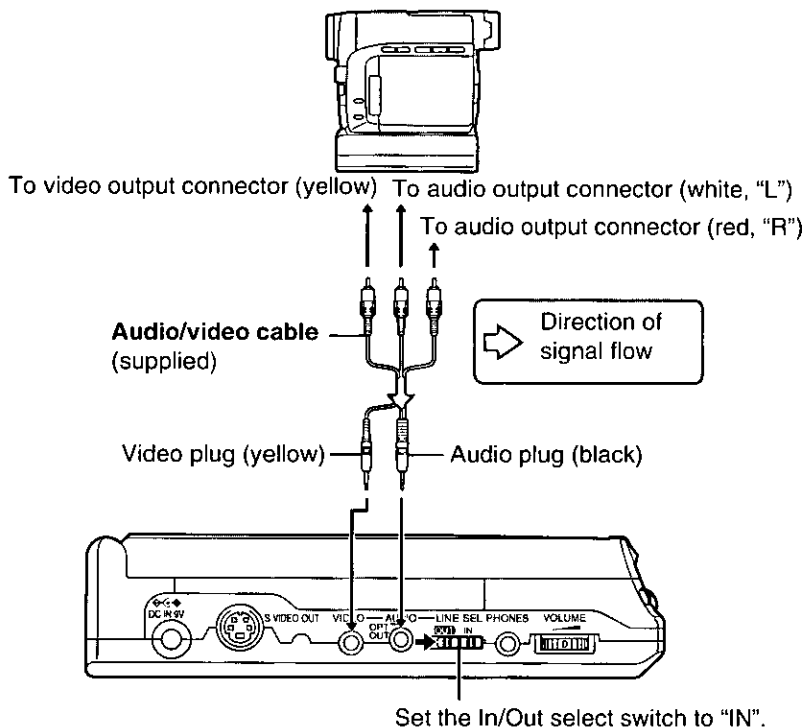

## Connecting headphones (optional)

- Headphones with a  $\frac{1}{8}$ " (3.5 mm) stereo plug can be connected.
- Turn down the volume level before connection, and then adjust the level.

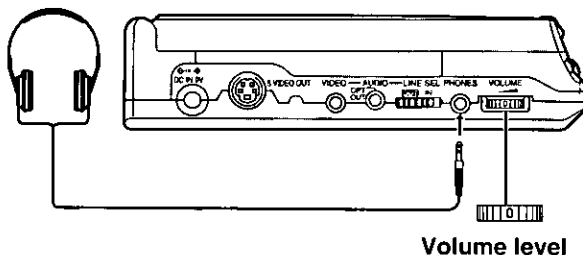

### Caution:

- Avoid listening to the sound at levels which may be harmful to your ears.

### For your reference:

- When the headphones are connected, no sound will be output from the player's stereo speakers.

# Troubleshooting

Before requesting service for this player, check the chart below for a possible cause of the problem you are experiencing. Some simple checks or a minor adjustment on your part may eliminate the problem and restore proper operation.

If you are in doubt about some of the check points, or if the remedies indicated in the chart do not solve the problem, consult your dealer for instructions in U.S.A. or refer to the dealer from whom you have made your purchase to locate a convenient servicentre in Canada.

[In U.S.A. consult PASC Authorized Servicenters for detailed instructions, call 1-888-PANA-DVD (1-888-726-2383) or visit our home address [www.panasonic.com/dvd](http://www.panasonic.com/dvd) for the address of an authorized factory servicenter. In Canada contact our Customer Care Centre at 905-624-5505 or the CCC web site at [www.panasonic.ca](http://www.panasonic.ca)]

## □ Regarding power

Symptom	Remedy	Reference page
<b>No power.</b>	<ul style="list-style-type: none"> <li>● Ensure that the player is properly connected to the AC adaptor or the battery pack.</li> <li>● The HOLD switch on the player's right-side panel is set to the "HOLD" position. Turn off the HOLD function.</li> <li>● It is impossible to turn on the player with the remote control unit if the player is powered by the battery pack.</li> </ul>	<p>24, 25</p> <p>19</p> <p>—</p>
<b>The player is automatically set to the standby mode or the power turns itself off.</b>	<ul style="list-style-type: none"> <li>● To conserve power or prevent battery consumption, the player is automatically set to the standby mode after approx. 15 minutes have elapsed in the stop mode when the player is powered by the AC adaptor, or the power turns itself off after approx. 5 minutes have elapsed when the player is powered by the battery pack (<b>Auto power-off function</b>). Turn the power back to ON.</li> </ul>	—

## □ Regarding battery pack

Symptom	Remedy	Reference page
<b>Charging is impossible.</b>	<ul style="list-style-type: none"> <li>● Set the player to the standby mode, then start charging. (The battery pack cannot be charged while the player is ON.)</li> <li>● If the battery pack is too warm, charging may take longer than usual or it may not be possible at all. Wait for the battery pack to cool off before charging it.</li> </ul>	<p>26</p> <p>26</p>
<b>The CHARGE indicator does not light.</b>	<ul style="list-style-type: none"> <li>● Detach the battery pack, and then attach it again. Alternatively, attach the battery pack to the player, use it for 10 to 20 minutes or so and then charge the battery pack again.</li> </ul>	25

# Troubleshooting

## □ Regarding battery pack

Symptom	Remedy	Reference page
The player cannot be operated using the battery pack.	<ul style="list-style-type: none"> <li>● If the battery pack overheats, its protective circuit may be activated, making it no longer possible to use the battery pack.</li> </ul>	—

## □ Playback or other operation is impossible.

Symptom	Remedy	Reference page
No menu play of Video CD.	<ul style="list-style-type: none"> <li>● This function works only with Video CDs with playback control.</li> </ul>	80
No key operation (by the player and/or the remote control unit) is effective.	<ul style="list-style-type: none"> <li>● Some operations may be prohibited by the disc.</li> <li>● The HOLD switch on the player's right-side panel is set to the "HOLD" position. Turn off the HOLD function.</li> </ul>	— 19
	<ul style="list-style-type: none"> <li>● Press and hold STOP (□) to set the player to the standby mode and then back to ON. Alternatively, press and hold STOP (□) to set the player to the standby mode, disconnect the AC adaptor, and then re-connect it. (The player may not be operating properly due to lightning, static electricity or some other external factor.)</li> </ul>	—
<ul style="list-style-type: none"> <li>● Play fails to start even when PLAY (▷) is pressed.</li> <li>● Play starts but then stops immediately.</li> </ul>	<ul style="list-style-type: none"> <li>● Condensation has formed: wait about 1 to 2 hours to allow the player to dry out.</li> </ul>	—
	<ul style="list-style-type: none"> <li>● This player cannot play disc other than DVD, Video CD and CD.</li> </ul>	10
	<ul style="list-style-type: none"> <li>● The disc may be dirty and may require cleaning.</li> <li>● Ensure that the disc is installed with the label side to be played facing upwards.</li> </ul>	15 28
No operations can be performed with the remote control unit.	<ul style="list-style-type: none"> <li>● Check if the button-type battery is installed with the correct polarities (⊕ and ⊖).</li> </ul>	22
	<ul style="list-style-type: none"> <li>● The button-type battery is depleted: replace it with a new one.</li> </ul>	22
	<ul style="list-style-type: none"> <li>● Point the remote control unit at the remote control signal sensor and operate.</li> </ul>	23
	<ul style="list-style-type: none"> <li>● Operate the remote control unit at a distance of not more than 23 feet (7 meters) from the remote control signal sensor.</li> </ul>	23
	<ul style="list-style-type: none"> <li>● Remove the obstacles between the remote control unit and remote control signal sensor.</li> </ul>	23
	<ul style="list-style-type: none"> <li>● The HOLD switch on the player's right-side panel is set to the "HOLD" position. Turn off the HOLD function.</li> </ul>	19



**□ Playback or other operation is impossible.**

Symptom	Remedy	Reference page
<b>A-B repeat play does not work.</b>	<ul style="list-style-type: none"> <li>● A-B repeat play works only within a title (DVD) or a track (Video CD/CD). (If the title/track is completed before end location B is specified, the end point of the title/track serves as end location B.)</li> </ul>	—
<b>None of the initial settings can be changed.</b>	<ul style="list-style-type: none"> <li>● After the player is set to the "Lock All" setting in "2 Ratings", none of the initial settings, including "2 Ratings", can be changed if the DVD disc is left inside the player. In this case, remove the disc, and unlock the player.</li> </ul>	55

**□ No sound**

Symptom	Remedy	Reference page
<b>No sound from the external speakers of the stereo system or other equipment.</b>	<ul style="list-style-type: none"> <li>● Ensure that the player is connected properly.</li> </ul>	66-69
	<ul style="list-style-type: none"> <li>● Ensure that the input settings for the TV and stereo system are correct.</li> </ul>	—
	<ul style="list-style-type: none"> <li>● The In/Out select switch on the player's left-side panel is set to "IN". Set it to "OUT".</li> </ul>	18
<b>No sound from the stereo speakers.</b>	<ul style="list-style-type: none"> <li>● When the outer cover of the player is closed, sound from the stereo speakers automatically turns off to conserve power and battery consumption.</li> </ul>	—
	<ul style="list-style-type: none"> <li>● The volume level is set to "0" (No sound).</li> </ul>	18

**□ No image or distorted image**

Symptom	Remedy	Reference page
<b>No image on the LCD screen.</b>	<ul style="list-style-type: none"> <li>● Ensure that the In/Out select switch on the player's left-side panel is set properly.                             <ul style="list-style-type: none"> <li>—To display the image from an external device such as a video camera, set it to "IN".</li> <li>—To play discs, set it to "OUT".</li> </ul> </li> </ul>	18
	<ul style="list-style-type: none"> <li>● The display mode of the LCD is set to "OFF". Select a mode other than "OFF".</li> </ul>	59
<b>No image on the TV monitor.</b>	<ul style="list-style-type: none"> <li>● Ensure that the player is connected properly.</li> </ul>	66
	<ul style="list-style-type: none"> <li>● Ensure that the input setting for the TV is "Video".</li> </ul>	—
	<ul style="list-style-type: none"> <li>● The In/Out select switch on the player's left-side panel is set to "IN". Set it to "OUT".</li> </ul>	18

# Troubleshooting

## □ No image or distorted image

Symptom	Remedy	Reference page
No image is displayed on the LCD screen when a video camera or other device is connected to the player.	<ul style="list-style-type: none"> <li>• Ensure that the player is connected properly.</li> <li>• Ensure that the video camera is turned on.</li> <li>• The In/Out select switch on the player's left-side panel is set to "OUT". Set it to "IN".</li> <li>• The display mode of the LCD is set to "OFF". Select a mode other than "OFF".</li> </ul>	<p>70</p> <p>—</p> <p>18</p> <p>59</p>
The LCD screen is dark.	<ul style="list-style-type: none"> <li>• Adjust the brightness of the LCD.</li> </ul>	16
Picture is distorted during rapid advance or rapid reverse.	<ul style="list-style-type: none"> <li>• The picture will be somewhat distorted at times; this is normal.</li> </ul>	—
No 4:3 (16:9) picture on the TV screen.	<ul style="list-style-type: none"> <li>• Choose the correct setup "5 TV Aspect" item which matches the TV set used.</li> </ul>	58
On-Screen Menu Icons not displayed or only partially displayed on the screen.	<ul style="list-style-type: none"> <li>• Change the position of the On-Screen Menu Icons using "2 Color and Position" in "4 On-Screen Messages" of the initial settings.</li> </ul>	57

## □ DVD-specific functions (Title, Audio soundtrack, Subtitle)

Symptom	Remedy	Reference page
Play does not start even when title is selected.	<ul style="list-style-type: none"> <li>• Confirm the "2 Ratings" setting.</li> </ul>	54
Alternative audio soundtrack (or subtitle) languages fail to be selected.	<ul style="list-style-type: none"> <li>• An alternative language is not selected with discs which do not contain more than one language.</li> <li>• In the case of some discs, the alternative language cannot be selected by operating the AUDIO or SUBTITLE button. Try selecting it from the DVD menu if one is available.</li> </ul>	<p>—</p> <p>43</p>
Audio soundtrack and/or subtitle language is not the one selected at the initial settings.	<ul style="list-style-type: none"> <li>• If the audio soundtrack and/or subtitle language does not exist on the disc, the language selected at the initial settings will not be seen/heard.</li> </ul>	—

□ DVD-specific functions  
(Subtitle, Angle, VSS, Menu Language, Ratings)

Symptom	Remedy	Reference page
No subtitles.	<ul style="list-style-type: none"> <li>● Subtitles appear only with discs which contain them.</li> <li>● Subtitles are cleared from the screen. Perform the steps on page 47 to display the subtitles.</li> <li>● Some subtitles recorded around point A or B may fail to appear during A-B repeat play.</li> <li>● Some subtitles recorded around the marker may fail to appear.</li> </ul>	— 47 — —
The subtitle language does not change to the selected one immediately.	<ul style="list-style-type: none"> <li>● In some cases, the subtitle language is not changed to the selected one immediately.</li> </ul>	—
Angle cannot be changed.	<ul style="list-style-type: none"> <li>● This function is dependent on software availability. Even if a disc has a number of angles recorded, these angles may be recorded for specific scenes only.</li> </ul>	—
VSS function does not work.	<ul style="list-style-type: none"> <li>● This function does not work with DVD Karaoke discs.</li> <li>● This function may not work with some Dolby Digital 2.1ch or 3.1ch DVDs. Additionally, this effect may not work properly with some Dolby Digital DVDs other than 2.1ch or 3.1ch, depending on the software.</li> </ul>	— —
The menu is not displayed in the preferred language.	<ul style="list-style-type: none"> <li>● Confirm the setting at the “3 Menu” of “1 Disc Languages”.</li> </ul>	52
The password for rating level has been forgotten. ● Reset all the settings to Factory Preset.	<ul style="list-style-type: none"> <li>● While the player is in the stop mode, press and hold the player’s SKIP/SEARCH (◀◀) button and the PAUSE (⏏) button down simultaneously and then press and hold PLAY (▶) for longer than 3 seconds (until “Initialized” disappears from the screen). The lock will be released and all initial settings will return to the default values.</li> </ul>	—

# Troubleshooting

## □ Others

Symptom	Remedy	Reference page
During playback of a CD, the On-Screen Menu Icons do not appear automatically.	●If play is stopped after the On-Screen Menu Icons have been cleared from the screen, the icons will not appear automatically when play is resumed.	36
No On-Screen Display.	●The "Off" setting is selected for "1 On-Screen Messages" in "4 On-Screen Messages": select "On".	57
Shock-proof function (for preventing jumps in the sound during CD play) fails to work.	●Shock-proof function does not work when the optical digital audio cable is connected to the audio input/output (optical digital audio output) connector of the player's left-side panel.	—
If you cannot solve your problem.	● <b>U.S.A.:</b> For customer service, please contact the Panasonic Customer Call Center at 1-888-PANA-DVD (1-888-726-2383) or visit our home address <a href="http://www.panasonic.com/dvd">www.panasonic.com/dvd</a> for further assistance. ● <b>Canada:</b> To contact the nearest authorized Panasonic service centre, contact our Customer Care Centre at 905-624-5505, or the CCC web site at <a href="http://www.panasonic.ca">www.panasonic.ca</a>	—

## Self-diagnosis display function

When an error or trouble is detected during operation, a service number appears on the screen.

When a service number appears, check out the details given below.

Service number	Player status	Remedy
U11	●Disc is dirty.	●Wipe the disc clean.
H□□ □□ stands for a number.	●Trouble is likely to have occurred. The number following "H" differs depending on the status of the player.	●Press and hold STOP (□) to set the player to the standby mode and then back to ON. Alternatively, press and hold STOP (□) to set the player to the standby mode, disconnect the AC adaptor, and then re-connect it.

- If the service number fails to be cleared even when the remedial action is taken, ask the service technician to repair the player.

### The following symptoms may be found during play or during charging of the battery pack: these are normal.

- The player heats up during use.
- When the battery pack is detached and then re-attached during charging, the CHARGE indicator goes off for an instant.
- Transmission noises are heard inside the AC adaptor during charging.
- The battery pack heats up after charging or during use.

### Regarding the LCD screen

This player provides a 280,000-pixel high-resolution LCD wide-screen, which lets you enjoy sharp images. However, a very small number of pixels may be luminous in black or in other colors: this results from a characteristic of the pixel and is not a malfunction.

# Troubleshooting

## When the STANDBY (⏻) indicator or the CHARGE (CHG) indicator flashes

### STANDBY (⏻) indicator

The indicator flashes slowly.



- The LCD is closed when the player is ON.
- The display mode of the LCD is set to "OFF" when the player is ON.
- Even though the In/Out select switch is set to "IN", there is no video plug (yellow) connected to the video input/output connector.

The indicator flashes quickly.



- A function button is pressed when the HOLD switch is set to the "HOLD" position.
- A function button is pressed when the In/Out select switch is set to "IN".

### CHARGE (CHG) indicator

The indicator flashes slowly.



- The remaining charge is low. [The power will soon be cut off (after a time period ranging from several minutes to about ten minutes.)]

The indicator flashes quickly.



- The battery pack has overheated during charging. (Wait for the battery pack to cool off, then start charging.)

The indicator flashes quickly.



- Though the battery pack has been charged for more than 12 hours, it cannot be fully charged for some reason. (Try charging again.)

■ refers to the period when the indicator is ON.

# Language code list

Code	Language
6565	Afar
6566	Abkhazian
6570	Afrikaans
6577	Ameharic
6582	Arabic
6583	Assamese
6588	Aymara
6590	Azerbaijani
6665	Bashkir
6669	Byelorussian
6671	Bulgarian
6672	Bihari
6678	Bengali; Bangla
6679	Tibetan
6682	Breton
6765	Catalan
6779	Corsican
6783	Czech
6789	Welsh
6865	Danish
6869	German
6890	Bhutani
6976	Greek
6978	English
6979	Esperanto
6983	Spanish
6984	Estonian
6985	Basque
7065	Persian
7073	Finnish
7074	Fiji
7079	Faroese
7082	French
7089	Frisian
7165	Irish
7168	Scots Gaelic
7176	Galician
7178	Guarani
7185	Gujarati
7265	Hausa
7273	Hindi
7282	Croatian
7285	Hungarian

Code	Language
7289	Armenian
7365	Interlingua
7378	Indonesian
7383	Icelandic
7384	Italian
7387	Hebrew
7465	Japanese
7473	Yiddish
7487	Javanese
7565	Georgian
7575	Kazakh
7576	Greenlandic
7577	Cambodian
7578	Kannada
7579	Korean
7583	Kashmiri
7585	Kurdish
7589	Kirghiz
7665	Latin
7678	Lingala
7679	Laothian
7684	Lithuanian
7686	Latvian, Lettish
7771	Malagasy
7773	Maori
7775	Macedonian
7776	Malayalam
7778	Mongolian
7779	Moldavian
7782	Marathi
7783	Malay
7784	Maltese
7789	Burmese
7865	Nauru
7869	Nepali
7876	Dutch
7879	Norwegian
7982	Oriya
8065	Punjabi
8076	Polish
8083	Pashto, Pushto
8084	Portuguese
8185	Quechua

Code	Language
8277	Rhaeto-Romance
8279	Romanian
8285	Russian
8365	Sanskrit
8368	Sindhi
8372	Serbo-Croatian
8373	Singhalese
8375	Slovak
8376	Slovenian
8377	Samoan
8378	Shona
8379	Somali
8381	Albanian
8382	Serbian
8385	Sundanese
8386	Swedish
8387	Swahili
8465	Tamil
8469	Telugu
8471	Tajik
8472	Thai
8473	Tigrinya
8475	Turkmen
8476	Tagalog
8479	Tonga
8482	Turkish
8484	Tatar
8487	Twi
8575	Ukrainian
8582	Urdu
8590	Uzbek
8673	Vietnamese
8679	Volapük
8779	Wolof
8872	Xhosa
8979	Yoruba
9072	Chinese
9085	Zulu

# Definition of terms

## Title, Chapter (DVD)

DVDs are divided into some large sections (titles) or some small sections (chapters). Each section is numbered; these numbers are called "Title number" or "Chapter number".

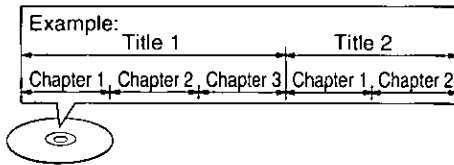

## Track (Video CD/CD)

Video CDs or CDs are divided into some sections (tracks). Each section is numbered; these numbers are called "Track number".

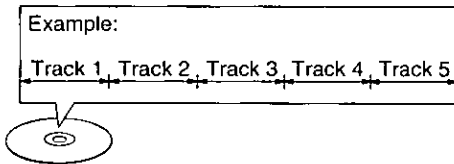

## Interactive DVD

An interactive DVD is a DVD software which includes multiple angles, multiple plot endings, etc.

## Playback control (Video CD)

If the Video CD has "With Playback Control" or others written on the disc surface or on the jacket, the scenes or information to be viewed (or listened to) can be selected interactively with the screen by looking at the menu shown on the screen.

In these instructions, playback using the menu screen is referred to as the "menu play" for Video CDs. This player supports Video CDs with playback control.

## Frame

Individual images in a video or on the TV are called frames.

## Frame still

The two fields are displayed, alternately, on the screen, so the image is blurry. However, the image quality is better than field images.

## Field

Half of the video information (video signal) in a frame is called a field. With conventional TV systems, a signal frame (a single screen) consists of two fields.

## Field still

Only one field (half of the video information) is displayed on the screen, so the apparent resolution is low. However, there is no blurring on the screen.

## Pan & Scan screen

This refers to a screen on which part of the wide-screen picture (either at both sides or one side of the screen) is automatically eliminated so that the picture fills the whole screen.

## Letterbox

This refers to a screen on which the playback picture of wide-screen DVDs or Video CDs appears with black bands inserted at the top and bottom of the screen to fill in the gaps where the size of the picture is smaller than the screen.

## S video output connector

The S (separate) video output connector separates the color (C) and luminance (Y) signals before transmitting them to the TV set in order to achieve a sharper picture.

Use the S video cable (optional) when connecting the player to a TV set equipped with an S video input connector for the best picture clarity possible.



### Picture type (I/P/B)

The MPEG 2 standard adopted for DVD uses the following 3 picture type for the coding of each picture (frame) on the screen.

#### **I: I-Picture (Intra coded picture)**

This is the standard picture type, and each picture is coded separately. Since it features the best picture quality, it is recommended that the screen be frozen with I-Picture when the picture quality is to be adjusted.

#### **P: P-Picture (Predictive coded picture)**

This picture type is computed on the basis of a past I-Picture or P-Picture.

#### **B: B-Picture (Bidirectionally-predictive coded picture)**

This picture type is computed by comparing the previous and subsequent I-Picture or P-Picture. It has the lowest volume of information.

#### General Picture type

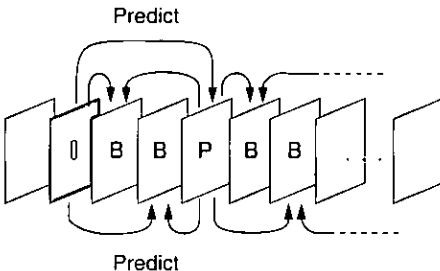

### Digital audio output connector (Optical)

The digital audio output connector (optical) converts electrical signals into optical signals and transfers them to the amplifier. Consequently, it has a number of features including its immunity from electrical interference from external sources and its ability to prevent the generation of noise and its minimal effect on the external environment.

### Dolby Digital (AC-3)

Dolby Digital (AC-3) is a digital sound compression technique developed by the Dolby Laboratories, Inc.

Supporting 5.1-channel surround sound, as well as stereo (2-channel) sound, this technique enables a large quantity of sound data to be efficiently recorded on a disc.

Manufactured under license from Dolby Laboratories. "Dolby", "AC-3", "Pro Logic" and the double-D symbol are trademarks of Dolby Laboratories. Confidential Unpublished Works. © 1992-1997 Dolby Laboratories, Inc. All rights reserved.

### Dolby Pro Logic Surround decoder

This is a unit which uses the Dolby Surround (Pro Logic) system to restore 4-channel signals which were recorded on 2 channels back to the signals of 4 separate channels during playback. Compared with Dolby Digital (AC-3)/5.1 channel surround sound, the channel separation is not as good and surround signals can be reproduced only up to a frequency of 7 kHz.

### dts (digital theater systems)

The digital theater systems (dts) is a 5.1-channel surround sound system, which is widely used in movie theaters around the world. It allows the bit rate to be increased in order to provide good sound quality without excessively compressing the data.

### Linear PCM audio (LPCM)

This refers to a signal recording format used in a CD.

While a CD is recorded in 44.1 kHz/16 bit, a DVD is recorded in 48 kHz/16 bit up to 96 kHz/24 bit, thus achieving higher quality audio than that of a CD.

# Specifications

<b>Power source:</b>	DC 9.0 V (AC adaptor connector)/ DC 7.2 V (Exclusive battery connector)
<b>Power consumption:</b>	16 W (10 W: Player only) (Approx. 2.0 W when power is off using the player or the remote control) [when the exclusive AC adaptor (supplied) is connected]
<b>AC adaptor</b>	Part No. VSK0555
<b>Power source:</b>	U.S.A. and Canada: AC 120 V, 60 Hz Foreign: AC 100–240 V, 50/60 Hz
<b>Power consumption:</b>	24 W
<b>DC output:</b>	9 V, 2 A

<b>Signal system:</b>	NTSC
<b>Weight:</b>	1.4 lbs. (640 g)
<b>Dimensions:</b>	5 <sup>9</sup> / <sub>16</sub> " (W)×6" (D)×1 <sup>1</sup> / <sub>2</sub> " (H) [140 (W)×151.5 (D)×37.7 (H) mm] (when the LCD screen is closed, excluding protrusions)
<b>Operating temperature range:</b>	+41 to +95°F (+5 to +35°C)
<b>Operating humidity range:</b>	5 to 90% RH (no condensation)
<b>Discs played:</b>	(1) DVD-VIDEO disc 5" (12 cm) single-sided, single-layer 5" (12 cm) single-sided, dual-layer 5" (12 cm) double-sided, single-layer 3" (8 cm) single-sided, single-layer 3" (8 cm) single-sided, dual-layer 3" (8 cm) double-sided, single-layer (2) Compact disc (CD-DA, VIDEO CD) 5" (12 cm) disc 3" (8 cm) disc
<b>LCD screen:</b>	5" α-Si, TFT wide-screen LCD
<b>S video output:</b>	Y output level: 1 Vp-p (75Ω) C output level: 0.286 Vp-p (75Ω) Output connector: S terminal (1 system)
<b>Video output/input:</b>	Output/input level: 1 Vp-p (75Ω) Output/input connector: Mini-jack (1 system, Output/Input selectable)
<b>Audio output/input:</b>	Output/input level: 1.5 Vrms (1 kHz, 0 dB) Output/input connector: Stereo mini-jack (1 system, Output/Input selectable)
<b>Audio signal output characteristics:</b>	(1) Frequency response: •DVD (linear audio): 4 Hz–22 kHz (48 kHz sampling) 4 Hz–44 kHz (96 kHz sampling) •CD audio: 4 Hz–20 kHz (2) S/N ratio: •CD audio: 115 dB (3) Dynamic range: •CD audio: 97 dB
<b>Digital audio output:</b>	Optical digital output: Mini optical connector (Also used for audio output/input)
<b>Pickup:</b>	Wave length: 660 nm/780 nm Laser power: CLASS II/CLASS I

Specifications are subject to change without notice.

Weight and dimensions are approximate.

Download from [www.Somanuals.com](http://www.Somanuals.com). All Manuals Search And Download.

# Index

- A** A-B repeat play ..... 40  
Angle switching ..... 39, 48  
Audio mode ..... 39  
Audio soundtrack  
•Audio attribute ..... 39  
•Audio soundtrack  
  language No. .... 39, 46  
•Changing audio soundtrack  
  language ..... 39, 46  
Auto-power off ..... 31
- B** Battery pack ..... 25–27  
Button-type battery ..... 22
- C** Card-type remote control unit ..... 20–23  
Chapter ..... 80  
Chapter preview function ..... 32  
Copyright ..... Back cover
- D** Dialogue Enhancer ..... 32, 41  
Digital audio  
  output ..... 51, 60–62, 68, 69, 81  
Disc  
•Disc handling ..... 15  
•Discs supported by this player ..... 10, 82  
•Inserting/Removing discs ..... 28  
Disc languages ..... 51, 52  
Dolby Digital  
  (AC-3) ..... 60–62, 65, 68, 69, 81  
Dolby Digital (AC-3) decoder ..... 68, 69  
Dolby Pro Logic surround  
  decoder ..... 68, 81  
dts (digital theater  
  systems) ..... 8, 60–62, 68, 69, 81  
dts decoder ..... 68, 69  
DVD Karaoke ..... 39, 47  
DVD menu ..... 43  
Dynamic range ..... 65
- E** Elapsed playing time ..... 38
- F** Field still ..... 34, 64, 80  
Frame advance/Frame reverse ..... 34  
Frame still ..... 34, 64, 80
- H** Headphones ..... 70  
Hold function ..... 19
- I** IN/OUT select of  
  video/audio ..... 18, 66–70  
Initial settings ..... 50–65  
Interactive DVD ..... 31, 80
- L** Language code list ..... 79  
LCD  
•Adjusting brightness ..... 16  
•Display mode ..... 16, 59  
Letterbox ..... 59, 65, 80  
Linear PCM ..... 60, 62, 68, 81  
Lithium ion battery ..... 8
- M** Maintenance ..... 15  
Marker ..... 41  
Menu play ..... 35, 80
- O** On-Screen Menu Icons ..... 36–42  
On-Screen Menu language ..... 51, 56  
On-Screen Messages ..... 51, 57  
Optical digital audio cable ..... 69  
Other settings ..... 51, 63
- P** Pan & Scan ..... 65, 80  
Picture type (I/P/B) ..... 65, 81  
Play mode ..... 41  
Playback control ..... 31, 35, 80  
Program play ..... 41, 44
- R** Random play ..... 41, 45  
Rapid advance/Rapid reverse  
  (Search) ..... 33, 40  
Ratings ..... 51, 54  
•Password ..... 54, 55, 75  
Region number ..... 10  
Repeat play ..... 40  
RESUME function ..... 32
- S** S video output connector ..... 18, 66, 80  
Self-diagnosis display function ..... 77  
Shuttle screen ..... 40  
Skipping ahead or back ..... 33  
Slow-motion play ..... 35, 40  
Stereo speakers ..... 16  
Still mode ..... 63  
Still picture/Pause ..... 34, 40  
Subtitles  
•Changing subtitle language ..... 39, 47  
•On/Off ..... 39, 47  
•Subtitle language No. .... 39, 47
- T** Title ..... 80  
Title menu ..... 43  
Track ..... 80  
TV aspect ..... 51, 58
- V** Video camera connection ..... 70  
Virtual Surround Sound (VSS) ..... 8, 41, 49

## ***Product service***

Do not attempt to remove the cover(s) or repair the player yourself. Refer servicing to qualified personnel only.

## ***Product information***

**U.S.A.:** For product service, product information or assistance with product operation, refer to the service center directory. **Canada:** Call the dealer from whom you have made your purchase, contact our Customer Care Centre at 905-624-5505, or access the CCC web site at [www.panasonic.ca](http://www.panasonic.ca)

## ***If you ship the product***

Carefully pack and send it prepaid, adequately insured and preferably in the original carton. Attach a postage-affixed letter, detailing the complaint, to the outside of the carton. **DO NOT send the product to the Executive or Regional Sales offices. They are NOT equipped to make repairs.**

Apparatus Claims of U.S. Patent Nos. 4,631,603, 4,577,216, and 4,819,098, licensed for limited viewing uses only.

This product incorporates copyright protection technology that is protected by method claims of certain U.S. patents and other intellectual property rights owned by Macrovision Corporation and other rights owners. Use of this copyright protection technology must be authorized by Macrovision Corporation, and is intended for home and other limited viewing uses only unless otherwise authorized by Macrovision Corporation. Reverse engineering or disassembly is prohibited.

---

**Panasonic Consumer Electronics Company,  
Division of Matsushita Electric Corporation of America**  
One Panasonic Way Secaucus, New Jersey 07094  
<http://www.panasonic.com>

**Panasonic Sales Company,  
Division of Matsushita Electric of Puerto Rico, Inc. ("PSC")**  
Ave. 65 de Infantería, Km 9.5 San Gabriel Industrial Park, Carolina, Puerto Rico 00985

**Panasonic Canada Inc.**  
5770 Ambler Drive, Mississauga, Ontario L4W 2T3  
[www.panasonic.ca](http://www.panasonic.ca)

© Matsushita Electric Industrial Co., Ltd. 1999

## Free Manuals Download Website

<http://myh66.com>

<http://usermanuals.us>

<http://www.somanuals.com>

<http://www.4manuals.cc>

<http://www.manual-lib.com>

<http://www.404manual.com>

<http://www.luxmanual.com>

<http://aubethermostatmanual.com>

Golf course search by state

<http://golfingnear.com>

Email search by domain

<http://emailbydomain.com>

Auto manuals search

<http://auto.somanuals.com>

TV manuals search

<http://tv.somanuals.com>