

# Panasonic

ideas for life

DP-3030

the **SMART** way to work

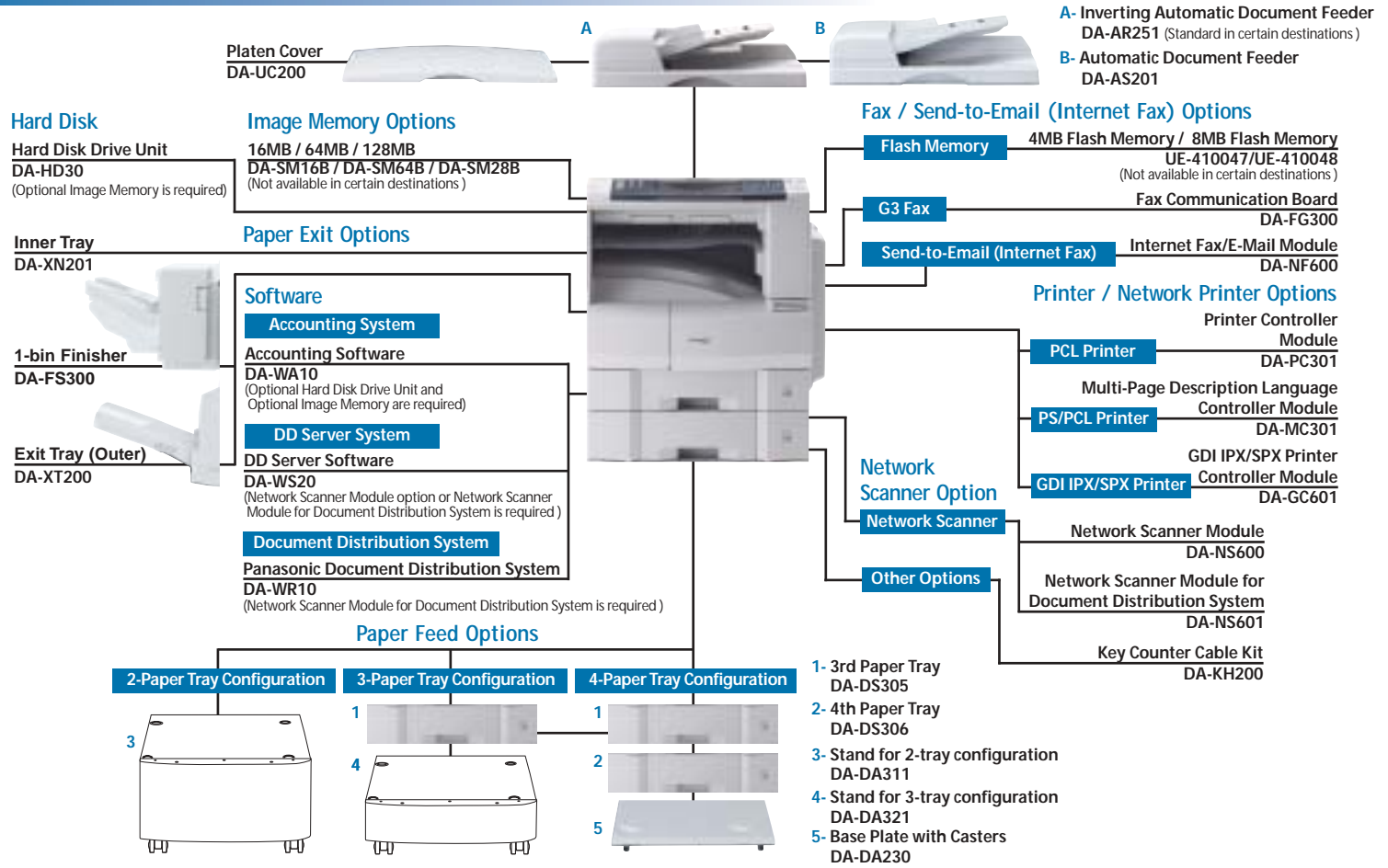

## DP-3030 Specifications

General	
Type	Desktop
Copy / Print Process	Laser Indirect Electrostatic
Developing Process	Dry Dual Component
Inverting Automatic Document Feeder (Option)	50 sheets (A4, 75 g/m <sup>2</sup> )
Paper Feed	Std. 550-sheet paper tray unit x 2 + 50-sheet bypass Max. 2,250 sheets with option
Paper Weight	Paper Tray: 60 to 90 g/m <sup>2</sup> Bypass: 55 to 133 g/m <sup>2</sup>
Power Requirements	AC 220-240 V, 50/60 Hz, 6.3A
Power Consumption	Max.: Less than 1.5 kW Power saver mode: Approx. 28 W Sleep mode: Approx. 18 W
Warm-up Time (20°C)	Approx. 35 sec. (Main power switch ON) Approx. 30 sec. (Power saver mode)
Dimensions (W x D x H) <sup>*1</sup> (Excluding optional equipment)	597 x 707 x 697 mm
Weight <sup>*1</sup> (Excluding optional equipment)	Approx. 72 kg (82 kg with Inverting Automatic Document Feeder)
Digital Copier	
First Copy Time	Approx. 4.5 sec. (A4)
Resolution	600 dpi
Gray Scale	256 steps
Multi Copy Speed <sup>*2</sup>	30 cpm
Maximum Original Size	A3
Copy Size	A3-A5 (fixed)
Copy Ratio	Enlargement (fixed): 200%, 173%, 141%, 122%, 115% Reduction (fixed): 87%, 82%, 71%, 58%, 50% 25-400% (in 1% increments)
Zoom (variable)	1 to 999. Automatic reset to 1
Multiple Copy	Text / Text/Photo / Photo
Exposure Control	16 MB
Sort Memory (Standard) (Option)	Base Memory (16 MB) plus 16 MB <sup>*3</sup> / 64 MB <sup>*3</sup> / 128 MB <sup>*3</sup> (max. 144 MB) 12 GB (with optional HDD)

Printer	
Network Printer Interface	Ethernet 10Base-T/100Base-TX
Communication Protocol	TCP/IP (LPR, FTP), SNMP, DHCP, IPX/SPX <sup>*4</sup> (NDIS, Bindery, NDIS <sup>*5</sup> ), AppleTalk (PS), IPP (PCL, PS)
Local Printer Interface	USB 1.1
Printer Language (Standard) (Option)	Panasonic Printing System for Windows <sup>®</sup> PCL 5e Emulation <sup>*6</sup> , PCL 6 Emulation <sup>*6</sup> Adobe <sup>®</sup> PostScript <sup>®</sup> 3 <sup>*7</sup>
Printing Speed <sup>*2</sup>	30 ppm
Paper Size	Paper Tray: A3-A5 Bypass: A3-A5
Printing Resolution	1,200 dpi equivalent x 600 dpi (PCL, PS), 600 dpi x 600 dpi, 300 dpi x 300 dpi (PCL, PS, GDI)
Printer Memory	50 MB
PCL/PS Spool Memory	6 GB with optional HDD
Compatible Operating Systems	Windows <sup>®</sup> XP/2000/Server 2003, 98, Me, Windows NT <sup>®</sup> 4.0, MacOS 8.6-10.3 (PS Only) <sup>*7</sup>
Network Scanner (Option)	
Network Scanner Interface	Ethernet 10Base-T/100Base-TX
Communication Protocol	TCP/IP (LPR, FTP)
Maximum Scanning Size	A3
Scanning Speed <sup>*8</sup>	Approx. 30 opm (Originals per minute – A4 portrait with ADF)
Scanning Resolution	150 dpi x 150 dpi, 300 dpi x 300 dpi, 600 dpi x 600 dpi
Compatible Operating Systems	Windows <sup>®</sup> XP/2000/Server 2003, 98, Me, Windows NT <sup>®</sup> 4.0
Data Format	TIFF, PDF
G3 Fax (Option)	
Compatibility	ITU-T Group 3, EOM
Modem Speed	33.6-2.4 kbps with automatic fallback
Coding Scheme	JBIG / MMR / MR / MH
Scanning Speed <sup>*8</sup>	Approx. 0.7 sec. (A4 portrait in Standard or Fine mode with ADF)
Transmission Speed <sup>*9</sup>	Approx. 2.9 sec.
Scanning Resolution	Standard: 8 dots/mm x 3.85 lines/mm Fine: 8 dots/mm x 7.7 lines/mm Super Fine: 16 dots/mm x 15.4 lines/mm 600 dpi: 600 dpi x 600 dpi
Maximum Original Size	A3
Effective Scanning Width	292 mm
Recording Resolution	600 x 600 dpi
Standard Memory <sup>*10</sup>	3 MB (Approx. 180 pages)
Optional Memory <sup>*10</sup>	Base memory plus 4 MB <sup>*11</sup> (320 pages) / 8 MB <sup>*11</sup> (640 pages)
Speed Dials	200 (Max. 1,000 with optional HDD and optional Image Memory)
Internet Fax/Send-to-Email (Option) <sup>*11</sup>	
Compatibility	IE/F RFC 2305, ITU-T T.37
Communication Protocol	TCP/IP (SMTP, POP3, LDAP <sup>*12</sup> )
Network Connectivity	Ethernet 10Base-T/100Base-TX
Data Format	TIFF-FX (Profile S/F/J), PDF <sup>*13</sup>

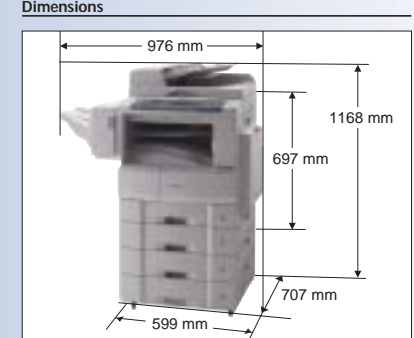

**Notes**

\*1 Dimensions and weight are approximate.  
 \*2 Speeds are contingent upon applications, machine configuration, and status. Individual speeds may vary.  
 \*3 May not be available in certain destinations.  
 \*4 Compatible with Novell NetWare<sup>®</sup> 3.4/5/6 and Novell Directory Services<sup>®</sup>.  
 \*5 Available in the 4th quarter of 2004.  
 \*6 Printer Controller Module or Multi-Page Description Language Controller Module option required.  
 \*7 Multi-Page Description Language Controller Module option required.  
 \*8 Scanning speed applies to the feeding process from the top to the end of a single page test chart. The time for the feeding process does not include the time that it takes for the top edge of the page to reach the scanning point and page ejection. Time for entire storing process is not applied.  
 \*9 Transmission time applies to memory transmission of test data using only ITU-T Image No. 1 between the same models at maximum modem speed. Transmission time may vary in actual usage. Usually public telephone lines can only support communication speeds of 28.8 Kbps or lower. Via PBX, transmission speed may fall back to a lower speed.  
 \*10 Based on ITU-T Image No. 1 scanned in Standard mode.  
 \*11 Depending on the receiving machine's capability, the document may not be correctly printed depending on the chosen resolution and document size.  
 \*12 This function is not available in certain destinations.  
 \*13 T.37 Internet Fax only supports TIFF format.

Design and specification are subject to change without notice. Not all options may be available at the time of notification.

Microsoft<sup>®</sup> Windows<sup>®</sup> and Windows NT<sup>®</sup> are registered trademarks of Microsoft Corporation.  
 Adobe, PostScript and PostScript 3 are either registered trademarks or trademarks of Adobe Systems Incorporated in the United States and/or other countries.  
 Novell NetWare<sup>®</sup> and Novell Directory Services<sup>®</sup> are registered trademarks of Novell Inc., in the United States and other countries.  
 PCL is a registered trademark of Hewlett-Packard.  
 WORKiO<sup>™</sup> is a registered trademark of Matsushita Electric Industrial Co., Ltd.  
 All other brand or product names are the property of their respective holders.



**30 cpm / 30 ppm**  
Digital Copying / Printing

Standard Network Printing / Document Manager Software

Scan-to-PC / Send-to-Email / Scan-to-FTP / Scan-to-Server capabilities

Standard Stackless Duplexing



**ISO 9001 Quality Management System**

Our business processes which produce document, information and network products, from manufacturing to marketing, conform to ISO9001 Quality Management Systems standard. Design, development, manufacture, installation, repair and maintenance of document, information and network products, their associated devices and consumables. In addition, the plants outside Japan have acquired ISO 9001 certification.

As an Energy Star<sup>®</sup> Partner, Panasonic has determined that this product meets the Energy Star<sup>®</sup> Guidelines for energy efficiency.

Printed on recycled paper



# WORKiO network-ready solutions

Welcome to the world of WORKiO digital imaging platforms - the true convergence of digital communications and cutting-edge imaging technology. With every new generation, WORKiO solutions deliver more versatility, higher reliability, greater ease of use, and expanded network connectivity to your business. From our flagship department-class digital hubs and "all-round" multifunction workgroup platforms to high-performance colour printers and document scanners, WORKiO again sets new standards in intuitive operation, durability, performance, and network integration.

Our newest addition to the WORKiO product lineup is the WORKiO DP-3030, designed to take the most difficult job and simplify it, freeing up your time to focus on other priorities. Its advanced digital capabilities, intuitive user interface, and efficient speed, enable the Panasonic WORKiO DP-3030 to truly deliver productivity to your business, with a touch of a button.

Whether you are focused on today's needs or you are looking ahead to the future, the Panasonic WORKiO DP-3030 is always "the SMART way to work".

## Face of the Next Generation

A true multifunction digital imaging system, the WORKiO DP-3030 provides you with solutions. High quality printing and efficient copying are essential to your document needs. The WORKiO DP-3030 gives you these capabilities and more... in one easy-to-use product. It incorporates the same advanced technology, versatility, and intuitive operation found in our department-class digital hubs, in a reliable compact platform with performance that precisely fits your needs. Serving as a complete document processing and management solution, the DP-3030 is ready to bring the digital imaging revolution to your workplace. The WORKiO DP-3030's advanced features and multifunction capabilities are easily accessible thanks to a revolutionary visual user interface displayed on a spacious half-VGA size touch panel. Everything is arranged according to the natural workflow and organised in an intuitive tabbed interface that enables walk-up users to complete even the most challenging applications. The WORKiO DP-3030 is a true multifunction device right out of the box with standard GDI Network Printing, Network Interface card, and a built-in Duplex Unit with output expandable to two inner trays. Its advanced technology combines all this functionality in a single console, exceeding expectations. The WORKiO DP-3030 is "the smart way to work" for your workplace.



# WORKiO

# WORKiO – the Copying Solution & Network Printing Solution



## fast, high-quality copying

From routine copying of meeting notes to the production of stapled multi-page reports for the entire department, the WORKiO DP-3030 delivers up to 30 A4-size copies per minute and features A3-size paper handling as standard. The combination of 600 x 600 dpi printing resolution and 256 gray scale half tones offers the ultimate in output quality thanks to a unique new Panasonic image stabilization system that uses advanced technology to control the laser exposure time. ■



## Image Enhancement Technology

Original WORKiO technology makes sure that very detailed graphics and small text are copied in clear detail.

## innovative interface

The intuitive tabbed **interface** on the extra-large half-VGA LCD display (640 x 240 pixels) provides quick access to basic copying functions as well as walks users through advanced settings such as image rotation and finishing options. A graphical confirmation feature helps prevent costly copying errors and can even send a completion notice to the user. ■



## meet the friendliest interface in the office

Designed to let even a first-time user take full advantage of the many digital copying conveniences, the WORKiO GUI sets a standard in ease of use. The left-to-right menu arrangement follows the natural flow of work and takes the complexity out of the most challenging copy jobs. In the spacious layout of the large touch-screen panel, settings are presented with easy-to-understand graphics to simplify your selection.

## versatility and convenience

Enjoy amazing versatility with the built-in **stackless duplex unit** and Optional Inverting Automatic Document Feeder\* as well as handy functions such as **Double Exposure**, **Digital SkyShot**, **N-in-1 Copy**, **Zoom** and **Image Rotation**. The convenient Sort Copy function electronically collates copies as shifted and rotated sets. ■



\* Standard in certain destinations.

## Double Exposure **WORKiO Original**

The DP-3030 has a versatile unique function that allows users to make quality copies of double-sided documents on a single sheet of paper without the black borders, even if the platen cover is open. This is especially convenient for copying small double-sided originals such as ID and insurance cards, cheques, and receipts.

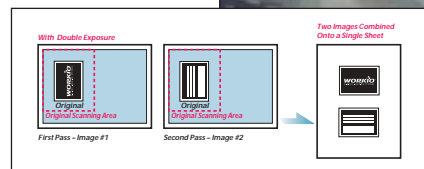

## N-in-1 copy

N-in-1 Copy is a cost efficient feature. Copy multiple originals onto a single sheet of paper.



## copying connectivity

Built-in connectivity enables advanced capabilities such as **Tandem Copy\*** and **Remote Copy\***. For extra-large jobs with tight deadlines, Tandem Copy lets you harness the power of multiple WORKiO platforms to work jointly on a single job. ■

\* Optional Hard Disk Drive Unit and optional Image Memory are required. These functions are available only between DP-3030/2330 and other DP-3030/2330/3010/2310 WORKiOs.

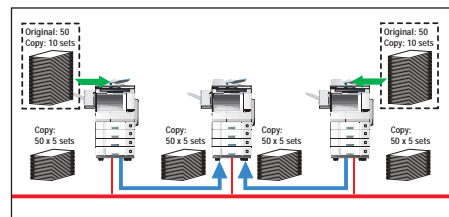

## complete from start to finish

The optional finishing capabilities turn your WORKiO into a complete document solution, from start to finish. Before you press start, the DP-3030 lets you **check finishing selections** to prevent costly mistakes. ■



## check finishing selections

You can confirm all settings from size and "Zoom/Effects" to "Sort/Finish" on the screen and prevent wasteful miscopying.

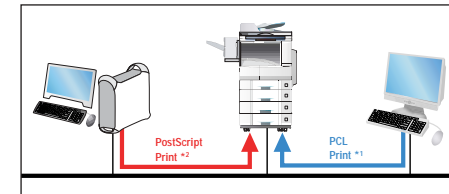

## leveraging your network with connectivity

With the standard 10Base-T/100Base-TX Ethernet interface, the DP-3030 provides printing power and performance to all networked PCs. The standard USB interface allows for direct connection to a dedicated PC.



## status monitor utility

With this convenient utility, users can easily view the status of the WORKiO DP-3030 including toner and paper supply.

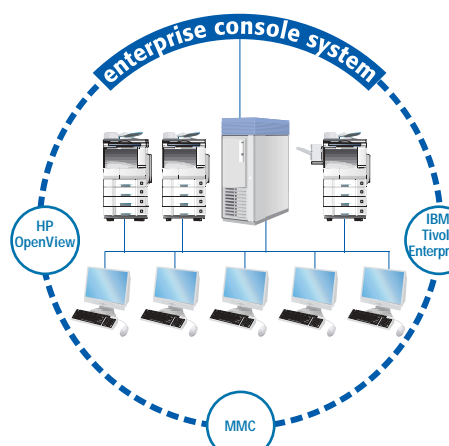

## systematic issue identification and resolution

Incorporating MetaConsole™ technology licensed from Netaphor™ Software, the DP-3030 can be used as a device that can be managed by popular Enterprise Console Systems to maintain peak system performance while reducing support costs.

\* MetaConsole™ is a registered trademark of Netaphor™ Software Inc.  
\* Tivoli™ is a registered trademark of IBM Corporation.  
\* OpenView is a trademark of Hewlett Packard.  
\* Microsoft® Management Console is a registered trademark of Microsoft Corporation.

## high-quality 30-ppm network printing and A3-size capability

The **network-ready** DP-3030 lets your LAN users access up to 30-ppm (A4) printing speed and **high-quality** output thanks to Panasonic's Image Enhancement Technology. This A3-size network printer takes advantage of the built-in automatic duplex unit to provide 2-sided printing. In addition to the standard Panasonic Printing System for Windows (GDI), optional modules and drivers expand printing versatility with PCL\*1 and genuine Adobe PostScript 3\*\* capability. These optional modules are also compatible with IPX/SPX protocols. ■

\*1 Optional PCL Printer Controller Module is required.

\*\*2 Optional Multi-Page Description Language Controller Module is required.

## versatile print driver

Easy-to-install print drivers empower users with full control of versatile printing functions right from the desktop. From the intuitive tabbed interface, to the on-screen graphical preview of job settings, to being able to check the status of the machine prior to printing, everything is designed to maximize ease of use and eliminate costly errors. ■

## true system integration

For today's networked business environments, the DP-3030 includes many network utilities. From the Console Management System, to network based configuration tools for address books and system settings, the DP-3030 provides IT Managers with the advanced configuration and enhanced network connectivity they require. ■

## "smart" economy and efficiency

The optional hard disk drive unit\* enables document storage in mailboxes that can be password protected for secure printing, Intelligent Job Control Management for detailed print queue management, concurrent copy capability for up to 12 sequential jobs, storage for downloading PostScript fonts and enlarged memory areas for job spooling, scanning and sorting capabilities... these are just a few of the intelligent WORKiO features that contribute to improved productivity. The WORKiO DP-3030 also enables administrators to efficiently set up and configure the system via the network, and offers easy-to-install optional Network Accounting Software to track and log the volume of WORKiO usage by user, department and function (Print, Copy, Scan, Fax). ■

\* Optional Image Memory is required.

## maximum 3-way paper output

Automatically separate output by function to a maximum of three trays for easy sorting and pickup. For example, incoming faxes can be assigned to the inner tray (1), printer output can be assigned to the optional inner tray (2), and copy output can be assigned to the optional outer tray/finisher (3).



## security function

To ensure the security of your print or copy data, the DP-3030 has the capability to employ multiple levels of security functions that erases data on a hard disk by overwriting it with zero data or random numbers to prevent the leakage of information. ■



## security level selection

DP-3030 has 3 levels for auto deletion and 2 levels for manual deletion. Thanks to multiple choices, it is possible to choose the security level depending on the importance of the data and situation.

# WORKiO – the Scanning & Document Distribution Solution



## high-speed network scanning

With the optional Network Scanning Module, the WORKiO DP-3030 becomes a high-speed network scanner that revolutionizes document distribution. The intuitive WORKiO interface makes it easy to send scanned documents to an FTP server or PC on the LAN. The "File Naming" feature gives you the freedom to assign a name to scanned files before you send it for easy identification. Thanks to the high-resolution scanning at up to 600 x 600dpi with 256 gray scale halftone using error diffusion technology, clear crisp image quality is achieved. With the optional inverting ADF unit\*, 2-sided scanning up to A3-size is possible. ■

\* Standard in certain destinations.

## document distribution system

The optional Document Distribution System allows users to send documents to dedicated recipients automatically. Information can be received as scans, incoming faxes or even emails with attachments and routed to the right person every time saving time and money. You can even perform user defined jobs such as auto-rotation, noise reduction, skew correction, OCR text extraction and automatic file naming using OCR title extraction. Once you've used the DP-3030 to start the workflow process, the Document Distribution System can route those documents via fax, email, ftp, or send them to a network folder, a web based folder or even directly to a PC's desktop. Combine that with the built-in PDF conversion utility and you can get text-searchable PDF files where you want them and when you want them. ■

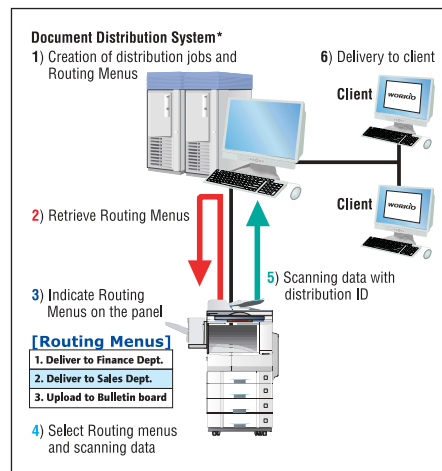

### Document Distribution System\*

\*Optional Network Scanner Module for Document Distribution System is required.

## fast faxing

Transform the DP-3030 into a high-performance fax station. The optional fax communication kit adds fast 33.6 kbps Super G3 fax capability accelerated by 0.7-sec\* "Quick Scanning" for shorter preparation time and Quick Memory Transmission. One of the smart features of the DP-3030 is a function that automatically switches to fax mode by determining that a telephone number is being entered when a number over 6 digits is keyed in. ■

\*A4 portrait in Standard or Fine mode using the ADF.

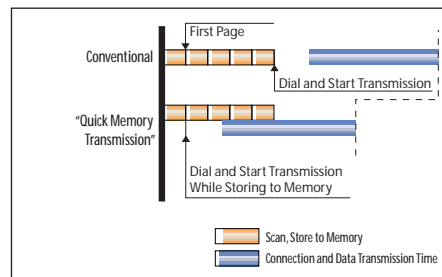

### "Quick Memory Transmission"

For fax transmission of multiple pages, the WORKiO DP-3030 begins transmitting while scanning large documents.

## desktop document management

The WORKiO DP-3030 also provides Document Manager software for efficient management, editing and sharing of scanned documents. For very large-scale document management based on a client-server model, the optional DD Server System\* takes your business a step closer to paperless document management. ■

\*Optional Network Scanner Module or Network Scanner Module for Document Distribution System is required.

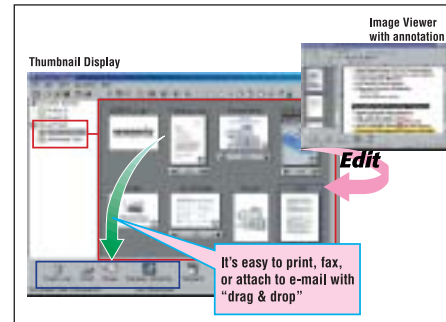

## scanned document management

When a scanned document arrives, the Document Manager software notifies the user and automatically opens the file. Image Viewer enables the user to easily view, annotate or attach memos to the file. With a simple drag and drop operation, users can manage and edit documents from their desktop, and then share them with other users.

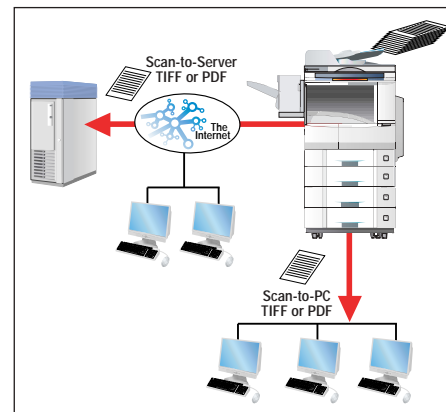

## multi-network design

Broad OS compatibility ensures that LAN clients using Windows XP/Server 2003/2000/98/Me and even Windows NT 4.0 take advantage of the versatile "Push-type" network scanning capability.

\*To receive the TIFF or PDF file, Panasonic Document Management System software is required.

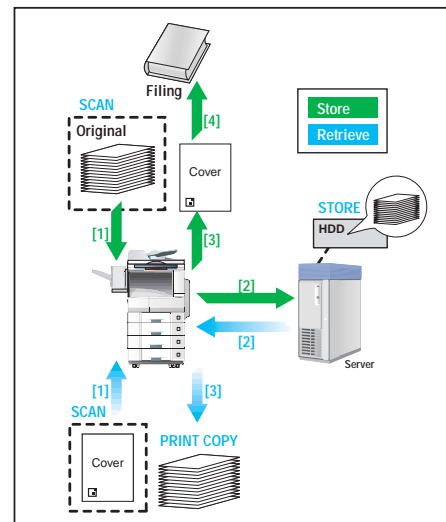

## one-touch document routing

The DP-3030's Address Book allows up to 1,000 addresses to be programmed (optional Hard Disk Drive Unit and optional Image Memory are required). Fax numbers, email addresses as well as network addresses can be easily stored using the "soft" QWERTY keyboard. This convenient utility supports the simple creation of a standardized email header.

## service friendly

Easy maintenance access is one of the distinctive features of WORKiO's "service friendly" concept.



Replacing toner is easy with front panel access. Just open, remove the waste toner container, and then twist and slide out the toner cartridge.

## the solution that is friendly to the environment

The EnergyStar-compliant DP-3030 contributes to lower Total Cost of Ownership (TCO). In sleep mode, energy requirements drop to virtually nothing. The work environment is also quieter and cleaner thanks to reduced noise and ozone emissions.



## internet faxing

With the Internet Fax/E-Mail option, the DP-3030 can be set up to scan documents as TIFF images or PDF files and transmit them as email attachments. For example, with the "Send-to-Email" feature, scanned documents can be sent to other Internet Fax-capable\* platforms or email clients anywhere in the world. Simultaneous distribution of the same document to multiple email clients and G3 fax terminals is easy using the "Mixed Broadcast" feature. WORKiO's Internet Fax/E-Mail option also provides a fax/email gateway function, which automatically routes incoming faxes to the recipient's email inbox. The attached image file can easily be opened and viewed with a standard image viewer. With Panafax Desktop software, users can send documents directly from their PC via the LAN and the DP-3030 gateway to G3 fax machines around the world. ■

\*In the case of the Send to Email transmission at 600dpi and/or A3 documents, reception may not be possible in some instances due to reception-side functions.

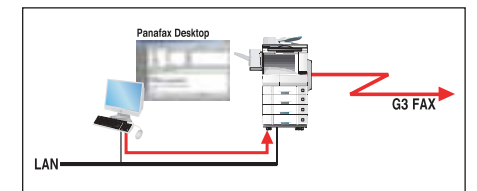
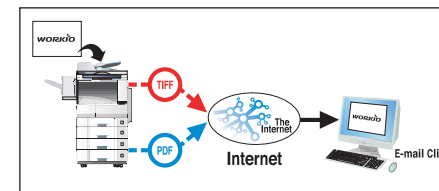

## image format versatility

The DP-3030 can be set up to scan images in standard TIFF or the popular PDF format and transmit them as email attachments.

## Panafax Desktop software

Panafax Desktop lets users send documents from their PCs directly to fax machines over the network. By eliminating the step of printing out a hard copy and then running it through the fax machine, Panafax Desktop can save valuable paper, labor and time.

## the solution you can depend on

Reliability is always top priority for the entire line of Panasonic WORKiO products. Especially in the case of a multifunction digital document hub, we know that downtime is costly. For this reason, every aspect of the WORKiO DP-3030 is engineered to last. Also it features an easy-access design to reduce time required for routine toner replacement and other servicing tasks. ■

## the solution we help maintain

By automatically reporting the status of the toner level and various key mechanical issues to a service centre, "Check & Call" can prevent costly downtime caused by simple problems. The WORKiO DP-3030 also incorporates the Remote Diagnostic System that enables technicians to quickly identify problems and provide solutions. ■



### "Check & Call"

The convenient "Check and Call" system enables service centres to stay on top of your printer status and performance. For example, the built-in automatic report function notifies your service centre when toner is running low or if any mechanical problems need attention.

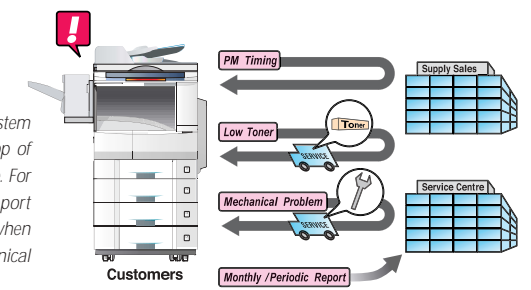

\*Optional Fax Communication Board or Internet Fax/E-Mail Module is required.

## Free Manuals Download Website

<http://myh66.com>

<http://usermanuals.us>

<http://www.somanuals.com>

<http://www.4manuals.cc>

<http://www.manual-lib.com>

<http://www.404manual.com>

<http://www.luxmanual.com>

<http://aubethermostatmanual.com>

Golf course search by state

<http://golfingnear.com>

Email search by domain

<http://emailbydomain.com>

Auto manuals search

<http://auto.somanuals.com>

TV manuals search

<http://tv.somanuals.com>