

Specifications



Panasonic®

digital imaging systems

DP-4510

the **SMART** way to work

DP-4510 Specifications

General / Digital Copier

Type	Semi Console
Copy/Print Process	Laser/Electrostatic photographic method
Warm-up Time	Less than 180 sec.
First Copy Speed	Less than 4.5 sec.
Copy Resolution	600 x 600 dpi
Gray Scale	256 steps
Multi-Copy Speed	45 ppm
Max. Original Size	A3
Copy Size	A3, B4, Foolscap, A4, B5, A5
Copy Ratio	
Enlargement (fixed):	200%, 173%, 141%, 122%, 115%
Reduction (fixed):	87%, 82%, 71%, 58%, 50%
Zoom (variable):	25 - 400% (in 1% increments)
Paper Capacity	1,550 (Large-Capacity Tray) + 550 sheets
Bypass Capacity	50 sheets
Max. Paper Capacity	6,250 sheets with option
Paper Weight	
Paper tray:	60 to 90 g/m ²
Bypass:	55 to 133 g/m ²
Quantity Selector	1 to 999, Automatic reset to 1
Duplex	Standard with "stackless" duplex unit
Exposure Control	Text, Text/Photo, Photo
Sort Memory	Uses JBIG Compression
Standard	32MB
Option ¹	Base memory (32MB) plus 16MB/ 64MB/128MB (max. 160MB) and optional HDD.
Dimensions (W x D x H) ²	600 x 758 x 900 mm Main unit with (excluding optional equipment)
Weight ²	Approx. 131 kg (excluding optional equipment)
Power Requirements	AC 220 - 240V, 50/60 Hz, 6.5A
Power Consumption	MAX. Less than 1.5kW, 20Wh in Sleep Mode

Auto Document Feeder

Document Capacity	Max. 70 sheets (80 g/m ²)
Document Size	A3 - A5
Original Set	Face Up
Scanning Method	Sheet Through

Printer/Scanner

Printing Speed	45 ppm
Page Description Language	PCL5e, PCL6, PostScript® 3™ (Option)
Standard Printer Memory	20MB
Printing Resolution	1200 dpi equivalent x 600 dpi (PCL/PS)
Paper Size	A3 - A5
Interface	Ethernet 10Base-T/100Base-TX, Bi-directional Parallel (IEEE1284)
Scanning Resolution (Max.)	600 dpi x 600 dpi
Computer Compatibility	Windows® XP/2000/98/Me, Windows NT® 4.0, Mac OS 8.6 - 10.1 (PS only)

G3 Fax

Compression Method	MH, MR, MMR, JBIG
Modem Speed (Max.)	33.6 kbps
Resolution	600 x 600 dpi
Fax Memory Capacity	2MB (Max. 10MB*)
	Uses non-volatile Flash ROM
Transmission Speed	Less than 3 sec.
No. of Auto Dialers	200 (Max. 1000 with optional HDD)

Send to E-mail / Internet Fax

Compatibility	IETF RFC 2305, ITU-T T.37
Communication Protocol	TCP/IP, SMTP, POP3, MIME
Network Connectivity	Ethernet 10Base-T/100Base-TX (IEEE802.3)
Data Format	TIFF-FX, Profile S, MMR

Dimensions

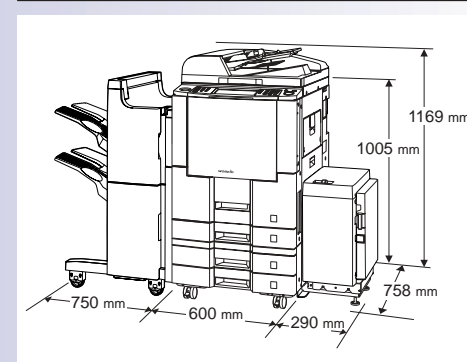

Notes

*1 Not available in certain countries.
*2 Dimensions and weight are approximate.
Microsoft®, Windows® and Windows NT® are registered trademarks of Microsoft Corporation.
Adobe®, PostScript® and PostScript logo® are trademarks of Adobe Systems, Inc.
PCL® and Open View® are registered trademarks of Hewlett-Packard.
WORKIO™ is a trademark of Matsushita Electric Industrial Co., Ltd.
All other brand or product names are the property of their respective holders.

Design and specifications are subject to change without notice.
Not all options may be available at the time of introduction.

ISO 9001

Quality Management System

Our business processes which produce document, information and network products, from manufacturing to marketing, conform to ISO9001 Quality Management Systems standard. Design, development, manufacture, installation, repair and maintenance of document, information and network products, their associated devices and consumables.



As an Energy Star® Partner, Panasonic has determined that this product meets the Energy Star® Guidelines for energy efficiency.

Compact, Network-Ready
Colour Laser Printers

WORKIO



Colour Laser Printers



45 ppm Digital Input and Output System

Standard Network Printing/
Document Management

Powerful Upgrades for Incredible
Multifunctionality

Advanced Network and
Job Management Capability

Panasonic®

WORKIO™
DIGITAL IMAGING SYSTEMS

WORKiO network-ready solutions

Welcome to the world of WORKiO digital imaging platforms - the true convergence of digital communications and cutting-edge imaging technology. With every new generation, WORKiO solutions deliver more versatility, higher reliability, greater ease of use, and expanded network connectivity to your business. From our flagship department-class digital hubs and "all-round" multifunction workgroup platforms to high-performance colour printers and document scanners, WORKiO again sets new standards in intuitive operation, durability, performance, and network integration.

Our latest generation offers a glimpse into the WORKiO vision for the office of tomorrow. As you experience our new "smart" visual user interface, you see how WORKiO will put the power of the most advanced office technology at your fingertips. In your exploration of our desktop document management, you realise that WORKiO is bringing the "paperless" office another step closer to reality. In our enhanced network connectivity, you begin to share our future vision of the "ubiquitous digital" work environment where all devices speak the same language.

Whether you are focused on today's needs or looking ahead to the future, WORKiO is always

"the **SMART** way to work"

Digital Hub Keystone of Your Document Infrastructure

Anticipating the next generation of workplace needs, the WORKiO DP-4510 digital hub transcends multifunctionality and brings you connectivity. Featuring incredible networkability and ease of operation, this platform is the simple high-performance, high-volume solution for total document processing and management needs.

WORKiO DP-4510 integrates the total document workflow from digital copying, network printing and network scanning to fax and e-mail distribution in a single space-saving console. Ready to connect to your LAN right out of the box, it immediately brings the efficiency and productivity of digital imaging to every desktop PC. For walk-up users, the revolutionary visual user interface erases any fears of complexity and gives new meaning to "user friendly". The rugged design and a host of service-friendly features set new standards for WORKiO reliability. Of course, every aspect of its design from key components with extended life to its energy-stingy design contributes to lower TCO and a more economical work environment.

WORKiO DP-4510 is a complete solution designed and engineered for the sole purpose of giving you "the smart way to work."



WORKiO – the Copying Solution



WORKiO Walkthrough: Simple Steps to Making a Booklet

Step 1:



Setting naturally begins with the left tab - "Basic" menu. We select "Proof Set" to obtain one sample set to check all job settings before committing to a mass copying job. We also want to be informed when the job is done, so we press the "Completion Notice" button on the bottom left of the screen.

Step 2:

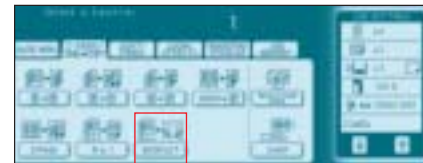

The next tab "2-sided/orig.->copy" offers a variety of choices that use built-in duplex. Each is represented by text and easy-to-understand graphics. We choose "Booklet".



Step 3:

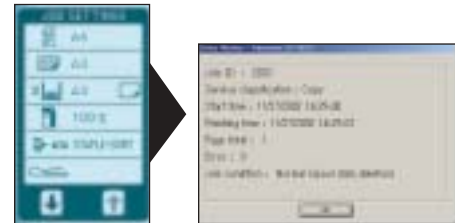

Always visible on the right side of the interface, the "Job Setting" summary lets the user confirm settings and easily go back and make changes. After the job is started, we return to our desk and take care of other business until the job completion notice from WORKiO arrives.

high-speed A3-class copying

From routine copying of notes for meetings to the production of bound multi-page reports for the entire department, WORKiO DP-4510 is ready for everything from simple to complex high-volume jobs at a blazing 45 A4-size copies per minute. Responding to the demand for large-size document copying, A3-size paper handling is standard. ■

innovative interface

Engineered from the ground up for ease of use, this platform also saves time in job setting through an innovative and friendly GUI. The intuitive tabbed interface on the extra-large half-VGA LCD display (640 x 240 pixels) gives users quick access to both basic copying functions as well as leads them through advanced settings such as image rotation and finishing options. Graphical confirmation of the original versus final job setting is provided prior to job execution to prevent costly miscopying errors. While WORKiO is completing a large-volume job, the user can return to other work and wait for a completion notice to be sent directly to their PC. ■

high-quality image reproduction

Speed never comes at the expense of quality with WORKiO. Newly developed LSIs, ultra-fine toner/carrier particles and image stabilising technology ensure 600 x 600 dpi resolution and 256-level gray scale to produce copies with high legibility and clear sharp clear images at high speed across multiple generations. ■



Image Enhancement Technology

If one picture is worth a thousand words, then WORKiO makes sure the image quality delivers full value by faithfully copying every graphic nuance and the smallest text in clear detail.



capacity that grows with your needs

WORKiO DP-4510 is ready to meet the needs of most high-volume work environments. The standard huge capacity of 2,150 sheets is realized by a 1,550-sheet large-capacity tray, a 550-sheet paper tray and a 50-sheet bypass tray. However, if more capacity is required, the addition of two optional 550-sheet trays and a 3,000-sheet cassette can raise capacity to a maximum 6,250 sheets.

Meet the Friendliest Face in the Office

Designed to let even a first-time user take full advantage of the many digital copying conveniences, the new WORKiO GUI sets a new standard in ease of operation. The left-to-right menu arrangement follows the natural flow of work and takes the complexity out of setting the most challenging copy jobs. In the spacious layout of the large touch-screen panel, settings are presented with easy-to-understand graphics to speed identification and selection.

versatility and convenience

In digital copying versatility, the WORKiO DP-4510 is unsurpassed with features like a built-in duplex unit and high-speed automatic document feeder. Conveniences like N-in-1 Copy, Zoom and Image Rotation introduce users to new flexibility in digital copying, while Sort Copy electronically collates copies as shifted and rotated sets, saving valuable time. ■



N-in-1 copy

Using the easy-to-understand interface, copying multiple originals on a single sheet face is very simple, accelerating document production while saving paper.

network-enhanced functionality

Connectivity may not seem important in copying until you explore how the inherent networkability of WORKiO DP-4510 enables enhanced capabilities such as Tandem Copy* and Remote Copy*. ■

complete from start to finish

The final step of manually "finishing" copies as stapled or bound sets, ready for distribution, is a time-consuming step. The addition of optional stapling, punching and saddle-stitching finishing modules automates this process and makes your WORKiO a complete document solution literally from start to finish. Always visible on the right side of the interface, the Job Setting window provides an easy-to-see, easy-to-navigate graphical list of all user settings, enabling confirmation of "finish" or any other settings beforehand. ■



double-side copying for double savings

Built-in duplex unit enables copying on both sides of each sheet for higher productivity and economy. Used in combination with the Automatic Document Feeder, users can exploit the advantages of high-speed duplex copying.

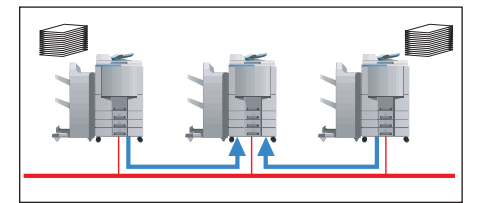

Tandem Copy*

For extra-large jobs with tight deadlines, Tandem Copy lets you harness the power of multiple WORKiO platforms to work jointly on a single job.

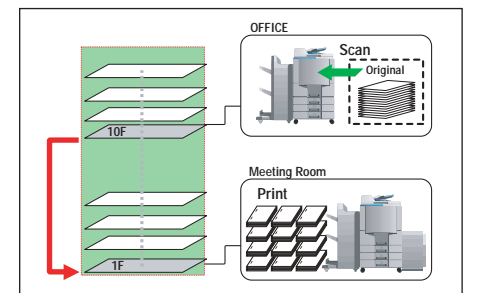

Remote Copy*

With remote copy, a copy job can be sent to another networked WORKiO platform on another floor or in a different department.



Finishing the Job

Select sorting/finishing options and your only job is picking up the collated sets of copies. With optional finishing modules, sets are automatically stapled or saddle-stitched or hole-punched for ring binding.

*Optional Hard Disk Drive Unit is required.

WORKiO Solutions



WORKiO network connectivity opens the door to innovative productivity even in copying. For example, this network-ready platform can work together on the same large-volume copy job with another DP-6010, DP-4510 or DP-3510 digital imaging hub on your LAN, reducing time as much as 50%.

WORKiO – the Printing Solution



Step 1:
Select the paper size in the WORKiO printer driver menu.



Step 2:
Select from a range of labor-saving finishing options.

Step 3: After sending the job to the printer, DP-4510 notifies the user when the job is finished by sending a Completion Notice, eliminating wasted trips back and forth to check especially when the print job queue is full.

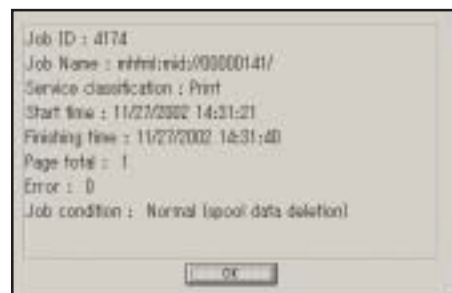

45-ppm network printing plus A3-output capability

Equipped with "plug-and-play" network connectivity as a standard feature, network-ready WORKiO DP-4510 gives all PCs on your LAN access to super-fast 45-ppm (A4) printing speed. Custom LSIs and a high-performance microprocessor make sure that there is no compromise in quality even at this high speed. Effortlessly meeting heavy volume needs with total reliability, this A3-class platform further enhances productivity with a built-in automatic duplex unit. ■

friendly graphical drivers

Easy-to-install graphical printer drivers empower users with full control of versatile printing functions right from the desktop. From the intuitive tabbed interface to on-screen graphical preview of job settings, everything is designed to maximise ease of use and eliminate costly errors. ■

quality in detail

True 600x600-dpi resolution is more than enough image quality for professional-quality documents, but DP-4510 raises the bar with Panasonic Image Enhancement Technology and produces quality equivalent to 1,200dpi for even smoother gradations, sharper detail, and superb photos and graphics. Small text is easily legible even against background graphics. In addition to standard Windows GDI printing, WORKiO offers optional modules and drivers to expand printing versatility with PCL® and PostScript® capability. ■



behind speed and quality

Powered by a high-performance microprocessor and custom-developed LSIs, the improved imaging processing speed and quality ensures high-speed printing of crisp high-quality images.

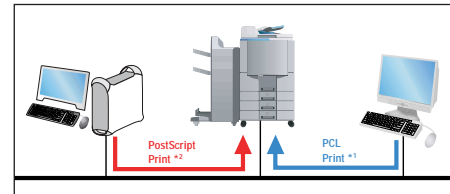

leveraging your network with connectivity

WORKiO is about sharing networked resources and multiplying their effectiveness. With 10Base-T/100Base-TX Ethernet interface as standard, DP-4510 immediately enables all networked PCs to access the power and performance of network printing from the desktop. A parallel interface is also included for direct connection to a dedicated PC.

*1 Optional PCL Printer Controller Module is required.
*2 Optional Multi-Page Description Language Controller Module is required.

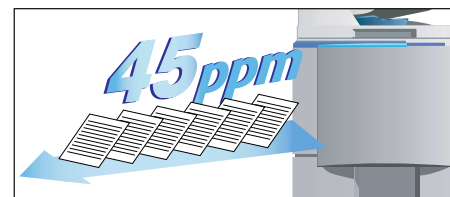

beyond stand-alone printer performance

Built to stand up to the tough day-to-day high-volume demands of the busiest environments, the durable printer engine pumps out high-quality printout at 45 ppm - more than double the speed of most single-function office printers. Moreover, its A3-size output capability is uncommon in standard PC printers.

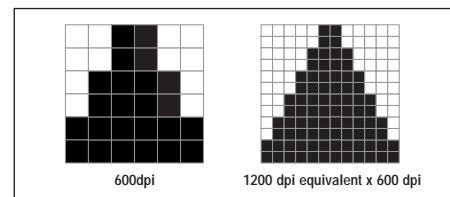

improving images pixel by pixel

Panasonic Image Enhancement Technology makes a visible difference in every printout. By producing images with the equivalent of twice the number of dots per inch of a 600dpi printer, WORKiO DP-4510 gives documents smoother curves and diagonals and banding-free gradations.

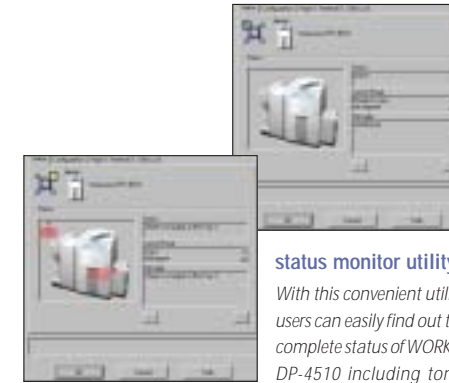

status monitor utility

With this convenient utility, users can easily find out the complete status of WORKiO DP-4510 including toner and paper supply.

handy status monitor

A visual Status Monitor lets users check the current status of the WORKiO DP-4510 without leaving their desks. If toner is running low or the paper bin needs refilling, users know immediately and quickly respond, avoiding costly work interruptions. ■

true system integration

For today's networked business environment, WORKiO responds with advanced features that explore the full potential of network connectivity. By connecting DP-4510 to a sophisticated enterprise console system, WORKiO's Console Management System can help preempt issues that diminish productivity. ■

"smart" economy and efficiency

The addition of an optional hard disk drive unit enables document storage in secure and personalised space in DP-4510 for later retrieval. Output of frequently used documents can be easily obtained without searching for an original paper document to copy or reprinting the file from the PC. Intelligent Job Control Management is another important benefit of the new WORKiO series. The enhanced GUI lets users view the print queue and approximate job times, and delete individual print or copy jobs if necessary. If on a network, the administrator can monitor device status with the job queue and other WORKiO controls, and also set up or configure the system. Also easy-to-install optional Network Accounting Software can track and provide detailed logs on the volume of WORKiO utilisation by individual users and by departments. ■

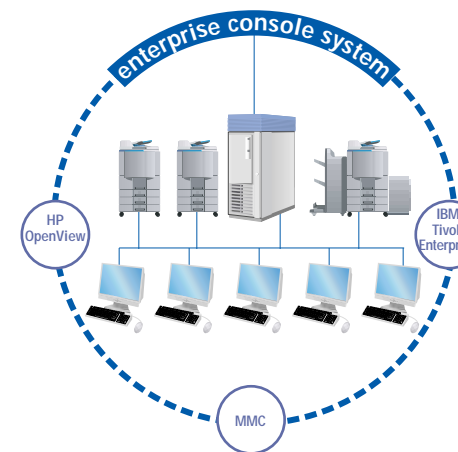

systematic issue identification and resolution

Enterprise console systems help maintain peak system performance and availability while reducing support costs in a corporate computing environment. Incorporating MetaConsole technology licensed from Netaphor Software, WORKiO can be set up as a device that can be managed by popular Enterprise Console Systems such as HP OpenView, IBM Tivoli Enterprise, and Microsoft Management Console (MMC).

*MetaConsole™ is a registered trademark of Netaphor™ Software Inc.

*Tivoli™ is a registered trademark of IBM Corporation.

print data storage box

Mail Box™ or Security Box™ space on the optional hard disk can be assigned to a maximum of 100 users for storage of printing data inside the WORKiO DP-4510. Data is sent from the user's PC to the Mail/Security Box for later printing. The security of 8-digit User IDs and 4-digit passwords is available to protect sensitive documents.

*3 Optional Hard Disk Drive Unit is required.

Step 1:

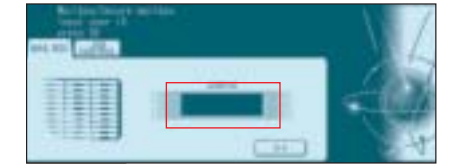

Enter your User ID under the "Mail Box" menu.

Step 2:



Select "Mailbox" to gain access to your personalised disk space.

Step 3:



Select the desired job run, and press "Print".

WORKiO Solutions

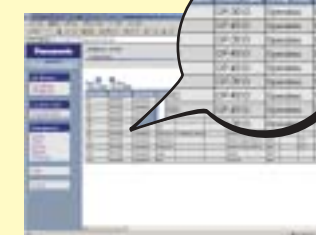

Network Accounting Software is server-based software that collects log information from network printing devices. Comprehensive logs include document name, client host name, user name, paper size, number of sheets, number of sides and other information useful for evaluation of device utilisation. In addition to providing tabulated reports and various output options, data can be easily exported in CSV format for examination in popular spreadsheet applications.

WORKiO – the Scanning & Document Distribution Solution

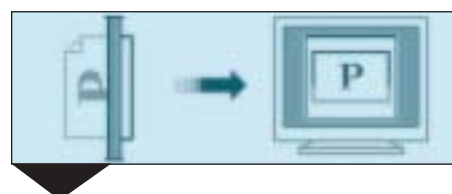
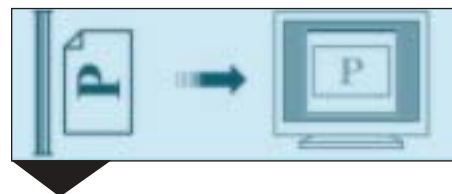

powerful distribution options at your fingertips

Friendly WORKiO GUI guides users through every step of the scanning and document distribution process. For example, even after pressing start, the interface keeps the user informed of the progress of the scanning job with an animated graphic.

high-speed network scanning

WORKiO DP-4510 is also a high-speed scanning solution. Equipped with an inverting ADF unit (70-page capacity), it can automatically perform double-side scanning of documents as large as A3 size. Scanned documents can later be printed out at quality comparable to the original document thanks to high-resolution scanning at 600 x 600dpi with 256 levels of gray scale. ■

network scanning versatility

When the optional Network Scanning Module is combined with WORKiO built-in network connectivity, DP-4510 becomes a powerful multi-protocol network scanner that revolutionises document distribution. Instead of copying documents and then delivering them around the office by hand, network scanning and the intuitive WORKiO interface make it easy to send scanned documents to specified PC "Scan to PC" or Server "Scan to Server" on the LAN. ■

desktop document management

WORKiO not only gets documents into the digital flow faster with high-speed scanning, but also provides Document Manager software for efficient management, editing and sharing of scanned documents. For very large-scale document management based on a client-server model, the optional DD Server System takes your business a major step closer toward realising paperless document management. ■

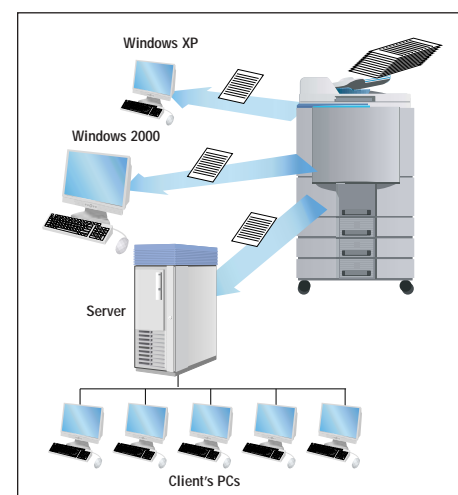

multiprotocol, multinet network design

Broad OS compatibility ensures LAN clients using Windows® XP/2000/98/Me and even Windows NT can all take advantage of the versatile "Push-type" network scanning capability of WORKiO DP-4510.

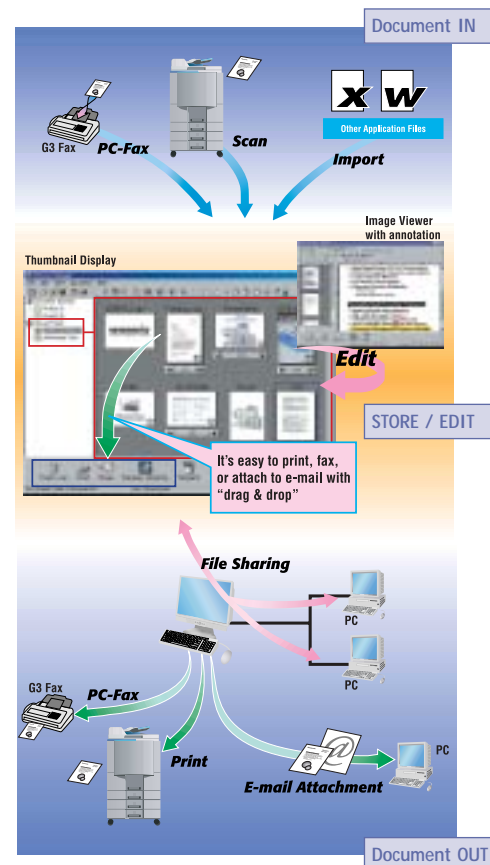

scanned document management

When a scanned document arrives, Document Manager notifies the user and automatically opens it. Image Viewer enables the user to easily view, annotate or attach memos to the file. With "drag and drop" simplicity, users can manage and edit documents from their desktop PC, and even share them with other PCs.

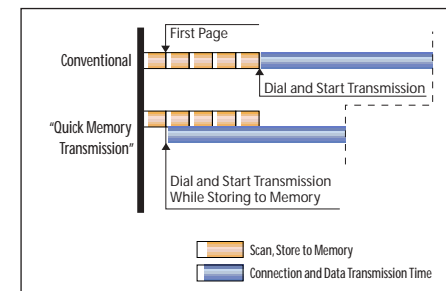

"Quick Memory Transmission"

For fax transmission of multiple pages, WORKiO begins transmission while scanning pages.



Super G3 and JBIG compression

Super G3 is the new fax communication speed standard available in high-end business fax machines. WORKiO fax module also has JBIG compression for more efficient compression of images at higher resolution, resulting in smaller files, faster transmission and superior output.



one-touch document routing

WORKiO's Address Book allows registration of up to 1,000 addresses (optional hard disk drive unit required.) Fax numbers, e-mail addresses as well as network addresses can be easily registered using the "soft" keyboard. Also a handy utility supports easy creation of a standardised e-mail header.

fast faxing

Transform WORKiO DP-4510 into a high-performance fax station. The optional fax communication kit adds fast 33.6 kbps Super G3 fax capability accelerated by 0.7-sec "Quick Scanning" for shorter prep time and Quick Memory Transmission. High 600 x 600 dpi communication resolution preserves the high scanning resolution of WORKiO for accurate reproduction at the destination. ■

internet faxing

With the Internet Fax/E-mail option, WORKiO is equipped to deliver cutting-edge document distribution solutions to your business. Documents are scanned as TIFF-F image files and then transmitted as e-mail attachments. For example, with the "Send to E-mail" feature, scanned documents can be directly sent from the WORKiO DP-4510 to other Internet Fax-capable platforms or even multiple e-mail clients anywhere in the world. Simultaneous distribution of the same document to multiple e-mail clients and G3 fax terminals is easy using the "Mixed Broadcast" feature and convenient fax/e-mail utilities like the WORKiO Address Book. ■

gateway to "paperless" productivity

WORKiO's Internet Fax/E-mail option also provides the platform with a fax/e-mail gateway function. Incoming faxes can be automatically routed to the designated recipient's e-mail inbox where the attached image file can be easily opened and viewed with a standard image viewer such as "Imaging for Windows". Also with the optional fax communication kit and Panafax Desktop software, users can send documents directly from their PC via the LAN and WORKiO gateway to G3 fax machines around the world. ■

DD Server Software

Saving paper and reducing storage space needs, DD Server software is easily installed in a file server for more efficient network document sharing. Using the optional DD Server software, documents are scanned with WORKiO's ADF and sent to the server for storage. At the same time, a single cover sheet stamped with the DD bar code to identify the scanned document is printed out for filing by the user. Later users can quickly retrieve and print out the entire document just by scanning the DD code-stamped cover sheet.

Step 1:

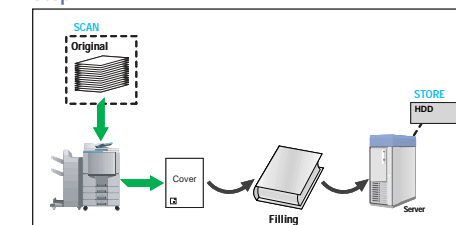

Original document is scanned, and WORKiO sends the entire document in digitised form to the DD Server. It also prints out a single cover sheet with a special DD code. This ID cover sheet is filed by the user.

Step 2:

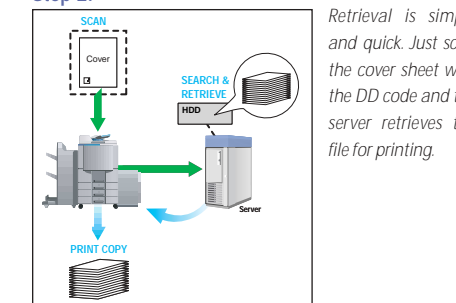

Retrieval is simple and quick. Just scan the cover sheet with the DD code and the server retrieves the file for printing.

Panafax Desktop software

PC Fax lets users send documents from their PCs directly to fax machines. By eliminating the step of printing out a hard copy and then running it through the fax machine, PC Fax can save valuable paper, labor and time.

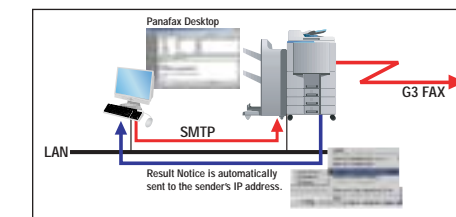

WORKiO Solutions

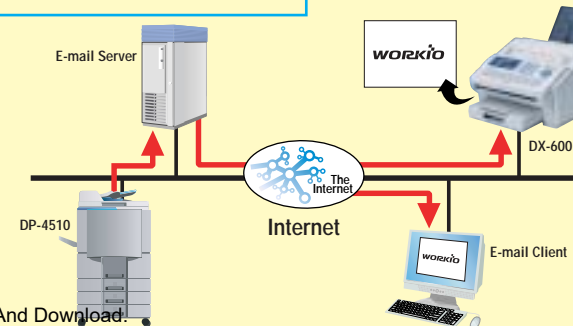

Standard in the latest Panafax models and available as an option on many WORKiO multifunction platforms, Internet faxing offers incredible economy and versatility. IP-based fax capability is one of the key components of WORKiO's next-generation document distribution network.



Service friendly

Full-front access is one of the distinctive design features of WORKiO's "service-friendly" concept.



Changing the toner bottle is as easy as opening the front panel door.



Toner bottle swings out of the way and the entire printer engine slides out for easy access to service core components, letting you quickly take care of problems like misfeeds.

the solution you can depend on

Reliability is always top priority for WORKiO. Especially in the case of a multifunction digital hub, we know that any downtime can be costly. For this reason, every aspect of the WORKiO DP-4510 from its extra rugged chassis and high-reliability copier/printer engine to the long service life of the drum and other periodically replaced parts, is engineered to last. ■

service-friendly

The full front-access design of the WORKiO DP-4510 reduces time required for a wide range of servicing tasks from routine toner replacement to the occasional clearing of misfeeds. This is just one of the many engineering improvements that make the care and maintenance of this platform easier. ■

Remote Maintenance System

By automatically reporting the status of toner level and various key mechatronics to a service centre, "Check & Call" can prevent costly downtime caused by simple problems like running out of toner or provide early warning of mechanical problems. Our remote maintenance system is also supported by a Remote Diagnostic System* that can take advantage of the WORKiO connectivity via telephone line or via the internet to enable technicians to quickly identify problems and provide solutions. ■

*These functions are not available in certain countries.

environment-friendly

Environment-friendly design is not just good corporate citizenship, it also makes good business sense. By using very little energy to get the job done and significantly reducing power in idle mode, the EnergyStar-compliant WORKiO contributes to lower TCO (Total Cost of Ownership). In sleep mode, energy needs drop to virtually nothing. Work environment is also quieter and cleaner thanks to reduced noise and ozone emissions. ■

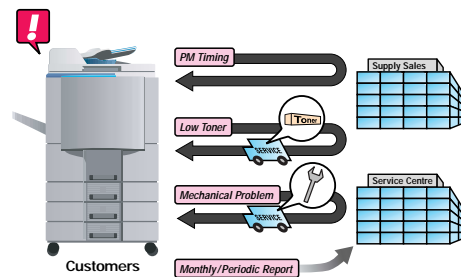

"Check & Call"

To prevent any interruptions in work, our convenient "Check and Call" system enables service centres to stay on top of your printer status and performance. For example, the built-in automatic report function lets us know when toner is running low or if any mechanical problems need attention.



WORKiO offers a wide range of options to build a custom configuration that precisely matches current needs or to upgrade functionality in the future as your business grows.

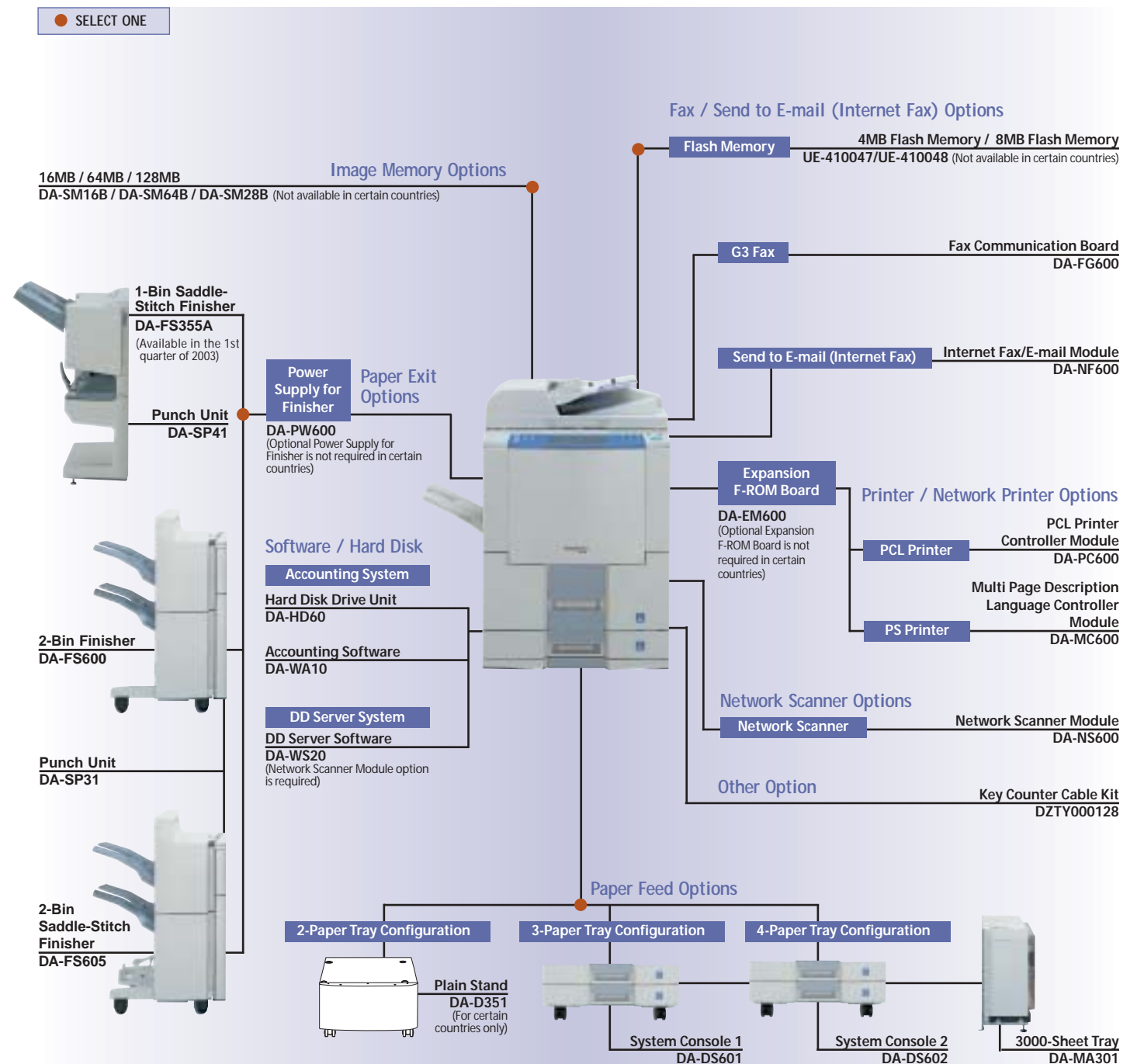

Free Manuals Download Website

<http://myh66.com>

<http://usermanuals.us>

<http://www.somanuals.com>

<http://www.4manuals.cc>

<http://www.manual-lib.com>

<http://www.404manual.com>

<http://www.luxmanual.com>

<http://aubethermostatmanual.com>

Golf course search by state

<http://golfingnear.com>

Email search by domain

<http://emailbydomain.com>

Auto manuals search

<http://auto.somanuals.com>

TV manuals search

<http://tv.somanuals.com>