

Panasonic

Operating Instructions

Check Printing Accountant™



MODEL NO.

KX-RC105



Please read before using.

Thank you for purchasing the Panasonic Check Printing Accountant
KX-RC105

Note:

This equipment has been tested and found to comply with the limits for a Class B digital device, pursuant to Part 15 of the FCC Rules. These limits are designed to provide reasonable protection against harmful interference in a residential installation. This equipment generates, uses and can radiate radio frequency energy and, if not installed and used in accordance with the instructions, may cause harmful interference to radio communications. However, there is no guarantee that interference will not occur in a particular installation. If this equipment does cause harmful interference to radio or television reception, which can be determined by turning the equipment off and on, the user is encouraged to try to correct the interference by one or more of the following measures:

Reorient or relocate the receiving antenna.

Increase the separation between the equipment and receiver.

Connect the equipment into an outlet on a circuit different from that to which the receiver is connected.

Consult the dealer or an experienced radio/TV technician for help.

FCC Warning: To assure continued FCC compliance, the user must use only shielded interfacing cables when connecting to computer or peripheral. Also, any unauthorized changes or modifications to this equipment would void the user's authority to operate.

CAUTION: AC ADAPTOR (KX-WZ4) IS FOR INDOOR USE ONLY.

Caution, since your Check Printing Accountant has been designed to hold your personal checks, you should be as careful as you would be of your checkbook. If you should lose your Check Printing Accountant, be sure to notify your bank as to the numbers of the lost checks.

NOTICE

- Panasonic strongly recommends that separate permanent written records be kept of all important data. Data may be lost or altered in virtually any electronic memory product under certain circumstances. Panasonic assumes no responsibility for data lost or otherwise rendered unusable for any reason, including without limitation, defect, repair, improper use, battery replacement, use after the specified battery life has expired, or any other reason. See limited warranty for details.
- Panasonic assumes no responsibility, directly or indirectly, for financial losses or claims from third persons resulting from the use, loss or misuse of this product.

**WARNING: TO PREVENT FIRE OR SHOCK HAZARD,
DO NOT EXPOSE THIS PRODUCT TO RAIN
OR ANY TYPE OF MOISTURE**

- It is recommended that you periodically print the content of the memory of your Check Printing Accountant, so that you will have a permanent record in the event of any unexpected memory loss.

The serial number of this unit may be found on the upper label located on the back side.

Write this number below and keep this book along with your proof of purchase to serve as a permanent record of your purchase or for future reference.

MODEL NO KX-RC105
SERIAL NO _____
NAME OF DEALER _____
ADDRESS OF DEALER _____
DATE OF PURCHASE _____

Enjoy the Convenient Functions of Your Check Printing Accountant! (CPA)

CHECK Function

Hand-writing a check is no longer necessary

Enter the necessary data and CPA prints the check CPA also balances your checking account



CARD Function

Whenever you pay with a credit card enter the data and CPA adds up the amount of each credit card payment

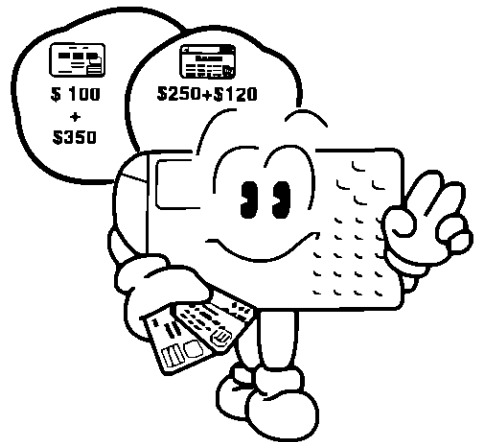

Enjoy the Convenient Functions of Your Check Printing Accountant! (CPA)

CASH Function

When paying in cash enter the data

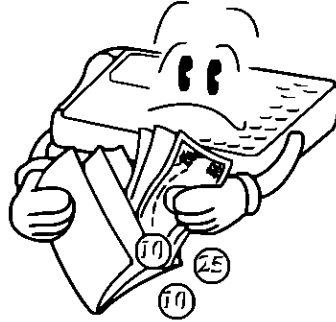

CALCULATION Function

Use CPA as a pocket calculator

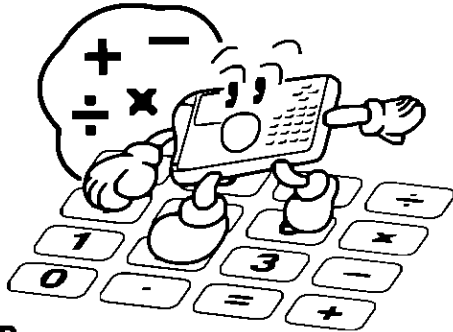

ADDRESS LIST Function

Use CPA as an address directory

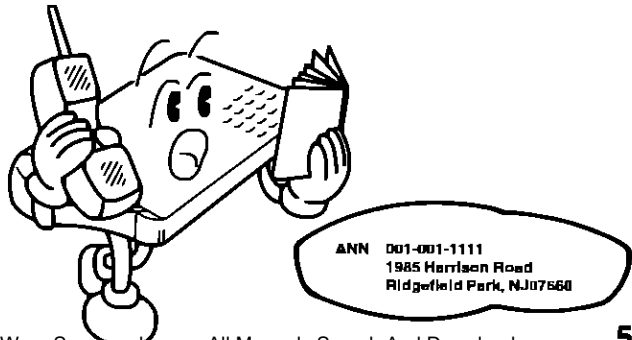

Accessories

Make sure that the following accessories are included with CPA.

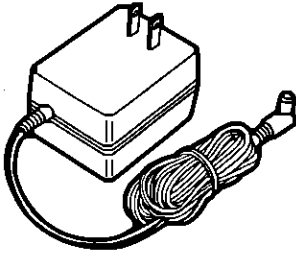

AC adaptor (p. 12) one

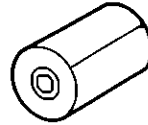

Paper roll (p. 78) one

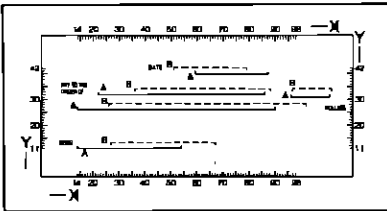

Template (p. 26) one

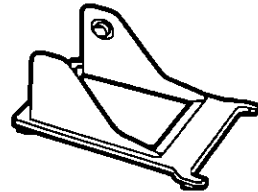

Paper feeder (p. 78) one

Printed material

Operating instructions one

Payee list card
(found on the back
of CPA) one

Quick start guide one

Sample sheet three

Important!

Before using, remove the protective sheet from CPA.

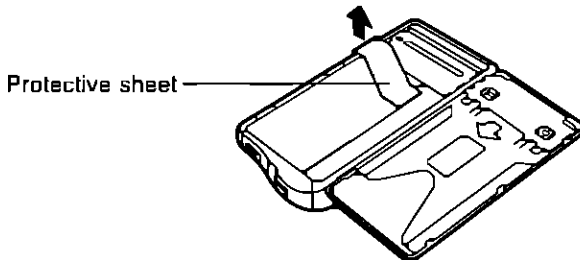

Table of Contents

	Page	
Precautions	8	
Chapter 1 Before Using	9	1
Chapter 2 Preparation	15	2
Chapter 3 CHECK Function	21	3
Chapter 4 CARD Function	49	4
Chapter 5 CASH Function	59	5
Chapter 6 CALCULATOR Function	65	6
Chapter 7 ADDRESS LIST Function	69	7
Chapter 8 REPORT Function	77	8
Chapter 9 Other Functions	93	9
Chapter 10 Transferring Data to Another CPA Unit	101	10
Chapter 11 General Information	109	11
Chapter 12 Appendix	119	12

Precautions



Do not keep CPA in your back pocket as it may break when you sit down

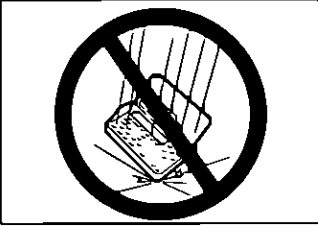

Do not drop or jar CPA

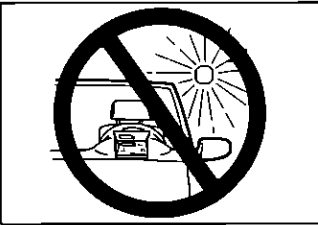

Do not place CPA where it will be exposed to direct sunlight or heat, especially in an automobile



To prevent electric shock, do not remove any screws
Your stored data may be erased



Use only a soft, dry cloth to clean CPA
Water or cleaning fluids may damage the case or electronic circuitry

Chapter 1

Before Using

	Page
Part Names	10
Front view	10
Printer parts	10
Keyboard	11
Power Supply	12
From household AC	12
Using the rechargeable Ni-Cd battery	12

Part Names

Front view

1
Before Using

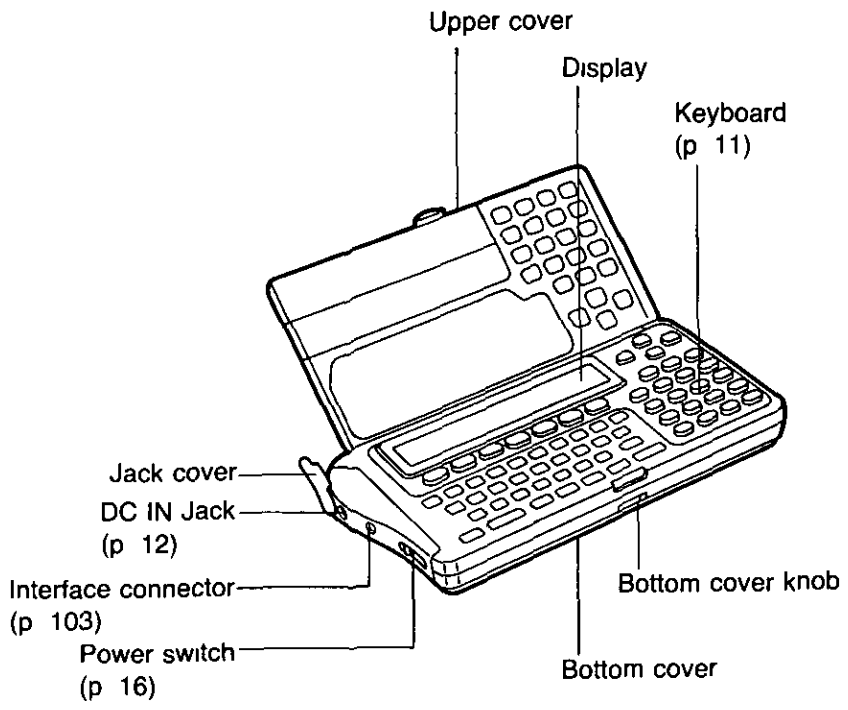

Printer parts

(Bottom side)

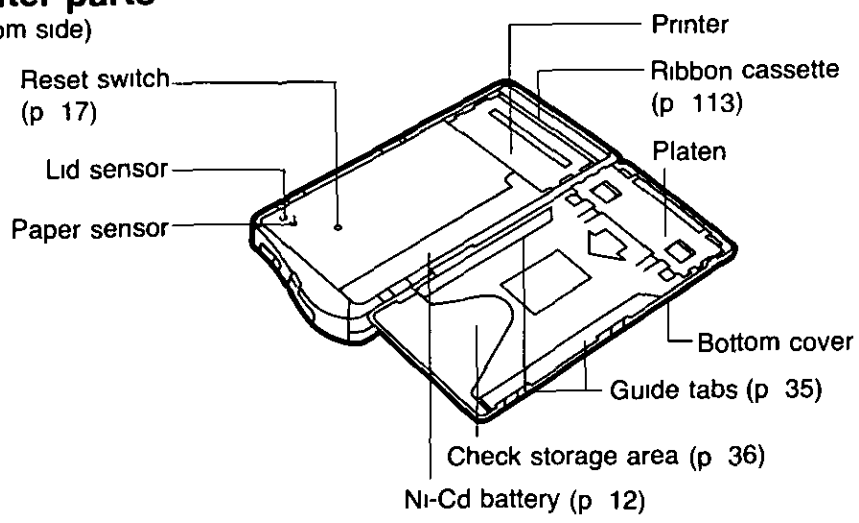

Keyboard

Function keys

- CHECK key (p 21)
- CARD key (p 49)
- CASH key (p 59)
- CALC key (p 65)
- ADDRESS key (p 69)
- PRINT key (p 37)
- ENTER key

Cursor keys: To move the cursor

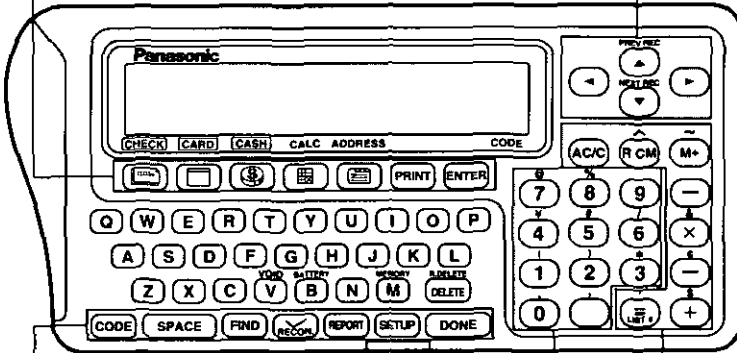

Figure keys: To enter numerical values

Calculation keys: Used for calculations

Sub function keys

- CODE key To enter special functions,
combined with other keys (p 123)
- SPACE key To enter a space
- FIND key (p 43)
- RECON key (p 45)
- REPORT key (p 77)
- SETUP key To begin setting up functions
- DONE key To finish an operation and to return
to the initial display (current time)
- DELETE key To delete a letter/number
under the cursor

Power Supply

CPA has two power sources:

- Household AC (AC 120 V)
- Rechargeable Ni-Cd battery (built-in CPA)

1

From household AC

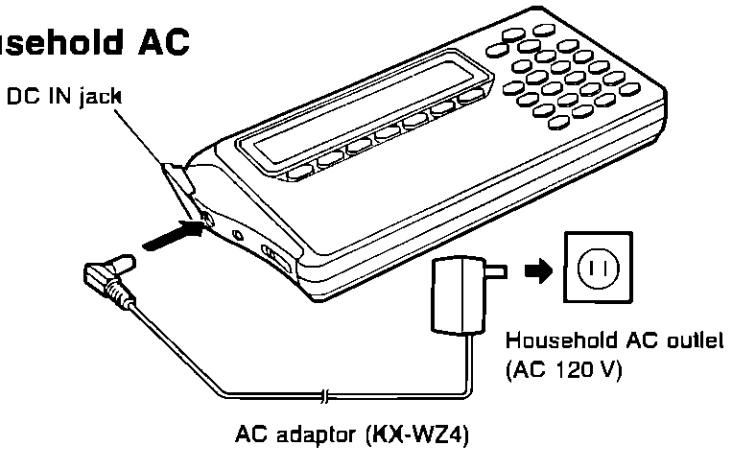

CAUTION:

Use only the supplied AC adaptor.
Other adaptors may damage CPA.

Using the rechargeable Ni-Cd battery

When connected to household AC as illustrated above, the built-in Ni-Cd battery automatically charges itself.

A full battery charge requires about three (3) hours.

After charging, disconnect the AC adaptor from CPA and the AC outlet. CPA can now be operated from battery power.

The printing capability of the fully charged battery is about 50 sheets for check printing or about 35 pages for report printing at 25°C (77°F).

For "Showing Remaining Battery Power", refer to p. 94.

Notes about the rechargeable battery:

- Before initial use, or use after a long period of time (about 6 months), recharge CPA for about three (3) hours
- When the display shows "WEAK NI-CD BATTERY" several sheets of check can be printed but recharge CPA soon
- When the display shows "RECHARGE NI-CD BATTERY" CPA will not print Recharge CPA soon
- When the display shows "INSERT AC ADAPTOR", the keys will not function Recharge CPA soon
- Repetitive short-term recharging and discharging makes the battery life shorter than usual and/or the remaining battery power may be shown incorrectly To solve it, continue operating CPA until the display shows "WEAK NI-CD BATTERY" then recharge it For about 30 minutes after the display shows "WEAK NI-CD BATTERY", CPA refreshes the battery automatically During it, recharging battery is not possible Recharge CPA for about three (3) hours including above refreshing period of time
- The battery drains excessively when used under unusually high or low temperature Also, when CPA is left in an automobile for a long period of time the battery will weaken and the battery life shortens Use CPA within an appropriate temperature range of 5°C (41°F) to 35°C (95°F)
- If CPA remains unused for several months or more, the remaining battery power shows incorrectly The battery has become inactive Continue operating CPA until the display shows "WEAK NI-CD BATTERY" Recharge the battery for about three (3) hours
- When you find the printable number of checks reduced after repetitive recharging, the battery life is exhausted Purchase a new battery pack (KX-RC30) from your dealer

Power Supply

ATTENTION:

The product that you have purchased contains a rechargeable battery. The battery is recyclable. At the end of its useful life, under various state and local laws, it may be illegal to dispose of this battery into the municipal waste stream. Check with your local solid waste officials for details in your area for recycling options or proper disposal.



Ni-Cd

Chapter 2

Preparation

	Page
Connecting CPA to Household AC	16
Turning On/Turning Off CPA	16
Resetting CPA	17
Setting the Clock	19
Adjusting Display Contrast	20

Connecting CPA to Household AC

Before operating CPA connect it to the household AC outlet (AC 120 V) with the AC adaptor for about three (3) hours in order to charge the battery. (While charging you can operate CPA. However, it will take longer for it to charge.)

For details about recharging refer to p. 12.

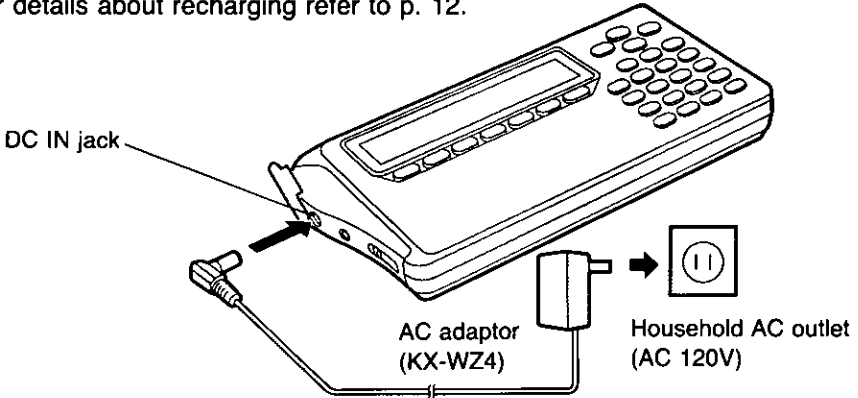

Turning On/Turning Off CPA

To turn on CPA, slide the power switch in the direction of the arrow for about one (1) second, until the display appears.

To turn off CPA, slide the power switch again in the same direction until the display disappears.

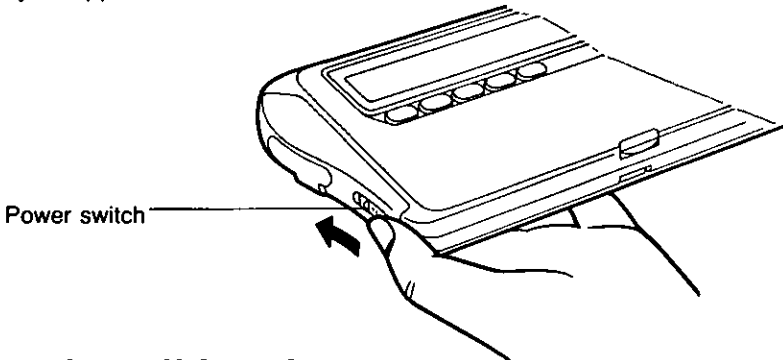

Auto shut-off function

If CPA is not in operation for more than 5 minutes while using battery power, it automatically shuts off to prevent battery drainage.

Turn the power switch on again to resume using CPA.

Resetting CPA

Before using CPA for the first time, resetting is necessary to clear the memory.

1. Be sure that the power is ON.
Open the upper cover by pulling the tab up gently.

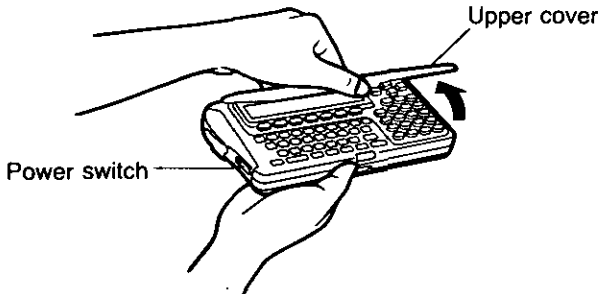

2. Open the bottom cover by sliding the bottom cover knob to the right.

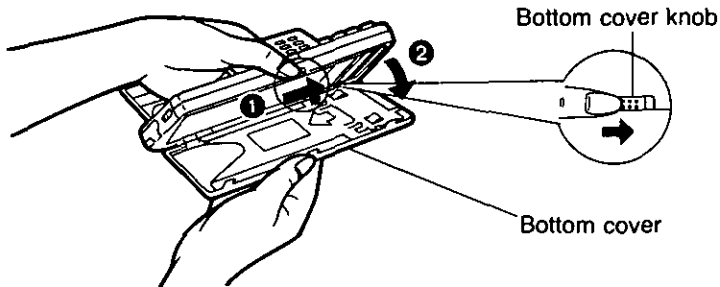

3. While pressing **DONE**, press the reset switch inside the bottom compartment of CPA with a sharp object like the point of a pen.

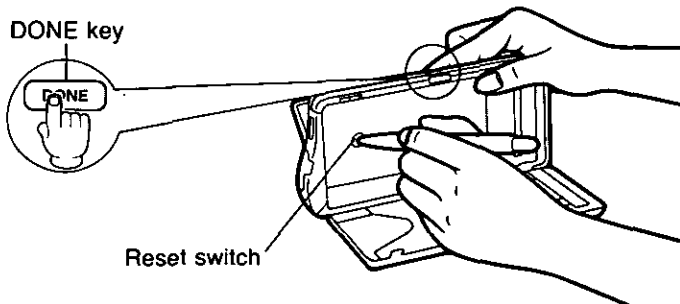

Resetting CPA

4. After pressing the reset switch, release **(DONE)**.
The display will show:

→ DELETE ALL DATA Y ?

5. Close the bottom cover.
(Press the "PRESS" mark.)

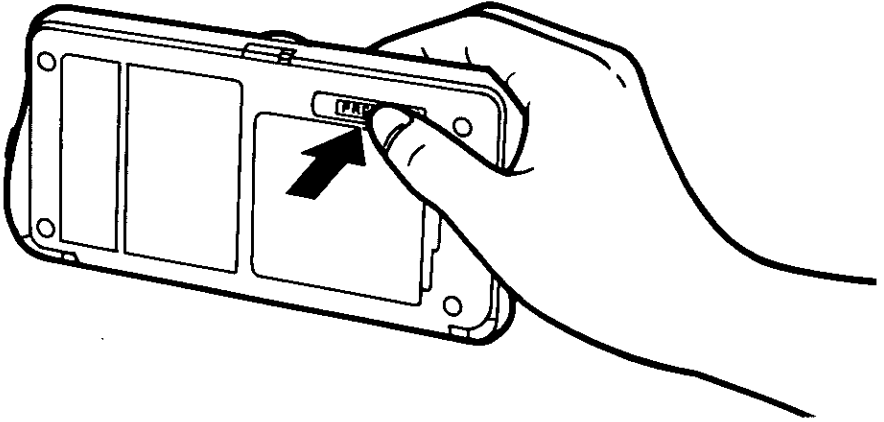

6. Press **(Y)** or **(▶)** to YES.

→ DELETE ALL DATA Y ?

7. Press **(ENTER)**.

→ WAIT . . .



after a few seconds

JAN. 01, 1993 FRI
12:00:00 AM

CAUTION: This operation clears the memory.
After it, the remaining battery power will be incorrectly displayed. Recharge CPA for about three (3) hours.

Setting the Clock

Before using CPA for the first time, set the clock.

Example: Setting "January 28, 1993, 10:30 AM".

	Operation	Display/Description						
1	<input type="button" value="SETUP"/>	<table><tr><td><input checked="" type="checkbox"/> DATE</td><td>CHECK</td><td>CARD</td></tr><tr><td>CONTRAST</td><td></td><td>MORE ↓</td></tr></table>	<input checked="" type="checkbox"/> DATE	CHECK	CARD	CONTRAST		MORE ↓
<input checked="" type="checkbox"/> DATE	CHECK	CARD						
CONTRAST		MORE ↓						
2	To select "DATE" press <input type="button" value="ENTER"/>	DATE: 01/01/93 TIME: 12:00 AM						
3	Enter month, day, and year. Example: <input type="button" value="0"/> <input type="button" value="1"/> <input type="button" value="2"/> <input type="button" value="8"/> <input type="button" value="9"/> <input type="button" value="3"/>	DATE: 01/28/93 TIME: 12:00 AM • Calendar runs from 1992 to 2091.						
4	<input type="button" value="ENTER"/>	DATE: 01/28/93 TIME: 12:00 AM						
5	Enter the hour and minute(s). Example: <input type="button" value="1"/> <input type="button" value="0"/> <input type="button" value="3"/> <input type="button" value="0"/>	DATE: 01/28/93 TIME: 10:30 AM						
6	<input type="button" value="ENTER"/>	DATE: 01/28/93 TIME: 10:30 AM/PM						
7	To select "AM" or "PM" press <input type="button" value="◀"/> or <input type="button" value="▶"/>	DATE: 01/28/93 TIME: 10:30 AM/PM						
8	To return to SETUP menu press <input type="button" value="ENTER"/>	<table><tr><td><input checked="" type="checkbox"/> DATE</td><td>CHECK</td><td>CARD</td></tr><tr><td>CONTRAST</td><td></td><td>MORE ↓</td></tr></table>	<input checked="" type="checkbox"/> DATE	CHECK	CARD	CONTRAST		MORE ↓
<input checked="" type="checkbox"/> DATE	CHECK	CARD						
CONTRAST		MORE ↓						
9	To return to initial display press <input type="button" value="DONE"/>	JAN. 28, 1993 THU 10:30:03 AM						

2

Preparation

Setting the Clock

- ☞ Correct mistakes either before or after entering numbers/letters.
- If you find a mistake before pressing **ENTER**, press **◀** / **▶**, then write the new entry over the old one.
 - If you find a mistake after pressing **ENTER**, press **▲** to move up, then write the new entry over the old one.
- To set the second at "0", press **ENTER** at the minute or AM/PM.

2

Preparation

Adjusting Display Contrast

Example: To make the display darker.

	Operation	Display/Description						
1	SETUP	<table border="1"> <tr> <td>DATE</td> <td>CHECK</td> <td>CARD</td> </tr> <tr> <td>CONTRAST</td> <td></td> <td>MORE ↓</td> </tr> </table>	DATE	CHECK	CARD	CONTRAST		MORE ↓
DATE	CHECK	CARD						
CONTRAST		MORE ↓						
2	To select "CONTRAST" press ▼	<table border="1"> <tr> <td>DATE</td> <td>CHECK</td> <td>CARD</td> </tr> <tr> <td>CONTRAST</td> <td></td> <td>MORE ↓</td> </tr> </table>	DATE	CHECK	CARD	CONTRAST		MORE ↓
DATE	CHECK	CARD						
CONTRAST		MORE ↓						
3	ENTER	<table border="1"> <tr> <td colspan="3" style="text-align: center;">LCD CONTRAST</td> </tr> <tr> <td>LIGHT</td> <td>■■■■■□□□□</td> <td>DARK</td> </tr> </table>	LCD CONTRAST			LIGHT	■■■■■□□□□	DARK
LCD CONTRAST								
LIGHT	■■■■■□□□□	DARK						
4	Select appropriate contrast. Example: Press ▶ twice.	<table border="1"> <tr> <td colspan="3" style="text-align: center;">LCD CONTRAST</td> </tr> <tr> <td>LIGHT</td> <td>■■■■■■■□□□</td> <td>DARK</td> </tr> </table> <p>• To make the display lighter, press ◀.</p>	LCD CONTRAST			LIGHT	■■■■■■■□□□	DARK
LCD CONTRAST								
LIGHT	■■■■■■■□□□	DARK						
5	To return to SETUP menu press ENTER .	<table border="1"> <tr> <td>DATE</td> <td>CHECK</td> <td>CARD</td> </tr> <tr> <td>CONTRAST</td> <td></td> <td>MORE ↓</td> </tr> </table>	DATE	CHECK	CARD	CONTRAST		MORE ↓
DATE	CHECK	CARD						
CONTRAST		MORE ↓						
6	To return to initial display press DONE .	<table border="1"> <tr> <td colspan="3" style="text-align: center;">JAN. 28, 1993 THU</td> </tr> <tr> <td colspan="3" style="text-align: center;">10:35:00 AM</td> </tr> </table>	JAN. 28, 1993 THU			10:35:00 AM		
JAN. 28, 1993 THU								
10:35:00 AM								

Chapter 3

CHECK Function

	Page
Entering Your Bank Name(s)	22
Making the Payee List	24
Setting Print Positions on Your Check	26
Entering Data for Each Check	31
Printing a Check	35
Entering Deposit Data	39
Searching a CHECK Record	43
Reconciling (✓) a Check	45
Voiding a Check After Issued	46
Deleting a CHECK Record	47
Entering Withdrawals/Service Charges	48

Entering Your Bank Name(s)

Two bank names can be entered

Confirm the checking account balances before entering it

Example. You have two checking accounts

- In the **FIRST** bank (Balance \$5000) → Primary bank
- In the **SECOND** bank (Balance \$3000)

3 CHECK Function

Operation

Display/Description

1

SETUP

<input type="checkbox"/> DATE	CHECK	CARD
CONTRAST		MORE ↓

2

To select "CHECK" press

▶

DATE	<input checked="" type="checkbox"/> CHECK	CARD
CONTRAST		MORE ↓

3

ENTER

NAME ACCT1	<input type="checkbox"/>
BAL ACCT1	\$0 00

4

Enter bank name
(up to 8 letters/numbers)
Example

F **I** **R** **S** **T**

NAME ACCT1	FIRST <input type="checkbox"/>
BAL ACCT1	\$0 00

- By pressing **ENTER** without entering a bank name, "ACCT1" is automatically entered

5

ENTER

NAME ACCT1	FIRST
BAL ACCT1	\$0 00

6

Enter current balance
(up to \$99,999 99)
Example

5 **0** **0** **0**

NAME ACCT1	FIRST
BAL ACCT1	\$5000 <input type="checkbox"/>

Entering Your Bank Name(s)

7

ENTER

NAME ACCT2
BAL ACCT2 \$0 00

- If only entering one bank name, press **DONE** to finish
- If entering a second bank name, proceed as follows

8

Enter second bank and balance by repeating steps 4 through 6 on p 22

NAME ACCT2 SECOND
BAL ACCT2 \$3000

9

ENTER

SELECT PRIMARY ACCT
 FIRST SECOND

10

To select primary bank press

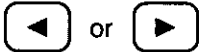

SELECT PRIMARY ACCT
 FIRST SECOND

11

ENTER

DATE CHECK CARD
CONTRAST MORE ↓

12

To return to initial display press

DONE

JAN 28, 1993 THU
10 40 03 AM

3

CHECK Function



Correct mistakes either before or after entering letters/numbers

- If you find a mistake before pressing **ENTER**, press / and **DELETE**. This clears the letter/number under the cursor
- If you find a mistake after pressing **ENTER**, press to move up then write the new entry over the old one

Making the Payee List

It is recommended that you make a payee list of those to whom you most frequently write checks. It makes entering CHECK data much easier. Enter up to 25 payee names each with memo.

Example: Entering payee name "PANA SHOP" into payee list number 1.

Operation

Display/Description

1

SETUP

DATE CHECK CARD
CONTRAST MORE ↓

2

To select "PAYLIST" press

▼

twice.

PAYLIST PRINTER LINK
PASSWORD MORE ↑

3

ENTER

PAYLIST 01: □
MEMO:

4

Enter payee's name
(up to 32 letters/numbers).
Example:

P A N A SPACE
S H O P

PAYLIST 01: PANA SHOP □
MEMO:

5

ENTER

PAYLIST 01: PANA SHOP
MEMO: □

6

Enter memo if necessary
(up to 20 letters/numbers).
Example:

E L E C T R O
N I C S

PAYLIST 01: PANA SHOP
MEMO: ELECTRONICS □

3

CHECK Function

7 **ENTER**

PAYLIST 02: <input type="checkbox"/>
MEMO:

8 If entering other payees and memos repeat steps 4 through 7 (up to 25 payees can be entered).

9 To return to SETUP menu press **DONE**.

PAYLIST	PRINTER	LINK
PASSWORD		MORE ↑

10 To return to initial display press **DONE**.

JAN. 28, 1993 THU
10:42:28 AM

-  Correct mistakes either before or after entering letters/numbers.
- If you find a mistake before pressing **ENTER**, press **◀** / **▶** and **DELETE**. This clears the letter/number under the cursor.
 - If you find a mistake after pressing **ENTER**, press **▲** to move up then write the new entry over the old one.
 - It is recommended that you memorize your payee list on the PAYEE LIST card attached on the back of CPA.

Setting Print Positions on Your Check

The following five (5) items out of the CHECK entries print at a specified position on a check:

- 1 DATE
- 2 PAY TO
- 3 AMOUNT
- 4 DOLLARS
- 5 MEMO

3 Deciding the print positions

CHECK Function

The check has its own print position for each item. By using the template included with CPA you can select two types of print position (A or B) and let CPA print data at proper positions closer to them. Place the template on top of your check adjusting left and bottom rulers with left and bottom ends of your check. Check to see where the above five (5) positions on your check correspond to on the template, "A" or "B".

When defaulted, the above print positions set at "A".

(Using the template ruler you can manually set other desired print positions. We discuss this on p. 29.)

Example of a check:

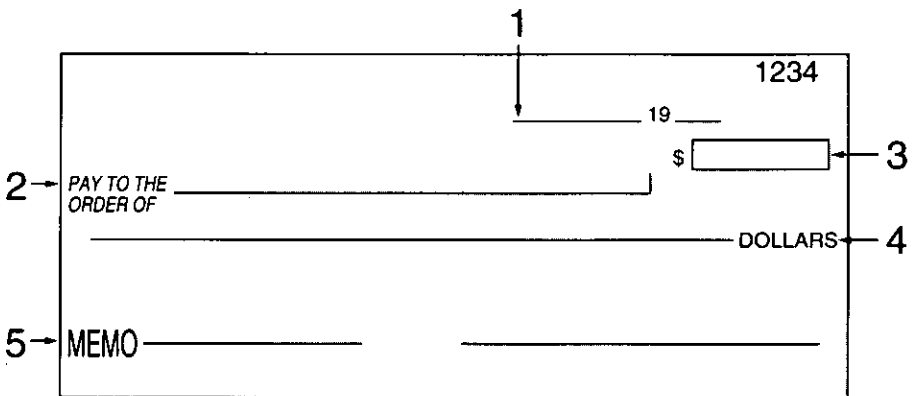

Setting Print Positions on Your Check

Example: Setting the "DATE" and "PAY TO" at the "B" position

	Operation	Display/Description						
1	[SETUP]	<table border="1"> <tr> <td>DATE</td> <td>CHECK</td> <td>CARD</td> </tr> <tr> <td>CONTRAST</td> <td></td> <td>MORE ↓</td> </tr> </table>	DATE	CHECK	CARD	CONTRAST		MORE ↓
DATE	CHECK	CARD						
CONTRAST		MORE ↓						
2	Press [▼] twice	<table border="1"> <tr> <td>PAYLIST</td> <td>PRINTER</td> <td>LINK</td> </tr> <tr> <td>PASSWORD</td> <td></td> <td>MORE ↑</td> </tr> </table>	PAYLIST	PRINTER	LINK	PASSWORD		MORE ↑
PAYLIST	PRINTER	LINK						
PASSWORD		MORE ↑						
3	To select "PRINTER" press [▶]	<table border="1"> <tr> <td>PAYLIST</td> <td>PRINTER</td> <td>LINK</td> </tr> <tr> <td>PASSWORD</td> <td></td> <td>MORE ↑</td> </tr> </table>	PAYLIST	P RINTER	LINK	PASSWORD		MORE ↑
PAYLIST	P RINTER	LINK						
PASSWORD		MORE ↑						
4	[ENTER]	<table border="1"> <tr> <td colspan="3">SELECT ACCOUNT</td> </tr> <tr> <td>ACT1</td> <td></td> <td>ACCT2</td> </tr> </table>	SELECT ACCOUNT			A CT1		ACCT2
SELECT ACCOUNT								
A CT1		ACCT2						
5	To select Account press [◀] or [▶]	<table border="1"> <tr> <td colspan="3">SELECT ACCOUNT</td> </tr> <tr> <td>ACT1</td> <td></td> <td>ACCT2</td> </tr> </table>	SELECT ACCOUNT			A CT1		ACCT2
SELECT ACCOUNT								
A CT1		ACCT2						
6	[ENTER]	<table border="1"> <tr> <td colspan="3">SELECT LOCATION</td> </tr> <tr> <td>DATE</td> <td>A</td> <td>B RULER</td> </tr> </table>	SELECT LOCATION			DATE	A	B RULER
SELECT LOCATION								
DATE	A	B RULER						
7	Select position of "DATE" Example select "B" by pressing [▶]	<table border="1"> <tr> <td colspan="3">SELECT LOCATION</td> </tr> <tr> <td>DATE</td> <td>A</td> <td>B RULER</td> </tr> </table>	SELECT LOCATION			DATE	A	B RULER
SELECT LOCATION								
DATE	A	B RULER						
8	[ENTER]	<table border="1"> <tr> <td>PAY TO</td> <td>A</td> <td>B RULER</td> </tr> <tr> <td>\$</td> <td>A</td> <td></td> </tr> </table>	PAY TO	A	B RULER	\$	A	
PAY TO	A	B RULER						
\$	A							

"DATE" position has been set at "B"

3 CHECK Function

Setting Print Positions on Your Check

- 9 Select position of "PAY TO"
Example select "B" by
pressing 

PAY TO	A	<input checked="" type="checkbox"/>	RULER
\$	A		

- When selecting "B" position for "PAY TO" and entering more than 25 letters/numbers for the name, it overlaps the \$ sign

3

CHECK Function

- 10 

PAY TO	B		RULER
\$	<input checked="" type="checkbox"/>	B	

"PAY TO" position has been set at "B"

- If changing another item repeat steps 7 and 8 on p 27

- 11 To return to SETUP menu
 three times

PAYLIST	<input checked="" type="checkbox"/>	PRINTER	LINK
PASSWORD			MORE ↑

- 12 To return to initial display press

JAN 28, 1993 THU
10 48 11 AM

Setting Print Positions on Your Check

When a position on your check corresponds to neither "A" nor "B":

Place the template on top of your check adjusting left and bottom rulers with left and bottom ends of your check.

Check to see where the **bottom-left point** of each of five (5) data items correspond to on the template ruler. Check height on the left or right side, and horizontal on the top or bottom.

Template ruler:

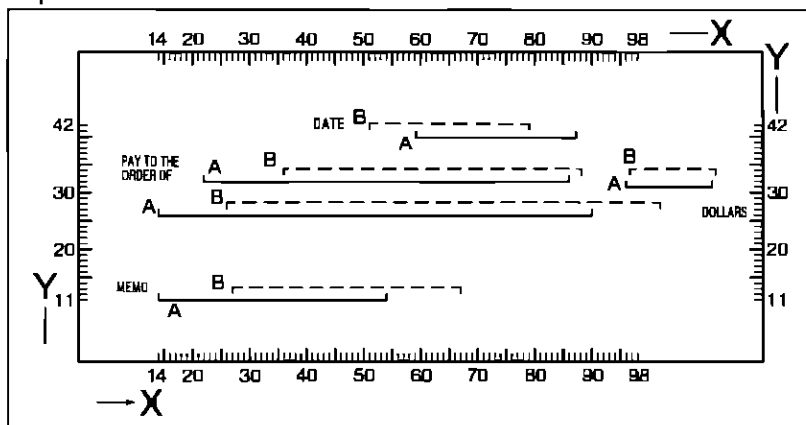

Example: Setting print position for "DATE" according to the template ruler (X=60, Y=39).

Operation

Display/Description

1 Repeat steps 1 through 6 on p. 27.

```
SELECT LOCATION
DATE : A B RULER
```

2 To select "RULER" press  twice.

```
SELECT LOCATION
DATE : A B RULER
```

3 

```
ENTER X,Y
DATE X=59 Y=40
```

Default of "A" position for "DATE".

Setting Print Positions on Your Check

4 Enter "X" and "Y" points
Example

6 0 3 9

ENTER X, Y
DATE X=60 Y=39

- By entering numbers not within the range (X, 14 to 98, Y, 11 to 42) setting of each of the five (5) items, the display automatically shows "X=14, Y=11"

5 ENTER

PAY TO A B RULER
\$ A

6 To return to SETUP menu
press DONE

PAYLIST PRINTER LINK
PASSWORD MORE ↑

7 To return to initial display press
DONE

JAN 28, 1993 THU
11 03 33 AM



Correct mistakes either before or after entering letters/numbers

- If you find a mistake before pressing **ENTER**, press **◀** / **▶** and **DELETE**. This clears the letter/number under the cursor
- If you find a mistake after pressing **ENTER**, press **▲** to move up then write the new entry over the old one

Entering Data for Each Check

Have you finished setting the clock (p. 19), entering your bank name(s) (p. 22), making the payee list (p. 24), and setting the print position (p. 26)?

Before issuing a check, enter the following data:

- **PAY TO** : Can be selected from the payee list
- **DATE**
- **CHECK#**
- **CLASS** : Business, Personal or Others
- **TAX** : Tax-related or No tax-related
- **CATEGORY** : Can be selected from the category list (p. 125)
- **MEMO** : Automatically entered if "PAY TO" is selected from the payee list
- **AMOUNT**

Example: Suppose you purchased a CD player at a PANA SHOP as a birthday gift. It costs \$300. You issue check #1426 for it.

Operation

Display/Description

1

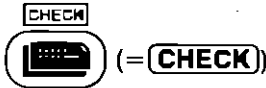

PAY TO	DEPOSIT
FIRST	BAL: \$5000.00

2

To select "PAY TO" press



PAY TO	BAL: \$5000.00
F IRST	

Bank name selected as the primary bank Balance

- If issuing a check from your second bank, press **CHECK**.

3

To enter "PAY TO" press



PAY TO: □	
DATE: 01/29/93	CHK#: 1

- If a payee is not on the "PAY TO" list, enter it manually (up to 32 letters/numbers). Go to step 7 on p. 32.

3

CHECK Function

Entering Data for Each Check

4

LIST #

LIST#	<input type="text" value=""/>
DATE	01/29/93 CHK# 1

5

Enter payee number from list
Example

LIST#	1 <input type="text" value=""/>
DATE	01/29/93 CHK# 1

6



Confirm payee's name and memo

PAYLIST 01	<input type="text" value="PANA SHOP"/>
MEMO	ELECTRONICS

- To select another payee from the list, press
The list can not be modified here

7



Confirm data

PAY TO	PANA SHOP
DATE	<input type="text" value="01"/> /29/93 CHK# 1

- To correct the date, rewrite by entering the desired month, day, and year (see p 19)

8

PAY TO	PANA SHOP
DATE	01/29/93 CHK# <input type="text" value="1"/>

9

Enter check number
Example

PAY TO	PANA SHOP
DATE	01/29/93 CHK# 1426

- Counting will start from the next number

NOTE: When you withdraw your money from your bank, enter 0 (zero) as check number to adjust the balance

10

CLASS	<input type="text" value="B"/> <input type="text" value="P"/> <input type="text" value="O"/>	TAX	N
CATEGORY	MISC		

3

CHECK Function

11 To select "CLASS" press



or



CLASS	B	P	O	TAX	N
CATEGORY	MISC				

B Business
P Personal
O Others

12



CLASS	P	TAX	N	Y ?
CATEGORY	MISC			

13

To select "TAX" press



or



CLASS	P	TAX	N	Y ?
CATEGORY	MISC			

N No tax-related
Y Tax-related

14



CLASS	P	TAX	N
CATEGORY	MISC		

15

Select a category from the list on p 125



Example GIFTS

To display first category under "G" press



To display next category (GIFTS) press



CLASS	P	TAX	N
CATEGORY	GIFT	RECVD	

CLASS	P	TAX	N
CATEGORY	GIFTS		

Entering Data for Each Check

16

ENTER

↓
Confirm memo

MEMO ELECTRONICS
AMOUNT \$

“MEMO” entered from the payees list

- If “PAY TO” was not selected from the payee list, “MEMO” is blank Enter desired memo

17

ENTER

MEMO ELECTRONICS
AMOUNT \$

18

Enter amount
(up to \$99,999 99)
Example

MEMO ELECTRONICS
AMOUNT \$300

- AMOUNT value can be cleared by pressing **AC/C**

19

ENTER

↓
Confirm each item

01/29/93 1426 PANA SHOP
ELECTR \$300 00

Summarized display of the CHECK record

- This display can not be modified

20

To finish process press

ENTER

END OF TRANSACTION
PRESS PRINT/CHECK KEY

• If you will print the check, proceed to “Printing a Check” on the next page.

If required, you can print checks later by following “Searching a CHECK Record” on p 43 to 44

• If you want to enter the data for other checks continuously, press **CHECK** and repeat steps 2 through 20.

Entering Data for Each Check

-  Correct mistakes either before or after entering letters/numbers.
- If you find a mistake before pressing **ENTER**, press **◀** / **▶** and **DELETE**. This clears the letter/number under the cursor.
 - If you find a mistake after pressing **ENTER**, press **▲** to move up then write the new entry over the old one.
- If amount is zero (0), the data can not be entered in memory.

Printing a Check

Before printing put a check into CPA.

NOTE: A check with duplicate copies cannot be printed.

Use standard wallet-sized checks. {2¾"×6" (Max. 225/32"×61/16")}

- 1.** Open the bottom cover by sliding the bottom cover knob to the right.

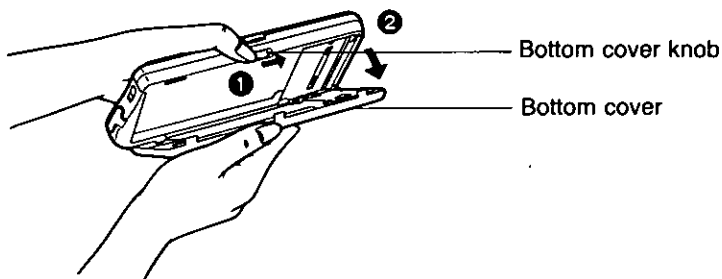

- 2.** Insert only one check under the guide tabs until you feel some resistance.
- NOTE:** Make sure that the check number is correspond to CHK# of the data.

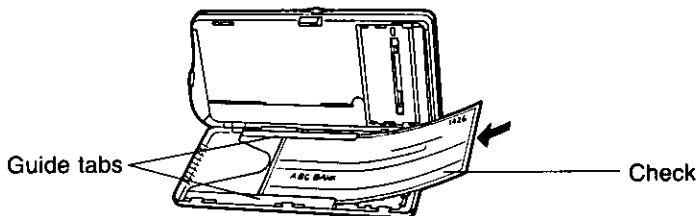

Align the bottom edge of the check with the bottom side of the guide tab.

Printing a Check

3. Close the bottom cover.
(Press the "PRESS" mark.)

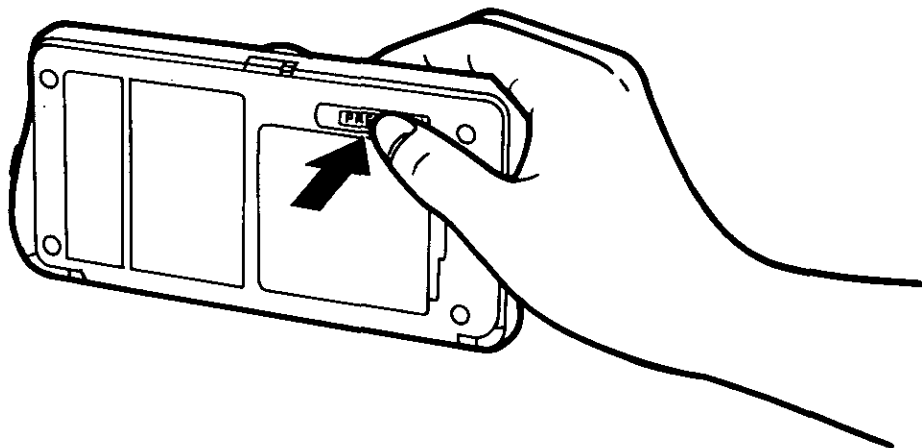

3

CHECK Function

Preparation for check printing is finished.
Proceed to the next page for printing instructions.

Inside the bottom cover is a check storage area where you can store up to 25 separate checks. Stack them from the smallest number check on the top to the largest number check on the bottom and to insert less than 12 or 13 checks at one time. This eliminates possible errors in check number and order.

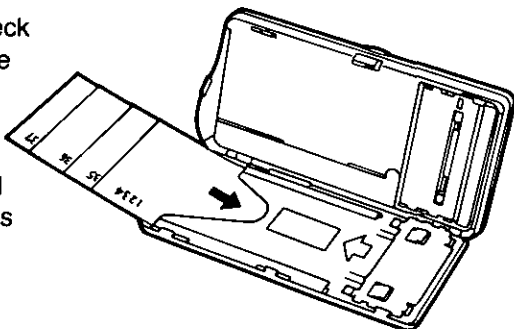

Now let's print.

Operation

When finished entering the necessary data this display appears.

1

PRINT

2

▶ or **Y**

3

ENTER

When printing has finished this display appears.

4

To return to initial display press

DONE

Display/Description

END OF TRANSACTION
PRESS PRINT/CHECK KEY

•Make sure that the check is inserted.

PRINT CHECK **N/Y** ?

PRINT CHECK **N/Y** ?

N: To cancel
Y: To execute

PRINTING...
PLEASE ENDORSE CHECK!

Printing begins.

PAY TO	DEPOSIT
FIRST	BAL: \$4700.00

JAN. 29, 1993 FRI
01:26:00 PM

3

CHECK Function

 •To stop the printing halfway through, press **DONE**. The display shows " *PRINT CANCELED* ".

Printing a Check

When an error occurs printing will not begin. If it has begun, it stops halfway through.

Display

Cause

CHECK NOT INSERTED
CONTINUE N/Y ?

A check has not been placed inside the printing area.

* PRINTER ERROR *
CANNOT PRINT A DEPOSIT

You cannot print the deposit data.

* PRINTER ERROR *
CHECK ALREADY PRINTED

This check has already been printed.

* PRINTER ERROR *
CHECK IS VOIDED

This check has been voided.

* PRINTER ERROR *
COVER OPEN

The cover is open.

* PRINTER ERROR *
PRINTER NOT READY

Something is wrong with the printer.

Entering Deposit Data

The amount of the deposit is automatically added to the balance of the checking account. You need not worry about looking up the previous balance, adding the new deposit on, and entering a new balance.

Have you finished setting the clock (p 19), entering your bank names (p 22)?

Whenever you deposit money into your checking account, enter the following data:

- DESCRIPTION
- DATE
- CLASS Business, Personal or Others
- TAX Tax-related or No tax-related
- CATEGORY Can be selected from the category list (p 125)
- MEMO
- AMOUNT



Example: You deposit your salary, \$4000, into your FIRST bank checking account on January 30, 1993

Operation

Display/Description

1  (= **CHECK**)

PAY TO		DEPOSIT
FIRST	BAL	\$4700 00

2 To select "DEPOSIT" press  or 

PAY TO		<input checked="" type="checkbox"/> DEPOSIT
FIRST	BAL	\$4700 00

3 

<input checked="" type="checkbox"/> FIRST	BAL	DEPOSIT
		\$4700 00

If you select the second bank you entered, press **CHECK** Balance

- The balance displayed may differ from the actual balance due to a commission subtracted or interest added. Please check your bank records.
- The balance can only be modified from the SETUP

Entering Deposit Data

4

ENTER

DESCRP:
DATE: 01/30/93

5

Enter type of deposit in description area, if necessary.

Example:

S A L A R Y

DESCRP: SALARY
DATE: 01/30/93

6

ENTER



Confirm data.

DESCRP: SALARY
DATE: 01/30/93

• To correct it, rewrite over it by entering the desired month, day, and year (see p. 19).

7

ENTER

CLASS: B/P/O TAX: N
CATEGORY: MISC

8

To select "CLASS" press

◀ / ▶

or

B / P / O

CLASS: B/P/O TAX: N
CATEGORY: MISC

B: Business

P: Personal

O: Others

9

ENTER

CLASS: P TAX: ~~N~~Y ?
CATEGORY: MISC

10

To select "TAX" press

◀ / ▶

or

N / Y

CLASS: P TAX: N/Y ?
CATEGORY: MISC

N: No tax-related

Y: Tax-related

11

ENTER

CLASS: P TAX: Y
CATEGORY: MISC

3

CHECK Function

12

Select category
from the list on p. 125.



Example: SALARY
To display first category under
"S" press

S

CLASS: P	TAX: Y
CATEGORY: SALARY <input type="checkbox"/>	

13

ENTER

MEMO: <input type="checkbox"/>
AMOUNT: \$

14

Enter memo, if necessary
(up to 20 letters/numbers).

Example:

J A N U A R Y

MEMO: JANUARY <input type="checkbox"/>
AMOUNT: \$

15

ENTER

MEMO: JANUARY
AMOUNT: \$ <input type="checkbox"/>

16

Enter amount
(up to \$99,999.99).

Example:

4 0 0 0

MEMO: JANUARY
AMOUNT: \$4000 <input type="checkbox"/>

• AMOUNT value can be cleared
by pressing **AC/C**.

17

ENTER



Confirm each item.

01/30/93	SALARY
JANUAR	\$4,000.00 T

Summarized display of
DEPOSIT record.

• This display can not be altered.

3 CHECK Function

Entering Deposit Data

18

To finish process press

ENTER

PAY TO FIRST	DEPOSIT BAL: \$8700.00
-----------------	---------------------------

The new deposit is added to the balance.

19

To return to initial display press

DONE

JAN. 30, 1993 SAT 02:02:01 PM

3

CHECK Function



Correct mistakes either before or after entering numbers/letters.

- If you find a mistake before pressing **ENTER**, press **◀** / **▶** and **DELETE**. This clears the letter/number under the cursor.
- If you find a mistake after pressing **ENTER**, press **▲** to move up. Write the new entry over the old one.

Searching a CHECK Record

You can search for a CHECK record in the following ways and print it if required. Use the most convenient one for you.

A. Moves up and down through the check records.

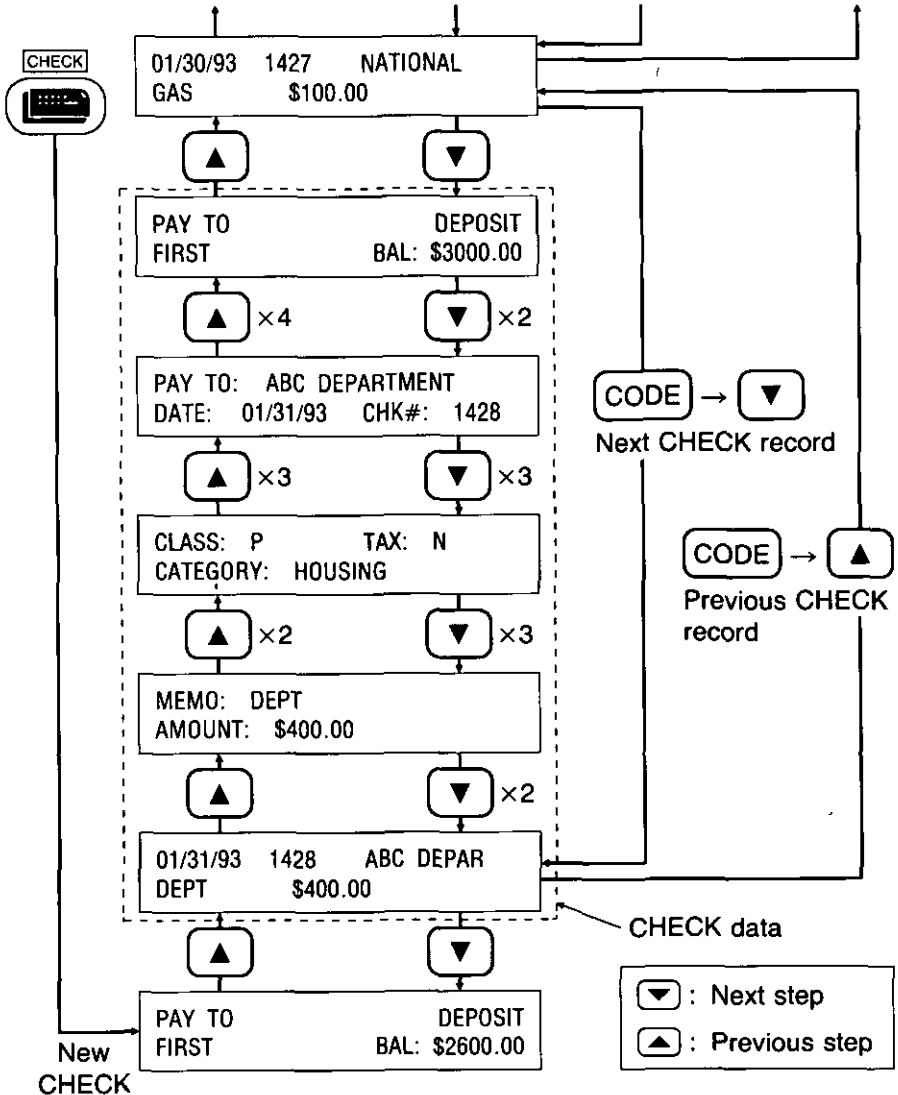









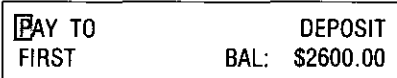

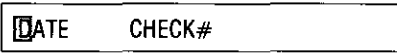
When data is full, the last record will be displayed.

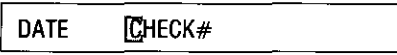
B. **FIND** This function allows you to jump to a desired record by specifying its date or check number. (See next page.)

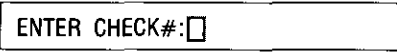
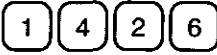
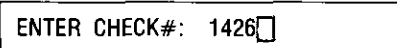
Searching a CHECK Record

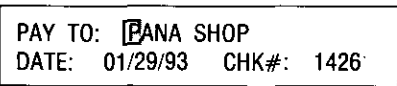
Example: You want to know the data of check #1426.

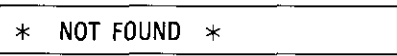
	Operation	Display/Description
1		
2		
3	Select search item, date, or check number. Example: "CHECK#" 	
4		
5	Enter check number. Example: 	 <ul style="list-style-type: none"> • If searching by "DATE", enter the month, day and year (see p. 19).
6		 <ul style="list-style-type: none"> • When two or more records exist, the first one is displayed. • If you want to print the check, press  8 times and repeat steps 1 through 4 on p. 37.
	When data does not exist this display appears.	

Reconciling (✓) a Check

Example: You receive, from your bank, the statement of issued checks. Confirm the statement according to the CHECK records in CPA. Confirmation will be easier if you reconcile (✓) the record while checking (✓) the corresponding statement.

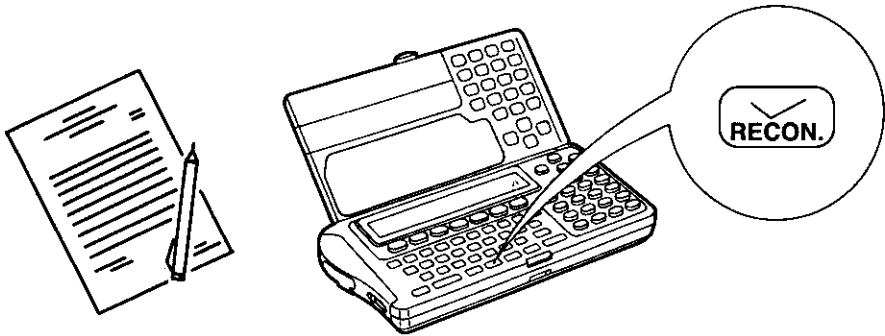

Operation

Display/Description

- 1** Repeat steps 1 through 6 on p. 44 and press 8 times.
 ↓
 Confirm statement with display.

01/29/93	1426	PANA SHOP
ELECTR	\$300.00	

Summarized display of CHECK record.

- 2** To reconcile (✓) display press .
 To cancel reconciling, press again.

01/29/93	1426	PANA SHOP
ELECTR	\$300.00	✓

Reconciled

- 3** To return to initial display press .

01/29/93	1426	PANA SHOP
ELECTR	\$300.00	

• To display other record for reconciling, press → or → .

FEB. 06, 1993 SAT
11:07:55 AM

Voiding a Check After Issued

Example: You issue a check but later void it.
You must also void the corresponding CHECK record so that the amount of that check is added again to the balance.

Operation



Display/Description

- 1** Repeat steps 1 through 6 on p. 44 and press  8 times.

01/29/93	1426	PANA SHOP
ELECTR	\$300.00	

Summarized display of CHECK record.



- 2** To void check record press

 →  .

01/29/93	1426	PANA SHOP	
ELECTR	\$300.00		V

Voided

To cancel void press

 →  again.

01/29/93	1426	PANA SHOP
ELECTR	\$300.00	

- Void is canceled by reconciling and the amount of that check is again added to the balance.

- 3** To return to initial display press







 .

FEB. 06, 1993 SAT
11:14:22 AM

Deleting a CHECK Record

CPA can hold data for up to 1000 checks. If you have entered data for 1000 checks in order to enter more you must delete old data.

Only the check record data will be deleted: the balance will not be changed.

Operation	Display/Description
1 Repeat steps 1 through 6 on p 44 and press  8 times	<div style="border: 1px solid black; padding: 5px; display: inline-block;">01/29/93 1426 PANA SHOP ELECTR \$300 00</div> <p>Summarized display of CHECK record</p>
2  → 	<div style="border: 1px solid black; padding: 5px; display: inline-block;">DELETE RECORD <input checked="" type="checkbox"/> Y ?</div>
3  or 	<div style="border: 1px solid black; padding: 5px; display: inline-block;">DELETE RECORD <input checked="" type="checkbox"/> Y ?</div> <p>N To cancel Y To execute</p>
4 	<div style="border: 1px solid black; padding: 5px; display: inline-block;">* DELETED *</div> <p style="text-align: center;">↓ after a few seconds</p> <div style="border: 1px solid black; padding: 5px; display: inline-block;">PAY TO <input checked="" type="checkbox"/> ABC SHOP DATE 01/30/93 CHK# 1427</div> <p>Next record appears Deleting is complete</p>
5 To return to initial display press 	<div style="border: 1px solid black; padding: 5px; display: inline-block;">FEB 06, 1993 SAT 11 18 24 AM</div>

3

CHECK Function

Now you may search and delete other records

One record can be deleted at a time. Before changing the account name, all records must be deleted.

Entering Withdrawals/Service Charges

Withdrawals and service charges can be entered as check data. Follow the steps for "Entering Data for Each Check" starting on page 31 with one exception. When performing step 9, enter "0" for the check number.

This procedure is useful for entering withdrawals such as those performed at automatic teller machines.

3

CHECK
Function

Chapter 4

CARD Function

	Page
Making the Card List	50
Entering Data for Purchase with a Credit Card	52
Searching a CARD Record	55
Deleting a CARD Record	57

Making the Card List

Up to 10 card names can be entered.
Confirm the card balances before entering it.

Example: Make the card list using the card name "ABC CARD" and card number "9876543".

4 CARD Function

Operation	Display/Description										
1 <input type="button" value="SETUP"/>	<table border="1"> <tr> <td><input checked="" type="checkbox"/> DATE</td> <td>CHECK</td> <td>CARD</td> </tr> <tr> <td>CONTRAST</td> <td></td> <td>MORE ↓</td> </tr> </table>	<input checked="" type="checkbox"/> DATE	CHECK	CARD	CONTRAST		MORE ↓				
<input checked="" type="checkbox"/> DATE	CHECK	CARD									
CONTRAST		MORE ↓									
2 To select "CARD" press <input type="button" value="▶"/> twice.	<table border="1"> <tr> <td>DATE</td> <td>CHECK</td> <td><input checked="" type="checkbox"/> CARD</td> </tr> <tr> <td>CONTRAST</td> <td></td> <td>MORE ↓</td> </tr> </table>	DATE	CHECK	<input checked="" type="checkbox"/> CARD	CONTRAST		MORE ↓				
DATE	CHECK	<input checked="" type="checkbox"/> CARD									
CONTRAST		MORE ↓									
3 <input type="button" value="ENTER"/>	<table border="1"> <tr> <td>CARD NAME: <input type="text"/></td> </tr> <tr> <td>CARD#: <input type="text"/></td> </tr> </table> <p>• If you have already made entries, the first card name will be displayed. Press <input type="button" value="CARD"/> or <input type="button" value="CODE"/> → <input type="button" value="▼"/> to skip to a blank entry.</p>	CARD NAME: <input type="text"/>	CARD#: <input type="text"/>								
CARD NAME: <input type="text"/>											
CARD#: <input type="text"/>											
4 Enter card name (up to 20 letters/numbers). Example: <table border="1" style="display: inline-table; margin: 5px;"> <tr> <td><input type="button" value="A"/></td> <td><input type="button" value="B"/></td> <td><input type="button" value="C"/></td> <td><input type="button" value="SPACE"/></td> </tr> <tr> <td><input type="button" value="C"/></td> <td><input type="button" value="A"/></td> <td><input type="button" value="R"/></td> <td><input type="button" value="D"/></td> </tr> </table>	<input type="button" value="A"/>	<input type="button" value="B"/>	<input type="button" value="C"/>	<input type="button" value="SPACE"/>	<input type="button" value="C"/>	<input type="button" value="A"/>	<input type="button" value="R"/>	<input type="button" value="D"/>	<table border="1"> <tr> <td>CARD NAME: ABC CARD <input type="text"/></td> </tr> <tr> <td>CARD#: <input type="text"/></td> </tr> </table>	CARD NAME: ABC CARD <input type="text"/>	CARD#: <input type="text"/>
<input type="button" value="A"/>	<input type="button" value="B"/>	<input type="button" value="C"/>	<input type="button" value="SPACE"/>								
<input type="button" value="C"/>	<input type="button" value="A"/>	<input type="button" value="R"/>	<input type="button" value="D"/>								
CARD NAME: ABC CARD <input type="text"/>											
CARD#: <input type="text"/>											
5 <input type="button" value="ENTER"/>	<table border="1"> <tr> <td>CARD NAME: ABC CARD</td> </tr> <tr> <td>CARD#: <input type="text"/></td> </tr> </table>	CARD NAME: ABC CARD	CARD#: <input type="text"/>								
CARD NAME: ABC CARD											
CARD#: <input type="text"/>											
6 Enter card number (up to 16 digits). Example: <table border="1" style="display: inline-table; margin: 5px;"> <tr> <td><input type="button" value="9"/></td> <td><input type="button" value="8"/></td> <td><input type="button" value="7"/></td> <td><input type="button" value="6"/></td> <td><input type="button" value="5"/></td> <td><input type="button" value="4"/></td> <td><input type="button" value="3"/></td> </tr> </table>	<input type="button" value="9"/>	<input type="button" value="8"/>	<input type="button" value="7"/>	<input type="button" value="6"/>	<input type="button" value="5"/>	<input type="button" value="4"/>	<input type="button" value="3"/>	<table border="1"> <tr> <td>CARD NAME: ABC CARD</td> </tr> <tr> <td>CARD#: 9876543 <input type="text"/></td> </tr> </table>	CARD NAME: ABC CARD	CARD#: 9876543 <input type="text"/>	
<input type="button" value="9"/>	<input type="button" value="8"/>	<input type="button" value="7"/>	<input type="button" value="6"/>	<input type="button" value="5"/>	<input type="button" value="4"/>	<input type="button" value="3"/>					
CARD NAME: ABC CARD											
CARD#: 9876543 <input type="text"/>											

7

BALANCE: ~~\$0.00~~
CREDIT LIMIT: \$0.00

8 Enter current card balance (up to 99,999.99).

Example:

BALANCE: \$400
CREDIT LIMIT: \$0.00

• Calculations will start from this amount.

9

BALANCE: \$400
CREDIT LIMIT: ~~\$0.00~~

10 Enter credit card limit for one payment term for reference (up to 99,999.99).

Example:

BALANCE: \$400
CREDIT LIMIT: \$4200

11

CARD NAME:
CARD#:

12 If entering data for another card (up to 10 cards) repeat steps 4 through 11.

13 To return to SETUP menu press

DATE CHECK CARD
CONTRAST MORE ↓

14 To return to initial display press

FEB. 20, 1993 SAT
08:30:05 PM

 Correct mistakes either before or after entering letters/numbers.

- If you find a mistake before pressing , press / and . This clears the letter/number under the cursor.
- If you find a mistake after pressing , press to move up then write the new entry over the old one.
- We recommend that you reset the "BALANCE" to "0" after setting up.

Entering Data for Purchase with a Credit Card

Have you finished setting the clock (p 19) and making the card list (p 50)?

When you purchase something with a credit card, enter the following data

- DATE
- AMOUNT
- MEMO
- CLASS Business, Personal or Others
- TAX Tax-related or No tax-related
- CATEGORY Can be selected from the category list (p 125)

Example: You pay \$100 with the XYZ Card for a dinner at the "ABC" market on February 21, 1993

4

CARD Function

Operation

Display/Description

1



CARD NAME
CARD# 9876543

To see the balance press



twice

BALANCE \$
CREDIT LIMIT \$4200 00

2

If selecting another card from the list press



CARD NAME
CARD# 123456789

3



XYZ CARD DATE
AMOUNT \$

4

Enter a new date
Example



XYZ CARD DATE 02/21/
AMOUNT \$

5



XYZ CARD DATE 02/21/93
AMOUNT \$

Entering Data for Purchase with a Credit Card

6 Enter amount
Example

XYZ CARD	DATE 02/21/93
AMOUNT \$100	

7

MEMO	<input type="checkbox"/>
CLASS P	TAX N

8 Enter memo if necessary (up to 20 letters/numbers)
Example

MEMO	ABC MARKET
CLASS P	TAX N

9

MEMO	ABC MARKET
CLASS B	TAX N

10 To select "CLASS" press

/

or

/ /

MEMO	ABC MARKET
CLASS B	TAX N

- B Business
- P Personal
- O Others

11

MEMO	ABC MARKET
CLASS P	TAX <input type="checkbox"/> Y ?

12 To select "TAX" press

/

or

/

MEMO	ABC MARKET
CLASS P	TAX <input type="checkbox"/> Y ?

- N No tax-related
- Y Tax-related

4

CARD Function

Entering Data for Purchase with a Credit Card

13

ENTER

CATEGORY: MISC
END OF TRANSACTION

14

Select category
from the list on p. 125.



Example: DINING
To display first category under
"D" press

D

CATEGORY: DINING
END OF TRANSACTION

15

To finish process press

ENTER

XYZ CARD DATE: 02/24/93
AMOUNT: \$

16

To return to initial display press

DONE

FEB. 24, 1993 WED
04:05:10 PM

Now you can enter data for other card payments.

The "AMOUNT" you enter adds to the "BALANCE".

If you do not make the card list in setup, the balance is not updated (\$0.00).



Correct mistakes either before or after entering letters/numbers.

- If you find a mistake before pressing **ENTER**, press **◀** / **▶** and **DELETE**. This clears the letter/number under the cursor.
- If you find a mistake after pressing **ENTER**, press **▲** to move up then write the new entry over the old one.

Searching a CARD Record

You can search for a CARD record in the following ways.
Use the most convenient one for you.

A. Moves up and down through the records.

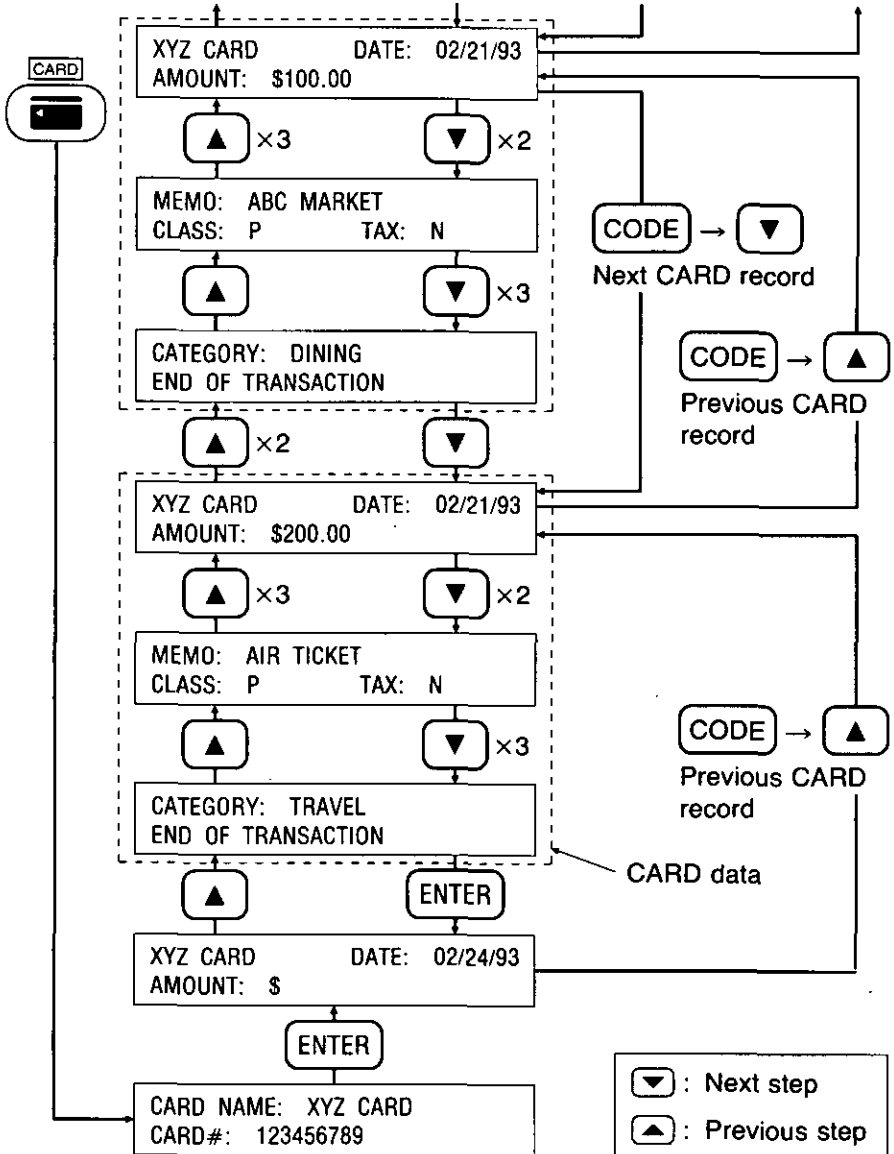

B. **FIND**

This function allows you to jump to a desired record by specifying its date (see next page).

Searching a CARD Record

Example: You want to know how much you paid with the XYZ card on February 21, 1993

Operation

Display/Description

1

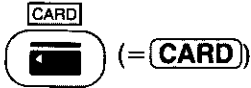

CARD NAME XYZ CARD
CARD# 123456789

- If selecting another card, press **CARD** until the desired card name appears

4

2



XYZ CARD DATE 02/27/93
AMOUNT \$

3

To search by date press



ENTER DATE □ / □ / □

- Can search only by date

4

Enter date
Example

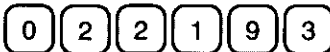

ENTER DATE 02/21/93

5



XYZ CARD DATE 02/21/93
AMOUNT \$100 00

- When two or more records exist, the first one is displayed

When data does not exist this display appears

* NOT FOUND *

6

To move down through records press twice

MEMO ABC MARKET
CLASS P TAX N

7

To return to initial display press



FEB 27, 1993 SAT
09 12 43 PM

- If selecting a card from the list, **FIND** allows you to jump to a desired card by specifying its name

Deleting a CARD Record

CPA holds data for up to 600 card and cash payments.

If you have entered data for 600 payments by a credit card and/or cash, you must delete old data in order to enter more.

Only the card record data will be deleted, and the amount will not be subtracted from the balance automatically.

Operation	Display/Description
1 Repeat steps 1 through 5 on p. 56.	XYZ CARD DATE: 02/21/93 AMOUNT: \$100.00 Data to be deleted
2 CODE → DELETE	DELETE RECORD NY?
3  or Y	DELETE RECORD NY? N: To cancel Y: To execute
4 ENTER	* DELETED * after a few seconds XYZ CARD DATE: 02/21/93 AMOUNT: \$200.00 Next record appears. Deleting is complete.
5 To return to initial display press DONE	FEB. 28, 1993 SUN 09:28:21 PM

Now you may search and delete other records.

- To delete a card and all its records, first select the card (p. 50 Making the Card List), then press **CODE** → **DELETE**.

Chapter 5

CASH Function

	Page
Entering Data for Purchase in Cash	60
Searching a CASH Record	62
Deleting a CASH Record	64

Entering Data for Purchase in Cash

When you make a cash purchase, enter the following data

- DATE
- AMOUNT
- MEMO
- CLASS Business, Personal or Others
- TAX Tax-related, No tax-related
- CATEGORY Can be selected from the category list (p 125)

Example: You pay \$20, in cash, for a book on February 25, 1993

Operation

Display/Description

1



DATE 02/26/93
AMOUNT \$

2

Enter date
Example

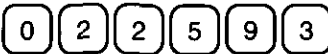

DATE 02/25/93
AMOUNT \$

3



DATE 02/25/93
AMOUNT \$

4

Enter amount
(up to \$99,999.99)
Example



DATE 02/25/93
AMOUNT \$20

5



MEMO
CLASS P TAX N

6

Enter memo, if necessary
(up to 20 letters/numbers)
Example



MEMO BOOK
CLASS P TAX N

7



MEMO BOOK
CLASS B/P/O TAX N

Entering Data for Purchase in Cash

8

To select "CLASS" press



or



MEMO: BOOK
CLASS: B/P/O TAX: N

B: Business
P: Personal
O: Others

9



MEMO: BOOK
CLASS: P TAX: N/Y ?

10

To select "TAX" press



or



MEMO: BOOK
CLASS: P TAX: N/Y ?

N: No tax-related
Y: Tax-related

11



CATEGORY: MISC
END OF TRANSACTION

12

Select category
from the list on p. 125.



Example: EDUCATION
To display first category under
"E" press



CATEGORY: EDUCATION
END OF TRANSACTION

13

To finish process press



DATE: 02/26/93
AMOUNT: \$

14

To return to initial display press



FEB. 26, 1993 FRI
09:30:00 PM

Now you can enter data for other cash payments.

Searching a CASH Record

You can search for a CASH record in the following ways.
Use the most convenient one for you.



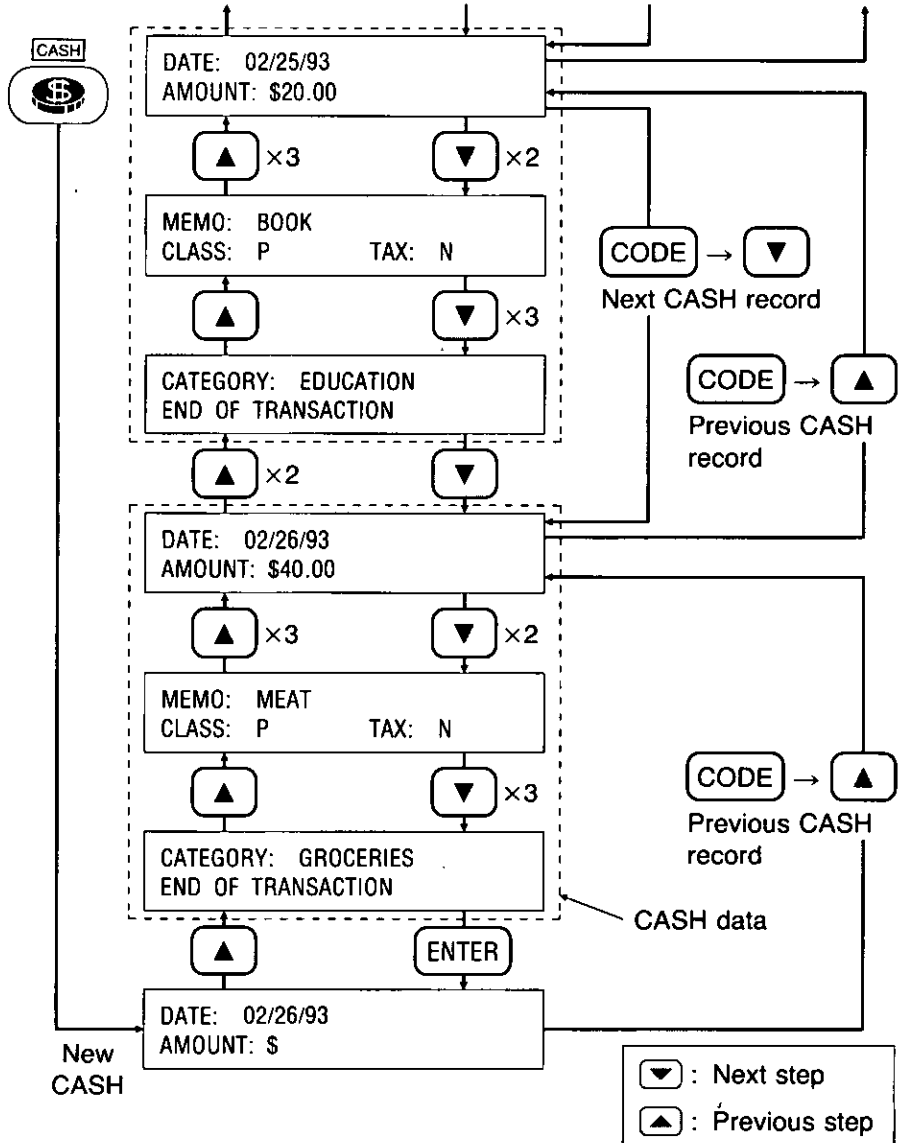



A. Moves up and down through the records.



B. **FIND** This function allows you to jump to a desired record by specifying its date (see next page).

Searching a CASH Record

Example: You want to know how much you paid in cash on February 25, 1993.

Operation	Display/Description
1 	DATE: 02/26/93 AMOUNT: \$
2 To search by date press 	ENTER DATE: / / ●Can search only by date.
3 Enter date. Example: 	ENTER DATE: 02/25/93
4 	DATE: 02/25/93 AMOUNT: \$20.00 ●When two or more records exist, the first one is displayed.
When data does not exist this display appears.	* NOT FOUND *
5 To move down through records press  twice.	MEMO: BOOK CLASS: P TAX: N
6 To return to initial display press 	FEB. 26, 1993 FRI 09:48:16 PM

5

CASH Function

Deleting a CASH Record

CPA can hold data for up to 600 card payments and cash payments. If you have entered data for 600 payments by a credit card and/or cash you must delete old data in order to enter more.

	Operation	Display/Description
1	Repeat steps 1 through 4 on p. 63.	DATE: 02/25/93 AMOUNT: \$20.00
2	CODE → DELETE	DELETE RECORD <input checked="" type="checkbox"/> Y ?
3	▶ or Y	DELETE RECORD <input checked="" type="checkbox"/> Y ? N: To cancel Y: To execute
4	ENTER	* DELETED * ↓ after a few seconds DATE: 02/26/93 AMOUNT: \$40.00 Next record appears. Deleting is complete.
5	To return to initial display press DONE	FEB. 26, 1993 FRI 10:02:43 PM

Now you may search and delete other records.

5
CASH Function

Chapter 6







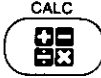

CALCULATOR Function

	Page
Basic Calculation	66
Memory Calculation	67

Basic Calculation

CPA can do basic calculation, "+", "-", "x", and "/" with a 10 digit maximum

Example. Q $123 \times 34 - 15 =$

	Operation	Display/Description
1		0
2		123
3		x 123
4		x 34
5		- 41.82 Result of (123 x 34)
6		- 15
7		40.32 Final result
8	To return to initial display press 	FEB 27, 1993 SAT 09 22 55 AM



- You can correct mistakes made during calculations

To reset a figure to "0" press **AC/C** once





To clear "+", "-", "x", or "/" press **AC/C** once or twice

- When you press **+** → **=**, the displayed number is added to itself
(Example **5** → **+** → **=** The answer is 10)

Memory Calculation

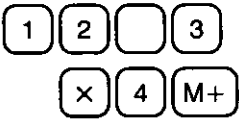
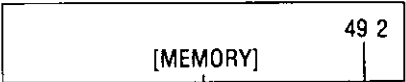
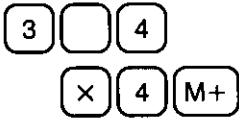
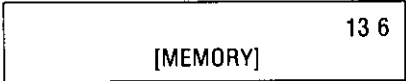
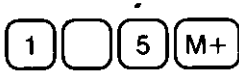
CPA can calculate, memorizing a midway result, with a 10 digit maximum

Example: Q $(123 \times 4) + (34 \times 4) + 15 =$

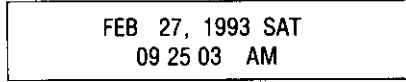
	Operation	Display/Description
1	Confirm display shows "0"	0
2		 <p>Result of (123×4) has been memorized</p>
3		 <p>Result of (34×4) will be added to the memory</p>
4		 <p>"15" will be added to the memory</p>
5		 <p>Final result</p>
6	To return to initial display press 	

-  You can correct mistakes made during calculations
 - To reset a figure to "0" press **AC/C** once
 - To clear "+", "-", "x", or "-" press **AC/C** once or twice
 - To clear "[MEMORY]" press **R•CM** twice

Memory Calculation

“[ERROR]” shows in the following cases

- When the result exceeds “9,999,999,999”
- When you try to divide by “0”

To clear “[ERROR]” press **AC/C**

Chapter 7

ADDRESS LIST Function

	Page
Making the Address List	70
Searching an ADDRESS LIST Record	73
Deleting an ADDRESS LIST Record	75

Making the Address List

You can enter up to 110 address lists.

Example: You want to enter the following names, the telephone numbers and addresses.

Name	Telephone No.	Address
MONICA SIMPSON	123-456-7890	29 HICKS STREET NEW YORK, NY 10004
ALICIA PRITCHETT	852-963-7410	131 ASCAN AVENUE SUMMIT, NJ 07091

Operation

Display/Description

1



NAME :
 PHONE:

2

Enter name
 (up to 32 letters/numbers).
 Example:

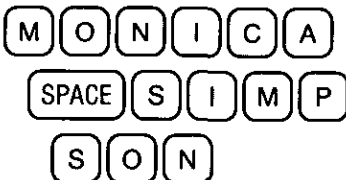

NAME : MONICA SIMPSON
 PHONE:

3



NAME : MONICA SIMPSON
 PHONE:

4

Enter telephone number
 (up to 12 digits).
 Example:

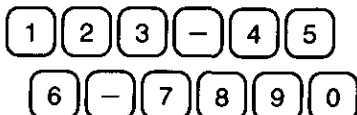

NAME : MONICA SIMPSON
 PHONE: 123-456-7890

Making the Address List

5

ENTER

STREET
CITY, ST

6

Enter street name
(up to 32 letters/numbers)

Example

2 9 SPACE H I
C K S SPACE S
T R E E T

STREET HICKS STREET
CITY, ST

7

ENTER

STREET 29 HICKS STREE
CITY, ST

8

Enter city and state name
(up to 32 letters/numbers)

Example

N E W SPACE Y
O R K CODE
N Y SPACE 1 0
0 0 4

STREET 29 HICKS STREE
CITY, ST YORK, NY 10004

9

ENTER

NAME
PHONE

10

If entering another address
list (up to 110) repeat steps 2
through 9

11

To return to initial display press





DONE

FEB 24, 1993 WED
08 30 05 PM

7

ADDRESS LIST Function

Making the Address List

- ✎ • Correct mistakes either before or after entering letters/numbers
- If you find a mistake before/after pressing **ENTER**, press  /  ,  /  and **DELETE**. This clears the letter/number under the cursor

Entries will be sorted in alphabetical order according to the first name

MONICA SIMPSON	→	ALICIA PRITCHETT
ALICIA PRITCHETT		MONICA SIMPSON

Searching an ADDRESS LIST Record

You can search for an ADDRESS LIST record in the following ways Use the most convenient one for you



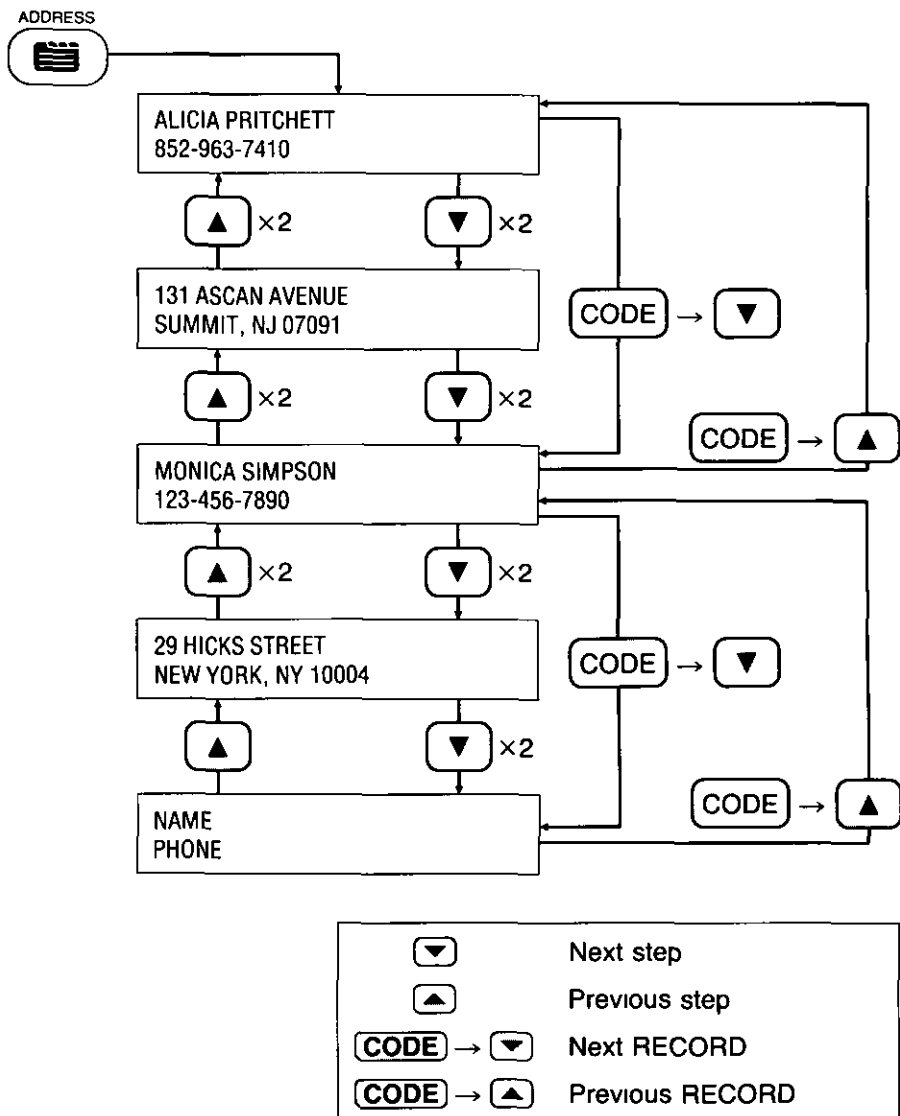





A. Moves up and down through the records

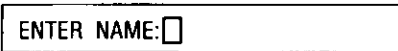

Searching an ADDRESS LIST Record

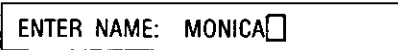
- B.** **FIND** This function allows you to jump to a desired record by specifying the name.

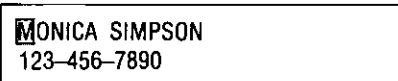
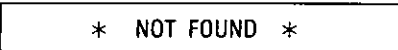
Example: You want to know Monica's telephone number and address.

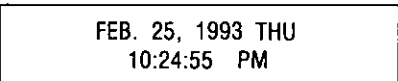
	Operation	Display/Description
1		
2	To search by name press 	
3	Enter name Example: 	 <ul style="list-style-type: none">•The record can also be shown on the display by entering the first letter of the name.
4	 When name does not exist this display appears.	 The desired record appears. 
5	To return to initial display press 	

Deleting an ADDRESS LIST Record

CPA can hold up to 110 address lists. If you have entered 110 address lists, you must delete old data in order to enter more.

	Operation	Display/Description
1	Repeat steps 1 through 4 on p. 74.	<div style="border: 1px solid black; padding: 5px;">M MONICA SIMPSON 123-456-7890</div>
2	<input type="text" value="CODE"/> → <input type="text" value="DELETE"/>	<div style="border: 1px solid black; padding: 5px;">DELETE RECORD <input checked="" type="checkbox"/> Y ?</div>
3	<input type="text" value="▶"/> or <input type="text" value="Y"/>	<div style="border: 1px solid black; padding: 5px;">DELETE RECORD <input type="checkbox"/> N <input checked="" type="checkbox"/> Y ?</div> <p>N: To cancel Y: To execute</p>
4	<input type="text" value="ENTER"/>	<div style="border: 1px solid black; padding: 5px;">* DELETED *</div> <p style="text-align: center;">↓ after a few seconds</p> <div style="border: 1px solid black; padding: 5px;">A ALICIA PRITCHETT 852-963-7410</div> <p>Next record appears. Deletion is complete.</p>
5	To return to initial display press <input type="text" value="DONE"/> .	<div style="border: 1px solid black; padding: 5px;">FEB. 25, 1993 THU 10:31:06 PM</div>

Now you may search and delete other records.

Chapter 8

REPORT Function

	Page
Putting the Paper Roll on the Printer . . .	78
Showing Contents of CHECK Records	80
Showing Contents of CARD Records . . .	85
Showing Contents of CASH Records . . .	88
Showing Contents of ADDRESS LIST Records	91

Putting the Paper Roll on the Printer

If you want to know what is in the memory for CHECK, CARD, CASH and ADDRESS LIST use the REPORT function. This will show you the contents of the records on the display or will print them on the paper roll. If you want the records to be printed on the paper roll, you must first attach the paper roll to the printer. Paper roll: 2 1/4" standard adding machine paper roll (diameter: 3 5/32" or less)

1. Put the paper roll on the paper feeder.
Make sure the paper is fed from underneath not from top.

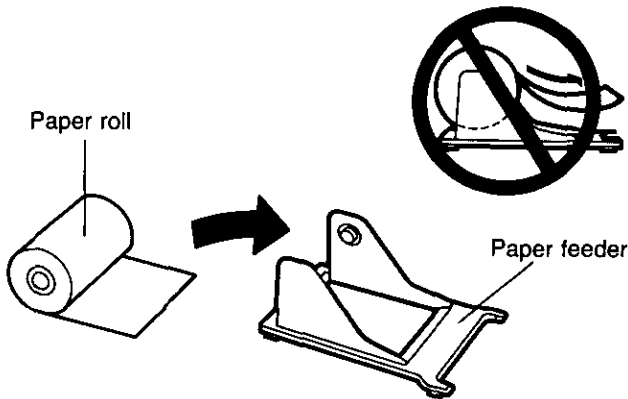

2. Connect the paper feeder to CPA on a stable or level surface.
The two hooks of the feeder should be inserted into the holes on the bottom of CPA.

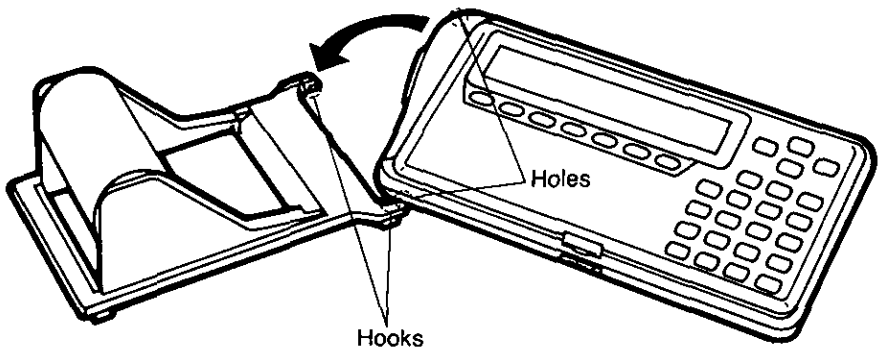

Putting the Paper Roll on the Printer

3. Open CPA by sliding the bottom cover knob to the right.

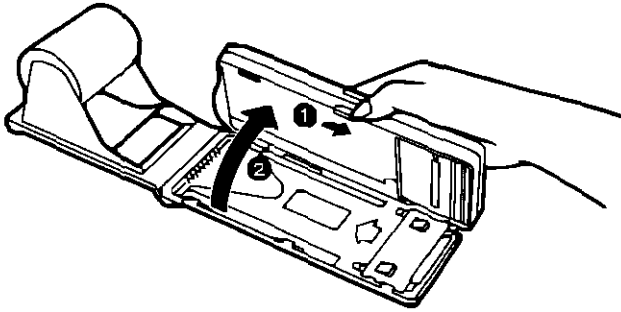

4. Pull the paper out forward along the paper setting lines marked on both sides and leave the paper out about 1/2 inch.
(Be sure the paper is set exactly along the lines marked.)

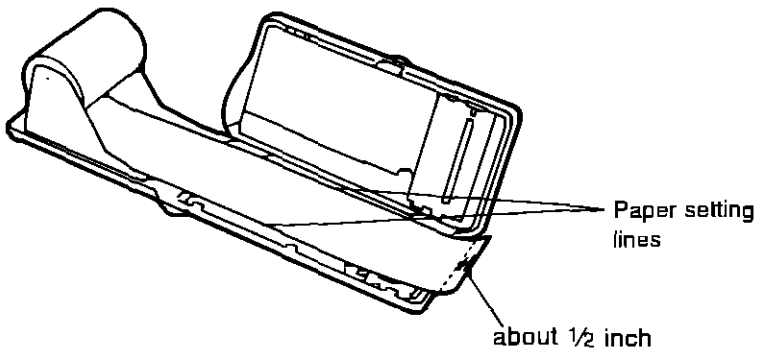

5. Close CPA while setting the paper exactly to the marks.

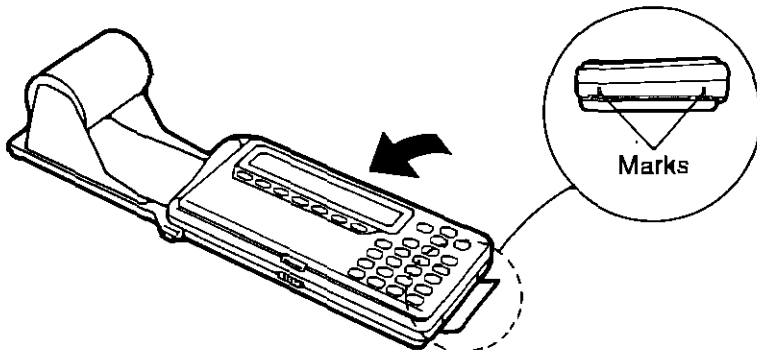

Showing Contents of CHECK Records

Example: You want to print a list of checks from #1426 to #1430 (FIRST bank)

Operation

Display/Description

1

REPORT

<input checked="" type="checkbox"/> CHECK	CARD	CASH
ADDRESS		

2

ENTER

SELECT ACCOUNT	
<input checked="" type="checkbox"/> FIRST	SECOND

FIRST

Records of FIRST bank will be selected

SECOND

Records of SECOND bank will be selected

- If no second bank has been entered, jump to step 4

3

To select Accounts (FIRST bank or SECOND bank) press



or



SELECT ACCOUNT	
<input checked="" type="checkbox"/> FIRST	SECOND

4

ENTER

<input checked="" type="checkbox"/> ALL	TAX	CHECK#	DATE
CATEGORY	CLASS		NAME

ALL

All CHECK records

TAX

Records entered as "Tax-related"

CHECK#

Records with specified number

DATE

Records on specified dates

CATEGORY

Records in specified category





CLASS

Records in specified class

NAME

Records for specified payee

Showing Contents of CHECK Records

- 5** To select search item,
Example: "CHECK#", press  twice.
- | | | | |
|----------|-----|--|------|
| ALL | TAX | <input checked="" type="checkbox"/> CHECK# | DATE |
| CATEGORY | | CLASS | NAME |
- 6** 
- | | |
|---------------|--------------------------|
| START CHECK#: | <input type="checkbox"/> |
| END CHECK#: | |
- 7** Enter first number.
Example:
- | | | | |
|--------------------------------|--------------------------------|--------------------------------|--------------------------------|
| <input type="text" value="1"/> | <input type="text" value="4"/> | <input type="text" value="2"/> | <input type="text" value="6"/> |
|--------------------------------|--------------------------------|--------------------------------|--------------------------------|
- | | |
|---------------|-------------------------------|
| START CHECK#: | 1426 <input type="checkbox"/> |
| END CHECK#: | |
- 8** 
- | | |
|---------------|--------------------------|
| START CHECK#: | 1426 |
| END CHECK#: | <input type="checkbox"/> |
- 9** Enter last number.
Example:
- | | | | |
|--------------------------------|--------------------------------|--------------------------------|--------------------------------|
| <input type="text" value="1"/> | <input type="text" value="4"/> | <input type="text" value="3"/> | <input type="text" value="0"/> |
|--------------------------------|--------------------------------|--------------------------------|--------------------------------|
- | | |
|---------------|-------------------------------|
| START CHECK#: | 1426 |
| END CHECK#: | 1430 <input type="checkbox"/> |
- Be sure to enter both first and last numbers.
- 10** 
- | |
|--|
| <input checked="" type="checkbox"/> VIEW ON SCREEN |
| SEND TO PRINTER |
- 11** To select "SEND TO PRINTER" press 
- | |
|---|
| VIEW ON SCREEN |
| <input checked="" type="checkbox"/> SEND TO PRINTER |

Showing Contents of CHECK Records

12

ENTER

PRINTING REPORT . . .

Printing begins.

When printing has finished this display appears.

SELECT ACCOUNT
FIRST SECOND

13

To return to initial display press

DONE

FEB. 27, 1993 SAT
9:30:00 AM

Showing Contents of CHECK Records

When printing has finished:

1. Cut the paper.

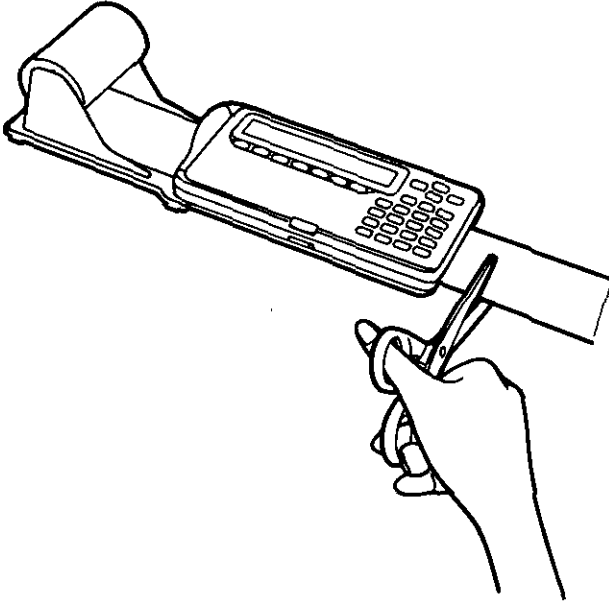

2. Open CPA by sliding the bottom cover knob to the right (refer to step 3 on p. 79).
3. Pull the paper roll out of CPA.

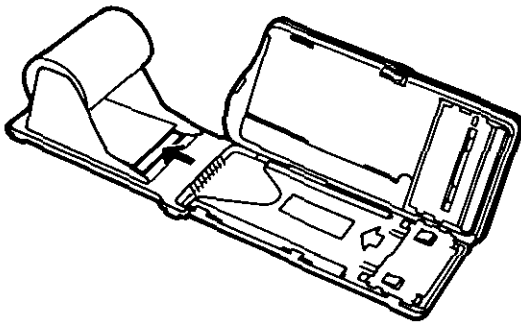

Showing Contents of CHECK Records

4. Close CPA (refer to step 5 on p. 79).
5. Remove the paper feeder from CPA by holding the paper feeder down with your hands.

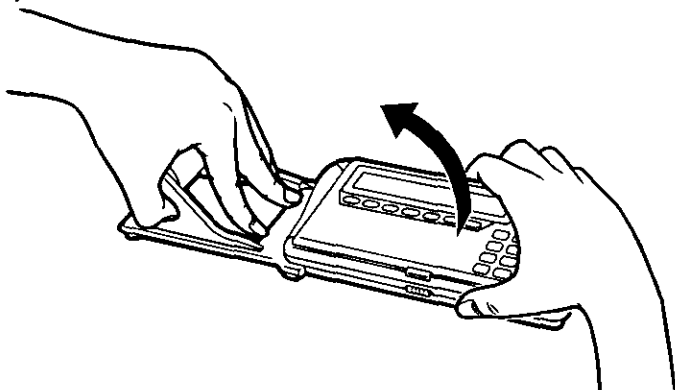

If "VIEW ON SCREEN" was selected in step 11 on p. 81:

CHK# 1426	DATE 01/16/93	PAYEE → PANA SHOP	←	PAYMENT 300.00	DEPOSIT ✓ V
		▲ ↓ ▼	◀ ▶		
CHK# 1427	DATE 01/16/93	PAYEE → NATIONAL	←	PAYMENT 100.00	DEPOSIT ✓ V
		▲ ↓ ▼	◀ ▶		
CHK# 1428	DATE 01/16/93	PAYEE → ABC MARKE	←	PAYMENT 400.00	DEPOSIT ✓ V
		▲ ↓ ▼	◀ ▶		

Showing Contents of CARD Records

Example: You want to print a list of XYZ card payments from February 21 to February 22, 1993

- | | Operation | Display/Description | | | | | | | | | | | | | | | | | | | | | | |
|---|---|--|---|--|--------|--|----------|-------|------|--|-----|------------------|-----|----------------------------------|--------|--------------------------|------|----------------------------|----------|-------------------------------|-------|----------------------------|------|--------------------------|
| 1 | <input type="button" value="REPORT"/> | <table border="0" style="width: 100%;"> <tr> <td><input checked="" type="checkbox"/> CHECK ADDRESS</td> <td style="text-align: center;">CARD</td> <td style="text-align: center;">CASH</td> </tr> </table> | <input checked="" type="checkbox"/> CHECK ADDRESS | CARD | CASH | | | | | | | | | | | | | | | | | | | |
| <input checked="" type="checkbox"/> CHECK ADDRESS | CARD | CASH | | | | | | | | | | | | | | | | | | | | | | |
| 2 | To select "CARD" press
<input type="button" value="▶"/> | <table border="0" style="width: 100%;"> <tr> <td>CHECK ADDRESS</td> <td style="text-align: center;"><input checked="" type="checkbox"/> CARD</td> <td style="text-align: center;">CASH</td> </tr> </table> | CHECK ADDRESS | <input checked="" type="checkbox"/> CARD | CASH | | | | | | | | | | | | | | | | | | | |
| CHECK ADDRESS | <input checked="" type="checkbox"/> CARD | CASH | | | | | | | | | | | | | | | | | | | | | | |
| 3 | <input type="button" value="ENTER"/> | <table border="0" style="width: 100%;"> <tr> <td>CARD NAME</td> <td style="text-align: center;"><input checked="" type="checkbox"/> XYZ CARD</td> </tr> <tr> <td>CARD#</td> <td style="text-align: center;">123456789</td> </tr> </table> <p>• If selecting another card press <input type="button" value="CARD"/> until the desired card record appears</p> | CARD NAME | <input checked="" type="checkbox"/> XYZ CARD | CARD# | 123456789 | | | | | | | | | | | | | | | | | | |
| CARD NAME | <input checked="" type="checkbox"/> XYZ CARD | | | | | | | | | | | | | | | | | | | | | | | |
| CARD# | 123456789 | | | | | | | | | | | | | | | | | | | | | | | |
| 4 | <input type="button" value="ENTER"/> | <table border="0" style="width: 100%;"> <tr> <td><input checked="" type="checkbox"/> ALL</td> <td style="text-align: center;">TAX</td> <td style="text-align: center;">CHECK#</td> <td style="text-align: center;">DATE</td> </tr> <tr> <td>CATEGORY</td> <td style="text-align: center;">CLASS</td> <td style="text-align: center;">NAME</td> <td></td> </tr> </table>
<table border="0" style="width: 100%;"> <tr> <td style="width: 30%;">ALL</td> <td>All CARD records</td> </tr> <tr> <td>TAX</td> <td>Records entered as "Tax-related"</td> </tr> <tr> <td>CHECK#</td> <td>Can not be selected here</td> </tr> <tr> <td>DATE</td> <td>Records on specified dates</td> </tr> <tr> <td>CATEGORY</td> <td>Records in specified category</td> </tr> <tr> <td>CLASS</td> <td>Records in specified class</td> </tr> <tr> <td>NAME</td> <td>Can not be selected here</td> </tr> </table> | <input checked="" type="checkbox"/> ALL | TAX | CHECK# | DATE | CATEGORY | CLASS | NAME | | ALL | All CARD records | TAX | Records entered as "Tax-related" | CHECK# | Can not be selected here | DATE | Records on specified dates | CATEGORY | Records in specified category | CLASS | Records in specified class | NAME | Can not be selected here |
| <input checked="" type="checkbox"/> ALL | TAX | CHECK# | DATE | | | | | | | | | | | | | | | | | | | | | |
| CATEGORY | CLASS | NAME | | | | | | | | | | | | | | | | | | | | | | |
| ALL | All CARD records | | | | | | | | | | | | | | | | | | | | | | | |
| TAX | Records entered as "Tax-related" | | | | | | | | | | | | | | | | | | | | | | | |
| CHECK# | Can not be selected here | | | | | | | | | | | | | | | | | | | | | | | |
| DATE | Records on specified dates | | | | | | | | | | | | | | | | | | | | | | | |
| CATEGORY | Records in specified category | | | | | | | | | | | | | | | | | | | | | | | |
| CLASS | Records in specified class | | | | | | | | | | | | | | | | | | | | | | | |
| NAME | Can not be selected here | | | | | | | | | | | | | | | | | | | | | | | |
| 5 | To select search item,
Example "DATE", press
<input type="button" value="▶"/> twice | <table border="0" style="width: 100%;"> <tr> <td>ALL</td> <td style="text-align: center;">TAX</td> <td style="text-align: center;">CHECK#</td> <td style="text-align: center;"><input checked="" type="checkbox"/> DATE</td> </tr> <tr> <td>CATEGORY</td> <td style="text-align: center;">CLASS</td> <td style="text-align: center;">NAME</td> <td></td> </tr> </table> | ALL | TAX | CHECK# | <input checked="" type="checkbox"/> DATE | CATEGORY | CLASS | NAME | | | | | | | | | | | | | | | |
| ALL | TAX | CHECK# | <input checked="" type="checkbox"/> DATE | | | | | | | | | | | | | | | | | | | | | |
| CATEGORY | CLASS | NAME | | | | | | | | | | | | | | | | | | | | | | |

Showing Contents of CARD Records

6

ENTER

START DATE: / /
END DATE: / /

7

Enter first date.

Example:

012193

START DATE: 01/21/93
END DATE: / /

8

ENTER

START DATE: 01/21/93
END DATE: / /

9

Enter last date.

Example:

012293

START DATE: 01/21/93
END DATE: 01/22/93

- Be sure to enter both first and last dates.

10

ENTER

VIEW ON SCREEN
 SEND TO PRINTER

11

To select "SEND TO PRINTER" press

▼

VIEW ON SCREEN
 SEND TO PRINTER

12

ENTER

PRINTING REPORT . . .

Printing begins.

When printing has finished this display appears.

CARD NAME: ABC CARD
CARD#: 9876543

The first record appears.

Showing Contents of CARD Records

13

To return to initial display
press **DONE**

FEB 27, 1993 SAT
9 35 00 AM

If printing is finished, remove the paper feeder from CPA (refer to steps 1 through 5 on p 83-84)

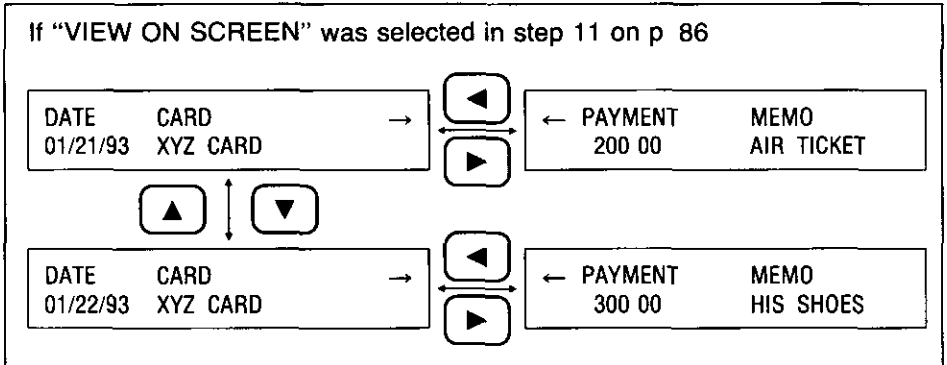

8

REPORT Function

Showing Contents of CASH Records

Example: You want to print a list of cash payments for groceries

Operation

Display/Description

1

REPORT

<input checked="" type="checkbox"/> CHECK ADDRESS	CARD	CASH
--	------	------

2

To select "CASH" press

▶ twice

CHECK ADDRESS	CARD	<input checked="" type="checkbox"/> CASH
------------------	------	--

3

ENTER

<input checked="" type="checkbox"/> ALL CATEGORY	TAX	CHECK# CLASS	DATE NAME
---	-----	-----------------	--------------

ALL All CASH payment records
TAX Records entered as "Tax-related"

CHECK# Can not be selected here
DATE Records on specified dates
CATEGORY Records in specified category
CLASS Records in specified class
NAME Can not be selected here

4

To select search item,
Example "CATEGORY",

press **▼**

ALL <input checked="" type="checkbox"/> CATEGORY	TAX	CHECK# CLASS	DATE NAME
---	-----	-----------------	--------------

5

ENTER

CATEGORY	MISC <input type="checkbox"/>
----------	-------------------------------

8

REPORT Function

Showing Contents of CASH Records

- 6 Select category
from the list on p 125
↓
Example GIFTS
To display first category under
"G" press

G

CATEGORY GIFT RECVD



- To display next category
(GIFTS) press



CATEGORY GIFTS

- 7 ENTER

START DATE / /
END DATE / /

- Be sure to enter both first and last dates

- 8 Repeat steps 7 through 10 on
p 86

VIEW ON SCREEN
 SEND TO PRINTER

- 9 To select "SEND TO
PRINTER" press



VIEW ON SCREEN
 SEND TO PRINTER

- 10 ENTER

PRINTING REPORT

Printing begins

- When printing has finished this
display appears

ALL	TAX	CHECK#	DATE
CATEGORY	CLASS	NAME	

- 11 To return to initial display press

DONE

FEB 27, 1993 SAT
9 40 00 AM

Showing Contents of CASH Records

If printing is finished remove the paper feeder from CPA (refer to steps 1 through 5 on p 83-84)

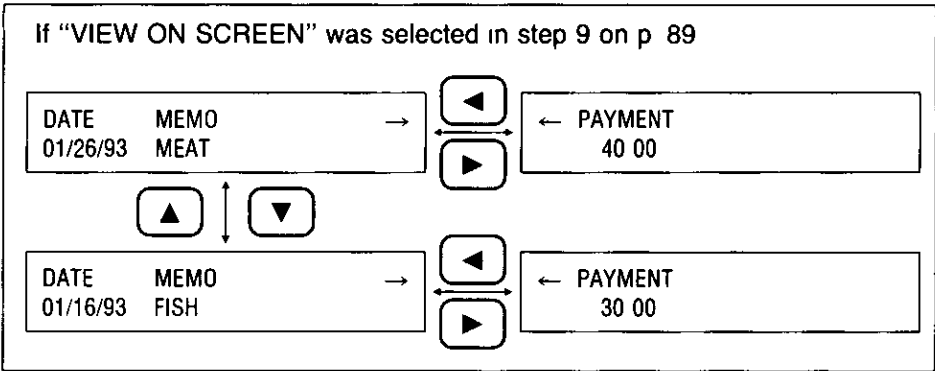

Showing Contents of ADDRESS LIST Records

All the address list records can be shown on the display or printed.

Example: You want to print an address list.

	Operation	Display/Description
1	<input type="button" value="REPORT"/>	<div style="border: 1px solid black; padding: 5px; display: flex; justify-content: space-between;"> <input type="checkbox"/> CHECK ADDRESS CARD CASH </div>
2	To select "ADDRESS" press <input type="button" value="▼"/>	<div style="border: 1px solid black; padding: 5px; display: flex; justify-content: space-between;"> <input checked="" type="checkbox"/> CHECK ADDRESS CARD CASH </div>
3	<input type="button" value="ENTER"/>	<div style="border: 1px solid black; padding: 5px;"> <input checked="" type="checkbox"/> ALL SELECT </div>
4	To select search item, Example: "ALL", press <input type="button" value="◀"/> or <input type="button" value="▶"/>	<div style="border: 1px solid black; padding: 5px;"> <input checked="" type="checkbox"/> ALL SELECT </div>
5	<input type="button" value="ENTER"/>	<div style="border: 1px solid black; padding: 5px; display: flex; justify-content: space-between;"> <input checked="" type="checkbox"/> VIEW ON SCREEN SEND TO PRINTER </div>
6	To select "SEND TO PRINTER" press <input type="button" value="▼"/>	<div style="border: 1px solid black; padding: 5px; display: flex; justify-content: space-between;"> VIEW ON SCREEN <input checked="" type="checkbox"/> SEND TO PRINTER </div>
7	<input type="button" value="ENTER"/>	<div style="border: 1px solid black; padding: 5px;"> PRINTING REPORT ... </div> <p>Printing begins.</p>
	When printing has finished this display appears.	<div style="border: 1px solid black; padding: 5px;"> <input checked="" type="checkbox"/> ALL SELECT </div>

Showing Contents of ADDRESS LIST Records

8

To return to initial display press

DONE

FEB. 27, 1993 SAT
9:45:00 AM

If printing is finished remove the paper feeder from CPA (refer to steps 1 through 5 on p. 83-84).

If "VIEW ON SCREEN" was selected in step 6 on p. 91:

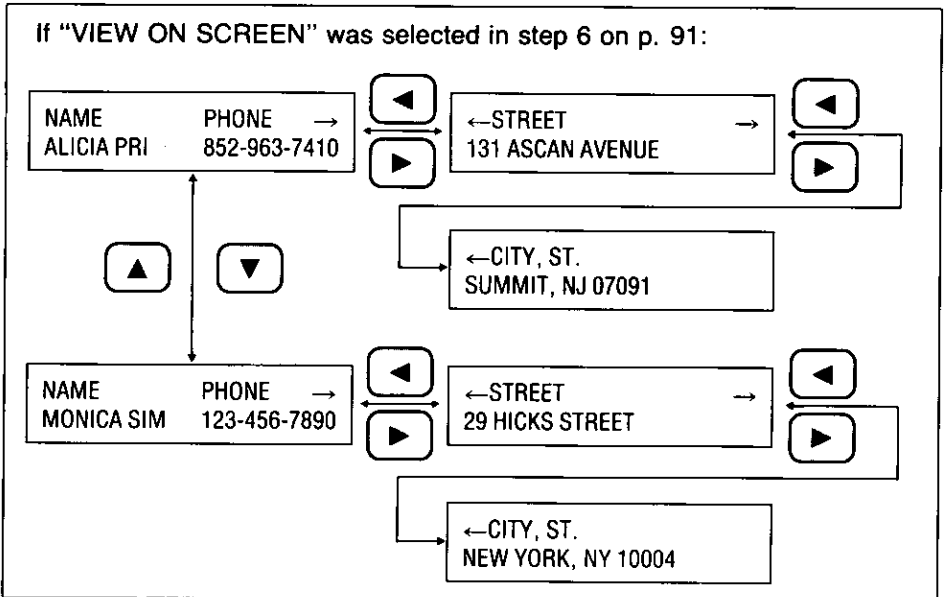





8
REPORT Function

Chapter 9



Other Functions

	Page
Showing Remaining Memory for CHECK, CARD/CASH and ADDRESS LIST	94
Showing Remaining Battery Power	94
Password	95
Entering the password	95
Operation after entering the password	96
Changing the password	97
Clearing the password	99

Showing Remaining Memory for CHECK, CARD/CASH and ADDRESS LIST

	Operation	Display/Description						
1	 → 	<table border="1"><tr><td>CHECK</td><td>3/1000</td><td>FULL</td></tr><tr><td>CARD/CASH</td><td>2/600</td><td>FULL</td></tr></table>	CHECK	3/1000	FULL	CARD/CASH	2/600	FULL
CHECK	3/1000	FULL						
CARD/CASH	2/600	FULL						
2	To show memory for ADDRESS LIST press 	<table border="1"><tr><td>ADDRESS</td><td>2/110</td><td>FULL</td></tr></table>	ADDRESS	2/110	FULL			
ADDRESS	2/110	FULL						
3	To return to initial display press 	<table border="1"><tr><td>FEB 25, 1993 THU</td></tr><tr><td>08 30 54 AM</td></tr></table>	FEB 25, 1993 THU	08 30 54 AM				
FEB 25, 1993 THU								
08 30 54 AM								

Showing Remaining Battery Power

	Operation	Display/Description		
1	 → 	<table border="1"><tr><td>NI-CD BATTERY</td></tr><tr><td>EMP ■■■□ FULL</td></tr></table> <ul style="list-style-type: none">•When AC adaptor is inserted the display shows "CHARGING " for a few seconds then returns to the previous displayIf Ni-Cd battery is full, the display shows remaining battery power	NI-CD BATTERY	EMP ■■■□ FULL
NI-CD BATTERY				
EMP ■■■□ FULL				

CAUTION: The remaining battery power may be shown incorrectly when used under unusual high or low temperature













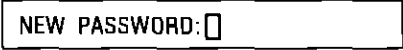

Password

If you do not want others to operate CPA enter a password.

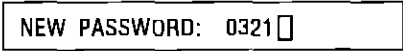
CAUTION: If you forget your password you have to use the "All Reset" on p. 17 to 18.
Using the "All Reset" also clears all memory that has been entered.

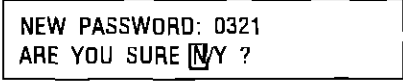
Entering the password

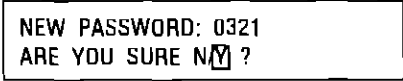
Example: You want to enter the password "0321".

	Operation	Display/Description
1		
2	To select "PASSWORD" press  three times.	
3		
4	Enter password (up to 7 letters/numbers). Example:    	
5		
6	 or 	
7	To return to SETUP menu press  .	

The password has been entered.

Password

8

To return to initial display press

DONE

FEB. 25, 1993 THU
08:38:44 AM

Operation after entering the password

Once the password has been entered CPA will ask you the password next time you try to operate it.

Operation

Display/Description

1

Press any key

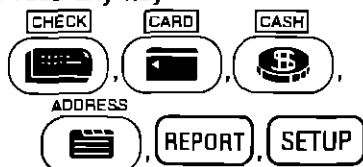

ENTER PASSWORD:

2

Enter password.

Example:



ENTER PASSWORD:

3

ENTER

Now CPA may be operated.

■ If a wrong password is entered:

* INVALID PASSWORD *

CPA can not be operated.
Confirm the password again.

Changing the password

Example: You want to change the password from "0321" to "Q30A".

Operation	Display/Description						
1 <input type="button" value="SETUP"/>	<table border="1"> <tr> <td><input type="checkbox"/> DATE</td> <td>CHECK</td> <td>CARD</td> </tr> <tr> <td>CONTRAST</td> <td></td> <td>MORE ↓</td> </tr> </table> <p>• If the display shows "ENTER PASSWORD" enter the preset password.</p>	<input type="checkbox"/> DATE	CHECK	CARD	CONTRAST		MORE ↓
<input type="checkbox"/> DATE	CHECK	CARD					
CONTRAST		MORE ↓					
2 To select "PASSWORD" press <input type="button" value="▼"/> three times.	<table border="1"> <tr> <td>PAYLIST</td> <td>PRINTER</td> <td>LINK</td> </tr> <tr> <td><input type="checkbox"/> PASSWORD</td> <td></td> <td>MORE ↑</td> </tr> </table>	PAYLIST	PRINTER	LINK	<input type="checkbox"/> PASSWORD		MORE ↑
PAYLIST	PRINTER	LINK					
<input type="checkbox"/> PASSWORD		MORE ↑					
3 <input type="button" value="ENTER"/>	<table border="1"> <tr> <td>ENTER PASSWORD: <input type="text"/></td> </tr> </table>	ENTER PASSWORD: <input type="text"/>					
ENTER PASSWORD: <input type="text"/>							
4 Enter old password. Example: <input type="button" value="0"/> <input type="button" value="3"/> <input type="button" value="2"/> <input type="button" value="1"/>	<table border="1"> <tr> <td>ENTER PASSWORD: <input type="text"/></td> </tr> </table>	ENTER PASSWORD: <input type="text"/>					
ENTER PASSWORD: <input type="text"/>							
5 <input type="button" value="ENTER"/>	<table border="1"> <tr> <td>0321</td> <td>CHANGE PASSWORD <input type="checkbox"/> Y ?</td> </tr> </table>	0321	CHANGE PASSWORD <input type="checkbox"/> Y ?				
0321	CHANGE PASSWORD <input type="checkbox"/> Y ?						
6 <input type="button" value="▶"/> or <input type="button" value="Y"/>	<table border="1"> <tr> <td>0321</td> <td>CHANGE PASSWORD <input checked="" type="checkbox"/> Y ?</td> </tr> </table>	0321	CHANGE PASSWORD <input checked="" type="checkbox"/> Y ?				
0321	CHANGE PASSWORD <input checked="" type="checkbox"/> Y ?						
7 <input type="button" value="ENTER"/>	<table border="1"> <tr> <td>NEW PASSWORD: <input type="text"/></td> </tr> </table>	NEW PASSWORD: <input type="text"/>					
NEW PASSWORD: <input type="text"/>							
8 Enter new password. Example: <input type="button" value="Q"/> <input type="button" value="3"/> <input type="button" value="0"/> <input type="button" value="A"/>	<table border="1"> <tr> <td>NEW PASSWORD: Q30A <input type="text"/></td> </tr> </table>	NEW PASSWORD: Q30A <input type="text"/>					
NEW PASSWORD: Q30A <input type="text"/>							

Password

- 9

NEW PASSWORD Q30A
ARE YOU SURE ?
- 10 or

NEW PASSWORD Q30A
ARE YOU SURE ?
- 11















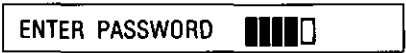

PAYLIST PRINTER LINK
ASSWORD MORE ↑

The password has been
changed
- 12 To return to initial display press

FEB 25, 1993 THU
08 30 54 AM

Clearing the password

Make CPA operational without a password

Operation	Display/Description
1 	
2 To select "PASSWORD" press  three times	
3 	
4 Enter password Example 	
5 	
6  or 	
7 	
8 Leave it blank press 	 The password has been deleted

Next time CPA is turned on it won't ask you for the password



Chapter 10

Transferring Data to Another CPA Unit

	Page
Connecting CPA to Another CPA Unit	102
Setting the Link Parameter	104
Transferring Data	105

Connecting CPA to Another CPA Unit

KX-RC20 (optional), an interface cable for data transfer with another CPA unit, must be purchased before data can be transferred

1. Turn off both CPA units

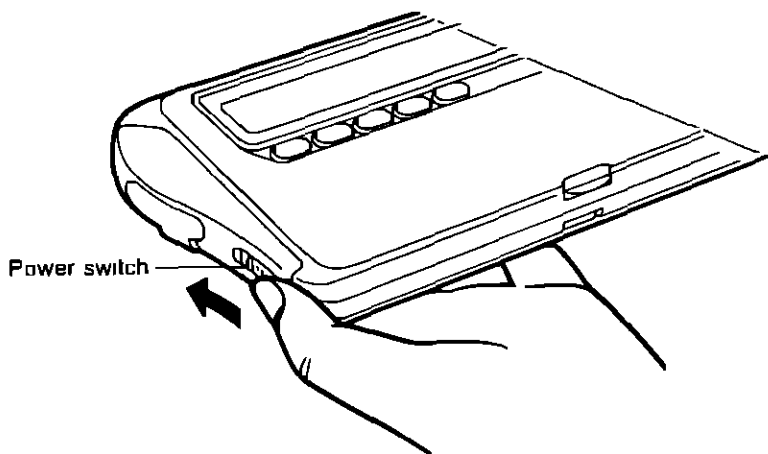

2. Open the jack covers of both CPA units

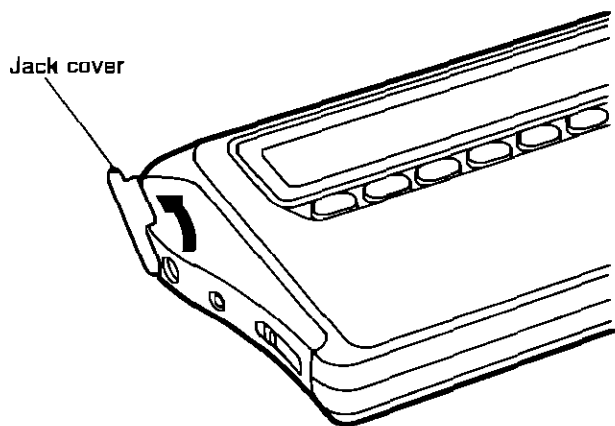

- When a cable is not plugged into the jacks, be sure to insert the jack covers. Dust or dirt particles may get into them or static electricity may occur around them.

Connecting CPA to Another CPA Unit

3. Plug the interface cable into the interface connectors of both CPA units. Be sure to plug the cable in securely.

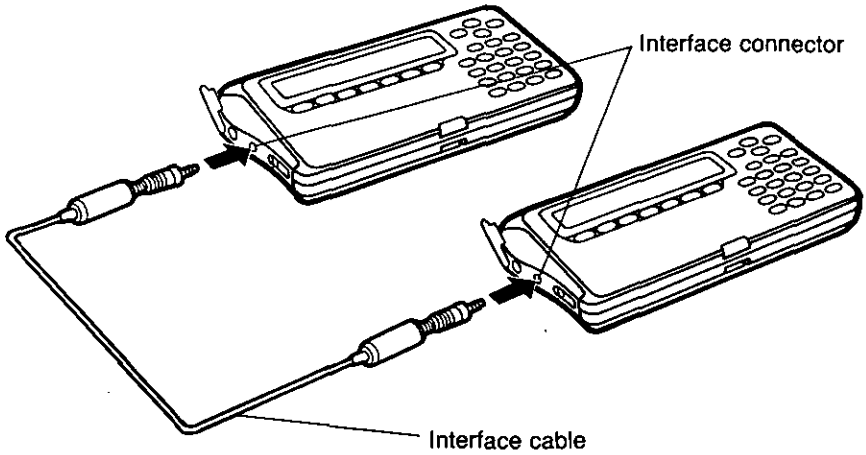

4. Turn on both CPA units.

Setting the Link Parameter

Before starting, confirm that the baud rate is the same in both CPA units
 Default of baud rate is 9600

Operation

Display/Description

1

<input type="checkbox"/> DATE	CHECK	CARD
CONTRAST		MORE ↓

2 To select "LINK" press

twice,
 ↓
 twice

PAYLIST	PRINTER	<input type="checkbox"/> LINK
PASSWORD		MORE ↑

3

BAUD	2400	4800	<input checked="" type="checkbox"/> 9600
------	------	------	--

4 To select the baud rate
 (if necessary) press

or

BAUD	2400	4800	<input checked="" type="checkbox"/> 9600
------	------	------	--

5

PARITY	NONE	STOP	1BIT
LENGTH	8BITS	OK	<input checked="" type="checkbox"/> Y ?

Parity bit no parity

Stop bit 1 bit

Data length 8 bits

• These parameters are for communication with a personal computer

6 or

PARITY	NONE	STOP	1BIT
LENGTH	8BITS	OK	<input checked="" type="checkbox"/> Y ?

7

PAYLIST	PRINTER	<input type="checkbox"/> LINK
PASSWORD		MORE ↑

8 To return to initial display press

FEB 25, 1993 THU
08 38 44 AM

Set the same baud rate in another CPA unit in the same way

Transferring Data

Note: When receiving data, all existing data is deleted.

Example: You want to transfer the all data from CPA-a (sender) to CPA-b (receiver).

	Operation	Display/Description
1	CPA-a <input type="text" value="CODE"/> → <input type="text" value="L"/>	LINK: <input checked="" type="checkbox"/> SEND RECEIVE PRESS DONE KEY TO EXIT
2	<input type="text" value="ENTER"/>	<input checked="" type="checkbox"/> ALL CHECK CARD/CASH ADDRESS
3	To select "ALL" (if necessary) press <input type="text" value="◀"/> or <input type="text" value="▶"/>	<input checked="" type="checkbox"/> ALL CHECK CARD/CASH ADDRESS
4	CPA-b <input type="text" value="CODE"/> → <input type="text" value="L"/>	LINK: <input checked="" type="checkbox"/> SEND RECEIVE PRESS DONE KEY TO EXIT
5	To select "RECEIVE" press <input type="text" value="▶"/>	LINK: SEND <input checked="" type="checkbox"/> RECEIVE PRESS DONE KEY TO EXIT
6	<input type="text" value="ENTER"/>	EXISTING DATA SHOULD BE DELETED CONTINUE <input checked="" type="checkbox"/> N/Y ?
7	To select "Y" press <input type="text" value="▶"/> or <input type="text" value="Y"/>	EXISTING DATA SHOULD BE DELETED CONTINUE <input checked="" type="checkbox"/> N/Y ?
8	<input type="text" value="ENTER"/>	RECEIVING... PRESS DONE KEY TO EXIT

CPA-b is ready to receive the data.

• Proceed to the next step
overleaf (step 9).

Transferring Data

9

CPA-a

ENTER

SENDING
PRESS DONE KEY TO EXIT

- Press **ENTER** within 30 seconds, or link error will occur

When the data transferring is finished this display appears

END OF LINK
PRESS ANY KEY

10

To return to LINK menu press

DONE (CPA-a)

LINK **SEND** RECEIVE
PRESS DONE KEY TO EXIT

DONE (CPA-b)

LINK SEND **RECEIVE**
PRESS DONE KEY TO EXIT

11

To return to initial display press

DONE (Both CPA units)

FEB 25, 1993 THU
09 12 43 AM

10

Transferring Data

- To stop transferring data, press **DONE** on either CPA-a or CPA-b.
The display will show:

* LINK CANCELED *

On the other CPA, after a while, the display will show:

LINK ERROR !

The data on the way is gone in the CPA-b.

- When an error occurs, transferring will not start, or stop and the display shows:

LINK ERROR !

or

MEMORY FULL !

Before starting the transferring, make sure that the memory size of CPA-b is larger than the existing data size of CPA-a. If not, delete some records of CPA-a.

- Link errors occur in the following cases:
 1. Baud rate is different between CPA units.
 2. CPA units are not connected correctly by the interface cable.
 3. The address data is sent to KX-RC100.
 4. The phone data is received from KX-RC100.

Chapter 11

General Information

	Page
Troubleshooting Guide	110
Resetting CPA	112
Changing the Ribbon Cassette	113
Changing the Battery Pack	115
Specifications	117

Troubleshooting Guide

When trouble occurs, check the following points before returning CPA for service.

Trouble	Cause	Procedure
Press a key but nothing appears on the display.	CPA is not turned on.	Turn the power switch on. (p. 16)
Turn on the power switch, but nothing appears on the display.	The battery is not charged.	Charge the battery for about three (3) hours. (p. 12)
	The battery pack is not installed.	Install the battery pack. (p. 115)
	The protective sheet has not been removed from the battery terminal.	Remove the protective sheet. (p. 6)
	The power switch is not operated correctly.	Try turning on again following procedure on p.16. If nothing appears on the display, press the reset switch with a pointed object like the tip of a pen (p. 112) then slide the power switch again.
The remaining battery amount is incorrectly displayed.	The battery has become inactive.	Keep operating CPA until "WEAK BATTERY" is displayed then recharge the battery. (p. 12)
The display shows "INSERT AC ADAPTOR" and CPA will not accept any key function.	The battery is empty.	Plug in the AC adaptor and charge the battery for about three (3) hours. (p. 12)

Troubleshooting (continued)

Trouble	Cause	Procedure
The display shows "CHANGE LITHIUM BATTERY" and CPA will not accept any key function.	The life of the lithium battery is terminated.	Go to a service center to have the battery pack exchanged. (See the included list of authorized service centers.)
CPA does not print correctly or printing is blurred.	The ribbon cassette is not installed or is installed incorrectly.	Install the ribbon cassette correctly. (See p. 113)
	The ribbon cassette is run out.	Replace with new ribbon cassette. (See P. 113)
The printing positions are not correct.	Setting the printing positions is wrong.	Set the printing positions correctly. (See p. 26)
A check is not fed.	A check is not set on the printer correctly.	Set a check on the printer correctly. (See p. 35)
The display shows "MEMORY ERROR". CPA does not operate properly, or memory may contain garbled characters.	Noise on the AC line or static electricity may prevent CPA from operating properly.	Turn the power switch off for a few seconds then turn the power switch on again. If the CPA does not function properly, reset the CPA (p. 112), and then print the records on the paper roll. If the CPA still does not function properly, perform a total reset following the procedure on p. 17.

Troubleshooting

Resetting CPA

There are two ways to reset CPA:

- Reset and clear all memory (see p. 17).
- Reset without disturbing the memory (see below).

Reset without disturbing the memory

If CPA is exposed to intense noise or a strong shock during operation it may get out of order and not accept any key function. When this occurs, follow the procedures below to reset CPA without harming the memory.

1. Open the bottom cover by sliding the bottom cover knob to the right.

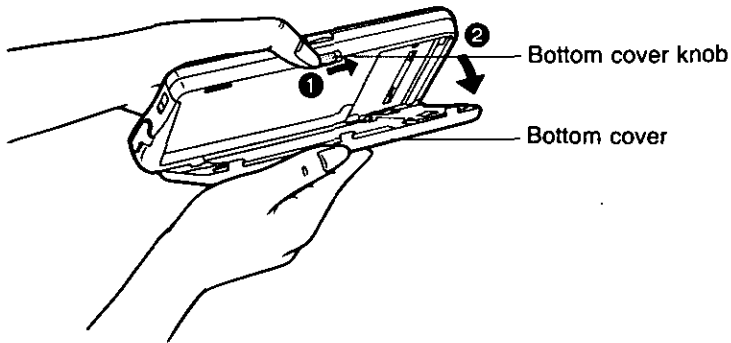

2. Press the reset switch with a sharp object like the point of a pen.

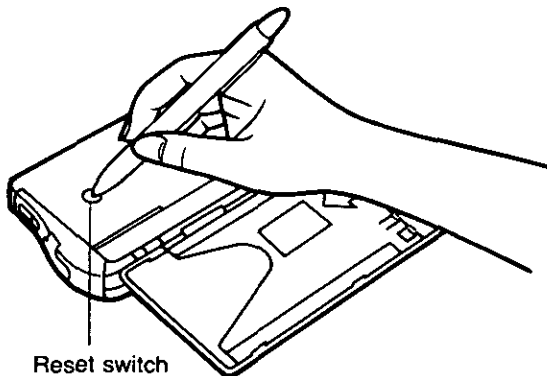

Changing the Ribbon Cassette

When the printing starts to fade, purchase a new ribbon cassette, KX-RC10 (optional), and replace with the new ribbon cassette.

(Use only Panasonic KX-RC10. Other ribbons may damage the unit.)

1. Open the bottom cover by sliding the bottom cover knob to the right.

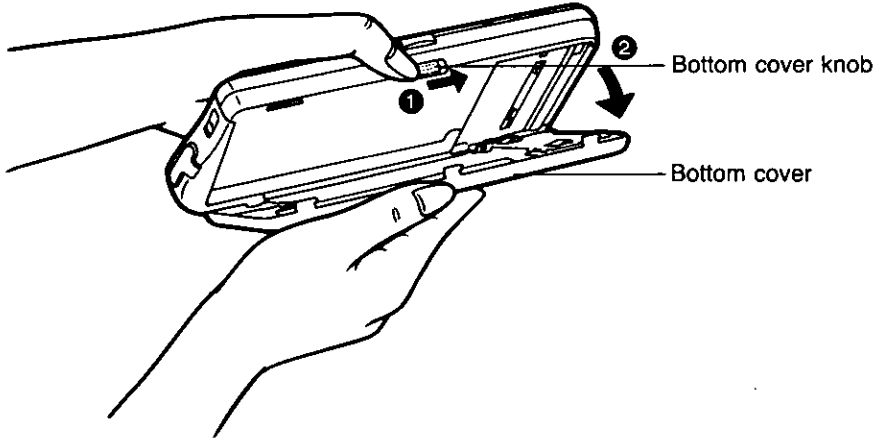

2. Push the printer open lever and pull up the printer as indicated by the arrows.

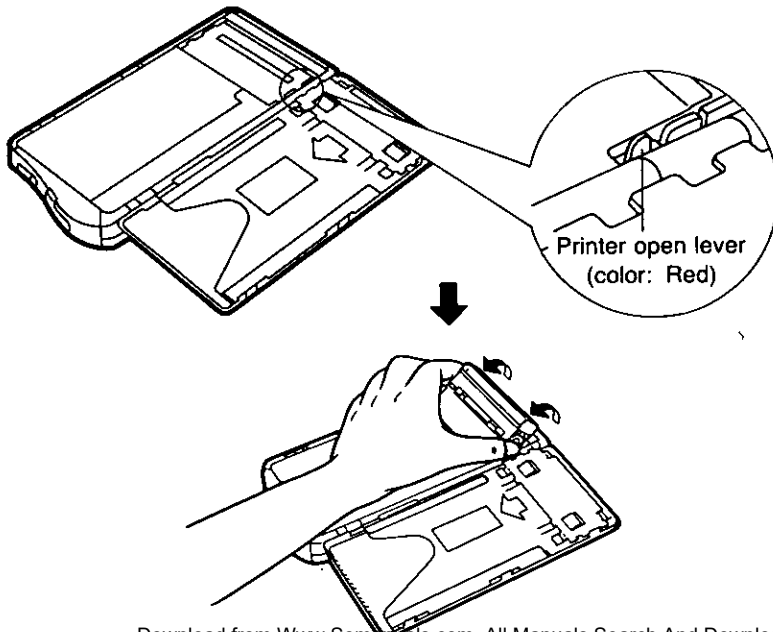

Changing the Ribbon Cassette

3. Remove the old cassette and install a new one.
NOTE: Do not touch the printhead.

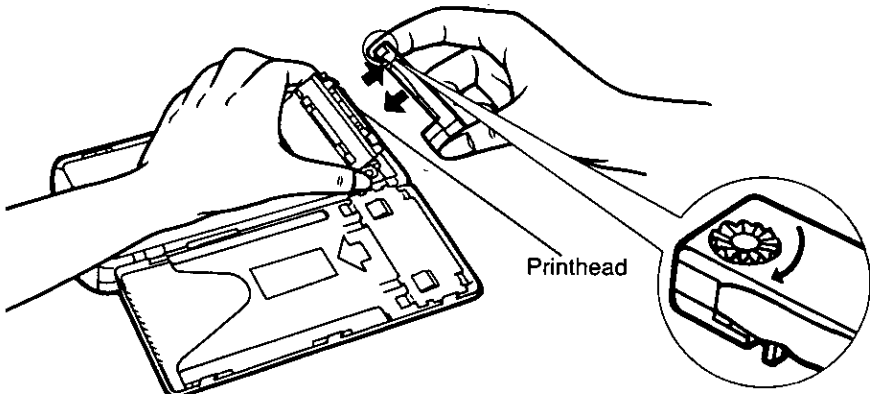

Wind the ribbon with your finger in the direction of the arrow before and after installing the cassette.

4. Press the printer down until it clicks into place.

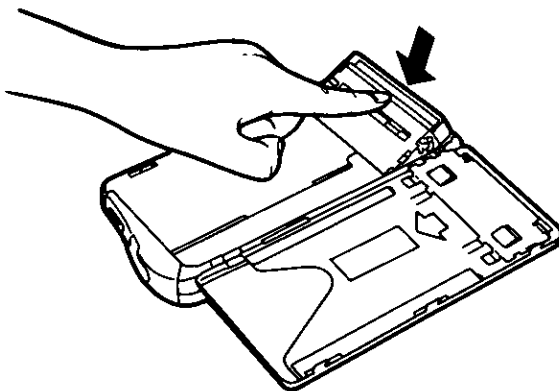

Changing the Battery Pack

Even though operated and charged correctly, the battery life will terminate. When this occurs, purchase a new Ni-Cd battery pack, KX-RC30 (optional), and replace the old battery pack.

1. Turn off CPA and unplug the AC adaptor.

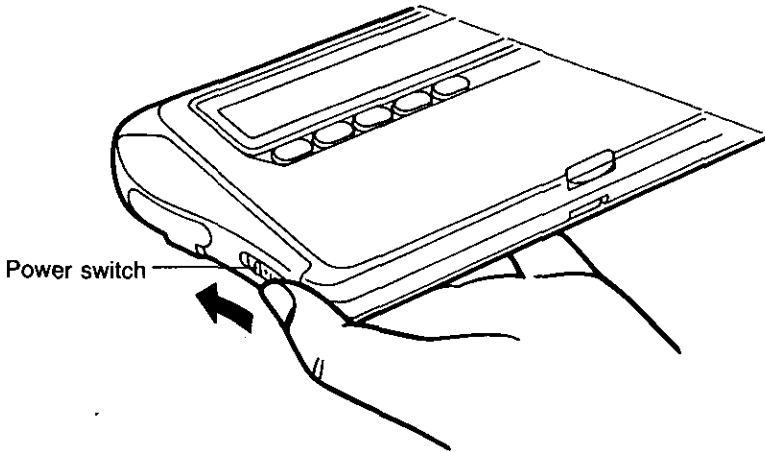

2. Open the bottom cover and remove the battery pack screw.

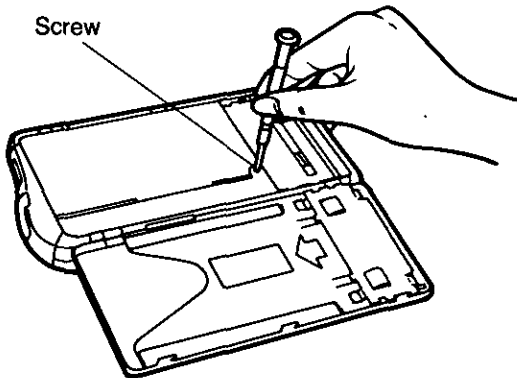

Changing the Battery Pack

3. Remove the old battery pack and install the new one

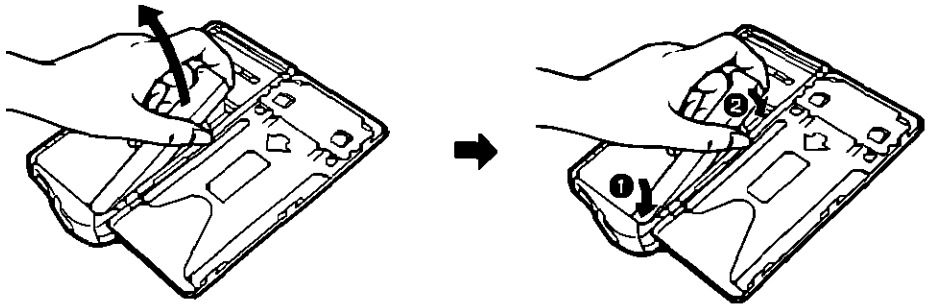

4. Replace and tighten the screw

After exchanging the battery pack be sure to plug in the AC adaptor and recharge the battery for about three (3) hours

Because the remaining battery amount will be incorrectly displayed

CAUTION: To reduce the risk of fire or injury, read and follow these instructions carefully

- Never disassemble or modify the battery pack. It is made of strong alkali and may irritate skin or damage clothes
- Never short-circuit the battery pack. Overheating the battery pack may cause burns
- Never dispose of the battery pack in a fire. It may explode
- Never try to recharge the battery without the pack unit. Always recharge the entire battery pack CPA

Specifications

CHECK Memory	: 2 bank names 1000 checks
CARD/CASH Memory	: 10 card names 600 entries
ADDRESS LIST Memory	: 110 address lists
Clock	: Year, month, day, day of the week, hour, AM/PM From 1992 to 2091 \pm 30 seconds/month (at 25°C)
Calculation	: Up to 10 digits: Addition, Subtraction, Multiplication, Division
Printer	: 4-pin dot matrix printer
Print Speed	: About 20 seconds/check
Ribbon	: Fabric ribbon
Display	: Liquid Crystal Display
Display Size	: 23-character \times 2-line
Interface	: Interface capability with other CPA units (Using optional KX-RC20); Interface capability with a personal computer (Using optional KX-RC21)
Power Requirements	: AC 120 V \pm 10%, 60 Hz, Ni-Cd Battery (For memory back-up: lithium battery)
Auto Shut-OFF	: After about 5 minutes with battery unit
Memory Life	: Minimum 5 years (with lithium battery)
Power Consumption	: Refer to the nameplate on the bottom of CPA
Operating Temperature	: 5°C (41°F) to 35°C (95°F)
Operating Humidity	: 20 to 80% RH
Storage Temperature	: -20°C (-4°F) to 60°C (140°F)
Dimensions	: 183 (W) \times 88 (D) \times 29.8 (H) mm { 7 $\frac{7}{32}$ " (W) \times 3 $\frac{15}{32}$ " (D) \times 1 $\frac{3}{16}$ " (H)}
Mass {Weight}	: 0.385 kg (0.85 lb)

General Information

11

Chapter 12

Appendix

	Page
List of Display Messages	120
List of Code Key Functions	123
Category List	125
Options	126
Index	127

List of Display Messages

Message	Description
ACCOUNT ALREADY ENTERED . . .	The same account name is already entered.
* ADDRESS DATABASE FULL *	Address list database is full.
ALL CARD CHARGE DELETED CONTINUE N/Y ?	All records relating to this card will be deleted. Do you want to continue?
ARE YOU SURE N/Y ?	Are you sure you want to change the password?
BUILDING REPORT...	The machine is building a report.
* CARD DATABASE FULL *	Card database is full.
* CASH DATABASE FULL *	Cash database is full.
CHANGE LITHIUM BATTERY ! . . .	Please change the lithium battery.
CHANGE PASSWORD N/Y ?	Do you want to change the password?
CHARGING...	Charging the Ni-Cd battery.
CHECK ALREADY ENTERED	The same check number has already been entered.
* CHECK DATABASE FULL *	Check database is full.
CHECK NOT INSERTED CONTINUE N/Y ?	A check has not been placed inside the printing area.
DELETE ALL DATA N/Y ?	Do you want to delete all data?
DELETE RECORD N/Y ?	Are you sure you want to delete the record?
* DELETED *	The record has been deleted.
END OF LINK PRESS ANY KEY	Sending or receiving is done.
END OF TRANSACTION	This line is the end of the transaction.
[ERROR]	Error has occurred during calculating.
* ERROR *	
BALANCE OVERFLOW	Will be displayed if consecutive payments or deposits exceed 99,999.99.

List of Display Messages

Message	Description
EXISTING DATA SHOULD BE DELETED CONTINUE N/Y ?	This action deletes existing data Are you sure?
INSERT AC ADAPTOR THEN PRESS ANY KEY	Insert AC adaptor and recharge the Ni-Cd battery
* INVALID PASSWORD *	Invalid password was entered
* LINK CANCELED *	Sending or receiving is canceled
LINK ERROR ! PRESS ANY KEY	Error has occurred while sending or receiving data
[MEMORY]	Data is stored in memory
MEMORY ERROR ! PRESS ANY KEY	Data in memory is damaged
MEMORY FULL ! PRESS ANY KEY	Memory became full while receiving data
* NO CARD RECORDS *	There are no card records in memory
* NO CASH RECORDS *	There are no cash records in memory
* NO CHECK RECORDS *	There are no check records in this account
NO NI-CD BATTERY ! PRESS ANY KEY	Ni-Cd battery is not connected
NO PAYEE LIST ENTRIES	There are no payee list entries in memory
* NOT FOUND *	The required record is not found
* NUMBER MUST BE 1-25 *	Payee list number must be 1 to 25
PAPER NOT INSERTED CONTINUE N/Y ?	Paper roll is not inserted
* PRINT CANCELED *	Print is canceled

List of Display Messages

Message	Description
PRINT CHECK N/Y ?	Will you print the check?
* PRINTER ERROR *	
CANNOT PRINT A DEPOSIT	You cannot print the deposit data.
* PRINTER ERROR *	
CHECK ALREADY PRINTED	This check has already been printed.
* PRINTER ERROR *	
CHECK IS VOIDED	This check has been voided.
* PRINTER ERROR *	
COVER OPEN	The cover is open.
* PRINTER ERROR *	
PRINTER NOT READY	Something is wrong with the printer.
PRINTING...	
PLEASE ENDORSE CHECK !	The check is printing.
PRINTING AREA OVER	
CONTINUE N/Y ?	Printing will exceed the area. Do you want to continue?
PRINTING REPORT...	The machine is printing the report.
RECEIVING...	
PRESS DONE KEY TO EXIT	The machine is receiving data via transfer.
RECHARGE NI-CD BATTERY !	
PRESS ANY KEY	Recharge the Ni-Cd battery.
SEARCHING...	Searching the records.
SENDING...	
PRESS DONE KEY TO EXIT	The machine is sending the data via transfer.
WEAK LITHIUM BATTERY !	
PRESS ANY KEY	Lithium battery is getting weak.
WEAK NI-CD BATTERY !	
PRESS ANY KEY	Ni-Cd battery is getting weak.











List of Code Key Functions

- CODE **B** Shows the remaining battery power on the display.
When AC adaptor is inserted the display shows "CHARGING..." for a few seconds.
If Ni-Cd battery is full, the display shows remaining battery power.
- CODE **L** Sends (receive) data to (from) another CPA unit or to a personal computer.
- CODE **M** Shows the remaining CHECK, CARD/CASH and ADDRESS LIST memory.
- CODE **V** Voids a check.
- CODE **DELETE** Deletes a CHECK/CARD/CASH/ADDRESS LIST record.
Deletes current entry or moves cursor to the first column.
- CODE **▲** Jumps up to the previous CHECK/CARD/CASH/ADDRESS LIST record.
- CODE **▼** Jumps down to the next CHECK/CARD/CASH/ADDRESS LIST record.
- CODE **AC/C** Enters " ".
- CODE **R-CM** Enters " ^ ".
- CODE **M+** Enters " ~ ".
- CODE **7** Enters " @ ".
- CODE **8** Enters " % ".
- CODE **9** Enters " \ ".
- CODE **÷** Enters " / ".
- CODE **4** Enters " ¥ ".

• These five accent symbols (" " " " ") can only be used in combination with the characters shown.

Ä	Ë	Ö	Ü
À	É	Ó	Ú
Â	Ê	Ô	Û
Ã	Ë	Ö	Ü
Ñ			

List of Code Key Functions

CODE		Enters "#".
CODE		Enters "/".
CODE		Enters "&".
CODE		Enters "(".
CODE		Enters ")".
CODE		Enters "*".
CODE		Enters "ç".
CODE		Enters ":".
CODE		Enters ", ,".
CODE		Enters "'".
CODE		Enters "\$".

Category List

The 50 categories are listed in the alphabetical order.

A	AUTO AUTO FUEL AUTO LOAN AUTO SERVICE	L	LATE FEES
B	BANK CHARGE BONUS	M	MEDICAL MISC MORTGAGE
C	CHARITY CHILDCARE CHRISTMAS CLOTHING COMMISSION	O	OTHER EXP OTHER INCM
D	DINING DIVIDND INCM DUES	R	RECREATION RENT PAID REPAIRS
E	EDUCATION ENTERTAIN	S	SALARY SUBSCRIPT SUPPLIES
G	GIFT RECVD GIFTS GROCERIES	T	TAX TAX FEDERAL TAX FICA TAX OTHER TAX PROPERTY TAX STATE TELEPHONE TRAVEL
H	HOME REPAIR HOUSEHOLD HOUSING	U	UTILITIES UTL GAS/ELEC UTL WATER
I	INSURANCE INT INCM INT PAID INVEST EXP INVEST INCM		

Options

The following options are available through your local authorized parts distributor.

Part No.	Description	Comment
KX-RC10	Fabric ribbon	1 unit
KX-RC20	Interface cable for data transfer with other CPA units	1 unit
KX-RC21	Interface adaptor for data transfer with a personal computer	1 unit
KX-RC30	Ni-Cd battery pack	1 unit

Index

A

AC adaptor	6, 12
Accessories	6
ADDRESS key	11
ADDRESS LIST	69
Auto shut-off	16

B

Bank names	22
Battery pack, changing	115
Bottom cover	10
Bottom cover knob	10, 35

C

CALC key	11
Calculation	
basic	66
keys	11
memory	67
CALCULATOR	65
CARD key	11
Card list	50
CASH	59
CATEGORY	31
Category list	125
Charging	12
Check	
insert	35
issuing	31
storage area	10, 36
with duplicate copies	35
CHECK key	11
CLASS	31
Clock	19
CODE key	11
Code key function	123

Connecting	
CPA	16
household AC	16
Credit card	52
Cursor keys	11

D

DC IN jack	10, 12
DELETE key	11
Deleting	
ADDRESS LIST	75
CARD record	57
CHECK record	47
CASH record	64
Deposit	39
Display	10
Display contrast	20
Display message	120
DONE key	11

E

ENTER key	11
-----------	----

F

Figure keys	11
FIND key	11
FIRST bank	22
Function keys	11

G

Guide tabs	10, 35
------------	--------

Index

H

Household AC 12

I

Interface
 cable 102
 connector 10

J

Jack cover 10

K

Keyboard 10, 11

L

Lid sensor 10

M

Memory, remaining
 ADDRESS LIST 94
 Battery power 94
 CARD 94
 CASH 94
 CHECK 94

N

Ni-Cd battery 10, 12

O

Options 126

P

Paper roll 6, 78
Paper feeder 6, 78
Paper sensor 10
Part names 10
Password
 Changing 97
 Clearing 99
 Entering 95
 Operation 96
Payee list 24
Platen 10
Power switch 10
Precautions 8
Primary bank 22
PRINT key 11
Print position 26
Printer 10, 78
Printer
 open lever 113
 parts 10
Printing check 35
Protective sheet 6

R

Rechargeable battery	13
RECON key	11
Reconciling check	45
REPORT	77
REPORT key	11
Reset switch	10
Resetting	17, 112
Ribbon cassette	10
Ribbon cassette, changing	113

S

Searching	
ADDRESS LIST record	73
CARD record	55
CASH record	62
CHECK record	43
SECOND bank	22
Setting clock	19
SETUP key	11
Showing	
ADDRESS LIST record	91
CARD record	85
CASH record	88
CHECK record	80
SPACE key	11
Specifications	117
Sub-function keys	11

T

TAX	31
Template	6, 26
Template ruler	29
Transferring data	101
Troubleshooting	110
Turning off	16
Turning on	16

U

Upper cover	10
-------------------	----

V

Voiding check	46
---------------------	----

Servicenter Directory

PRODUCT INFORMATION • OPERATION ASSISTANCE • LITERATURE REQUESTS • DEALER LOCATIONS

DIAL TOLL FREE: 1-800-CPA-7033 (1-800-272-7033)

Customer Service Center 2F-3, One Panasonic Way, Secaucus, NJ 07094 (Headquarters)

201-348-9090 (9:00am–8:00pm Monday–Friday, EST)

SERVICE INQUIRIES

Regional Customer Care Department

NORTHEAST

2221 Cabot Boulevard West
Suite A
Langhorne, PA 19047
215-741-0676

Covers:

CT, DE, ME, MD, MA,
NH, NJ, NY, PA, RI, VT,
VA, DC, WV, Eastern OH

MIDWEST

1703 North Randall Road
Elgin, IL 60123
708-468-5530

Covers:

IL, IN, IA, KS, KY, MI,
MN, MO, NE, ND, SD,
WI, Western OH

WESTERN

6550 Katella Avenue
Cypress, CA 90630
714-373-7440

Covers:

AK, AZ, CA, CO, ID,
MT, NV, NM, OR, UT,
WA, WY, HI

SOUTHERN

1854 Shackelford Court
Suite 4105
Norcross, GA 30093
404-717-6628

Covers:

AL, AR, FL, GA, LA,
MS, NC, OK, SC, TN, TX

PRODUCT SERVICE

Factory Servicenters

TENNESSEE

919-Bth Avenue South
Nashville, TN 37203
615-244-4434

AUTHORIZED SERVICENTERS • PARTS DISTRIBUTOR LOCATIONS

To locate an independent authorized servicenter or parts distributor in your area, within the USA dial toll free **1-800-545-2672**, 24 hours a day, 7 days a week.

ACCESSORY PURCHASES

1-800-332-5368 (Consumer Orders Only)

Matsushita Services Company Box 01, 545 Tollgate Road Suite C, Elgin, IL 60123

(8:00am–7:30pm Monday–Thursday; 8:00am–5:00pm Friday; 9:00am–12:30pm Saturday; CST)

(Visa, Mastercard, Discover card, Check or Money Order)

If you ship the product

Carefully pack and send it prepaid, adequately insured and preferably in the original carton. Attach a postage-paid letter, detailing the complaint, to the outside of the carton. **DO NOT send the product to the Executive or Regional Sales offices. They are NOT equipped to make repairs.**

PANASONIC COMPANY, DIVISION OF
MATSUSHITA ELECTRIC CORPORATION
OF AMERICA

One Panasonic Way Secaucus, New Jersey
07091

PANASONIC COMPANY (WEST) OF
AMERICA, DIVISION OF MATSUSHITA
ELECTRIC CORPORATION OF AMERICA

6550 Katella Avenue Cypress, CA 90630

PANASONIC CHECK PRINTING ACCOUNTANT LIMITED WARRANTY

Panasonic Company or Panasonic Company (West) of America (collectively referred to as "Panasonic") will repair this product with new or rebuilt parts, free of charge, in the U.S.A. from the date of the original purchase in the event of a defect in materials or workmanship as follows:

Check Printing Accountant—For One (1) Year.

Batteries (When applicable)—New rechargeable batteries in exchange for defective rechargeable batteries—For ten (10) days.
Non-rechargeable batteries are not warranted.

One (1) Year Extended Warranty on Lithium Battery—New lithium battery in exchange for a defective lithium battery during the second (2nd) year after the original purchase; purchaser pays for all labor charges for removal and installation of the lithium battery.

Carry-in or Mail-in service in the continental U.S.A. can be obtained during the warranty period by contacting a Matsushita Services Company (MSC) Factory Servicenter listed in the Servicenter Directory. Or call 1-800-545-2672, toll free, to locate an authorized MSC Servicenter.

This Warranty is extended only to the original purchaser. A purchase receipt or other proof of date of original purchase will be required before warranty performance is rendered.

This warranty only covers failures due to defects in materials or workmanship which occur during normal use and does not cover the print ribbon or damage which occurs in shipment or failures which are caused by products not supplied by Panasonic or failures which result from accident, misuse, abuse, neglect, mishandling, misapplication, interfacing, set-up, adjustments, improper maintenance, line power surge, introduction of sand, dust, humidity and

liquids, modification, or commercial use of the product, such as hotel, office or rental use of the product, or service by anyone other than an MSC Factory Servicenter or damage that is attributable to acts of God.

LIMITS AND EXCLUSIONS

There are no express warranties except as listed above. PANASONIC SHALL NOT BE LIABLE FOR INCIDENTAL, CONSEQUENTIAL OR PUNITIVE DAMAGES, INCLUDING, WITHOUT LIMITATION, LOSS OF GOODWILL, PROFITS OR REVENUE, LOSS OF USE OF THIS PRODUCT OR ANY ASSOCIATED EQUIPMENT, COST OF SUBSTITUTE EQUIPMENT, DOWNTIME COSTS, OR CLAIMS OF ANY PARTY DEALING WITH BUYER FOR SUCH DAMAGES, RESULTING FROM THE USE OF THIS PRODUCT, OR ARISING OUT OF ANY BREACH OF THIS WARRANTY OR CONTRACT, NEGLIGENCE, OR ANY OTHER LEGAL THEORY. ALL EXPRESS AND IMPLIED WARRANTIES, INCLUDING THE WARRANTIES OF MERCHANTABILITY, ARE LIMITED TO THE APPLICABLE PERIOD SET FORTH ABOVE. Some states do not allow the exclusion or limitation of incidental or consequential damage, or limitations on how long an implied warranty lasts, so the above exclusions or limitations may not apply to you.

This warranty gives you specific legal rights and you may also have other rights which vary from state to state.

If a problem with this product develops during or after the warranty period, you may contact your dealer or Servicenter. If the problem is not handled to your satisfaction, then write to the Customer Service Center at the company address indicated above.

Panasonic Company
Division of Matsushita Electric Corporation of America
One Panasonic Way, Secaucus, New Jersey 07094

Panasonic Company (West) of America
Division of Matsushita Electric Corporation of America
6550 Katella Avenue, Cypress, California 90630

PJQX6618ZA F0693W0 

Free Manuals Download Website

<http://myh66.com>

<http://usermanuals.us>

<http://www.somanuals.com>

<http://www.4manuals.cc>

<http://www.manual-lib.com>

<http://www.404manual.com>

<http://www.luxmanual.com>

<http://aubethermostatmanual.com>

Golf course search by state

<http://golfingnear.com>

Email search by domain

<http://emailbydomain.com>

Auto manuals search

<http://auto.somanuals.com>

TV manuals search

<http://tv.somanuals.com>