



Panasonic

Operating Instructions

Check Printing Accountant™

MODEL NO. **CPA**
KX-RC95



Please read before using.

Thank you for purchasing the Panasonic Check Printing Accountant KX-RC95.

Note:

This equipment has been tested and found to comply with the limits for a Class B digital device, pursuant to Part 15 of the FCC Rules. These limits are designed to provide reasonable protection against harmful interference in a residential installation. This equipment generates, uses and can radiate radio frequency energy and, if not installed and used in accordance with the instructions, may cause harmful interference to radio communications. However, there is no guarantee that interference will not occur in a particular installation. If this equipment does cause harmful interference to radio or television reception, which can be determined by turning the equipment off and on, the user is encouraged to try to correct the interference by one or more of the following measures:

Reorient or relocate the receiving antenna.

Increase the separation between the equipment and receiver.

Connect the equipment into an outlet on a circuit different from that to which the receiver is connected.

Consult the dealer or an experienced radio/TV technician for help.

FCC Warning: To assure continued FCC compliance, the user must use only shielded interfacing cables when connecting to computer or peripheral. Also, any unauthorized changes or modifications to this equipment would void the users authority to operate.

CAUTION: AC ADAPTOR (KX-WZ4) IS FOR INDOOR USE ONLY.

Caution, since your Check Printing Accountant has been designed to hold your personal checks, you should be as careful as you would be of your checkbook. If you should lose your Check Printing Accountant, be sure to notify your bank as to the numbers of the lost checks.

■ Macintosh is a registered trademark of Apple Computer, Inc.

NOTICE

- Panasonic strongly recommends that separate permanent written records be kept of all important data. Data may be lost or altered in virtually any electronic memory product under certain circumstances. Panasonic assumes no responsibility for data lost or otherwise rendered unusable for any reason, including without limitation, defect, repair, improper use, battery replacement, use after the specified battery life has expired, or any other reason. See limited warranty for details.
- Panasonic assumes no responsibility, directly or indirectly, for financial losses or claims from third persons resulting from the use, loss or misuse of this product.

WARNING: TO PREVENT FIRE OR SHOCK HAZARD,
DO NOT EXPOSE THIS PRODUCT TO RAIN
OR ANY TYPE OF MOISTURE.

- It is recommended that you periodically print the content of the memory of your Check Printing Accountant, so that you will have a permanent record in the event of any unexpected memory loss.

The serial number of this unit may be found on the upper label located on the back side.

Write this number below and keep this book along with your proof of purchase to serve as a permanent record of your purchase or for future reference.

MODEL NO. **KX-RC95** _____
SERIAL NO. _____
NAME OF DEALER _____
ADDRESS OF DEALER _____
DATE OF PURCHASE _____

Enjoy the Convenient Functions of Your Check Printing Accountant! (CPA)

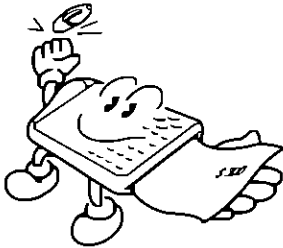

CHECK Function

Hand-writing a check is no longer necessary. Enter the necessary data and CPA prints the check. CPA also balances your checking account.

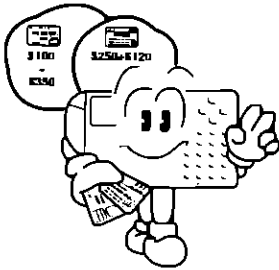

CARD Function

Whenever you pay with a credit card enter the data and CPA adds up the amount of each credit card payment.

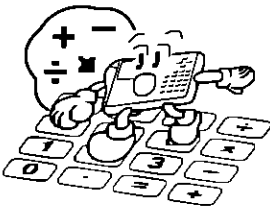

CALCULATION Function

Use CPA as a pocket calculator.

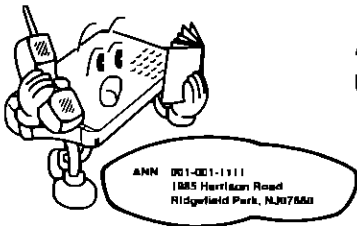

ADDRESS Function

Use CPA as an address directory.

ANN 001-001-1111
1885 Harrison Road
Ridgely Park, NJ07860

Accessories

Make sure that the following accessories are included with CPA.

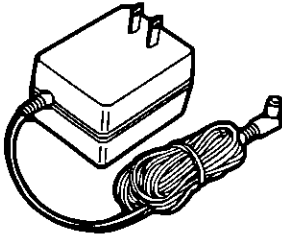

AC adaptor (p. 11) one

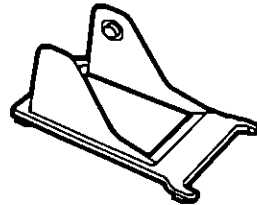

Paper feeder (p. 39) one

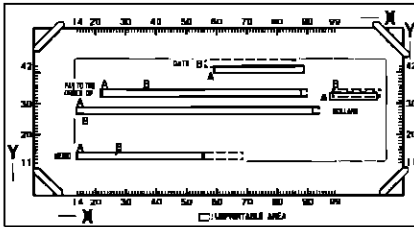

Template (p. 20) one

Printed material

Operating instructions one

Payee list card
(found on the back
of CPA) one

Quick start guide one

Owner information card one

Sample sheet two

Important!

Before using, remove the protective sheet from CPA.

Protective sheet

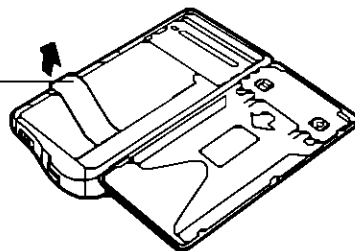

Table of Contents

	Page
Precautions	8
1 Before Using	9
Part Names	9
Front view	9
Printer parts	9
Keyboard	10
Power Supply	11
From household AC	11
Using the rechargeable Ni-Cd battery	11
2 Preparation	13
Turning On/Turning Off CPA	13
Resetting CPA (Clears all memory)	14
Setting the Clock	16
Adjusting Display Contrast	16
3 CHECK Function	17
Entering Your Bank Name	17
Making the Payee List	18
Inserting a Check	19
Setting Print Positions on Your Check	20
Issuing a Check (Entering Withdrawals/Service Charges)	23
Entering Deposit Data	26
Searching a CHECK Record	28
Reconciling (✓) a Check	29
Voiding a Check After Issued	29
Deleting the CHECK Record(s)	30
4 CARD Function	31
Making the Card List	31
Entering Data for Purchase with a Credit Card	32
Searching a CARD Record	33
Deleting the CARD Record(s)	34
5 CALCULATOR Function	35
Memory Calculation	35

	Page
6 ADDRESS Function	36
Making the Address List	36
Searching an ADDRESS Record	37
Deleting an ADDRESS Record	38
7 REPORT Function	39
Putting the Paper Roll on the Printer	39
Confirming Contents of CHECK/CARD/ADDRESS Records ..	41
8 Other Functions	44
Showing Remaining Memory for CHECK, CARD and ADDRESS	44
Showing Remaining Battery Power	44
Password	45
Entering the password	45
Changing/Clearing the password	46
9 Transferring Data	47
Transferring Data	47
Connecting CPA to Another CPA	47
Setting the Link Parameter	48
Performing the transfer	48
10 General Information	50
Troubleshooting Guide	50
Adjusting Print	52
Resetting CPA without Disturbing the Memory	53
Changing the Ribbon Cassette	54
Changing the Battery Pack	56
Specifications	57
11 Appendix	58
List of Display Messages	58
List of Code Key Functions	61
Category List	62
Options	63
Index	64

1
2
3
4
5
6
7
8
9
10
11

Precautions



Do not keep CPA in your back pocket as it may break when you sit down

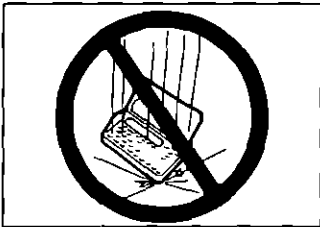

Do not drop or jar CPA

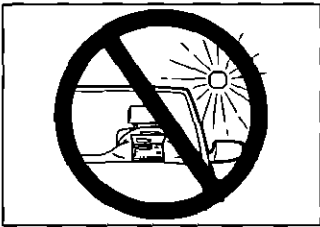

Do not place CPA where it will be exposed to direct sunlight or heat, especially in an automobile



To prevent electric shock, do not remove any screws
Your stored data may be erased



Use only a soft, dry cloth to clean CPA
Water or cleaning fluids may damage the case or electronic circuitry

Part Names

Front view

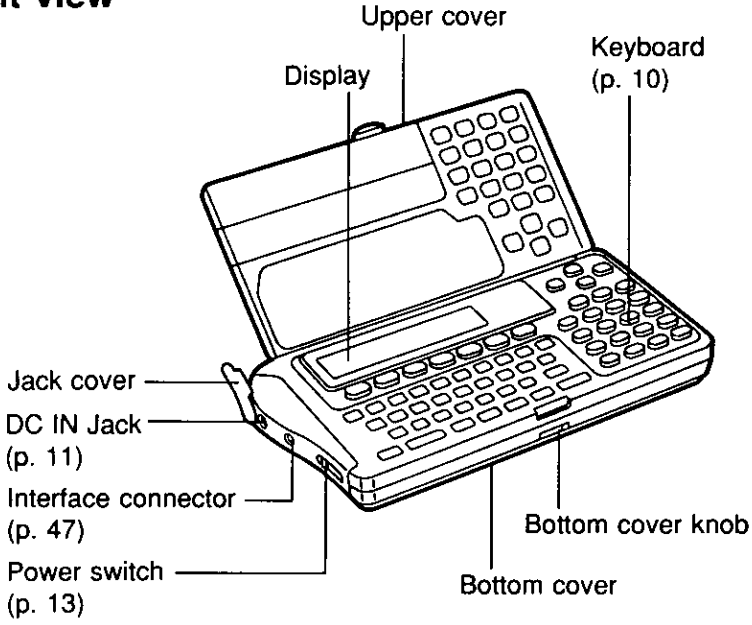

Printer parts

(Bottom side)

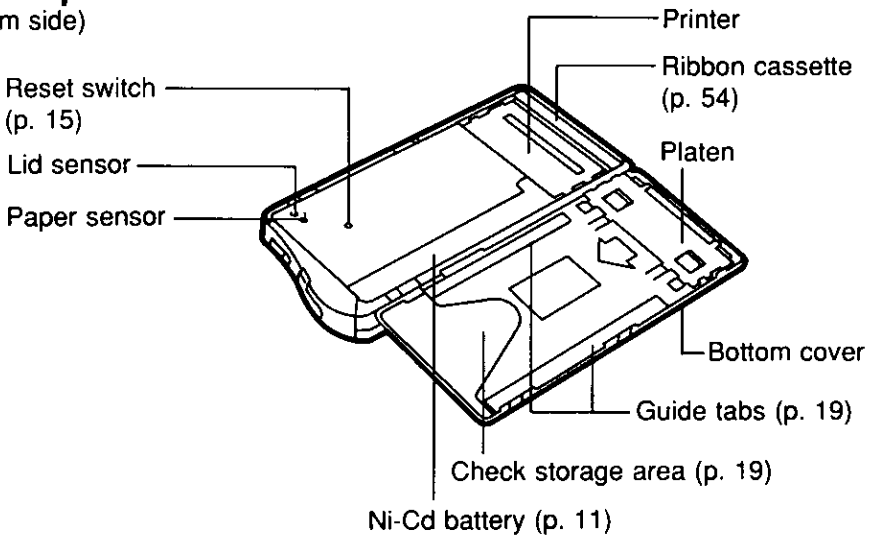

Part Names

Keyboard

Function keys

CHECK key (p 23)
 CARD key (p 32)
 CALC key (p 35)
 ADDRESS key (p 36)
 LIST # key (p 23)
 PRINT key (p 25)
 ENTER key

Cursor keys. To move the cursor

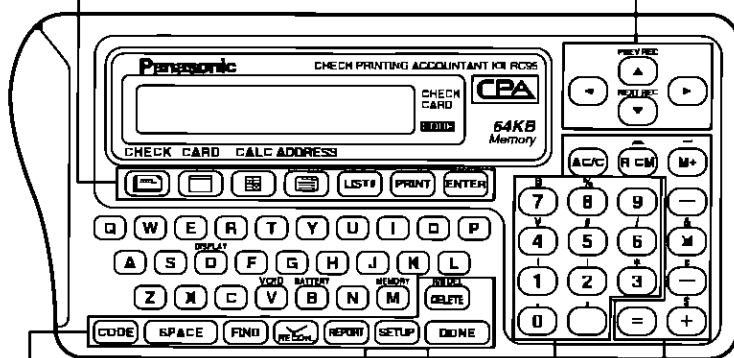

Figure keys: To enter numerical values

Calculation keys: Used for calculations

Sub function keys

CODE key To enter special functions,
 combined with other keys (p 16)
 SPACE key To enter a space
 FIND key To search for a desired record (p 28)
 RECON key To reconcile your CHECK record (p 29)
 REPORT key To confirm what is in the memory (p 41)
 SETUP key To begin setting up functions
 DONE key To finish an operation and to return
 to the initial display (current time)
 DELETE key To delete a letter/number
 under the cursor

Power Supply

CPA has two power sources:

- Household AC (AC 120 V)
- Rechargeable Ni-Cd battery (built-in CPA)

From household AC

Before operating CPA connect it to the household AC outlet (AC 120 V) with the AC adaptor for about three (3) hours in order to charge the battery. (While charging you can operate CPA. However, it will take longer for it to charge.)

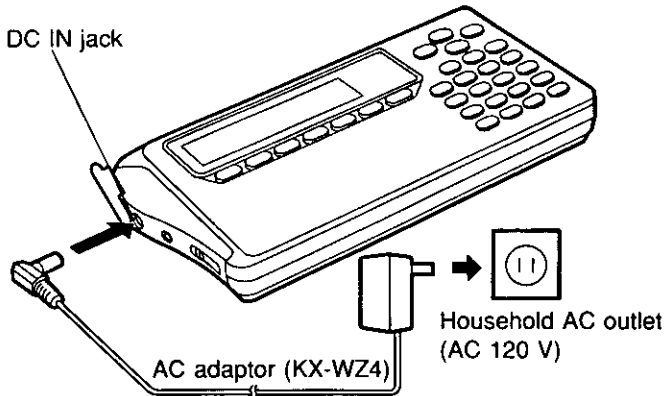

CAUTION:

Use only the supplied AC adaptor.
Other adaptors may damage CPA.

Using the rechargeable Ni-Cd battery

When connected to household AC as illustrated above, the built-in Ni-Cd battery automatically charges itself.

A full battery charge requires about three (3) hours.

After charging, disconnect the AC adaptor from CPA and the AC outlet. CPA can now be operated from battery power.

The printing capability of the fully charged battery is about 50 sheets for check printing or about 35 pages for report printing at 25°C (77°F).

For "Showing Remaining Battery Power", refer to p. 44.

ATTENTION:

The product that you have purchased contains a rechargeable battery. The battery is recyclable. At the end of its useful life, under various state and local laws, it may be illegal to dispose of this battery into the municipal waste stream. Check with your local solid waste officials for details in your area for recycling options or proper disposal.



Ni-Cd

Power Supply

Notes about the rechargeable battery:

- Before initial use, or use after a long period of time (about 6 months), recharge CPA for about three (3) hours.
- When the display shows "WEAK NI-CD BATTERY" several sheets of check can be printed but recharge CPA soon.
- When the display shows "RECHARGE NI-CD BATTERY" CPA will not print. Recharge CPA soon.
- When the display shows "INSERT AC ADAPTOR", the keys will not function. Recharge CPA soon.
- Repetitive short-term recharging and discharging makes the battery life shorter than usual and/or the remaining battery power may be shown incorrectly. To solve this, continue operating CPA until the display shows "WEAK NI-CD BATTERY" then recharge it. For about 30 minutes after the display shows "WEAK NI-CD BATTERY", CPA refreshes the battery automatically, during it, recharging the battery is not possible. Recharge CPA for about three (3) hours including the above refreshing time period.
- The battery drains excessively when used under unusually high or low temperature. Also, when CPA is left in an automobile for a long period of time the battery will weaken and the battery life shortens. Use CPA within an appropriate temperature range of 5°C (41°F) to 35°C (95°F).
- If CPA remains unused for several months or more, the remaining battery power shows incorrectly. The battery has become inactive. Continue operating CPA until the display shows "WEAK NI-CD BATTERY". Recharge the battery for about three (3) hours.
- When you find the printable number of checks reduced after repetitive recharging, the battery life is exhausted. Purchase a new battery pack (KX-RC30) from your dealer.

Turning On/Turning Off CPA

To turn on CPA, slide the power switch in the direction of the arrow for about one (1) second, until the display appears.

To turn off CPA, slide the power switch again in the same direction until the display disappears.

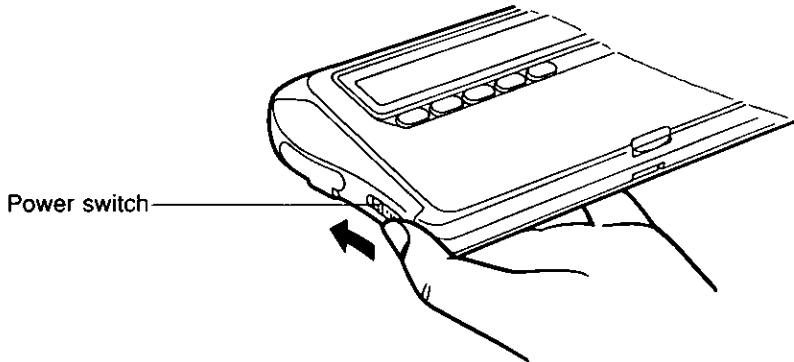

Auto shut-off function

If CPA is not in operation for more than 5 minutes while using battery power, it automatically shuts off to prevent battery drainage.

Turn the power switch on again to resume using CPA.

Resetting CPA (Clears all memory)

Before using CPA for the first time, resetting is necessary to clear the memory.

CAUTION: This operation clears the memory.

After resetting CPA, recharge CPA for about three (3) hours and make sure that CPA is fully charged by looking on the display. (p. 44)

1. Be sure that the power is ON.
Open the upper cover by pulling the tab up gently.

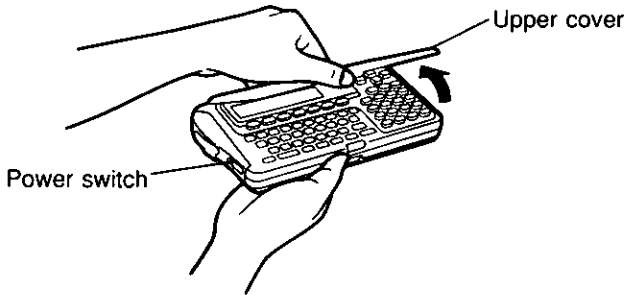

2. Open the bottom cover by sliding the bottom cover knob to the right.

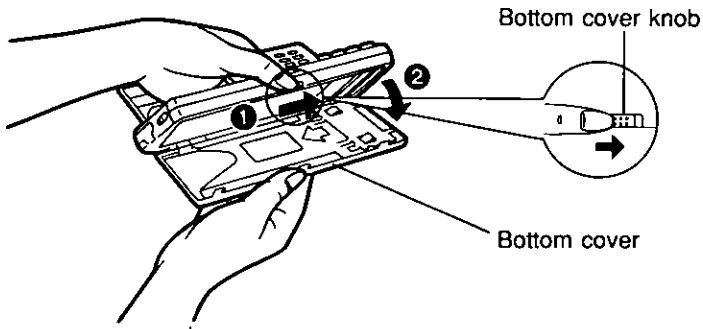

Resetting CPA (Clears all memory)

3. While pressing **DONE**, press the reset switch with the tip of a ball-point pen.

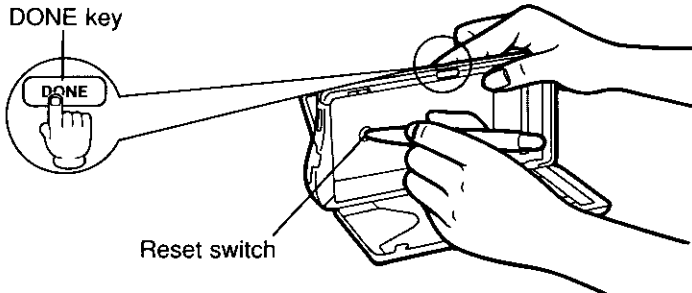

4. After pressing the reset switch, release **DONE**.
The display will show:

→ DELETE ALL DATA **N**/Y ?

5. Close the bottom cover.
(Press the "PRESS" mark.)

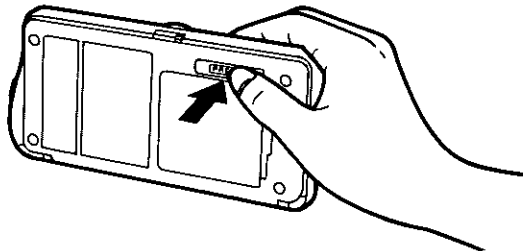

6. Press **Y** or **▶** to YES.

→ DELETE ALL DATA **N**/**Y** ?

7. Press **ENTER**.

→ WAIT . . .



after a few seconds

JAN.01,1994 SAT
12:00 AM

Setting the Clock

Example: Setting "January 28, 1994, 10:30 PM".

Operation

Display/Description

① Enter month, day and year.
SETUP → **ENTER** → **012894**
 (Select DATE)

DATE: 01 / 28 / 9**4**
 TIME: 12:00 AM

• Calendar runs from 1992 to 2091.

② Enter the hour and minute(s).
ENTER → **1030**

DATE: 01 / 28 / 94
 TIME: 10:3**0** AM

③ Select AM or PM.
ENTER → **▶** → **ENTER** → **DONE**
 (Select PM)

JAN.28,1994 FRI
 10:30 PM

• To set the second at "0", press **ENTER** at the minute or AM/PM.



How to correct a mistake

• Return to the incorrect letters/numbers by using **◀** / **▶** / **▲** / **▼**, then write the new entry over the old one.

Adjusting Display Contrast

Operation

Display/Description

① **CODE** → **D**

LCD CONTRAST
 LIGHT ■■■■■■□□□□ DARK

② Select appropriate contrast.
◀ or **▶**

LCD CONTRAST
 LIGHT ■■■■■■■■□□□□ DARK

Display: **▶** was pressed twice

③ Return to initial display.
ENTER or **DONE**

JAN.28,1994 FRI
 10:35 PM

Making the Payee List

It is recommended that you make a payee list of those to whom you most frequently write checks to and also to fill out the PAYEE LIST card attached on the back of CPA. It makes entering CHECK data much easier. Enter up to 25 payee names each with memo.

Example: Entering payee name "PANA SHOP" into payee list number 1.

Operation	Display/Description
① Enter payee's name. SETUP → ▼ → ENTER (Select PAYLIST) → PANA SPACE SHOP	<div style="border: 1px solid black; padding: 5px;">PAYLIST 01 : PANA SHOP <input type="text"/> MEMO:</div> <p>Payee's name: up to 32 letters/numbers</p>
② Enter memo if necessary. ENTER → ELECTRONICS	<div style="border: 1px solid black; padding: 5px;">PAYLIST 01 : PANA SHOP MEMO : ELECTRONICS <input type="text"/></div> <p>Memo: up to 20 letters/numbers</p>
③ Return to initial display. ENTER → DONE → DONE	<div style="border: 1px solid black; padding: 5px; text-align: center;">JAN.28,1994 FRI 10:42 PM</div>



How to correct a mistake

- Clear the incorrect letters/numbers under the cursor by pressing **◀** / **▶** / **▲** / **▼** and **DELETE**.
Pressing **AC/C** clears all of the letters/numbers on the line that the cursor is currently positioned at.

Inserting a Check

NOTE: A check with duplicate copies cannot be printed.

Use standard wallet-sized checks. {2 3/4" x 6" (Max. 2 25/32" x 6 1/16")}

1. Open the bottom cover by sliding the bottom cover knob to the right.

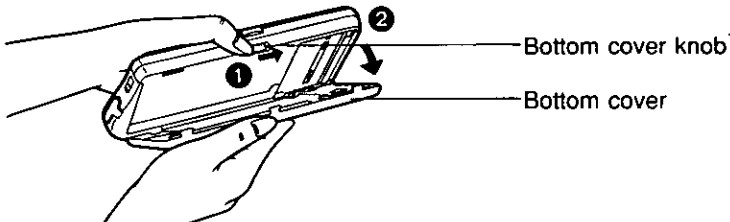

2. Insert only one check under the guide tabs until you feel some resistance. Align the bottom edge of the check with the bottom side of the guide tab. It is recommended that you use the sample sheet to confirm the print positions at first.

NOTE: Make sure that the check number corresponds to CHK# of the data.

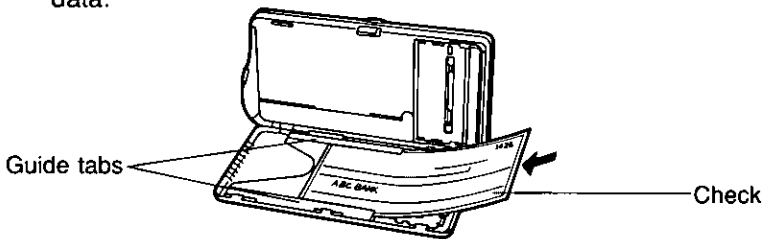

3. Close the bottom cover. (Press the "PRESS" mark.)

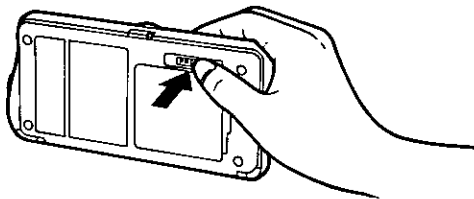

How to store checks

Inside the bottom cover is a check storage area where you can store up to 25 separate checks. Stack them from the smallest number check on the top to the largest number check on the bottom and to insert less than 12 or 13 checks at one time. This eliminates possible errors in check number and order.

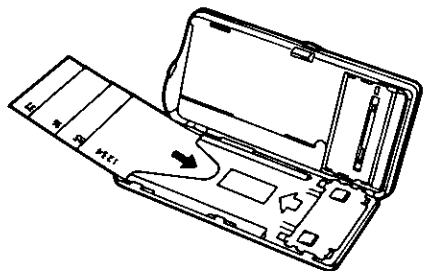

Setting Print Positions on Your Check

The following five (5) items out of the CHECK entries print at a specified position on a check:

- 1 DATE
- 2 PAY TO THE ORDER OF
- 3 \$
- 4 DOLLARS
- 5 MEMO

Deciding the print positions

Some checks have their own print position for each item. By using the template included with CPA you can select from two types of print positions (A or B), and CPA prints data at the proper position.

How to use the template:

- ① Place the template on the top of your check.
- ② Fit the bottom-left corner of your check in the bottom-left corner of the template, then insert the remaining corners. Align the bottom and left side of your check with bottom and left lines on the template.
- ③ Check to see where the above five (5) positions on your check correspond to on the template, "A" or "B".

Template:

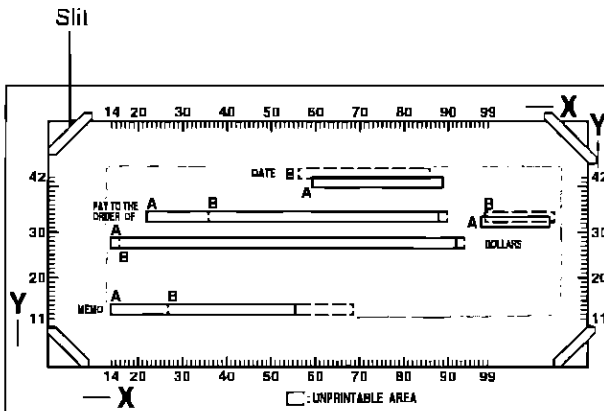

When defaulted, the above print positions set at "A".
(Using the template ruler you can manually set other desired print positions. We discuss this on p. 22.)

Setting Print Positions on Your Check

It is recommended that a demo print be done after setting print positions. A demo print will indicate the print positions with X and Y values. Be sure to insert a check or a sample sheet into CPA (p. 19).

Example: Setting the "DATE" and "\$" at the "B" position, "PAY TO", "DOLLARS" and "MEMO" at the "A" position.

Operation

Display/Description

- ① Select position of "DATE" (Select B).
SETUP → **▼** → **▶** → **ENTER** → **▶**
 (Select PRINTER)

```
DATE : A BR PAY   : A $ : A
DOL. : A   MEMO  : A
```

- ② Select positions of "PAY TO" (Select A) and "\$" (Select B).
ENTER → **ENTER** → **▶**

```
DATE : B   PAY   : A $ : A BR
DOL. : A   MEMO  : A
```

- When selecting "B" position for "PAY TO" and entering more than 25 letters/numbers for the payee's name, it overlaps the \$ sign.

- ③ Select positions of "DOLLARS" and "MEMO" (Select A).
ENTER three times

```
LOCATIONS SELECTED
PRINT DEMO N / Y ?
```

- ④ Print demo if necessary.
▶ or **Y** → **ENTER**

```
LOCATIONS SELECTED
PRINTING . . .
```

Example of demo print:

"DATE" is printed at B position (56, 42).

"PAY TO" is printed at A position (22, 32).

```

Please use this paper to check print settings.
PAY TO THE ORDER OF APAYEE : (X=22, Y=32) . . . PAYEE : PAYEE BX98Y32
DATE BDATE : X=56Y=42***
DOLLARS
    
```

- ⑤ Return to initial display.
DONE

```
JAN.28,1994 FRI
10:48 PM
```

Setting Print Positions on Your Check



When a position on your check corresponds to neither "A" nor "B".

- ① Place the template on the top of your check.
- ② Fit the bottom-left corner of your check in the bottom-left corner of the template, then insert the remaining corners. Align the bottom and left side of your check with bottom and left lines on the template.
- ③ Check to see where the **bottom-left point** of each of five (5) data items correspond to on the template ruler.

Example: Setting print position for "DATE" according to the template ruler (X=60, Y=39).

Operation

- ① Select position of "DATE" (Select R).

SETUP →  →  → **ENTER**
(Select PRINTER)

→ 

- ② Enter "X" and "Y" points.

ENTER → **6039**

- ③ Return to initial display.

ENTER → **DONE** → **DONE**

Display/Description

DATE : AB  PAY : A \$: B
DOL : A MEMO : A

ENTER X , Y
DATE X=60 Y=39 

- By entering numbers not within the range setting (X; 14 to 99, Y; 11 to 42) of each of the five (5) items, the print positions will be automatically set on the Maximum or Minimum value of the X, Y coordinates.
- If you want to print a demo, see p. 21.

JAN.28,1994 FRI
11:03 PM



How to correct a mistake

- Clear the incorrect letters/numbers under the cursor by pressing

 /  /  /  and **DELETE**.



- If "PRINTING AREA OVER CONTINUE N/Y?" is displayed when you attempt to print a demo, it means that you have entered a number that will cause data to be truncated when printed. Press "Y" to print the demo or press "N" and re-enter the data.

Issuing a Check

(Entering Withdrawals/Service Charges)

Have you finished setting the clock (p. 16), entering your bank name (p. 17), making the payee list (p. 18), inserting a check (p. 19) and setting the print position (p. 20)?

When you issue a check, enter the following data:

- PAY TO : Can be selected from the payee list
- DATE : The date when you will issue the check
- CHECK# : Number of the check
- CLASS : Business, Personal or Others
- TAX : Tax-related or No tax-related
- CATEGORY : Can be selected from the category list (p. 62)
- MEMO : Automatically entered if "PAY TO" is selected from the payee list
- AMOUNT : The amount of money that will be paid with the check

Example: Suppose you purchase a CD player at a PANA SHOP as a birthday gift on January 29, 1994. It costs \$300. You issue check #1426 for it. (Class→Business Tax→Tax-related)

Operation

Display/Description

- ① a) Enter pay to.
 (= **CHECK**) → **ENTER**
 (Select PAYMENT)
 → **P A N A SPACE S H O P**

PAY TO : PANA SHOP
 DATE : 01 / 28 / 94 CHK# :1

Payee's name: up to 32 letters/numbers

- b) Enter payee number from list.
 (= **CHECK**) → **ENTER**
 (Select PAYMENT)
 → **LIST #** → **1** → **ENTER**

PAYLIST 01 : ANA SHOP
 MEMO : ELECTRONICS

- To select another payee from the list, press . The list can not be modified here.

- ② Enter date.
ENTER → **0 1 2 9 9 4**

PAY TO : PANA SHOP
 DATE : 01 / 29 / 94 CHK# :1

Issuing a Check (Entering Withdrawals/Service Charges)

③ Enter check number.
ENTER → 1 4 2 6

PAY TO : PANA SHOP
 DATE : 01 / 29 / 94 CHK# : 1426

● Counting will start from the next number.

Entering Withdrawals/Service Charges

Withdrawals and service charges can be entered as check data.

NOTE: When you withdraw your money from your bank, press **A**, **S** or **O**.

- A**: ATM (Automated teller machine)
- S**: SVC (Service charges)
- O**: OTH (Other charges)

④ Select class (Business).
ENTER → ◀ or **B**

CLASS : **B** / P / O TAX : N
 CATEGORY : MISC

B: Business P: Personal O: Others

⑤ Select tax (Tax-related).
ENTER → ▶ or **Y**

CLASS : B TAX : N / **Y** ?
 CATEGORY : MISC

N: No tax-related Y: Tax-related

⑥ Select category (Example: GIFTS).
ENTER → **G** → ▶

CLASS : B TAX : Y
 CATEGORY : GIFTS

⑦ a) Enter memo (Example: Electronics).
ENTER → **ELECTRONICS**

MEMO : ELECTRONICS
 AMOUNT : \$

b) Confirm memo
 (if "PAY TO" is selected from list).
ENTER

MEMO : **E**LECTRONICS
 AMOUNT : \$

⑧ Enter amount.
ENTER → 3 0 0

MEMO : ELECTRONICS
 AMOUNT : \$300

Amount: up to \$99,999.99

● If amount is zero (0), the data will not be stored in memory.

Issuing a Check (Entering Withdrawals/Service Charges)

- ⑨ Confirm each item.
ENTER

01 / 29 / 94 1426 PANA SHOP
ELECTRONI \$300.00 T

Summarized display

- When entering withdrawals and service charges as check data, jump to step ⑫.

- ⑩ **ENTER**

END OF TRANSACTION
PRESS PRINT / CHECK KEY

- If you want to enter data for other checks continuously, press **CHECK**.
- If required, you can print checks later by using "Searching a CHECK Record" on p. 28.

- ⑪ Print the check.
PRINT → **▶** or **Y**

PRINT CHECK N / ?

N: To cancel Y: To execute

→ **ENTER**

PRINTING . . .
PLEASE ENDORSE CHECK !

- To stop the printing halfway through, press **DONE**.

- ⑫ Return to initial display.
DONE

JAN.28,1994 FRI
01:26 PM

How to correct a mistake

- Clear the incorrect letters/numbers under the cursor by pressing **◀** / **▶** / **▲** / **▼** and **DELETE**.

Pressing **AC/C** clears all of the letters/numbers on the line that the cursor is currently positioned at.

- If "PRINTING AREA OVER CONTINUE N/Y?" is displayed when you attempt to print a check, it means that you have entered data that will cause printout to be truncated because it exceeds the printable area on the check. Press "Y" to print the check or press "N" and re-enter the data.

Entering Deposit Data

The amount of the deposit is automatically added to the balance of the checking account. You need not worry about looking up the previous balance, adding the new deposit on, and entering a new balance. Have you finished setting the clock (p. 16), entering your bank name (p. 17)?



Whenever you deposit money into your checking account, enter the following data:

- DESCRIPTION : For your records, if necessary
- DATE : The date when you deposited money
- CLASS : Business, Personal or Others
- TAX : Tax-related or No tax-related
- CATEGORY : Can be selected from the category list (p. 62)
- MEMO : For your records, if necessary
- AMOUNT : The amount of money deposited

Example: You deposit your salary, \$4000, into your FIRST bank checking account on January 30, 1994.
(Class→Personal Tax→Tax-related)

Operation

Display/Description

- ① Enter type of deposit
(Example: SALARY).
 (= **CHECK**) →  or **D**
(Select DEPOSIT)

DESCRP : SALARY
DATE : 01 / 31 / 94

→ **ENTER** → **SALARY**

- ② Enter date.
ENTER → **013094**

DESCRP : SALARY
DATE : 01 / 30 / 94

- ③ Select class (Personal).
ENTER

CLASS : B / / O TAX : N
CATEGORY : MISC

B: Business P: Personal O: Others

- ④ Select tax (tax-related).
ENTER →  or **Y**

CLASS : P TAX : N / ?
CATEGORY : MISC

N: No tax-related Y: Tax-related

Entering Deposit Data

- ⑤ Select category (Example SALARY)
ENTER → **S**

CLASS P	TAX Y
CATEGORY SALARY	<input type="checkbox"/>

- ⑥ Enter memo if necessary
ENTER → **JANUARY**

MEMO JANUARY	<input type="checkbox"/>
AMOUNT \$	

Memo up to 20 letters/numbers

- ⑦ Enter amount
ENTER → **4000**

MEMO JANUARY	
AMOUNT \$4000	<input type="checkbox"/>

Amount up to \$99,999.99

- ⑧ Confirm each item
ENTER

01 / 30 / 94	SALARY
JANUARY	\$4,000.00 T

Summarized display

- ⑨ Return to initial display
ENTER → **DONE**

JAN 31, 1994 MON
02 02 PM

How to correct a mistake

- Clear the incorrect letters/numbers under the cursor by pressing **◀** / **▶** / **▲** / **▼** and **DELETE**

Pressing **AC/C** clears all of the letters/numbers on the line that the cursor is currently positioned at

-  • The balance displayed may differ from the actual balance due to a commission subtracted or interest added. Please check your bank records.

The balance can only be modified in step ②, "Entering Your Bank Name" (p 17)

-  • You can reconcile deposit data by following the same way as "Reconciling (✓) a Check" (p 29)

Searching a CHECK Record

You can search for a desired check record by specifying its date or check number and, if required, print the check. Use the most convenient one for you.

Example: You want to know the data of check #1426

Operation	Display/Description
① Select search item (Example CHECK#) ⏏ (= CHECK) → FIND	⏏ CHECK# DATE
② Enter check number ENTER → 1426	ENTER CHECK# 1426 ⏏ <ul style="list-style-type: none">• To search withdrawals, service, or other charges, press A, S or O (p 24)
③ Display the check record ENTER	01 / 29 / 94 1426 PANA SHOP ELECTRONI \$300 00 T <ul style="list-style-type: none">• If you want to print the check, press PRINT (p 23-25)• When searching by date, ATM, SVC or OTH, the last record is displayed To display the previous desired record, press CODE → FIND
④ Return to initial display DONE	JAN 31, 1994 MON 02 02 PM

Reconciling (✓) a Check

Example: You receive, from your bank, the statement of issued checks Confirm the statement according to the CHECK records in CPA Confirmation will be easier if you reconcile (✓) the record while checking (✓) the corresponding statement

Operation

Display/Description

- ① Repeat steps ① through ③ on p 28 and reconcile (✓) display
RECON

```
01 / 29 / 94 1426 PANA SHOP
ELECTRONI $300 00 T ✓
```

Reconciled

- To cancel, press **RECON** again
- To display other check record for reconciling, press **CODE** → **▼** or **CODE** → **▲**

- ② Return to initial display
DONE

```
FEB 06, 1994 SUN
11 07 AM
```

Voiding a Check After Issued

Example: You issue a check but later void it You must also void the corresponding CHECK record so that the amount of that check is added again to the balance

Operation

Display/Description

- ① Repeat steps ① through ③ on p 28 and void check record
CODE → **V**

```
01 / 29 / 94 1426 PANA SHOP
ELECTRONI $300 00 T V
```

Voided

- To cancel, press **CODE** → **V** again or **RECON**
- The amount of that check is again added to the balance

- ② Return to initial display
DONE

```
FEB 06, 1994 SUN
11 14 AM
```

Deleting the CHECK Record(s)

CPA can hold data for up to 500 checks. If you have entered data for 500 checks in order to enter more you must delete old data.
The check record data will be deleted: the balance will not be changed.

Example: You want to delete the data of check #1426 and #1427 at one time.

Operation

- ① Repeat steps ① through ③ on p. 28.
- ② Select type of deletion (Example: Block).
CODE → **DELETE** → **▶** or **B**
- ③ Select record to be deleted.
ENTER → **DELETE**
- ④ Select the other record to be deleted.
▼ → **DELETE**
- ⑤ Delete record(s)
ENTER → **▶** or **Y**
- ⑥ Return to initial display.
ENTER → **DONE**

Display/Description

01 / 29 / 94 1426 PANA SHOP
 ELECTRONI \$300.00 T

RECORD DELETE **B**LOCK

- If selecting "Record", jump to step ⑤.
- RECORD: To delete each record
- BLOCK: To delete two or more records at one time

01 / 29 / 94 1426 PANA SHOP
 ELECTRONI \$300.00 TD

- Delete
- After pressing **DELETE** a "D" will appear to indicate that you wish to delete this record. If you do not wish to delete the record, press **DELETE** again and the "D" will disappear.

01 / 30 / 94 1427 NATIONAL
 GAS \$100.00 D

END OF BLOCK
 DELETE RECORDS N / **Y**?

N: To cancel Y: To execute

FEB.06.1994 SUN
 11:18 AM

Making the Card List

Up to 5 card names can be entered.
Confirm the card balances before entering it.

Example: Make the card list using the card name "XYZ CARD" and card number "9876543".

Operation	Display/Description
① Enter card name. SETUP → ▶ twice (Select CARD) → ENTER → X Y Z SPACE C A R D	CARD NAME : XYZ CARD <input type="text"/> CARD#: Card name: up to 20 letters/numbers
② Enter card number. ENTER → 9 8 7 6 5 4 3	CARD NAME : XYZ CARD CARD# : 9876543 <input type="text"/> Card number: up to 16 digits
③ Enter current card balance. ENTER → 4 0 0	BALANCE : \$400 <input type="text"/> CREDIT LIMIT : \$0.00 Balance: up to \$99,999.99 ● Calculations will start from this amount.
④ Enter credit card limit. ENTER → 4 2 0 0	BALANCE : \$400 CREDIT LIMIT : \$4200 <input type="text"/> Credit limit: up to \$99,999.99
⑤ Return to initial display. ENTER → DONE → DONE	FEB.20,1994 SUN 08:30 PM



How to correct a mistake

- Clear the incorrect letters/numbers under the cursor by pressing **◀** / **▶** / **▲** / **▼** and **DELETE**.

Pressing **AC/C** clears all of the letters/numbers on the line that the cursor is currently positioned at.

Entering Data for Purchase with a Credit Card

Have you finished setting the clock (p. 16) and making the card list (p. 31)?

When you purchase something with a credit card, enter the following data:

- DATE : The date when you purchased something
- AMOUNT : The amount of your purchase
- MEMO : For your records, if necessary
- CLASS : Business, Personal or Others
- TAX : Tax-related or No tax-related
- CATEGORY : Can be selected from the category list (p. 62)

Example: You pay \$100 with the XYZ Card for a dinner at the "ABC" market on February 21, 1994.

Operation

Display/Description

- ① Enter date and amount.

 (= **CARD**) → **ENTER**
→ **022194** → **ENTER**
→ **100**

XYZ CARD DATE : 02 / 21 / 94
AMOUNT : \$100

- If selecting another card, first press **CARD** until the desired card name appears.
- The "AMOUNT" you enter adds to the "Balance" of XYZ card.

- ② Enter memo if necessary.

ENTER → **A B C SPACE**
M A R K E T

MEMO : ABC MARKET
CLASS : P TAX : N

Memo: up to 20 letters/numbers

- ③ Select class (Personal).

ENTER

MEMO : ABC MARKET
CLASS : B / / O TAX : N

B: Business P: Personal O: Others

- ④ Select tax (No tax-related).

ENTER

MEMO : ABC MARKET
CLASS : P TAX : / Y ?

N: No tax-related Y: Tax-related

- ⑤ Select category (Example: DINING).

ENTER → **D**

CATEGORY : DINING
END OF TRANSACTION

Entering Data for Purchase with a Credit Card

- ⑥ Return to initial display.

ENTER → **DONE**

FEB.24,1994 THU
04:05 PM



How to correct a mistake

- Clear the incorrect letters/numbers under the cursor by pressing **◀** / **▶** / **▲** / **▼** and **DELETE**.

Pressing **AC/C** clears all of the letters/numbers on the line that the cursor is currently positioned at.

Searching a CARD Record

Example: You want to know how much you paid with the XYZ card on February 21, 1994.

Operation

Display/Description

- ① Search by date.

☐ (= **CARD**) → **ENTER** → **FIND**

ENTER DATE : / /

- Can search only by date.
- If selecting another card, press **CARD** until the desired card name appears.

- ② Enter date.

0**2****2****1****9****4**

ENTER DATE : 02 / 21 / 94

- ③ Display the card record.

ENTER

XYZ CARD DATE : **0**2 / 21 / 94
AMOUNT : \$100.00

- When two or more records exist, the last one is displayed.
- To display the previous desired record, press **CODE** → **FIND**.

- ④ Return to initial display.

DONE

FEB.24,1994 THU
04:05 PM

Deleting the CARD Record(s)

CPA holds data for up to 200 card purchases.

If you have entered data for 200 payments by a credit card, you must delete old data in order to enter more.

Only the card record data will be deleted, and the amount will not be subtracted from the balance automatically.

Example: You want to delete a record dated February 21, 1994 of the XYZ Card.

Operation

- ① Repeat steps ① through ③ on p. 33.

- ② Delete a record.

CODE → **DELETE** → **▶** or **Y**

- ③ Return to initial display.

ENTER → **DONE**

Display/Description

XYZ CARD DATE : 02 / 21 / 94
AMOUNT : \$100.00

DELETE RECORD N / **Y** ?

N: To cancel Y: To execute

FEB.28,1994 MON
09:28 PM

Example: You want to delete all records of the XYZ Card.

Operation

- ① Select card name.

SETUP → **▶** twice → **ENTER**
(Select CARD)

- ② Delete the records.

CODE → **DELETE** → **▶** or **Y**

- ③ Continue to delete.

ENTER → **▶** or **Y**

- ④ Return to initial display.

ENTER → **DONE** twice

Display/Description

CARD NAME : **X**YZ CARD
CARD# : 9876543

DELETE RECORD N / **Y** ?

N: To cancel Y: To execute

ALL CARD CHARGE DELETED
CONTINUE N / **Y** ?

FEB.28,1994 MON
09:28 PM

Memory Calculation

CPA can calculate, memorizing a midway result, with a 10 digit maximum.

Example: Q. $(12.3 \times 4) + (3.4 \times 4) + 1.5 =$

Operation	Display/Description
① (= CALC) Display shows "0".	0.
② 1 2 . 3 × 4 M+	<div style="border: 1px solid black; padding: 5px; text-align: right;"> [MEMORY] 49.2 </div> Result of (12.3×4) has been memorized.
③ 3 . 4 × 4 M+	<div style="border: 1px solid black; padding: 5px; text-align: right;"> [MEMORY] 13.6 </div> Result of (3.4×4) will be added to the memory.
④ 1 . 5 M+	<div style="border: 1px solid black; padding: 5px; text-align: right;"> [MEMORY] 1.5 </div> "1.5" will be added to the memory.
⑤ R·CM	<div style="border: 1px solid black; padding: 5px; text-align: right;"> [MEMORY] 64.3 </div> Final result
⑥ Return to initial display. DONE	<div style="border: 1px solid black; padding: 5px; text-align: center;"> FEB.27,1994 SUN 09:25 AM </div>

- ☞ You can correct mistakes made during calculations.
 - To reset a figure to "0" press **AC/C** once.
 - To clear "+", "-", "×", or "÷" press **AC/C** once or twice.
 - To clear "[MEMORY]" press **R·CM** twice.
- ☞ When you press **+ → =**, the displayed number is added to itself. (Example: **5 → + → =**, the answer is 10.)
- ☞ When the result exceeds "9,999,999,999", or you try to divide by "0", "[ERROR]" is displayed. To clear "[ERROR]" press **AC/C**.

Making the Address List

You can enter up to 75 addresses.

Example: You want to enter the following name, the telephone number and address.

Name	Telephone No.	Address
MONICA SIMPSON	123-456-7890	29 HICKS STREET NEW YORK, NY 10004

Operation

Display/Description

- ① Enter name.

ENTER (= **ADDRESS**)
→ **M O N I C A SPACE**
S I M P S O N

NAME : MONICA SIMPSON
PHONE :

Name: up to 32 letters/numbers

- To add a new name, telephone number and address, press

ADDRESS twice.

- ② Enter telephone number.

ENTER → **1 2 3 - 4 5 6 -**
7 8 9 0

NAME : MONICA SIMPSON
PHONE : 123-456-7890

Telephone number: up to 12 digits

- ③ Enter street name.

ENTER → **2 9 SPACE H I C K S**
SPACE S T R E E T

STREET : HICKS STREET
CITY,ST.:

Street name: up to 32 letters/numbers

- ④ Enter city and state name.

ENTER → **N E W SPACE**
Y O R K
CODE - N Y SPACE
1 0 0 0 4

STREET : 29 HICKS STREE
CITY,ST.: YORK,NY 10004

City and state name: 32 letters/numbers

- ⑤ Return to initial display.

ENTER → **DONE**

FEB.24,1994 THU
08:30 PM



How to correct a mistake

- Clear the incorrect letters/numbers under the cursor by pressing

◀ / ▶ / ▲ / ▼ and **DELETE**.

Pressing **AC/C** clears all of the letters/numbers on the line that the cursor is currently positioned at.

Entries will be sorted in alphabetical order according to the first name.

MONICA SIMPSON	→	ALICIA PRITCHETT
PAUL SMITH		MONICA SIMPSON
ALICIA PRITCHETT		PAUL SMITH

Searching an ADDRESS Record

Example: You want to know Monica's telephone number and address.

Operation	Display/Description
① Search by name. [] (= ADDRESS) → FIND	ENTER NAME : []
② Enter name. M O N I C A	ENTER NAME : MONICA [] • You can also search using only the first letter of the name. Press ▼ until the desired name is displayed.
③ Display the address record. ENTER	M ONICA SIMPSON 123-456-7890
④ Return to initial display. DONE	FEB. 25, 1994 FRI 10:24 PM

Deleting an ADDRESS Record

CPA can hold up to 75 addresses. If you have entered 75 addresses, you must delete old data in order to enter more.

Operation

① Repeat steps ① through ③ on p. 37

② Delete a record
CODE → **DELETE** → **▶** or **Y**

③ Return to initial display
ENTER → **DONE**

Display/Description

MONICA SIMPSON
123-456-7890

DELETE RECORD N / Y ?

N To cancel Y To execute

FEB 25, 1994 FRI
10 31 PM

Putting the Paper Roll on the Printer

If you want to know what is in the memory for CHECK, CARD and ADDRESS use the REPORT function. This will show you the contents of the records on the display or will print them on the paper roll. If you want the records to be printed on the paper roll, please purchase a paper roll specified below and attach the paper roll to the printer.

Paper roll: 2¼" standard adding machine roll paper (diameter: 3⁵/₃₂" or less)

1. Put the paper roll on the paper feeder.
Make sure the paper is fed from underneath not from the top.

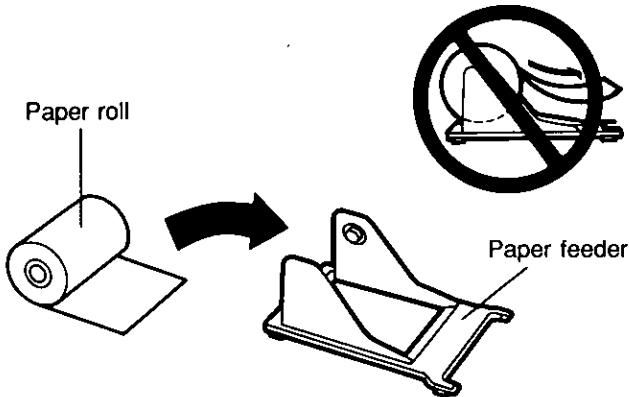

2. Connect the paper feeder to CPA on a stable or level surface.
The two hooks of the feeder should be inserted into the holes on the bottom of CPA.

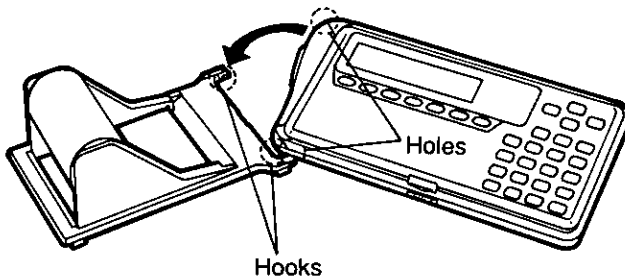

Putting the Paper Roll on the Printer

3. Open CPA by sliding the bottom cover knob to the right.

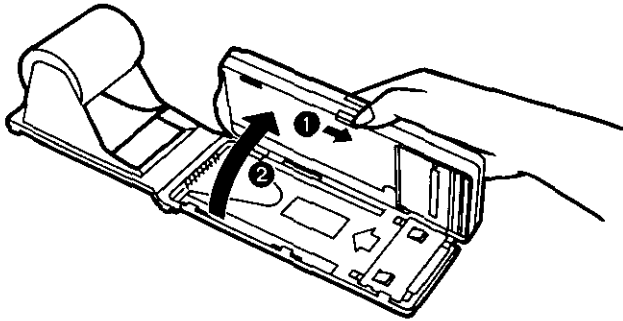

4. Pull the paper out forward along the paper setting lines marked on both sides and leave the paper out about 1/2 inch. (Be sure the paper is set exactly along the lines marked.)

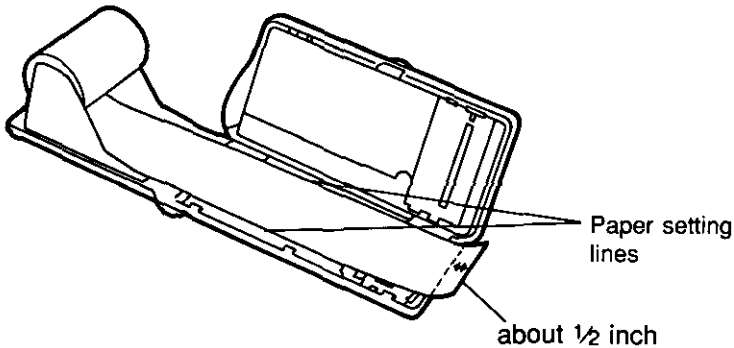

5. Close CPA while setting the paper exactly to the marks.

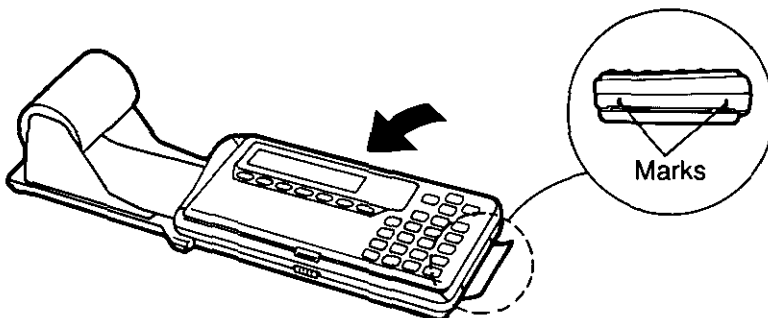

Confirming Contents of CHECK/CARD/ADDRESS Records

Example: You want to print a list of checks from 01/01/94 to 01/31/94 (FIRST bank).

Operation

- ① Select item (Example: CHECK).

REPORT

- ② Select search item (Example: DATE).

ENTER →  twice

Display/Description

```
SELECT ITEM
[C]HECK    CARD    ADDRESS
```

- If selecting "CARD" press **CARD** until the desired card record appears.

Search item display for CHECK/CARD

```
ALL *CHK# [D]ATE *NONRECON.
TAX *NAME CLASS CATEGORY
```

- *: Can not be selected, when selecting "CARD"

Search item display for ADDRESS

```
[A]LL SELECT
```

- When selecting "ALL", jump to step ⑤. When selecting "SELECT", enter the name and jump to step ⑤.

ALL : All CHECK/CARD/PHONE records
 CHECK# : Records within a specified range of check numbers or records of ATM withdrawals and/or charges
 DATE : Records with specified date
 NONRECON. : Records that have not been reconciled
 TAX : Records entered as "Tax-related"
 NAME : Records for specified payee
 CLASS : Records in specified class
 CATEGORY : Records in specified category
 SELECT : Can be searched by entering a desired name.

Confirming Contents of CHECK/CARD/ADDRESS Records

REPORT Function

7

Confirming Contents of CHECK/CARD/ADDRESS Records

③ Enter start date
ENTER → 0 1 0 1 9 4

START DATE	01 / 01 / 94
END DATE	/ /

• Start date must be before end date

④ Enter end date
ENTER → 0 1 3 1 9 4

START DATE	01 / 01 / 94
END DATE	01 / 31 / 94

⑤ Select "SEND TO PRINTER"
ENTER → ▼

VIEW ON SCREEN
SEND TO PRINTER

• If you want to view the contents of it, select "VIEW ON SCREEN"

⑥ Print report
ENTER

PRINTING REPORT

⑦ Return to initial display
DONE

FEB 27, 1994 SUN
9 30 PM

How to view CHECK records

(When selecting "VIEW ON SCREEN" in step ⑤)

CHK#	DATE	PAYEE	→	↔	←	PAYMENT	DEPOSIT ✓ V
1426	01/29/94	PANA SHOP				300 00	
▼ ↑ ▲				▼ ↑ ▲			
CHK#	DATE	PAYEE	→	↔	←	PAYMENT	DEPOSIT ✓ V
1427	01/30/94	NATIONAL				100 00	

• The final screen of the check report shows "CUR BAL" (Current Balance) and "REP TOTAL" (Report Total) "CUR BAL" shows the current checking account balance and "REP TOTAL" shows the total amount that you have entered as check data

Confirming Contents of CHECK/CARD/ADDRESS Records

When printing has finished:

1. Cut the paper.

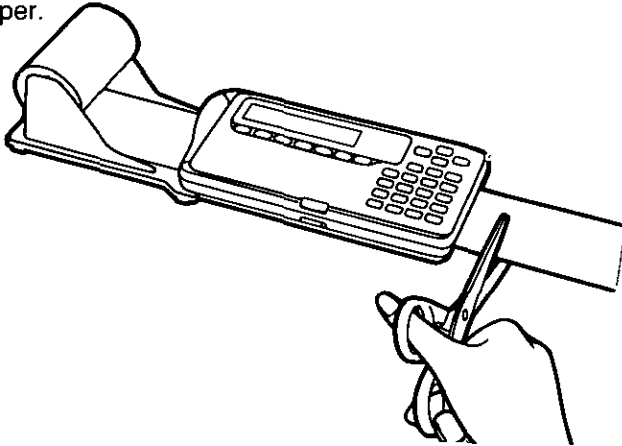

2. Open CPA by sliding the bottom cover knob to the right (refer to step 3 on p. 40).
3. Pull the paper roll out of CPA.

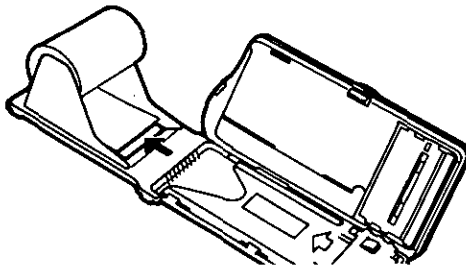

4. Close CPA (refer to step 5 on p. 40).
5. Remove the paper feeder from CPA by holding the paper feeder down with your hands.

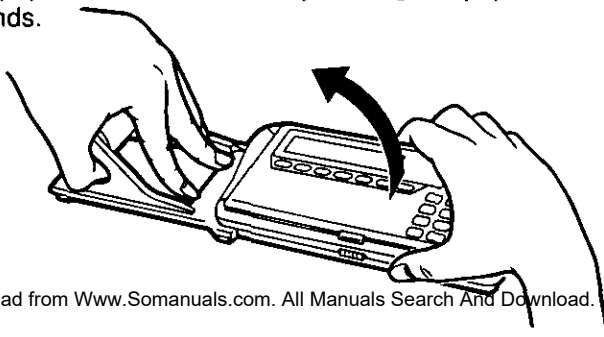

Showing Remaining Memory for CHECK, CARD and ADDRESS

Operation	Display/Description
① CODE → M	CHECK : 3/500 FULL CARD : 2/200 FULL
② Show memory for ADDRESS. ▼	ADDRESS : 2/75 FULL
③ Return to initial display. DONE	FEB.25,1994 FRI 08:30 PM

Showing Remaining Battery Power

Operation	Display/Description
① CODE → B	NI-CD BATTERY EMP ■■■□□ FULL

- When AC adaptor is inserted the display shows "CHARGING..." for a few seconds then returns to the previous display.
If Ni-Cd battery is full, the display shows "EMP■■■■■ FULL".

CAUTION: The remaining battery power may be shown incorrectly when used under unusual high or low temperature.





Password

If you do not want others to operate CPA enter a password

CAUTION: If you forget your password you have to use the "Resetting CPA (Clears all memory)" on p 14 to 15
Using the "Resetting CPA (Clears all memory)" also clears all memory that has been entered

Entering the password

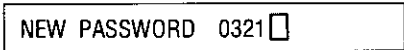
Example: You want to enter the password "0321"

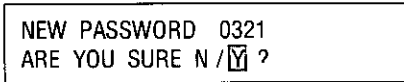
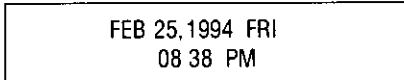
Operation	Display/Description
① Enter password SETUP →  twice →  → ENTER → 0 3 2 1	 Password up to 7 letters/numbers
② ENTER →  or Y	
③ Return to initial display ENTER → DONE	

 After setting the password, CPA requires you to enter it whenever using the **CHECK**, **CARD**, **ADDRESS**, **REPORT** or **SETUP** functions
When entering the password, it will not be shown on the display

Changing/Clearing the password

Example: You want to change the password from "0321" to "Q30A".

Operation

Display/Description

① **SETUP**

DATE CHECK CARD
PAYLIST PRINTER MORE ↓

● If the display shows "ENTER PASSWORD" enter the preset password.

② Enter old password.
▼ twice → ▶ → **ENTER**
→ **0321**

ENTER PASSWORD : ■■■■□

③ **ENTER** → ▶ or **Y**

0321
CHANGE PASSWORD N / **Y** ?

④ Enter new password.
ENTER → **Q30A**

NEW PASSWORD : Q30A □

● If you want to clear the password, press **ENTER** to leave it blank, then press **DONE** to return to initial display.

⑤ **ENTER** → ▶ or **Y**

NEW PASSWORD : Q30A
ARE YOU SURE N / **Y** ?

⑥ **ENTER** → **DONE**

FEB.25,1994 FRI
08:30 PM

Other Functions ∞ Password

Transferring Data

Connecting CPA to Another CPA

KX-RC20 (optional), an interface cable for data transfer with another CPA, must be purchased before data can be transferred.

1. Turn off both CPAs.
2. Open the jack covers of both CPAs.

Jack cover

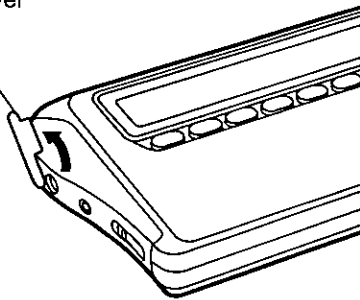

-  • When a cable is not plugged into the jacks, be sure to insert the jack covers. Dust or dirt particles may get into them or static electricity may occur around them.

3. Plug the interface cable into the interface connectors of both CPAs. Be sure to plug the cable in securely.

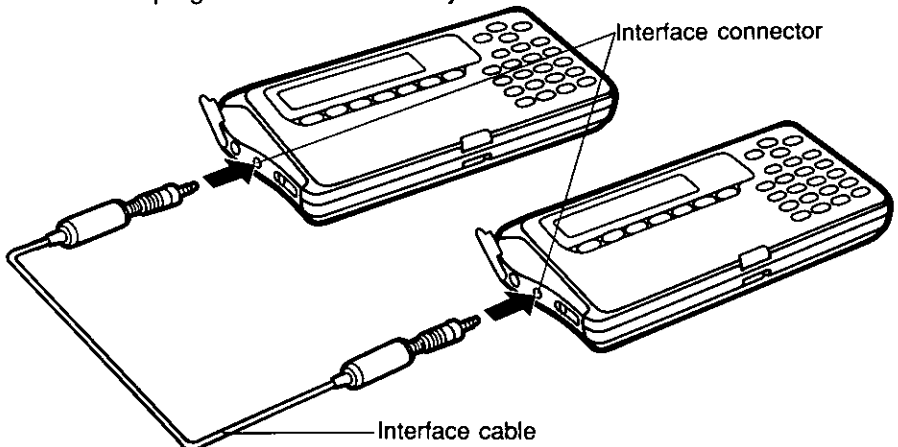

4. Turn on both CPAs.

Transferring Data

Setting the Link Parameter

Before transferring data, both CPAs must be set to the same baud rate (baud rate of 9600 is set at the factory).

Operation

Display/Description

- ① Select the baud rate (Example: 9600).

SETUP → twice → **ENTER**
(Select LINK)

BAUD : 2400 4800 600

- ② Confirm the other parameters.

ENTER → or

PARITY : NONE STOP : 1BIT
LENGTH : 8BITS OK N / ?

Parity bit: no parity

Stop bit: 1 bit

Data length: 8 bits

- These parameters are for communication with a personal computer.

- ③ Return to initial display.

ENTER → **DONE**

FEB.25,1994 FRI
08:38 PM

- ④ Set the same baud rate of the other CPA in the same way.

Performing the transfer

Note: When receiving data, all existing data is deleted.

Example: You want to transfer all the data from CPA-a (sender) to CPA-b (receiver).

Operation

Display/Description

- ① On CPA-a:
Select item to be sent (Example: ALL).

CODE → → **ENTER**
(Select SEND)

LL CHECK
CARD ADDRESS

② On CPA-b:

Receive the data.

CODE → **L** → **▶** → **ENTER**
(Select RECEIVE)

→ **▶** or **Y** → **ENTER**
(Select Y)

RECEIVING . . .
PRESS DONE KEY TO EXIT

CPA-b is ready to receive the data.

③ On CPA-a:

Send the data.

ENTER

SENDING . . .
PRESS DONE KEY TO EXIT

- Press **ENTER** within 30 seconds, or "LINK ERROR" will occur.
- To stop transferring data, press **DONE** on either CPA-a or CPA-b.
The data on the way is transferred to CPA-b (receiver).

④ On both CPAs

Return to initial display.

DONE → **DONE**

FEB.25,1994 FRI
09:12 PM

- ☞ Before starting the transfer, make sure that the memory size of CPA-b is larger than the existing data size of CPA-a. If not, the existing data of CPA-b will all be cleared. If necessary, delete some records in CPA-a.
- ☞ If KX-RC100 is the sender, the data of Second Bank, Cash, Card #6~10 and Phone will not be sent to CPA (KX-RC95).
- ☞ If KX-RC105 is the sender, the data of Second Bank, Cash and Card #6~10 will not be sent to CPA (KX-RC95).
- ☞ "LINK ERROR" will occur in the following cases:
 1. If the baud rate is different between the CPA units.
 2. If the CPA units are not connected correctly by the interface cable.
 3. If address data is sent to a CPA which has phone data.
 4. If phone data is sent to a CPA which has address data.
- ☞ Withdrawals and service charges are entered on a KX-RC100/105 by entering 0 as the check number. When this data is transferred to a KX-RC95 it will be included when you make a report and select the check number as "A", "S" or "O" (p. 24, 41). To search for this type of record on a KX-RC95, press **FIND** and enter "0" as the check number (p. 28).

Troubleshooting Guide

When trouble occurs, check the following points before returning CPA for service

Trouble	Cause	Procedure
Press a key but nothing appears on the display	CPA is not turned on	Turn the power switch on (See p 13)
Press a key but nothing enters	The bottom cover is open	Close the bottom cover (See p 15)
Turn on the power switch, but nothing appears on the display	The battery is not charged	Charge the battery for about three (3) hours (See p 11)
	The battery pack is not installed	Install the battery pack (See p 56)
	The protective sheet has not been removed from the battery terminal	Remove the protective sheet (See p 5)
	The power switch is not operated correctly	Try turning on again following procedure on p 13 If nothing appears on the display, press the reset switch with the tip of a ball-point pen (p 53) then slide the power switch again
The remaining battery amount is incorrectly displayed	The battery has become inactive	Keep operating CPA until "WEAK BATTERY" is displayed then recharge the battery (See p 11)
The display shows "INSERT AC ADAPTOR" and CPA will not accept any key function	The battery is empty	Plug in the AC adaptor and charge the battery for about three (3) hours (See p 11)

Troubleshooting (continued)

Download from www.Somanuals.com. All Manuals Search And Download.

Trouble	Cause	Procedure
The display shows "CHANGE LITHIUM BATTERY" and CPA will not accept any key function.	The life of the lithium battery is terminated.	Go to a service center to have the battery pack exchanged. (See the included list of authorized service centers.)
CPA does not print correctly or printing is blurred.	The ribbon cassette is not installed or is installed incorrectly.	Install ribbon cassette correctly. (See p. 54)
	The ribbon cassette is run out.	Replace with new ribbon cassette. (See P. 54)
The printing positions are not correct.	The printing positions are set incorrectly.	Set the printing positions correctly. (See p. 20)
A check is not fed.	A check is not set on the printer correctly.	Set a check on the printer correctly. (See p. 19)
The display shows "MEMORY ERROR". CPA does not operate properly, or memory may contain garbled characters.	Noise on the AC line or static electricity may prevent CPA from operating properly.	Turn the power switch off for a few seconds then turn the power switch on again. If the CPA does not function properly, reset CPA (p. 53), and then print the records on the paper roll. If the CPA still does not function properly, perform a total reset following the procedure on p. 14.

Troubleshooting



Adjusting Print

You can adjust the print in the following way.

Operation

Display/Description

- ① Insert the paper roll (refer to steps 1 through 5 on p. 39–40).

- ② Adjust print.
SETUP →  three times
 (Select PRINT ADJUST)
 → **ENTER** →  or **Y**
 (Select Y)

ADJUST PRINT N / **Y** ?

- ③ **ENTER**

Example of print:

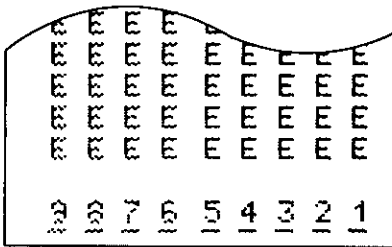

PRINTING . . .

SELECT DESIRED NUMBER
 9 8 7 6 **5** 4 3 2 1

- ④ Select the best print number.
 (Example: 3)

3

or

 twice → **ENTER**

PRINTING . . .

ADJUST PRINT **N** / Y ?

Example of print:

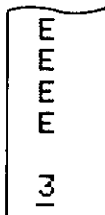

- ⑤ Return to initial display.

ENTER → **DONE**
 (Select N)

FEB.20,1994 SUN
 09:30 PM

Resetting CPA without Disturbing the Memory

If CPA is exposed to intense noise or a strong shock during operation it may get out of order and not accept any key function. When this occurs, follow the procedures below to reset CPA without harming the memory.

1. Open the bottom cover by sliding the bottom cover knob to the right.

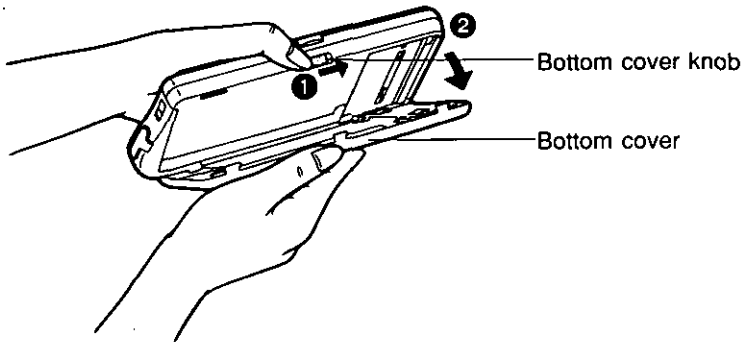

2. Press the reset switch with the tip of a ball-point pen.

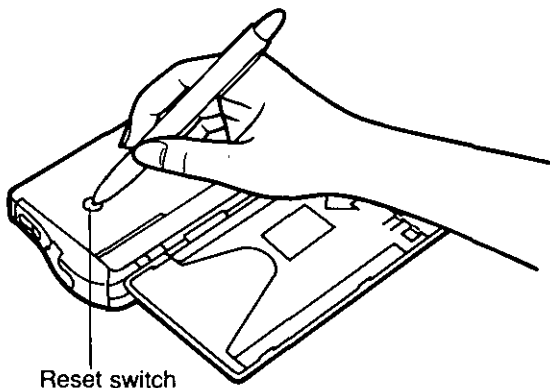

Changing the Ribbon Cassette

When the printing starts to fade, purchase a new ribbon cassette, KX-RC10 (optional), and replace with the new ribbon cassette. (Only use Panasonic KX-RC10. Other ribbons may damage the unit.)

1. Open the bottom cover by sliding the bottom cover knob to the right.

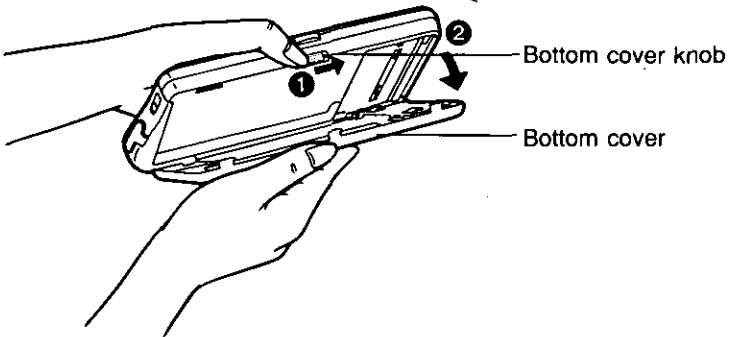

2. Push the printer open lever and pull up the printer as indicated by the arrows.

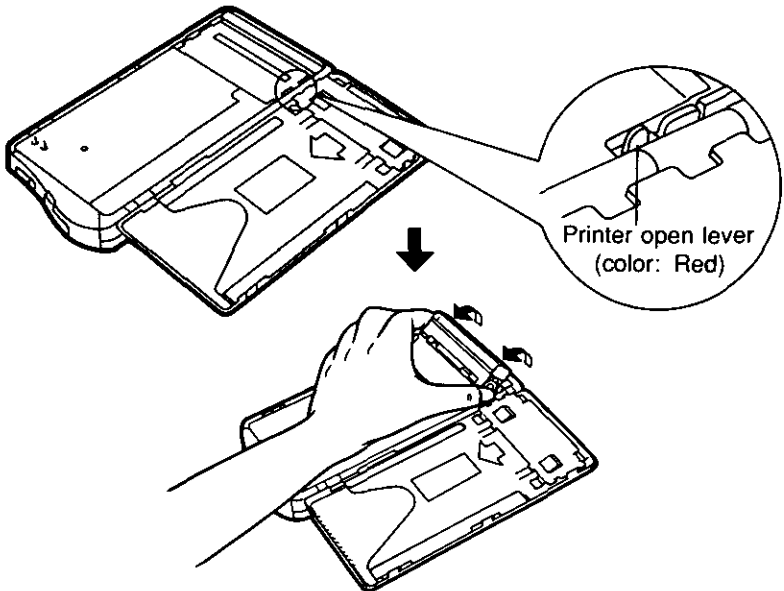

Changing the Ribbon Cassette

3. Remove the old cassette and install a new one. Make sure the ribbon is between the printhead and the ribbon guider sheet.

NOTE: Do not touch the printhead.

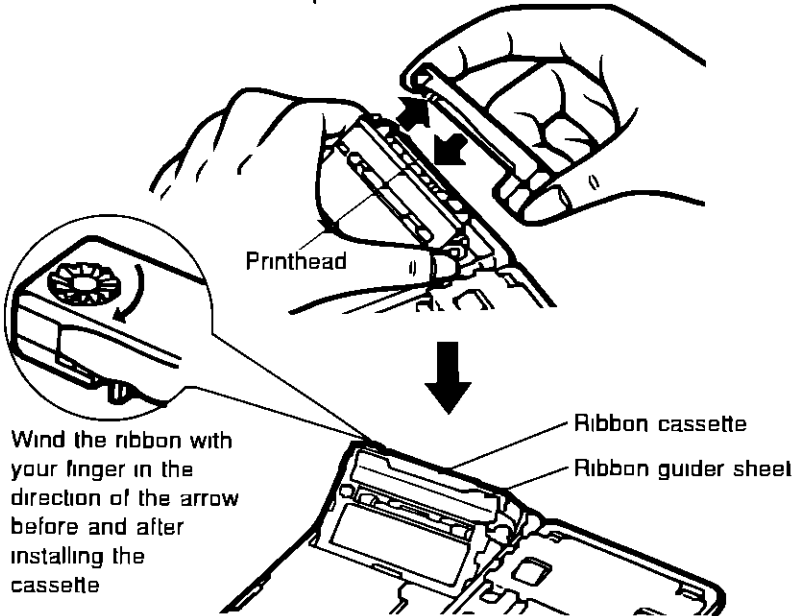

4. Press the printer down until it clicks into place.

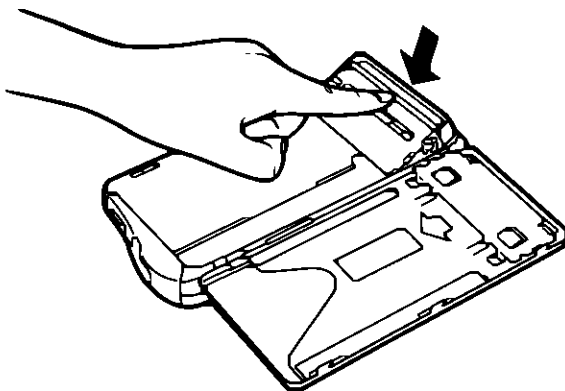

Changing the Battery Pack

Even though operated and charged correctly, the battery life will terminate. When this occurs, purchase a new Ni-Cd battery pack, KX-RC30 (optional), and replace the old battery pack.

1. Turn off CPA and unplug the AC adaptor.
2. Open the bottom cover and remove the battery pack screw.

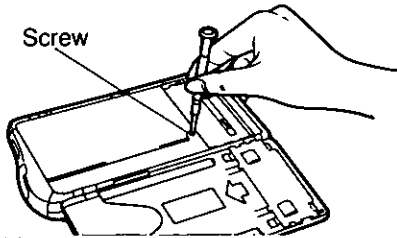

3. Remove the old battery pack and install the new one.

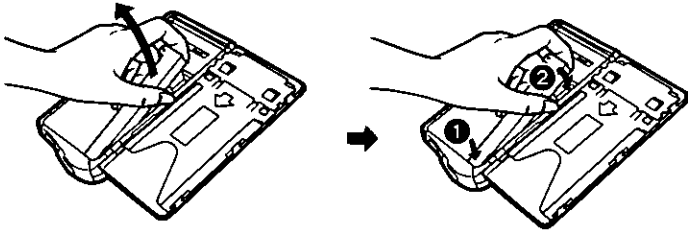

4. Replace and tighten the screw.

After exchanging the battery pack be sure to plug in the AC adaptor and recharge the battery for about three (3) hours as the remaining battery amount will be incorrectly displayed.

CAUTION: To reduce the risk of fire or injury, read and follow these instructions carefully.

- Never disassemble or modify the battery pack. It is made of strong alkali and may irritate skin or damage clothes.
- Never short-circuit the battery pack. Overheating the battery pack may cause burns.
- Never dispose of the battery pack in a fire. It may explode.
- Never try to recharge the battery without the pack unit. Always recharge the entire battery pack CPA.

Specifications

CHECK Memory	: 1 bank name 500 checks
CARD Memory	: 5 card names 200 entries
ADDRESS Memory	: 75 addresses
Clock	: Year, month, day, day of the week, hour, AM/PM From 1992 to 2091 ± 30 seconds/month (at 25°C)
Calculation	: Up to 10 digits: Addition, Subtraction, Multiplication, Division
Printer	: 4-pin dot matrix printer
Print Speed	: About 20 seconds/check
Ribbon	: Fabric ribbon
Display	: Liquid Crystal Display
Display Size	: 23-characters \times 2-line
Interface	: Interface with other CPA (Using optional KX-RC20); Interface with a personal computer (Using optional KX-RC21 or KX-RC22)
Power Requirements	: AC 120 V \pm 10%, 60 Hz, Ni-Cd Battery (For memory back-up: lithium battery)
Auto Shut-OFF	: After about 5 minutes with battery unit
Memory Life	: Minimum 5 years (with lithium battery)
Power Consumption	: Refer to the nameplate on the bottom of CPA
Operating Temperature	: 5°C (41°F) to 35°C (95°F)
Operating Humidity	: 20 to 80% RH
Storage Temperature	: -20°C (-4°F) to 60°C (140°F)
Dimensions	: 183 (W) \times 88 (D) \times 29.8 (H) mm {77/32"(W) \times 315/32"(D) \times 13/16"(H)}
Mass {Weight}	: 0.385 kg (0.85 lb)

List of Display Messages

Message	Description
* ADDRESS DATABASE FULL *	Address database is full.
ADJUST PRINT N/Y?	Do you want to adjust the print? (See p. 52)
ALL CARD CHARGE DELETED	All records relating to this card will be deleted. Do you want to continue? (See p. 34)
CONTINUE N/Y ?	
ARE YOU SURE N/Y ?	Are you sure you want to enter, change or clear the password? (See p. 45–46)
BOTTOM COVER IS OPEN	The bottom cover is open. (See p. 15)
BUILDING REPORT...	The machine is building a report.
CANNOT PRINT	This check has already been printed.
CHECK ALREADY PRINTED	
CANNOT PRINT	You cannot print deposit, withdrawal and service charge data.
DEPOSIT, ATM, SVC, OTH	
CANNOT PRINT	This check has been voided.
VOIDED CHECK	
* CARD DATABASE FULL *	Card database is full.
CHANGE LITHIUM BATTERY !	Please change the lithium battery.
CHANGE PASSWORD N/Y ?	Do you want to change the password?
CHARGING...	Charging the Ni-Cd battery.
CHECK ALREADY ENTERED	The same check number or zero (0) has been entered.
* CHECK DATABASE FULL *	Check database is full.
CHECK NOT INSERTED	A check has not been placed inside the printing area. (See p. 19)
CONTINUE N/Y ?	
DELETE ALL DATA N/Y ?	Do you want to delete all data?
DELETE RECORD N/Y ?	Are you sure you want to delete the record?
* DELETED *	The record has been deleted.

List of Display Messages

Message	Description
END OF BLOCK DELETE RECORDS N/Y?	Do you want to delete a block of records?
END OF LINK PRESS ANY KEY	Sending or receiving is done.
END OF TRANSACTION	This line is the end of the transaction.
[ERROR]	Error has occurred during calculating.
* ERROR * BALANCE OVERFLOW	Will be displayed if consecutive payments or deposits exceed 99,999.99.
ERROR ADDRESS TOO LARGE PRESS ANY KEY	Memory became full while receiving address data.
ERROR CARD TOO LARGE PRESS ANY KEY	Memory became full while receiving card data.
ERROR CHECK TOO LARGE PRESS ANY KEY	Memory became full while receiving check data.
EXISTING DATA SHOULD BE DELETED CONTINUE N/Y ?	This action deletes existing data. Are you sure?
INSERT AC ADAPTOR THEN PRESS ANY KEY	Insert AC adaptor and recharge the Ni-Cd battery. (See p. 11)
* INVALID PASSWORD *	Invalid password was entered.
* LINK CANCELED *	Sending or receiving is canceled.
LINK ERROR ! PRESS ANY KEY	Error has occurred while sending or receiving data. (See p. 49)
LOCATIONS SELECTED PRINT DEMO N/Y?	Do you want to print a demo?
[MEMORY]	Data is stored in memory.
MEMORY ERROR ! PRESS ANY KEY	Data in memory is damaged. (See "Troubleshooting Guide" on p. 51)
* NO CARD RECORDS *	There are no card records in memory.
* NO CHECK RECORDS *	There are no check records in this account.

List of Display Messages

Message	Description
NO NI-CD BATTERY ! PRESS ANY KEY	Ni-Cd battery is not connected. (See p. 56)
NO PAYEE LIST ENTRIES	There are no payee list entries in memory.
* NOT FOUND *	The required record is not found.
* NUMBER MUST BE 1-25 *	Payee list number must be 1 to 25.
PAPER NOT INSERTED CONTINUE N/Y ?	Paper roll is not inserted. (See p. 39–40)
* PRINT CANCELED *	Print is canceled.
PRINT CHECK N/Y ?	Will you print the check?
* PRINTER ERROR * COVER OPEN	The cover is open.
* PRINTER ERROR * PRINTER NOT READY	Something is wrong with the printer.
PRINTING...	The check is being printed.
PLEASE ENDORSE CHECK!	
PRINTING AREA OVER CONTINUE N/Y?	Payee's name will overlap the \$ sign or your entered data will exceed the printable area. Do you want to continue?
PRINTING REPORT...	The machine is printing the report.
RECEIVING... PRESS DONE KEY TO EXIT	The machine is receiving data via transfer.
RECHARGE NI-CD BATTERY ! PRESS ANY KEY	Recharge the Ni-Cd battery.
SEARCHING...	Searching the records.
SENDING... PRESS DONE KEY TO EXIT	The machine is sending the data via transfer.
WEAK LITHIUM BATTERY ! PRESS ANY KEY	Lithium battery is getting weak.
WEAK NI-CD BATTERY ! PRESS ANY KEY	Ni-Cd battery is getting weak.

List of Code Key Functions

CODE → 4	Enters “¥”.	CODE → 3	Enters “*”.
CODE → 5	Enters “#”.	CODE → -	Enters “¢”.
CODE → 6	Enters “/”.	CODE → 0	Enters “:”.
CODE → ×	Enters “&”.	CODE → .	Enters “,”.
CODE → 1	Enters “(”.	CODE → =	Enters “'”.
CODE → 2	Enters “)”.	CODE → +	Enters “\$”.

Category List

The 50 categories are listed in the alphabetical order.

A
 AUTO
 AUTO FUEL
 AUTO LOAN
 AUTO SERVICE

B
 BANK CHARGE
 BONUS

C
 CHARITY
 CHILDCARE
 CHRISTMAS
 CLOTHING
 COMMISSION

D
 DINING
 DIVIDND INCM
 DUES

E
 EDUCATION
 ENTERTAIN

G
 GIFT RECVD
 GIFTS
 GROCERIES

H
 HOME REPAIR
 HOUSEHOLD
 HOUSING

I
 INSURANCE
 INT INCM
 INT PAID
 INVEST EXP
 INVEST INCM

L
 LATE FEES

M
 MEDICAL
 MISC
 MORTGAGE

O
 OTHER EXP
 OTHER INCM

R
 RECREATION
 RENT PAID
 REPAIRS

S
 SALARY
 SUBSCRIPT
 SUPPLIES

T
 TAX
 TAX FEDERAL
 TAX FICA
 TAX OTHER
 TAX PROPERTY
 TAX STATE
 TELEPHONE
 TRAVEL

U
 UTILITIES
 UTL GAS/ELEC
 UTL WATER

Options

The following options are available through your local authorized parts distributor.

Part No.	Description	Comment
KX-RC10	Fabric ribbon	1 unit
KX-RC20	Interface cable for data transfer with other CPA	1 unit
KX-RC21	Interface adaptor for data transfer with a personal computer	1 unit
KX-RC22	Interface adaptor for data transfer with a Macintosh	1 unit
KX-RC30	Ni-Cd battery pack	1 unit

Index

A

AC adaptor	5, 11
Accessories	5
Account name	17
ADDRESS key	10
Address list, making	36
Adjust print	52
ATM (Automated teller machine)	24
Auto shut-off	13

B

Balance	17
Bank name, entering	17
Battery pack, changing	56
Bottom cover	9, 14
Bottom cover knob	9, 14, 19

C

CALC key	10
CALCULATOR	35
CARD key	10
Card list, making	31
CATEGORY	23
Category list	62
Charging	11
Check	
inserting	19
issuing	23
size	19
storage area	9, 19
with duplicate copies	19
CHECK key	10
CLASS	23
Clock, setting	16
CODE key	10
Code key function	61
Connecting	
CPA	11
household AC	11
Contrast, display	16
Credit card	32
Cursor keys	10

D

DC IN jack	9, 11
DELETE key	10
Deleting	
ADDRESS record	38
CARD record	34
CHECK record	30
Deposit	26
Display	9
Display contrast, adjusting	16
Display message	58
DONE key	10, 15

E

ENTER key	10
-----------	----

F

Figure keys	10
FIND key	10
FIRST bank	17
Function keys	10

G

Guide tabs	9, 19
------------	-------

H

Household AC	11
--------------	----

I

Interface	
cable	47
connector	9

J

Jack cover	9
------------	---

K

Keyboard	9, 10
----------	-------

L

Lid sensor 9
 LIST # key 10

M

Memory, remaining
 ADDRESS 44
 Battery power 44
 CARD 44
 CHECK 44

N

Ni-Cd battery 9, 11

O

Options 63

P

Paper feeder 5, 39
 Paper roll 39
 Paper sensor 9
 Part names 9
 Password
 Changing 46
 Clearing 46
 Entering 45
 Payee list 18
 Platen 9
 Power Supply 11
 Power switch 9, 13, 14
 Precautions 8
 PRINT key 10
 Print position 20
 Printer 9, 39
 Printer
 open lever 54
 parts 9
 Printing check 25
 Protective sheet 5

R

Rechargeable battery 11, 12
 RECON. key 10
 Reconciling check 29
 REPORT 39
 REPORT key 10
 Reset switch 9, 15, 53
 Resetting 14, 53
 Ribbon cassette 9
 Ribbon cassette, changing 54

S

Searching
 ADDRESS record 37
 CARD record 33
 CHECK record 28
 Setting clock 16
 SETUP key 10
 Showing
 ADDRESS record 44
 CARD record 44
 CHECK record 44
 SPACE key 10
 Specifications 57
 Sub function keys 10
 SVC (Service charges) 24

T

TAX 23
 Template 5, 20
 Template ruler 20, 22
 Transferring data 47
 Troubleshooting 50
 Turning off 13
 Turning on 13

U

Upper cover 9, 14

V

Voiding check 29

Servicenter Directory

PRODUCT INFORMATION - OPERATION ASSISTANCE

DIAL TOLL FREE: 1-800-CPA-7033 (1-800-272-7033)

Customer Service Center 2F-3, One Panasonic Way, Secaucus, NJ 07094 (Headquarters)
201-348-9090 (9:00am-8:00pm Monday-Friday, EST)

SERVICE INQUIRIES

Regional Customer Care Department

NORTHEAST

2221 Cabot Boulevard West
Suite A
Langhorne, PA 19047
215-741-0675

Covers:

CT, DE, ME, MD, MA,
NH, NJ, NY, PA, RI, VT,
VA, DC, WV, Eastern OH

MIDWEST

1703 North Randall Road
Elgin, IL 60123
708-468-5530

Covers:

IL, IN, IA, KS, KY, MI,
MN, MO, NE, ND, SD,
WI, Western OH

WESTERN

6550 Matella Avenue
Cypress, CA 90630
714-373-7440

Covers:

AK, AZ, CA, CO, ID,
MT, NV, NM, OR, UT,
WA, WY, HI

SOUTHERN

1854 Shackelford Court
Suite 4105
Norcross, GA 30093
404-717-6628

Covers:

AL, AR, FL, GA, LA,
MS, NC, OK, SC, TN, TX

PRODUCT SERVICE

Factory Servicenters

TENNESSEE

919-5th Avenue South
Nashville, TN 37203
615-244-4434

AUTHORIZED SERVICENTERS - PARTS DISTRIBUTOR LOCATIONS

To locate an independent authorized servicenter or parts distributor in your area, within the USA dial toll free **1-800-545-2672**, 24 hours a day, 7 days a week.

ACCESSORY PURCHASES

1-800-332-5368 (Consumer Orders Only)

Matsushita Services Company Box 01, 545 Tollgate Road Suite C, Elgin, IL 60123

(8:00am-7:30pm Monday-Thursday; 8:00am-5:00pm Friday; 9:00am-12:30pm Saturday; CST)

(Visa, Mastercard, Discover card, Check or Money Order)

If you ship the product:

Carefully pack and send it prepaid, adequately insured and preferably in the original carton. Attach a postage-paid letter, detailing the complaint, to the outside of the carton. **DO NOT** send the product to the Executive or Regional Sales offices. They are **NOT** equipped to make repairs.

PANASONIC COMPANY, DIVISION OF
MATSUSHITA ELECTRIC CORPORATION
OF AMERICA

One Panasonic Way Secaucus, New Jersey
07094

PANASONIC COMPANY (WEST) OF
AMERICA, DIVISION OF MATSUSHITA
ELECTRIC CORPORATION OF AMERICA

6550 Katella Avenue Cypress, CA 90630

PANASONIC CHECK PRINTING ACCOUNTANT LIMITED WARRANTY

Panasonic Company or Panasonic Company (West) of America (collectively referred to as "Panasonic") will repair this product with new or rebuilt parts, free of charge, in the U.S.A. from the date of the original purchase in the event of a defect in materials or workmanship as follows:

Check Printing Accountant—for One (1) Year.

Batteries (When applicable)—New rechargeable batteries in exchange for defective rechargeable batteries—For ten (10) days.

Non-rechargeable batteries are not warranted.

One (1) Year Extended Warranty on Lithium Battery—New lithium battery in exchange for a defective lithium battery during the second (2nd) year after the original purchase; purchaser pays for all labor charges for removal and installation of the lithium battery.

Carry-in or Mail-in service in the continental U.S.A. can be obtained during the warranty period by contacting a Matsushita Services Company (MSC) Factory Servicenter listed in the Servicenter Directory. Or call 1-800-545-2672, toll free, to locate an authorized MSC Servicenter.

This Warranty is extended only to the original purchaser. A purchase receipt or other proof of date of original purchase will be required before warranty performance is rendered.

This warranty only covers failures due to defects in materials or workmanship which occur during normal use and does not cover the print ribbon or damage which occurs in shipment or failures which are caused by products not supplied by Panasonic or failures which result from accident, misuse, abuse, neglect, mishandling, misapplication, interfacing, set-up, adjustments, improper maintenance, line power surge, introduction of sand, dust,

humidity and liquids, modification, or commercial use of the product, such as hotel, office or rental use of the product, or service by anyone other than an MSC Factory Servicenter or damage that is attributable to acts of God.

LIMITS AND EXCLUSIONS

There are no express warranties except as listed above. PANASONIC SHALL NOT BE LIABLE FOR INCIDENTAL, CONSEQUENTIAL OR PUNITIVE DAMAGES, INCLUDING, WITHOUT LIMITATION, LOSS OF GOODWILL, PROFITS OR REVENUE, LOSS OF USE OF THIS PRODUCT OR ANY ASSOCIATED EQUIPMENT, COST OF SUBSTITUTE EQUIPMENT, DOWNTIME COSTS, OR CLAIMS OF ANY PARTY DEALING WITH BUYER FOR SUCH DAMAGES, RESULTING FROM THE USE OF THIS PRODUCT, OR ARISING OUT OF ANY BREACH OF THIS WARRANTY OR CONTRACT, NEGLIGENCE, OR ANY OTHER LEGAL THEORY. ALL EXPRESS AND IMPLIED WARRANTIES, INCLUDING THE WARRANTIES OF MERCHANTABILITY, ARE LIMITED TO THE APPLICABLE PERIOD SET FORTH ABOVE. Some states do not allow the exclusion or limitation of incidental or consequential damage, or limitations on how long an implied warranty lasts, so the above exclusions or limitations may not apply to you.

This warranty gives you specific legal rights and you may also have other rights which vary from state to state.

If a problem with this product develops during or after the warranty period, you may contact your dealer or Servicenter. If the problem is not handled to your satisfaction, then write to the Customer Service Center at the company address indicated above.

Panasonic Company
Division of Matsushita Electric Corporation of America
One Panasonic Way, Secaucus, New Jersey 07094

Panasonic Company (West) of America
Division of Matsushita Electric Corporation of America
6550 Katella Avenue, Cypress, California 90630

Free Manuals Download Website

<http://myh66.com>

<http://usermanuals.us>

<http://www.somanuals.com>

<http://www.4manuals.cc>

<http://www.manual-lib.com>

<http://www.404manual.com>

<http://www.luxmanual.com>

<http://aubethermostatmanual.com>

Golf course search by state

<http://golfingnear.com>

Email search by domain

<http://emailbydomain.com>

Auto manuals search

<http://auto.somanuals.com>

TV manuals search

<http://tv.somanuals.com>