

Panasonic®

LIFI™ HDTV Operating Instructions

Models No. **PT-50LCZ70 / PT-56LCZ70 / PT-61LCZ70 /
PT-50LCZ7 / PT-56LCZ7 / PT-61LCZ7 /
PT-50LCZ70-K / PT-56LCZ70-K / PT-61LCZ70-K**



(USA)

For assistance, please call :
1-888-VIEW PTV(843-9788)
or, contact us via the web at:
<http://www.panasonic.com/contactinfo>

(Puerto Rico)

For assistance, please call :
787-750-4300
or visit us at www.panasonic.com

(Canada)

For assistance, please call :
1-800-561-5505
or visit us at www.panasonic.ca

Three Important Reasons to Register Your Product Immediately!

- 1 Protect Your New Investment...**
Register your new Projection Display for insurance purposes in case your new Projection Display is stolen.
- 2 Product safety notification...**
Registering your product can help us to contact you in the unlikely event a safety notification is required under the Consumer Product Safety Act.
- 3 Improved Product Development...**
Help us continue to design products that meet your needs.
Register online at www.panasonic.com/register



* The presence of the DTV certification mark indicates that this product will successfully receive digital television transmissions that conform to any and all of the video formats described in the ATSC Digital Television Standard.

As an ENERGY STAR® Partner, Panasonic Corporation of North America has determined that this product or product model meets the ENERGY STAR® guidelines for energy efficiency.

This operating instruction book is designed for use with models PT-50LCZ70, PT-56LCZ70, PT-61LCZ70, PT-50LCZ7, PT-56LCZ7, PT-61LCZ7, PT-50LCZ70-K, PT-56LCZ70-K and PT-61LCZ70-K. Illustrations in this manual show the PT-56LCZ70.

Before connecting, operating or adjusting this product, please read the instructions completely. Please keep this manual for future reference.

! IMPORTANT SAFETY INSTRUCTIONS



This symbol warns the user that uninsulated voltage within the unit may have sufficient magnitude to cause electric shock. Therefore, it is dangerous to make any kind of contact with any inside part of this unit.



This symbol alerts the user that important literature concerning the operation and maintenance of this unit has been included. Therefore, it should be read carefully in order to avoid any problems.



The pictorial representation of a hot surface within a triangle is intended to tell the user that parts inside the product are a risk of burns to persons.

Note to CATV System Installer:

This reminder is provided to call the CATV system installer's attention to Article 820-40 of the NEC that provides guidelines for proper grounding and, in particular, specifies that the cable ground shall be connected to the grounding system of the building, as close to the point of cable entry as practical.

! WARNING

To reduce the risk of electric shock, fire, injury to persons or damage to this product:

- 1) **Read these instructions** before using, connecting or adjusting this product.
- 2) **Keep these instructions** for future reference.
- 3) **Heed all warnings** on the product and in this Operating Instructions manual.
- 4) **Follow all instructions** carefully.
- 5) **Do not use this apparatus near water.** For example, near a bathtub, washbowl, kitchen sink, or laundry tub, in a wet basement or near a swimming pool, and the like. Do not place objects filled with water, such as a vase or the like, on top of this unit.
- 6) **Clean only with a dry cloth.** Do not use liquid cleaners or aerosol cleaners.
- 7) **Do not block any ventilation openings. Install in accordance with the manufacturer's instructions.** Openings in the cabinet are provided for ventilation to ensure reliable operation and to protect it from overheating. Never block openings by placing the product on a bed, sofa or similar surfaces.
- 8) **Do not install near any heat source such as radiators, heat registers, stoves, or other apparatus (including amplifiers) that produces heat.** Do not install in a built-in installation such as a bookcase or rack, unless proper ventilation is provided or the manufacturer's instructions have been adhered to.
- 9) **Do not defeat the safety purpose of the polarized or grounding-type plug. A polarized plug has two blades with one wider than the other. A grounding type plug has two blades and a third grounding prong. The wide blade or the third prong are provided for your safety. If the provided plug does not fit into your outlet, consult an electrician for replacement of the obsolete outlet.**
- 10) **Protect the power cord from being walked on or pinched particularly at plugs, convenience receptacles, and the point where they exit from the apparatus.**
- 11) **Only use attachments/accessories specified by the manufacturer.**
- 12) **Use only with the cart, stand, tripod, bracket, or table specified by the manufacturer, or sold with the apparatus. When a cart is used, use caution when moving the cart/apparatus combination to avoid injury from tip-over.**
- 13) **Unplug this apparatus during lightning storms or when unused for long periods of time.**
- 14) **Refer all servicing to qualified service personnel. Servicing is required when the apparatus has been damaged in any way, such as power-supply cord or plug is damaged, liquid has been spilled or objects have fallen into the apparatus, the apparatus has been exposed to rain or moisture, does not operate normally, or has been dropped.**



⚠ IMPORTANT SAFETY INSTRUCTIONS (CONTINUED)

⚠ WARNING

AS WITH ANY SMALL OBJECT, SD CARDS CAN BE SWALLOWED BY YOUNG CHILDREN. DO NOT ALLOW CHILDREN TO HANDLE THE SD CARD.

⚠ WARNING

TO REDUCE THE RISK OF FIRE OR ELECTRIC SHOCK, DO NOT EXPOSE THIS EQUIPMENT TO RAIN OR MOISTURE. DO NOT PLACE OBJECTS FILLED WITH WATER, SUCH AS A VASE OR THE LIKE, ON TOP OF THIS APPARATUS.

⚠ CAUTION

- (1) This Projection Display is intended to be used with the following TV stand :
model TY-50LC7, TY-56LC7, TY-61LC7, TY-50LC70, TY-56LC70, or TY-61LC70 for the PT-50LCZ70, PT-56LCZ70, PT-61LCZ70, PT-50LCZ7, PT-56LCZ7, PT-61LCZ7, PT-50LCZ70-K, PT-56LCZ70-K, or PT-61LCZ70-K. Use with other stands may result in the Projection Display becoming unstable, possibly causing injury.
- (2) This Projection Display should not be exposed to direct sunlight, extreme temperatures or moisture, as this can result in serious irreparable damage.
– For U.S.A. only –
- (3) This Projection Display TV has an Electrodeless Discharge Lamp that contains mercury. Disposal may be regulated in your community due to environmental considerations. For disposal or recycling information, please contact your local authorities, or the Electronic Industries Alliance: <<http://www.eiae.org>>

Trademarks

- VGA and XGA are trademarks of International Business Machines Corporation.
- Macintosh is a registered trademark of Apple Inc., USA.
- SVGA is a trademark of the Video Electronics Standard Association.
Even if no special notation has been made of company or product trademarks, these trademarks have been fully respected.
- Equipped with **dbx**[®]-TV Noise Reduction for true MTS reproduction. **dbx**[®]-TV Noise Reduction is required for good stereo separation and audio fidelity. **dbx**[®] is a registered trademark, and is licensed by **dbx**[®] Technology Licensing.
- LIFI[™] is a trademark of LUXIM[®] Corporation.



HDMI, the HDMI logo and High-Definition Multimedia Interface are trademarks or registered trademarks of HDMI Licensing LLC.



Manufactured under license from BBE Sound, Inc. Licensed by BBE Sound, Inc. under one or more of the following US patents: 5510752, 5736897. BBE and BBE symbol are registered trademarks of BBE Sound, Inc.



SDHC Logo is a trademark.



Manufactured under license from Dolby Laboratories. Dolby and the double-D symbol are trademarks of Dolby Laboratories.



LIFI[™] is a trademark of LUXIM[®] Corporation.



GalleryPlayer and the GalleryPlayer Logo are trademarks of GalleryPlayer, Inc.



EZ Sync[™] is a trademark of Matsushita Electric Industrial Co., Ltd.



HDAVI Control[™] is a trademark of Matsushita Electric Industrial Co., Ltd.

Licensed by Ferguson under UPS5717422.

License description: To view the license information for software used in this product, press MENU button and select "Setup"→"About"→"License". (p. 55)

Note

- Do not allow a still picture to be displayed for an extended period, as this can cause a permanent afterimage to remain on this unit. Examples of still pictures include logos, video games, computer images, teletext and images displayed in 4:3 mode.

Dear Panasonic Customer

Welcome to the Panasonic family of customers. We hope that you will have many years of enjoyment from your new Projection Display.

To obtain maximum benefit from your set, please read these Instructions before making any adjustments, and retain them for future reference.

Retain your purchase receipt also, and record the serial number of your set in the space provided on the rear cover of these instructions.

Visit our Panasonic Web Site for USA : www.panasonic.com / for Canada : www.panasonic.ca

(USA)	For assistance, please call : 1-888-VIEW PTV(843-9788) or, contact us via the web at: http://www.panasonic.com/contactinfo
(Puerto Rico)	For assistance, please call : 787-750-4300 or visit us at www.panasonic.com
(Canada)	For assistance, please call : 1-800-561-5505 or visit us at www.panasonic.ca

– For U.S.A. –

FCC STATEMENT:

NOTE:

This equipment has been tested and found to comply with the limits for a Class B digital device, pursuant to Part 15 of the FCC Rules. These limits are designed to provide reasonable protection against harmful interference in a residential installation. This equipment generates, uses and can radiate radio frequency energy and, if not installed and used in accordance with the instructions, may cause harmful interference to radio communications. However, there is no guarantee that interference will not occur in a particular installation. If this equipment does cause harmful interference to radio or television reception, which can be determined by turning the equipment off and on, the user is encouraged to try to correct the interference by one or more of the following measures:

- Reorient or relocate the receiving antenna.
- Increase the separation between the equipment and receiver.
- Connect the equipment into an outlet on a circuit different from that to which the receiver is connected.
- Consult the dealer or an experienced radio / TV technician for help.

FCC Caution:

To assure continued compliance, follow the attached installation instructions and use only shielded interface cables when connecting to computer or peripheral devices. Any changes or modifications not expressly approved by the party responsible for compliance could void the user's authority to operate this equipment.

ANY CHANGES OR MODIFICATIONS TO THIS PTV RECEIVER NOT EXPRESSLY APPROVED BY PANASONIC CORPORATION OF NORTH AMERICA COULD CAUSE HARMFUL INTERFERENCE, WHICH WOULD VOID THE USER'S AUTHORITY TO OPERATE THIS EQUIPMENT.



The Class II insulation symbol (square within a square) indicates that this product has been evaluated and tested to comply with Class II insulation requirements.

Declaration of Conformity

Models Number: **PT-50LCZ70/PT-56LCZ70/PT-61LCZ70/PT-50LCZ7/PT-56LCZ7/PT-61LCZ7**

Trade Name: **Panasonic**

Responsible party: **Panasonic Corporation of North America**

Address: **One Panasonic Way, Secaucus, New Jersey 07094**

Telephone number: **1-888-VIEW PTV(843-9788)**

This device complies with Part 15 of the FCC Rules. Operation is subject to the following two conditions: (1) This device may not cause harmful interference, and (2) this device must accept any interference received, including interference that may cause undesired operation.

CANADIAN NOTICE:

1. Cable Compatible Television Apparatus
2. This Class B digital apparatus complies with Canadian ICES-003.

Table of Contents

To Start !	▲ IMPORTANT SAFETY INSTRUCTIONS	2
	Before Using	6
	Location of Controls	9
	Installation.....	12
	Recommended AV Connections	21
Use Now !	Power ON / OFF	24
	Tuning channels.....	26
	Projection Display Operation	29
	ASPECT Controls	33
Enjoy More !	EZ Sync™ Feature.....	34
	Picture Adjustments.....	35
	Audio Adjustments.....	38
	Sleep Timer Feature	40
	Lock Feature	41
	Viewing from SD Card.....	46
	Setup Features.....	49
Other Information !	Operating Peripheral Equipment	56
	Remote Control Operation/Code List	57
	Warning Indicators	61
	Troubleshooting	62
	Specifications	63
	Customer Services Directory (for U.S.A.)	64
	Limited Warranty (for U.S.A.)	65
	Limited Warranty (for Canada).....	66
Index	67	

Before Using

Receiver Location

This Projection Display is intended to be used with an optional stand or entertainment center. Consult your dealer for available options.

Situate for comfortable viewing. Avoid placing where sunlight or other bright light (including reflections) will fall on the screen.

Use of some types of fluorescent lighting can reduce Remote Control transmitter range.

Adequate ventilation is essential to prevent internal component failure. Keep away from areas of excessive heat or moisture.

Optional External Equipment

The Video / Audio connection between components can be made with shielded video and audio cables. For best performance, video cables should utilize 75 Ω coaxial shielded cables. Cables are available from your dealer or electronics store.

Before you purchase any cables, be sure you know what type of output and input connectors your various components require. Also determine the length of cable you'll need.

Safety Precaution

Please take safety precautions to prevent the unit from falling over.

⚠ WARNING

The unit may tip or fall if not situated on a stable surface, if pushed or during an earthquake. Use a strong rope or chain (not included) to fasten the Projection Display firmly to a strong wall support.

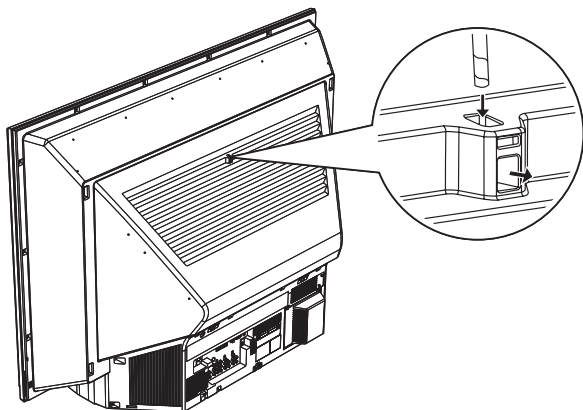

Installation Dimensions Diagram

⚠ CAUTION

Keep the unit at least 100 mm (4") away from the wall to provide proper ventilation because warm air is discharged. Blocking the ventilation opening of the cooling fan may damage the unit.

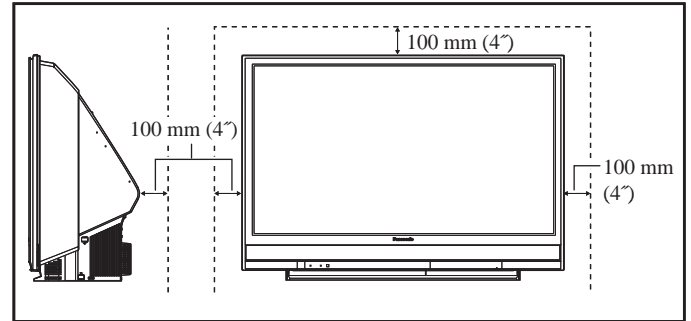

Accessories

1. Remote Control (N2QAYB000100)
2. Batteries 2 "AA"
3. Cleaning cloth (LSFQ0003)

Viewing position

To optimize your viewing comfort, please follow the viewing guidelines shown in the diagrams below. If viewing for an extended period of time, sit as far back from the screen as possible.

< Top view >

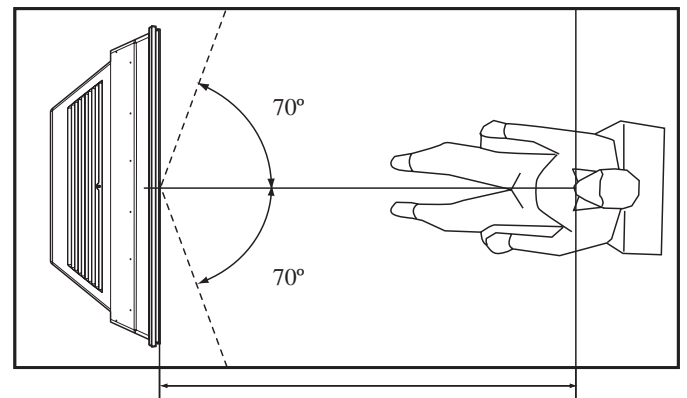

At least
1.8 m (PT-50LCZ70/PT-50LCZ7/PT-50LCZ70-K) /
2.0 m (PT-56LCZ70/PT-56LCZ7/PT-56LCZ70-K) /
2.2 m (PT-61LCZ70/PT-61LCZ7/PT-61LCZ70-K).

< Side view >

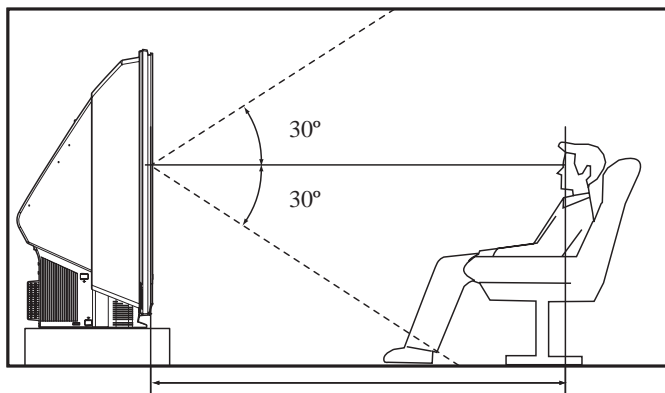

At least
 1.8 m (PT-50LCZ70/PT-50LCZ7/PT-50LCZ70-K) /
 2.0 m (PT-56LCZ70/PT-56LCZ7/PT-56LCZ70-K) /
 2.2 m (PT-61LCZ70/PT-61LCZ7/PT-61LCZ70-K).

Remote Control Battery Installation

Requires two AA batteries (supplied).

1. While pressing in on the catch, open cover in direction of arrow.

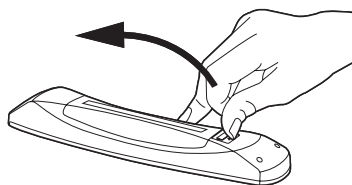

2. Install batteries in the battery compartment.
 - Battery polarity (+) and (-) must match the markings inside the compartment.



Two AA size

3. Press cover until it snaps shut.

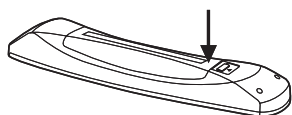

CAUTION

Incorrect battery installation can cause the batteries to leak, leading to personal injury and/or damage to the Remote Control.

Observe the following precautions:

1. Always replace batteries with a pair of new ones.
2. Do not combine a new battery with an old one.
3. Do not mix battery types (example: "Zinc Carbon" with "Alkaline").
4. Do not attempt to charge, short-circuit, disassemble, heat or burn used batteries.
5. Battery replacement is necessary when the Remote Control acts sporadically or stops operating the Projection Display set.

Helpful Hints:

- (1) Frequent Remote Control users choose long-lasting Alkaline batteries as replacements.
- (2) Whenever batteries are removed, **you may need to reset Remote Control infrared codes.** We suggest making a note of the codes on page 56 prior to setting up the remote.

Reset All Memory Functions

Use when moving unit to a new location, or when First Time Setup needs to be done over.

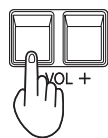

Press together the VOL- button on the unit and MENU button on the Remote Control for more than 3 seconds.

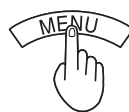

Selfcheck

Selfcheck in progress.
Please refrain from any activity. Do not turn off or unplug the TV.

After the above message indication disappeared, unplug the unit then plug it back in and turn power ON.



Note

- When using "EZ Sync™ "HDAVI Control™"" , with the device connected, set "EZ Sync" first to "Off" and then "On" using the Setup Menu. (p. 52-53)

Before Using (continued)

Cleaning

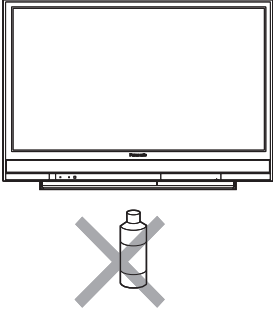
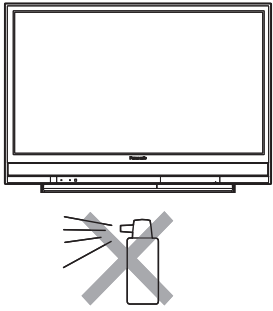
To ensure continued excellent performance from this product, periodic cleaning is recommended.

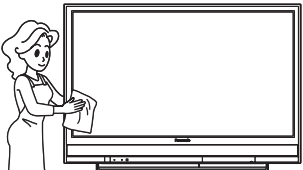
Projection Display	
	The unit contains many plastic parts. For this reason DO NOT use benzene, thinner or other chemicals to clean the unit.
	DO NOT bring into contact with insecticide or other volatile substances. DO NOT allow the unit to come into contact for extended periods with rubber or vinyl products.
	Remove dirt and soiling by wiping with a light cloth. Even if the unit is heavily soiled, do not apply cleaner directly to the unit. Soak a cloth in a solution of neutral cleanser diluted with water. Then wring out the cloth, wipe the unit clean, and finish by wiping with a dry cloth. Do not use any type of cleansers on the picture screen.
Picture Screen	
	Dust will accumulate on the picture screen. Please wipe with a soft cloth from time to time. If you use a chemically treated cloth, please be careful to follow the instructions that come with the cloth.

Location of Controls

Remote Control

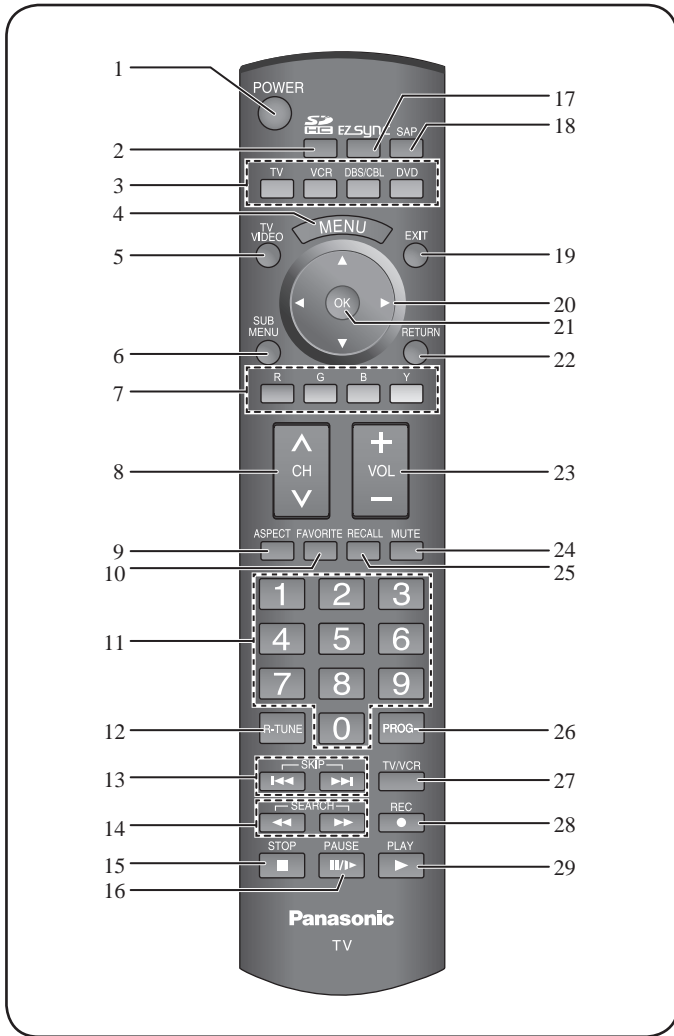

1	POWER	Press to turn ON and OFF.
2	SD	Press to view from SD Card.
3	TV	Sets the remote to control television or digital television.
	VCR, DBS/CBL, DVD	Sets the remote to control other devices.
4	MENU	Press to display Main Menu.
5	TV/VIDEO	Changes Input source.
6	SUB MENU	Press to display the Sub Menu.
7	FUNCTION	Press to use for various functions.
8	CH \updownarrow	Press to change channels.
9	ASPECT	Changes display aspect ratio.

10	FAVORITE	Press to operate the Favorite channel list function.
11	NUMBER	Press numeric keypad to select any channel or to make alpha-numeric entries in menus.
12	R-TUNE	Press to switch to previously viewed channel or input modes.
13	SKIP $\leftarrow\leftarrow$	While remote is in DVD mode, press to skip backward.
	SKIP $\rightarrow\rightarrow$	While remote is in DVD mode, press to skip forward.
14	SEARCH $\leftarrow\leftarrow$	While remote is in VCR or DVD mode, press to rewind.
	SEARCH $\rightarrow\rightarrow$	While remote is in VCR or DVD mode, press to fast forward.
15	STOP	While remote is in VCR or DVD mode, press to stop.
16	PAUSE	While remote is in VCR or DVD mode, press to pause.
17	EZ Sync	Press to display EZ Sync menu.
18	SAP	In analog mode, press to access audio modes (Stereo, SAP or Mono). In digital mode, press to access next audio track.
19	EXIT	Press to exit menus.
20	SELECT $\updownarrow\leftarrow\rightarrow$	Controls navigation around on-screen menu.
21	OK	Press to select menu and sub-menu items.
22	RETURN	Press to return one step backward in menus.
23	VOL \rightarrow	Press to adjust TV sound.
24	MUTE	Press to mute sound.
25	RECALL	Press to display or delete Channel banner.
26	PROG-	Press after entering a digital channel to enter a sub-channel.
27	TV/VCR	Press to switch to TV or VCR.
28	REC	While remote is in VCR or DVD mode, press to record.
29	PLAY	While remote is in VCR or DVD mode, press to play.

Controls and Terminals on the Projection Display

Front View <Model PT-56LCZ70 unit shown>

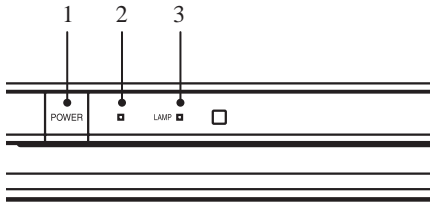

1	POWER button	Press to turn ON and OFF. (p. 24, 61, 62)
2	POWER indicator	Lights up green when power is ON. (p. 24, 61, 62)
3	LAMP indicator	Lights up or flashes when the lamp unit is malfunctioning. (p. 24, 61)



Remote Control Sensor

Open Door:
Press position ①, and slide Door open as shown by arrow.

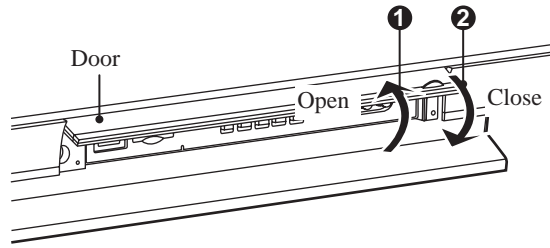

Close Door:
Press position ②, and slide Door closed as shown by arrow.

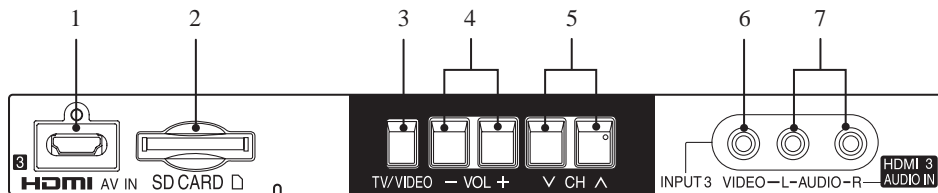

1	HDMI Input Terminal 3	Connect from other component. (HDMI 3)
2	SD CARD Slot	Insert SD Card.
3	TV/VIDEO*	Changes Input source.
4	VOL +/-*	Press to adjust TV sound.

5	CH va*	Press to change channels.
6	Video Input Connector 3	Connect from other component. (Video 3)
7	Audio Input Connector 3	Connect from other component. (Video 3 / HDMI 3)

* Buttons listed above operate the same as Remote Control buttons of the same name.

Rear View <Model PT-56LCZ70 unit shown>

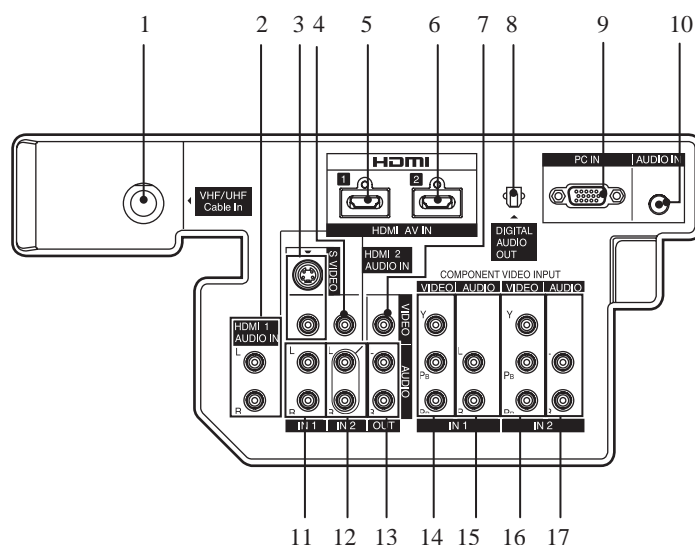
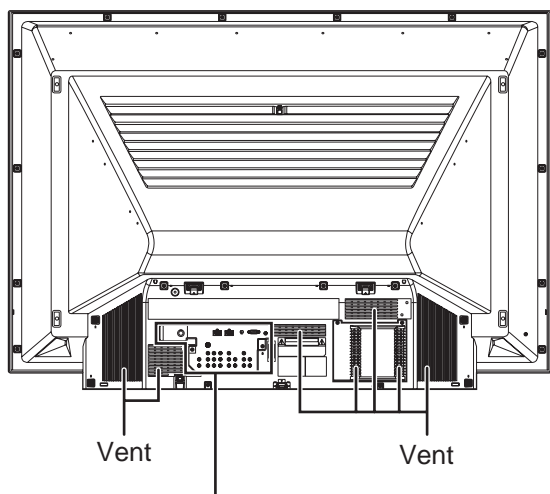

1	VHF/UHF Cable In	Input terminal for an antenna or cable box signal.	
2	HDMI Input Terminal 1	Audio 1	Connect from other component. (HDMI 1)
3	S Video/Video Input Connector 1		Connect from other component. (Video 1)
4	Video Input Connector 2		Connect from other component. (Video 2)
5	HDMI Input Terminal 1	Audio/Video 1	Connect from other component. (HDMI 1)
6	HDMI Input Terminal 2	Audio/Video 2	Connect from other component. (HDMI 2)
7	Video Out Connector		Output video signal.
8	DIGITAL AUDIO OUT		Output audio signal (Digital)
9	PC (RGB) Input Connector		Connect from PC. (PC)
10	Audio Input Connector		Connect from PC. (PC)

11	Audio Input Connector 1		Connect from other component. (Video 1)
12	HDMI Input Terminal 2	Audio 2	Connect from other component. (HDMI 2)
	Audio Input Connector 2		Connect from other component. (Video 2)
13	Audio Out Connector		Output audio signal. (Analog)
14	Component Video Input Connector 1		Connect from other component. (Component 1)
15	Audio Input Connector 1		Connect from other component. (Component 1)
16	Component Video Input Connector 2		Connect from other component. (Component 2)
17	Audio Input Connector 2		Connect from other component. (Component 2)

Notes

- Make sure the vents are not blocked. (This could cause damage.)
- Indication on the back panel may change without notice.

Installation

Connected Equipment Introduction (Signal source)

■ Watching TV

VHF/UHF Antenna

- NTSC (National Television System Committee): Conventional broadcasting
- ATSC (Advanced Television Systems Committee): Digital TV Standards include digital high-definition television (HDTV), standard-definition television (SDTV), data broadcasting, multi-channel surround-sound audio and interactive television.

Cable Box/Cable

- You need to subscribe to a cable TV service to enjoy viewing their programming.
- You can enjoy high-definition programming by subscribing to a high-definition cable service. The connection can be done with the use of HDMI or Component Video cable.

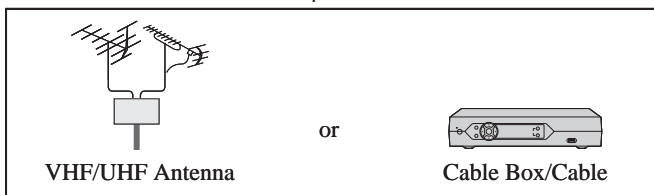

■ Recording/playing back with DVD recorder or VCR

DVD Recorder

This source has higher resolution through interlace or progressive signal. Connection can be done with the use of Component Video or HDMI cable.

VCR

Connection can be done with the use of an RF cable and Composite Video/S VIDEO.

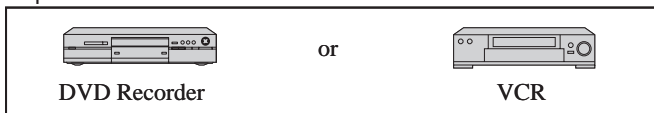

■ Watching Satellite

You can enjoy high-definition programming by subscribing to a high-definition satellite service. Connection can be done with the use of HDMI or Component Video cable.

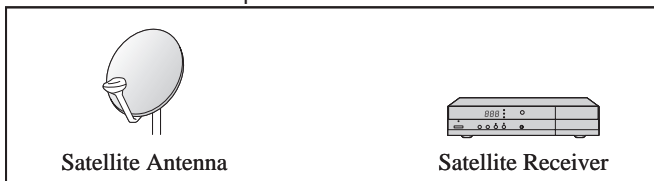

■ Enjoying Home theater and DVD recorder with HDMI connection

Home theater and DVD Recorder

HDMI connection enables you to enjoy higher quality audio and video with a single cable.

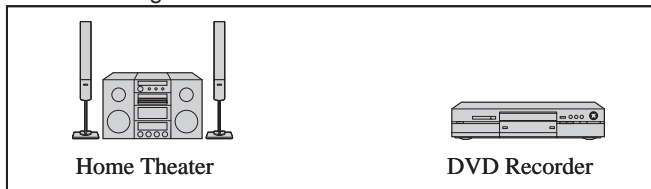

■ Enjoying large screen capabilities with PC connection

You can enjoy playing computer games or making presentations on a large screen with the PC connection.

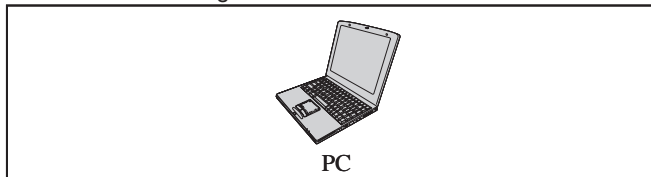

Notes

- If your Panasonic DVD Recorder is compatible with EZ Sync (HDAVI control 2), you can operate your Panasonic DVD Recorder with this Projection Display's remote control (EZ Sync™ on page 34).
- All cables and external equipment shown in this book are not supplied with this Projection Display.
- For the details of the external equipment's connections, please refer to the operating manuals for the equipment.

Reference of connection

■ Antenna terminal

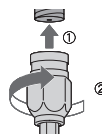

- Firmly tighten by hand.

■ Pin terminals

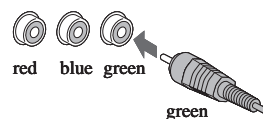

- Match colors of plugs and terminals.
- Insert firmly.

■ HDMI terminal

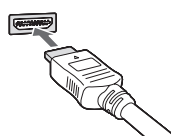

- Insert firmly.

■ S VIDEO terminal

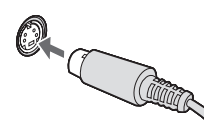

- Insert firmly.

■ PC terminal

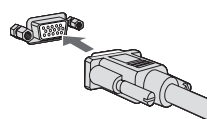

- Insert firmly.

Example 1 Connecting Antenna (To watch TV)

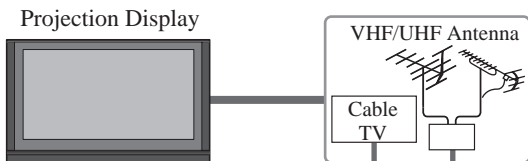

! CAUTION

When using "Nut type" RF coaxial cable, tighten with fingers only. Overtightening may damage terminal.

To connect antenna terminals

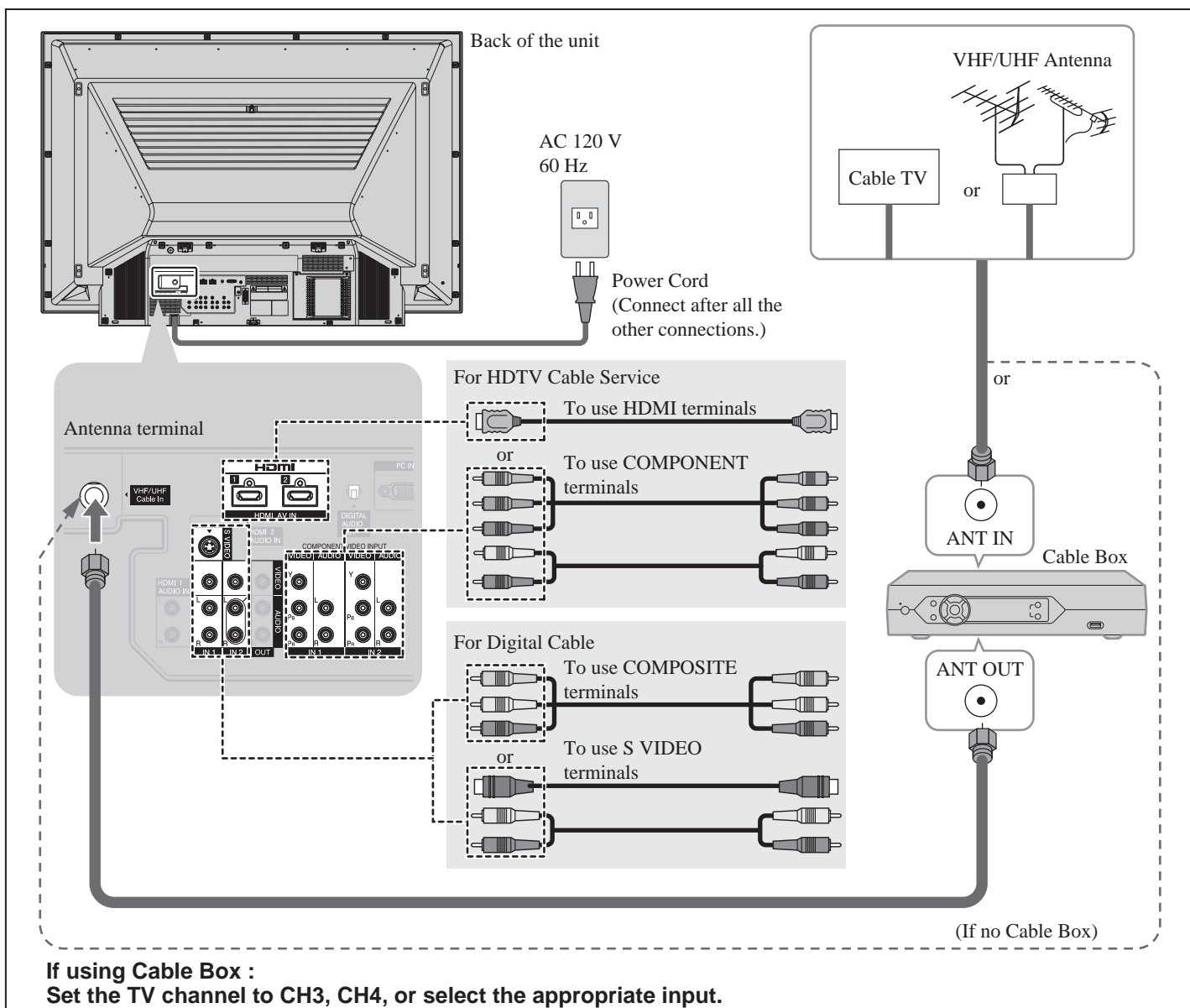

Note

- For additional assistance, visit us at : www.panasonic.com
www.panasonic.ca

Installation (continued)

Example 2 Connecting DVD recorder (VCR) (To record/playback)

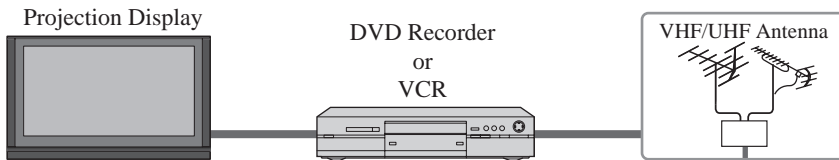

⚠ CAUTION

When using "Nut type" RF coaxial cable, tighten with fingers only. Overtightening may damage terminal.

To connect antenna terminals

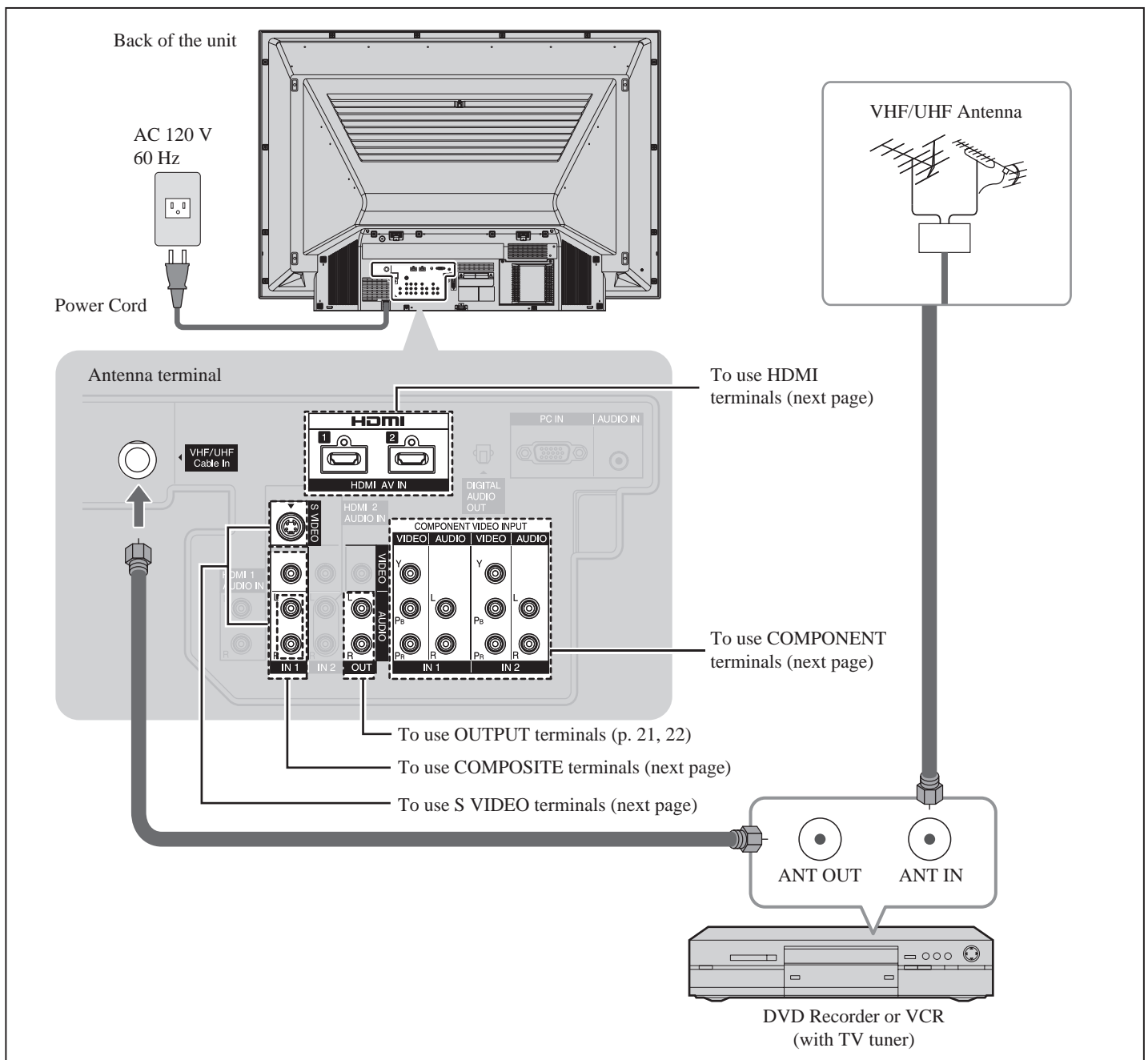

■ To use HDMI terminals

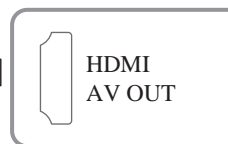
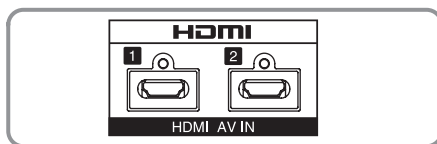

DVD Recorder, Blu-ray Disc Player, DTV STB, etc

- Connecting to HDMI terminals will enable you to enjoy high-definition digital images and high-quality sound by connecting this Projection Display and the devices.

■ To use COMPONENT terminals

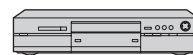
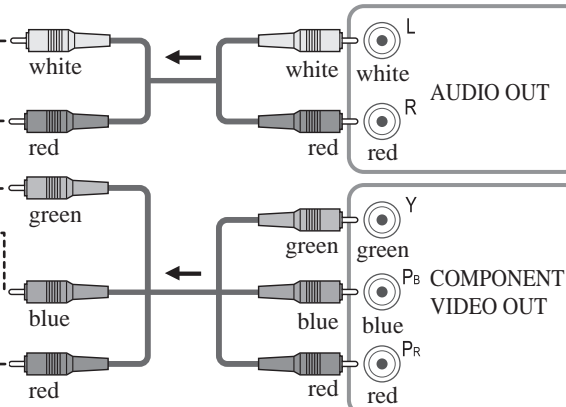
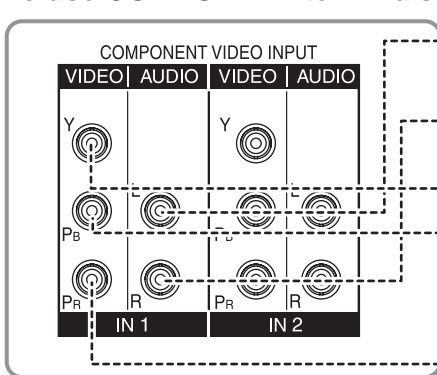

DVD Recorder, Blu-ray Disc Player, DTV STB, etc

- Recorders may also be connected to COMPOSITE or S VIDEO terminals. (see below.)

■ To use COMPOSITE terminals

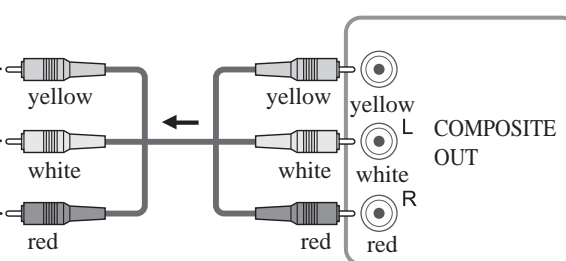
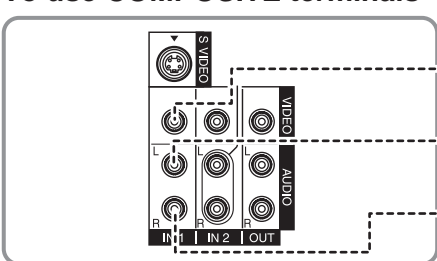

DVD Recorder

or



VCR

■ To use S VIDEO terminals

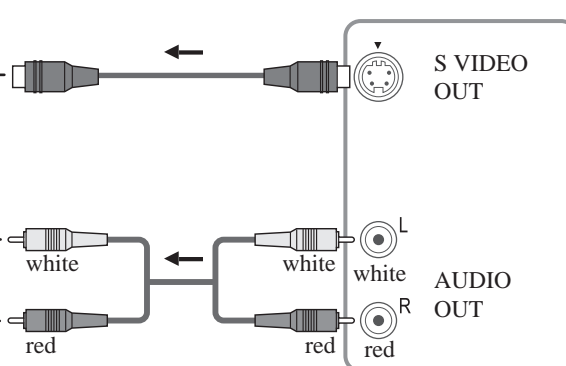
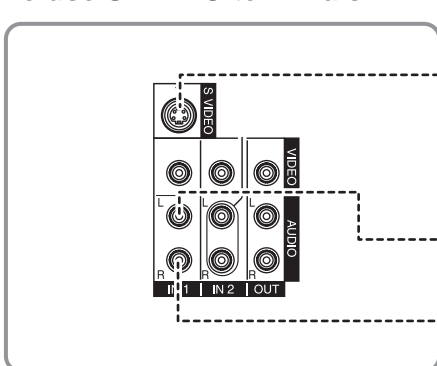

DVD Recorder

or



VCR

- The S Video input will override the composite video signal when S Video cable is connected. Connect either S Video or Video cable.
- Connecting to S VIDEO terminals will enable you to enjoy greater picture quality than using Composite terminals.

Notes

- Some programs contain a copyright protection signal to prevent recording.
- When the copyright protection program is displayed, do not connect the other TV monitor through a VCR. Video signals fed through VCRs may be affected by copyright protection systems and the picture will be distorted on the other TV monitor.

Installation (continued)

Example 3 Connecting DVD recorder (VCR) and satellite receiver

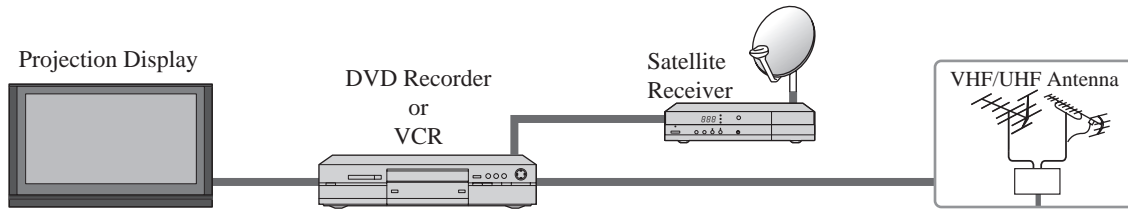

⚠ CAUTION

When using “Nut type” RF coaxial cable, tighten with fingers only. Overtightening may damage terminal.

To connect antenna terminals

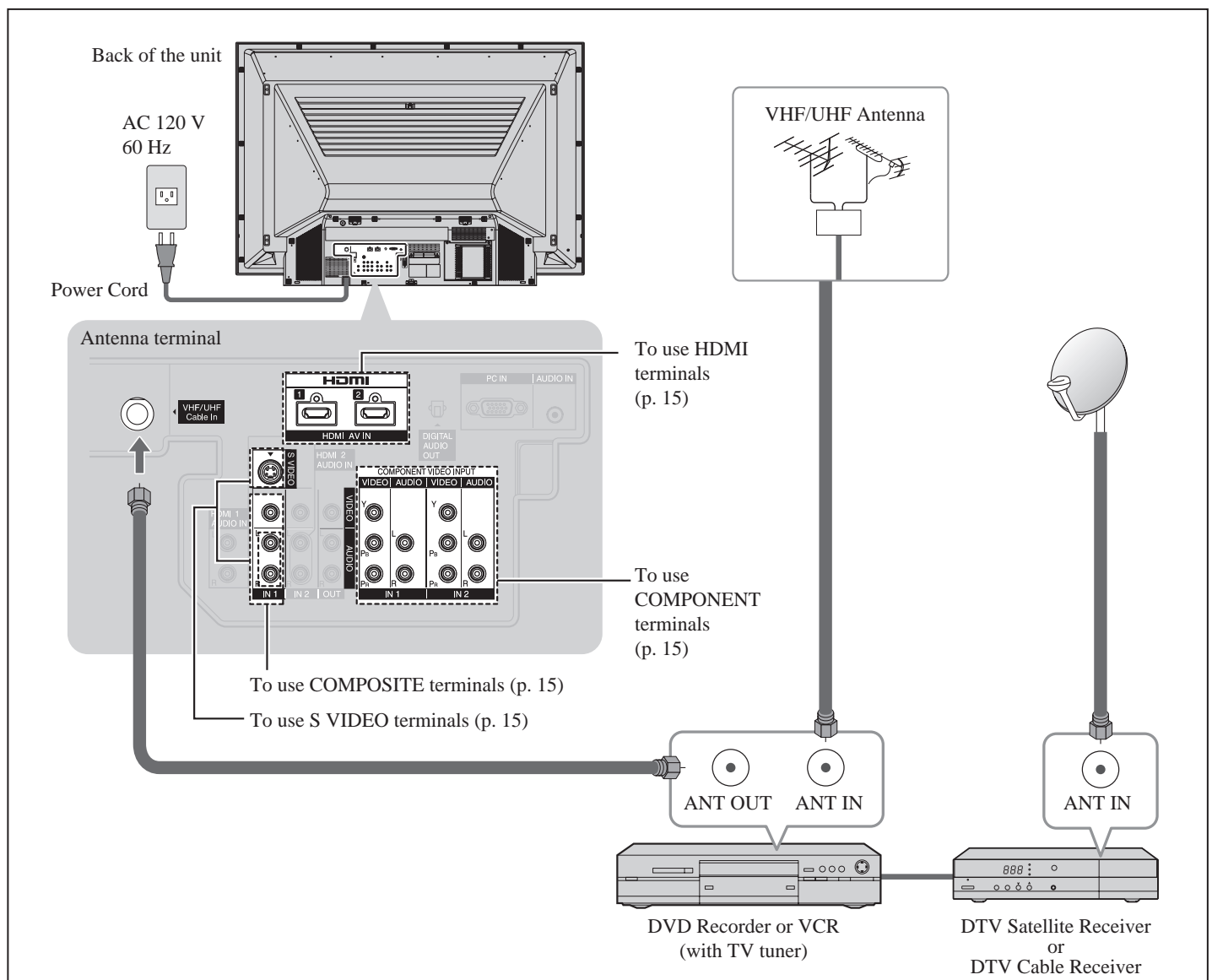

Connecting this Projection Display and DVD recorder (VCR)

Connect in the same way as on page 15.

■ To use HDMI terminals

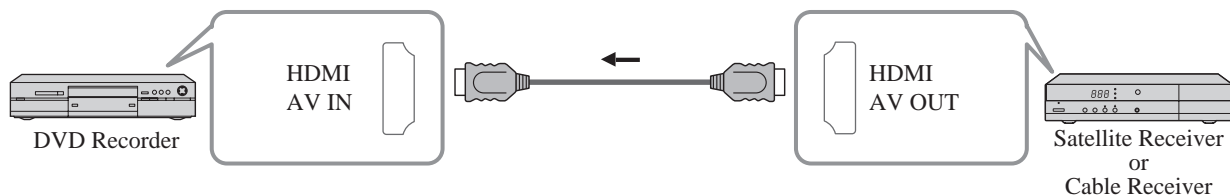

- Connecting to HDMI terminals will enable you to enjoy high-definition digital images and high-quality sound.

■ To use COMPONENT terminals

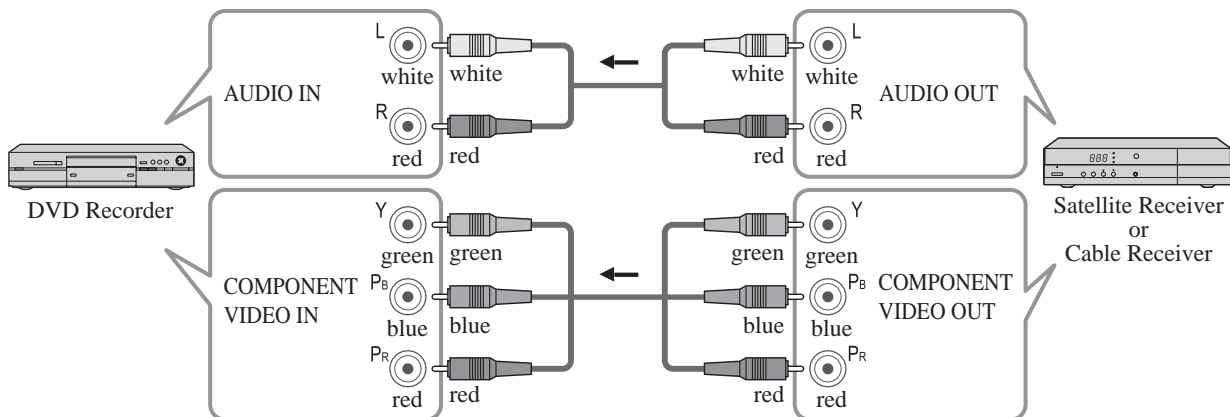

- Satellite Receiver may also be connected to COMPOSITE or S VIDEO terminals. (see below.)

■ To use COMPOSITE terminals

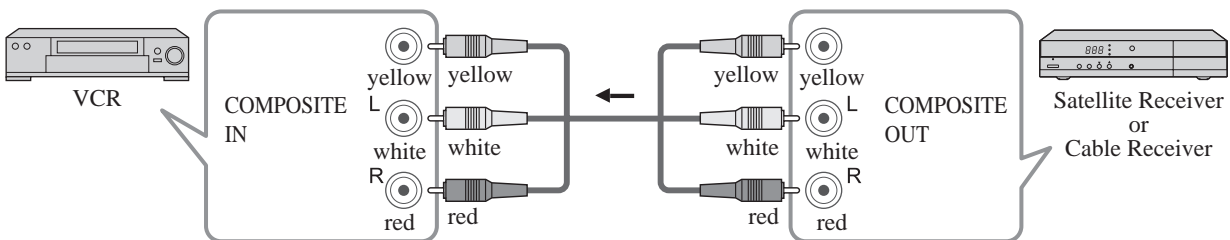

■ To use S VIDEO terminals

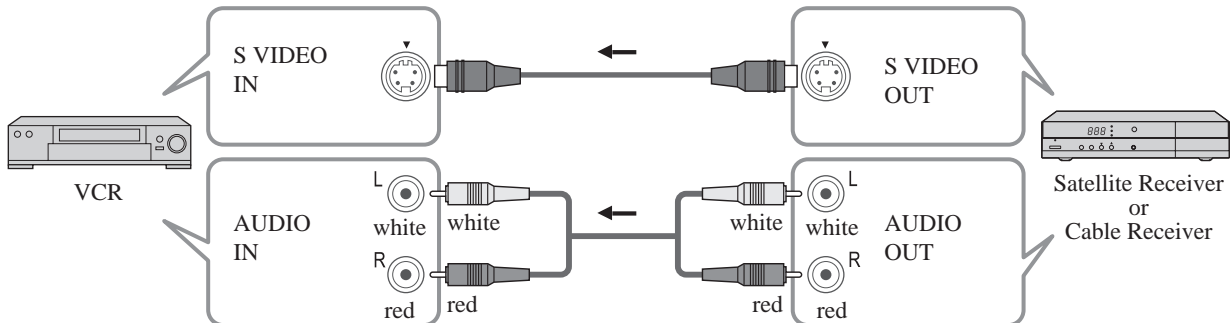

- The S Video input will override the composite video signal when S Video cable is connected. Connect either S Video or Video cable.
- Connecting to S VIDEO terminals will enable you to enjoy greater picture quality than using Composite terminals.

Installation (continued)

Example 4 Connecting Home Theater and DVD recorder

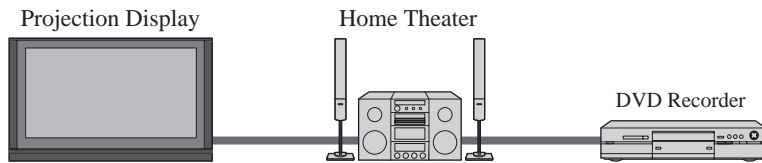

To connect HDMI terminals

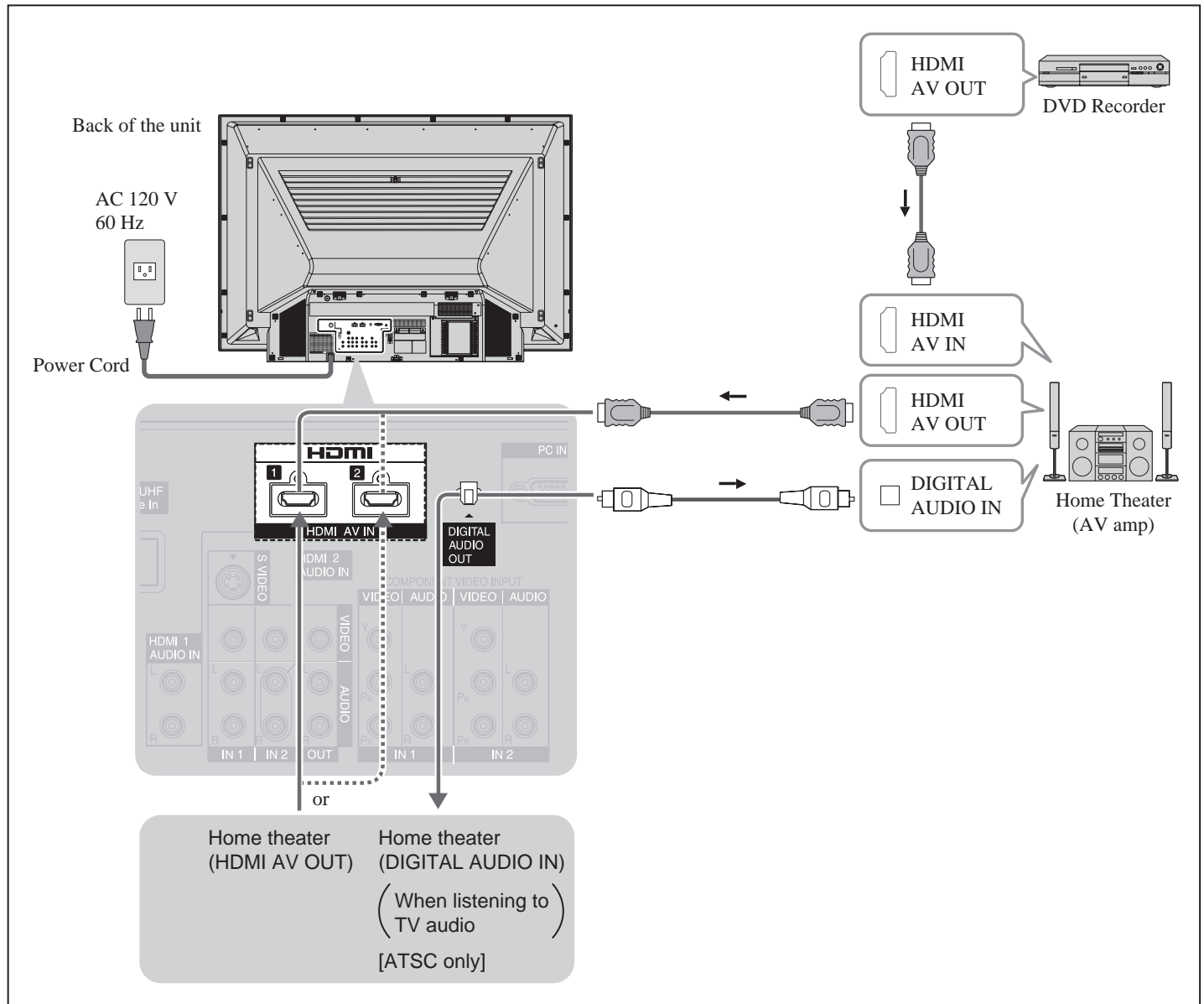

Notes

- It is recommended that you use Panasonic's HDMI cable. (p. 52)
- When Using the COMPONENT VIDEO OUT terminals or the S VIDEO OUT terminal, refer to page 17 "To use COMPONENT terminals" or "To use S VIDEO terminals".
- If you connect RAM theater or Player theater with HDMI cable, use audio cable instead of the optical digital audio cable. (p. 22)

Example 5 Connecting PC

Projection Display

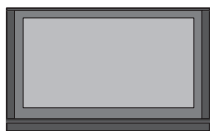

PC



To connect PC terminals

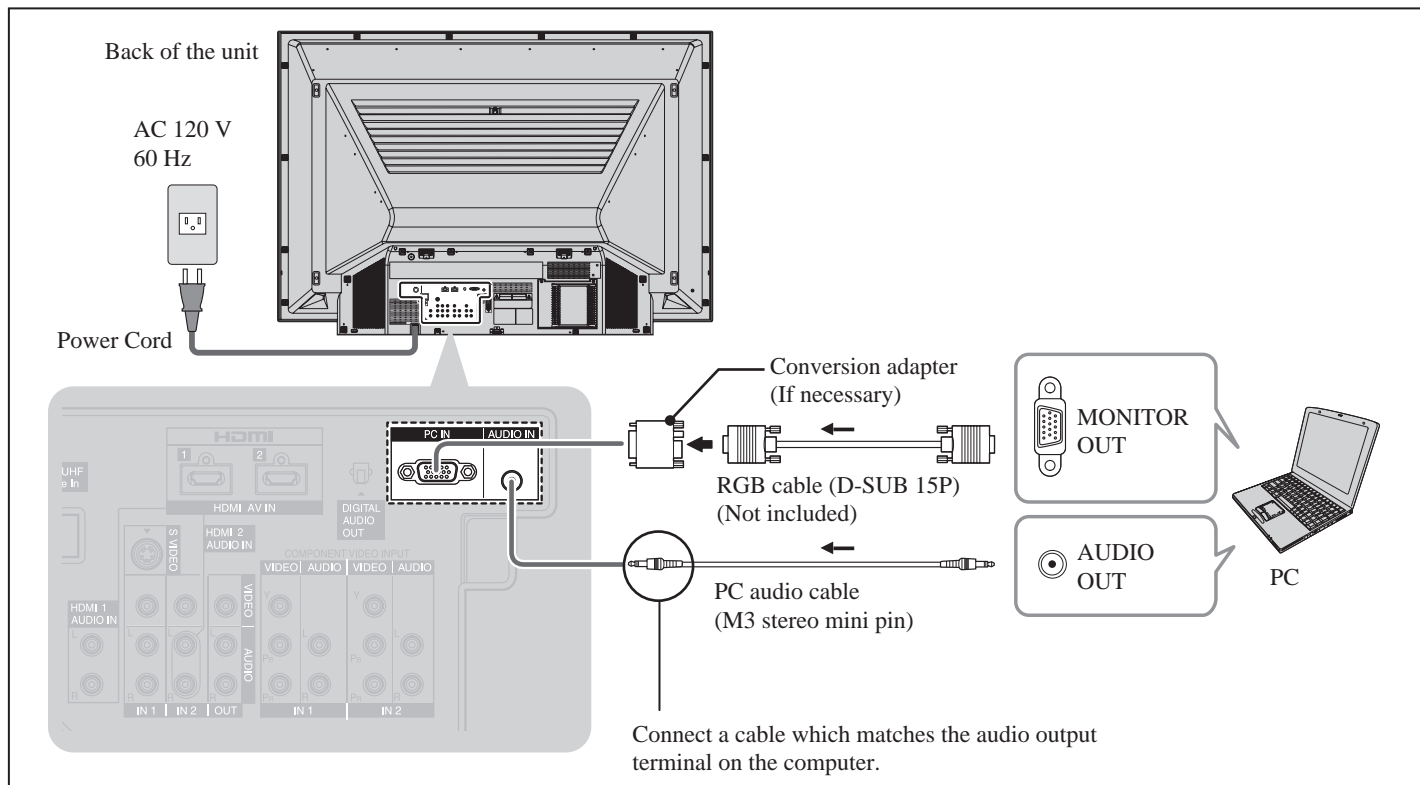

PC IN Terminal (D-SUB 15P) Pin Layouts

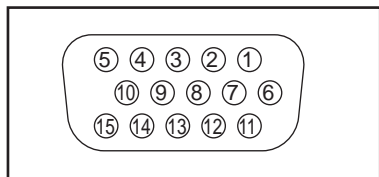

Connection port view

Pin No.	Signal name	Pin No.	Signal name
1	R	9	NC
2	G	10	Ground
3	B	11	NC
4	NC	12	NC
5	NC	13	HD/CSYNC
6	Ground for R	14	VD
7	Ground for G	15	NC
8	Ground for B		

NC: Not connected

Notes

- Some PC models cannot be connected to the set. A conversion adapter is required to use the RGB cable (D-SUB 15P) (Not included) to connect a Macintosh computer to the set. There is no need to use an adapter for computers with PC / AT compatible D-SUB 15P terminal.
- The computer shown in the illustration is for example purposes only. Additional equipment and cables shown are not supplied with this set.
- Do not set the horizontal and vertical scanning frequencies for PC signals which are above or below the specified frequency range.
- Select the desired PC input position by pressing the TV/VIDEO button on the Remote Control. (p. 29)

Installation (continued)

RGB signals that can be input

The table below lists the different types of RGB signals that can be input.

If a signal which differs greatly from the types listed below is input, the picture may not be displayed correctly, or a black background may be displayed.

Mode type		Signal data		
		No. of dots (H × V)	Horizontal frequency (kHz)	Vertical frequency (Hz)
Personal Computer Signals	VGA400 (70 Hz)	640 × 400	31.47	70.08
	VGA480 (60 Hz)	640 × 480	31.47	59.94
	Macintosh 13" *	640 × 480	35.00	66.67
	VGA480 (75 Hz)	640 × 480	37.50	75.00
	SVGA (60 Hz)	800 × 600	37.88	60.32
	SVGA (75 Hz)	800 × 600	46.88	75.00
	SVGA (85 Hz)	800 × 600	53.67	85.06
	Macintosh 16" *	832 × 624	49.73	74.55
	WVGA (60 Hz)	852 × 480	31.47	59.94
	XGA (60 Hz)	1 024 × 768	48.36	60.00
	XGA (70 Hz)	1 024 × 768	56.48	70.07
	XGA (75 Hz)	1 024 × 768	60.02	75.03
	XGA (85 Hz)	1 024 × 768	68.67	85.00
	Macintosh 21" *	1 152 × 870	68.68	75.06
	SXGA (60 Hz)	1 280 × 1 024	63.98	60.02
	WXGA (60 Hz)	1 366 × 768	48.39	60.04

Notes

- The D-SUB 15P connector can accept RGB (H-V sync separate).
- The signal with a * mark is compatible with sync on Green.
- To view a WXGA and WVGA picture, a setting change is necessary. Please refer to "PC Adjust" on page 37.

Recommended AV Connections

These diagrams show our recommendations for how to connect this Projection Display to your various equipment. For other connections, consult the instructions and the specifications for each piece of equipment. (p. 63)

For additional assistance, please visit our website at: www.panasonic.com
www.panasonic.ca

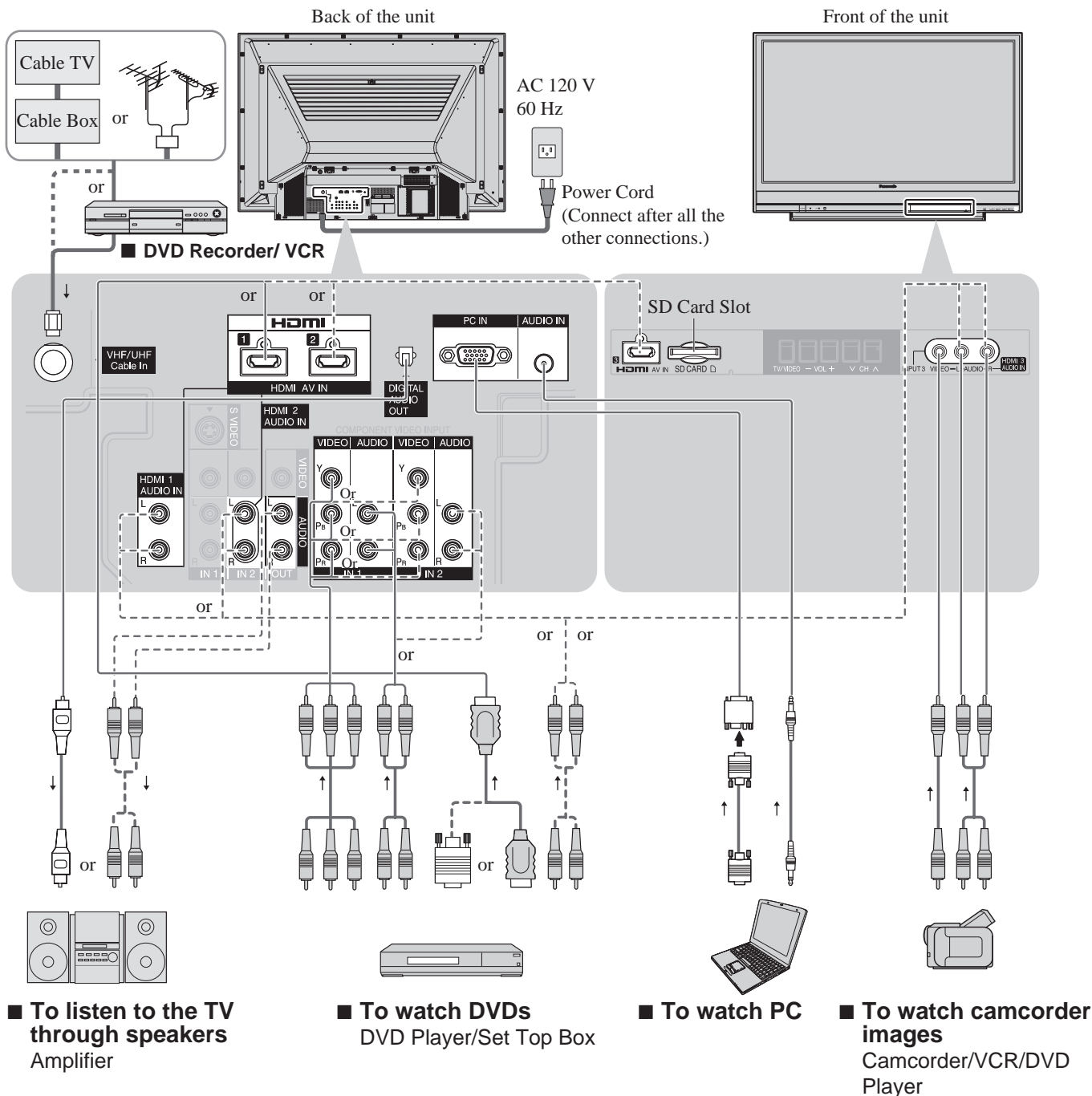

Notes

- The picture and audio input signals connected to a terminal specified in "Monitor out" (p. 50) cannot be output from "OUTPUT" terminals. However, audio output can be obtained from "DIGITAL AUDIO OUT" terminal.
- To prevent howling and image oscillation, set the "Monitor out" setting when connecting the VCR with loop-connection. (p. 50)
- When equipment (STB, DVD, etc.) is connected to HDMI or COMPONENT terminals, only audio signals can be obtained. From the output terminals, no video signals can be passed.
- When receiving digital channel signals, all digital formats are down-converted to composite NTSC video to be output through the OUTPUT terminals.

Recommended AV Connections (continued)

EZ Sync™ Connections

Follow the connection diagrams below for HDAVI control of a single AV piece of equipment such as a Panasonic DIGA-DVD recorder, RAM theater, or Player theater system. Refer to pages 52-54 for Setup Menu settings and additional control information.

- Optional HDMI and/or optical cables are not provided.

If the connection (or settings) of equipment compatible with HDAVI control has been changed, switch the power of this unit Off then On again while the power of all equipment is On (so that the unit can correctly recognize the connected equipment) and check that DIGA, RAM theater, and Player theater playback operate.

Note

- HDMI 1 is recommended. When connecting to HDMI 2 or HDMI 3, set the input mode to HDMI 2 or HDMI 3 (p. 29) initially before connecting to HDMI 2 or HDMI 3. After connection, confirm the HDMI control functions (p. 52-54).

■ Connecting this unit to a DVD recorder and AV amp

When using an “EZ Sync” audio-video amplifier and a compatible DIGA recorder, use a daisy chain connection as shown below.

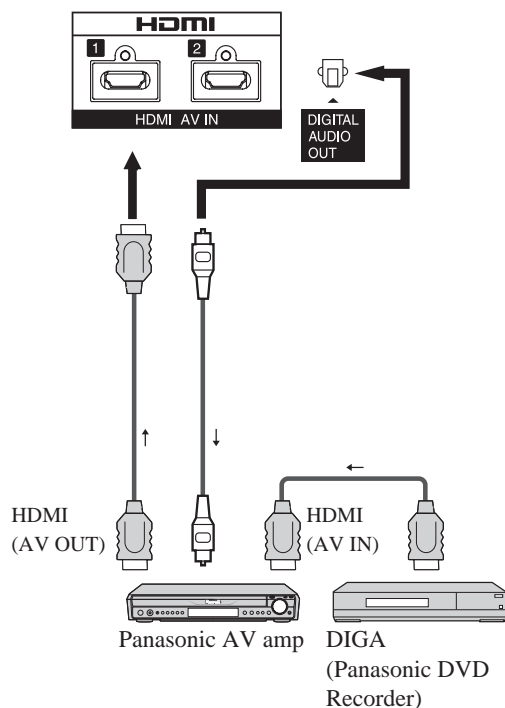

■ Connecting this unit to the DIGA, RAM theater, Player theater, or HD Camcorder

- For DIGA : Connect with HDMI cable
- For RAM theater and Player theater : Connect with the HDMI and audio cables. If audio cable is not connected, you cannot listen to the TV program through the theater system.
- For HD Camcorder : Connect with HDMI cable (HDMI 3 is recommended when connecting to a Camcorder via HDMI.)

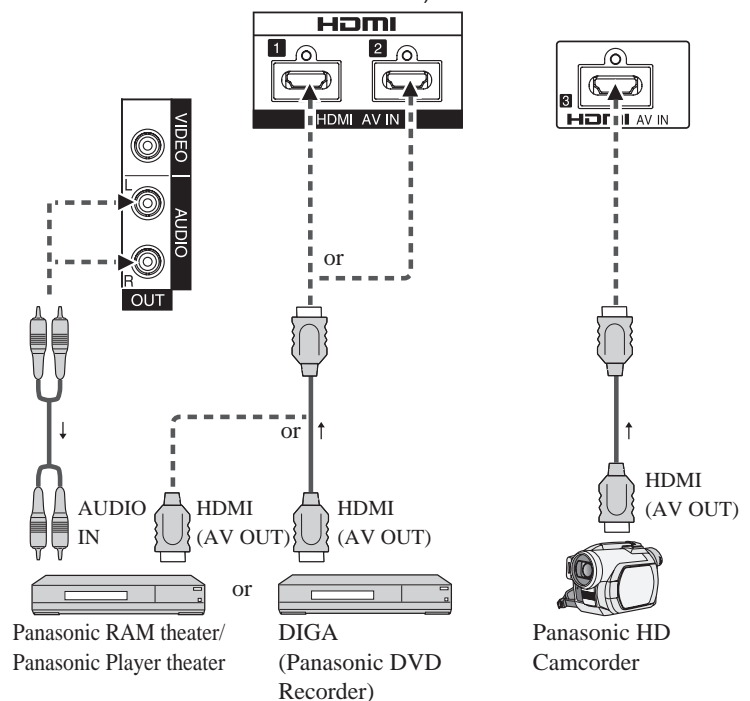

- One AV amp and one DIGA recorder can be operated with this unit.
- Be sure to connect the AV amp between this unit and the DIGA recorder.

■ Setting this unit after connections

After making connections as shown above, set “EZ Sync” (under “EZ Sync setting”) first to “Off” and then “On” using the Setup Menu. (p. 52-53)

Notes

- Individual HDMI equipment may require additional menu settings specific to each model. Please refer to their respective operating instruction manuals.
- When audio from other equipment connected to this unit via HDMI is output using “DIGITAL AUDIO OUT” of this unit, the system switches to 2CH audio. (p. 52-53)
(When connecting to an AV amp via HDMI, you can enjoy higher sound quality.)

HDMI connection

HDMI (high-definition multimedia interface) allows you to enjoy high-definition digital images and high-quality sound by connecting this Projection Display and the devices.

HDMI-compatible equipment (*1) with an HDMI or DVI output terminal, such as a Set Top Box or a DVD player, can be connected to the HDMI connector using an HDMI compliant (fully wired) cable.

- HDMI is the world's first complete digital consumer AV interface complying with a non-compression standard.
- If the external equipment has only a DVI output, connect to the HDMI terminal via a DVI to HDMI adapter cable (*2).
- When the DVI to HDMI adapter cable is used, connect the audio cable to the audio input terminal.
- Audio settings can be made on the "HDMI 1 in", "HDMI 2 in" or "HDMI 3 in" menu screen. (p. 39)
Applicable audio signal sampling frequencies (L.PCM): 48 kHz, 44.1 kHz, 32 kHz

(*1): The HDMI logo is displayed on an HDMI-compliant device.

(*2): Enquire at your local digital equipment retailer shop.

Notes

- Use with a PC is not assumed.
- All signals are reformatted before being displayed on the screen.
- If the connected device has an aspect adjustment function, set the aspect ratio to "16:9".
- This HDMI connector is "type A".
- These HDMI connectors are compatible with HDCP (High-Bandwidth Digital Content Protection) copyright protection.
- A device having no digital output terminal may be connected to the input terminal of either "COMPONENT", "S VIDEO", or "VIDEO" to receive analog signals.
- The HDMI input terminal can be used with only the following image signals: 480i, 480p, 720p, 1080i and 1080p. Match the output setting of the digital device.
- For details of the applicable HDMI signals, see below.

About HDMI

HDMI is the first all digital consumer electronics A/V interface that supports several uncompressed standards, enhanced and high-definition video formats as well as all existing multichannel audio formats. One jack supports both video and audio information. The HDMI/HDCP*1 input can be connected to an EIA/CEA 861/861D*2 compliant consumer electronic device, such as a Set Top Box or DVD player equipped with a HDMI output connection. By inputting a High-bandwidth Digital Content Protection (HDCP) high-definition picture source to the HDMI terminal of this unit, high-definition pictures can be displayed on the screen in their digital form. The HDMI input terminal is not intended to be used with personal computers. This unit is compatible with 1080p, 1080i, 720p, 480p and 480i formats. Select the output of the connected device to match that of the unit.

*1 HDMI/HDCP = High-Definition Multimedia Interface / High-Bandwidth Digital Copy Protection.

*2 EIA/CEA-861/861D Profiles compliance covers profiles for transmission of uncompressed digital video including high bandwidth digital content protection.

Input signals that can be displayed

*Mark : Applicable input signal for Component (Y, P_B, P_R) and HDMI

	Horizontal frequency (kHz)	Vertical frequency (Hz)	COMPONENT	HDMI
480i	15.75/15.73	60/59.94	*	*
480p	31.50/31.47	60/59.94	*	*
720p	45.00/44.96	60/59.94	*	*
1080i	33.75/33.72	60/59.94	*	*
1080p	67.50/67.43	60/59.94		*

Notes

- Signals other than those shown above may not be displayed properly.
- The above signals are reformatted for optimal viewing on your display.

Power ON / OFF

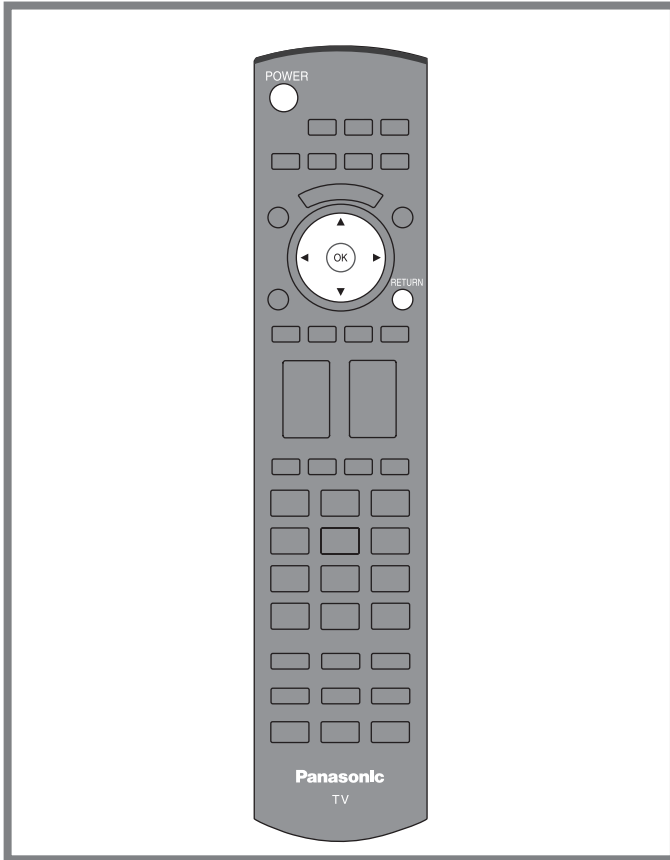

Turning the Power ON and OFF

Always be sure to follow the procedure given below to turn the Projection Display power ON and OFF.

- The lamp cooling fan will continue to operate for approximately 3 minutes after the power is turned off. During this time, the POWER indicator will blink Red.

Do not disconnect the power cord from the outlet and do not open the circuit breaker (unless necessary) while the cooling fan is still operating. Do not disconnect the power cord from the power outlet while the power indicator blinks Red.

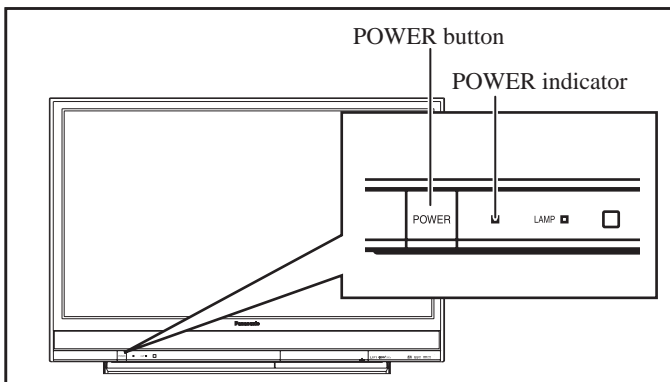

The Power Indicator

LED	ACTION
Off	Power – OFF
Red (blinking)	Power – OFF (Now cooling)
Green	Power – ON
Green (blinking)	Power – ON (Preparing to light lamp)

Notes

- If the POWER button is accidentally turned off during use, after power is turned back on, it may take a short period before the lamp automatically comes on.
- This unit consumes approx. 0.4 W in OFF condition when plugged into an AC outlet.

Power ON

Press POWER on Projection Display or Remote Control to turn power on.

- The Power Indicator blinks Green for about 10 seconds and then turns solid Green.
- Picture display may be delayed when the unit has not been used for a long time or ambient temperature is low.
- The fan rotating sound may be increased in high temperature condition.

Power OFF

Press POWER on Projection Display or Remote Control to turn power off.

- Power shuts off after a Black Screen is displayed for about 3 minutes. If the POWER button is pressed during the Black Screen display, Power is turned back on.
- The Power Indicator blinks Red for about 3 minutes and then LED turns off.

Auto shut off

- If “No signal shut-off” has been selected “Set”, the TV will automatically turn off if NO SIGNAL is present for more than 10 minutes. (p. 54-55)
- If “No action shut-off” has been selected “Set”, the TV will automatically turn off if no key has been pressed for more than 3 hours. (p. 54-55)

First Time Setup

For your convenience, First Time Setup menu will be displayed on screen when the set is turned on for the first time. If needed, follow the menus and procedures displayed on-screen for setting up the features.

Language

The language of the on-screen display is set to English as the factory setting. You can select English, Spanish or French as the on-screen display language.

Procedure

1. Press ▲▼ to select “Language”.
2. Press OK to display the Language menu.

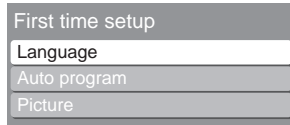

3. Press ◀▶ to select “English,” “Español” or “Français”.
4. Press RETURN to go to previous screen.



Auto program

You can scan All (Analog and Digital) channels. If needed, follow the menus and procedures displayed on-screen for setting up the features. You can also make the settings in Setup menu.

Procedure

1. Press ▲▼ to select “Auto program”.
2. Press OK to display the Program channel menu.

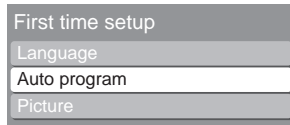

3. Press ▲▼ to select “ANT in”.
4. Press ◀▶ to select “Cable” or “Antenna”.



5. Press ▲▼ to select “Auto”.
6. Press OK to display the Auto program menu.



7. Press ▲▼ to select “All channels”, “Analog only”, or “Digital only”.
8. Press OK to start scan.
 - Channels available for reception will be set automatically.

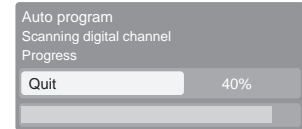
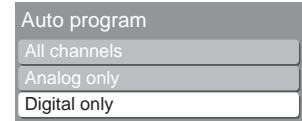

9. After Auto program is complete, the unit will return to Manual program mode. To place the channels that were located by auto scan in memory, move the cursor to “Apply” and press OK. (p. 27-28)
If OK is not pressed after selecting APPLY, the channels will not be memorized.

10. Press ▲▼ to select “Picture”.
11. Press OK to display the Picture menu. (p. 35)

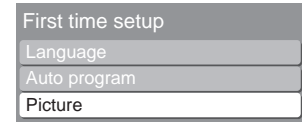

Notes

- After “Auto program” is completed the unit tunes to the first channel found during “Auto program”.
- If setup is incomplete, check connection of Antenna/Cable to the RF IN Terminal, then try “Auto program” again. (p. 26-27)
- “Auto program” must be done when you select the input signal for the first time or whenever you change the antenna configuration.
- Depending on conditions, “Auto program” may take a while.

Tuning channels

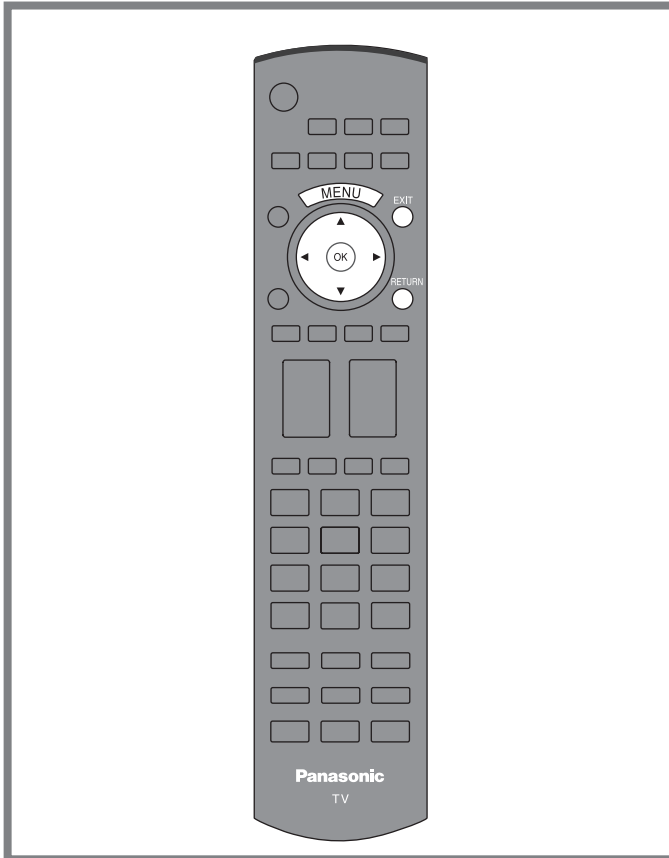

Switching languages for display

Allows you to select the language used for On-Screen Displays.

Procedure

1. Press MENU to display the Main Menu screen.
2. Press ▲▼ to select “Setup” icon.
3. Press OK to display the Setup menu.

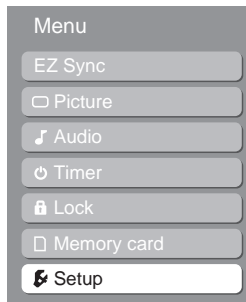

4. Press ▲▼ to select “Language”.

5. Press OK to display the Language menu.

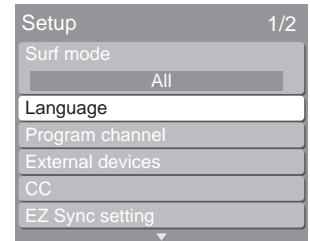

6. Press ◀▶ to select “English,” “Español” or “Français”.



7. Press RETURN to go to previous screen.

Automatic program setting

Automatically searches and adds receivable channels to memory.

Procedure

1. Press MENU to display the Main Menu screen.
2. Press ▲▼ to select “Setup” icon.
3. Press OK to display the Setup menu.

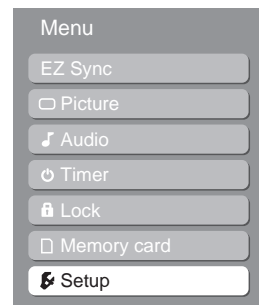

4. Press ▲▼ to select “Program channel”.
5. Press OK to display the Program channel menu.

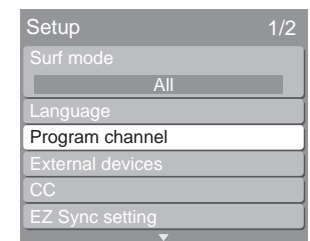

6. Press ▲▼ to select “ANT in”.
7. Press ◀▶ to select “Antenna” or “Cable”.

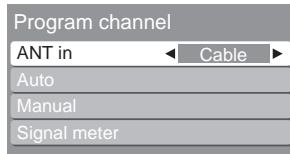

8. Press ▲▼ to select “Auto”.
9. Press OK to display the Auto program menu.

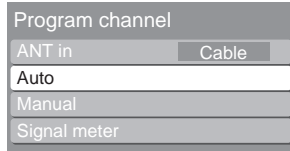

10. Press ▲▼ to select “All channels”, “Analog only”, or “Digital only”.
11. Press OK to start scan.

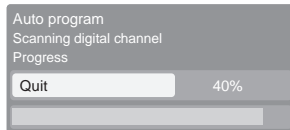
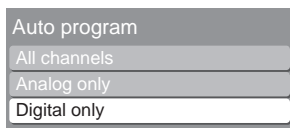

12. After Auto program is complete, the unit will return to Manual program mode. To place the channels that were located by auto scan in memory, move the cursor to “Apply” and press OK. (p. 27-28)
If OK is not pressed after selecting APPLY, the channels will not be memorized.

Notes

- Some channels with very weak signals may be locked into memory. If desired, these channels can be deleted manually using the “Manual program setting”. (p. 27-28)
- “Auto program” must be done when you select the input signal for the first time or whenever you change the antenna configuration.

Manual program setting

Use this procedure when changing setting of receiving channels or changing the channel display. Also, use to add or delete channels from channel list manually.

Procedure

1. Press MENU to display the Main Menu screen.
2. Press ▲▼ to select “Setup” icon.
3. Press OK to display the Setup menu.

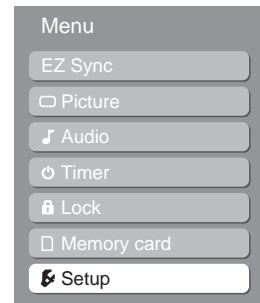

4. Press ▲▼ to select “Program channel”.
5. Press OK to display the Program channel menu.

- If Lock (p. 41) has been set, you must enter your password to display the Program channel menu.

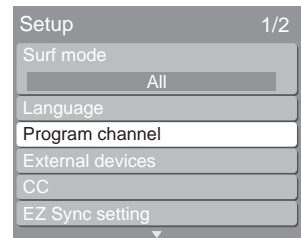

6. Press ▲▼ to select “Manual”.
7. Press OK to enter the Manual program screen.

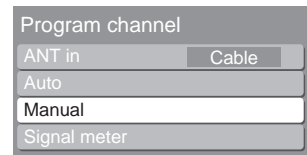

Tuning channels (continued)

8. Press ◀▶ to select “Edit”.
9. Press OK to enter the edit mode.

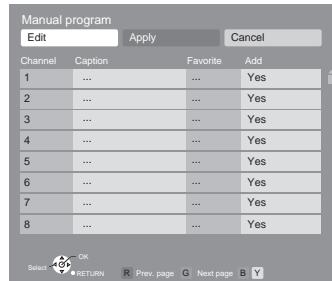

10. Press ▲▼ to select the desired preset channel line.
11. Press ◀▶ to select edit area (“Channel,” “Caption,” “Favorite,” “Add”).

■ Edit (Caption)

When a preset Caption has been entered.

1. Press OK to display the Caption select menu.
2. Press ▲▼ to select “Caption”.
3. Press ◀▶ to select Broadcast station.

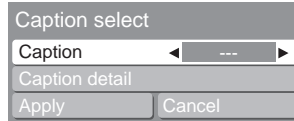

4. Press ▲▼ to select “Apply”.
5. Press OK to enter the Caption.

When selecting a desired Caption manually.

1. Press OK to display the Caption select menu.
2. Press ▲▼ to select “Caption detail”.
3. Press OK to display the Caption detail menu.
4. Press ▲▼ to select “Caption”.
5. Press OK to enter input field.

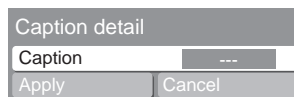

6. Press ▲▼ to select the character to input/change.
7. Press ◀▶ to move to the character to input/change.
8. Press OK to enter your selection.
9. Press ▲▼ to select “Apply”.
10. Press OK to enter the Caption.

■ Edit (Favorite)

1. Press OK to display the Set favorite menu. (p. 31)

■ Edit (Add)

Setting of register/delete in Program channel.

1. Press OK to select “Yes” or “No”.

12. Press RETURN to move cursor to “Apply”.

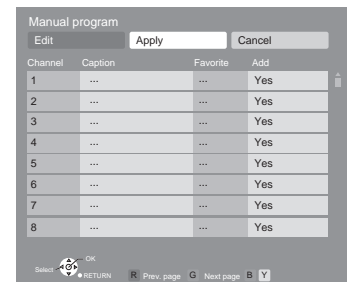

13. Press OK to enter your program.

Projection Display Operation

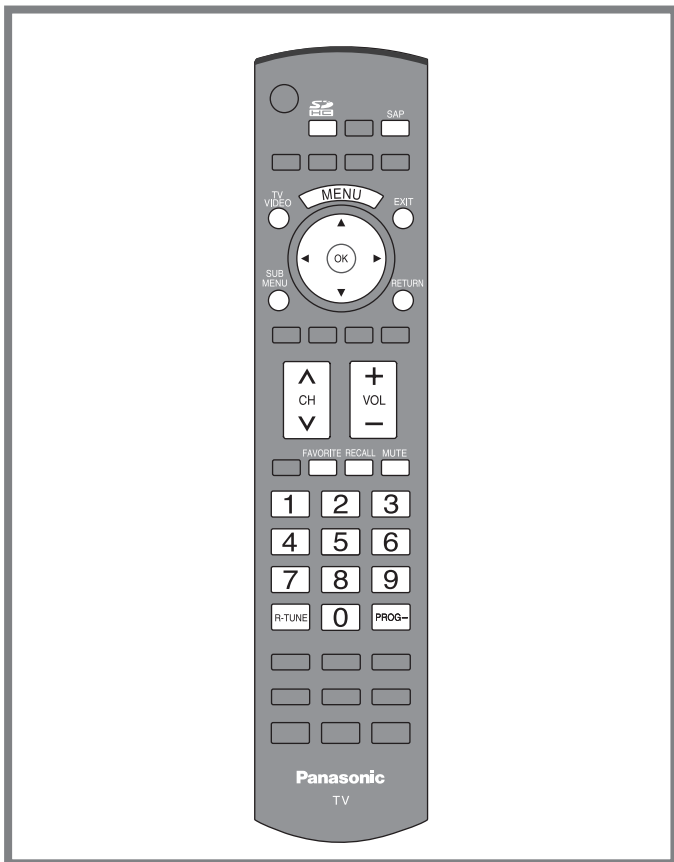

Selecting Input Mode

Procedure

1. Press TV/VIDEO to display the Input select menu.
2. Press corresponding NUMBER keys to select the input of your choice. Or, press ▲▼ to select the input of your choice, then press OK.

- If, during selection, no action is taken for several seconds, the Input selection menu is exited and the current input is automatically selected.

Input select	
1	TV
2	Component 1
3	Component 2
4	HDMI 1
5	HDMI 2
6	HDMI 3
7	Video 1
8	Video 2
9	Video 3
0	PC

Component 1	Signal of source connected to COMPONENT VIDEO INPUT 1 is displayed.
Component 2	Signal of source connected to COMPONENT VIDEO INPUT 2 is displayed.
HDMI 1	Signal of source connected to HDMI IN 1 is displayed.
HDMI 2	Signal of source connected to HDMI IN 2 is displayed.
HDMI 3	Signal of source connected to HDMI IN 3 is displayed.
Video 1	Signal of source connected to VIDEO INPUT 1 is displayed. Signal of source connected to S VIDEO INPUT is displayed.
Video 2	Signal of source connected to VIDEO INPUT 2 is displayed.
Video 3	Signal of source connected to VIDEO INPUT 3 is displayed.
PC	Signal of source connected to PC IN is displayed.

Note

- If SKIP is set as the Input Label setting, the mode will not be changed. (p. 50)

■ Card input mode (Photo viewer) is selected.

Procedure

1. Press SD to display Photo viewer mode.

Photo (Photo viewer)	Signal of source connected to CARD SLOT is displayed.
-----------------------------	---

Rapid Tuning

Switches between the current and last channel or input modes.

Procedure

1. Press R-TUNE to switch to previously viewed channel or input modes.

Note

- When Photo viewer (p. 46) is used, Rapid Tuning is not available.

Using the CH/VOL Button

■ Select desired channel:

Press CH ▲▼ or NUMBER keys.

■ Adjust to desired volume level:

Press VOL+ or VOL-.

Notes

- The channel number and volume level are stored even after the unit is turned off.
- Power consumption can be reduced if the volume level is lowered.

Projection Display operation (continued)

Channel and Program Tuning

Channel and Program tuning in digital television differs from conventional television. With DTV, many programs can exist within a single 6 MHz channel. These channels behave as sub-channels within a single channel. When tuning to a digital channel, the unit will also tune to a program and will indicate the channel and program in the on-screen Channel Banner display.

In order to select channels properly, Auto program must be performed. (p. 26-27)

Follow the procedure below to directly enter the channel number using the NUMBER keys.

Select analog channel

Procedure

1. Press the NUMBER keys to enter the Channel number. Press OK.

- The following is an example of tuning to channel 15.

Direct Tuning Example

Step	Action	Channel Banner Display
1	Press 1	1
2	Press 5	15
3	Press OK	15

Note

- If, during channel selection, no action is taken for several seconds, the Channel Banner is exited and the currently input channel is automatically selected.

Select digital channel

Procedure

1. If tuning a digital channel and your channel contains more than one program, press PROG- and enter the program (1, 2, 3 etc.) using the NUMBER keys. Press OK.

- The following is an example of tuning to channel 15-1.

Direct Tuning Example

Step	Action	Channel Banner Display
1	Press 1	1
2	Press 5	15
3	Press PROG-	15-
4	Press 1	15-1
5	Press OK	15-1

Note

- If, during channel selection, no action is taken for several seconds, the Channel Banner is exited and the currently input channel is automatically selected.

Unit Status Display

Press CH Δ V or RECALL, except when the MENU screen is displayed, to display current unit status information.

Channel Banner: Minimized

Procedure

1. Press CH Δ V to minimize the displayed channel banner.

- It will display the channel number, and the station identification (if available).

Channel Number

15-2
ABC-HD

Station Identifier

Channel Banner: Maximized

Procedure

1. Press RECALL to maximize the displayed channel banner.

Channel, Program and Station identifier

Program title

15-2	Andrew's cooking show						
ABC-HD	CC SAP	TV-G	1080i	Standard	4:3	⊕ 30	
Closed Caption	SAP indication	Rating Level	Signal resolution	Picture mode	Aspect ratio	Time remaining in Sleep Timer	

Audio Mute

Press MUTE to instantly mute the sound. Press again to restore the previous sound level.

Procedure

1. Press MUTE to mute the sound. Press again to reactivate sound.

- Sound is also reactivated when power is turned off or volume level is changed.

Note

- The audio output from AV OUT is not muted.

Display the SUB MENU

This menu consists of shortcuts to convenient functions.

Procedure

1. Press SUB MENU to display the Setup SUB MENU.

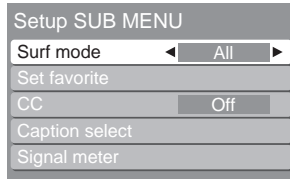

Favorite Feature

This feature lets you add channels to or delete channels from the Favorite channel list.

Set Favorite Feature

Procedure

1. Display the channel to be placed on the Favorites list.
2. Press SUB MENU to display the Setup SUB MENU.

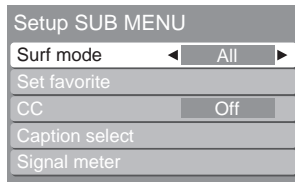

3. Press ▲▼ to select "Set favorite".
4. Press OK to display the Set favorite menu.

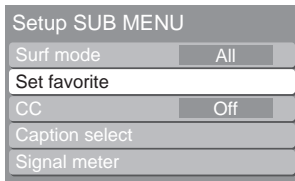

5. Press FAVORITE repeatedly to change between pages (1/3, 2/3, 3/3, or exit). Pressing ◀▶ also changes the page.



6. Press ▲▼ to highlight a position on the list. Then, press OK to save the displayed channel in that position.

- You can also use the NUMBER keys (1-9 and 0) to select a list number (1-9 and 0). By doing so, the displayed channel will be saved on that list number without pressing OK.



■ To delete a favorite channel

A saved channel can be removed from the list by holding down OK while its position is highlighted or by pressing the NUMBER keys.

Projection Display operation (continued)

Use Favorite Feature

Procedure

1. Press FAVORITE.

- Press FAVORITE repeatedly to change between pages (1/3, 2/3, 3/3, or exit). Pressing ◀▶ also changes the page.

Favorite channels		1/3
1	---	
2	---	
3	---	
4	---	
5	---	
6	---	
7	---	
8	---	
9	---	
0	---	

2. Press ▲▼ or a NUMBER keys (1-9 and 0) to highlight a channel on the list.

- Selecting a channel number from the list with the NUMBER keys will display the channel directly.

3. Press OK to display the highlighted channel.

Select Audio Mode for TV Viewing

Digital mode

Procedure

1. Press SAP to select the next audio track (if available) when receiving a digital channel.

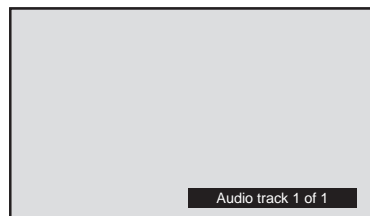

Analog mode

Procedure

1. Press SAP button to select the desired audio mode as described below. (Arrow shows selection.)

- Each press of SAP button will change the audio mode as shown below.

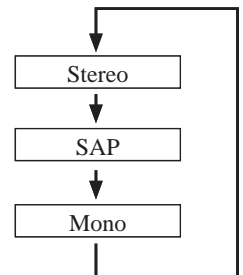

■ Receivable Broadcast Types

The following are possible broadcast types with their accompanying on-screen displays. The signal being received is indicated with a red text while the selected audio mode is a yellow background.

MTS Stereo and SAP broadcast

Multi-channel Television Sound Stereo (main language) and Secondary Audio Program (sub language) broadcasts are both being received simultaneously. Select the Stereo or SAP audio mode.

MTS Stereo broadcast

Multi-channel Television Sound Stereo broadcast. Select Stereo audio mode.

- If stereo broadcast is weak and the display flickers, select Mono audio mode for possibly better results.

SAP broadcast

Secondary Audio Program (sub language.) Select SAP audio mode for the sub language.

Mono broadcast

Normal monaural sound broadcast.

ASPECT Controls

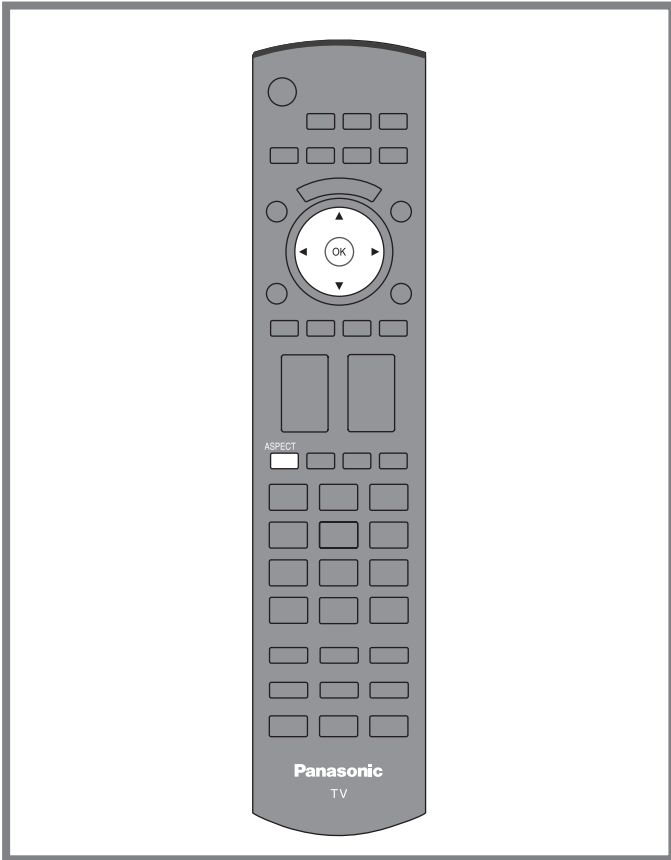

Changing the Aspect Mode

Lets you choose the aspect mode based on the format of the received signal and your preference.

Procedure

- The aspect mode changes each time ASPECT is pressed.

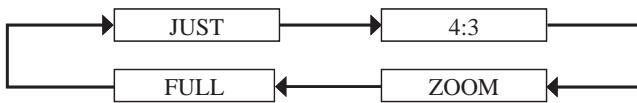

- When an HD signal (1080p/1080i/720p) is received, the mode switches between FULL, H-FILL, JUST, and ZOOM.

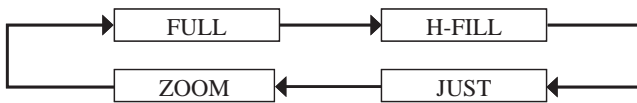

- During PC input, the mode switches between 4:3 and FULL only.

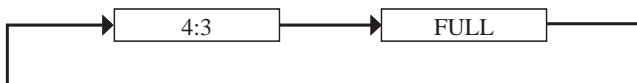

Notes

- When input mode is CARD, the aspect is set to 4:3 and cannot be changed.
- If the mode selected does not match the aspect ratio of the input signal, the original picture quality may be affected.
- If using this Projection Display in places, such as cafes or hotels, with the aim of displaying programs for a commercial purpose or for public presentation, please note that by using the aspect ratio (16:9) selection function to change the aspect ratio, you may be infringing on the rights of the original copyright owner of that program under copyright protection laws.
- If a 4:3 picture is projected in wide screen, distortion may occur around the edges so that part of the picture may no longer be visible. We recommend viewing in 4:3 mode so you can enjoy the picture as it was intended to be seen.

Mode	Picture	Explanation
JUST		JUST mode will display a 4:3 picture at maximum size, but with aspect correction applied to the center of the screen so that elongation is only apparent at the left and right edges of the screen. The size of the picture will depend on the original signal.
4:3		4:3 mode displays a 4:3 picture at the standard 4:3 size.
ZOOM		ZOOM mode magnifies the central section of the picture.
FULL		FULL mode displays the picture at maximum size, but with a slightly elongated appearance.
H-FILL		H-FILL mode enlarges a 4:3 image horizontally to the sides of the screen. The side edges of the image are cut off.

EZ Sync™ Feature

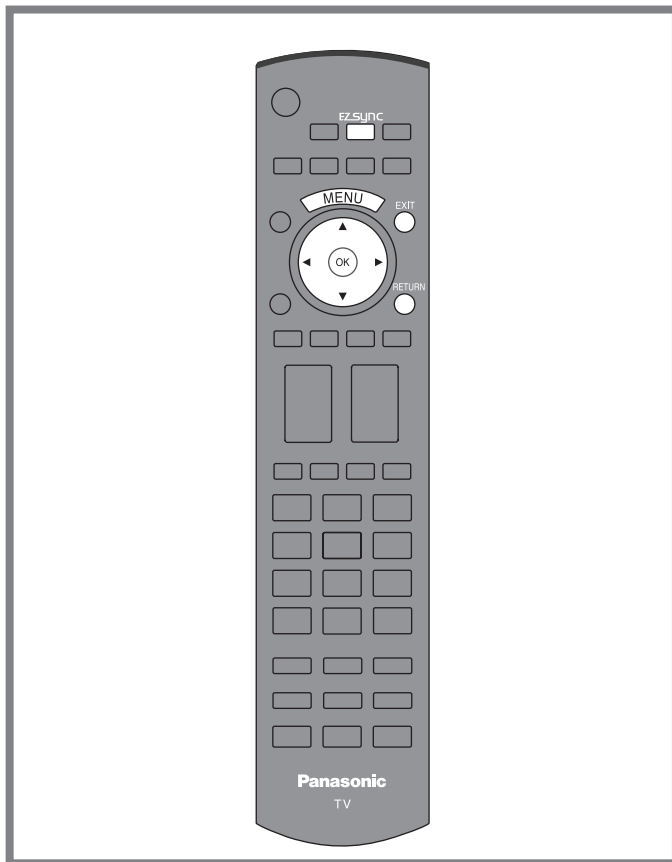

EZ Sync™

If you connect equipment that has the “HDAVI Control 2” function to the TV with HDMI cable, you can enjoy using this convenient function. For details, “EZ Sync Control” on pages 22 and 52-54.

Procedure

1. Press ▲▼ to select the equipment.

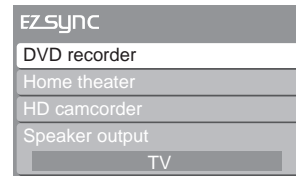

2. Press OK to operate the selected equipment with this Projection Display's Remote Control.

- Follow the menu of the equipment and enjoy watching.
- For the remote control operations, refer to page 54.

■ Return to TV screen

Press EXIT.

Note

- For details, see the equipment manual or ask your local dealer.

Press MENU to display the Main Menu screen.

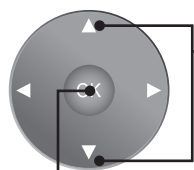

Press to select “EZ Sync”.

Press to display the EZ Sync menu.

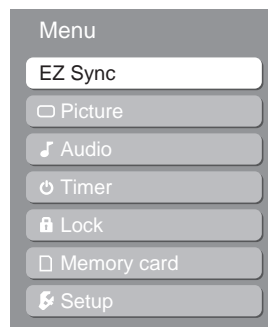

- **The EZ Sync may be set using the EZ Sync button.**
- While Main Menu (only) is displayed, pressing MENU will exit the menu screen.
- **Return to previous level menu.**
Press RETURN to return to previous level menu.
- **Return to normal picture.**
Press EXIT to exit menu.

Picture Adjustments

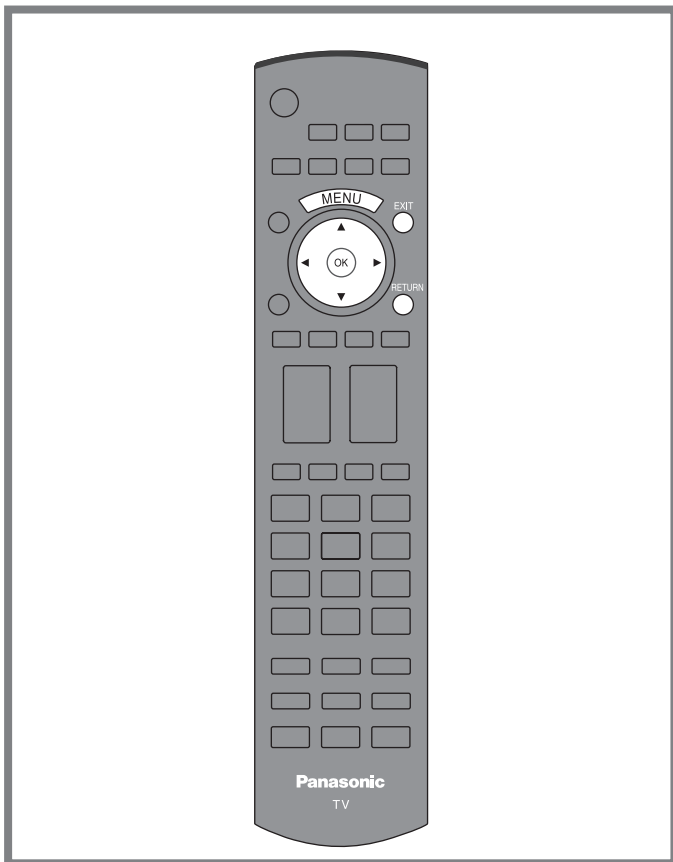

Normal / Lamp / Picture / Brightness / Color / Tint / Sharpness / Color mgmt. / AI picture

Procedure

1. Press ▲▼ to select each item.
2. Press ◀▶ to adjust each item.

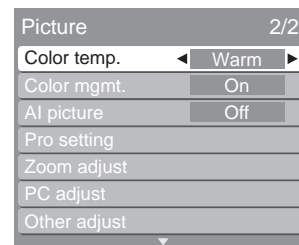
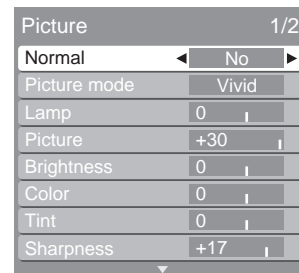

Press MENU to display the Main Menu screen.

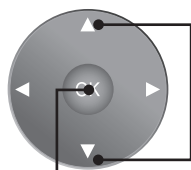

Press to select "Picture" icon.

Press to display the Picture menu.

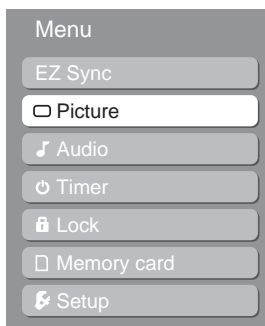

- While Main Menu (only) is displayed, pressing MENU will exit the menu screen.
- **Return to previous level menu.**
Press RETURN to return to previous level menu.
- **Return to normal picture.**
Press EXIT to exit menu.

Item	Explanations
Normal	Resets all picture adjustments to factory default settings.
Lamp	Adjusts luminance of the lamp.
Picture	Adjusts white areas of picture.
Brightness	Adjusts dark areas of picture.
Color	Adjusts desired color intensity.
Tint	Adjusts natural flesh tones.
Sharpness	Adjusts clarity of outline detail.
Color temp. (Color temperature)	To increase or decrease Warm (red) and Cool (blue) colors to suit personal preferences.
Color mgmt. (Color management)	Enhances green and blue color reproduction, especially outdoor scenes.
AI picture	Controls dark areas without affecting the black level or brightness in the overall picture.

Picture Adjustments (continued)

Picture Mode

Lets you choose one of four preset Picture Modes that best suits the program that you are viewing. Selecting this feature will also affect Color Temperature setting.

Procedure

1. Press ▲▼ to select “Picture mode”.
2. Press ◀▶ to select picture mode.

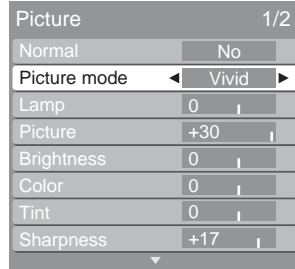

- Vivid (default) - Provides enhanced picture contrast and sharpness for viewing in a well-lit room.
- Standard - Recommended for normal viewing conditions with subdued room lighting.
- Cinema - For watching movies in a darkened room. It provides a soft, film-like picture.
- Custom (Photo) - Customizes each item according to your taste.
Photo is displayed in JPEG menu.

Pro Setting

Highly-detailed adjustments can be made.

Procedure

1. Press ▲▼ to select “Picture mode”.
2. Press ◀▶ to select “Custom”.

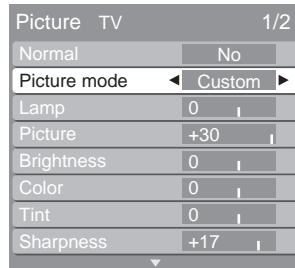

3. Press ▲▼ to select “Pro setting”.
4. Press OK to display the Pro setting menu.

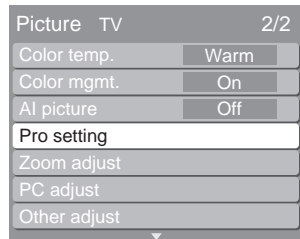

5. Press ▲▼ to select each item.
6. Press ◀▶ to adjust each item.



Item	Explanations
Normal	Resets all picture adjustments to factory default settings.
AI brightness	The median brightness level of the picture can be set.
Black extension	You can adjust the gray level of black for areas of the screen that are darker than the median level.
W/B high R	Adjusts the W/B high R (red).
W/B high B	Adjusts the W/B high B (blue).
W/B low R	Adjusts the W/B low R (red).
W/B low B	Adjusts the W/B low B (blue).

Zoom Adjust

Adjust the vertical image position and size. It works when Aspect mode is Zoom.

Procedure

1. Press ▲▼ to select “Zoom adjust”.
2. Press OK to display the Zoom adjust menu.

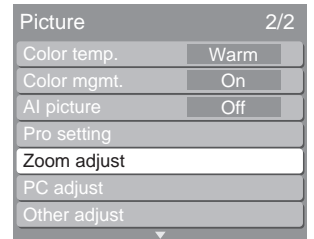

3. Press ▲▼ to adjust the vertical position.
4. Press ◀▶ to adjust the vertical size.

Note

- Press OK to reset the aspect ratio.

Depending on the signal being input, some menu items may or may not be adjustable and some functions may or may not be available.

PC Adjust

You can adjust the picture when "Input select" is selected to "PC". (p. 29)

Procedure

1. Press ▲▼ to select "PC adjust".
2. Press OK to display the PC adjust menu.

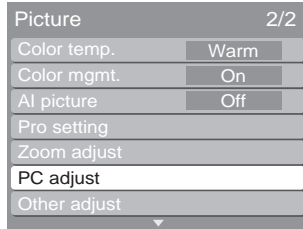

3. Press ▲▼ to select each item.
4. Press ◀▶ to adjust each item.

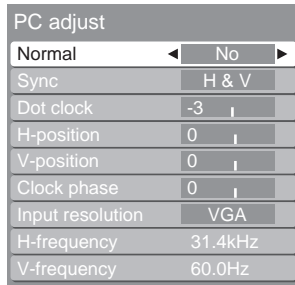

Item	Explanations
Normal	Resets all picture adjustments to factory default settings.
Sync	<ul style="list-style-type: none"> • H&V : The H and V sync signals are input from the HD/VD connector. • On G : Uses a synchronized signal on the Video G signal, which is input from the G connector.
Dot clock	Adjusts horizontal size.
H-Position	Adjusts horizontal position.
V-Position	Adjusts vertical position
Clock phase	Adjusts in order to remove any picture interference or contour blurring which may occur in computer images.
Input resolution	Switches to wide display. Input signal switched from XGA to WXGA and from VGA to WVGA.
H-Frequency/ V-Frequency	Displays the frequencies of the PC signal currently being adjusted. Displays the H (Horizontal) / V (Vertical) frequencies. Display range: Horizontal 15-110 kHz Vertical 48 - 120 Hz

Note

- This function is available only when the signal being viewed is from a PC.

Other Adjust

Other detailed picture adjustments can be made. This function is not available when "Input select" is selected to "PC". (p. 29)

Procedure

1. Press ▲▼ to select "Other adjust".
2. Press OK to display the Other adjust menu.

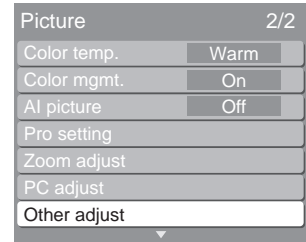

3. Press ▲▼ to select each item.
4. Press ◀▶ to adjust each item.

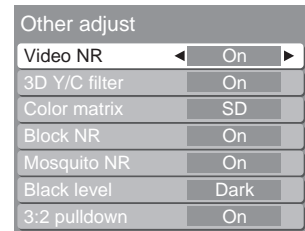

Item	Explanations
Video NR	Reduces noise, commonly called snow. Leave off when receiving a strong signal.
3D Y/C filter	Minimizes noise and cross-color in the picture.
Color matrix	<p>Select SD or HD.</p> <ul style="list-style-type: none"> • SD : Color matrix is set same as a normal TV system (NTSC). • HD : Color matrix is set same as a High-Definition system (ATSC). <p>With a 480p signal from equipment connected to COMPONENT VIDEO INPUT (Y, PB, PR) or HDMI INPUT terminals or from the unit's DTV tuner, you can select SD or HD color matrix to display the most natural color.</p> <p>Notes</p> <ul style="list-style-type: none"> • This feature is available only with 480p signals. • The default setting with HDTV signals (720p, 1080i or 1080p) is HD color matrix. • The default setting with NTSC signals (480i) is SD color matrix.
Block NR	Reduces noise of specific digital signals of DVD, STB, etc.
Mosquito NR	Reduces HDTV flicker noise in the contoured sections of an image.
Black level	Select Light or Dark [Dark : VIDEO, Light : 480i/480p/720p/1080i/1080p] Invalid for Digital channel, Analog channel, PC and Photo viewer.
3:2 pulldown	Transfers film to video.

Audio Adjustments

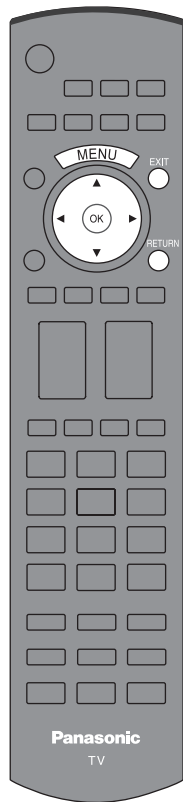

Press MENU to display the Main Menu screen.

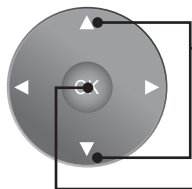

Press to select "Audio" icon.

Press to display the Audio menu.

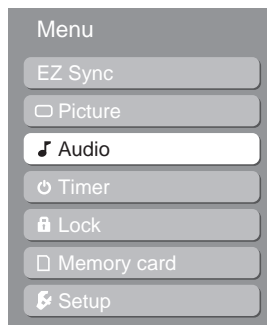

• While Main Menu (only) is displayed, pressing MENU will exit the menu screen.

■ **Return to previous level menu.**

Press RETURN to return to previous level menu.

■ **Return to normal picture.**

Press EXIT to exit menu.

Normal / Bass / Treble / Balance

Procedure

1. Press ▲▼ to select each item.
2. Press ◀▶ to adjust each item.

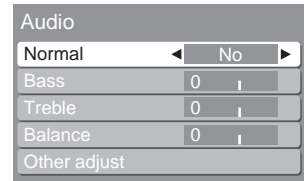

Item	Explanations
Normal	Reset Bass, Treble and Balance adjustments to factory default settings.
Bass	Increase or decrease the bass response.
Treble	Increase or decrease the treble response.
Balance	Emphasize the left / right speaker volume.

Other Adjust

Other detailed audio adjustments can be made.

Procedure

1. Press ▲▼ to select "Other adjust".
2. Press OK to display the Other adjust menu.

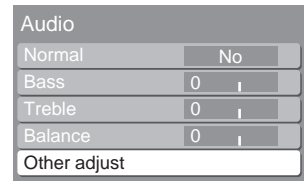

3. Press ▲▼ to select each item.
4. Press ◀▶ to adjust each item.

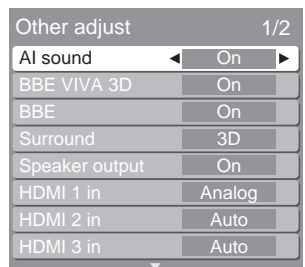

Depending on the signal being input, some menu items may or may not be adjustable and some functions may or may not be available.

Item	Explanations
AI sound	Equalize overall volume levels across all channels.
BBE VIVA 3D	BBE ViVA HD3D (High-Definition 3D) Sound provides musically accurate natural 3D image with Hi-Fi sound. The clarity of the sound is improved by BBE while the width, depth and height of sound image are expanded by BBE's proprietary 3D sound process. BBE ViVA HD3D Sound is compatible with all TV programs including news, music, dramas, movies, sports and electronic games.
BBE	BBE High-Definition Sound restores clarity and presence for better speech intelligibility and musical realism. <ul style="list-style-type: none"> • "BBE" is not available when "BBE VIVA 3D" is set to "On".
Surround	Enhances audio response when listening to stereo. <ul style="list-style-type: none"> • "Surround" is not available when "BBE VIVA 3D" is set to "On".
Speaker output	Switches to "Off" when using external speakers. <ul style="list-style-type: none"> • "AI sound", "Surround" and "Audio leveler" do not work if "Off" is selected.
HDMI 1 in/ HDMI 2 in/ HDMI 3 in	Perform input switching of analog audio input and digital audio input when using the HDMI terminal. <p>Auto : Automatically performs digital/analog input switching according to the input signal type.</p> <p>Digital : Forces use of digital audio input signal transmitted via the HDMI terminal.</p> <p>Analog : Forces use of analog audio input signal transmitted via separate RCA terminals.</p> <ul style="list-style-type: none"> • This item can be selected when viewing a signal from a HDMI.
Audio leveler	The audio leveler monitors the difference in audio levels between input signals from external equipment and minimizes the change in output volume that could occur when switching input signals.

Notes

- "BBE VIVA 3D", "BBE", and "Audio leveler" do not work when "Speaker output" is set to "Off".
- Sound signals are output from the rear AUDIO OUT and DIGITAL AUDIO OUT terminal. (p. 21)
- When volume is adjusted or the MUTE button is pressed from the Remote Control, a message will be displayed.

Sleep Timer Feature

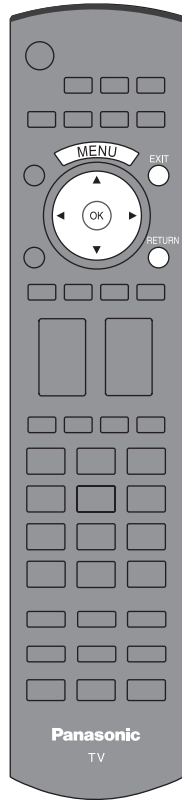

Set Sleep Timer

Press to set unit to shut itself off after a preselected amount of time.

Procedure

1. Press ◀▶ to select "0," "30," "60," or "90".



Notes

- Pressing the RECALL button with sleep timer set displays remaining time.
- The on-screen display will flash 3, 2 and 1 to indicate the last three (3) remaining minutes prior to turn off.

Press MENU to display the Main Menu screen.

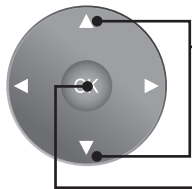

Press to select "Timer" icon.

Press to display the Timer menu.

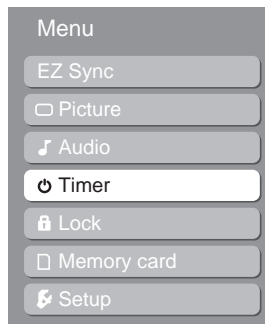

- While Main Menu (only) is displayed, pressing MENU will exit the menu screen.

■ **Return to previous level menu.**

Press RETURN to return to previous level menu.

■ **Return to normal picture.**

Press EXIT to exit menu.

Lock Feature

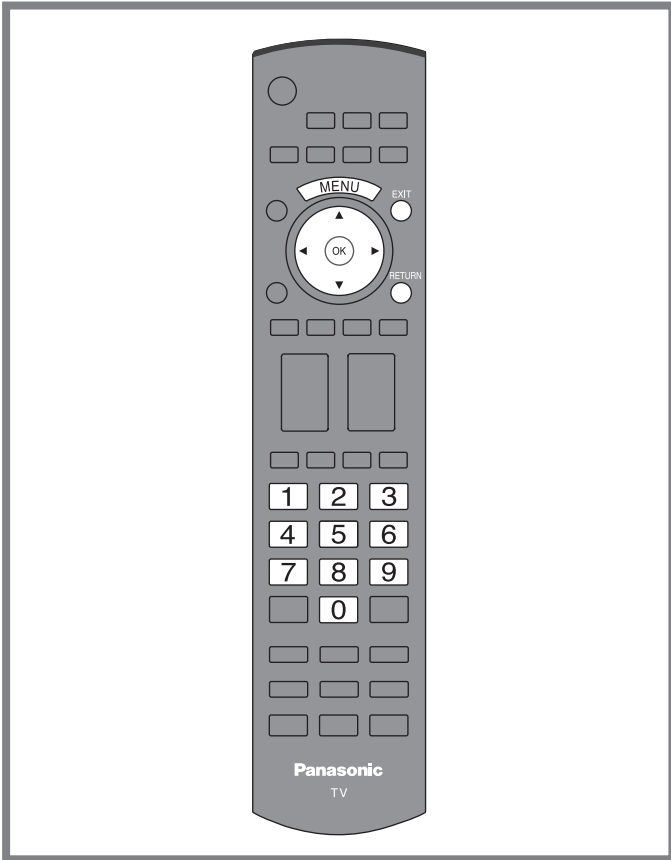

This Projection Display incorporates V-CHIP technology to block the viewing of movies and television programs according to the rating category. There are four (4) Content Advisory Categories: MPAA (Motion Picture Association of America), TV Parental Guidelines Ratings, Canadian English Language Ratings and Canadian French Language Ratings. These categories are used as guidelines for blocking the programs. The default mode for the Lock category is the Unlocked state. In this state, you can surf the various categories of the Lock menu. After you have created a password, you are prompted to enter it before you can make any changes in the Lock menu.

- This Projection Display is designed to support the “Downloadable U.S. Region Rating System” when available. (Available only in U.S.A.)

Enter Password

A 4-digit password must be entered to view a blocked program or change rating settings.

■ Create Password

Procedure

1. Press NUMBER keys to enter your password.

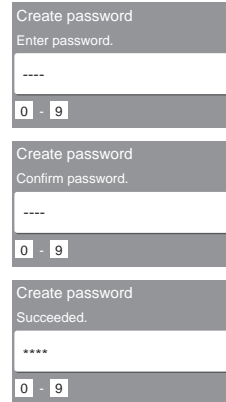

2. Upon entering the 4 digit password, the Lock menu is displayed.

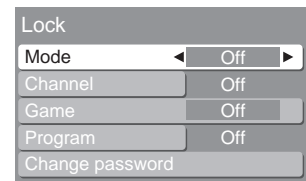

Press MENU to display the Main Menu screen.

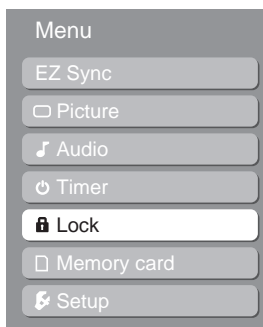
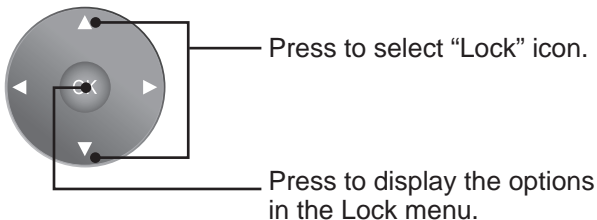

- You will be asked to enter your password each time you display the Lock menu.
- While Main Menu (only) is displayed, pressing MENU will exit the menu screen.
- **Return to previous level menu.**
Press RETURN to return to previous level menu.
- **Return to normal picture.**
Press EXIT to exit menu.

Note

- Use a password that is easy to remember and record it in a safe place.

Lock Feature (continued)

■ Enter Password

Procedure

1. Press NUMBER keys to enter your password.

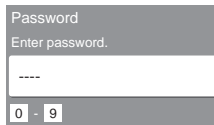

2. Upon entering the 4 digit password, the Lock menu is displayed.

Notes

- Once ratings are set, restricted tapes or programs cannot be accessed unless the secret password is entered.
- **Do not forget your password.** If you have forgotten it, please contact service center.

Lock Set

Select Lock mode to prevent viewing of video games, VCR tapes, channels and Video modes.

Procedure

1. Press ▲▼ to select “Mode”.
2. Press ◀▶ to select the desired setting.

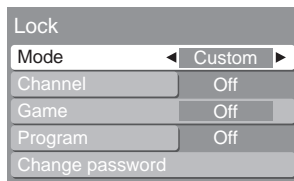

To prevent video games, VCR tapes and all channels and video modes from being viewed. The available modes are:

- Off - Unlocks all the lock settings of “Channel”, “Game” and “Program”.
- All - Locks all the inputs regardless of the lock setting of “Channel”, “Game” and “Program”.
- Custom - Locks specified inputs of “Channel”, “Game” and “Program”.
- “Channel”, “Game” and “Program” will grey out unless “Custom” is selected in “Mode”.

Channel Lock (Block channel selection)

Select up to 7 (1-7) channels to be blocked out. These channels will be blocked out regardless of the program rating.

Procedure

1. Press ▲▼ to select “Channel”.
2. Press OK to display the Channel lock menu.

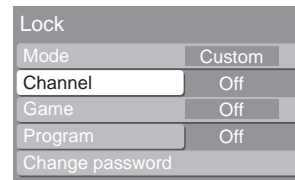

3. Press ▲▼ to select “Mode”.
4. Press ◀▶ to select “Custom”.

- All - Locks all channels.
- Off - Unlocks all channels.

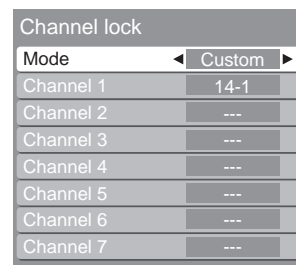

5. Press ▲▼ to select Channel 1 - 7.
6. Press ◀▶ to select the desired Block channel.

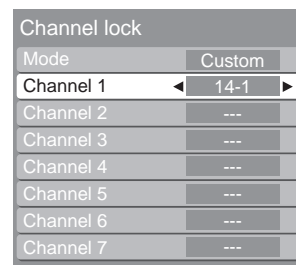

Game Lock

Locks Channel 3, Channel 4 and external inputs.

Procedure

1. Press ▲▼ to select “Game”.
2. Press ◀▶ to select “On” or “Off”.
 - On - Locks
 - Off - Unlocks

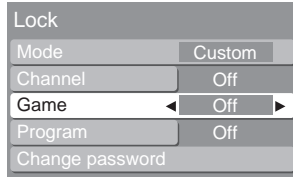

Block program

This television incorporates V-Chip technology to block the viewing of movies and television programs according to the rating category. There are four (4) Content Advisory Categories: MPAA (Motion Picture Association of America), U.S.TV Program, Canadian English ratings and Canadian French ratings. These categories are used as guidelines for blocking programs.

- The default mode for the Lock category is the Unlocked state.

Rating level setting

Procedure

1. Press ▲▼ to select “Program”.
2. Press OK to display the Program lock menu.

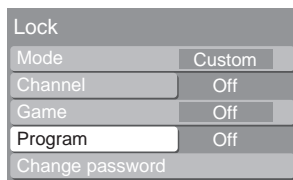

3. Press ▲▼ to select “Mode”.
4. Press ◀▶ to select “On”.

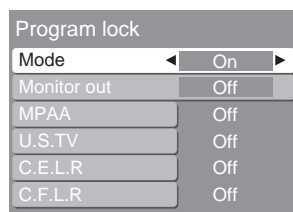

5. Press ▲▼ to select “MPAA”, “U.S.TV”, “C.E.L.R.” or “C.F.L.R.”.

6. Press OK to display the program lock menu.

- MPAA : for U.S movie ratings
- U.S.TV : for U.S TV program ratings
- C.E.L.R. : for Canadian English ratings
- C.F.L.R. : for Canadian French ratings

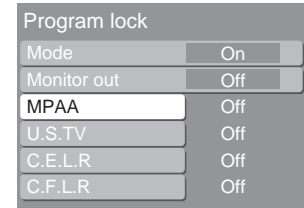

7. Press ▲▼◀▶ to highlight the desired rating level.

Monitor out setting

Procedure

1. Press ▲▼ to select “Program”.
2. Press OK to display the Program lock menu.

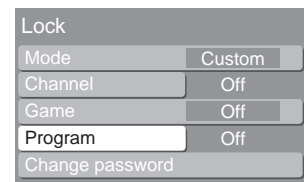

3. Press ▲▼ to select “Monitor out”.
4. Press ◀▶ to select “On” or “Off”.

- On - Turns on the monitor terminal output for programs that have been set to “Blocked.”
- Off - Turns off the monitor terminal output for programs that have been set to “Blocked.”

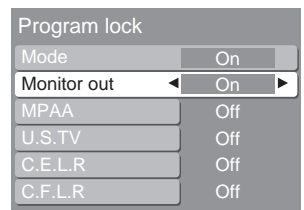

Notes

- The Off rating is independent of other ratings.
- When placing a block on a specific age based rating level, the Off rating and any other more restrictive ratings will also be blocked.

Lock Feature (continued)

U.S. MOVIES RATINGS CHART (MPAA)

Off	NO RATING (NOT RATED) AND NA (NOT APPLICABLE) PROGRAMS. Movie has not been rated or rating does not apply.
G	GENERAL AUDIENCES. All ages admitted.
PG	PARENTAL GUIDANCE SUGGESTED. Some material may not be suitable for children.
PG-13	PARENTS STRONGLY CAUTIONED. Some material may be inappropriate for children under 13.
R	RESTRICTED. Under 17 requires accompanying parent or adult guardian.
NC-17	NO ONE 17 AND UNDER ADMITTED.
X	ADULTS ONLY.

U.S. TV PROGRAMS RATINGS CHART

The TV Parental Guidelines has 7 levels of age-based ratings that can be selected. These 7 levels are split into 2 age-based groups:

Youth Age-based Ratings and Guidance Age-based Ratings. Some of these age-based ratings can also have content-based ratings, denoted as D (Dialog), L (Language), S (Sex) and V (Violence). The table below shows the age-based ratings selection.

Age-based Group	Age-based Ratings	Blocked Content Selections	Description
NR (Not Rated)	TV-NR	<ul style="list-style-type: none"> Viewable Blocked 	Not Rated. See "Customer Caution" on page 45.
Youth	TV-Y	<ul style="list-style-type: none"> Viewable Blocked 	All children. The themes and elements in this program are specifically designed for a very young audience, including children from ages 2-6.
	TV-Y7	<ul style="list-style-type: none"> FV (Fantasy Violence) Viewable Blocked 	Directed to older children. Themes and elements in this program may include mild physical or comedic violence, or may frighten children under the age of 7.

Age-based Group	Age-based Ratings	Blocked Content Selections	Description
Guidance	TV-G	<ul style="list-style-type: none"> Viewable Blocked 	General audience. It contains little or no violence, no strong language, and little or no sexual dialogue or situations.
	TV-PG	<ul style="list-style-type: none"> D,L,S,V (all selected) Any combination of D, L, S, V 	Parental guidance suggested. The program may contain infrequent coarse language, limited violence, some suggestive sexual dialogue and situations.
	TV-14	<ul style="list-style-type: none"> D,L,S,V (all selected) Any combination of D, L, S, V 	Parents strongly cautioned. This program may contain sophisticated themes, sexual content, strong language and more intense violence.
	TV-MA	<ul style="list-style-type: none"> L,S,V (all selected) Any combination of L, S, V 	Mature audiences only. This program may contain mature themes, profane language, graphic violence, and explicit sexual content.
FV :		Fantasy/Cartoon Violence.	
V :		Violence	
S :		Sex	
L :		Offensive Language	
D :		Dialogue with sexual content.	

CANADIAN ENGLISH RATINGS CHART

E	Exempt - Exempt programming includes: news, sports, documentaries and other information programming, talk shows, music videos, and variety programming.
C	Programming intended for children under age 8. No offensive language, nudity or sexual content.
C8+	Programming generally considered acceptable for children 8 years and over. No profanity, nudity or sexual content.
G	General programming, suitable for all audiences.
PG	Parental Guidance suggested. Some material may not be suitable for children.
14+	Programming contains themes or content which may not be suitable for viewers under the age of 14. Parents are strongly cautioned to exercise discretion in permitting viewing by pre-teens and early teens.
18+	18+ years old. Programming restricted to adults. Contains constant violence or scenes of extreme violence.

CANADIAN FRENCH RATINGS CHART

E	Exempt - Exempt programming.
G	General - Programming intended for audience of all ages. Contains no violence, or the violence content is minimal or is depicted appropriately.
8 ans +	8+ General - Not recommended for young children. Programming intended for a broad audience but contains light or occasional violence. Adult supervision recommended.
13 ans +	Programming may not be suitable for children under the age of 13 - Contains either a few violent scenes or one or more sufficiently violent scenes to affect them. Adult supervision strongly suggested.
16 ans +	Programming may not be suitable for children under the age of 16 - Contains frequent scenes of violence or intense violence.
18 ans +	Programming restricted to adults. Contains constant violence or scenes of extreme violence.

Customer Caution

The V-Chip system that is used in this set is capable of blocking "NR" programs (non rated, not applicable and none) as per FCC Rules Section 15.120(e)(2). If the option of blocking "NR" programs is chosen "unexpected and possibly confusing results may occur, and you may not receive emergency bulletins or any of the following types of programming:"

- Emergency Bulletins (Such as EAS messages, weather warnings and others)
- Locally originated programming • News • Political • Public Service Announcements • Religious • Sports
- Weather

Blocking Messages

Various Blocking messages are displayed on-screen depending upon the type of blocking you have selected in the Lock menu.

Note

- Entering the password will override the block condition. However, the ratings selection will be retained.

Message	Possible cause
Game locked.	The TV/VIDEO button was pressed when the Game lock had been selected.
Channel Locked.	Tuned to the designated channel when the Channel lock had been selected.
All locked.	Tuned to CH 3 or CH 4 when the Game lock had been selected. Lock all is selected.
Program locked.	Received program that exceeds the Block Program rating level.

Change password

Procedure

1. Press **▲ ▼** to select "Change password".
2. Press **OK** to display the Input Password screen.

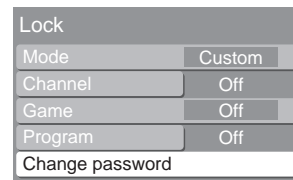

3. Press the **NUMBER** keys to change a 4-digit password to enter the Lock menu. Enter a 4-digit password.

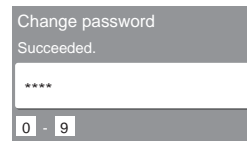
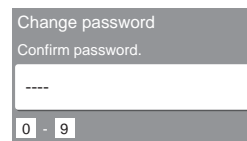
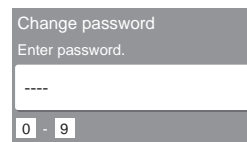

Notes

- Use a password that is easy to remember and record it in a safe place.
- **Do not forget your password.** If you have forgotten it, please contact service center.

Viewing from SD Card

Still image data (JPEG) made with a digital camera or digital video camera can be played back using an SD Card.

⚠ WARNING

As with any small objects, SD cards can be swallowed by young children. Do not allow children to handle the SD card.

⚠ CAUTION

1. Always insert card in the correct direction. Failure to do so may result in damage to the card and this unit.
2. The SD Card is precision devices. Do not subject them to excessive pressure or strong impacts.

Cautions in handling SD Card:

- Do not remove the card while the unit is accessing data (this can damage card or unit).
- Do not touch the terminals on the back of the card.
- Do not subject the card to a high pressure or impact.
- Insert the card in the correct direction (otherwise, card may be damaged).
- Electrical interference, static electricity, or erroneous operation may damage the data or card.
- Back up the recorded data at regular intervals in case of deteriorated or damaged data or erratic operation of the unit. (Panasonic is not liable for any deterioration or damage of recorded data.)

■ Data Format for Card Browsing

Photo: Still images recorded with digital still cameras compatible with JPEG files of DCF* and EXIF** standards

Data format: Baseline JPEG (Sub-sampling: 4:4:4, 4:2:2 or 4:2:0)

Max. number of files: 9,999

Image resolution: 160 × 120 to 10,000,000

* DCF (Design rule for camera file system): A Japan Electronics and Information Technology Industries Association's standard

** EXIF (Exchangeable Image File Format)

Notes

- Some parts of an image may not be displayed, or the image may be displayed on a smaller scale depending on the size of the image.
- Only JPEG images can be displayed on this unit.
- A JPEG image modified with a PC may not be displayed.

Insert/Remove the Card

⚠ CAUTION

Do not remove the SD card while "Accessing" is being displayed on screen. Otherwise, data may be lost or corrupted.

Notes

- Compliant card type (maximum capacity): SDHC Card (4 GB), SD Card (2 GB), mini SD Card (1 GB) (requiring mini SD Card adapter).
- Remove the Card carefully to prevent it from popping out of the slot too fast.

Insert the Card

With the SD logo facing upward, insert the Card horizontally into the SD Card Slot. The card is secured when you hear a click.

Front Card Slot (p. 10)

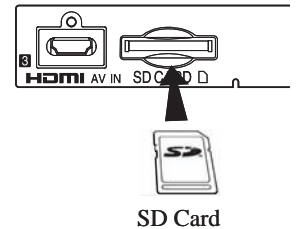

Remove the Card

Gently press in on the Card and release slowly. Pull the Card from the slot.

Front Card Slot (p. 10)



Press in lightly on SD Card, then release.

Card Warning Messages

If there is a problem with the card or card data, the following messages will appear.

■ SD Card warning messages

Message	Description
Is memory card in?	• The card is not inserted.
No file	• The card has no data, or this type of data is not supported.
Cannot read file	• The file is broken or unreadable. • This Projection Display does not support the format.

■ GalleryPlayer warning messages (p. 48)

Message	Description
Cannot display image due to incorrect ID data.	• There is a problem with the unit decoder. • If this message appears, please contact Panasonic Service Center for assistance. Refer to page 64 (Customer Services Directory (for U.S.A.)), page 65 or 66 (Limited Warranty (for U.S.A. or for Canada))
Cannot display image on SD card.	• There is a problem with the data. Check the data on the SD card.

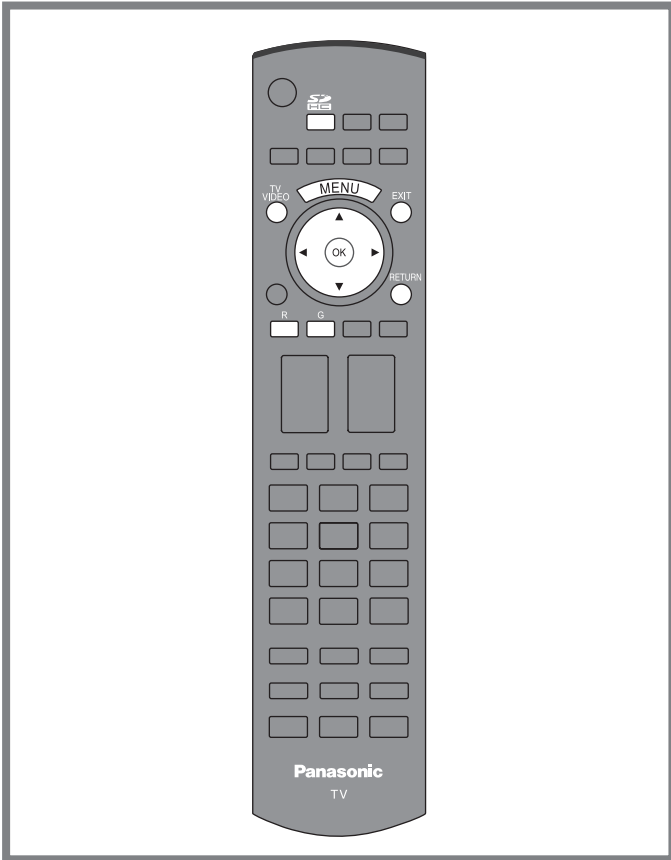

Press MENU to display the Main Menu screen.

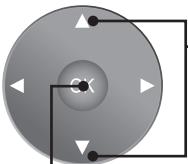

Press to select "Memory card" icon.

Press to display the Photo viewer.

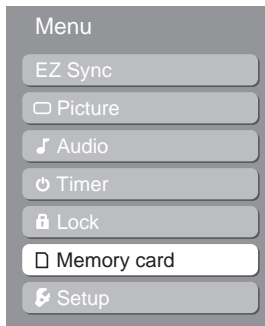



- The SD button may also be pressed for Photo viewer mode. (p. 29)
- While Main Menu (only) is displayed, pressing MENU will exit the menu screen.
- **Return to previous level menu.**
Press RETURN to return to previous level menu.
- **Return to normal picture.**
Press EXIT to exit menu.

Photo viewer Mode

The screen below is displayed automatically while a card is inserted.

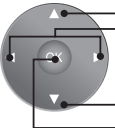
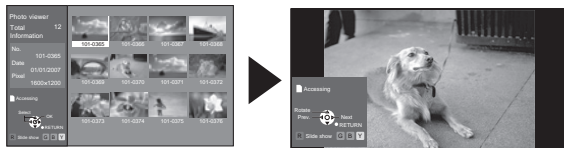

1	<p>Total Total number of images.</p>
2	<p>Information Selected picture information is displayed. No. : Image number or file name is displayed. Date : Date of recording is displayed. Pixel : Display resolution is displayed.</p> <p>Note</p> <ul style="list-style-type: none"> • Depending on the JPEG format, "Info" contents may not be displayed correctly. Refer to page 46 (Data format for SD card browsing) for details.
<p>Navigation Area</p> <p>■ Single Play Mode</p>  <p>Present status While reading the data.</p> <p>3 Press the R button : to Slide Show Mode</p> <p>■ Slide Show Mode</p>  <p>Present status While reading the data.</p> <p>Press the G button : to Single Play Mode</p>	
4	<p>Index Area</p>  <p>Press to select file.</p> <p>Press to display full size file preview. (See Next Page.)</p> 

- **Exit Photo viewer**
Press EXIT.
- **Return to the previous screen**
Press RETURN.

Viewing from SD Card (continued)

Single Play Mode



Displays one at a time

Navigation Area

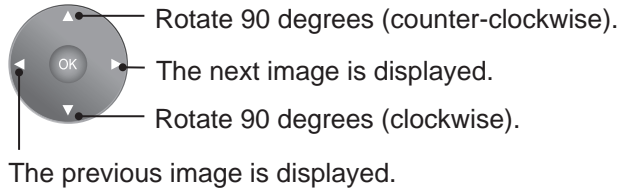

- **Display/hide Navigation area**
Press RECALL.

To Watch Photos in Slide Show Mode

Procedure

1. Press R to start Slide Show in Photo viewer mode or Single Play mode.

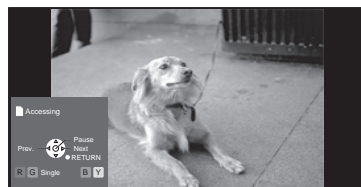

Notes

- For large image sizes, the display time will be longer than the number of seconds set.
- To stop in mid-cycle → Press RETURN.
- To stop a slide show → Press OK.

■ Slide Show Setting

Procedure

1. Press MENU to display the JPEG menu.



2. Press ▲ ▼ to select “JPEG setup”.

3. Press OK to display the JPEG setup menu.



4. Press ▲ ▼ to select each item.

5. Press ◀ ▶ to set each item.

Disp. time	You can set how many seconds each image is displayed in Slide mode.
Repeat	Turn the slide show Repeat function On or Off.

To Adjust Picture

When MENU is pressed in Photo viewer mode or Single Play mode, the JPEG menu is displayed.

Procedure

1. Press ▲ ▼ to select “Picture”.
2. Press OK to display the Picture menu.



3. Press ▲ ▼ to select each item.

4. Press ◀ ▶ to set each item.

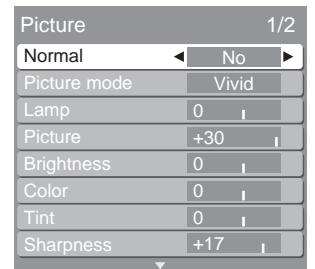

Picture menu (p. 35)

Viewing from a GalleryPlayer SD Card

You can view high-definition art and photography purchased on or downloaded to an SD card. GalleryPlayer provides pre-loaded SD cards with copy-protected imagery and images for download to your computer that can be saved on an SD card for display on your television.

Visit www.galleryplayer.com
<<http://www.galleryplayer.com/>> for more info.

GalleryPlayer images are available for a fee from GalleryPlayer, Inc.

Setup Features

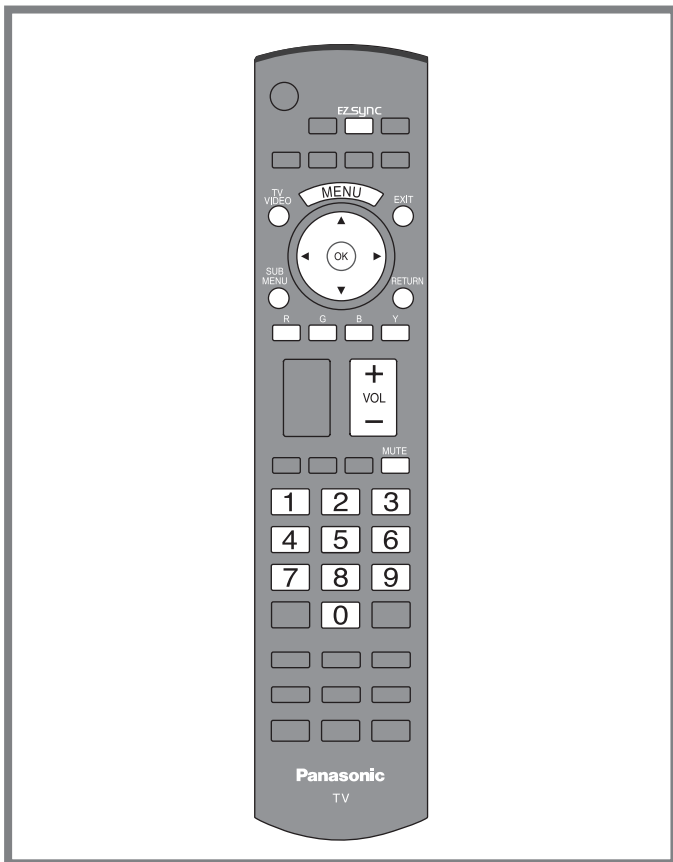

Press MENU to display the Main Menu screen.

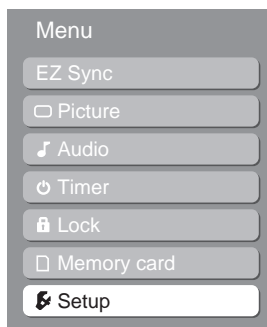
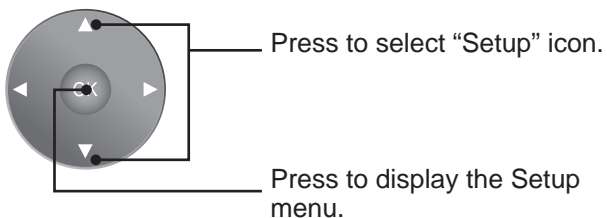

• While Main Menu (only) is displayed, pressing MENU will exit the menu screen.

- **Return to previous level menu.**
Press RETURN to return to previous level menu.
- **Return to normal picture.**
Press EXIT to exit menu.

Surf Mode

You may choose the way in which channels are selected with ▲▼.

Procedure

1. Press ▲▼ to select “Surf mode”.
2. Press ◀▶ to select “Favorite” or “All”.
 - Favorite - ◀▶ only displays programs on the Favorite CH list.
 - All - ◀▶ selects all channels memorized with Auto Program.

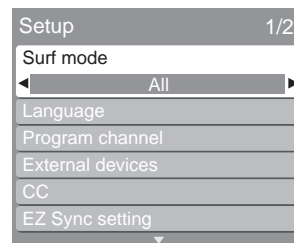

Signal Meter

Allows you to confirm the signal strength of a desired channel.

Procedure

1. Press ▲▼ to select “Program channel”.
2. Press OK to display the Program channel menu.
 - If Lock (p. 41) has been set, you must enter your password to display the Program channel menu.

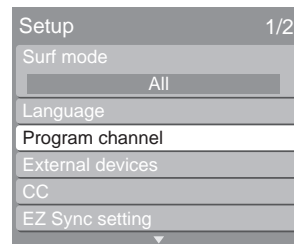

3. Press ▲▼ to select “Signal meter”.
4. Press OK to display the Signal meter menu.

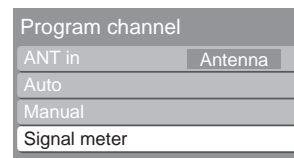

Setup Features (continued)

5. Press ◀▶ to select desired channel.

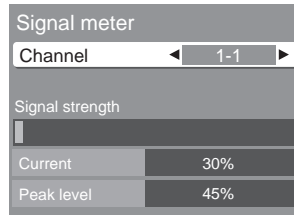

Note

- The signal meter works only for digital signals input via the antenna.

Input labels

To label video input connections for on-screen display.

Procedure

1. Press ▲▼ to select “External devices”.
2. Press OK to display the External devices menu.

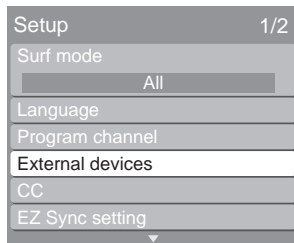

3. Press ▲▼ to select “Input labels”.
4. Press OK to display the Input labels menu.

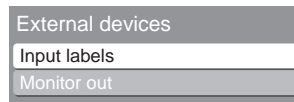

5. Press ▲▼ to select each item.
6. Press ◀▶ to select the input label.

- To skip the input, select “SKIP”. The input will be skipped when you press TV/VIDEO.
- Selectable input labels : SKIP, VCR, DVD, CABLE, DBS, PVR, GAME, AUX, blank (non label).

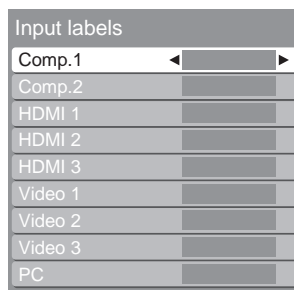

Monitor out

When connecting external equipment to this unit - Stops output of the picture and sound signals at the AV OUT jacks for the input source selected in this menu to avoid signal loop.

Procedure

1. Press ▲▼ to select “External devices”.
2. Press OK to display the External devices menu.

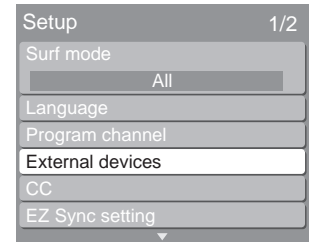

3. Press ▲▼ to select “Monitor out”.
4. Press OK to display the Monitor out menu.

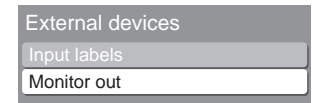

5. Press ▲▼ to select each item.
6. Press ◀▶ to select “On” or “Off”.

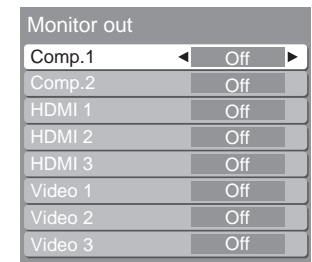

Notes

- Select “Off” to stop output of picture and audio. (Video 1/Video 2/Video 3)
- Comp.1 / Comp.2 / HDMI 1 / HDMI 2 / HDMI 3 cannot output video signals regardless of “Monitor out” setting. When equipment (STB, DVD, etc.) is connected to HDMI or COMPONENT terminals, only audio signals can be obtained. From the output terminals, no video signals can be passed.

CC (Closed Caption)

The television includes a built-in decoder that is capable of providing a visual display of the audio portion. The program viewed must provide Closed Caption (CC) for the television to display it.

Procedure

1. Press **▲▼** to select “CC”.
2. Press **OK** to display the CC (Closed Caption) menu.

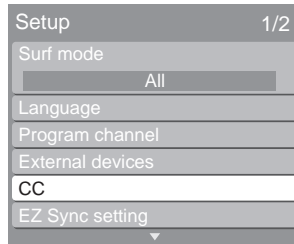

CC Mode

Procedure

1. Press **▲▼** to select “Mode”.
2. Press **◀▶** to select “On” or “Off”.
 - Off - Recommended mode when Closed Caption is not being used.
 - On - To display Closed Captions.

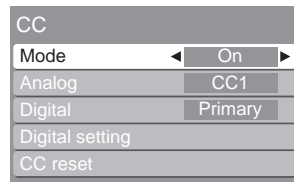

Notes

- The Closed Caption is not displayed when you use HDMI connection.
- If analog connected equipment is used for displaying or recording, Closed Caption (CC) should be set On/Off on the connected equipment. The CC mode setting of the TV will not affect the analog input. If a digital program is being output in analog format, the CC data will also be output in analog format. If digital connected equipment is used for input, CC should be set “On” on either the connected equipment or the TV. If CC is set “On” on both the connected equipment and the TV, captions from each unit will overlap.

CC Mode for Analog

Choose the Closed Caption service of Analog broadcasting.

Procedure

1. Press **▲▼** to select “Analog”.
2. Press **◀▶** to select the setting.

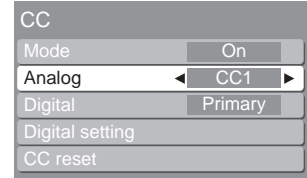

CC1	For video related information that can be displayed (up to 4 lines of script on the screen, where it does not disturb the relevant parts of the picture). Script can be in any language.
CC2/CC3/CC4	Other modes used for video related information.
T1	Blanks out a large portion of the picture on the television screen, and displays program guide or any other information currently being transmitted.
T2/T3/T4	Other modes that display information and blank out a large portion of the picture of the TV screen.

CC Mode for Digital

The Digital Closed Caption menu lets you configure the way you choose to view the digital captioning.

Procedure

1. Press **▲▼** to select “Digital”.
2. Press **◀▶** to select the setting.
 - Primary, Second., Service 3, Service 4, Service 5, Service 6

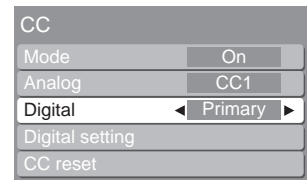

Setup Features (continued)

Digital settings

Selecting digital broadcast service and viewing formats.

Procedure

1. Press **▲▼** to select “Digital setting”.
2. Press **OK** to display the Digital setting menu.

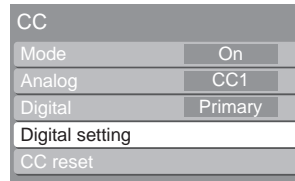

3. Press **▲▼** to select each item.
4. Press **◀▶** to select the setting.

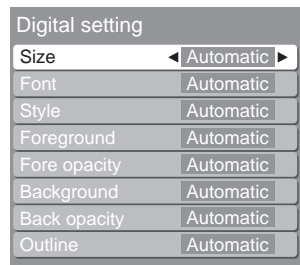

Size	Automatic, Normal, Small, Large
Font	Automatic, Default, Mono-serif, Prop-serif, Mono, Prop, Casual, Cursive, Small caps
Style	Automatic, None, Raised, Depressed, Uniform, Drop shadow
Foreground	The color of the font (Automatic, Black, White, Red, Green, Blue, Yellow, Magenta, Cyan)
Fore opacity	The opacity of the font (Automatic, Transparent, Translucent, Solid, Flashing)
Background	The color of the text box (Automatic, Black, White, Red, Green, Blue, Yellow, Magenta, Cyan)
Back opacity	The opacity of the text box (Automatic, Transparent, Translucent, Solid, Flashing)
Outline	The outline of the text (if selected under style) (Automatic, Black, White, Red, Green, Blue, Yellow, Magenta, Cyan)

CC Reset

Reset the CC settings.

Procedure

1. Press **▲▼** to select “CC reset”.
2. Press **OK** to reset Closed Caption settings.

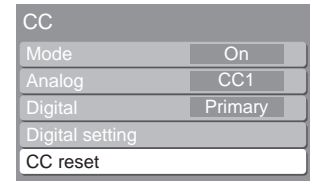

EZ Sync™ “HDAVI Control™”*

* Simultaneously control all Panasonic “HDAVI Control” equipped components using one button on one remote.

Enjoy additional HDMI Inter-Operability with Panasonic products which have “HDAVI Control” function. This Projection Display supports “HDAVI Control 2” function.

Connections to some Panasonic equipment (DVD Recorder DIGA, HD Camcorder, RAM theater, Player theater, Amplifier, etc.) with HDMI cables allow you to interface automatically.

The equipment with “HDAVI Control” function enables the following operations:

Automatic Input Switching, Power on link, Power off link and Speaker control (p. 53-54)

In addition, the equipment with “HDAVI Control 2” function enables the following operation:

EZ Sync Control only with this Projection Display’s remote control (for “HDAVI Control 2”). (p. 54)

EZ Sync “HDAVI Control”, based on the control functions provided by HDMI which is an industry standard known as HDMI CEC (Consumer Electronics Control), is a unique function that we have developed and added. As such, its operation with other manufacturers’ equipment that supports HDMI CEC cannot be guaranteed.

- **For the first time / When adding new equipment, reconnecting the equipment or changing the setup. After the connection turn the equipment on and then switch this Projection Display on. Select the input mode to HDMI 1, HDMI 2, or HDMI 3 (p. 29), and make sure that an image is displayed correctly.**
- This function needs an HDMI compliant (fully wired) cable. Non-HDMI-compliant cables cannot be utilized. It is recommended that you use Panasonic’s HDMI cable. Recommended part number: RP-CDHG15 (1.5 m), RP-CDHG30 (3.0 m), RP-CDHG50 (5.0 m)

HDMI connections to some Panasonic equipment allow you to interface automatically.

- This function may not work normally depending on the equipment condition.
- The equipment can be operated by other equipment's remote controls with this function on even if this Projection Display is in Standby mode.
- Image or sound may not be available for the first few seconds when the playback starts.
- Image or sound may not be available for the first few seconds when Input mode is switched.
- Volume function will be displayed when adjusting the volume of the equipment.
- If you connect the same kind of equipment at once (for example: one DIGA to HDMI 1 / another DIGA to HDMI 2), EZ Sync™ is available for the terminal with the smaller number.
- If you connect the equipment that has "HDAVI Control 2" function to the TV with HDMI cable, the sound from DIGITAL AUDIO OUT terminal can be output as multi-channel surround.

Procedure

1. Press ▲▼ to select "EZ Sync setting".
2. Press OK to display the EZ Sync setting menu.

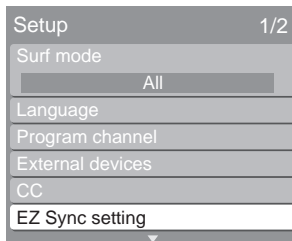

3. Press ▲▼ to select "EZ Sync".

4. Press ◀▶ to select "On".

- Default setting is "On". If no HDMI devices are connected or standard HDMI (without "EZ Sync") is used, set to "Off".

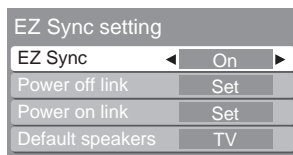

5. Press ▲▼ to select each item.

6. Press ◀▶ to select the setting.

Item	Explanations
EZ Sync	Controls equipment connected to HDMI terminal. (p. 52-53) <ul style="list-style-type: none"> • "Power off link", "Power on link", and "Default speakers" cannot be selected if "Off" is set.
Power off link	When "Set" is selected and this Projection Display is turned off, all connected EZ Sync compatible equipment is also automatically turned off. <ul style="list-style-type: none"> • DIGA (Panasonic DVD Recorder) will not turn off if it is still in rec mode. Caution: <ul style="list-style-type: none"> • This Projection Display remains on even if the EZ Sync compatible equipment is turned off.
Power on link	When "Set" is selected, this Projection Display is turned on automatically and switches to the appropriate HDMI input whenever EZ Sync compatible equipment is initially turned on and Play mode is selected. <ul style="list-style-type: none"> • While the power lamp is blinking, the picture cannot be seen. • Power on link will not work until lamp cooling is completed when power is turned off.
Default speakers	"TV" is the default setting. To set the Home theater system as default speakers, change the default speakers setting from "TV" to "Theater". Sound will be output from the Home Theater whenever this Projection Display is powered on.

Automatic Input Switching

At the start of the DIGA, Player theater, or RAM theater playback, this Projection Display's input automatically switches to the input based on the playback equipment.

- For the RAM theater, the speakers automatically switch to the theater system. If using the DIGA operation, this Projection Display's input automatically switches to the DIGA and DIGA menu is displayed.

Speaker control

You can select Home theater, or TV speakers for audio output.

Control theater speakers with this Projection Display's remote control.

This function is available only when Panasonic Amplifier or Player theater is connected.

Procedure

1. Press EZ Sync to display the EZ Sync menu.

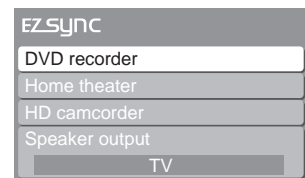

Setup Features (continued)

- Press ▲▼ to select “Speaker output”.
- Press ◀▶ to select “TV” or “Home theater”.

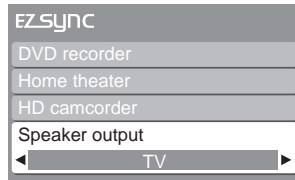

■ Home theater:

Adjustment for equipment.

- Press VOL +/- for desired volume level.
- Press MUTE to mute the sound.

Notes

- The sound of TV is muted.
- When the equipment is turned off, TV speakers become active.
- Selecting “Home theater” turns the equipment on automatically if it is in standby mode.

■ TV:

The TV speakers are active.

EZ Sync Control (Only for HDAVI Control 2 compatible DVD recorder, Home theater, and HD camcorder models)

In the EZ Sync menu, you can select an HDMI connected Panasonic equipment and access it quickly. Continue using this Projection Display’s remote control to operate the equipment, pointing it at the Projection Display.

Procedure

- Press EZ Sync to display the EZ Sync menu.

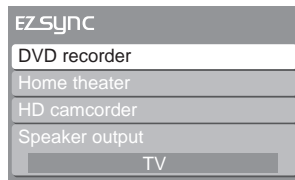

- Press ▲▼ to select the equipment.

- You can select available items only.

- Press OK to access the selected equipment.

- Operate the equipment with this Projection Display’s remote control, pointing it at the Projection Display.

- To operate the equipment, read the manual for the equipment.

■ Available this Projection Display’s remote control buttons

	Move the cursor/Select
	Set/Access
	Return to the previous menu
	Display the Functions menu on the equipment
	Available when the purpose of the keys are displayed

One-touch theater playback

If the “ONE TOUCH PLAY” key is pressed on the remote control for Panasonic Home Theater system, the following sequence of operations is performed automatically.

- Home Theater power switches On, and playback begins.
- TV power switches On, and the playback screen is displayed.
- Audio is muted on the TV and switches to the theater system.

Other Adjust

Procedure

- Press ▲▼ to select “Other adjust”.
- Press OK to display the Other adjust menu.

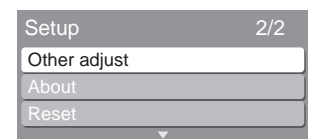

- Press ▲▼ to select each item.

- Press ◀▶ to select “Set” or “No”.

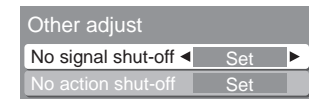



No signal shut-off	<p>To conserve energy, this Projection Display automatically turns off when NO SIGNAL continues more than 10 minutes.</p> <p>Notes</p> <ul style="list-style-type: none"> • Not in use when setting “PC”, “Photo viewer mode”, “Lock”, or Digital channel. • “No signal shut-off was activated” will be displayed for about 10 seconds when this Projection Display is turned on for the first time after turning the power off by “No signal shut-off”. • The on-screen display will flash 3, 2 and 1 to indicate the last three (3) remaining minutes prior to the shut-off.
No action shut-off	<p>To conserve energy, this Projection Display automatically turns off when no operation of remote or front panel key continues more than 3 hours.</p> <p>Notes</p> <ul style="list-style-type: none"> • Not in use when setting “PC”. • “No action shut-off was activated” will be displayed for about 10 seconds when this Projection Display is turned on for the first time after turning the power off by “No action shut off”. • The on-screen display will flash 3, 2 and 1 to indicate the last three (3) remaining minutes prior to the shut-off.

About

Display the TV set Version and Software License.

Procedure

1. Press ▲▼ to select “About”.
 2. Press OK to display the About screen.
- 
3. Press ▲▼ to select “Version” or “License”.
 4. Press OK to display the Version or License screen.
- 

Reset

Setup is reset.

Procedure

1. Press ▲▼ to select “Reset”.
2. Press OK to display the password screen.



3. Enter your password by pressing the NUMBER keys to reset the Setup settings.

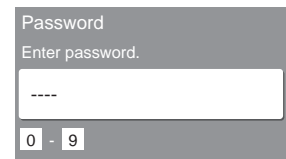

4. The confirmation screen is displayed. Select “Yes”, and press OK.

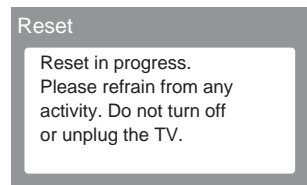
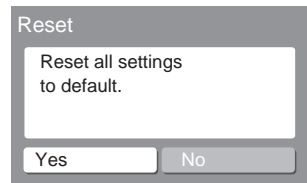

Notes

- Performing Reset will clear all items set with Setup, such as channel settings. Use Reset with care.
- POWER indicator flashes red. After flashing stops, unplug the unit then plug it back in and turn power ON.
- When using “EZ Sync™ “HDAVI Control™””, with the device connected, set “EZ Sync” first to “Off” and then “On” using the Setup Menu. (p. 52-53)

Operating Peripheral Equipment

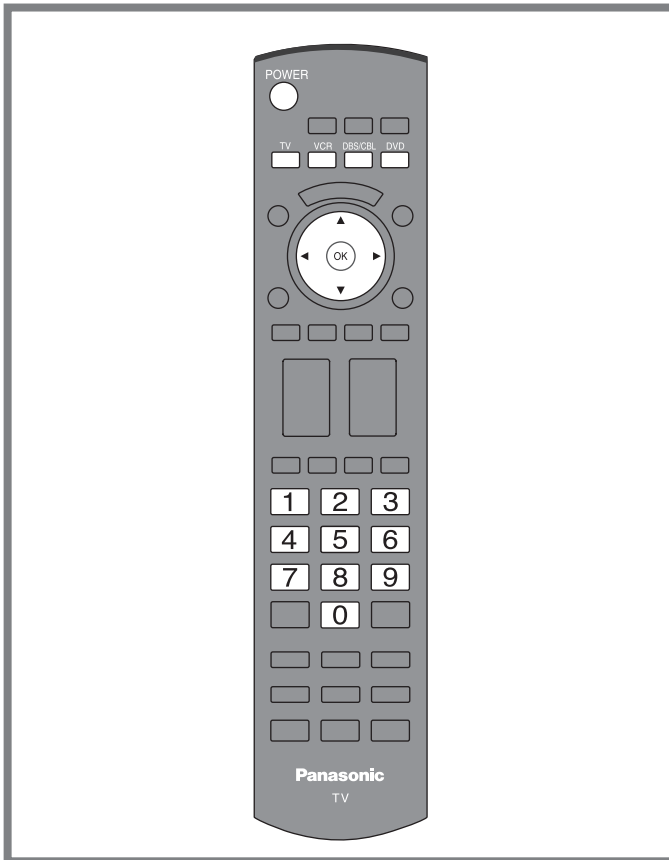

You can operate other manufacturers' equipment using this Projection Display's remote control.

Procedure

- 1. Connect the external equipment to the Projection Display and Power Off the external equipment.**
- 2. Press POWER and OK simultaneously for more than 3 seconds.**
 - Release the buttons when the equipment selection buttons start flashing.
- 3. Select the equipment with the equipment selection button (VCR, DBS/CBL, DVD).**
 - The selected button remains lit (other buttons are not lit).
- 4. Press the NUMBER keys to input the equipment's 4-digit remote control code. (p. 58-60)**
- 5. Press POWER to operate the equipment with the remote control. (p. 57)**
 - The external equipment turns On.

■ If the equipment does not operate with the remote control

- When your equipment has a single code
→ Input the remote control code again
- When your equipment has multiple codes
→ Change the code with step 4 and test again

■ Return to the TV mode

Press TV.

Caution

- Registration will fail if the wrong code is input or it takes more than 30 seconds to register.

To find a code not listed in the code list

This procedure searches all codes and is called the "sequence method."

Procedure

- 1. After step 3, press ► and POWER to change the code and test.**
 - Operate the equipment with the remote control. (p. 57)
 - Repeat until the code is found.
 - It may take many attempts before the correct code is found.
- 2 When the correct code is found, press OK.**

Remote Control Operation/Code List

The following explains how to operate external devices with the remote control.

- Register the remote control codes (p. 56) if you want to operate an external device of another manufacturer. (p. 58-60)

Note

- Operation may not be possible depending on the available memory size of the remote control.
This remote control is not designed to cover operation of all functions of all models.

Remote Control Operation List

This chart defines which keys are operational after programming (if needed) while in the selected remote control mode, CABLE, DBS, VCR, or DVD.

KEY NAME	VCR MODE	DBS/CBL MODE		DVD MODE
		(DBS)	(CBL)	
POWER	Power	Power	Power	Power
SAP	—	LIST	LIST	DVD AUDIO
TV VIDEO	TV Input Switch	TV Input Switch	TV Input Switch	TV Input Switch
MENU	—	Menu	Menu	Functions
EXIT	—	Exit	Exit	—
	—	Up/Down/Left/Right	Up/Down/Left/Right	Up/Down/Left/Right
	—	Select	Select	Enter
SUB MENU	—	Guide	Guide	Sub Menu
RETURN	—	PPV/VOD	PPV/VOD	Return
R	—	Red	A	Red
G	—	Green	B	Green
B	—	Blue	C	Blue
Y	—	Yellow	D	Yellow
	Channel Up/Down	Channel Up/Down	Channel Up/Down	Channel Up/Down
	TV Volume Up/Down	TV Volume Up/Down	TV Volume Up/Down	TV Volume Up/Down
ASPECT	—	Aspect	Aspect	—
FAVORITE	—	Favorite	Favorite	Direct Navigator
RECALL	Onscreen Display	Info	Info/Display/OSD	Onscreen Display
MUTE	TV Mute	TV Mute	TV Mute	TV Mute
	0-9	0-9	0-9	0-9
R-TUNE	—	Last Channel	Last Channel	Drive Select
PROG	—	Sub Channel	Music	PROG (Sub Channel)
SKIP	—	Page Down/Up	Page Down/Up	Skip Reverse/Forward
TV/VCR	TV/VCR Switch	TV/DBS Switch	TV/CBL Switch	—
SEARCH	Rewind/Fast Forward	Rewind/Fast Forward	Rewind/Fast Forward	Reverse/Forward
REC	VCR Record	PVR Record *1	PVR Record *1	Record
STOP	Stop	Stop	Stop	Stop
PAUSE	Pause	Pause	Pause	Pause
PLAY	Play	Play	Play	Play

*1: Combination type

Remote Control Operation/Code List (continued)

Remote Control Code List

Cable Converter (DBS/CBL)

Brand	Code	Brand	Code	Brand	Code	Brand	Code
A-Mark	0008, 0144	GE	0144	Pace	0008, 0237, 0877, 1877	Sony	1006
ABC	0003, 0008, 0237	General Instrument	0003, 0012, 0276, 0476, 0810	Panasonic	0000, 0008, 0107, 0144	Sprucer	0144
Accuphase	0003	Gibraltar	0003	Paragon	0000, 0008, 0525	Starcom	0003
Acom	0237	GMI	0883	Penney	0000	Supercable	0276
Action	0237	GoldStar	0144	Philips	0317, 1305	Supermax	0883
Active	0237	Hamlin	0009, 0273	Pioneer	0144, 0533, 0877, 1877	Thomson	1256
Americast	0899	Hitachi	0003, 0008, 0009	Prism	0012	Tocom	0012
Archer	0237	Insight	0476, 0810	Pulsar	0000	Torx	0003
BCC	0276	Jerrold	0003, 0012, 0276, 0476, 0810	Quasar	0000	Toshiba	0000
Bell South	0899	Memorex	0000	RadioShack	0883	Tristar	0883
British Telecom	0003	Mitsubishi	0003	RCA	1256	United Cable	0003, 0276
Century	0008	Motorola	0276, 0476, 0810, 1254, 1376	Regal	0273, 0276, 0279	US Electronics	0003, 0008, 0276
Clearmaster	0883	Multitech	0883	Runco	0000	V2	0883
ClearMax	0883	Nova Vision	0008	Samsung	0003, 0144	Videoway	0000
Cool Box	0883	Novaplex	0008	Scientific Atlanta	0000, 0003, 0008, 0012, 0237, 0477, 0877, 1877	Viewmaster	0883
Coolmax	0883	NSC	0012			Vision	0883
Director	0476					Vortex View	0883
Fosgate	0276					Zenith	0000, 0525, 0899

Cable/PVR Combination (DBS/CBL)

Brand	Code	Brand	Code	Brand	Code	Brand	Code
Americast	0899	Motorola	0810, 1376	Scientific Atlanta	0877, 1877	Zenith	0899
General Instrument	0810	Pace	0237, 1877	Sony	1006		
Jerrold	0810	Pioneer	0877, 1877	Supercable	0276		
		RCA	1256	Thomson	1256		

Satellite Receiver (DBS/CBL)

Brand	Code	Brand	Code	Brand	Code	Brand	Code
Bell ExpressVu	0775	GE	0392, 0566	Motorola	0856, 0869	Samsung	1108, 1109, 1142, 1276, 1377, 1442, 1609
Chaparral	0216	General Instrument	0869	Netsat	0099	SKY	0856, 0099
Crossdigital	1109	GOI	0775, 1775	Next Level	0869	Sony	0639, 1639, 1640
DirecTV	0099, 0247, 0392, 0566, 0639, 0724, 0749, 0819, 1076, 1108, 1109, 1142, 1377, 1392, 1414, 1442, 1609, 1639, 1640, 1749, 1856	Hitachi	0749, 0819, 1250	Optimus	0724	Star Choice	0869
Dish Network System	0775, 1005, 1505, 1775	Houston	0775	Panasonic	0247, 0701, 1786	Star Trak	0869
Dishpro	0775, 1005, 1505, 1775	HTS	0775, 1775	Paysat	0724	Thomson	0392, 0566
Echostar	0775, 1005, 1505, 1775	Hughes Network Systems	0749, 1142, 1442, 1749	Philips	0099, 0722, 0724, 0749, 0775, 0819, 1076, 1142, 1442, 1749	Tivo	1142, 1442
Expressvu	0775, 1775	Innova	0099	Pioneer	1142, 1442	Toshiba	0749, 0790, 0819, 1285, 1749
Funai	1377	Jerrold	0869	Primestar	0869	UltimateTV	1392, 1640
		JVC	0775, 1775	Proscan	0392, 0566	Uniden	0724, 0722
		LG	1414	RadioShack	0566, 0775, 0869	Voom	0869
		Magnavox	0722, 0724	RCA	0392, 0566, 0775, 1142, 1392, 1442	Zenith	0856, 1856
		McIntosh	0869				
		Memorex	0724				
		Mitsubishi	0749				

DBS/PVR Combination (S) (DBS/CBL)

Brand	Code	Brand	Code	Brand	Code	Brand	Code
DirecTV	0099, 0392, 0639, 1076, 1142, 1377, 1392, 1442, 1640	Dishpro	0775, 1505	Motorola	0869	Sony	0639, 1640
Dish Network System	0775, 1505	Echostar	0775, 1505	Philips	1142, 1442	Star Choice	0869
		Expressvu	0775	Proscan	0392		
		Hughes Network Systems	1142, 1442	RCA	1392		
				Samsung	1442		

VCR (VCR)

Brand	Code	Brand	Code	Brand	Code	Brand	Code
A-Mark	0000, 0037, 0240, 0278	Gemini	0060	NAD	0240	Sharp	0048, 0047, 0032, 0000, 0807
ABS	1972	Genexxa	0000, 0037, 0278	NEC	0038, 0067	Shintom	0000, 0039, 0240
Admiral	0039, 0047, 0048, 0060, 0209, 0479	Go Video	0240, 0432, 0614	Nikko	0037, 0278	Shogun	0240
Adventura	0000, 0037, 0240	GoldStar	0000, 0035, 0037, 0038, 0039, 0278, 1237	Nikkodo	0037, 0278	Siemens	0037
Aiko	0278	Goodmans	0000, 0037, 0081, 0278	Niveus Media	1972	Signature	0000, 0035, 0037, 0048, 0060, 0479
Aiwa	0000, 0037	Gradiente	0000	Noblex	0240	Singer	0037, 0240
Alba	0209, 0278	Granada	0042, 0081	Northgate	1972	Sonic Blue	0614, 0616
Alienware	1972	Grundig	0081	Olympus	0035, 0162	Sony	0000, 0032, 0033, 0035, 0047, 0067, 0636, 1232, 1972
Allegro	0039	Harley Davidson	0000	Optimus	0000, 0035, 0037, 0047, 0048, 0162, 0240, 0432, 1062	Soundmaster	0000
America Action	0278	Harman/Kardon	0038, 0081	Orion	0000, 0002, 0121, 0184, 0209, 0240, 0278, 0479, 1479	Stack 9	1972
American High	0035, 0081	Hewlett Packard	1972	Panama	0035	STS	0042
Amstrad	0000	HI-Q	0000, 0035, 0047	Panasonic	0000, 0035, 0162, 0225, 0614, 0616, 1035, 1062, 1244	SV2000	0000
Asha	0240	Hitachi	0000, 0035, 0037, 0042, 0045, 0089	Penney	0000, 0035, 0037, 0038, 0042, 0047, 0067, 0081, 0162, 0240, 1035, 1237	SVA	0000
Astra	0035, 0240	Howard Computers	1972	Pentax	0042	Sylvania	0000, 0035, 0043, 0081, 1781
Audiovox	0037, 0038, 0278	HP	1972	Philco	0000, 0035, 0081, 0209, 0479	Symphonic	0000, 0002, 0240
Avis	0000	Hughes Network Systems	0042, 0739	Philips	0000, 0035, 0048, 0045, 0081, 0162, 0209, 0616, 0618, 0739	Systemax	1972
Beaumarck	0240	Humax	0739	Pilot	0037	Tagar Systems	1972
Bell & Howell	0000, 0035, 0039, 0048, 0479	Hush	1972	Pioneer	0042, 0067, 0081, 0162	Tandy	0000
Broksonic	0002, 0121, 0209, 0479, 1479	Hytec	0000, 0047	Polk Audio	0081	Tatung	0000, 0048, 0067, 0081
Calix	0037	iBUYPOWER	1972	Portland	0278	Teac	0000, 0067
Candle	0037, 0038	ITT Nokia	0240	Profitronic	0240	Technics	0000, 0035, 0037, 0162
Canon	0035	Janeil	0240	Proscan	0060, 1060	Teknika	0000, 0035, 0037
Capehart	0002	Jensen	0067	Protex	0000	Telecorder	0240
Carrera	0240	JVC	0067	Pulsar	0039, 0240, 0278	Tevion	0479
Carver	0035, 0081	KEC	0037, 0278	Pulser	0240	Thomas	0000, 0002
CCE	0278	Kenwood	0038, 0067	Quartz	0035, 0047	Thomson	0060
Cineral	0278	Kodak	0035, 0037	Quasar	0002, 0035, 0162, 1035	Tisonic	0278
Citizen	0000, 0035, 0037, 0209, 0240, 0278, 0479, 1278	KTV	0000	RadioShack	0000, 0035, 0037, 0047, 0048, 0162, 0240	Tivo	0618, 0636, 0739, 1996
Classic	0037	LG	0037, 0038, 0240	Radix	0037	TMK	0000, 0240
Colortyme	0035, 0045, 0060, 0278	Linksys	1972	Randex	0037	TNIX	0037
Colt	0000	Lloyd's	0000, 0038, 0240	RCA	0000, 0035, 0042, 0045, 0048, 0060, 0240, 0807, 0880, 1035, 1060	Tocom	0240
Craig	0037, 0047, 0240	Loewe	0081	Realistic	0000, 0035, 0037, 0047, 0048, 0121, 0162, 0240, 0278	Toshiba	0000, 0043, 0045, 0209, 0240, 0845, 1008, 1145, 1972, 1996
Criterion	0000	Logik	0000, 0240	ReplayTV	0614, 0616	Tosonic	0278
Crosley	0000, 0035, 0081	Lumatron	0278	Ricavision	1972	Totevision	0037, 0240
Crown	0278	LXI	0000, 0037, 0042, 0067	Runco	0039	Touch	1972
Curtis Mathes	0000, 0035, 0060, 0162, 0240, 0278, 0432, 1035	M Electronic	0240	Samsung	0000, 0038, 0045, 0060, 0240, 0432, 0739, 1014	Trix	0037
Cybernex	0240	Magnasonic	0000, 0037, 0240, 0278, 1278	Samtron	0240	Ultra	0045, 0278
CyberPower	1972	Magnavox	0000, 0035, 0037, 0039, 0048, 0081, 0240, 0618, 1781	Sanky	0039, 0048	Unitech	0240
Daewoo	0037, 0045, 0278, 1278	Magnin	0240	Sansui	0000, 0002, 0067, 0209, 0240, 0479, 1479	Vector	0045
Daytron	0037, 0278	Marantz	0035, 0038, 0081	Sanyo	0000, 0047, 0240, 0479	Vector Research	0038, 0184
Dell	1972	Marta	0037	Scott	0043, 0045, 0184, 0121	Victor	0067
Denon	0042, 0081	Matsui	0037, 0209	Sears	0000, 0033, 0035, 0037, 0039, 0042, 0043, 0045, 0047, 0048, 0060, 0067, 0162, 0209, 1237	Video Concepts	0045
DirecTV	0739	Matsushita	0035, 0162, 0081			Videomagic	0037
Dual	0000	Media Center PC	1972			Videosonic	0000, 0240
Durabrand	0038, 0039	MEI	0035			Viewsonic	1972
Dynatech	0000, 0240	Memorex	0000, 0035, 0037, 0039, 0162, 0047, 0048, 0209, 0240, 0278, 0479, 1237			Villain	0000
Electrohome	0000, 0037, 0043, 0060, 0209, 0240	Metz	0037			Voodoo	1972
Electroponic	0037	MGA	0043, 0060, 0240			Wards	0000, 0060, 0033, 0035, 0037, 0038, 0042, 0043, 0045, 0047, 0048, 0081, 0240, 0479
Emerald	0121, 0184	MGN Technology	0240			White Westinghouse	0000, 0209, 0278, 0479
Emerex	0032	Microsoft	1972			World	0002, 0209, 0479
Emerson	0000, 0002, 0037, 0043, 0121, 0184, 0209, 0240, 0278, 0479, 1278, 1479	Midland	0240			XR-1000	0000, 0035, 0240
Fisher	0000, 0039, 0047	Mind	1972			Yamaha	0038
Fuji	0033, 0035	Minolta	0042			Zenith	0000, 0033, 0037, 0039, 0209, 0278, 0479, 1479
Fujitsu	0000	Mitsubishi	0000, 0042, 0043, 0047, 0048, 0060, 0067, 0807			ZT Group	1972
Funai	0000, 0037, 0278	Motorola	0035, 0048				
Garrard	0000	MTC	0000, 0240				
Gateway	1972	MTX	0000				
GE	0000, 0035, 0048, 0060, 0240, 0807, 1035, 1060	Multitech	0000, 0039				

Remote Control Operation/Code List (continued)

DBS/PVR Combination (V) ()

Brand	Code	Brand	Code
Hughes Network Systems	0739	Philips	0739
		Samsung	0739

PVR (V) ()

Brand	Code	Brand	Code	Brand	Code	Brand	Code
ABS	1972	Hughes Network Systems	0739	Northgate	1972	Tagar Systems	1972
Alienware	1972			Panasonic	0616	Tivo	0618, 0636, 0739
CyberPower	1972	Humax	0739	Philips	0618, 0739	Toshiba	1008, 1972, 1996
Dell	1972	Hush	1972	RCA	0880	Touch	1972
DirecTV	0739	iBUYPOWER	1972	ReplayTV	0614, 0616	Viewsonic	1972
Gateway	1972	Linksys	1972	Samsung	0739	Voodoo	1972
Hewlett Packard	1972	Media Center PC	1972	Sonic Blue	0614, 0616	ZT Group	1972
Howard Computers	1972	Microsoft	1972	Sony	0636, 1972		
HP	1972	Mind	1972	Stack 9	1972		
		Niveus Media	1972	Systemax	1972		

DVD ()

Brand	Code	Brand	Code	Brand	Code	Brand	Code
3D LAB	0503, 0539	Funai	0675, 1268	Minato	0752	Samsung	0490, 0573, 0744, 0820, 0899, 1044, 1075
Aiwa	0641	GE	0522, 0815	Mintek	0839	Sansui	0695
Akai	0695, 0899	Go Video	0573, 0741, 0744, 0869, 1044, 1075	Mitsubishi	1521, 0521	Sanyo	0675, 0695
Alba	0672	GoldStar	0741, 0869	NAD	0591, 0741	Schwaiger	0752
Alco	0790	Goodmans	0790	NEC	0785, 0869	Sharp	0630, 0675, 0752, 1256
Allegro	0869	Gradiente	0490, 0651	Onkyo	0503, 0627, 0792	Shinonic	0533, 0839
Apex Digital	0533, 0672, 1020, 1056, 1061	Grundig	0539	Optimus	0571	Slim Art	0784
Arrgo	1023	Harman/Kardon	0582	Oritron	0651	Sonic Blue	0573, 0869
Audiovox	0790	Hitachi	0573, 0664	Palsonic	0672	Sony	0533, 0864, 1033, 1431, 1533
Blue Parade	0571	Hiteker	0672	Panasonic	0503, 0490, 0571, 0703, 1362, 1462, 1490, 1762, 2006, 2016, 2026, 1779	Sylvania	0675, 1268
Blue Sky	0695	Insignia	1268	Philips	0503, 0539, 0646, 0675, 1267, 1354	Symphonic	0675, 1268
Brandt	0651	Integra	0571, 0627	Pioneer	0525, 0571, 0631	Teac	0571, 0790
Broksonic	0695	JMB	0695	Polaroid	1020, 1061	Technics	0490, 0703
California Audio Labs	0490	JVC	0558, 0623, 0867, 1164	Polk Audio	0539	Tevion	0651
Celestial	1020	Kawasaki	0790	Presidian	0675	Theta Digital	0571
Centrex	0672	Kenwood	0490, 0534	Proceed	0672	Thomson	0522
CineVision	0869	KLH	0790, 1020	Proscan	0522	Toshiba	0503, 0539, 0573, 0695, 1045, 1154
Clairtone	0571	Kloss	0533	Qwestar	0651	Universum	0591
Creative	0503, 0539	Koss	0651, 1061	Radionette	0741	Urban Concepts	0503, 0539
CyberHome	0816, 0874, 1023, 1129	Lasonic	0627	RadioShack	0571	US Logic	0839
Daewoo	0784, 0869, 1172	Lecson	1533	RCA	0522, 0571, 0790, 0822, 1022, 1132	Venturer	0790
Denon	0490, 0634	LG	0591, 0741, 0869	Realistic	0571	Xbox	0522
Digitrex	0672	LiteOn	1058	Reoc	0752	Yamaha	0490, 0539, 0545
Disney	0675	Loewe	0741	Rio	0869	Zenith	0503, 0591, 0741, 0869
Dual	0675	Magnasonic	0651, 0675	Rotel	0623	Zeus	0784
DVD2000	0521	Magnavox	0503, 0539, 0646, 0675, 1268	Saba	0651		
Emerson	0591, 0675, 1268	Marantz	0503, 0539, 0675	Sampo	0752		
Enterprise	0591	McIntosh	1533				
Entivo	0503, 0539	Medion	0651				
ESA	1268	Memorex	0695				
Firstline	0651	Microsoft	0522				

DVD-Recorder (Y) ()

Brand	Code	Brand	Code	Brand	Code	Brand	Code
Apex Digital	1056	LG	0741	Pioneer	0631	Sylvania	0675
CyberHome	1129	Magnavox	0646, 0675	RCA	0522	Zenith	0741
Funai	0675	Panasonic	0490, 2006, 2016, 2026	Samsung	0490		
Go Video	0741	Philips	0646	Sharp	0675		
JVC	1164			Sony	1033, 1431		

Warning Indicators

Indicator lights on the front of the unit alert you to the unit's internal condition. (p. 10)
 If the Power or LAMP indicators flash, turn unit off and follow the directions below.

	Indicator	Symptom	Problem	Possible Solution
POWER Indicator	Flashes orange 1 time.	Power shuts off.	Malfunction 1.	Disconnect the AC plug, and wait for about 5 seconds. Reconnect the AC plug, then turn unit power on. If error persists, contact service center.
	Flashes orange 2 times.	Power shuts off.	Malfunction 2.	
	Flashes orange 3 times.	Power shuts off.	Malfunction 3.	
	Flashes orange 4 times.	Power shuts off.	Malfunction 4.	
	Flashes orange 6 times.	Power shuts off.	Malfunction 5.	
	Flashes orange 7 times.	Power shuts off.	Malfunction 6.	
	Flashes orange 9 times.	Power shuts off.	Malfunction 7.	
	Flashes orange 10 times.	Power shuts off.	Malfunction 8.	
LAMP Indicator	Flashes red 2 times.	Power shuts off.	Malfunction 9.	Wait for about 1 minute, then try turning Power On several times. If error persists, contact service center.
	Flashes red 3 times.	Power shuts off.	Internal overheat error.*1	
	Flashes red 4 times.	Power shuts off.	Internal overheat error.*1	
	Flashes red 5 times.	Power shuts off.	Malfunction 10.	
	Flashes red 8 times.	Power shuts off.	Malfunction 11.	Disconnect the AC plug, and wait for about 5 seconds. Reconnect the AC plug, then turn unit power on. If error persists, contact service center.
	Flashes red 9 times.	Power shuts off.	Malfunction 12.	
	Flashes red 10 times.	Power shuts off.	Malfunction 13.	
	Flashes red 11 times.	Power shuts off.	Malfunction 14.	
	Flashes red 12 times.	Power shuts off.	Malfunction 15.	
	Flashes red 13 times.	Power shuts off.	Malfunction 16.	Wait for about 5 seconds, then try turning Power On several times. If error persists, contact service center.

*1: Once necessary steps have been taken, and before turning unit back On, be sure the unit has sufficiently cooled down. Especially if the unit was used for a long period, the lamp may take a while to cool down.

Troubleshooting

Before you call for service, determine the symptoms and make a few simple checks as shown below.

Problem		Possible solution	Page
Power does not turn ON.		<ul style="list-style-type: none"> Is the power cord plugged in? 	24
Remote Control/ Unit buttons do not function. Power does not turn ON or OFF. Image is distorted. Image freezes.		<ul style="list-style-type: none"> Press unit POWER button down over 7 seconds. The POWER indicator goes out. If the Power was On, the screen will also disappear. After 5 seconds, turn Power On and operate unit normally. If the steps above do not restore normal operation, disconnect then reconnect the AC plug and turn the power On. 	-
The power turns OFF.	Power turns off while another indicator is flashing.	<ul style="list-style-type: none"> Please consult your nearest dealer. 	61
Remote Control does not function.		<ul style="list-style-type: none"> Are the batteries dead or inserted incorrectly? 	7
		<ul style="list-style-type: none"> Is the Remote Control sensor in direct fluorescent lamp light or other strong sources of light? 	10
Image shakes.		<ul style="list-style-type: none"> Is the antenna or antenna cable old, broken, or shorted out? 	-
Image is not clear. (blurring / vertical lines)		<ul style="list-style-type: none"> Is the antenna cable connected properly? 	12-17
		<ul style="list-style-type: none"> A sudden temperature change may have caused condensation in the internal optics which results in blurring or vertical lines. Please wait until room temperature is normal and constant before turning power ON. These symptoms will clear up as time passes. 	-
		<ul style="list-style-type: none"> Depending on the connected device, a 1080i input signal may cause the picture to flicker. If the connected device has a format selection switch, set the format to 720p. 	-
Color patches or no color.		<ul style="list-style-type: none"> When using a VCR and selecting channels on the TV, is the TV/VIDEO mode for the VCR set to TV? 	-
Image appears doubled or tripled.		<ul style="list-style-type: none"> Is the antenna facing the right direction? 	-
		<ul style="list-style-type: none"> Is the antenna receiving any signals reflected off of mountains or buildings? 	-
Images disappear at the top and bottom of the screen.		<ul style="list-style-type: none"> When using 16:9 image software (cinema vision size software, etc.), there is no picture at the top and bottom of the screen. 	-
During ZOOM modes, the image is cut off at the top and bottom.		<ul style="list-style-type: none"> Please adjust the V-Size. This is not a malfunction. 	33, 36
Some parts of the screen are always lit while others do not light up. Some parts of the screen do not light up.		<ul style="list-style-type: none"> This is a characteristic of the LCD panel and not a malfunction. 	-
Fan is operating even though TV Power is OFF.		<ul style="list-style-type: none"> This is because the cooling fan is operating. The fan will stop after about 3 minutes. 	24
Leaving stationary images, such as still video images, web pages, or filler bars (used for NORMAL aspect mode), on-screen for an extended period of time can leave ghost images on the screen.		<ul style="list-style-type: none"> This is a characteristic of the LCD panel and not a malfunction. Try displaying constantly moving pictures which fill the entire screen, or turn the power OFF for a while to return the screen to normal. 	-
Pictures from equipment are unusual when the equipment is connected via HDMI.		<ul style="list-style-type: none"> Is the HDMI cable connected properly? 	12, 14-18, 21-22
		<ul style="list-style-type: none"> Turn Off the TV unit and device, then turn them On again. 	-
		<ul style="list-style-type: none"> Check the input signal from the equipment. 	29
No sound is produced.		<ul style="list-style-type: none"> Is "Sound Mute" active? 	30
		<ul style="list-style-type: none"> Is the volume set to the minimum? 	29
		<ul style="list-style-type: none"> Is "Speaker output" set to "Off"? 	39
		<ul style="list-style-type: none"> Change "SAP" settings. 	32
		<ul style="list-style-type: none"> Check "HDMI 1 in", "HDMI 2 in" or "HDMI 3 in" in settings when the equipment is connected via HDMI. 	39
		<ul style="list-style-type: none"> If digital sound connection has problem, select analog sound connection. 	21-23, 39

Specifications

		PT-50LCZ70/PT-50LCZ7/ PT-50LCZ70-K	PT-56LCZ70/PT-56LCZ7/ PT-56LCZ70-K	PT-61LCZ70/PT-61LCZ7/ PT-61LCZ70-K
Power Source		AC 120 V, 60 Hz		
Power Consumption		Power ON: Approx. 360 W Power OFF: Approx. 0.4 W (When cooling fan is stopped)		
LCD panels		0.74" Poly silicon TFT LCD panel x 3 2 073 600 (1 920 x 1 080) stripe pixels x 3 panels (16:9)		
Display		50-inch, 16 : 9 aspect ratio	56-inch, 16 : 9 aspect ratio	61-inch, 16 : 9 aspect ratio
Speaker		2 Speakers 20 W [10 W + 10 W] (10 % THD)		
Light Source		LUXIM® LIFI™ Electrodeless RF Lamp (LFS4000)		
Channel Capability (Digital/Analog)		VHF/UHF Cable	2-69 1-135	
Input Terminals	PC INPUT	RGB analog AUDIO	0.7 Vp-p (75 Ω) (D-SUB 15P) 0.5 Vrms (M3 Stereo mini Pin Jack)	
	AV INPUT 1-3	VIDEO S-VIDEO AUDIO L-R	1.0 Vp-p (75 Ω) (RCA Pin Jack) Y : 1 Vp-p (75 Ω), C : 0.286 Vp-p (75 Ω) (Mini DIN 4 pin) 0.5 Vrms (RCA Pin Jack x 2)	
	COMPONENT VIDEO INPUT 1-2	Y P _B / P _R AUDIO L-R	1.0 Vp-p (with sync) (75 Ω) (Pin Jack) ± 0.35 Vp-p (75 Ω) (Pin Jack x 2) 0.5 Vrms (RCA Pin Jack x 2)	
	HDMI 1-3	HDMI type A Connector • This Projection Display supports "HDAVI Control 2" function. AUDIO L-R	0.5 Vrms (RCA Pin Jack Type x 2)	
Card slot		SD CARD slot x 1		
Output signals (AV OUT)		VIDEO AUDIO L-R	1.0 Vp-p (75 Ω) (RCA Pin Jack) 0.5 Vrms (RCA Pin Jack x 2)	
Dimensions (W x H x D)		1 192 mm (W) x 836 mm (H) x 418 mm (D) 46.9" (W) x 32.9" (H) x 16.5" (D)	1 322 mm (W) x 923 mm (H) x 451 mm (D) 52" (W) x 36.3" (H) x 17.8" (D)	1 432 mm (W) x 996 mm (H) x 483 mm (D) 56.4" (W) x 39.2" (H) x 19" (D)
Weight (Mass)		28 kg (61.7 lbs.) Net	33 kg (72.8 lbs.) Net	35 kg (77.2 lbs.) Net
Operating conditions		Temperature : 0 °C – 35 °C (32 °F - 95 °F) Humidity : 20 % - 80 % (non-condensing)		

Note

- Design and Specifications are subject to change without notice. Weight and Dimensions shown are approximate.

Customer Services Directory (for U.S.A.)

Obtain Product Information and Operating Assistance; locate your nearest Dealer or Servicenter; purchase Parts and Accessories; or make Customer Service and Literature requests by visiting our Web Site at:

<http://www.panasonic.com/consumersupport>

or, contact us via the web at:

<http://www.panasonic.com/contactinfo>

You may also contact us directly at:

1-800-211-PANA (7262),

Monday-Friday 9 am-9 pm; Saturday-Sunday 10 am-7 pm, EST.

For hearing or speech impaired TTY users, TTY : 1-877-833-8855

Accessory Purchases

Purchase Parts, Accessories and Instruction Books online for all Panasonic Products by visiting our Web Site at:

<http://www.pstc.panasonic.com>

or, send your request by E-mail to:

npcparts@us.panasonic.com

You may also contact us directly at:

1-800-332-5368 (Phone) 1-800-237-9080 (Fax Only) (Monday – Friday 9 am to 9 pm, EST.)

Panasonic Service and Technology Company (PSTC)

20421 84th Avenue South,

Kent, WA 98032

(We Accept Visa, MasterCard, Discover Card, American Express, and Personal Checks)

For hearing or speech impaired TTY users, TTY : 1-866-605-1277

Service in Puerto Rico

Panasonic Puerto Rico, Inc. Panasonic Sales Company

Factory Servicenter:

Ave. 65 de Infantería, Km. 9.5, San Gabriel Industrial Park, Carolina, Puerto Rico 00985

Phone (787)750-4300 Fax (787)768-2910

Limited Warranty (for U.S.A.)

PANASONIC CONSUMER ELECTRONICS COMPANY,
DIVISION OF PANASONIC CORPORATION OF NORTH
AMERICA
One Panasonic Way, Secaucus, New Jersey 07094

PANASONIC SALES COMPANY, DIVISION OF PANASONIC
PUERTO RICO, INC.,
AVE. 65 de Infantería, Km. 9.5 San Gabriel Industrial Park,
Carolina, Puerto Rico 00985

Panasonic LIFI™ HDTV Limited Warranty

Limited Warranty Coverage

If your product does not work properly because of a defect in materials or workmanship, Panasonic Consumer Electronics Company or Panasonic Sales Company (collectively referred to as "the warrantor") will, for the length of the period indicated on the chart below, which starts with the date of original purchase ("warranty period"), at its option either (a) repair your product with new or refurbished parts, or (b) replace it with a new or a refurbished product. The decision to repair or replace will be made by the warrantor.

CATEGORY	PARTS	LABOR	SERVICE
LIFI™ HDTV	One (1) Year TV Original LIFI™ lamp unit - 5 years	1 Year	In-Home or Carry-In

During the "Labor" warranty period there will be no charge for labor. During the "Parts" warranty period, there will be no charge for parts. You must carry-in your product or arrange for in-home service during the warranty period. If non-rechargeable batteries are included, they are not warranted. This warranty only applies to products purchased and serviced in the United States or Puerto Rico. This warranty is extended only to the original purchaser of a new product which was not sold "as is". A purchase receipt or other proof of the original purchase date is required for warranty service.

Carry-in or In-Home Service

For In-Home or Carry-In Service in the United States call 1-888-VIEW-PTV (1-888-843-9788).

For assistance in Puerto Rico call Panasonic Sales Company (787)-750-4300 or fax (787)-768-2910.

In-Home service requires clear, complete and easy access to the product by the authorized servicer and does not include removal or re-installation of an installed product. It is possible that certain in-home repairs will not be completed in-home, but will require that the product, or parts of the product, be removed for shop diagnosis and/or repair and then returned.

Limited Warranty Limits And Exclusions

This warranty ONLY COVERS failures due to defects in materials or workmanship, and DOES NOT COVER normal wear and tear or cosmetic damage. The warranty also does not cover damages which occurred in shipment, or failures which are caused by products not supplied by the warrantor, or failures which result from accidents, misuse, abuse, neglect, bug infestation, mishandling, misapplication, alteration, faulty installation, set-up adjustments, misadjustment of consumer controls, power line surge, lightning damage, modification, or commercial use (such as in a hotel, office, restaurant, or other business), rental use of the product, service by anyone other than a Factory Servicenter or other Authorized Servicer, or damage that is attributable to acts of God.

THERE ARE NO EXPRESS WARRANTIES EXCEPT AS LISTED UNDER "LIMITED WARRANTY COVERAGE". THE WARRANTOR IS NOT LIABLE FOR INCIDENTAL OR CONSEQUENTIAL DAMAGES RESULTING FROM THE USE OF THIS PRODUCT, OR ARISING OUT OF ANY BREACH OF THIS WARRANTY. (As examples, this excludes damages for lost time, cost of having someone remove or re-install an installed unit if applicable, or travel to and from the servicer. The items listed are not exclusive, but are for illustration only.) **ALL EXPRESS AND IMPLIED WARRANTIES, INCLUDING THE WARRANTY OF MERCHANTABILITY, ARE LIMITED TO THE PERIOD OF THE LIMITED WARRANTY.**

Some states do not allow the exclusion or limitation of incidental or consequential damages, or limitations on how long an implied warranty lasts, so the exclusions may not apply to you.

This warranty gives you specific legal rights and you may also have other rights, which vary, from state to state. If a problem with this product develops during or after the warranty period, you may contact your dealer or Servicenter. If the problem is not handled to your satisfaction, then write to the warrantor's Consumer Affairs Department at the addresses listed for the warrantor.

PARTS AND SERVICE (INCLUDING COST OF AN IN-HOME SERVICE CALL, WHERE APPLICABLE) WHICH ARE NOT COVERED BY THIS LIMITED WARRANTY ARE YOUR RESPONSIBILITY.

Limited Warranty (for Canada)

Panasonic Canada Inc.

PANASONIC PRODUCT – LIMITED WARRANTY

Panasonic Canada Inc. warrants this product to be free from defects in materials and workmanship and agrees to remedy any such defect for a period as stated below from the date of original purchase.

LCD Rear Projection TV	In home Service	Parts	Labour
		TV - One (1) year Original LIFI™ lamp unit - 5 years	1 Year

In-home Service will be carried out only to locations accessible by roads and within 50 km of an authorized Panasonic service facility.

LIMITATIONS AND EXCLUSIONS

This warranty does not apply to products purchased outside Canada or to any product which has been improperly installed, subjected to usage for which the product was not designed, misused or abused, damaged during shipping, or which has been altered or repaired in any way that affects the reliability or detracts from the performance, nor does it cover any product which is used commercially. Dry cell batteries are also excluded from coverage under this warranty. This warranty is extended to the original end user purchaser only. A purchase receipt or other proof of date of original purchase is required before warranty service is performed.

THIS EXPRESS, LIMITED WARRANTY IS IN LIEU OF ALL OTHER WARRANTIES, EXPRESS OR IMPLIED, INCLUDING ANY IMPLIED WARRANTIES OF MERCHANTABILITY AND FITNESS FOR A PARTICULAR PURPOSE.

IN NO EVENT WILL PANASONIC CANADA INC. BE LIABLE FOR ANY SPECIAL, INDIRECT OR CONSEQUENTIAL DAMAGES.

In certain instances, some jurisdictions do not allow the exclusion or limitation of incidental or consequential damages, or the exclusion of implied warranties, so the above limitations and exclusions may not be applicable.

WARRANTY SERVICE

For product operation and information assistance, please contact:

Our Customer Care Centre: Telephone #: (905) 624-5505
1-800 #: 1-800-561-5505
Fax #: (905) 238-2360
Email link: "Customer support" on www.panasonic.ca

FOR PRODUCT REPAIRS, please locate your nearest Authorized Servicentre at www.panasonic.ca :

Link : "Servicentres™ locator" under "Customer support"

IF YOU SHIP THE PRODUCT TO A SERVICENTRE

Carefully pack and send prepaid, adequately insured and preferably in the original carton.
Include details of the defect claimed, and proof of date of original purchase.

Index

1080i.....	23
1080p.....	23
480i.....	23
480p.....	23
720p.....	23

A

ASPECT button	9, 33
Automatic program setting.....	26
Auto shut off	24

B

Blocking Messages.....	45
Block program	43

C

Card Warning Messages.....	46
Channel and Program Tuning	30
Channel Lock (Block channel selection)	42
Channel up / down buttons.....	9, 10, 29
Cleaning	8
Closed Caption (CC)	51–52
Component signal input 1-2 terminals..	11
Connecting Antenna (To watch TV)	13
Connecting DVD recorder (VCR) (To record/playback).....	14–15
Connecting DVD recorder (VCR) and satellite receiver.....	16–17
Connecting Home Theater and DVD recorder.....	18
Connecting PC	19–20

D

Display the SUB MENU.....	31
DTV	30

E

EZ Sync™	34
EZ Sync™ “HDAVI Control™”	52–54
EZ Sync™ Connections	22

F

Favorite Feature	31
First Time Setup	25

G

Game Lock	43
-----------------	----

H

HDMI	23, 29, 39
HDMI input terminals	11

I

Input 1, 2, 3 terminals.....	10–11
Input labels	50
Insert/Remove the Card	46

J

JPEG	46–48
------------	-------

L

LAMP indicator	10, 61
Lock Set.....	42

M

Manual program setting.....	27
Monitor out.....	50
MPEG	41, 43
MUTE button	9, 30

N

NUMBER keys.....	9, 30
------------------	-------

P

Password.....	41–42, 45
PC Adjust.....	37
PC input terminal.....	11
PC position	29
Picture Mode	36
POWER button (Remote Control)	9, 24
POWER button / POWER indicator (Unit).....	10, 24, 61

R

R-TUNE button.....	9, 29
RECALL button.....	9, 30
Remote Control Sensor	10
Reset	55
Reset All Memory Functions.....	7
RGB cable	19

S

SAP button	9, 32
SD Card.....	46–48
Selecting Input Mode.....	29
Signal Meter	49
Sleep Timer	40
Sound mute	30
Surf Mode.....	49
SVGA.....	20
Switching languages for display	26
SXGA.....	20

T

TV/VIDEO button.....	9, 10
----------------------	-------

U

Unit Status Display	30
---------------------------	----

V

VGA.....	20
Viewing from a GalleryPlayer SD Card	48
Volume +/- buttons	9, 10, 29

W

WVGA.....	20
WXGA.....	20

X

XGA.....	20
----------	----

Z

Zoom Adjust	36
-------------------	----

Customer's Record

The serial number of this product can be found on its back cover. You should note this serial number in the space provided below and retain this book, plus your purchase receipt, as a permanent record of your purchase to aid in identification in the event of theft or loss, and for Warranty Service purposes.

Model Number

Serial Number

Panasonic Consumer Electronics Company,
Division of Panasonic Corporation of North America
One Panasonic Way, Secaucus, New Jersey 07094

Panasonic Sales Company ("PSC"), Division of
Panasonic Puerto Rico, Inc.
Ave. 65 de Infantería, Km. 9.5
San Gabriel Industrial Park, Carolina, Puerto Rico 00985

Panasonic Canada Inc.
5770 Ambler Drive,
Mississauga, Ontario L4W 2T3
(905) 624-5010
www.panasonic.ca

Printed in Indonesia
LSQT1225 B
S0407-1077

Free Manuals Download Website

<http://myh66.com>

<http://usermanuals.us>

<http://www.somanuals.com>

<http://www.4manuals.cc>

<http://www.manual-lib.com>

<http://www.404manual.com>

<http://www.luxmanual.com>

<http://aubethermostatmanual.com>

Golf course search by state

<http://golfingnear.com>

Email search by domain

<http://emailbydomain.com>

Auto manuals search

<http://auto.somanuals.com>

TV manuals search

<http://tv.somanuals.com>