

Operating Instructions

DLP™ Based Projector **Commercial Use**

Model No. **PT-D5600E**
PT-D5600EL
PT-DW5000E
PT-DW5000EL

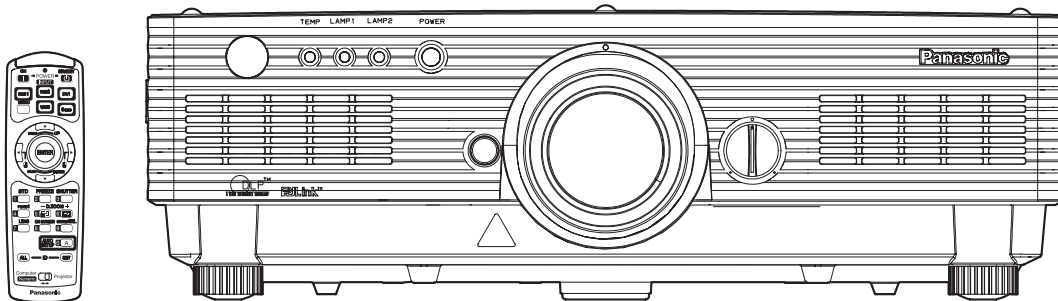

ENGLISH

DEUTSCH

FRANÇAIS

ESPAÑOL

ITALIANO

Read these instructions completely before operating this unit.

Dear Panasonic Customer:

This instruction booklet provides all the necessary operating information that you might require. We hope it will help you to get the most performance out of your new product, and that you will be pleased with your Panasonic DLP™ based projector.

The serial number of your product may be found on its back. You should note it in the space provided below and retain this booklet in case service is required.

Model number: **PT-D5600E/PT-D5600EL/PT-DW5000E/PT-DW5000EL**

Serial number:

IMPORTANT SAFETY NOTICE

WARNING: THIS APPARATUS MUST BE EARTHED.

WARNING: To prevent damage which may result in fire or shock hazard, do not expose this appliance to rain or moisture.

Machine Noise Information Ordinance 3. GSGV, January 18 1991: The sound pressure level at the operator position is equal or less than 70 dB (A) according to ISO 7779.

WARNING:



- 1) Remove the plug from the wall outlet when this unit is not in use for a prolonged period of time.
- 2) To prevent electric shock, do not remove cover. No user serviceable parts inside. Refer servicing to qualified service personnel.
- 3) Do not remove the earthing pin on the power plug. This apparatus is equipped with a three prong earthing-type power plug. This plug will only fit an earthing-type power outlet. This is a safety feature. If you are unable to insert the plug into the outlet, contact an electrician. Do not defeat the purpose of the earthing plug.

CAUTION:

To assure continued compliance, follow the attached installation instructions, which include using the shielded interface cables when connecting to a computer or peripheral device.

IMPORTANT: THE MOULDED PLUG (U.K. only)

FOR YOUR SAFETY, PLEASE READ THE FOLLOWING TEXT CAREFULLY.

This appliance is supplied with a moulded three pin mains plug for your safety and convenience. A 13 amp fuse is fitted in this plug. Should the fuse need to be replaced, please ensure that the replacement fuse has a rating of 13 amps and that it is approved by ASTA or BSI to BS1362. Check for the ASTA mark  or the BSI mark  on the body of the fuse.

If the plug contains a removable fuse cover, you must ensure that it is refitted when the fuse is replaced. If you lose the fuse cover, the plug must not be used until a replacement cover is obtained. A replacement fuse cover can be purchased from an Authorized Service Centre.

If the fitted moulded plug is unsuitable for the socket outlet in your home, then the fuse should be removed and the plug cut off and disposed of safely. There is a danger of severe electrical shock if the cut off plug is inserted into any 13 amp socket.

If a new plug is to be fitted, please observe the wiring code as shown below.
If in any doubt, please consult a qualified electrician.

WARNING: –THIS APPLIANCE MUST BE EARTHED.

IMPORTANT: –The wires in this mains lead are coloured in accordance with the following code: –

Green-and-Yellow:	Earth
Blue:	Neutral
Brown:	Live

As the colours of the wire in the mains lead of this appliance may not correspond with the coloured markings identifying the terminals in your plug, proceed as follows.

The wire which is coloured GREEN-AND-YELLOW must be connected to the terminal in the plug which is marked with the letter E or by the Earth symbol  or coloured GREEN or GREEN-AND-YELLOW.

The wire which is coloured BLUE must be connected to the terminal in the plug which is marked with the letter N or coloured BLACK.

The wire which is coloured BROWN must be connected to the terminal in the plug which is marked with the letter L or coloured RED.

How to replace the fuse. Open the fuse compartment with a screwdriver and replace the fuse.

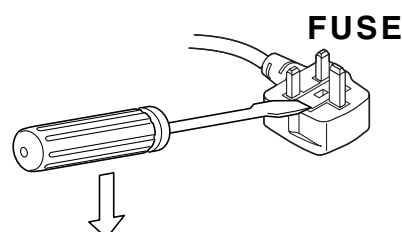

Contents

IMPORTANT SAFETY NOTICE	2
Precautions with regard to safety	5
Accessories	7
Precautions on handling	8
Name and function of parts	9
Remote control	9
Front and side of the projector	11
Rear view of the main unit/Controls on rear panel	12
Side-mounted connection terminals	13
Using the remote control unit	14
Loading dry cells	14
Effective range of remote control operation	14
Setting projector ID number to remote control	15
Using the remote control as a PC mouse.....	15
Using a wired remote control.....	16
Installation	16
Projection schemes	16
Installation geometry	16
Projection distances by projection lens	17
Calculation formulas for projection distance by lens types.....	19
Connection	20
Setup precautions	20
Example of connecting with AV products	21
Example of connecting with PCs	21
Projection	22
Powering up the projector	22
Making adjustment and selection	22
Powering off the projector	23
Direct power off function.....	23
How to install and remove the projection lens (optional)	24
How to install the projection lens	24
How to remove the projection lens	24
How to adjust the lens	24
How to adjust the lens focus, lens zoom and lens up/down position movement (optical shift)	24
How to adjust the lens position to the left or right.....	24
Automatic adjustment (AUTO SETUP)	25
Using the FREEZE function	25
Using the SHUTTER function	25
Using the digital zoom (- D.ZOOM +) function	25
On-screen menus	26
Structure of menu screens	26
Basic menu operations.....	27
Returning to the previous page	27
Menu items shown in transparent characters.....	27
Menu items setting	27
Resetting to the factory default.....	27
Adjusting the picture	28
PICTURE MODE	28
BRIGHT	28
CONTRAST	28
COLOR.....	28
TINT	28
COLOR TEMP.	28
WHITE GAIN	28
SHARPNESS	28
NR	28
AI	29
TV-SYSTEM.....	29
SYSTEM.....	29
Adjusting the position	29
POSITION	29
ASPECT	29
ZOOM.....	30
CLOCK PHASE.....	30
KEystone	30
How to use ADVANCED MENU	31
DIGITAL CINEMA REALITY	31
BLANKING	31
INPUT RESOLUTION	31
CLAMP POS.	31
RASTER POSITION.....	32
XGA MODE	32
SXGA MODE.....	32
Changing the display language	32
OPTION1 settings	33
COLOR CORRECTION	33
CONTRAST MODE	33
AUTO SIGNAL	33
BACK COLOR.....	33
SUB MEMORY LIST	33
DVI EDID	33
OPTION2 settings	34
ID	34
FRONT/REAR	34
DESK/CEILING	34
LAMP SELECT	34
LAMP POWER	34
RS232C	35
SYSTEM INFORMATION	35
FAN CONTROL1	35
FAN CONTROL2.....	35
FUNC1	35
AUTO POW.OFF.....	35
PASSWORD	35
Displaying the internal test pattern	36
Cycle of displayed internal test patterns.....	36
Setting the security	36
Setting the password.....	36
Changing the password.....	36
Setting the text	36
Changing the text	36
Setting the network	37
Connecting the PC	37
System requirements	37
Connection example.....	37
Using the serial terminals	38
Examples of connection	38
Pin assignments and signal names.....	38
Communication conditions (Factory setting)	38
Basic format	38
Control commands	39
Cable specifications	39
Using the Remote 2 terminal	39
Indication of lamp monitor	40
Cleaning and replacement of air filter	41
Procedure of cleaning	41
Replacing of lamp unit	42
Timing of lamp unit replacement	42
Lamp unit replacement steps	43
Using Web Browser Control	45
Accessing from the Web browser.....	45
Password change page	45
Basic control page	46
Detail control page	47
Monitor information page.....	47
Error information page.....	48
E-mail setup page	49
DNS server setup page	50
POP server setup page	51
Ping test page	51
Contents of mail sent.....	52
Adjust clock page	52
Network config page.....	53
Network status page.....	53
Using the PJLink™ protocol	54
Supported commands	54
PJLink™ security authentication	54
Before asking for service	55
Specifications	56
Compatible Signal List	58
Dimensions	59
Installation dimensions diagram	59

Precautions with regard to safety

WARNING

If a problem occurs (such as no image) or if you notice smoke or a strange smell coming from the projector, turn off the power and disconnect the power cord from the wall outlet.

- Do not continue to use the projector in such cases, otherwise fire or electric shocks could result.
- Check that no more smoke is coming out, and then contact an Authorized Service Centre for repairs.
- Do not attempt to repair the projector yourself, as this can be dangerous.

Do not install this projector in a place which is not strong enough to take the full weight of the projector.

- If the installation location is not strong enough, it may fall down or tip over, and severe injury or damage could result.
- Installation work (such as ceiling suspension) should only be carried out by a qualified technician.
- If installation is not carried out correctly, there is the danger that injury or electric shocks may occur.

If foreign objects or water get inside the projector, or if the projector is dropped or the cabinet is broken, turn off the power and disconnect the power cord from the wall outlet.

- Continued use of the projector in this condition may result in fire or electric shocks.
- Contact an Authorized Service Centre for repairs.

Do not cover the air filter, the air inlet and exhaust vents.

- Doing so may cause the projector to overheat, which can cause fire or damage to the projector.

Do not overload the wall outlet.

- If the power supply is overloaded (for example, by using too many adapters), overheating may occur and fire may result.

Do not remove the cover or modify it in any way.

- High voltages which can cause fire or electric shocks are present inside the projector.
- For any inspection, adjustment and repair work, please contact an Authorized Service Centre.

Use only the power cord supplied with the projector.

- Use only the supplied cord with three-pin plug and insert it only into a wall outlet that is connected to earth. Otherwise, electric shock could result.

Clean the power cord plug regularly to prevent it from becoming covered in dust.

- If dust builds up on the power cord plug, the resulting humidity can damage the insulation, which could result in fire. Pull the power cord out from the wall outlet and wipe it with a dry cloth.
- If not using the projector for an extended period of time, pull the power cord plug out from the wall outlet.

Do not do anything that might damage the power cord or the power cord plug.

- Do not damage the power cord, make any modifications to it, place it near any hot objects, bend it excessively, twist it, pull it, place heavy objects on top of it or wrap it into a bundle.
- If the power cord is used while damaged, electric shocks, short-circuits or fire may result.
- Ask an Authorized Service Centre to carry out any repairs to the power cord that might be necessary.

Do not handle the power cord plug with wet hands.

- Failure to observe this may result in electric shocks.

Insert the power cord plug securely into the wall outlet.

- If the plug is not inserted correctly, electric shocks or overheating could result.
- Do not use plugs which are damaged or wall outlets which are coming loose from the wall.

Do not place the projector on top of surfaces which are unstable.

- If the projector is placed on top of a surface which is sloped or unstable, it may fall down or tip over, and injury or damage could result.

Do not place the projector into water or let it become wet.

- Failure to observe this may result in fire or electric shocks.

Do not disassemble the lamp unit.

- If the lamp section breaks, it may cause injury.
- The lamp unit has high internal pressure. If improperly handled, explosion might result.
- The lamp unit can easily become damaged if struck against hard objects or dropped, and injury or malfunctions may result.

Precautions with regard to safety

Do not place liquid containers on top of the projector.

- If water spills onto the projector or gets inside it, fire or electric shocks could result.
- If any water gets inside the projector, contact an Authorized Service Centre.

Do not insert any foreign objects into the projector.

- Do not insert any metal objects or flammable objects into the projector or drop them onto the projector, as doing so can result in fire or electric shocks.

After removing the battery from remote control unit, keep it away from the reach of children.

- The battery can cause death by suffocation if swallowed.
- If the battery is swallowed, seek medical advice immediately.

Do not allow the + and - terminals of the battery to come into contact with metallic objects such as necklaces or hairpins.

- Failure to observe this may cause the battery to leak, overheat, explode or catch fire.
- Store the battery in a plastic bag and keep it away from metallic objects.

Before replacing the lamp unit, be absolutely sure to disconnect the power plug from the power outlet.

- Otherwise, electric shocks and/or damage may result.

When replacing the lamp, allow it to cool for at least one hour before handling it.

Do not bring your hands or other objects close to the air outlet port.

- Heated air comes out of the air outlet port. Do not place your hands or face, or objects which cannot withstand heat close to this port [allow at least 50 cm of space], otherwise burns or damage could result.

Do not suspend the projector using only the hole used for the anti-theft clasp.

- The projector may fall or sustain damage, and possibly result in injury.

Caution

Do not set up the projector in humid or dusty places or in places where the projector may come into contact with smoke or steam.

- Using the projector under such conditions may result in fire or electric shocks.

When disconnecting the power cord, hold the plug, not the cord.

- If the power cord itself is pulled, the cord will become damaged, and fire, short-circuits or serious electric shocks may result.

Always disconnect all cables before moving the projector.

- Moving the projector with cables still attached can damage the cables, which could cause fire or electric shocks to occur.

Do not place objects or other projectors on top of this unit.

- The objects or projectors may lose their balance or fall off, causing possible injury. Further, stacking one projector directly on top of another may cause the projectors to become deformed, resulting in possible malfunctioning.

Do not short-circuit, heat or disassemble the battery or place it into water or fire.

- Failure to observe this may cause the battery to overheat, leak, explode or catch fire, and burns or other injury may result.

When inserting the battery, make sure the polarities (+ and -) are correct.

- If the battery is inserted incorrectly, it may explode or leak, and fire, injury or contamination of the battery compartment and surrounding area may result.
- Do not use a new battery together with an old battery.
- Remove the batteries if you are not going to use the projector for a prolonged period of time.

Use only the specified battery.

- If incorrect batteries are used, they may explode or leak, and fire, injury or contamination of the battery compartment and surrounding area may result.

Do not look into the lens while the projector is being used.

- Strong light is emitted from the projector's lens. If you look directly into this light, it can hurt and damage your eyes.

Do not place your skin into the light beam while the projector is being used.

- Strong light is emitted from the projector's lens. If you place directly into this light, it can hurt or damage your skin.

Do not use the old lamp unit.

- The lamp section may break.

If the lamp has broken, ventilate the room immediately. Do not touch or bring your face close to the broken pieces.

- Failure to observe this may cause the user to absorb the gas which was released when the lamp broke and which contains nearly the same amount of mercury as fluorescent lamps, and the broken pieces may cause injury.
- If you believe that you have absorbed the gas or that the gas has got into your eyes or mouth, seek medical advice immediately.
- Ask your dealer to replace the lamp unit and check the inside of the projector.

Disconnect the power cord plug from the wall outlet as a safety precaution before carrying out any cleaning.

- Electric shocks can result if this is not done.

Ask an Authorized Service Centre to clean inside the projector at least once a year.

- If dust is left to build up inside the projector without being cleaned out, it can result in fire or problems with operation.
- It is a good idea to clean the inside of the projector before the season for humid weather arrives. Ask your nearest Authorized Service Centre to clean the projector when required. Please discuss with the Authorized Service Centre regarding cleaning costs.

Do not reach for the openings beside the optical lens, during horizontal or vertical movements of the lens there is a injury hazard.

Indication based on the German law "Geräte - und Produktsicherheitsgesetz"

- Directive 2001/95/EC (Article5); Panasonic Marketing Europe GmbH Hagenauer Str.43 65203 Wiesbaden F.R.GERMANY

Accessories

Check that all of the accessories shown below have been included with your projector.

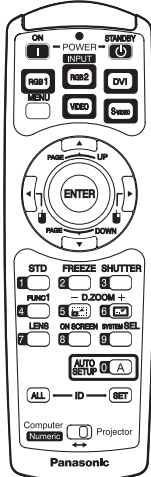
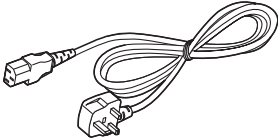
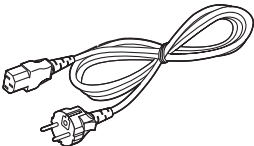
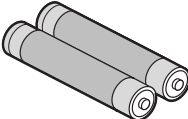
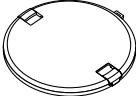
<p>Remote control unit [N2QAYA000005 x 1]</p> 	<p>Power cord for U.K. [K2CT3FZ00003 x 1]</p>  <p>for Continental [K2CM3FZ00003 x 1]</p> 	<p>Battery for remote control unit [R03NW/2ST x 1]</p> 	<p>Lens cover [TKKL5244-1 x 1]</p> 
---	---	---	--

Precautions on handling

■ Precautions on transport

Make absolutely sure that the lens cap is in place when transporting the projector or carrying it around. Both the projector and the projection lens are precision-made and, as such, are susceptible to vibration and impacts. When transporting the projector and lens or carrying them around, place them in the boxes in which they were housed at the time of purchase, and take care to keep them away from vibration and impacts.

■ Precautions on installation

Be sure to observe the following precautions when installing the product.

- **Avoid installing the product in a place exposed to vibrations or impacts.**

If the projector is installed in a place where vibrations are transmitted from a source of driving power and others or mounted in a car or a vessel, vibrations or impacts may be transmitted to the product to damage the internal parts, causing failure. Install the product in a place free from vibrations and impacts.

- **Do not move the projector while it is operating or subject it to vibration or impact.**

The service life of its internal motors may be shortened.

- **Do not install the projector near high-voltage power lines or power sources.**

The product may be exposed to interference if it is installed in the vicinity of high-voltage electrical power lines or power sources.

- **Do not place the projector on a vinyl sheet or carpet.**

If a vinyl sheet sucked up and blocks the air filter intake port, the internal temperature of the projector may increase, which triggers the protection circuit, turning off the power.

- **Be sure to ask a specialized technician when to install the product to a ceiling.**

If the product is to be installed hanging from the ceiling, purchase an optional hanging attachment (for high ceiling: Model No. ET-PKD55) (for low ceiling: Model No. ET-PKD55S) and call a specialized technician for installation.

- **Install the projector so that it will be supported only by its bottom panel and by none of its other parts or surfaces.**

- **Do not place the projector over 2 700 m above sea level. When using it over 1 400 m above sea level, set the "Fan Control1", described on page 35, to "HIGHLAND".**

Otherwise the life of the product may be shortened. When using it over 2 700 m above sea level, consult your dealer.

■ Disposal

To discard the product, call the dealer or a specialized dealer.

■ Precautions on use

- **To view clear images:**

- The audience cannot enjoy high-contrast and clear images if outside light or the illumination interferes the screen surface. Draw window curtains or blinds, turn off the lightings near the screen or take other proper measures.
- In rare cases, wafture can occur on the screen affected by the warm air from the exhaust port depending on the environment.

- **Do not touch the surface of the projection lens with bare hand.**

If fingerprints or stains are left on the projection lens surface, they are magnified and projected on the screen. Keep your hands away from the lens. Cover the lens with the supplied lens cap when the projector is not used.

- **Lamp**

A mercury lamp with high internal pressure is used for the light source of this product. A high-pressure mercury lamp has the following characteristics:

- It may burst with a loud sound or end its life cycle by not illuminating because of given impacts, flaws, or deterioration due to used hours.
- The life cycle of a mercury lamp varies according to the individual difference or conditions of use. In particular, turning the power on and off frequently and/or repeatedly will greatly affect the life cycle.
- In rare cases, it may burst shortly after the first lighting.
- The possibility of burst increases when the lamp is used beyond the replacement time.
- **If the projector is to be operated continuously round the clock, consult your dealer concerning the alternating lamp operation function (lamp changer function).**

Cleaning and maintenance

Be sure to remove the power cord plug from the receptacle before cleaning.

Use soft and dry cloth to clean the cabinet

If stains are hard to remove, use a cloth dampened with a kitchen detergent solution (neutral) and squeezed to wipe the cabinet and finish with a dry cloth. If a chemical wipe is used, follow its instructions.

Do not clean the lens surface with fuzzy or dusty cloth.

If dust adheres to the lens, it will be magnified and projected on the screen.

Use a soft and clean cloth to wipe off dust.

Name and function of parts

Remote control

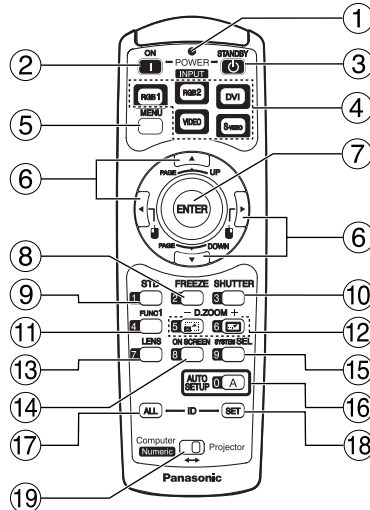

< When the operation mode selector ⑱ is set to Projector >

① Remote control operation indicator lamp

The lamp flashes when any remote control button is pressed.

② POWER ON (I) button (page 22)

Turns on the power if the MAIN POWER has been put to the "I" position.

③ POWER OFF (⏻) button (page 23)

Turns off the power if the MAIN POWER has been put to the "I" position.

④ Input selector (RGB1, RGB2, DVI, VIDEO, S-VIDEO) button

Use to toggle through the RGB1, RGB2, DVI-D, VIDEO and S-VIDEO input ports.

⑤ MENU button (page 27)

Displays and clears the Main Menu. It can also return to the previous screen when the menu is displayed.

⑥ Arrow ▲ ▼ ◀ ▶ buttons (page 27)

Use these buttons to select an item on the menu screen, change setting and adjust the level. Also use them to enter the "SECURITY" password.

⑦ ENTER button (page 27)

Press this button to enter your menu selection or to run function.

⑧ FREEZE button (page 25)

Press this button to freeze the image temporarily.

⑨ Standard (STD) button (page 27)

Press this button to restore the default factory setting.

⑩ SHUTTER button (page 25)

Press this button to black out the image temporarily.

⑪ Function 1 (FUNC1) button (page 35)

This button can control the functions set in "FUNC1" of the "OPTION2" screen from Main Menu.

⑫ Digital Zoom (- D.ZOOM +) buttons (page 25)

Any portion of the picture can be zoomed in.

⑬ LENS button (page 24)

Switches to the mode of projection lens adjustment.

⑭ ON SCREEN button

This button turns on and off the on-screen indication function.

⑮ SYSTEM SELECTOR button

Signal system switching (TV system/System) can be done.

⑯ AUTO SETUP button (page 25)

Pressing this button while projecting an image automatically corrects the picture positioning on the screen. While the auto setup feature is active, a message "AUTO SETUP..." appears on the screen.

⑰ ID ALL button (page 15)

When two or more main units are used in the system, this button switches to the mode to control them simultaneously with a single remote control.

⑱ ID SET button (page 15)

When two or more main units are used in the system, this button specifies the ID of the remote control.

⑲ Operation mode selector (Computer/Numeric, Projector) switch (page 15)

Put this selector to the right position to control the projector and to the left position to control the PC or use numeric buttons.

Name and function of parts

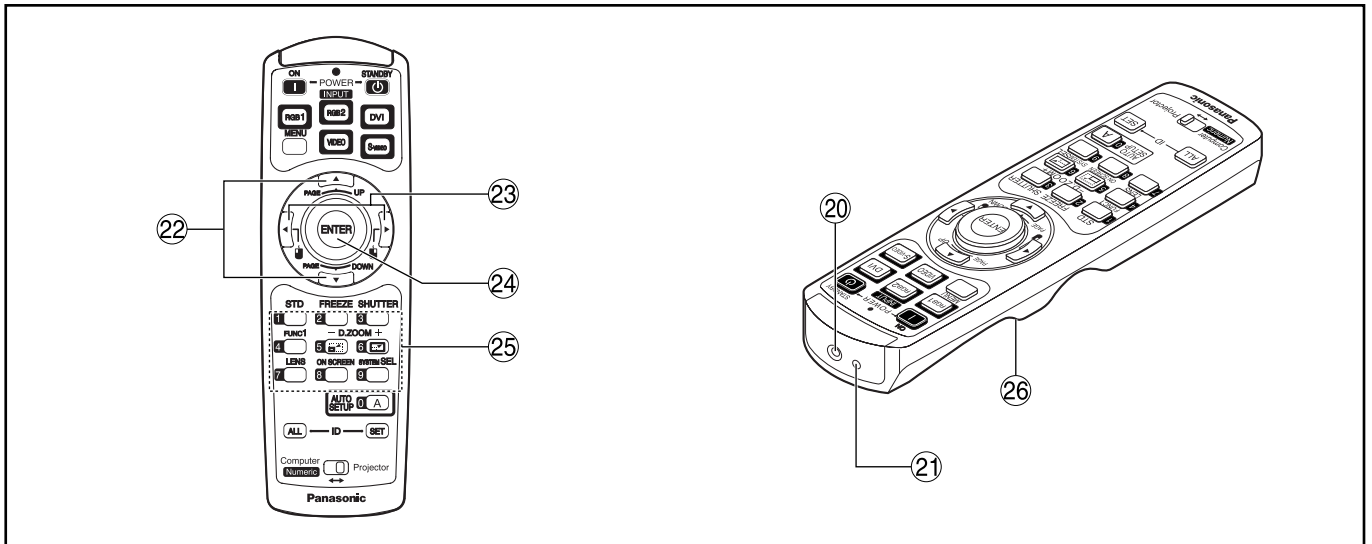

⑳ Remote control wired terminal (page 16)

To use the wired output terminal, connect the remote control and the main unit with the M3 stereo mini jack cable available in the market.

㉑ Remote control transmitter window

Operate the remote control aiming at the remote control receiver window on the main unit.

<When the operation mode selector ⑲ is set to Computer>

㉒ PAGE UP/PAGE DOWN buttons

These buttons correspond to the PAGE UP/PAGE DOWN buttons on PC's keyboard.

㉓ ⏪ ⏩ (◀ ▶) buttons

These buttons correspond to the left and right mouse buttons.

㉔ ENTER button

Moves the mouse cursor.

㉕ Numeric (0-9) buttons

In a system that uses a multiple number of projectors, these buttons serve to specify a particular projector.

They are also used to enter the password when the password for service personnel needs to be entered.

㉖ Click button (page 15)

This button corresponds to the left mouse button when the operation mode is switched to the Computer position.

Note • To use the remote control as a mouse, please purchase an optional wireless mouse receiver (model No.: ET-RMRC2).

Front and side of the projector

Side-mounted connection terminals (page 13)

Status LED lights (Refer to the figure on the right.)

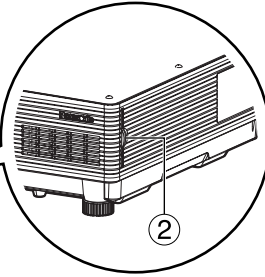
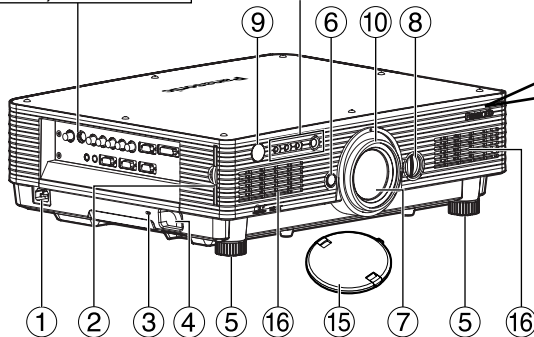

Status LED lights

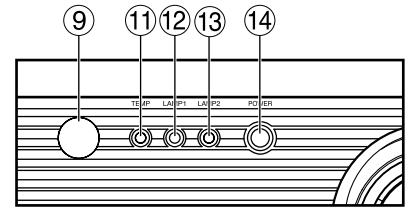

① AC IN terminal (page 22)

Connect the supplied line power cord into this receptacle.

Do not connect any other cable to this socket.

② Air filter (page 41)

③ Burglar lock

Attach a commercial burglar prevention cable (e.g., from Kensington) to this lock port. It is compatible with the Microsaver Security System from Kensington. Contact details for this company are given below.

Kensington Technology Group ACCO Brands Inc.
2885 Campus Drive San Mateo, CA94403
Tel (650)572-2700
Fax (650)572-9675
<http://www.kensington.com/>
<http://www.gravis.com/>

④ Clasp for attaching anti-theft chain

Attach a chain or other fastening device available from a hardware store through this clamp.

⑤ Level-adjusting feet (page 22)

Use these feet to adjust the tilt of the projector. (The leveling feet at the front left and right can be adjusted.)

⑥ Lens lock button (page 24)

Press this to remove the projection lens.

⑦ Projection lens

Lens for projecting images on the screen.

⑧ Lens left/right adjusting dial (page 24)

Turn this clockwise to move the screen to the left; conversely, turn it counterclockwise to move it to the right.

⑨ Remote control receiver window (front) (page 14)

This window receives the signal beam emitted from the remote control.

⑩ Focus ring (page 24)

For focus adjustment.

Powered focus adjustment is also available.

⑪ Temperature monitor (TEMP) (page 40)

Lighting or blinking of this lamp indicates an abnormal condition of the internal temperature.

⑫ LAMP1 monitor (page 40)

This lamp lights up when the time to replace lamp unit 1 is reached. It also blinks if something unusual occurs in the lamp circuit.

⑬ LAMP2 monitor (page 40)

This lamp lights up when the time to replace lamp unit 2 is reached. It also blinks if something unusual occurs in the lamp circuit.

⑭ Power indicator (page 22)

The lamp lights in red when the MAIN POWER switch is turned to "I" (on). It turns to green when the POWER ON button of the remote control or the main unit is pressed.

⑮ Lens cap

Cap the lens whenever the projector is left unused.

⑯ Ventilation holes

Attention • Do not remove the upper cover (white top panel).

Name and function of parts

Rear view of the main unit

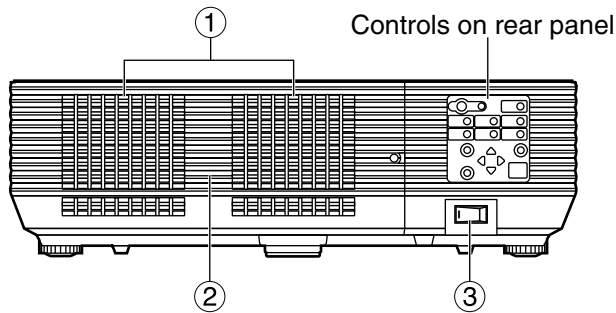

Controls on rear panel

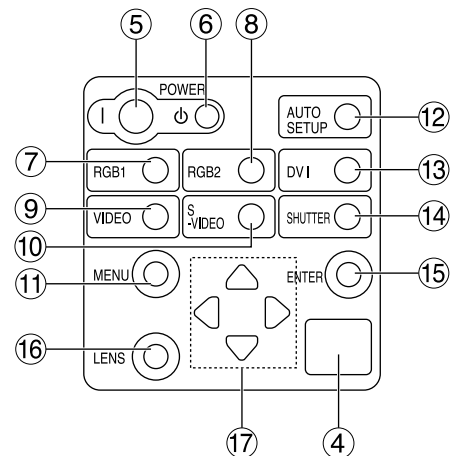

- ① **Ventilation holes**
- ② **Lamp unit cover**
The lamp unit is housed.
- ③ **MAIN POWER switch (page 22)**
Use this switch to turn on "I" and off "O" the main power applied to the projector.
- ④ **Remote control receiver window (rear) (page 14)**
This also receives the signal beam coming from the remote control.
- ⑤ **POWER ON (I) button (page 22)**
Turns on the power.
- ⑥ **POWER OFF (⏻) button (page 23)**
Turns off the power.
- ⑦ **RGB1 button (page 22)**
Switches to RGB1 input.
- ⑧ **RGB2 button (page 22)**
Switches to RGB2 input.
- ⑨ **VIDEO button (page 22)**
Switches to video input.
- ⑩ **S-VIDEO button (page 22)**
Switches to S-VIDEO input.
- ⑪ **MENU button (page 27)**
Displays and clears the Main Menu. It can also return to the previous screen when the menu is displayed.
The on-screen display (OSD) selection menu can be displayed by holding down the menu key for at least three seconds.
- ⑫ **AUTO SETUP button (page 25)**
Pressing this button while projecting an image automatically corrects the picture positioning on the screen.
- ⑬ **DVI button (page 22)**
Switches to DVI-D input.
- ⑭ **SHUTTER button (page 25)**
Press this button to black out the image temporarily.
- ⑮ **ENTER button (page 27)**
Press this button to enter your menu selection or to run function.
- ⑯ **LENS button (page 24)**
Switches to the adjustment mode for lens focus, zoom and shift (position).
- ⑰ **Arrow (▲ ▼ ◀ ▶) buttons (page 27)**
Use to select an item on the menu screen, change setting and adjust the level.
Also use them to enter the "SECURITY" password.

Side-mounted connection terminals

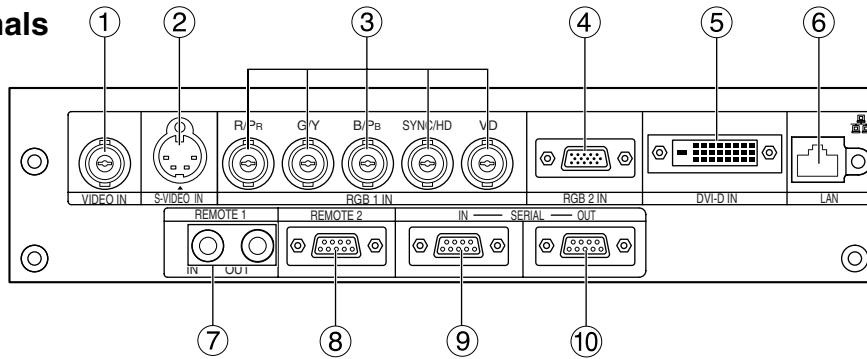

- ① **VIDEO IN terminal (page 21)**
An input terminal for video signals. (BNC)
- ② **S-VIDEO IN terminal (page 21)**
An input terminal for S-video signals. (MIN4-pin DIN)
This terminal complies with S1 signals and automatically toggles between 16:9 and 4:3 according to the size of input signals.
- ③ **RGB 1 input (RGB 1 IN) terminal (page 21)**
A terminal to input RGB or YPBPR signals. (BNC)
- ④ **RGB 2 input (RGB 2 IN) terminal (page 21)**
A terminal to input RGB or YPBPR signals. (D-SUB 15-pin female)
- ⑤ **DVI-D IN terminal (page 21)**
DVI-D signals are applied to this terminal. (24-pin DVI connector)
- ⑥ **LAN terminal (page 37)**
This terminal is used to control the projector from the PC. (10Base-T/100Base-TX compliant)
- ⑦ **REMOTE1 IN/OUT terminal (page 16)**
When two or more main units are used in the system, they can be connected and controlled with M3 stereo mini jack cable available in the market.
- ⑧ **REMOTE2 IN terminal**
The user can remotely control the main unit by using an external control circuit to this terminal. (D-SUB 9-pin female)
- ⑨ **SERIAL IN terminal (pages 21, 38)**
Use the RS232C serial terminal as an alternative interface for controlling the projector from your PC. (D-SUB 9-pin female)
- ⑩ **SERIAL OUT terminal (pages 21, 38)**
The signal applied to the serial input terminal appears at this terminal. (D-SUB 9-pin male)

LAN terminal (10Base-T/100Base-TX)

Connect LAN cable.

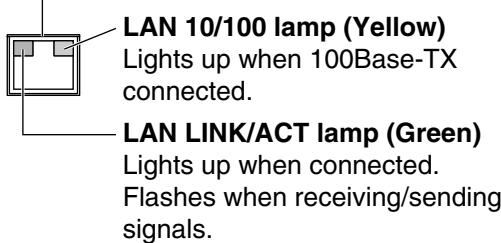

Using the remote control unit

■ Loading dry cells

When loading batteries into the battery compartment of the remote control, make sure that their polarities are correct.

1. Open battery compartment lid.

Open the lid in the order of steps ① and ②.

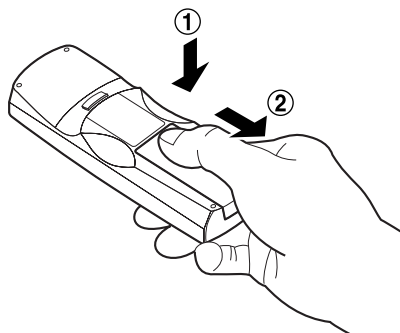

2. Insert the dry cells.

Into battery compartment, with their polarities orientated as indicated (+, -) in the compartment.

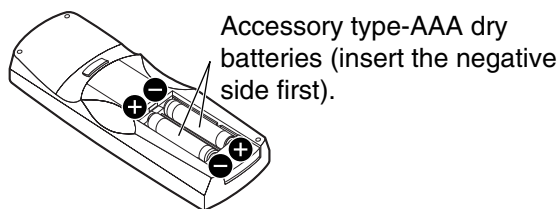

3. Close the battery compartment lid.

Replace the battery compartment lid over the compartment and slide until it clicks.

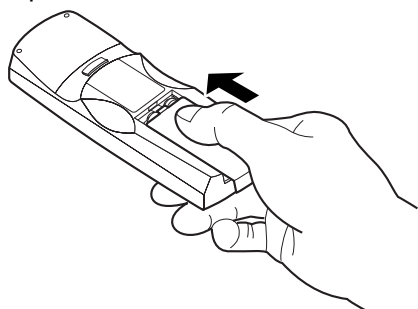

- Attention**
- Do not drop the remote control unit.
 - Do not expose remote control unit to any liquid.
 - Do not use NiCd batteries.

■ Effective range of remote control operation

The remote control should normally be aimed at either the front or rear remote control receiver window on the projector (figure 1). Otherwise, it may also be aimed at the screen, which will reflect commands back to the projector's front receiver window as illustrated in figure 2.

The effective control range is approx. 7 metres from the beam receiver on the front or rear.

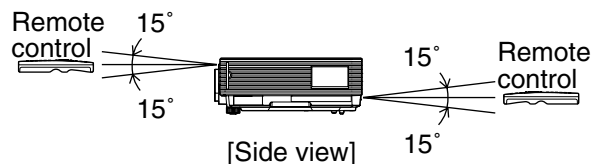
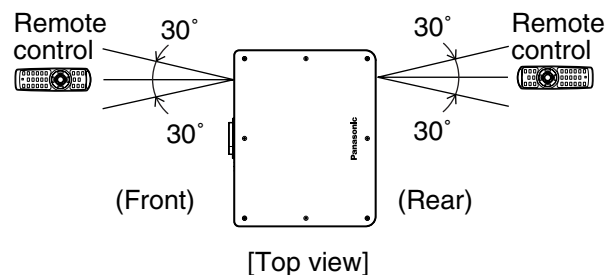

Figure 1

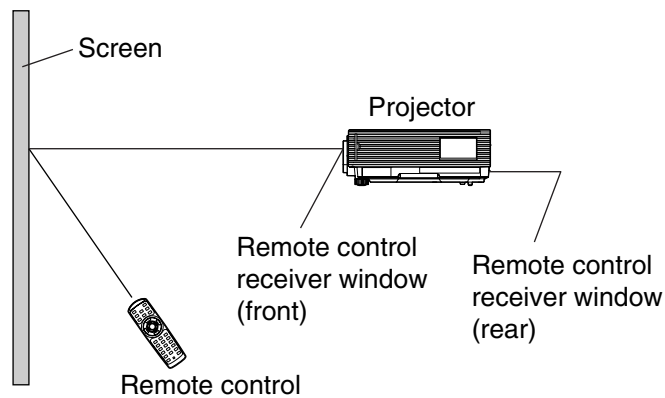

Figure 2

- Note**
- When the remote control is aimed at the screen, the effective control range may be reduced due to the optical loss by screen reflection.
 - The remote control may not function properly if an object is in the light path.
 - The remote control receiver may not function properly in intense ambient light such as fluorescent lamps. Carefully site the projector so its remote control receiver windows will not be directly exposed to intense light.

■ Setting projector ID number to remote control

Every projector has its ID number and the ID number of the controlling projector must be set to the remote control in advance so that the user can operate the remote control. **The ID number of the projector is set to "ALL" on shipping, and use the ID ALL button of the remote control when using only a single projector.**

Procedure of ID setting

- ① Change the position of the operation mode selector switch to "Computer".
- ② Press the ID SET button, and within five seconds use the number (0 to 9) buttons to enter the 2-digit ID number set by the projector.
- ③ Change the position of the operation mode selector switch to "Projector".

However, if the ID ALL button is pressed, the projector can be controlled regardless of the ID number of the projector (simultaneous control mode).

- Attention**
- Do not press the ID SET button accidentally or carelessly because the ID number on the remote control can be set even when no projector is around. If the ID SET button is pressed, the ID number goes back to the one set before pressing the ID SET button unless a numeric button is pressed within five seconds after the ID SET button is pressed.
 - Your specified ID number is stored in the remote control unit unless another one is specified later. However, the stored ID will be erased if the batteries of the remote control are left exhausted. When the dry cells are replaced, set the same ID number again.
 - When specifying the ID number, enter a 2-digit number even if the ID has only one digit. (Example: set "02" if the ID number is "2.")

■ Using the remote control as a PC mouse

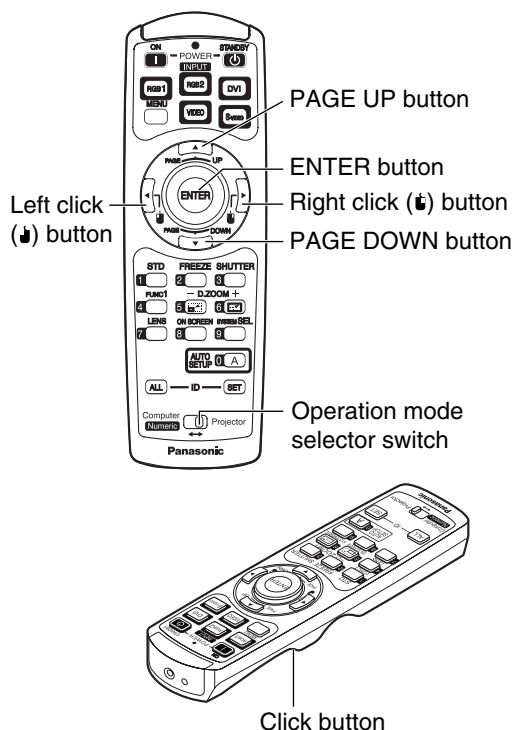

Operation mode selector switch

Put the knob to the Computer position.

- **ENTER button**
Pressing the front, rear, left and right edges of the button moves the mouse cursor up, down, left and right.
- **Right click (right arrow) button**
This button can be used as the right mouse button.
- **Left click (left arrow) button**
This button can be used as the left mouse button.
- **PAGE UP button**
This button can be used as the Page Up button on the PC keyboard.
- **PAGE DOWN button**
This button can be used as the Page Down button on the PC keyboard.
- **Click button**
This button can be used as the left mouse button.

- Note**
- To use the remote control as a mouse, please purchase an optional wireless mouse receiver (model No.: ET-RMRC2).

Using the remote control unit

■ Using a wired remote control

When multiple main units are connected in the system, connect the units with the M3 stereo mini jack cable available in the market to simultaneously control the multiple main units with a single remote control unit through the REMOTE1 IN/OUT terminal. It is effective to use the wired remote control in the environment in which an obstacle stands in the light path or where devices are susceptible to outside light.

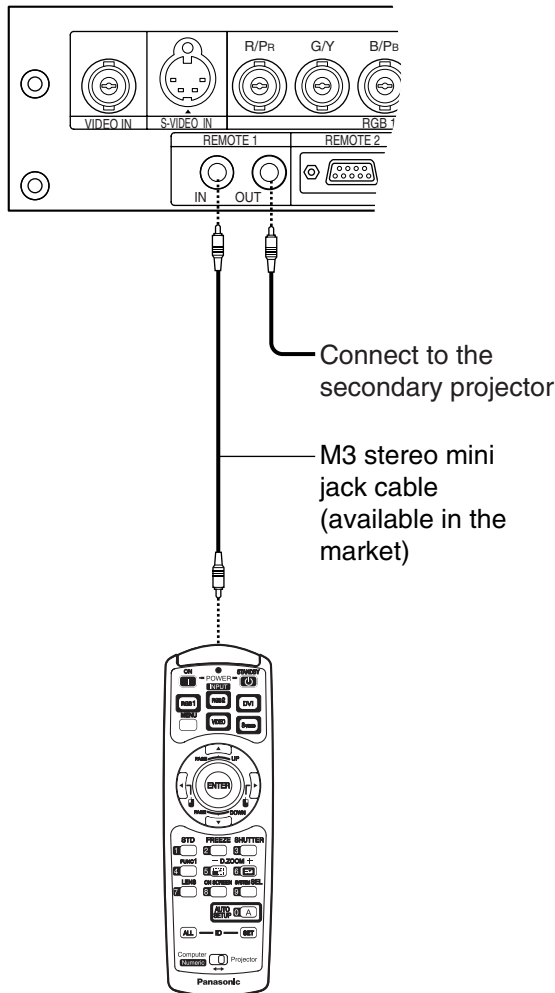

Attention • Use two-core shielded cable of length smaller than 15 m. If the cable length exceeds 15 m, or if the shielding of the cable is inadequate, the operation may be unsatisfactory.

Installation

■ Projection schemes

Any of the following four projection schemes can be used depending on user's needs or viewing conditions. Use "OPTION2" menu (chosen from the MAIN MENU) to choose the appropriate projection scheme (see page 34).

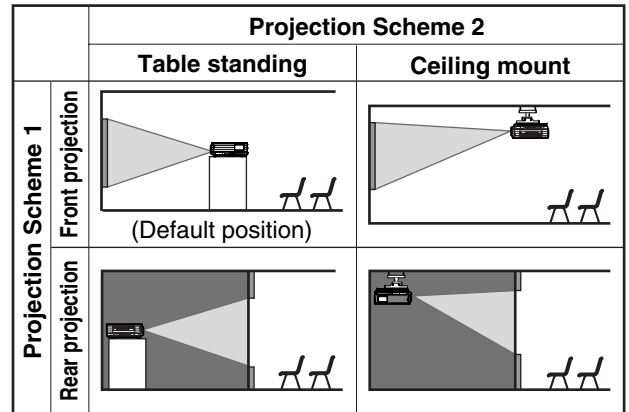

■ Installation geometry

After the projector is roughly positioned, picture size and vertical picture positioning can be finely adjusted with the powered zoom lens and lens tilt mechanism.

Side view

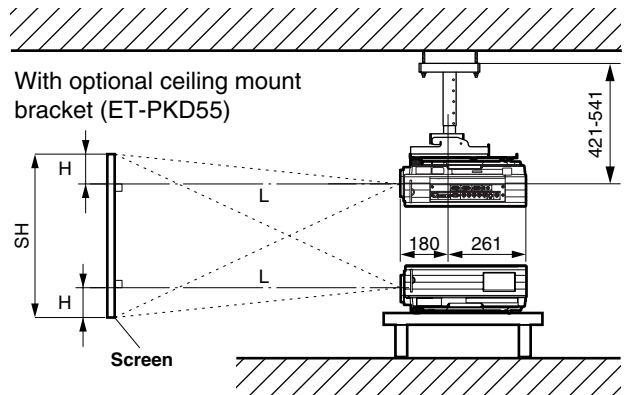

L : Projection distance
 SH : Image height
 SW : Image width
 H : Distance from centre of lens to bottom edge of projected image.

Top view

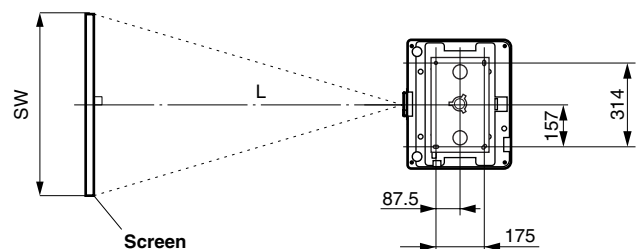

Attention • Do not place or use one projector on top of another projection unit.
 • Leave a clearance of at least 50 cm so that the ventilation opening on the rear panel will not be blocked.

■ Projection distance by projection lens

Listed in the table below are the lens projection distances for the PT-D5600E (lens included), PT-D5600EL (lens sold separately), PT-DW5000E (lens included) and PT-DW5000EL (lens sold separately).

- PT-D5600E, PT-D5600EL

Screen aspect ratio 4:3

Unit : m, (SD : inch)

Projected screen size (4:3 aspect ratio)			Standard zoom lens		Optional lens										Height position : H*
					Wide-angle fixed-focus lens	Wide-angle zoom lens	Intermediate focus zoom lens	Long-focus zoom lens	Ultra-long-focus zoom lens						
Diagonal length (SD)	Height (SH)	Width (SW)	(1.8-2.5)		(0.8)	(1.33 - 1.78)		(2.5 - 4.0)		(3.7 - 5.7)		(5.7 - 8.0)			
			Minimum (LW)	Maximum (LT)	(L)	Minimum (LW)	Maximum (LT)	Minimum (LW)	Maximum (LT)	Minimum (LW)	Maximum (LT)	Minimum (LW)	Maximum (LT)		
50	0.76	1.02	1.79	2.38	0.79	1.33	1.81	2.45	4.04	3.84	6.03	5.90	8.30	0 - 0.38	
60	0.91	1.22	2.16	2.86	0.96	1.61	2.18	2.96	4.87	4.63	7.26	7.08	9.94	0 - 0.46	
70	1.07	1.42	2.53	3.35	1.13	1.89	2.56	3.46	5.69	5.43	8.49	8.26	11.59	0 - 0.53	
80	1.22	1.63	2.90	3.84	1.29	2.16	2.93	3.97	6.52	6.22	9.73	9.43	13.23	0 - 0.61	
90	1.37	1.83	3.27	4.33	1.46	2.44	3.30	4.47	7.34	7.02	10.96	10.61	14.88	0 - 0.69	
100	1.52	2.03	3.64	4.82	1.62	2.71	3.67	4.97	8.16	7.81	12.19	11.78	16.53	0 - 0.76	
120	1.83	2.44	4.38	5.79	1.96	3.27	4.42	5.98	9.81	9.40	14.65	14.14	19.82	0 - 0.91	
150	2.29	3.05	5.49	7.26	2.45	4.09	5.53	7.49	12.28	11.79	18.35	17.66	24.76	0 - 1.14	
200	3.05	4.06	7.34	9.70	3.28	5.47	7.39	10.01	16.40	15.76	24.51	23.54	32.99	0 - 1.52	
250	3.81	5.08	9.19	12.14	—	6.85	9.25	12.53	20.52	19.74	30.67	29.42	41.22	0 - 1.91	
300	4.57	6.10	11.04	14.58	—	8.23	11.11	15.05	24.64	23.71	36.83	35.30	49.45	0 - 2.29	
350	5.33	7.11	12.89	17.02	—	9.61	12.97	17.57	28.76	27.69	42.99	41.18	57.68	0 - 2.67	
400	6.10	8.13	14.74	19.46	—	10.99	14.83	20.09	32.88	31.66	49.15	47.06	65.91	0 - 3.05	
500	7.62	10.16	18.44	24.34	—	13.75	18.55	25.13	41.12	39.61	61.47	58.82	82.37	0 - 3.81	
600	9.14	12.19	22.14	29.22	—	16.51	22.27	30.17	49.36	47.56	73.79	70.58	98.83	0 - 4.57	

Screen aspect ratio 16:9

Unit : m, (SD : inch)

Projected screen size (16:9 aspect ratio)			Standard zoom lens		Optional lens										Height position : H*
					Wide-angle fixed-focus lens	Wide-angle zoom lens	Intermediate focus zoom lens	Long-focus zoom lens	Ultra-long-focus zoom lens						
Diagonal length (SD)	Height (SH)	Width (SW)	(1.8-2.5)		(0.8)	(1.33 - 1.78)		(2.5 - 4.0)		(3.7 - 5.7)		(5.7 - 8.0)			
			Minimum (LW)	Maximum (LT)	(L)	Minimum (LW)	Maximum (LT)	Minimum (LW)	Maximum (LT)	Minimum (LW)	Maximum (LT)	Minimum (LW)	Maximum (LT)		
50	0.62	1.11	1.95	2.60	0.87	1.46	1.98	2.68	4.41	4.19	6.58	6.43	9.03	0 - 0.38	
60	0.75	1.33	2.35	3.13	1.05	1.76	2.38	3.23	5.31	5.06	7.92	7.71	10.82	0 - 0.46	
70	0.87	1.55	2.76	3.66	1.23	2.06	2.79	3.78	6.21	5.92	9.26	8.99	12.62	0 - 0.53	
80	1.00	1.77	3.16	4.19	1.41	2.36	3.19	4.33	7.11	6.79	10.61	10.27	14.41	0 - 0.61	
90	1.12	1.99	3.56	4.72	1.59	2.66	3.60	4.88	8.01	7.66	11.95	11.55	16.20	0 - 0.69	
100	1.25	2.21	3.97	5.26	1.77	2.96	4.00	5.42	8.90	8.52	13.29	12.83	18.00	0 - 0.76	
120	1.49	2.66	4.77	6.32	2.14	3.57	4.81	6.52	10.70	10.25	15.97	15.40	21.58	0 - 0.91	
150	1.87	3.32	5.98	7.92	2.68	4.47	6.03	8.17	13.39	12.85	20.00	19.24	26.96	0 - 1.14	
200	2.49	4.43	8.00	10.58	3.58	5.97	8.05	10.91	17.88	17.18	26.71	25.64	35.93	0 - 1.52	
250	3.11	5.53	10.01	13.24	—	7.48	10.08	13.66	22.37	21.51	33.42	32.05	44.89	0 - 1.91	
300	3.74	6.64	12.03	15.90	—	8.98	12.10	16.40	26.86	25.84	40.13	38.45	53.86	0 - 2.29	
350	4.36	7.75	14.04	18.56	—	10.49	14.13	19.15	31.35	30.17	46.84	44.86	62.82	0 - 2.67	
400	4.98	8.86	16.06	21.22	—	11.99	16.15	21.89	35.84	34.50	53.55	51.26	71.79	0 - 3.05	
500	6.23	11.07	20.09	26.54	—	15.00	20.20	27.38	44.82	43.16	66.97	64.07	89.72	0 - 3.81	
600	7.47	13.28	24.12	31.86	—	18.01	24.25	32.87	53.80	51.82	80.39	76.88	107.65	0 - 4.57	

※ The height position (H) of the ET-DLE050 is SH/2.

Installation

- PT-DW5000E, PT-DW5000EL

Screen aspect ratio 16:9

Unit : m, (SD : inch)

Projected screen size (16:9 aspect ratio)			Standard zoom lens		Optional lens										Height position : H*
					Wide-angle fixed-focus lens	Wide-angle zoom lens	Intermediate focus zoom lens	Long-focus zoom lens	Ultra-long-focus zoom lens						
Diagonal length (SD)	Height (SH)	Width (SW)	(1.8-2.5)		Model No. : ET-DLE050	Model No. : ET-DLE100		Model No. : ET-DLE200		Model No. : ET-DLE310		Model No. : ET-DLE410		Height position : H*	
			Minimum (LW)	Maximum (LT)	(0.8) (L)	Minimum (LW)	Maximum (LT)	Minimum (LW)	Maximum (LT)	Minimum (LW)	Maximum (LT)	Minimum (LW)	Maximum (LT)		
50	0.62	1.11	1.98	2.63	0.88	1.48	2.01	2.71	4.47	3.89	5.11	5.17	9.78	0 - 0.38	
60	0.75	1.33	2.39	3.17	1.06	1.78	2.42	3.27	5.38	4.69	6.15	6.23	11.76	0 - 0.46	
70	0.87	1.55	2.80	3.71	1.24	2.09	2.83	3.83	6.29	5.49	7.20	7.29	13.75	0 - 0.53	
80	1.00	1.77	3.21	4.25	1.43	2.39	3.24	4.38	7.20	6.29	8.24	8.35	15.73	0 - 0.61	
90	1.12	1.99	3.62	4.79	1.61	2.70	3.65	4.94	8.11	7.08	9.28	9.41	17.71	0 - 0.69	
100	1.25	2.21	4.03	5.33	1.79	3.00	4.06	5.49	9.02	7.88	10.32	10.47	19.69	0 - 0.76	
120	1.49	2.66	4.84	6.40	2.16	3.61	4.88	6.61	10.84	9.48	12.41	12.59	23.66	0 - 0.91	
150	1.87	3.32	6.07	8.02	2.71	4.53	6.12	8.27	13.57	11.88	15.54	15.78	29.61	0 - 1.14	
200	2.49	4.43	8.12	10.72	3.62	6.05	8.17	11.05	18.12	15.87	20.75	21.08	39.52	0 - 1.52	
250	3.11	5.53	10.16	13.41	—	7.58	10.23	13.83	22.67	19.87	25.97	26.39	49.44	0 - 1.91	
300	3.74	6.64	12.21	16.11	—	9.10	12.28	16.61	27.22	23.86	31.18	31.69	59.35	0 - 2.29	
350	4.36	7.75	14.25	18.80	—	10.63	14.34	19.39	31.77	27.86	36.40	37.00	69.27	0 - 2.67	
400	4.98	8.86	16.30	21.50	—	12.15	16.39	22.17	36.32	31.85	41.61	42.30	79.18	0 - 3.05	
500	6.23	11.07	20.39	26.89	—	15.20	20.50	27.73	45.42	39.84	52.04	52.91	99.01	0 - 3.81	
600	7.47	13.28	24.48	32.28	—	18.25	24.61	33.29	54.52	47.83	62.47	63.52	118.84	0 - 4.57	

※ The height position (H) of the ET-DLE050 is SH/2.

Note • Black bands will appear at the top and bottom of the screen.

■ Calculation formulas for projection distance by lens types

• PT-D5600E, PT-D5600EL

Screen aspect ratio 4:3

(L, LW, LT : m SD : inch)

Standard zoom lens		Minimum (LW)	$L=0.0370 \times SD-0.0650$
		Maximum (LT)	$L=0.0488 \times SD-0.0638$
Wide-angle fixed-focus lens	Model No. : ET-DLE050		$L=0.0166 \times SD-0.0361$
Wide-angle zoom lens	Model No. : ET-DLE100	Minimum (LW)	$L=0.0276 \times SD-0.0452$
		Maximum (LT)	$L=0.0372 \times SD-0.0478$
Intermediate-focus zoom lens	Model No. : ET-DLE200	Minimum (LW)	$L=0.0504 \times SD-0.0657$
		Maximum (LT)	$L=0.0824 \times SD-0.0758$
Long-focus zoom lens	Model No. : ET-DLE300	Minimum (LW)	$L=0.0795 \times SD-0.1380$
		Maximum (LT)	$L=0.1232 \times SD-0.1310$
Ultra-long-focus zoom lens	Model No. : ET-DLE400	Minimum (LW)	$L=0.1176 \times SD+0.0244$
		Maximum (LT)	$L=0.1646 \times SD+0.0651$

Screen aspect ratio 16:9

(L, LW, LT : m SD : inch)

Standard zoom lens		Minimum (LW)	$L=0.0403 \times SD-0.0650$
		Maximum (LT)	$L=0.0532 \times SD-0.0638$
Wide-angle fixed-focus lens	Model No. : ET-DLE050		$L=0.0181 \times SD-0.0361$
Wide-angle zoom lens	Model No. : ET-DLE100	Minimum (LW)	$L=0.0301 \times SD-0.0452$
		Maximum (LT)	$L=0.0405 \times SD-0.0478$
Intermediate-focus zoom lens	Model No. : ET-DLE200	Minimum (LW)	$L=0.0549 \times SD-0.0657$
		Maximum (LT)	$L=0.0898 \times SD-0.0758$
Long-focus zoom lens	Model No. : ET-DLE300	Minimum (LW)	$L=0.0866 \times SD-0.1380$
		Maximum (LT)	$L=0.1342 \times SD-0.1310$
Ultra-long-focus zoom lens	Model No. : ET-DLE400	Minimum (LW)	$L=0.1281 \times SD+0.0244$
		Maximum (LT)	$L=0.1793 \times SD+0.0651$

• PT-DW5000E, PT-DW5000EL

Screen aspect 16:9

(L, LW, LT : m SD : inch)

Standard zoom lens		Minimum (LW)	$L=0.0409 \times SD-0.0650$
		Maximum (LT)	$L=0.0539 \times SD-0.0638$
Wide-angle fixed-focus lens	Model No. : ET-DLE050		$L=0.0183 \times SD-0.0361$
Wide-angle zoom lens	Model No. : ET-DLE100	Minimum (LW)	$L=0.0305 \times SD-0.0452$
		Maximum (LT)	$L=0.0411 \times SD-0.0478$
Intermediate-focus zoom lens	Model No. : ET-DLE200	Minimum (LW)	$L=0.0556 \times SD-0.0657$
		Maximum (LT)	$L=0.0910 \times SD-0.0758$
Long-focus zoom lens	Model No. : ET-DLE310	Minimum (LW)	$L=0.0799 \times SD-0.1062$
		Maximum (LT)	$L=0.1043 \times SD-0.1056$
Ultra-long-focus zoom lens	Model No. : ET-DLE410	Minimum (LW)	$L=0.1061 \times SD-0.1374$
		Maximum (LT)	$L=0.1983 \times SD-0.1352$

Note

- The dimensions in the table in pages 17-18 and the values obtained from the above formulas may contain slight errors.
- When an SXGA signal is input and projected, the right and left ends of the picture will be blanked and the aspect ratio will be 5:4.
- The brightness is different between the wide lens position settings and telephoto lens position settings.

Connection

■ Setup precautions

- Before connecting any of your video/audio equipment to the projector, carefully read the owners manual supplied with the equipment once again.
- All cable connections should be made with the entire system devices, including the projector, first turned off.
- Obtain commercial interconnecting cables for devices supplied with no accessory or optional interconnect cables.
- Video signals containing too much jitter may cause the images on the screen to randomly wobble or shake. Inserting a time base corrector (TBC) in the projector's video line will relieve this problem.
- The projector only accepts composite-video, S-video, analogue-RGB (with TTL sync. level), and digital signal.
- Some PC models are not compatible with PT-D5600E/PT-D5600EL/PT-DW5000E/PT-DW5000EL projectors.

- The pin assignments on the S-VIDEO IN terminal are as follows:

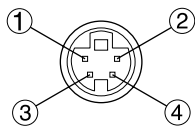

Viewed from mating side

Pin No.	Signal
①	Ground (luminance)
②	Ground (colour)
③	Luminance signal
④	Colour signal

- The pin assignments on the DVI-D input terminal are as follows (interface with DVI-D output terminal on PC):

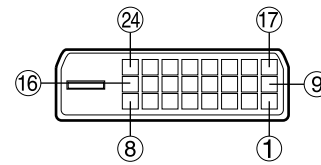

Viewed from mating side

Pin No.	Signal	Pin No.	Signal
①	T. M. D. S data 2-	⑬	—
②	T. M. D. S data 2+	⑭	+5 V
③	T. M. D. S data 2 shield	⑮	Ground
		⑯	Hot plug sense
④	—	⑰	T. M. D. S data 0-
⑤	—	⑱	T. M. D. S data 0+
⑥	DDC clock	⑲	T. M. D. S data 0 shield
⑦	DDC data		
⑧	—	⑳	—
⑨	T. M. D. S data 1-	㉑	—
⑩	T. M. D. S data 1+	㉒	T. M. D. S clock shield
⑪	T. M. D. S data 1 shield		
⑫	—	㉓	T. M. D. S clock+
		㉔	T. M. D. S clock-

- The pin assignments on the RGB2 input terminal are as follows:

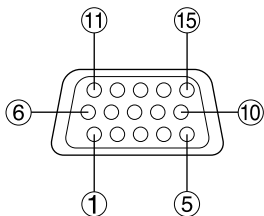

Viewed from mating side

Pin No.	Signal
①	R/P _R
②	G/G · SYNC/Y
③	B/P _B
⑬	HD/SYNC
⑭	VD

Pin ⑨ : Not used.

Pins ④ - ⑧, ⑩ and ⑪ : Ground.

- The DVI-D input terminal supports single link only.
- EDID settings should be performed to suit the DVI equipment being connected. (Page 33)
- The DVI-D input terminal can be used to connect to a DVI equipment, but note that images may not appear or the projector may not work properly when connected to certain DVI equipment.
- This projector supports HDCP.

■ Example of connecting with AV products

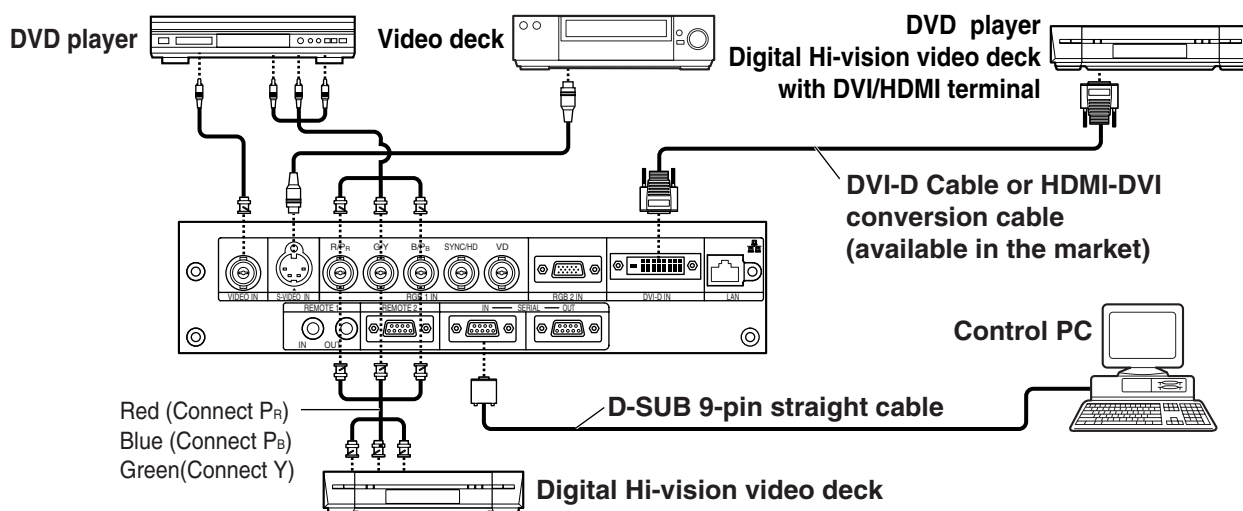

- Attention**
- When connecting with a video deck, be sure to use the one with a built-in time base corrector (TBC) or use a TBC between the projector and the video deck.
 - If nonstandard burst signals are connected, the image may be distorted. If this is the case, connect a TBC between the projector and the video deck.
 - The EDID settings suited to the equipment connected must be performed when DVI-D signals are input. (Refer to page 33.)

■ Example of connecting with PCs

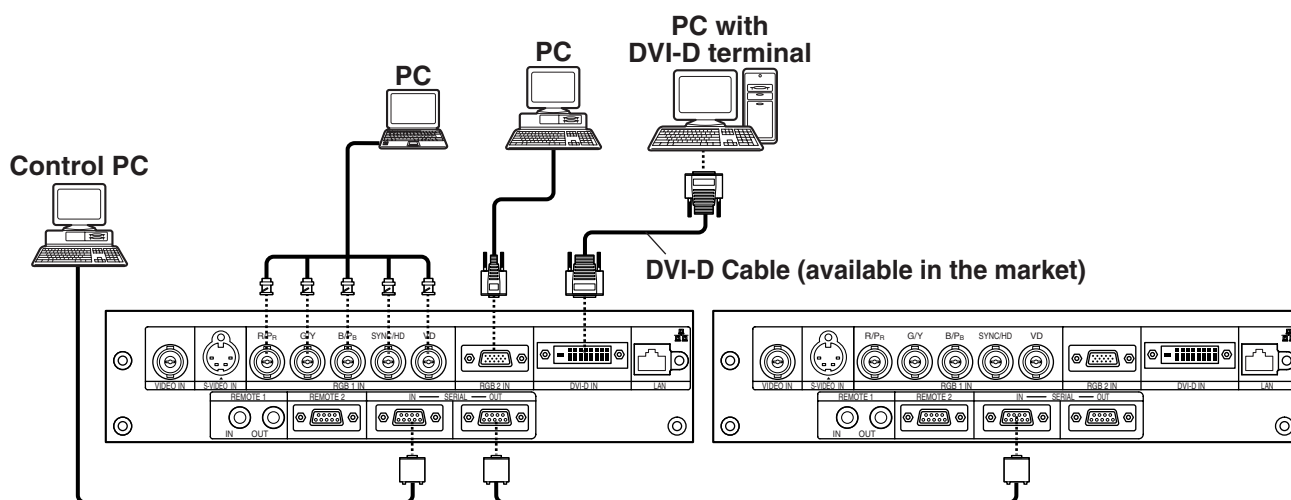

- Note**
- For the specifications of the RGB signals that can be applied from the PC, see the data sheet on page 58.
 - If your PC has the resume feature (last memory), the computer may not function properly until the resume capability is disabled.
 - When the SYNC ON GREEN signal is input, do not input sync signals to the SYNC/HD and VD terminals. Doing so may disrupt the images since, rather than using synchronization initiated by the GREEN signal, the sync signals of the SYNC/HD and VD terminals will be used instead. Even if the images are not disrupted, the white balance may be lost. If this is the case, select "USER" as the "COLOR TEMP." setting (see page 28), and adjust "W-BAL LOW".
 - The white balance may be lost when the SYNC ON RGB signal is input. If this is the case, select "USER" as the "COLOR TEMP." setting (see page 28), and adjust "W-BAL LOW".
 - The EDID settings suited to the equipment connected must be performed when DVI-D signals are input. (Refer to page 33.)

Projection

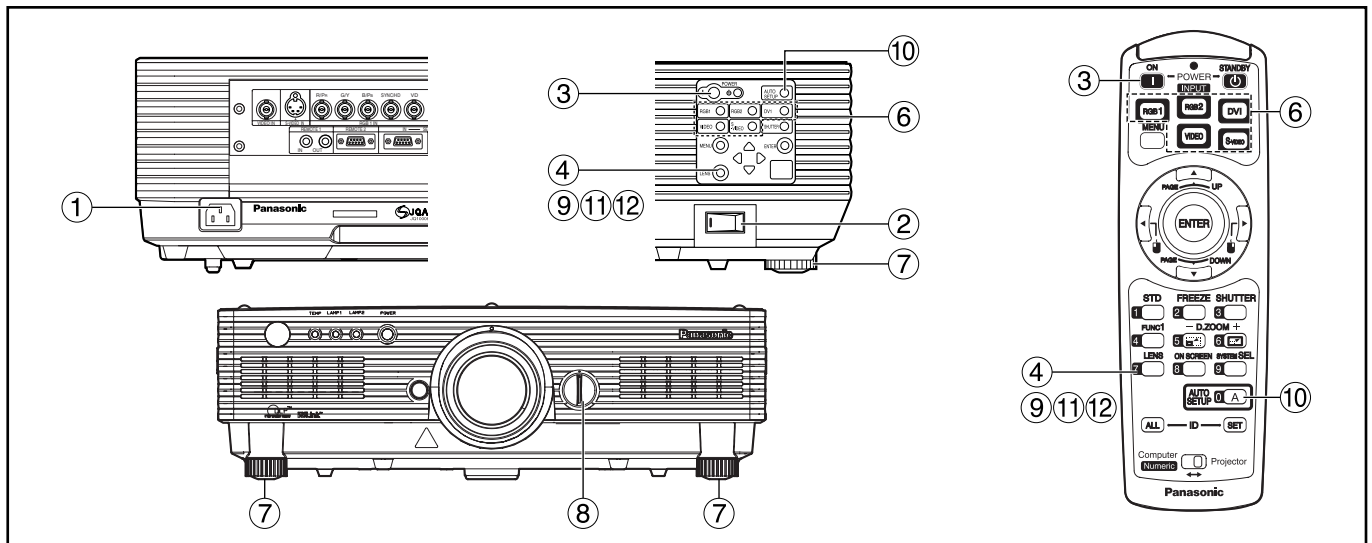

■ Powering up the projector

When using an optional lens, install a projection lens before powering up the projector. (Refer to page 24.)

Remove the lens cover beforehand.

- ① **Connect the supplied power cable. (220-240 V AC, 50 Hz/60 Hz)**
- ② **Press the “ I ” marked side of the MAIN POWER switch to turn on the power.**
The power indicator lights up red, and the projector is placed in the standby mode.
- ③ **Press the “ I ” button. [on the main unit or the remote control]**
The power indicator illuminates in green and soon the image is projected on the screen.

■ Making adjustment and selection

- ④ **Roughly adjust the focus of the lens. (Refer to page 24.)**
Press the LENS button on the main unit or the remote control unit to display a focus adjustment screen. Pressing ▲ ▼ buttons to adjust the image into focus.
- ⑤ **Select and set the projection scheme. (Refer to page 34.)**
- ⑥ **Select the input signal by pressing the input selector button to toggle through RGB1, RGB2, VIDEO, S-VIDEO and DVI. [on the main unit or the remote control]**
- ⑦ **Turn the feet, and adjust the tilt of the main unit in the front and rear or left and right.**
- ⑧ **Use the lens left/right adjustment dial to adjust the direction of the lens. (page 24)**



- ⑨ **Press the LENS button three times to adjust the lens shift. (Refer to page 24.)**
- ⑩ **Press the AUTO SETUP button if the input signal is RGB/DVI signal. (Refer to page 25.) [on the main unit or the remote control]**
- ⑪ **Fit the image size to the screen size.**
Press the LENS button twice and adjust the zoom of the lens on the lens zoom adjustment menu.
- ⑫ **Press the LENS button and adjust the focus of the lens on the lens focus adjustment menu.**
- ⑬ **Display the zoom adjustment menu again and adjust the zoom of the lens to fit the image size to the screen size. (Refer to page 24.)**

Note

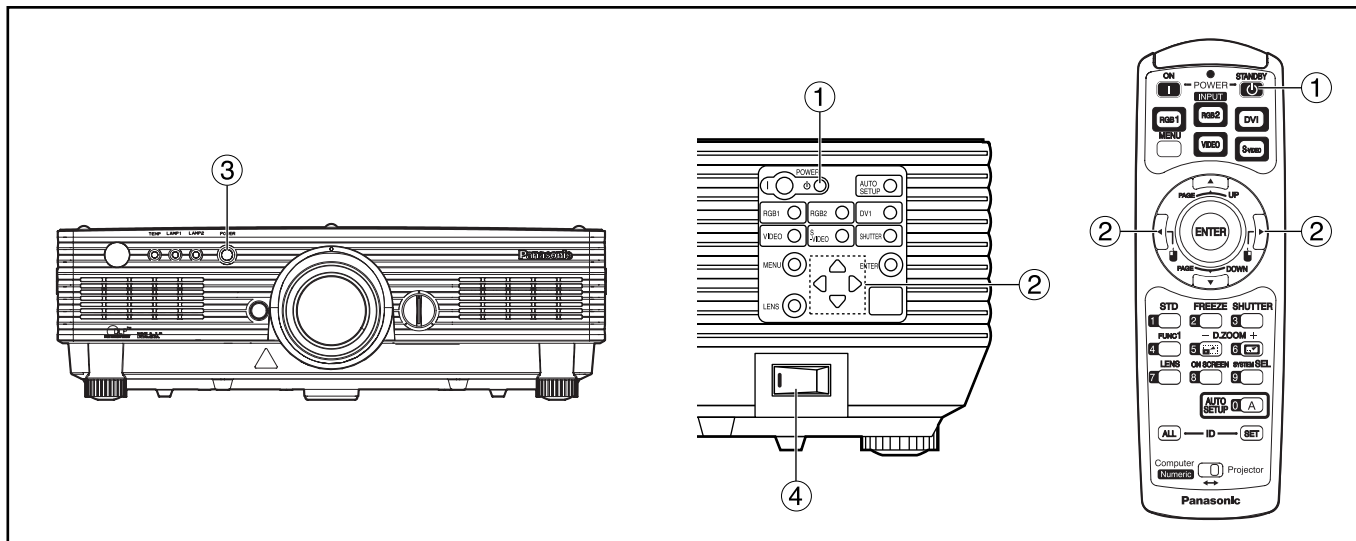
- If the projector is powered up at about 0 °C, a warm-up period of approximately five minutes may be necessary to start projection.
The temperature monitor (TEMP) lights during the warm-up period.
When the warm-up is completed, the temperature monitor (TEMP) turns off and the image is projected on the screen.
- If the surrounding temperature is very low and the warm-up period exceeds five minutes, the control determines it as an abnormal condition and turns off the power automatically. If this happens, raise the surrounding temperature to 0 °C or higher and then turn the main power “on” and turn the power “on” (|).
- It is recommended that the projector be allowed to warm up for at least 30 minutes before any adjustments are made to the focus.



■ Powering off the projector

- ① Press the POWER OFF “” button.
- ② Select “OK” with ◀ or ▶ button and press the ENTER button.
(or press the POWER OFF “” button again.)
The projection of the image stops, and the power indicator of the main unit lights up orange. (The cooling fan keeps running.)
- ③ Wait until the power indicator of the main unit turns to red (i.e., until the cooling fan stops).
- ④ Press the “○” marked side of the MAIN POWER switch to remove all power from the projector.

Attention • Do not turn the power supply off and then immediately back on again.
Turning on the power supply will not light up the light source lamp if the lamp is in the process of cooling down after turning off the power supply. To light up the lamp, turn on the power supply again when the lamp has been cooled sufficiently.
Turning on the power supply with the lamp in the hot condition may shorten the lamp life.

- Note**
- The projector consumes approximately 15 watts of power even in standby mode after the cooling fan stops. (Power indicator lit in red)
 - If you re-power the projector after shutting off the main power inadvertently, the projection lamp may remain unlit. Please turn the power on again after a while.

■ Direct power off function

The power supplied internally causes the cooling fan to continue operating and cool off in the event that the power has failed or even after the power cord is accidentally disconnected immediately after the power has been turned off.

- Note**
- When the lamp has been cooled by the direct power OFF function, it sometimes takes longer than usual for the lamp to light up again.
 - While the cooling fan is operating, do not place the projector inside a box or bag.
 - The operation time of the cooling fan will be less if fewer than 4 minutes have elapsed since the power was turned on.

How to install and remove the projection lens (optional)

■ How to install the projection lens

- ① Align the guide of the projection lens with the guide groove in the main unit.
- ② Turn the lens clockwise until it clicks into place.

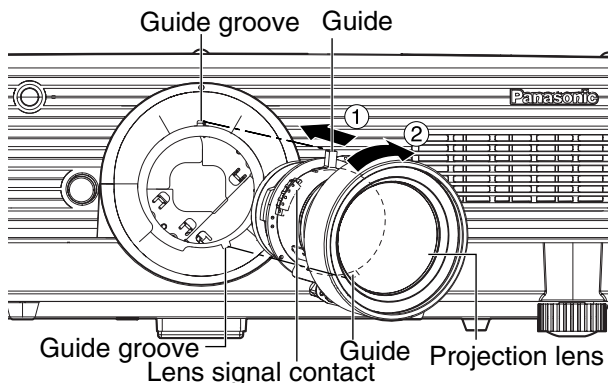

Attention • Turn the lens counterclockwise and confirm that the lens does not come off.

■ How to remove the projection lens

- ① Turn the lens counterclockwise as far as it will go.
- ② While holding down the lens lock button, turn the lens further counterclockwise.
- ③ Remove the lens.

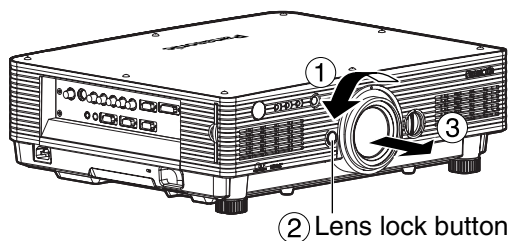

Note • Before replacing the lens, turn off the projector's power.
• Do not touch the lens signal contact. Dust or dirt may cause defective contact.
• Do not touch the surface of the projection lens with your bare hands.
• Store the replaced lens where it will be free from vibration and impact.

How to adjust the lens

■ How to adjust the lens focus, lens zoom and lens up/down position (optical shift)

The focus, zoom and up/down position of the images projected on the screen can be adjusted while the projector is positioned appropriately in relation to the screen.

- ① Press the LENS button on the remote control or on the control panel of the main unit.

Pressing the button changes the setup screen in the order of "LENS FOCUS", "LENS ZOOM" and "LENS SHIFT".

- ② Choose an item and adjust it using ▲ ▼ buttons.

Caution

Be careful not to catch your fingers between the lens and shroud when shifting the lens.

Note

- When a lens without zoom functions is used, the lens zoom adjustment menu will still displayed, but no operations can be performed using the items on this menu.
- By shifting the lens up/down position, it is possible to make adjustments upward or downward from the standard position in the direction of the upper 50 % of the projected screen height.
- Operations can be performed faster by holding down the ▲ ▼ buttons for about 3 or more seconds.

■ How to adjust the lens position to the left or right

When the lens left/right adjustment dial is turned clockwise, the screen moves toward the left; conversely, when it is turned counterclockwise, it moves toward the right. The maximum travel distance toward the left or right is 10 % of the projection screen width.

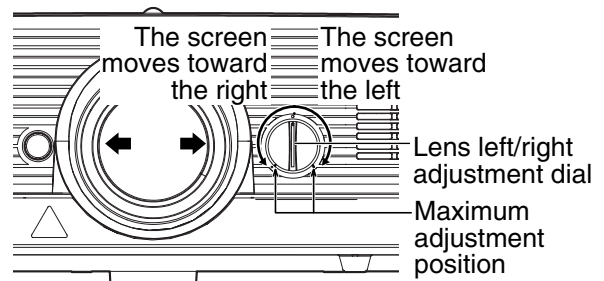

Attention • Move the lens left/right adjustment dial to any position up to the maximum adjustment position to make the adjustment. Turning the dial with undue force may cause malfunctioning.

Automatic adjustment (AUTO SETUP)

Automatic adjustment function adjust the resolution, clock phase and image position automatically when dots-structured analogue RGB signals such as computer signal are supplied. (Automatic adjustment is not available if moving picture input signals or signals having a dot clock frequency of more than 108 MHz are supplied.) When DVI signals are input, the image position is adjusted automatically.

It is recommended to supply images with a bright white frame at the outermost periphery containing characters etc. that are clear in white and black contrast when the system is in automatic adjustment mode. Avoid supplying images that involve halftones or gradation such as photographs and computer graphics.

Note

- “CLOCK PHASE” may have been shifted even when the adjustment ended normally. In this case, manually adjust the “CLOCK PHASE”.
- Automatic adjustments cannot be performed when images with blurred edges or dark images are input. With Composite sync and G-SYNC sync signals and some types of PCs, it may not be possible to perform these automatic adjustments. In this case, manually adjust the items of “INPUT RESOLUTION”, “CLOCK PHASE” and “POSITION”.
- Image may be disturbed for about 4 seconds during automatic adjustment, which is not an abnormal error.

Using the FREEZE function

The image on the screen displayed when you press the FREEZE button on the remote control is displayed as a still image until you press the FREEZE button again.

Using the SHUTTER function

If the projector is not going to be used for a certain period of time such as while a meeting is on a break or preparations are being made, the mechanical shutter can be used to hide the images temporarily.

① Press the “SHUTTER” button of the remote control or the main unit.

The image is turned off.

② Press the “SHUTTER” button again.

The image comes back.

Using the digital zoom (– D.ZOOM +) function

A portion of the picture on the screen can be zoomed in with “– D.ZOOM +” buttons of the remote control. It is useful for highlighting a specific object during the presentation.

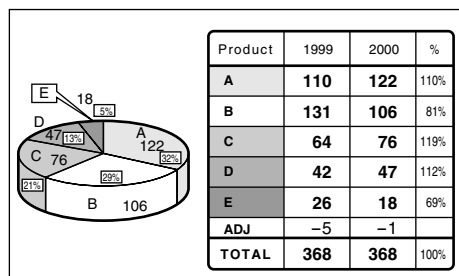

① Press the “– D.ZOOM +” button of the remote control.

The image is zoomed in.

② Change the magnification with the “– D.ZOOM +” button.

The magnification can be adjusted from 1.0 to 3.0 times.

③ Use ▲ ▼ ◀ ▶ buttons to move the magnified image.

④ To restore the original image, press the “MENU” button.

Note

- The digital zoomed state cannot be stored in memory.
- If the input signal format is changed while in digital zoom mode, the projector will exit digital zoom function.
- The combined magnification of “POSITION” zoom and digital zoom is 9.99 times maximum.

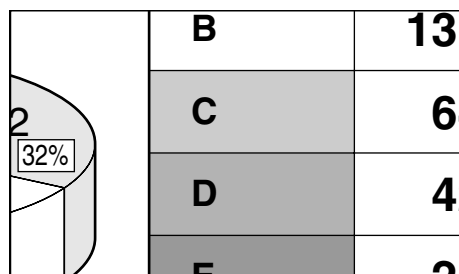

On-screen menus

Structure of menu screens

Menus are extensively used for configuring, adjusting or reconfiguring the projector. The menu structure is as follows:

MENU

MENU	
PICTURE	
POSITION	
ADVANCED MENU	
LANGUAGE	
OPTION1	
OPTION2	
TEST PATTERN	
SECURITY	
NETWORK	
SELECT ENTER ENTER MENU EXIT	

PICTURE (page 29)

For RGB signals

PICTURE	
PICTURE MODE	GRAPHIC
BRIGHT	32
CONTRAST	32
COLOR TEMP.	DEFAULT
WHITE GAIN	10
SHARPNESS	6
NR	OFF
AI	ON
SYSTEM	RGB
SELECT ADJ MENU RETRN	

For DVI signals

PICTURE	
PICTURE MODE	GRAPHIC
BRIGHT	32
CONTRAST	32
COLOR TEMP.	DEFAULT
WHITE GAIN	10
SHARPNESS	6
NR	OFF
AI	ON
SELECT ADJ MENU RETRN	

NETWORK (page 38)

NETWORK	
HOST NAME	
DHCP	OFF
IP ADDRESS	
SUBNET MASK	
GATEWAY	
MAC ADDRESS	
STORE	
SELECT ENTER ENTER MENU RETRN	

For S-Video/Video signals

PICTURE	
PICTURE MODE	STANDARD
BRIGHT	32
CONTRAST	32
COLOR	32
TINT	32
COLOR TEMP.	DEFAULT
WHITE GAIN	5
SHARPNESS	6
NR	ON
AI	ON
TV-SYSTEM	AUTO1
SELECT ADJ MENU RETRN	

For YPbPr signals

PICTURE	
PICTURE MODE	STANDARD
BRIGHT	32
CONTRAST	32
COLOR	32
TINT	32
COLOR TEMP.	DEFAULT
WHITE GAIN	5
SHARPNESS	6
NR	ON
AI	ON
SYSTEM	AUTO
SELECT ADJ MENU RETRN	

SECURITY (page 37)

TEST PATTERN (page 37)

OPTION2 (page 35)

OPTION2	
ID	ALL
FRONT/REAR	FRONT
DESK/CEILING	DESK
LAMP SELECT	DUAL
LAMP POWER	HIGH
RS232C	
SYSTEM INFORMATION	
FAN CONTROL1	NORMAL
FAN CONTROL2	HORIZ.
FUNC1	
AUTO POW. OFF	DISABLE
PASSWORD	
SELECT ADJ MENU RETRN	

ADVANCED MENU (page 32)

ADVANCED MENU	
DIGITAL CINEMA REALITY	
BLANKING	
INPUT RESOLUTION	
CLAMP POS.	1
RASTER POSITION	
XGA MODE	XGA
SXGA MODE	SXGA
SELECT ENTER ENTER MENU RETRN	

POSITION (page 30)

POSITION	
POSITION	
ASPECT	4:3
ZOOM	
CLOCK PHASE	16
KEYSTONE	
SELECT ENTER ENTER MENU RETRN	

OPTION1 (page 34)

OPTION1	
COLOR CORRECTION	
CONTRAST MODE	
AUTO SIGNAL	OFF
BACK COLOR	BLACK
SUB MEMORY LIST	
DVI EDID	EDID2.PC
SELECT ENTER ENTER MENU RETRN	

LANGUAGE (page 33)

LANGUAGE	
ENGLISH	
DEUTSCH	
FRANCAIS	
ESPAÑOL	
ITALIANO	
日本語	
中文	
PYCCKИM	
한국어	
SELECT ENTER ENTER MENU RETRN	

■ Basic menu operations

① Press the “MENU” button.

The MENU appears on the screen.

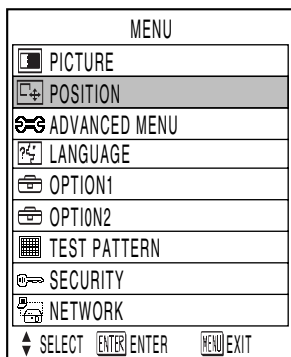

② Select (highlight) the desired item with the ▲ or ▼ buttons.

Selected items are displayed in blue.

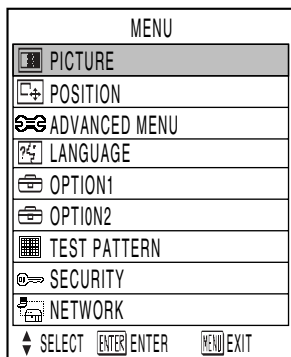

③ Press the “ENTER” button to enter your selection.

The submenu for the selected option will now open. (e.g. : PICTURE Menu)

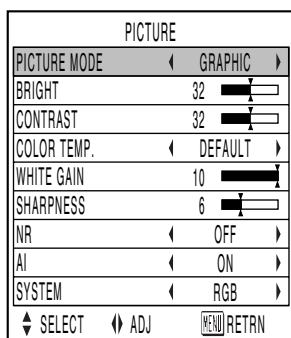

④ Highlight the desired adjustment item with the ▲ or ▼ buttons, then change the parameter value with the ◀ or ▶ buttons.

(Example of separate adjustment screen)



- If no button is operated for approx. 5 seconds while a bar graph is displayed, the screen will return to the previous page.

■ Returning to the previous page

- Pressing the “MENU” button returns the screen to the previous menu page.
- When the MENU is on the screen, pressing the “MENU” button clears all menus from the screen.

■ Menu items shown in transparent characters

- Some menu items may not be valid for certain signal formats applied to the projector. The menu items that cannot be adjusted or used are shown in transparent characters, and they cannot be selected even by pressing the ENTER button.

■ Menu items setting

- The bottom prompt line differs on each menu depending on the selected menu option:
 - A prompt “◀ ▶ ADJ” appears when changing the setting.
 - A prompt “ENTER ENTER” appears for a separate bar graph.

■ Resetting to the factory default

STD (standard) button is used to reset all of the projector adjustment values to the default levels which were set at the time of shipment from the factory.

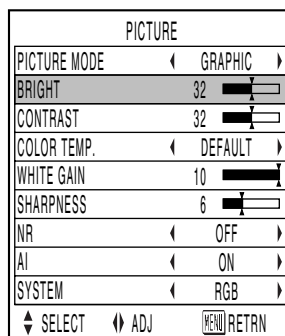

- If the parameter value on a bar graph is reset to the factory default, the bar turns to white.

Note

- The upper and lower triangular markings on a bar graph indicate the default setting for the parameter. If no such triangular markings are shown on the bar graph, the parameter cannot be reset to the factory default.

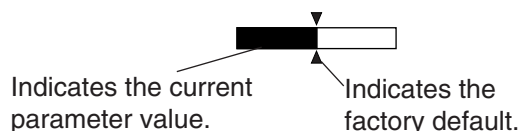

Adjusting the picture

• For RGB signals

PICTURE	
PICTURE MODE	◀ GRAPHIC ▶
BRIGHT	32
CONTRAST	32
COLOR TEMP.	◀ DEFAULT ▶
WHITE GAIN	10
SHARPNESS	6
NR	◀ OFF ▶
AI	◀ ON ▶
SYSTEM	◀ RGB ▶
⏴ SELECT ⏵ ADJ RETRN	

• For DVI signals

PICTURE	
PICTURE MODE	◀ GRAPHIC ▶
BRIGHT	32
CONTRAST	32
COLOR TEMP.	◀ DEFAULT ▶
WHITE GAIN	10
SHARPNESS	6
NR	◀ OFF ▶
AI	◀ ON ▶
⏴ SELECT ⏵ ADJ RETRN	

• For S-Video/Video signals

PICTURE	
PICTURE MODE	◀ STANDARD ▶
BRIGHT	32
CONTRAST	32
COLOR	32
TINT	32
COLOR TEMP.	◀ DEFAULT ▶
WHITE GAIN	5
SHARPNESS	6
NR	◀ ON ▶
AI	◀ ON ▶
TV-SYSTEM	◀ AUTO1 ▶
⏴ SELECT ⏵ ADJ RETRN	

• For YPbPr signals

PICTURE	
PICTURE MODE	◀ STANDARD ▶
BRIGHT	32
CONTRAST	32
COLOR	32
TINT	32
COLOR TEMP.	◀ DEFAULT ▶
WHITE GAIN	5
SHARPNESS	6
NR	◀ ON ▶
AI	◀ ON ▶
SYSTEM	◀ AUTO ▶
⏴ SELECT ⏵ ADJ RETRN	

■ PICTURE MODE

The picture mode can be selected from the following depending on viewing conditions and the video signal source in use:

- DYNAMIC** : Picture brightness/contrast ratio is increased to suit brighter viewing environments.
- GRAPHIC** : The picture becomes suitable for input from the personal computer.
- STANDARD** : The picture becomes suitable for moving images in general.
- CINEMA** : The picture becomes suitable for movie sources.
- NATURAL** : The picture becomes suitable for use in a dark room.

■ BRIGHT

“BRIGHT” is used to adjust the black level (brightness).

- ▶ : Raises the picture brightness.
- ◀ : Lowers the picture brightness.

■ CONTRAST

“CONTRAST” is used to adjust the contrast ratio.

- ▶ : Raises the contrast ratio.
- ◀ : Lowers the contrast ratio.

■ COLOR

(For S-Video/Video/YPbPr signals only)

- ▶ : Deepens colours.
- ◀ : Weakens colours.

■ TINT

(For S-Video/Video/YPbPr signals only)

“TINT” is used to adjust human skin.

- ▶ : Adjusts skin tone toward greenish colour.
- ◀ : Adjusts skin tone toward reddish-purple.

■ COLOR TEMP.

The colour temperature is adjusted when the white areas of images take on a reddish or bluish hue.

DEFAULT : Standard setting

HIGH : The white areas take on a more bluish-white hue.

MIDDLE : The white areas take on a slightly reddish hue.

USER : The RGB values of the white balance are set separately.

Press the ENTER button, select “W-BAL HIGH” or “W-BAL LOW”, and proceed with the detailed settings.

- ▶ : The colours of the selected item are darkened.
- ◀ : The colours of the selected item are lightened.

■ WHITE GAIN

The brightness of white parts of the image can be adjusted.

- ▶ : The intensity of white colour increases.
- ◀ : Reverts to natural image.

■ SHARPNESS

“SHARPNESS” is used to adjust the crispness of the image.

- ▶ : Sharpens the edge of the image.
- ◀ : Softens the edge of the image.

■ NR

In this mode, the video noise is reduced. (For S-Video/Video/YPbPr signals)

OFF : No correction

ON : Noise reduction is set to ON.

(For RGB/DVI signals)

OFF : No correction

1 : Low

2 : Middle

3 : High

Adjusting the position

AI

Gray scale control is exercised to suit the images, and optimal images with a clear contrast are projected.

- ON : AI compensation is enabled.
- OFF : AI compensation is disabled.

TV-SYSTEM

(For S-Video/Video signals)

The setting that corresponds to the TV system is selected here.

AUTO1 : Standard setting
Automatically selects the TV standard that matches the input video signal, out of NTSC, PAL, NTSC4.43, SECAM and PAL60.

AUTO2 : Automatically selects the TV standard that matches the input video signal, out of NTSC, PAL-M, and PAL-N.

- Normally "AUTO1" or "AUTO2" should be chosen for this option.
- If the video signals are not displayed properly due to signal deterioration, choose the TV system that matches the input video signals.

Automatically selected by detecting the horizontal/vertical scan frequencies and colour sub-carrier listed in the table below:

Signal System	H. Scan Frequency (kHz)	V. Scan Frequency (Hz)	Colour Subcarrier (MHz)
NTSC	15.75	60.00	3.58
NTSC4.43	15.75	60.00	4.43
PAL	15.63	50.00	
PAL-M	15.75	60.00	3.58
PAL-N	15.63	50.00	
SECAM	15.63	50.00	4.25 or 4.41
PLA60	15.75	60.00	4.43

SYSTEM

(For RGB/YPbPr signals)

This enables the RGB system or YPbPr system to be selected.

For the signals which are supported, refer to page 58.

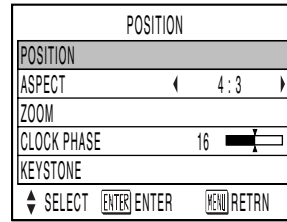

POSITION

The position where the images are displayed can be moved here.

- ◀ ▶ : The position is moved horizontally.
- ▲ ▼ : The position is moved vertically.

ASPECT

AUTO : (For S-Video/Video signals only)

At this setting, when S1 video signals*1 are identified as being input to the S-Video connector or video ID signals are identified as being input to the video connector, the images are displayed after automatically being converted to the 16:9 aspect ratio.

16:9 : At this setting, when standard signals*2 are input, the images are converted to the 16:9 aspect ratio and displayed.

When wide-screen signals*3 are input, the images are displayed with their inherent aspect ratio intact.

4:3 : At this setting, when standard signals*2 are input, the images are displayed with their inherent aspect ratio intact. When wide-screen signals*3 are input, they are converted by the PT-D5600E to the 4:3 aspect ratio and displayed. With the PT-DW5000E, the images are reduced in size and displayed without converting their aspect ratio so that they will fit onto a screen with a 4:3 aspect ratio.

S4:3 : Select this setting when using a 16:9 screen.

HV FIT : At this setting, the images are displayed to fill the entire screen.

If the aspect ratios of the input signals and screen differ, the images are converted into the screen's aspect ratio (4:3 for the PT-D5600E or 15:9 for the PT-DW5000E) and displayed.

- *1 S1 video signals are 16:9 video signals to which is added the detection signal output from the video deck or other unit which supports the wide-screen format.
- *2 Here, the standard signal means 4:3 or 5:4 input signals.
- *3 Here, the wide-screen signals means 16:9, 15:9 or 15:10 input signals.

(Continued on next page)

Adjusting the position

Attention • If you choose an aspect ratio that does not match the source video's aspect ratio, you will see a picture with an aspect ratio not the same as that of the original picture. Choose the appropriate aspect ratio carefully to match that of the original picture.

Note • If the picture size is compressed or enlarged by using the 16:9 aspect ratio when the projector is used for profitable purpose or in the presence of an audience (for example, in a coffee shop or at a hotel etc.), it may infringe the rights of the copyright owner of the original picture.

• If a picture with the standard (4:3) aspect ratio is projected at a wide aspect ratio, parts of the picture may run over the screen bounds or the overall picture may be distorted. To view the picture at its original aspect ratio, choose the standard 4:3 aspect ratio.

■ ZOOM

This enables the enlargement ratio to be changed and the resulting enlarged image displayed.

◀ ▶ : The enlargement ratio in the horizontal direction is changed.

▲ ▼ : The enlargement ratio in the vertical direction is changed.

■ CLOCK PHASE

(For RGB/YPBPR signals only)

Clock phase adjustment allows the user to minimize visible noise with the ◀ or ▶ button.

Note • When projecting signals whose dot clock frequency is 108 MHz or higher, the noise may not disappear even when the clock phase is adjusted.

• Clock phase adjustment is not available for digital RGB signals.

■ KEYSTONE

KEYSTONE : Keystone distortion can be corrected only along either horizontal bound of the picture.

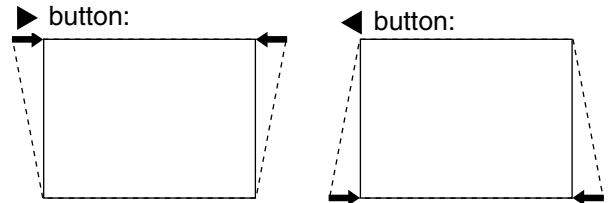

Note • Keystone distortion can be corrected to $\pm 30^\circ$ of the angle of tilt for the projector. However, the greater the correction amount, the more the picture quality will deteriorate, and the harder it will become to achieve a good level of focus. To obtain the best picture quality, set up the projector and screen in such a way that the amount of keystone correction required is as minimal as possible.

• The picture size will also change when correction of keystone distortion is carried out.

LINEARITY : After you are finished with keystone adjustment, adjust vertical linearity with the ◀ or ▶ button.

Linearity is not adjustable if no correction was made to keystone distortion.

How to use ADVANCED MENU

ADVANCED MENU	
DIGITAL CINEMA REALITY	
BLANKING	
INPUT RESOLUTION	
CLAMP POS.	1
RASTER POSITION	
XGA MODE	XGA
SXGA MODE	SXGA
⏏ SELSCT ⏎ ENTER ⏎ ENTER ⏏ RETRN	

■ DIGITAL CINEMA REALITY

(Only for input of S-Video/ Video/ YPBPR [480i, 576i] signals.)

ON: Set at ON when you need to faithfully capture images shot at 24 frames per second as in movies.

OFF: Set at OFF when unnatural images are obtained in the ON status.

■ BLANKING

You can perform fine adjustments for blanking if noise appears at the ends of the screen or the image protrudes out of the screen during image projection using a video deck and so on.

▲ ▼ : Select the UPPER, LOWER, LEFT or RIGHT adjustment.

◀ ▶ : Adjust the blanking width.

For upper adjustment

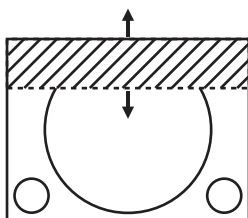

For lower adjustment

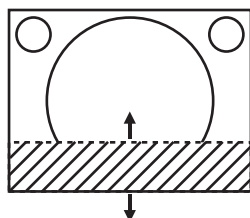

For left adjustment

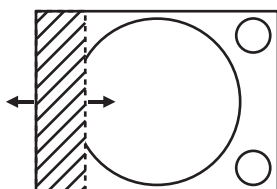

For right adjustment

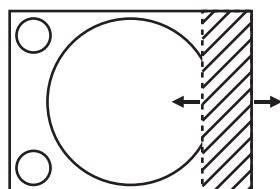

■ INPUT RESOLUTION

Input resolution adjustment achieves the best image when the screen flickers or halo is observed around the contour.

▲ ▼ : These select the items listed below.

◀ ▶ : These select the value.

“TOTAL DOTS”, “DISPLAY DOTS”, “TOTAL LINES” and “DISPLAY LINES”

Each item automatically displays a value in response to the type of the input signal. If vertical stripes appear on the screen or the image is partly missing, increase or decrease the displayed value while observing the screen to achieve the optimal value.

Note

- The abovementioned vertical stripes will not appear on the screen when all white signals are input.
- The picture may be distorted during the adjusting operation, but this is not a fault.
- The input resolution can be adjusted only when RGB signal input is applied with RGB1 and RGB2 IN.
- Automatic adjustment is not available if signals having a dot clock frequency of more than 108 MHz are supplied.

■ CLAMP POS.

(For RGB/ YPBPR signals only)

Use the clamp position adjustment to achieve the optimal value when dark areas of the image are crushed or displayed in green.

Adjust with the ◀ ▶ buttons.

The value changes from 0 to 255.

The optimal value for the clamp position adjustment

- If dark areas are crushed:
 - The optimal value is the point where the dark area is best improved.
- If the dark areas are displayed in green:
 - The optimal value is the point where the green area becomes dark and clear.

Note

- The clamp position can be adjusted only when the RGB signal input is applied with RGB1 and RGB2 IN.

How to use ADVANCED MENU

■ RASTER POSITION

When the whole area where the input picture can be displayed is not used, the picture can be moved to any position inside the display area.

◀ ▶ : These adjust the value in the horizontal direction.

▲ ▼ : These adjust the value in the vertical direction.

■ XGA MODE

This mode takes effect only when XGA (RGB) signals are input.

XGA : Standard setting

WXGA : Select this mode when WXGA signals are input.

■ SXGA MODE

This mode takes effect only when SXGA (RGB) signals are input.

SXGA : Standard setting

SXGA+: Select this when the screen is cut off.

Changing the display language



Currently chosen language is displayed here.

Menus, setting items, adjustment screens, and control button names will be displayed in the language the user chooses.

The available languages are:

ENGLISH, DEUTSCH, FRANÇAIS, ESPAÑOL, ITALIANO, 日本語, 中文, ПУСЬКИИ, 한국어.

Note

- The projector's on-screen display is set to the English language by default.

OPTION1 settings

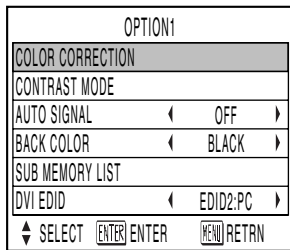

■ COLOR CORRECTION

- OFF : Standard setting
- USER : The six colours of red, green, blue, cyan, magenta and yellow can be adjusted and registered for each of four signal systems: Video, S-Video, RGB and YPbPr.
Press the ENTER button to make the detailed settings.

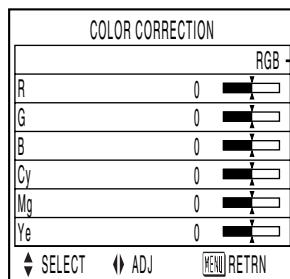

The current signal system is displayed.

■ CONTRAST MODE

There are two modes for adjusting to the operating environment.

- NORMAL : The contrast is set to normal and the brightness to maximum.
- HIGH : The contrast is set to maximum and the brightness to normal.

■ AUTO SIGNAL

The position where the screen is displayed can be adjusted automatically without pressing the AUTO SETUP button on the remote control each time signals are input when signals are input frequently such as when the projector is used at a conference.

- ON : Auto setup is performed automatically when the video signals of the images being projected have changed.
- OFF : The input auto setup function is set to OFF.

■ BACK COLOR

You can set the colours of the screen when no signal is input to the projector.

- BLUE: Set screen colour to blue.
- BLACK: Set screen colour to black.

■ SUB MEMORY LIST

Multiple sets of image adjustment data (PICTURE, POSITION, ADVANCED MENU adjustment values) for the same kind of signal can be registered.

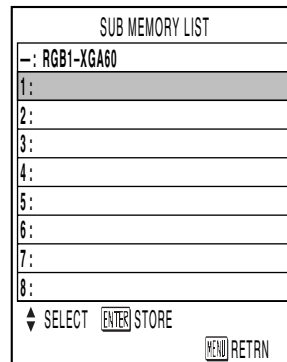

Registering in sub memory

- ① Select the sub memory number to be registered using the ▲ ▼ buttons.
- ② Press the ENTER button.

Note • Sub memories range from 1 to 8.

How to select sub memory

- ① Select sub memory number (1 to 8) using the ▲ ▼ buttons. Select “-” if you do not wish to use the sub memory.
- ② Press the ENTER button.

Note • You cannot select sub memory of a different signal system.

How to erase sub memory

- ① Select sub memory number (1 to 8) corresponding to sub memory to be erased using ▲ ▼ buttons.
- ② Press the STD button.
- ③ When the indicator of sub memory to be erased flashes, press the ENTER button.

■ DVI EDID

Set EDID to match the device connected.

Mode	Matching Signal
EDID1	480p, 576p, 720/60p, 720/50p, 1080/60i, 1080/50i
EDID2:PC	VGA60, SVGA60, XGA50, XGA60, XGA70, XGA85, WXGA768/50, WXGA768/60, SXGA60

OPTION2 settings

OPTION2	
ID	← ALL →
FRONT/REAR	← FRONT →
DESK/CEILING	← DESK →
LAMP SELECT	← DUAL →
LAMP POWER	← HIGH →
RS232C	
SYSTEM INFORMATION	
FAN CONTROL1	← NORMAL →
FAN CONTROL2	← HORIZ. →
FUNC1	
AUTO POW. OFF	← DISABLE →
PASSWORD	
↓ SELECT	↔ ADJ
	RETRN

■ ID

The projector has an ID number setting function that helps the user to control two or more projectors either simultaneously or separately with a single remote control. **The ID number is set to "ALL" by default. Hence the ID number need not be set when only one projector is used.**

1-64 : The ID number is set in this range.

Note

- The ID number can be set to "ALL", or selected from "1" to "64".
- If the projectors are given ID numbers, their remote controls must be assigned the same ID numbers, respectively.
- If the ID number of a projector is set to "ALL", it can be controlled by the remote control or the PC with any ID number.
If multiple projectors are used and some of them have their IDs set to "ALL", they cannot be controlled separately from the projectors with other ID numbers.
For details on remote control ID setting, see page 15.

■ FRONT/REAR

"FRONT/REAR" is used to choose the appropriate projection scheme from Front and Rear:

FRONT : Choose this option if pictures are projected from the front of a reflective screen.

REAR : Choose this if pictures are projected from the back of a translucent screen.

■ DESK/CEILING

"DESK/CEILING" is used to choose the appropriate projection scheme from Desk and Ceiling:

DESK : Choose this option if the projector is installed on a floor-standing base.

CEILING : Choose if the projector is installed on the ceiling using the optional ceiling mount bracket.

■ LAMP SELECT

"LAMP SELECT" is used to choose from Single Lamp and Dual Lamp modes depending on user's needs or viewing conditions. In Single Lamp mode, the projector may automatically select either lamp from the 2 lamps, or the particular lamp can be specified.

DUAL : Two lamps are used simultaneously.

SINGLE : One of either lamps is used (lamp with shorter operating hours is automatically selected).

LAMP1 : Lamp Unit 1 is always used.

LAMP2 : Lamp Unit 2 is always used.

When one of the above settings is selected, it will take effect after ENTER is pressed.

Note

- If, in the "SINGLE", "LAMP1" or "LAMP2" mode, one lamp remains off or the currently active lamp exceeds 1 500* hours of cumulative operating time (when "HIGH" is selected as the lamp power setting), the other lamp will light. If, in the "DUAL" mode, one lamp remains off or the currently active lamp exceeds 1 500* hours of cumulative operating time (when "HIGH" is selected as the lamp power setting), the other lamp alone will light. However, if both lamps remain off or the 1 500* hours of cumulative operating time are exceeded, the projector will enter the standby mode.
 - If only one lamp is installed in the projector, set lamp mode to either "LAMP1" or "LAMP2". "LAMP1" or "LAMP2" is selected. If the corresponding lamp is not installed, the other lamp will turn on.
 - The colours of the items indicate the status.
Green → Current setting
Cyan → Now changing from one status to another
Red → Lamp that has failed to light
White → Any other status
 - If the projector is repeatedly used for short periods of time, the lamps will need to be replaced more frequently.
- * This time period is 4 000 hours when long life lamp units (page 42) are used.

■ LAMP POWER

The luminance of the projection lamp can be changed depending on user's needs or the viewing conditions.

HIGH : Set when high brightness is necessary.

LOW : Set when high brightness is not necessary.

Note

- When set to "LOW", it is possible to reduce power consumption, reduce operating noise and extend lamp service life.
- "LOW" is set automatically when long life lamp units are used.

■ RS232C

This sets the communication parameters at the serial terminals.

For details on the serial terminals, refer to “Using the serial terminals” (pages 38).

- IN BAUDRATE : 9 600, 19 200 or 38 400 is selected.
- IN PARITY : NONE, EVEN or ODD is selected.
- OUT BAUDRATE: 9 600, 19 200 or 38 400 is selected.
- OUT PARITY : NONE, EVEN or ODD is selected.
- VPS SYSTEM : MASTER or SLAVE is selected.
- GROUP : A to Z is selected. MASTER or SLAVE is also selected.

■ SYSTEM INFORMATION

The projector’s system information can be viewed.

SYSTEM INFORMATION	
ROM VERSION	1.00.00
SET RUNTIME	300h
LAMP1 LOW	100h
HIGH	200h
TOTAL	300h
LAMP2 LOW	100h
HIGH	200h
TOTAL	300h
LAMP1 ON	20
LAMP2 ON	20
LAMP1 TYPE	LAD55
LAMP2 TYPE	LAD55
[RECALL] RETRN	

■ FAN CONTROL1

The fan can be controlled in accordance with the operating conditions.

- NORMAL : Standard setting
- HIGHLAND : This is selected when using the projector at an altitude of over 1 400 metres.

■ FAN CONTROL2

The fan can be controlled in accordance with the direction in which the images are to be projected.

- HORIZ. : Standard setting
- VERTICAL : This is selected when projecting images at a significant angle toward the vertical (more than 30 degrees from the horizontal).

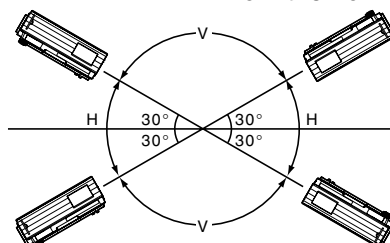

H: HORIZ.
V: VERTICAL

Attention • Select the correct FAN CONTROL2 setting in accordance with the direction in which the images are to be projected. Using the projector at the wrong FAN CONTROL2 setting will shorten the service life of the lamps.

■ FUNC1

The user can set the function for the remote control’s FUNC1 button.

- LAMP POWER: The button functions in the same way as “LAMP POWER” of “OPTION2”.
- ASPECT: This button has the same functions as “ASPECT” of “POSITION”.
- SUB MEMORY LIST: This button has the same functions as “SUB MEMORY LIST” of “OPTION1.”

■ AUTO POW.OFF

The projector can be automatically set to the standby mode if no signals are input for the set duration.

- DISABLE: Standard setting. This function is set to OFF.
- 45MIN.–90MIN.: The duration can be set in 15-minute increments from 45 to 90 minutes.

Note • The auto power OFF function does not work while the freeze function is used.

■ PASSWORD

This function is used by a service person. Input the password with the numeric buttons (0 to 9) of the remote control and press ENTER button to confirm the entry.

Displaying the internal test pattern

The projector has eight types of internal test patterns to check the condition of the set. To display test patterns, follow the steps below.

Note • Results of adjustment on the image, picture quality, position, size and other factors will not be reflected in test patterns. Be sure to display the input signal before performing various kinds of setting.

◀ ▶ : Search through the various types of test patterns

Cycle of displayed internal test patterns

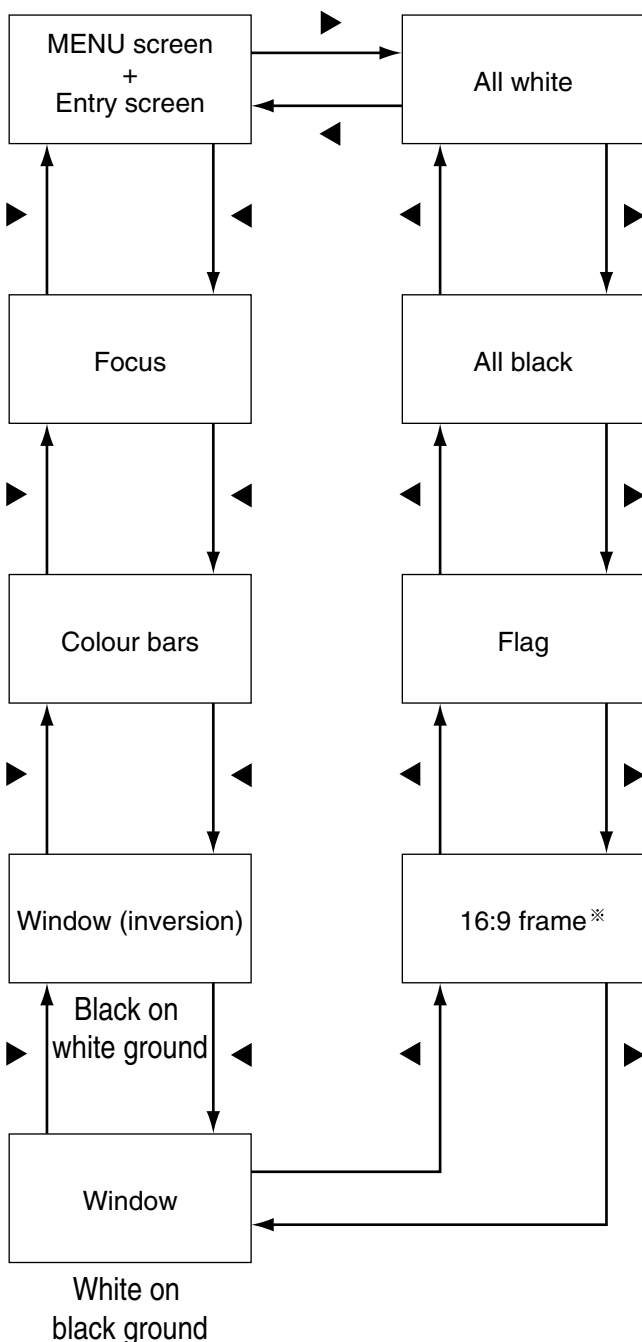

* The PT-DW5000E and PT-DW5000EL support the 4:3 frame format.

Setting the security

The projector's security function enables the password input screen to be displayed or a company's URL address to be set and displayed underneath the projected images.

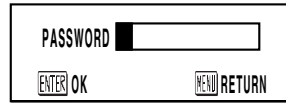

(When using the projector for the first time)

Press the ▲, ▶, ▼, ◀, ▲, ▶, ▼ and ◀ buttons in this order, and press the ENTER button.

(When the password has been changed)

Input the new password, and press the ENTER button.

Setting the password

It is possible to display the password input screen each time the power is turned on. If this option is used, no operations except for the POWER button can be performed without inputting the correct password.

- ON : Password input is enabled.
- OFF : Password input is disabled.

Changing the password

The password can be changed. Press the ENTER button.

- ① Set the password using the ▲, ▼, ◀, ▶ buttons (up to 8 buttons can be set).
- ② Press the ENTER button.
- ③ Confirm the password by inputting it again.
- ④ Press the ENTER button.

(This completes the settings.)

Note • Asterisks (*) will appear on the screen in the place of the actual password when the password is input.
• If the wrong password is input, the letters for "Password", "New", etc. appear in red. Input the correct password.

Setting the text

The text which has been set can be displayed underneath the projected images all the time.

- ON : The text display is enabled.
- OFF : The text display is disabled.

Changing the text

The text which is to be displayed when ON has been selected for the text setting can be changed. Press the ENTER button.

- ① Select the text using the ▲, ▼, ◀, ▶ buttons, and press the ENTER button. (Up to 22 alphanumeric can be input in succession.)
 - ② Select "OK" using the ▲, ▼, ◀, ▶ buttons, and press the ENTER button.
- To cancel the change at any time, select CANCEL.

Setting the network

The settings required for the network must be established in order to use the web browser (page 45) functions that the PC uses to control the projector.

NETWORK	
HOST NAME	
DHCP	← OFF →
IP ADDRESS	
SUBNET MASK	
GATEWAY	
MAC ADDRESS	
STORE	
⏴ SELECT ENTER ENTER MENU RETRN ⏵	

- HOST NAME** : Make alteration if necessary when to use the DHCP server.
- DHCP** : Set the DHCP item to ON when to acquire an IP address automatically using the DHCP server.
Set to OFF if DHCP server is not used.
- IP ADDRESS** : Enter the IP address if DHCP server is not used.
- SUBNET MASK** : Enter the subnet mask if DHCP server is not used.
- GATEWAY** : Enter the gateway address if DHCP server is not used.
- MAC ADDRESS** : Displays the MAC address (Media Access Control Address), which is proper to the network device.
This function may be needed when to use the DHCP server.
- STORE** : The settings are stored in the memory.

- Attention**
- Before using the DHCP server, make sure the DHCP server is already functioning.
 - For details of IP address, subnet mask, and gateway, ask the network administrator.

Connecting the PC

System requirements

The following system specifications are required in order to use the networking functions.

- **PC**
 - OS : Windows XP/2000/Me (Millennium Edition)/98SE (Second Edition)
 - CPU : Pentium III processor or faster
 - RAM : 64 MB or more (128 MB or more for Windows XP/2000)
 - Web browser: Internet Explorer 6.0 or newer, Netscape Communicator 7.0 or newer

- **LAN cable**
 - Type : Category 5 compatible straight cable
 - Length: 100 metres or less

Attention • If you want to use the e-mail function, make sure the system can handle e-mail.

Operation is not guaranteed for all computers that meet the above conditions.

Connection example

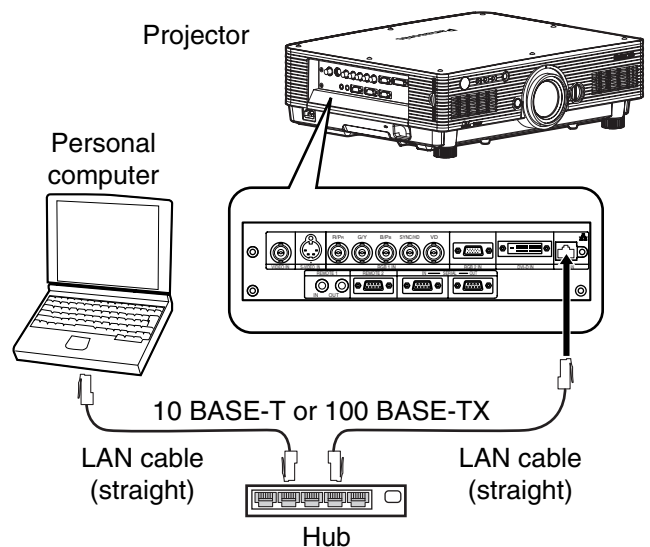

Attention • Touching the LAN terminal with your hand (or body) when you are carrying a static charge may damage the equipment due to a discharge of static electricity. Therefore, be careful not to touch the LAN terminal or metal parts of the LAN cable.

ENGLISH

Using the serial terminals

The main unit is equipped with SERIAL terminals located in its terminal section on the side, and this terminal is compliant with RS232C. Also a serial output terminal is provided to enable plural projector control.

Examples of connection

Single projector

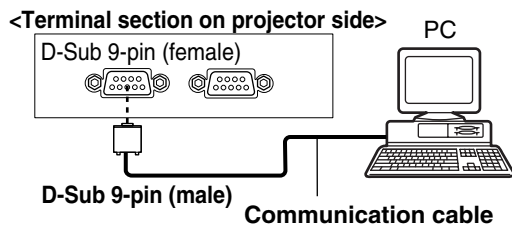

Plural projectors

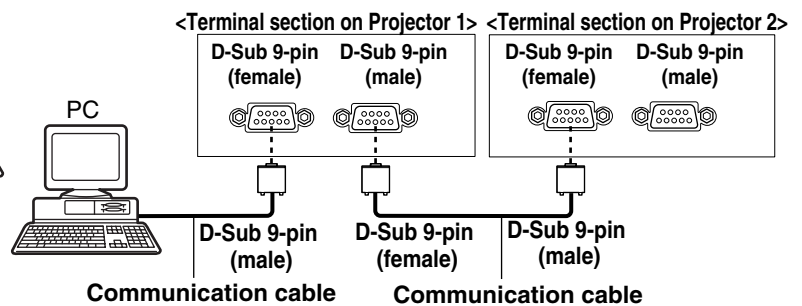

Pin assignments and signal names

D-Sub 9-pin (female), external appearance

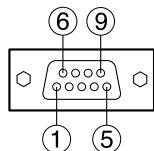

Serial input terminal

Pin No.	Signal name	Description
①		NC
②	TXD	Send data
③	RXD	Receive data
④		Connected internally
⑤	GND	Ground
⑥		NC
⑦	CTS	Connected internally
⑧	RTS	
⑨		NC

D-Sub 9-pin (male), external appearance

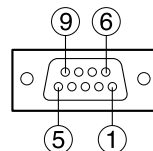

Serial output terminal

Pin No.	Signal name	Description
①		NC
②	RXD	Receive data
③	TXD	Send data
④		NC
⑤	GND	Ground
⑥		NC
⑦	RTS	Connected internally
⑧	CTS	
⑨		NC

Communication conditions (Factory setting)

Signal level	RS232C compliant
Synchronization method	Start-stop synchronization
Baud rate	9 600bps
Parity	None
Character length	8 bits
Stop bit	1 bit
X parameter	None
S parameter	None

Basic format

Transmission from the computer begins with STX, then the ID, command, parameter, and ETX are sent in this order. Add parameters according to the details of control.

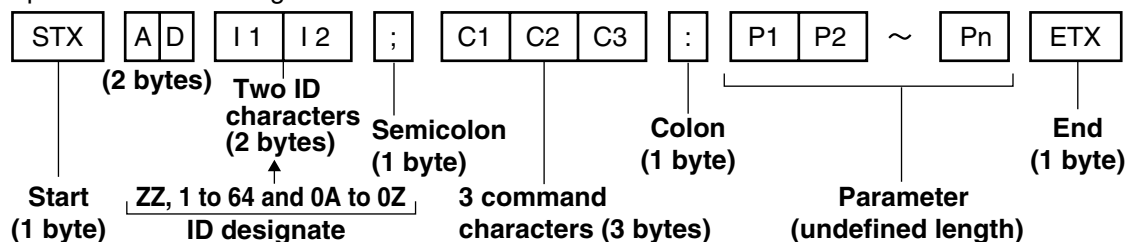

- Attention**
- No command can be sent or received for 10 to 60 seconds after the lamp starts lighting. Try sending any command after that period has elapsed.
 - When sending several commands, be sure to wait for more than 0.5 seconds after receiving a response from the projector, and then send the next command. When sending commands without parameters, a colon (:) is not necessary.

- Note**
- If an unworkable command is received, the projector will send an "ER401" response to the computer.
 - If an invalid command is received, the projector will send an "ER402" response to the computer.
 - Projector ID supported on the RS232C interface is ZZ (ALL) and a group of 1 to 64 and 0A to 0Z.
 - If a command is sent with a projector ID specified, the projector will return answer back only in the following cases:
 - If it coincides with the projector ID,
 - ID specification is ALL and VPS-SYSTEM is the master, or
 - ID specification is group and Group is the master.
 - In the hexadecimal format, STX has the character code 02 and ETX the character code 03.

Using the REMOTE 2 terminal

Control commands

When controlling the projector from a computer, the following commands are available:

Command	Function of command	Remarks
PON	Power "ON"	To confirm that the power is ON, use a "Power query" command.
POF	Power "STANDBY"	
QPW	Power query	Parameter 000 = STANDBY 001 = Power "ON"
I I S	Switch input modes	Parameter VID = VIDEO SVD = S-VIDEO RG1 = RGB1 RG2 = RGB2 DVI=DVI
QSL	Query for active lamp mode	Parameter 0 = DUAL ※ "SINGLE" will use the lamp (LAMP 1 or LAMP 2) with shorter operating hours. 1 = SINGLE 2 = LAMP 1 3 = LAMP 2
LPM	Active lamp mode	Parameter 0 = DUAL 1 = SINGLE 2 = Only LAMP 1 is on 3 = Only LAMP 2 is on
OLP	Lamp power setting	Parameter 0 = HIGH, 1 = LOW

Note • If you need a detailed command list, please contact your dealer.

Cable specifications

<Connecting to a PC>

Projector		Computer (DTE specifications)	
1	NC	NC	1
2			2
3			3
4	NC	NC	4
5			5
6	NC	NC	6
7			7
8			8
9	NC	NC	9

Attention • To connect the computer to the SERIAL terminal, prepare an adequate communication cable that fits to your personal computer.

Using the REMOTE 2 terminal provided on the side of the main unit, it is possible to operate the projector from a control panel etc. furnished in a distant location where infrared remote control signal cannot be received.

Example of a control panel layout

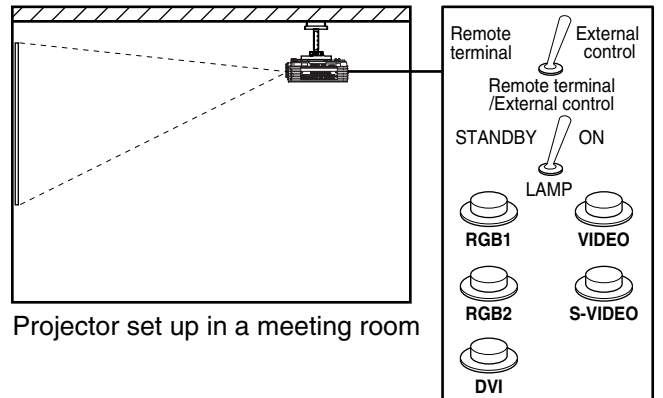

Projector set up in a meeting room

Control panel located in a different room

Pin assignments and control

Be sure to short-circuit Pins ① and ⑨ when controlling.

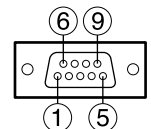

D-Sub 9-pin (female) external appearance

	Names of terminals	Open (H)	Short (L)
①	GND	—	GND
②	POWER	OFF	ON
③	RGB1	Other	RGB1
④	RGB2	Other	RGB2
⑤	VIDEO	Other	VIDEO
⑥	S-VIDEO	Other	S-VIDEO
⑦	DVI	Other	DVI
⑧	SHUTTER	OFF	ON
⑨	RST / SET	Controlled by remote control	Controlled by external contact



Note • The following buttons on the remote control and the operation area of the projector can no longer be operated when pins ① and ⑨ are shorted: POWER button and SHUTTER button. Neither will it be possible to use the RS232C commands or network functions corresponding to these functions.

• If you short pin ① and pin ⑨, and also short one of the pins from ③ to ⑦ and pin ①, then the following buttons on the projector operating area and the remote control can no longer be operated: POWER, RGB1, RGB2, DVI, VIDEO, S-VIDEO and SHUTTER buttons. Neither will it be possible to use the RS232C commands or network functions corresponding to these functions.

Indication of lamp monitor

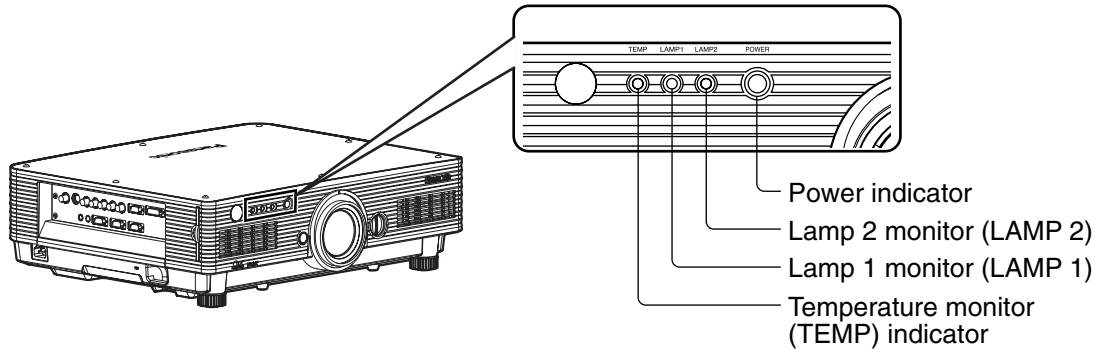
This projector is equipped with 3 indicators to show when a lamp needs replacement or there is an abnormal internal temperature. These lamps flash or light up to indicate a problem. Turn the power off and follow the steps below.



Name of monitor lamp	Lamp indication	Information	Checkpoint	Remedial measure
Temperature monitor TEMP 	Lighting in red (lamp unit ON)	Warm-up status	<ul style="list-style-type: none"> Did you turn on the power when the ambient temperature was low (approx. 0 °C)? 	<ul style="list-style-type: none"> Wait about five minutes in the current status. Install the unit in a location having an ambient temperature from 0 to 45 °C.
		High temperature inside. (WARNING)	<ul style="list-style-type: none"> Check if the ventilation port is blocked. Is the room air temperature too high? Is the air filter clogged with dust? 	<ul style="list-style-type: none"> Remove the object that is blocking the ventilation port. Move the projector to a temperature of 0 to 45 °C and the humidity of 20 to 80 % (no condensation). Turn off the MAIN POWER switch using the procedure on page 23 and clean the air filter (refer to page 41).
	Blinking in red (1 time)	The filter is clogged.		
	Blinking in red (2 times)	High temperature inside (Standby condition)		
Blinking in red (3 times)	Cooling fan has been stopped.	_____	<ul style="list-style-type: none"> Turn off the main power supply (MAIN POWER) switch in the procedure shown on page 23 and consult the distributor. 	
Lamp monitor LAMP1 LAMP2  	Lighting in red	Indicates the time for replacing the lamp unit.	<ul style="list-style-type: none"> Did you notice a "REPLACE LAMP" message on the screen when turning on the projector power supply? 	<ul style="list-style-type: none"> This lamp monitor lights up when the lamp unit used hours have reached 1 300 hours (3 800 hours when long life lamp units are used). Request the dealer to replace the lamp unit.
	Blinking in red (3 times)	Error is detected in the lamp or lamp power.	<ul style="list-style-type: none"> Did you turn the power back on immediately after turning it off? Some error has arisen in the lamp circuit. Check for fluctuation (or drop) in the source voltage. 	<ul style="list-style-type: none"> Wait until the lamp has cooled off, and then turn on the power. Turn off the MAIN POWER switch using the procedure on page 23 and consult the dealer.

- Attention**
- To solve any problems that the TEMP and LAMP monitor show, first turn the power off by following the steps on pages 22, 23.
 - If the power indicator blinks in red (3 times), the projector has malfunctioned. Please consult your dealer.

Cleaning and replacement of air filter

If too much dust accumulates on the air filter, [AIR FILTER]* appears at the lower left of the screen, and the temperature monitor (TEMP) will blink once. If even more dust is allowed to accumulate, the temperature inside the main unit will rise, the temperature monitor (TEMP) will blink twice, and the power is turned off. Clean the air filter section once every 100 hours or so as a guideline depending on the location of projector operation.

※ It appears only for 30 seconds within 3 minutes after the power is turned on. It disappears if any of the buttons on the rear side of the main unit or on the remote control is pressed.

■ Procedure of cleaning

① Turn off the main power and remove the power plug from the receptacle.

Turn off the main power supply observing the procedure (Powering off the projector) on page 23 and then remove the power plug.

② Dismantle the air filter.

There are two air filters, one at the left and one at the right.

Use your finger to pull the air filter tab toward you, and remove it from the main unit.

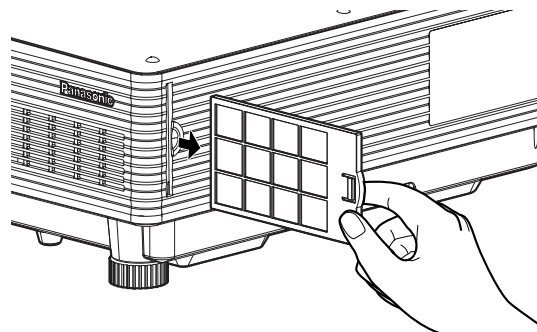
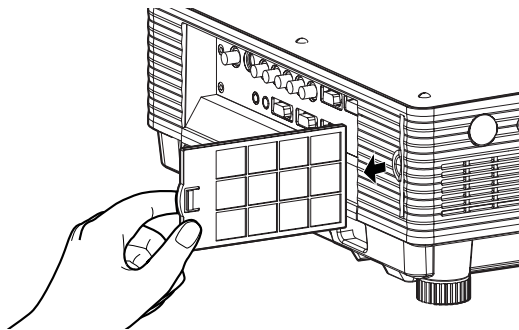

③ Clean the air filter.

Suck off deposited dust with a vacuum cleaner.

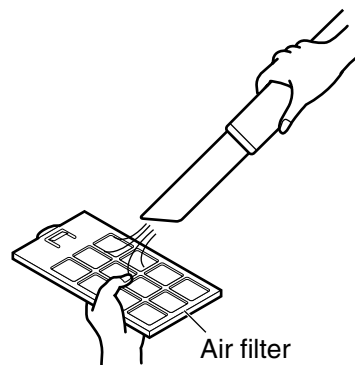

- Attention**
- Do not suck in the air filter itself.
 - Do not rinse off the air filter with water. Doing so will impair the filter's ability to provide protection from dust.

④ Set the air filter.

Set the air filter in the reverse order to step ②.

- Attention**
- Fit the air filters into place with the filter material facing the back. (The left and right filters have the same shape.)
 - The air filter must be fitted in place when using the projector. Using the projector without the air filter fitted inside, dirt and dust are sucked into the projector, causing failure.

- Note**
- If cleaning cannot remove the dust completely, then it is a sign to replace the air filter. Consult the dealer. In addition, when the lamp unit is replaced, also replace the air filter.
 - Be absolutely sure to use the air filter specifically designed for use with the projector.

Replacing the lamp unit

WARNING!

When replacing the lamp, allow it to cool for at least one hour before handling it.

Precautions on lamp unit replacement

Remove the power plug and confirm that the surroundings of the lamp unit have cooled off.

- Be careful when handling a light source lamp. The lamp unit has high internal pressure. If improperly handled, explosion might result.
- A used lamp unit may burst if it is handled violently.
For disposition of used lamps, request an industrial waste disposal contractor.
- Do not reset the cumulative time, except when the lamp unit has been replaced with a new unit.
- If you continue to use a lamp after the replacement time, the lamp may break.
- Phillips screwdriver is necessary when replacing a lamp unit.
Take care not to slip your hand when using a screwdriver.

- Attention**
- A lamp unit is an optional part. Contact the dealer.
Replacement lamp unit model No.: ET-LAD55 (single bulb), ET-LAD55W (double bulbs)
Rating: 300W
Long life lamp unit model No.: ET-LAD55L (single bulb), ET-LAD55LW (double bulbs)
Rating: 160W
 - Other lamps than specified above cannot be used. Be sure to use the specified lamp.

■ Timing of lamp unit replacement

The lamp used for the light source has its due life. The life of light source lamp used in the main unit is 1 500 hours*¹ (when “LAMP POWER” is “HIGH” and “LAMP SELECT” is “DUAL”). However, it may happen that the lamp becomes dead (will not light) by the time of 1 500 hours*¹ depending on the characteristics of individual lamps and working conditions (lamps may reduce their life affected by the times of lighting and the intervals between previous lighting and next lighting). Therefore, it is strongly recommended for the user to keep a spare bulb.

If your lamp unit is not replaced after 1 300 hours*² (with “LAMP POWER” set at “HIGH”), power supply will be turned off automatically at the time of 1 500 hours*¹, entering a standby state. After 1 500 hours*¹ of initial lighting, power supply is turned off automatically about 10 minutes later, entering a standby state even if it is turned on again.

● Indication after 1 300 hours*² (with “LAMP POWER” set at “HIGH”)



When lamp unit used hours have reached 1 300 hours*², lamp monitor (LAMP1 or LAMP2) light up including standby state. Further, an on-screen indication will appear for about 30 seconds as shown in the diagram on the left, recommending replacement of lamp unit. (The indication on the left diagram will disappear after about 30 seconds or when either control button on the rear of main unit or remote control button is operated.) After the time of 1 500 hours*¹, the on-screen indication will not disappear unless the menu (MENU) button is operated.

※¹ This time period is 4 000 hours when long life lamp units are used.

※² This time period is 3 800 hours when long life lamp units are used.

Replacing the lamp unit

- ⑩ Insert the power cord plug into the wall outlet and then press the MAIN POWER switch.

Attention • If the power does not turn on even after turning the MAIN POWER switch “I”, turn the MAIN POWER “O”, confirm that the lamp unit and door are installed correctly, and turn on again.

- ⑪ Press the “I” button so that a picture is projected onto the screen.

MENU	
PICTURE	
POSITION	
ADVANCED MENU	
LANGUAGE	
OPTION1	
OPTION2	

- ⑫ Press the “MENU” button to display the MAIN MENU screen, and then press the ▲ and ▼ buttons to move the cursor to select “OPTION2”.

SYSTEM INFORMATION	
ROM VERSION	1.00.00
SET RUNTIME	300h
LAMP1 LOW	100h
HIGH	200h
TOTAL	300h

- ⑬ Press the “ENTER” button to display the “OPTION2” screen, and select “SYSTEM INFORMATION” with the ▲ and ▼ buttons.

- ⑭ Press the “ENTER” button.

The SYSTEM INFORMATION screen will be displayed.

- ⑮ Press and hold the “ENTER” button on the projector or the remote control for approximately 3 seconds.

An item “LAMP TIME RESET” will be added.

LAMP TIME RESET	
LAMP1	
LAD55	1433h
LAD55L	0h
LAMP2	
LAD55	1100h
LAD55L	0h

- ⑯ Select the lamp which has been replaced with the ▲ and ▼ buttons.

LAMP1: Replace the LAMP UNIT 1

LAMP2: Replace the LAMP UNIT 2

- ⑰ Press the ENTER button, and when the “LAMP TIME RESET” display flashes, press the ENTER button again.

The used hours of the specified lamp unit will be reset to zero.

When more than one lamp has been replaced, repeat the procedure from step ⑯.

- Note** • When the “LAMP TIME RESET” display flashes, the lamp time reset can be canceled by pressing the MENU button.
• The used hours of the lamp units can also be reset to zero by taking the following action instead of steps ⑪ to ⑰.

When lamp unit 1 has been replaced:

In the standby mode, press the number buttons in the sequence of 737381, and then press the ENTER button.

When lamp unit 2 has been replaced:

In the standby mode, press the number buttons in the sequence of 737382, and then press the ENTER button.

When the used hours have been reset, the lamp monitor (LAMP1/LAMP2) will flash for 3 seconds.

Using Web Browser Control

This projector has networking functions which allow it to be controlled through a web browser on a PC.
The controlled items are:

- Projector's settings and adjustment
- Projector's status display
- Transmission of a E-mail message when the projector has a problem

■ Accessing from the Web browser

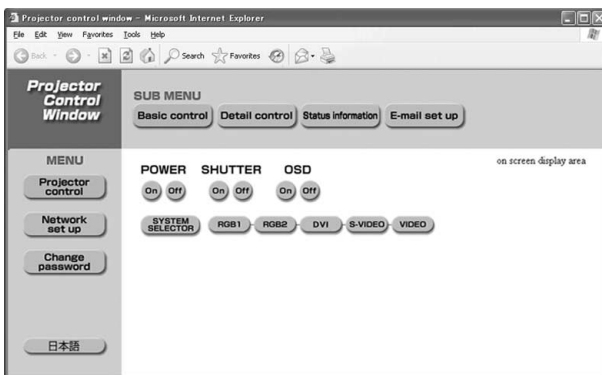

① Start the web browser on your PC, then enter the IP address which was set in the projector.

② Enter "user1" in the user name field, then enter the password in the password field.

The default setting is "panasonic" (all lower case). If you have changed the password, enter the new password here.

The host name set in the projector is displayed in the "Realm" field.

③ Click [OK].

The Basic Control page is displayed.

Note

- Avoid activating two or more Web browser simultaneously to work out setting or control actions.
- Change the password first of all.

■ Password change page

Click [Change password].

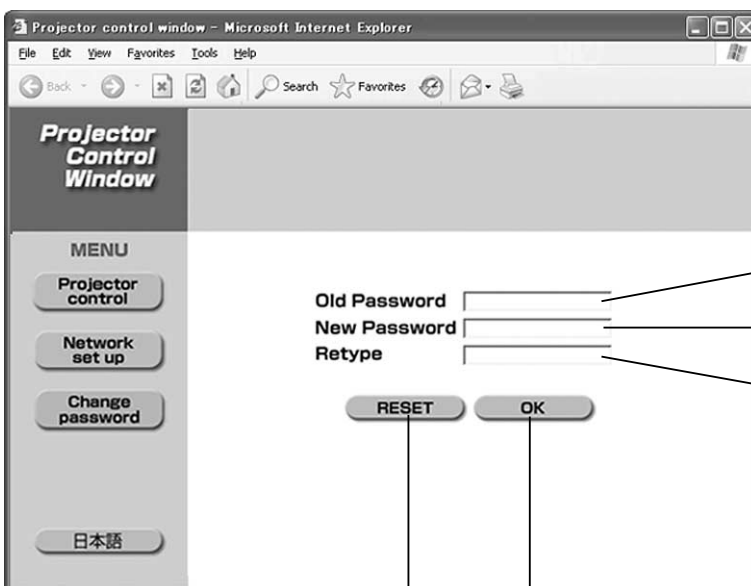

Old password input field

New password input field

New password input field (re-enter for confirmation)

Button for executing password change

Button for erasing all entered characters

Using Web Browser Control

■ Basic control page

This page is the first page displayed when the projector is accessed through a web browser. To move from another page, click [Projector control], then [Basic control].

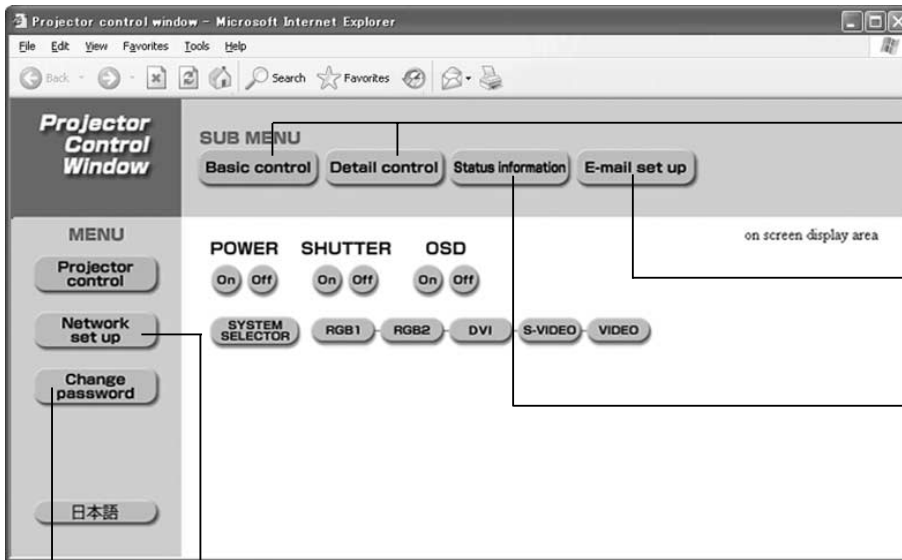

Control button

Click this item, and a projector control page appears.

E-mail set up button

Click this item, and an E-mail setting page appears.

Monitor information button

Click this item, and the status of the projector is displayed.

Network set up button

Click this item, and a network set up page for IP address and other items appear.

Change password button

Power On/Off control Shutter control

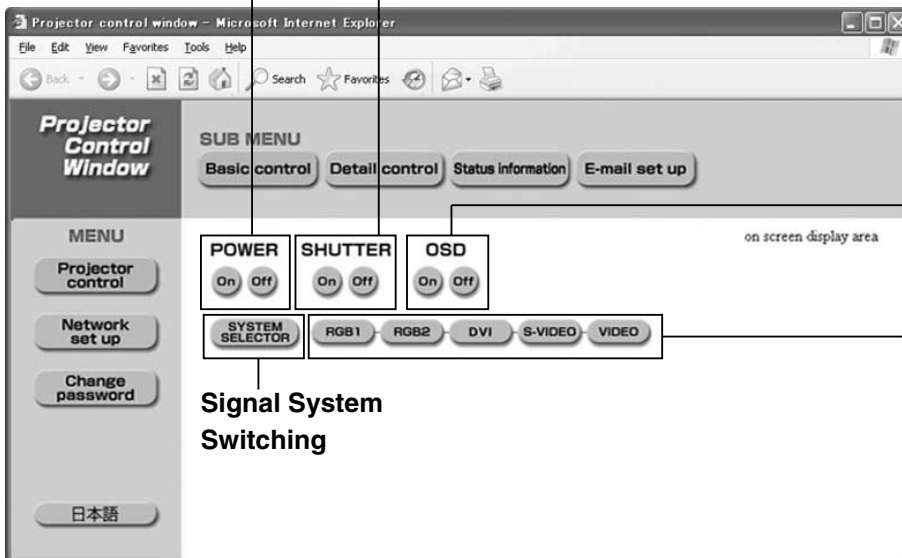

OSD

(On-screen Display) display/non-display

Use these to select the input signals.

Signal System Switching

■ Detail control page

Click [Projector control], then [Detail control] to display the Detail control page.

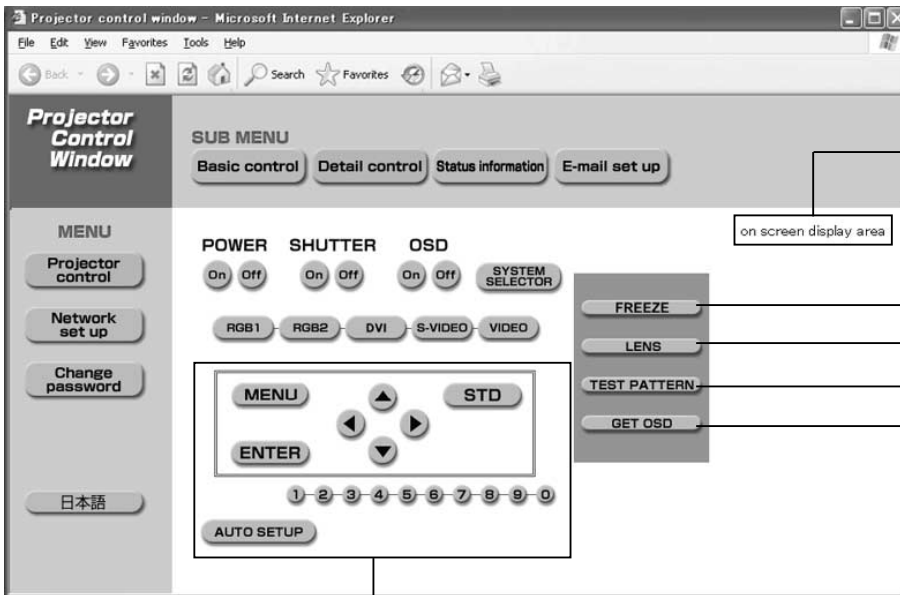

On-screen status is displayed, even if the on-screen of projector is set to off.

Temporary stop of video

Lens adjustment

Test pattern display

This button updates the on-screen description on the right of the control page with the latest information.

Pressing these buttons controls the projector and updates the on-screen description on the right of the control page when control is finished.

■ Monitor information page

Click [Projector control], then [Status information] to display the Status information page. This page displays the projector statuses established for the items shown below.

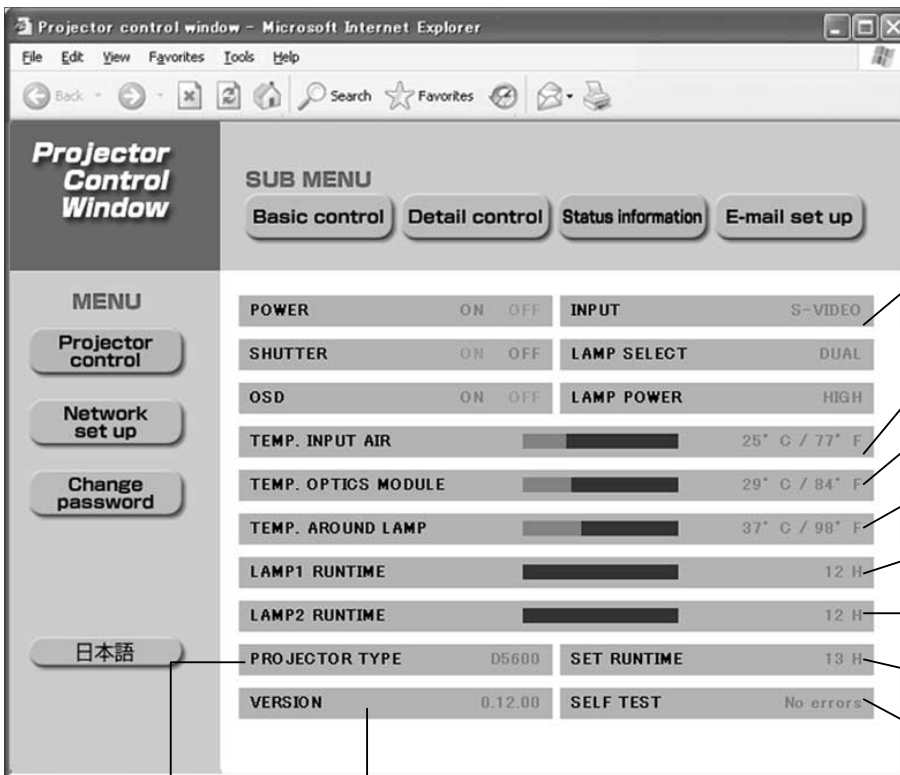

Displays the input switching status.

Displays temperature of projector's intake air.

Displays temperature inside the projector.

Displays temperature around the lamp.

Displays the lamp1 lit hours.

Displays the lamp2 lit hours.

Displays used hours of the projector.

Displays self-diagnosis information.

Displays the type of projector.

Displays the firmware version of the projector main unit.

Using Web Browser Control

■ Error information page

When [Error](#) is displayed on the status information screen, click it to display the error details.

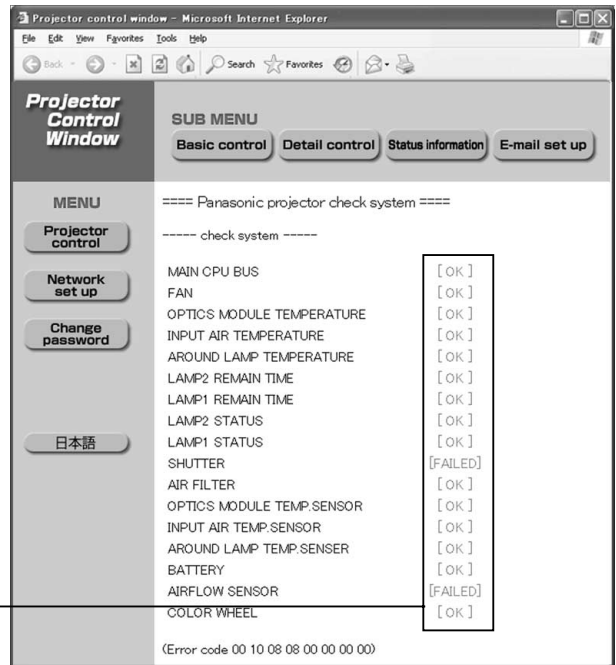
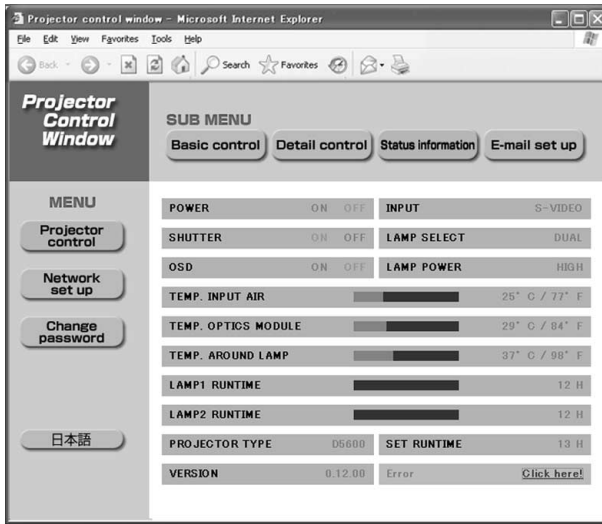

OK: Normal operation
FAILED: Occurrence of trouble

Note • Depending on the nature of the error, the projector may be placed in the standby mode for its own protection.

When [FAILED] has appeared for an item

Parameter	Description
MAIN CPU BUS	Trouble has occurred in the microcomputer circuitry. Consult your dealer.
FAN	Trouble has occurred in the fan or its drive circuit. Consult your dealer.
OPTICS MODULE TEMPERATURE	The temperature inside the projector is high. It may be that the projector is being used where the ambient temperature is high such as near a heating appliance.
INPUT AIR TEMPERATURE	The input air temperature is too high. It may be that the projector is being used where the ambient temperature is high such as near a heating appliance.
AROUND LAMP TEMPERATURE	The temperature near the lamp has risen very high. Something may be blocking the exhaust vent.
LAMP REMAIN TIME	The lamp runtime has exceeded the prescribed cumulative time, and it is now time to replace the lamp.
LAMP STATUS	The lamp has failed to light. Wait a short while for the lamp to cool off, and then turn on the power.
SHUTTER	Trouble has occurred in the shutter circuitry. Consult your dealer.
AIR FILTER	Too much dust accumulates on the air filter. Turn off the MAIN POWER switch using the procedure on page 23 and clean the air filter (refer to page 41).
OPTICS MODULE TEMP.SENSOR	Trouble has occurred in the temperature detection sensor inside the projector. Consult your dealer.
INPUT AIR TEMP.SENSOR	Trouble has occurred in the sensor used to detect the input air temperature. Consult your dealer.
AROUND LAMP TEMP. SENSOR	Trouble has occurred in the temperature detection sensor around lamps. Consult your dealer.
BATTERY	The backup battery has been run out. Consult your dealer.
AIRFLOW SENSOR	Trouble has occurred in the air volume sensor. Consult your dealer.
COLOR WHEEL	Trouble has occurred in the colour wheel or the colour wheel drive circuit. Consult your dealer.

■ E-mail setup page

With this projector, if a problem occurs or if the lamp usage time reaches a set value, an e-mail message can be sent to one or more preset e-mail addresses (maximum two addresses). Click [Projector Control], then [E-mail set up] to display the E-mail setup page.

Select "Enable" to use the E-mail function.

Enter the IP address or server name of the E-mail server (SMTP). The DNS server must be set if the server name is entered.

Enter the E-mail address of the projector. (maximum 63 characters)

The user can enter the location of, for example, the installed projector so that the recipient may easily identify the originator of the E-mail. (maximum 63 characters)

The user can modify the minimum time interval of temperature warning mail. The default value is 60 minutes. In this case, the user cannot send another mail for 60 minutes after sending previous temperature warning mail even the set warning temperature is reached again.

The user can modify the threshold temperature for sending temperature warning mail. If the temperature rises above the set value, control sends temperature warning mail.

Enter the E-mail address of your desired recipient.

Select the conditions for sending E-mail.
ERROR: an error is detected by self-diagnosis.
LAMP RUNTIME: remaining lamp service time has reached the value set in the field.
INPUT AIR TEMPERATURE: intake air temperature has reached the value set in the field.

Periodic warning interval setting (e-mail is sent on the checked days of the week/times)

(Continued on next page)

ENGLISH

■ E-mail setup page (continuing)

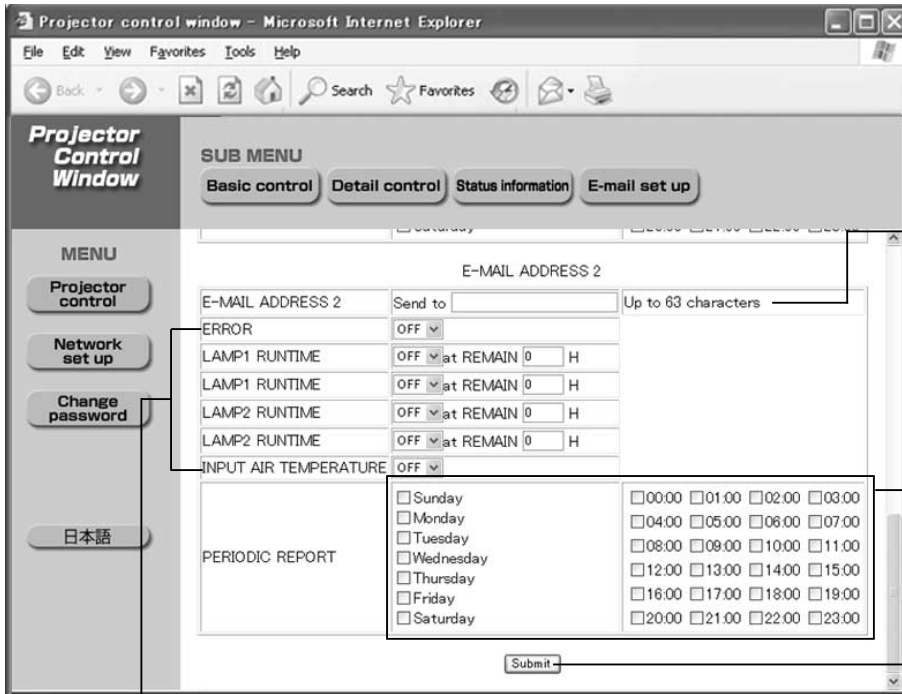

Enter the E-mail address to which the E-mail is to be sent when two E-mail addresses are going to be used. Do not enter it when the second E-mail address is not going to be used.

Check these boxes when E-mail is to be sent periodically to two E-mail addresses. E-mail will be sent at the times and on the days checked.

Button to update settings

Select the conditions for sending the second E-mail.

ERROR: an error is detected by self-diagnosis.

LAMP RUNTIME: remaining lamp service time has reached the value set in the field.

INPUT AIR TEMPERATURE: intake air temperature has reached the value set in the field.

Note • Only alphanumeric characters, ".", "_", "-", or "@" are available to set an e-mail address.

■ DNS server set up page

Click [Network set up], then [DNS server set up] to display the DNS server set up page.

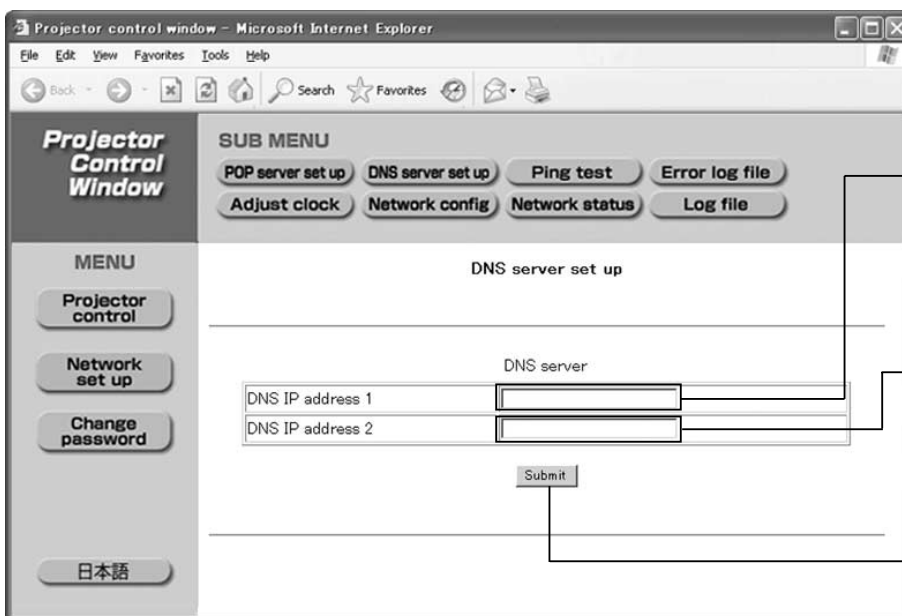

Primary DNS server address
Available input characters: Numbers (0 - 9), period (.) (ex. 192.168.0.253)

Secondary DNS server address
Available input characters: Numbers (0 - 9), period (.) (ex. 192.168.0.254)

Button to update settings

POP server setup page

The POP server is set on this page when POP authentication is required for mail transmissions. Click [Network set up], then [POP server set up] to display the POP server setup page.

Select "Enable" for this setting only when authentication is required for sending mail.

POP server name field
Available input characters: Alphanumeric characters (A-Z, a-z, 0-9), hyphen (-), period (.)

POP server user name field

POP server password field

Button to update settings

Ping test page

This page makes it possible to check whether the network is connected to the E-mail server, POP server, DNS server, etc.

Click [Network set up], then [Ping test] to display the Ping test page.

Enter the IP address of the server to be tested.

Button for conducting the test.

```
PING 192.168.0.122 (192.168.0.122): 56 data bytes
64 bytes from 192.168.0.122: icmp_seq=0 ttl=128 time=0.6 ms
64 bytes from 192.168.0.122: icmp_seq=1 ttl=128 time=3.1 ms
64 bytes from 192.168.0.122: icmp_seq=2 ttl=128 time=4.5 ms
64 bytes from 192.168.0.122: icmp_seq=3 ttl=128 time=5.8 ms

--- 192.168.0.122 ping statistics ---
4 packets transmitted, 4 packets received, 0% packet loss
round-trip min/avg/max = 0.6/3.5/5.8 ms
```

Display which appears when the connection was successful.

```
PING 192.168.0.122 (192.168.0.122): 56 data bytes

--- 192.168.0.122 ping statistics ---
4 packets transmitted, 0 packets received, 100% packet loss
```

Display which appears when the connection failed.

■ Contents of mail sent

- Mail with the contents shown below is sent when the E-mail settings have been established.

```

==== Panasonic projector report(CONFIGURE) ====
Projector Type      : D5600

----- E-mail setup data -----
TEMPERATURE WARNING SETUP
MINIMUM TIME       at [ 60] minutes interval
INPUT AIR TEMPERATURE Over [ 45C / 113F ]

ERROR              [ ON ]
LAMP1 RUNTIME      [ ON ] at REMAIN [ 100] H
LAMP1 RUNTIME      [ ON ] at REMAIN [ 200] H
LAMP2 RUNTIME      [ ON ] at REMAIN [ 300] H
LAMP2 RUNTIME      [ ON ] at REMAIN [ 400] H
INPUT AIR TEMPERATURE [ OFF ]

PERIODIC REPORT
Sunday [ ON ] Monday [ OFF ] Tuesday [ ON ] Wednesday [ OFF ]
Thursday [ ON ] Friday [ OFF ] Saturday [ ON ]

00:00 [ ON ] 01:00 [ OFF ] 02:00 [ ON ] 03:00 [ OFF ]
04:00 [ OFF ] 05:00 [ ON ] 06:00 [ OFF ] 07:00 [ ON ]
08:00 [ ON ] 09:00 [ OFF ] 10:00 [ ON ] 11:00 [ OFF ]
12:00 [ OFF ] 13:00 [ ON ] 14:00 [ OFF ] 15:00 [ ON ]
16:00 [ ON ] 17:00 [ OFF ] 18:00 [ ON ] 19:00 [ OFF ]
20:00 [ OFF ] 21:00 [ ON ] 22:00 [ OFF ] 23:00 [ ON ]

----- check system -----
MAIN CPU BUS      [ OK ]
FAN               [ OK ]
OPTICS MODULE TEMPERATURE [ OK ]
INPUT AIR TEMPERATURE [ OK ]
AROUND LAMP TEMPERATURE [ OK ]
LAMP2 REMAIN TIME [ OK ]
LAMP1 REMAIN TIME [ OK ]
.
.
.
    
```

- Mail with the contents shown below is sent when an error has occurred.

```

==== Panasonic projector report(ERROR) ====
Projector Type      : D5600

----- check system -----
MAIN CPU BUS      [ OK ]
FAN               [ OK ]
OPTICS MODULE TEMPERATURE [ OK ]
INPUT AIR TEMPERATURE [ OK ]
AROUND LAMP TEMPERATURE [ OK ]
LAMP2 REMAIN TIME [ OK ]
LAMP1 REMAIN TIME [ OK ]
LAMP2 STATUS      [ OK ]
LAMP1 STATUS      [ OK ]
SHUTTER           [ FAILED ]
AIR FILTER        [ OK ]
OPTICS MODULE TEMP.SENSOR [ OK ]
INPUT AIR TEMP.SENSOR [ OK ]
AROUND LAMP TEMP.SENSOR [ OK ]
BATTERY           [ OK ]
AIRFLOW SENSOR    [ OK ]
COLOR WHEEL       [ OK ]
(Error code 00 10 00 00 00 00 00)
Input air temperature : 30 degC / 86 degF
Optics module temperature : 30 degC / 86 degF
Around lamp temperature : 37 degC / 98 degF
SET RUNTIME        30 H
POWER ON           33 times
LAMP1 ON           34 times
LAMP1 LOW          25 H
LAMP1 HIGH         5 H
LAMP2 ON           24 times
LAMP2 LOW          16 H
LAMP2 HIGH         4 H
LAMP1 REMAIN       1476 H
LAMP2 REMAIN       1484 H

----- Network configuration -----
IP address 192.168.0.8
MAC address 00:00:00:00:00:00
Thu Mar 02 14:11:02 2006
----- Memo -----
    
```

■ Adjust clock page

Click [Network set up], then [Adjust clock] to display the Adjust clock page.

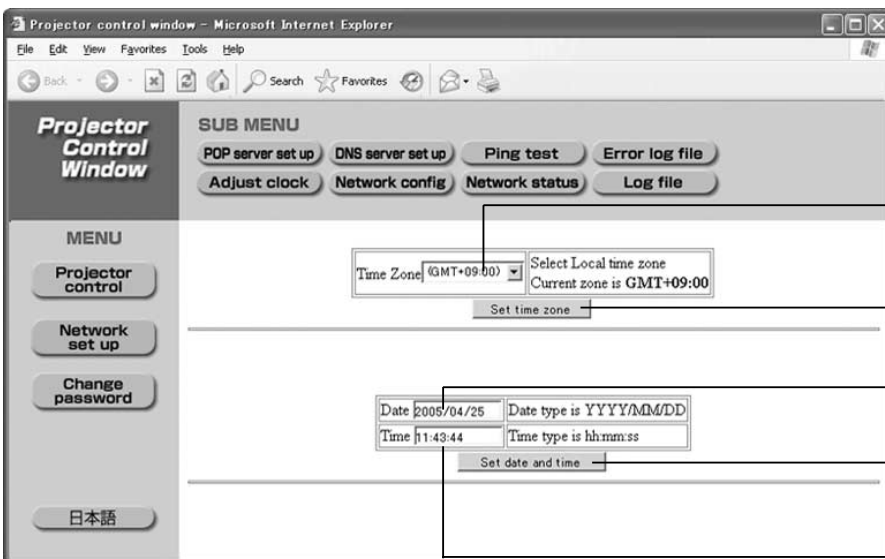

Time zone selection

Button to update time zone setting

New date field

Button to update time and date settings

New time field

- Note**
- If the time becomes incorrect immediately after setting the correct time, then the battery needs to be changed. Contact the dealer where you bought the projector to have the battery changed.

■ Network config page

Projector Control Window

SUB MENU

POP server set up DNS server set up Ping test Error log file
Adjust clock Network config Network status Log file

MENU

Projector control
Network set up
Change password
日本語

Configuration of network

DHCP client	OFF	Dynamic Host Configuration protocol
IP address	192.168.0.8	
Subnet mask	255.255.255.0	
Gate way address	192.168.0.1	
Host name	PROJECTOR	Up to 12 characters. alphabet (A-Z), digits (0-9), minus sign (-), and period (.).

Submit

Set this to ON to enable the DHCP client function.

Enter the IP address if DHCP server is not used.

Enter the subnet mask if DHCP server is not used.

Enter the gateway address if DHCP server is not used.

Enter the name of the projector here. Enter the host name here if it is required when the DHCP server is going to be used, for instance.

■ Network status page

Click [Network set up], then [Network status] to display the Network status page.

Projector Control Window

SUB MENU

POP server set up DNS server set up Ping test Error log file
Adjust clock Network config Network status Log file

MENU

Projector control
Network set up
Change password
日本語

Network status

Version

Network module version: 0.03B

Network

IP ADDRESS	192.168.0.8
SUB NET MASK	255.255.255.0
MAC ADDRESS	00:00:00:00:00:00

Collisions: 3

RX

packets	93	errors	0	dropped	0	overruns	0	frame	0
---------	----	--------	---	---------	---	----------	---	-------	---

TX

packets	87	errors	0	dropped	0	overruns	0	carrier	0
---------	----	--------	---	---------	---	----------	---	---------	---

Network software version display

Set IP address display

Set subnet mask display

MAC address display

Network status display

Using the PJLink™ protocol

The network functions of the projector are compatible with PJLink™※ Class 1. The operations mentioned below can be performed from a personal computer using the PJLink™ protocol.

- Projector settings
- Projector status inquiry

■ Supported commands

The commands for controlling the projector using the PJLink™ protocol are as given in the table below.

Command	Control Description	Remarks
POWR	Power control	Parameter 0 = Standby 1 = Power "ON"
POWR ?	Power status inquiry	Parameter 0 = Standby 1 = Power "ON" 2 = Cooling down 3 = During warm-up
INPT	Input selection	Parameter 11 = RGB1 12 = RGB2 21 = VIDEO 22 = S-VIDEO 31 = DVI
INPT ?	Input selection inquiry	
AVMT	Shutter control	Parameter 30 = Shutter mode OFF (Mute reset of video) 31 = Shutter mode ON (Mute video)
AVMT ?	Shutter status inquiry	
ERST ?	Error status inquiry	Parameter 1st byte: Refers to fan error; one of 0 to 2 2nd byte: Refers to lamp error; one of 0 to 2 3rd byte: Refers to temperature error; one of 0 to 2 4th byte: 0 fixed 5th byte: Refers to filter warning; one of 0 to 2 6th byte: Refers to some other error; one of 0 to 2 The meaning of 0 to 2 is as given below. 0 = Error not detected 1 = Warning 2 = Error
LAMP ?	Lamp status inquiry	Parameter First number (digits 1 to 5): Lamp cumulative time Second number: 0 = Lamp OFF; 1 = Lamp ON
INST ?	Input selection list inquiry	Parameter responds with following values: "11 12 21 22 31"
NAME ?	Projector name inquiry	Responds with the name set in "HOST NAME" of "NETWORK"
INF1 ?	Manufacturer's name inquiry	Responds with "Panasonic"
INF2 ?	Model name inquiry	Responds with "D5600" or "DW5000"
INFO ?	Other information inquiry	Responds with version number and so on
CLSS ?	Class information inquiry	Responds with "1"

■ PJLink™ security authentication

The password used in PJLink™ is the same as the password set in the Web Browser Control. To use PJLink™ without authentication, do not set any password in Web Browser Control.

※ PJLink™ is the applied-for trademark or a registered trademark in Japan, USA, and in other countries and regions. For specifications of PJLink™, see the website of the Japan Business Machine and Information System Industries Association.

URL <http://pjlink.jbmia.or.jp/>

Before asking for service

---Before asking for service, check the following points.

Symptoms	Checks
Power does not turn on	<ul style="list-style-type: none"> • Is the power cord plug correctly plugged in? • Is the MAIN POWER turned on? • Is electricity running to the power outlet? • Is the temperature monitor (TEMP) indicator on the front of the unit flashing or turned on? (See page 40) • Is the lamp monitor (LAMP) indicator on the front of the unit flashing or turned on? (See page 40) • Is the lamp unit door installed correctly? • A wrong ID is set. (See pages 15 and 34)
No image	<ul style="list-style-type: none"> • Is the lens cap still on the lens? • Is the image input correctly connected? • Is the input mode set correctly? (See page 22) • Is the black level adjustment set at the minimum level? (See page 28) • Is the equipment connected to the projector operating correctly? • Is the shutter function turned on? (See page 25)
Image is blurred	<ul style="list-style-type: none"> • Is the lens focused properly? (See page 24) • Is the projection distance correct? (See pages 17 to 18) • Is the lens dirty? • Is the projector positioned directly in front of the screen? (See page 16)
Light colour/ bad colour tone	<ul style="list-style-type: none"> • Is the colour density and colour tone setting correct? (See page 28) • Is the equipment connected to the projector correctly adjusted?
Remote control does not operate	<ul style="list-style-type: none"> • Are the batteries exhausted? • Are the battery polarities set correctly? (See page 14) • Are there any obstacles between the remote control and the remote control sensor? (See page 14) • Are you trying to operate the remote control beyond its operable range? (See page 14) • Are you controlling from external equipment using the REMOTE2 terminal? (See page 39) • Is there any external light interfering with remote control operation? • A wrong ID is set. (See pages 15 and 34) • Is the on-screen display function at "OFF"? (See page 9)
Abnormal image	<ul style="list-style-type: none"> • Is the input mode properly set? (See page 22) • Is the correct signal system (TV system) selected? (See page 29) • Are there any malfunctions on the source side, such as bad video tapes? • Are you inputting a signal that is not compatible with this projector? (See page 57)
Does not display images from PCs	<ul style="list-style-type: none"> • Is the cable too long? • Is the video output signal setting of the computer correctly set? (Read the operating instructions of the your PC.)

Specifications

Model No.	PT-D5600E	PT-D5600EL	PT-DW5000E	PT-DW5000EL
Power supply	AC 220-240 V, 50 Hz/60 Hz			
Power consumption	750 W (about 15 W in standby without fan running)			
DLP™ panel	0.7 inch (aspect ratio 4:3)		0.65 inch (aspect ratio 15:9)	
Panel size	DMD™ element, DLP™ type			
Display system	786 432 pixels (1 024 x 768 dots)		983 040 pixels (1 280 x 768 dots)	
Number of pixels				
Lens				
Powered zoom	1 to 1.32	Option	1 to 1.32	Option
Powered focus control	F=1.7 to 2.0 f=25.6 mm to 33.8 mm		F=1.7 to 2.0 f=25.6 mm to 33.8 mm	
Projection lamp	2 bulbs x 300 W UHM lamp			
Optical output	5 000 lm*1		4 500 lm*1	
Applicable scanning frequency	Horizontally 15.73 kHz/15.63 kHz, vertically 59.94 Hz/50 Hz			
For video signal (S-video included)	Horizontally 15 kHz–91 kHz, vertically 50 Hz–85 Hz, Panasonic Intelligent Auto Scanning (PIAS) system			
For RGB signal	Dot clock frequency Less than 108 MHz			
For DVI-D signal	Compliant with HDCP*2 EDID1:480p, 576p, 720/60p, 720/50p, 1080/60i, 1080/50i EDID2:VGA60, SVGA60, XGA50, XGA60, XGA70, XGA85, WXGA768/50, WXGA768/60, SXGA60			
For YPBPR signal	[480i], horizontally 15.73 kHz, vertically 59.94 Hz [480p], horizontally 31.5 kHz, vertically 59.94 Hz [576i], horizontally 15.63 kHz, vertically 50 Hz [576p], horizontally 31.25 kHz, vertically 50 Hz [720/60p], horizontally 45 kHz, vertically 60 Hz [720/50p], horizontally 37.5 kHz, vertically 50 Hz [1035/60i], horizontally 33.75 kHz, vertically 60 Hz [1080/60i], horizontally 33.75 kHz, vertically 60 Hz [1080/50i], horizontally 28.13 kHz, vertically 50 Hz • HD/SYNC, VD terminals are not compliant with 3 value composite SYNC.			
Colour system	7 standards (NTSC/NTSC4.43/PAL/PAN-N/PAL-M/SECAM/PAL60)			
Screen size	50 inch–600 inch			
Screen aspect ratio	4:3		15:9	
Projection scheme	Menu-selectable from front/rear/ceiling mount, and floor standing			
Contrast ratio	2 000:1 (when “HIGH” is selected as the “CONTRAST MODE” setting)			
Interface ports	1 set, BNC x 5			
RGB1 input terminal	[For YPBPR input] Y: 1.0 V[p-p] synchronization signal included, PbPR: 0.7 V[p-p] 75 Ω [For RGB input] 0.7 V[p-p] 75 Ω For G-SYNC: 1.0 V[p-p] 75 Ω HD/SYNC: TTL, high-impedance, positive/negative polarity automatically adjusted VD: TTL, high-impedance, positive/negative polarity automatically adjusted • However, HD/SYNC, and VD terminals are not compliant with 3-value direct SYNC.			

*1 These values are for the lens provided with the PT-D5600E/PT-DW5000E. Note that these values change according to the lens used.

*2 HDCP (High-bandwidth Digital Content Protection)

HDCP is a digital video signal encryption system developed with the aim of protecting digital content.

Model No.	PT-D5600E	PT-D5600EL	PT-DW5000E	PT-DW5000EL
Interface ports				
RGB2 input terminal	1 set of high-density, D-sub 15p (female) [For YP _B PR input] Y: 1.0 V [p-p] synchronization signal included, P _B PR: 0.7 V [p-p] 75 Ω [For RGB input] 0.7 V [p-p] 75 Ω For G-SYNC: 1.0 V [p-p] 75 Ω HD/SYNC: TTL, high-impedance, positive/negative polarity automatically adjusted VD: TTL, high-impedance, positive/negative polarity automatically adjusted • However, HD/SYNC, and VD terminals are not compliant with 3-value direct SYNC.			
Video input terminal	1 set BNC			
S-video input terminal	1.0 V [p-p] 75 Ω			
Serial input/output terminal	1 set Mini DIN 4p			
Remote1 input/output terminal	Y 1.0 V [p-p] C 0.286 V [p-p] 75 Ω Compliant with S1 signals			
Remote2 terminal	D-sub 9-pin (male/female), RS232C compliant Used for personal computer control			
DVI-D terminal	1 set each for M3 stereo mini jack Wired remote control, used for link control			
LAN terminal	D-sub 9-pin (female) Used for external control DVI-D 24-pin Single link, compatible with HDCP RJ-45 Compliant with PLink™			
Length of power supply cord	3.0 m			
Cabinet	Molded resin			
Outside dimensions	Width: 530 mm; Height : 167 mm; Depth: 425 mm			
Mass	14.5 kg	14.0 kg	14.5 kg	14.0 kg
Working environment condition	※ ³ Ambient temperature: 0 °C to 45 °C Ambient humidity: 20 % to 80 % (no condensation)			
Remote control				
Power source	3 V DC (two AAA dry cells)			
Operation range	approx. 7 m (in front of beam receiver)			
Mass	95 g (including dry cells)			
Outside dimensions	Width: 45 mm, Thickness: 23 mm, Depth: 145 mm			
Option				
Hanging attachment (For high ceiling)	ET-PKD55			
Hanging attachment (For low ceiling)	ET-PKD55S			
Projection lens	PT-D5600E/PT-D5600EL ET-DLE100, ET-DLE200, ET-DLE300, ET-DLE400, ET-DLE050 PT-DW5000E/PT-DW5000EL ET-DLE100, ET-DLE200, ET-DLE310, ET-DLE410, ET-DLE050			
Wireless mouse receiver	ET-RMRC2			
Replacement lamp unit	ET-LAD55 (single bulb), ET-LAD55W (double bulbs)			
Long life lamp unit	ET-LAD55L (single bulb), ET-LAD55LW (double bulbs)			

• The outside dimensions do not include the lens and other protruding parts. See page 59 for further details.

※³ When using the projector at high altitudes (1 400 to 2 700 m), the upper limit for the ambient temperature drops by 5 °C.

Compatible Signal List

Display mode	Resolution (as a number of dots) ^{※1}	Scanning frequency		Dot clock frequency (MHz)	Image quality ^{※2}	Format
		Horizontal (kHz)	Vertical (Hz)			
NTSC/NTSC4.43/ PAL-M/PAL60	720 x 480i	15.7	59.9		A	Video/S-Video
PAL/PAL-N/SECAM	720 x 576i	15.6	50.0		A	Video/S-Video
480i	720 x 480i	15.7	59.9	13.5	A	YPbPr/RGB
576i	720 x 576i	15.6	50.0	13.5	A	YPbPr/RGB
480p	720 x 483	31.5	59.9	27.0	A	YPbPr/RGB/DVI
576p	720 x 576	31.3	50.0	27.0	A	YPbPr/RGB/DVI
1080/60i	1 920 x 1 080i	33.8	60.0	74.3	A	YPbPr/RGB/DVI
1080/50i	1 920 x 1 080i	28.1	50.0	74.3	A	YPbPr/RGB/DVI
720/60p	1 280 x 720	45.0	60.0	74.3	A	YPbPr/RGB/DVI
720/50p	1 280 x 720	37.5	50.0	74.3	A	YPbPr/RGB/DVI
VGA400	640 x 400	31.5	70.1	25.2	A	RGB
	640 x 400	37.9	85.1	31.5	A	RGB
VGA480 ^{※3}	640 x 480	31.5	59.9	25.2	A	RGB/DVI
	640 x 480	35.0	66.7	30.2	A	RGB
	640 x 480	37.9	72.8	31.5	A	RGB
	640 x 480	37.5	75.0	31.5	A	RGB
	640 x 480	43.3	85.0	36.0	A	RGB
SVGA ^{※3}	800 x 600	35.2	56.3	36.0	A	RGB
	800 x 600	37.9	60.3	40.0	A	RGB/DVI
	800 x 600	48.1	72.1	50.0	A	RGB
	800 x 600	46.9	75.0	49.5	A	RGB
MAC16	832 x 624	49.7	74.6	57.3	A	RGB
XGA ^{※3}	1 024 x 768	39.6	50.0	51.9	AA	RGB/DVI
	1 024 x 768	48.4	60.0	65.0	AA	RGB/DVI
	1 024 x 768	56.5	70.1	75.0	AA	RGB/DVI
	1 024 x 768	60.0	75.0	78.8	AA	RGB/DVI
	1 024 x 768	68.7	85.0	94.5	AA	RGB/DVI
	1 024 x 768i	35.5	87.0	44.9	AA	RGB
MXGA	1 152 x 864	64.0	71.2	94.2	A	RGB
	1 152 x 864	67.5	74.9	108.0	A	RGB
	1 152 x 864	76.7	85.0	121.5	B	RGB
WXGA	1 280 x 800	41.3	50.0	68.6	A	RGB
	1 280 x 800	49.7	59.8	83.5	A	RGB
	1 280 x 768	39.6	50.0	65.2	AA	RGB/DVI
	1 280 x 768	47.7	60.0	80.1	AA	RGB/DVI
MAC21	1 152 x 870	68.7	75.1	100.0	A	RGB
MSXGA ^{※3}	1 280 x 960	60.0	60.0	108.0	A	RGB
SXGA ^{※3}	1 280 x 1 024	64.0	60.0	108.0	A	RGB/DVI
	1 280 x 1 024	80.0	75.0	135.0	B	RGB
	1 280 x 1 024	91.1	85.0	157.5	B	RGB
	1 400 x 1 050	64.0	60.0	108.0	A	RGB/DVI
UXGA ^{※3}	1 600 x 1 280	75.0	60.0	162.0	B	RGB

※1 Character “i” that follows the number of displayed dots stands for interlace signal.

※2 The symbols used to denote the image quality have the following significance:

AA = the images are projected at the highest quality (With XGA for the PT-D5600E/PT-D5600EL; with XGA/WXGA 1 280 x 768 for the PT-DW5000E/PT-DW5000EL); A = the images are converted by the image processing circuit and projected; B = the amount of data is scaled down and simplified images are projected.

※3 These signals support the frame lock function.

Note

- The number of display dots are 1 024 x 768 for PT-D5600E/PT-D5600EL, and 1 280 x 768 for PT-DW5000E/PT-DW5000EL. If signals with a number of display dots differing from the data listed above are supplied, they will be converted into signals with 1 024 x 768 dots and displayed for PT-D5600E/PT-D5600EL, and 1 280 x 768 for PT-DW5000E/PT-DW5000EL.

Dimensions

unit : mm

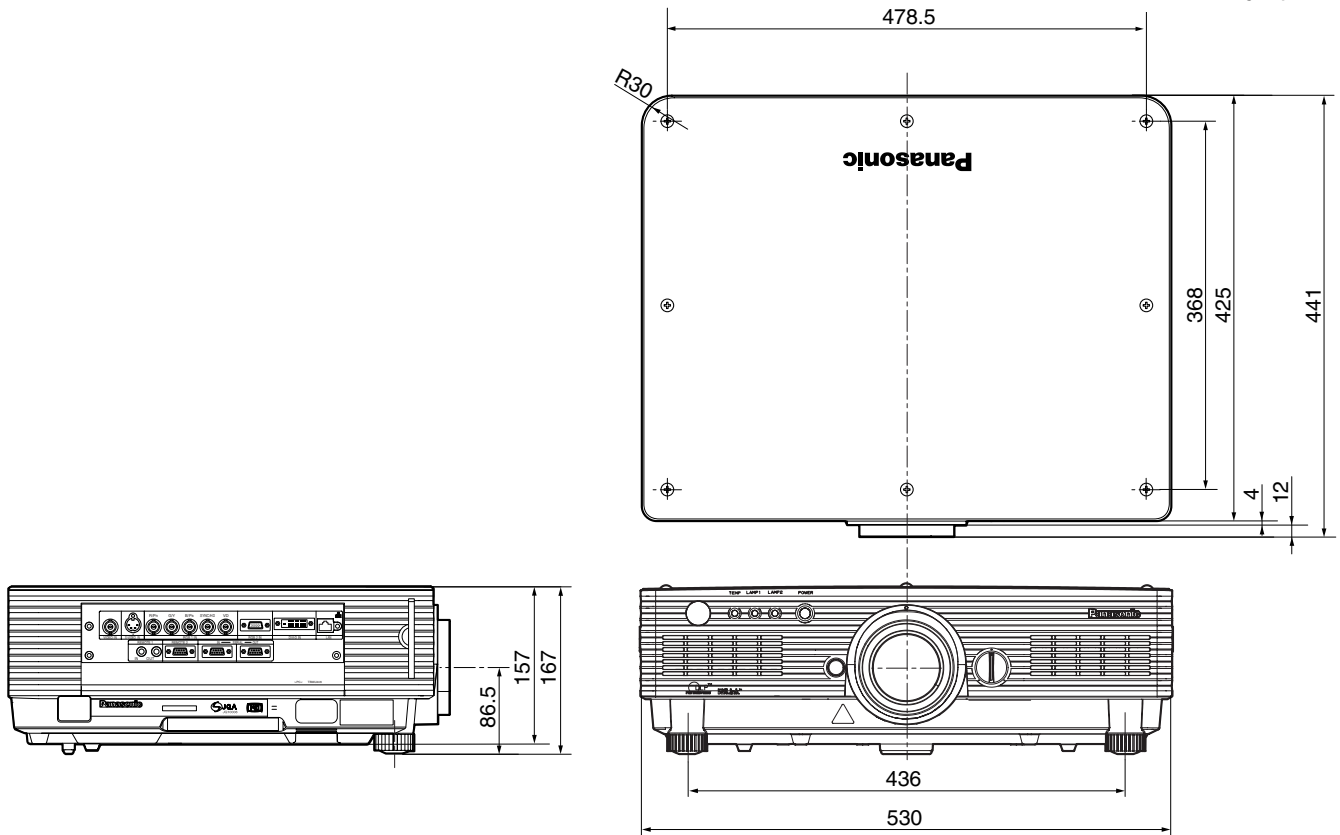

ENGLISH

Installation dimensions diagram

(Figure 1 : Dimensions applying when one unit is used)

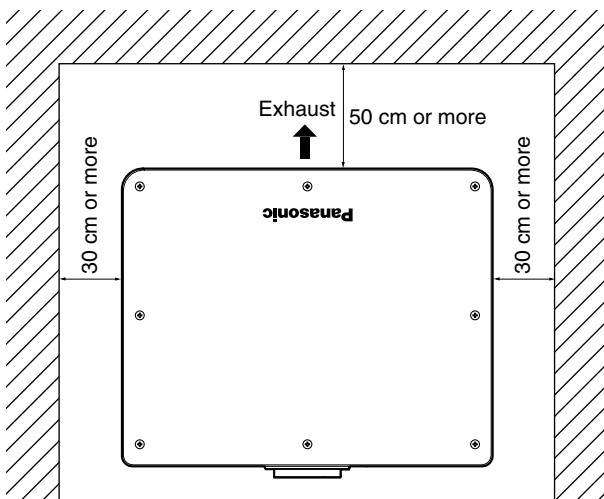

(Figure 2 : Dimensions applying when two units are used)

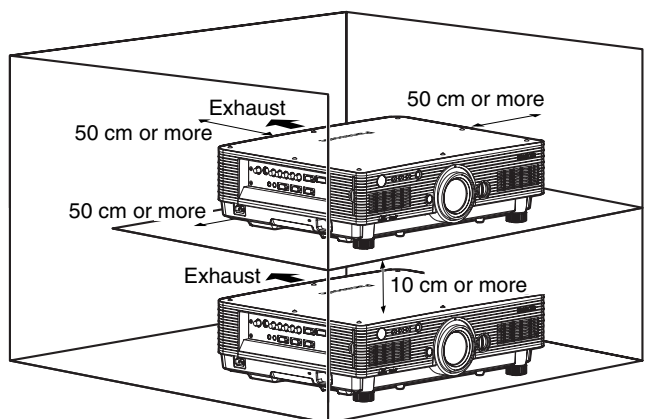

- Attenzione**
- Leave a clearance of at least 50 cm so that the ventilation opening on the rear panel will not be blocked.
 - Be careful not to retain exhausted air on the back side of the main unit. Also take steps to ensure that the hot air blown out from the air exhaust outlet will not be sucked into the air intake.
 - Install with clearances of at least 30 cm provided for the side panels to enable the air filter to be removed and re-installed.
 - When the projector is to be placed inside a box and used, leave the clearances shown in Fig. 2 and ensure that the temperature during operation remains within the 0 to 35 °C range.

Information on Disposal for Users of Waste Electrical & Electronic Equipment (private households)



This symbol on the products and/or accompanying documents means that used electrical and electronic products should not be mixed with general household waste.

For proper treatment, recovery and recycling, please take these products to designated collection points, where they will be accepted on a free of charge basis. Alternatively, in some countries you may be able to return your products to your local retailer upon the purchase of an equivalent new product.

Disposing of this product correctly will help to save valuable resources and prevent any potential negative effects on human health and the environment which could otherwise arise from inappropriate waste handling. Please contact your local authority for further details of your nearest designated collection point.

Penalties may be applicable for incorrect disposal of this waste, in accordance with national legislation.

For business users in the European Union

If you wish to discard electrical and electronic equipment, please contact your dealer or supplier for further information.

Information on Disposal in other Countries outside the European Union

This symbol is only valid in the European Union.

If you wish to discard this product, please contact your local authorities or dealer and ask for the correct method of disposal.

Note:

Purchase of this equipment includes the rights to use this software (the built-in microcomputer and information recorded on ROMs) but does not grant copyrights. Do not reverse engineer, change or modify the software. The guarantee will not be valid for any malfunctions caused by such actions.

Trademark Acknowledgement

- Digital Light Processing, DLP, and Digital Micromirror Device, DMD are registered trademarks of the Texas Instruments.
- VGA and XGA are trademarks of International Business Machines Corporation.
- S-VGA is a registered trademark of the Video Electronics Standards Association.
- "Microsoft Windows" is a registered trademark of the Microsoft Corporation (U.S.A.) in the U.S. and other countries.
- "Netscape" and "Netscape Navigator" are registered trademarks of the Netscape Communications Corporation in the U.S. and other countries.
- PJLink is the applied-for trademark or a registered trademark in Japan, USA, and in other countries and regions.
- HDMI and High-Definition Multimedia Interface are the trademarks or registered trademarks of HDMI Licensing LLC.

All other trademarks are the property of the various trademark owners.

Matsushita Electric Industrial Co., Ltd

Web Site : <http://panasonic.net>

© 2006 Matsushita Electric Industrial Co., Ltd. All Rights Reserved.

M0506-0

Free Manuals Download Website

<http://myh66.com>

<http://usermanuals.us>

<http://www.somanuals.com>

<http://www.4manuals.cc>

<http://www.manual-lib.com>

<http://www.404manual.com>

<http://www.luxmanual.com>

<http://aubethermostatmanual.com>

Golf course search by state

<http://golfingnear.com>

Email search by domain

<http://emailbydomain.com>

Auto manuals search

<http://auto.somanuals.com>

TV manuals search

<http://tv.somanuals.com>