

# Panasonic®

Heavy Duty Weather Band Receiver

Model: **CR-W402UA**



## Operating Instructions





- Please read these instructions (including "Limited Warranty" and "Customer Services Directory") carefully before using this product and keep this manual for future reference.

# Safety Information

■ Read the operating instructions for the unit and all other components of your car audio system carefully before using the system. They contain instructions about how to use the system in a safe and effective manner. Panasonic assumes no responsibility for any problems resulting from failure to observe the instructions given in this manual.

■ This manual uses pictographs to show you how to use the product safely and to alert you to potential dangers resulting from improper connections and operations. The meanings of the pictographs are explained below. It is important that you fully understand the meanings of the pictographs in order to use this manual and the system properly.

 **Warning** This pictograph intends to alert you to the presence of important operating instructions and installation instructions. Failure to heed the instructions may result in severe injury or death.

 **Caution** This pictograph intends to alert you to the presence of important operating instructions and installation instructions. Failure to heed the instructions may result in injury or material damage.

 **Warning**

**Observe the following warnings when handling this unit.**

- ❑ **The driver should not operate the system while driving.**  
Operating the system will distract the driver from looking ahead of the vehicle and can cause accidents. Always stop the vehicle in a safe location and use the parking brake before operating the system.
- ❑ **Use the proper power supply.**  
This product is designed for operation with a negative grounded 12 V DC battery system. Never operate this product with other battery systems, especially a 24 V DC battery system.
- ❑ **Do not expose the unit to direct sunlight or excessive heat.**  
Otherwise these will raise the interior temperature of the unit, and it may lead to smoke, fire, or other damage to the unit.
- ❑ **Do not use the product where it is exposed to water, moisture, or dust.**  
Exposure of the unit to water, moisture, or dust may lead to smoke, fire, or other damage to the unit. Make especially sure that the unit does not get wet in car washes or on rainy days.
- ❑ **Do not disassemble or modify the unit.**  
Do not disassemble, modify the unit or attempt to repair the product yourself. If the product needs to be repaired, consult the shop where you purchased this unit or an authorized Panasonic Servicenter.
- ❑ **Do not use the unit when it is out of order.**  
If the unit is out of order (no power, no sound) or in an abnormal state (has foreign matter in it, is exposed to water, is smoking, or smells), turn it off immediately and consult the store where you purchased it.
- ❑ **Refer fuse replacement to qualified service personnel.**  
When the fuse blows out, eliminate the cause and have it replaced with the fuse prescribed for this unit by a qualified service engineer. Incorrect replacement of the fuse may lead to smoke, fire, and damage to the product.
- ❑ **Any NOAA broadcast weather report, including current and forecasts, may not reflect your actual weather conditions at your exact time and location. You should always pay attention to your actual weather conditions to make safe decisions accordingly.**

**Observe the following warnings when installation.**

- ❑ **Disconnect the lead from the negative (–) battery terminal before installation.**  
Wiring and installation with the negative (–) battery terminal connected may cause electrical shock and injury due to a short circuit.  
Some cars equipped with the electrical safety system have specific procedures of battery terminal disconnection.  
**FAILURE TO FOLLOW THE PROCEDURE MAY LEAD TO THE UNINTENDED ACTIVATION OF THE ELECTRICAL SAFETY SYSTEM RESULTING IN DAMAGE TO THE VEHICLE AND PERSONAL INJURY OR DEATH.**
- ❑ **Never use safety-related components for installation, grounding, and other such functions.**  
Do not use safety-related vehicle components (fuel tank, brake, suspension, steering wheel, pedals, airbag, etc.) for wiring or fixing the product or its accessories.
- ❑ **Installing the product on the air bag cover or in a location where it interferes with airbag operation is prohibited.**
- ❑ **Check for piping, gasoline tank, electric wiring, and other items before installing the product.**  
If you need to open a hole in the vehicle chassis to attach or wire the product, first check where the wire harness, gasoline tank, and electric wiring are located. Then open the hole from outside if possible.
- ❑ **Never install the product in a location where it interferes with your field of vision.**
- ❑ **Never have the power cord branched to supply other equipment with power.**
- ❑ **After installation and wiring, you should check the normal operation of other electrical equipment.**  
The continuation of their using in abnormal conditions may cause fire, electrical shock or a traffic accident.
- ❑ **In the case of installation to an airbag-equipping car, confirm warnings and cautions of the vehicle manufacturer before installation.**
- ❑ **Make sure the leads do not interfere with driving or getting in and out of the vehicle.**
- ❑ **Insulate all exposed wires to prevent short circuiting.**

## Caution

### Observe the following cautions when handling this unit.

- Keep the sound volume at an appropriate level.**  
Keep the volume level low enough to be aware of road and traffic conditions while driving.
- This unit is designed for use exclusively in automobiles.**
- Do not operate the unit for a prolonged period with the engine turned off.**  
Operating the audio system for a long period of time with the engine turned off will drain the battery.
- To ensure safety, never attempt to preset stations while you are driving.**
- Depending upon the transmission condition of electro-magnetic waves, the geographical reasons and/or the weather conditions, you may not receive the NOAA radio partially or at all.**
- Make sure that your weather radio can receive properly before driving, especially, before use in a critical condition.**

### Observe the following cautions when installation.

- Refer wiring and installation to qualified service personnel.**  
Installation of this unit requires special skills and experience. For maximum safety, have it installed by the shop where you purchased it. Panasonic is not liable for any problems resulting from your own installation of the unit.
- Follow the instruction to install and wire the product.**  
Not following the instructions to properly install and wire the product could cause an accident or fire.
- Take care not to damage the leads.**  
When wiring, take care not to damage the leads. Prevent them from getting caught in the vehicle chassis, screws, and moving parts such as seat rails. Do not scratch, pull, bend or twist the leads. Do not run them near heat sources or place heavy objects on them. If leads must be run over sharp metal edges, protect the leads by winding them with vinyl tape or similar protection.
- Use the designated parts and tools for installation.**  
Use the supplied or designated parts and appropriate tools to install the product. The use of parts other than those supplied or designated may result in internal damage to the unit. Faulty installation may lead to an accident, a malfunction or fire.
- Do not block the air vent or the cooling plate of the unit.**  
Blocking these parts will cause the interior of the unit to overheat and will result in fire or other damage.
- Do not install the product where it is exposed to strong vibrations or is unstable.**  
Avoid slanted or strongly curved surfaces for installation. If the installation is not stable, the unit may fall down while driving and this can lead to an accident or injury.
- Installation Angle**  
The product should be installed in a horizontal position with the front end up at a convenient angle, but not more than 30°. The user should bear in mind that in some areas there may be restrictions on how and where this unit must be installed. Consult your dealer for further details.
- Wear gloves for safety. Make sure that wiring is completed before installation.**
- To prevent damage to the unit, do not connect the power connector until the whole wiring is completed.**
- Do not connect more than one speaker to one set of speaker leads. (except for connecting to a tweeter)**

The following applies only in the U.S.A.

#### Part 15 of the FCC Rules

##### FCC Warning:

This device complies with Part 15 of the FCC Rules for Radio Receiver. Operation is subject to the condition that this device may not cause harmful interference. Any unauthorized changes or modifications to this equipment may void the user's authority to operate this device.

## Accessories

1. Operating Instructions .....	1
2. Supplied Hardware .....	1 set (→ page 18)
3. Product Registration Card .....	1
4. Customer Care Plan .....	1

# Customer Services Directory

---

## U.S.A.

### **Customer Services Directory (United States and Puerto Rico)**

Obtain Product Information and Operating Assistance; locate your nearest Dealer or Servicenter; purchase Parts and Accessories; or make Customer Service and Literature requests by visiting our Web Site at:

<http://www.panasonic.com/support>

or, contact us via the web at:

<http://www.panasonic.com/contactinfo>

You may also contact us directly at:

1-800-211-PANA (7262),

Monday-Friday 9 am-9 pm; Saturday-Sunday 10 am-7 pm, EST.

For hearing or speech impaired TTY users,  
TTY : 1-877-833-8855

### **Accessory Purchases: (United States and Puerto Rico)**

Purchase Parts, Accessories and Instruction Books online for all Panasonic Products by visiting our Web Site at:

<http://www.pasc.panasonic.com>

or, send your request by E-mail to:

[npcparts@panasonic.com](mailto:npcparts@panasonic.com)

You may also contact us directly at:

1-800-332-5368 (Phone) 1-800-237-9080 (Fax Only) (Monday-Friday 9 am to 8 pm, EST.)

Panasonic Services Company

20421 84th Avenue South, Kent, WA 98032

(We accept Visa, MasterCard, Discover Card, American Express, and Personal Checks)

For hearing or speech impaired TTY users,  
TTY : 1-866-605-1277

# Limited Warranty

## U.S.A.

### Limited Warranty (For USA and Puerto Rico Only)

PANASONIC CONSUMER ELECTRONICS COMPANY,  
DIVISION OF PANASONIC CORPORATION OF NORTH AMERICA  
One Panasonic Way, Secaucus, New Jersey 07094

### PANASONIC AUTO PRODUCTS LIMITED WARRANTY

#### LIMITED WARRANTY COVERAGE

If your product does not work properly because of defects in materials and workmanship.

Panasonic Consumer Electronics Company or Panasonic Sales Company (collectively referred to as "the warrantor") will, for the length of the period indicated in the chart below, which starts with the date of original purchase ("warranty period"), at its option either (a) repair your product with new or refurbished parts, or (b) replace it with a new or refurbished product. The decision to repair or replace will be made by the warrantor.

Categories	Parts	Labor
Audio Components (except items listed below)	One (1) Year	One (1) Year
<b>MXE</b> Series Audio Components (except items listed below)	Two (2) Years	Two (2) Years
Speakers Defective Car Audio Speakers under warranty must be exchanged at the place of purchase. Contact your Dealer for details.	One (1) Year	Not Applicable
Accessories (in exchange for defective items)	Ninety (90) Days	Not Applicable

During the "Labor" warranty period, there will be no charge for labor. During the "Parts" warranty period, there will be no charge for parts. You must carry in or mail in your product prepaid during the warranty period. If non-rechargeable batteries are included, they are not warranted. This warranty only applies to products purchased and serviced in the United States or Puerto Rico. This warranty is extended only to the original purchaser of a new product which was not sold "as is". A purchase receipt or other proof of the original purchase date is required for warranty service.

#### CARRY-IN OR MAIL-IN SERVICE

For Carry-In or Mail-In Service in the United States and Puerto Rico call 1-800-211-PANA (7262) or visit  
Panasonic Web Site: <http://www.panasonic.com>

#### LIMITED WARRANTY LIMITS AND EXCLUSIONS

This warranty **ONLY COVERS** failures due to defects in materials and workmanship, and **DOES NOT COVER** normal wear and tear or cosmetic damage. The warranty **ALSO DOES NOT COVER** damages which occurred during shipment, failures which are caused by products not supplied by the warrantor, failures which result from accident, misuse, abuse, neglect, bug infestation, mishandling, misapplication, alteration, faulty installation, set-up adjustment, maladjustment of consumer control, improper maintenance, improper antenna, inadequate signal reception or pickup, power line surge, improper voltage supply, lightning, modification, commercial use (such as use in hotels, offices, restaurants, or other business uses) or rental use of the product, or service by anyone other than the technician from Factory Servicenter or other authorized service centers, or damage that is attributable to acts of God.

**THERE ARE NO EXPRESS WARRANTIES EXCEPT AS LISTED UNDER "LIMITED WARRANTY COVERAGE". THE WARRANTOR IS NOT LIABLE FOR INCIDENTAL OR CONSEQUENTIAL DAMAGES RESULTING FROM THE USE OF THIS PRODUCT, OR ARISING OUT OF ANY BREACH OF THIS WARRANTY.** (As examples, this excludes damages for lost time, cost of having someone remove or re-install an installed unit if applicable, travel to and from the service, and loss of media, data or other memory contents. The items listed are not exclusive, but are for illustration only.) **ALL EXPRESS AND IMPLIED WARRANTIES, INCLUDING THE WARRANTY OF MERCHANTABILITY, ARE LIMITED TO THE PERIOD OF THE LIMITED WARRANTY.**

Some states do not allow the exclusion or limitation of incidental or consequential damages, or limitations on how long an implied warranty lasts, so the exclusions may not apply to you.

This warranty gives you specific legal rights and you may also have other rights which vary from state to state. If a problem with this product develops during or after the warranty period, you may contact your dealer or Servicenter. If the problem is not handled to your satisfaction, then write to warrantor's Consumer Affairs Department at the addresses of the warrantor.

#### PARTS AND SERVICE WHICH ARE NOT COVERED BY THIS LIMITED WARRANTY ARE YOUR RESPONSIBILITY.

Customer's Record

Model

No. \_\_\_\_\_

Serial

No. \_\_\_\_\_

Dealer's

No. \_\_\_\_\_

Code

No. \_\_\_\_\_

Dealer's

Address \_\_\_\_\_

Date of

Purchase \_\_\_\_\_

# Contents

---

Safety Information (Part 15 of the FCC Rules).....	Page 2
Accessories .....	3
Customer Services Directory .....	4
Limited Warranty .....	5
Contents .....	6

---

<input type="checkbox"/> <b>Power and Sound Controls</b> .....	7
Power, volume, mute, display change, SQ (Sound Quality), audio modes (Bass/Treble/Balance/Fader)	

---

<input type="checkbox"/> <b>Clock Adjustment</b> .....	10
Initial time, time readjustment	

---

<input type="checkbox"/> <b>Radio</b> .....	11
Band, manual tuning, seek tuning, preset station setting, preset station calling, weather band station	

---

<input type="checkbox"/> <b>Troubleshooting</b> .....	14
Troubleshooting tips, product servicing	

---

<input type="checkbox"/> <b>Maintenance</b> .....	16
Care of the unit	

---

<input type="checkbox"/> <b>Speaker Connections</b> .....	16
---	----

---

<input type="checkbox"/> <b>Installation Guide</b> .....	17
Installation hardware, overview, required tools, dashboard specifications, preparation, to remove the unit	

---

<input type="checkbox"/> <b>Electrical Connections</b> .....	20
Cautions, wiring diagram	

---

<input type="checkbox"/> <b>Specifications</b> .....	21
--	----

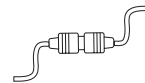
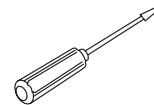
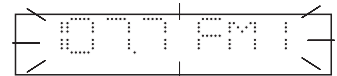
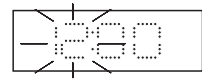

# Power and Sound Controls

## Power

Turn the key in the ignition until the accessory indicator lights.

**Power on:** Press **[PWR] (POWER)**.

**Power off:** Hold down **[PWR] (POWER)** for more than 1 second.

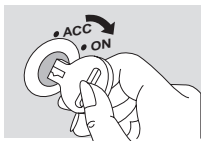

## Volume

Turn the knob clockwise to increase volume, and counterclockwise to decrease volume.



Volume level (0 to 40)  
(default: 18)

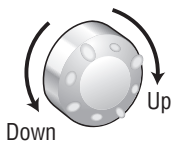

## Mute

Press **[MUTE]** to mute the sound completely.



Press **[MUTE]** again to cancel.

## Display Change

Press **[DISP]** to switch to the clock display.

**When the power is off:**



**Note:** "Adj" is displayed when the clock is not adjusted. (→ page 10)

# Power and Sound Controls (Continued)



## SQ (Sound Quality)

SQ is a function that can call up various sound types at the touch of button in accordance with your listening music type.

Press **[SQ]** for more than 2 seconds to select the sound type as follows:

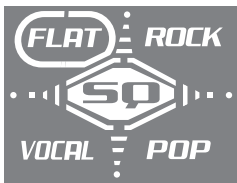

(FLAT) flat frequency response:  
does not emphasize any part. (default)

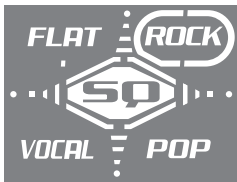

(ROCK) speedy and heavy sound:  
exaggerates bass and treble.

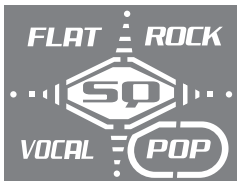

(POP) wide-ranged and deep sound:  
slightly emphasizes bass and treble.

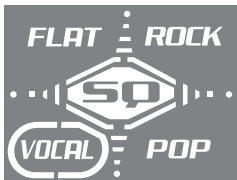

(VOCAL) clear sound:  
emphasizes middle tone and slightly emphasizes treble.

**Note:** Settings of SQ, bass and treble are influenced one another. If such an influence causes distortion to the audio signal, readjust bass/treble or volume.



# Audio Modes (Bass/Treble/Balance/Fader)

**Note:** If no operation takes place for more than 5 seconds in audio mode (2 seconds in volume mode), the display returns to the regular mode.

1 Push [SEL] to select the audio mode.

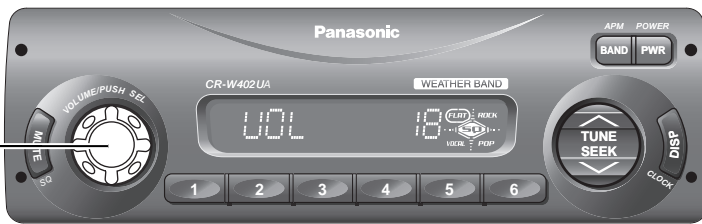
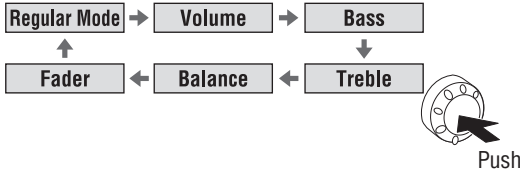

2 Turn [VOLUME] clockwise or counterclockwise to change each level.

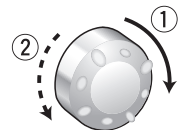

**VOL** 18 **Volume**  
(Setting Range: 0 to 40, Default: 18)

**VOL** 20  
① : UP  
② : Down

**BAS** 0 **Bass**  
(Setting Range: -12 dB to +12 dB by 2 dB, Default: 0 dB)

**BAS** 6  
① : Increased  
② : Decreased

**TRE** 0 **Treble**  
(Setting Range: -12 dB to +12 dB by 2 dB, Default: 0 dB)

**TRE** -6  
① : Increased  
② : Decreased

**BAL** 0 **Balance**  
(Setting Range: 15 levels each and 0 (center), Default 0)

**BAL** R 10  
① : Right enhanced  
② : Left enhanced

**FAD** 0 **Fader**  
(Setting Range: 15 levels each and 0 (center), Default 0)

**FAD** F 10  
① : Front enhanced  
② : Rear enhanced

# Clock Adjustment

## Selecting the Clock Display

Press **[DISP]** to change the display.

Radio mode display (default)

87.9 FM 1



10:08 FM 1

Clock display

The 12-hour system is used for the clock.



**[V TUNE]** **[^ TUNE]**  
(Hours, Minutes)

## Initial Time

① Press **[DISP]** (CLOCK).

Adj FM 1

② Hold down **[DISP]** (CLOCK) for more than 2 seconds.

12:00 FM 1

(Hours blink)

③ Adjust the hour.

8:00 FM 1

(Hours set)

Press **[^]**: sets the hour ahead.

Press **[V]**: sets the hour back.

④ Press **[DISP]** (CLOCK).

8:00 FM 1

(Minutes blink)

⑤ Adjust the minute.

8:15 FM 1

(Minutes set)

Press **[^]**: sets the minute ahead.

Press **[V]**: sets the minute back.

⑥ Press **[DISP]** (CLOCK).

8:15 FM 1

(End.)

## Time Readjustment

When you want to readjust the time, repeat steps ② to ⑥.

**Note:** Hold down **[V]** or **[^]** to change numbers rapidly.

# Radio

## ① Band

Press **[BAND]** to change the band.

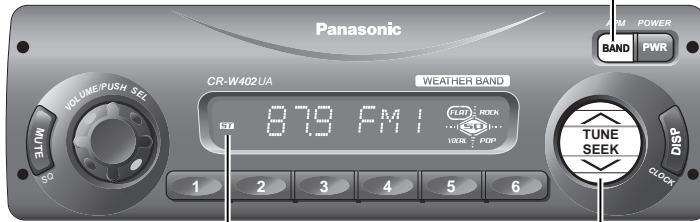
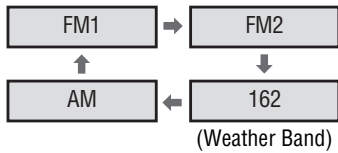

FM stereo indicator, lights while receiving an FM stereo signal.

## ② Manual Tuning

**[^TUNE]**: Higher frequency

**[vTUNE]**: Lower frequency

### Seek Tuning

Press and hold for more than 0.5 seconds and release it.

**[^TUNE]**: Higher frequency

**[vTUNE]**: Lower frequency

Tuning will automatically stop when the next broadcast station is received.

# Radio (Continued)

## Preset Station Setting

Up to 6 stations can be saved in each of the FM1, FM2 and AM preset station memories.

**Note:** Existing saved stations are overwritten with new stations after following this procedure.

### 1 Band

Press **[BAND] (APM)** to select a desired band.  
(→ page 11)

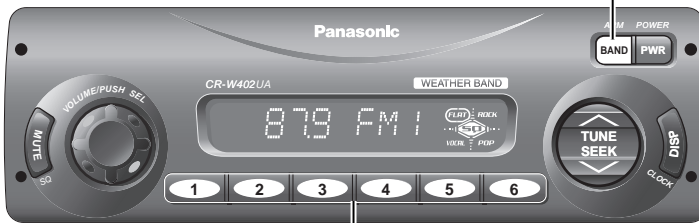

Preset buttons from [1] to [6]

### 2 Auto Preset Memory (APM)

Press and hold **[BAND] (APM: auto preset memory)** for more than 2 seconds.

- The 6 stations with good reception will be automatically saved in the memory under preset buttons from [1] to [6].
- Once set, the preset stations are sequentially scanned for 5 seconds each.
- To stop scanning, press one of the buttons from [1] to [6].

### Manual Preset Memory

- 1 Use manual or seek tuning to find a station.  
(→ page 11)
- 2 Press and hold one of the preset buttons from [1] to [6] until the display blinks once.

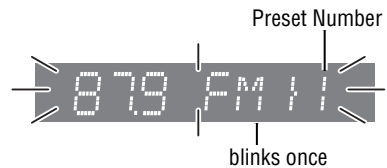

### Preset Station Calling

Press the corresponding preset button from [1] to [6] to tune in a preset station.

#### **Caution**

To ensure safety, never attempt to preset stations while you are driving.

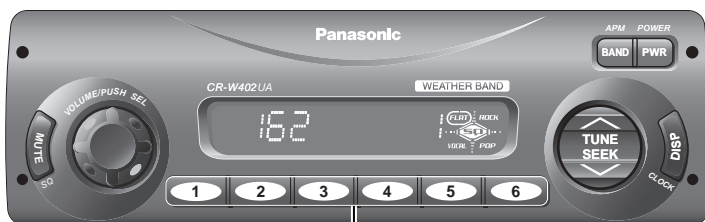

## Tuning in a Weather Band Station

- Press **[BAND]** (**APM**) to select WB (Weather Band). (→ page 11)
- Press any of the buttons **[1]** to **[6]** to monitor the preset station.



WB

Weather Band Frequency (channel) Number

**Note:** The weather band (CH1-6) has been preset. CH7 is selected by pressing **[V]** or **[^]**.

## Weather Band Stations

National Weather Radio Broadcasts from over 380 locations throughout the U.S. on seven VHF/FM frequencies.

Tune to weather band to receive continuous weather information 24 hours a day on one of the following frequencies.

1. 162.550 MHz
2. 162.400 MHz
3. 162.475 MHz
4. 162.425 MHz
5. 162.450 MHz
6. 162.500 MHz
7. 162.525 MHz

Occasionally the frequency of an existing or planned station must be changed because of unexpected radio frequency interfere with adjacent NOAA weather Radio Stations and/or with other Government or commercial Operations within the area. If you have a question concerning NOAA Weather Radio, please contact your nearest National Weather Service Office.

### Warning

A weather report (including both weather forecasts and current weather reports) of NOAA broadcasting may not accord with an actual weather condition in your place.

In the critical situation, you should always pay attention to the actual weather condition to safely make decisions.

# Troubleshooting

## If You Suspect Something Wrong

Check and take steps as described below.

If the described suggestions do not solve the problem, it is recommended to take the unit to your nearest authorized Panasonic Servicenter. The product should be serviced only by qualified personnel. Please refer the checking and the repair to professionals. Panasonic shall not be liable for any accidents arising out of neglect of checking the unit or your own repair after your checking.

**Never take measures especially for those other than indicated by *italic* letters in "Possible Solution" described below because those are too dangerous for users to handle themselves.**



## Warning

- Do not use the unit in an irregular condition, for example, without sound, or with smoke or a foul smell, which can cause ignition or electric shock. Immediately stop using the unit and consult your dealer.
- Never try to repair the unit by yourself because it is dangerous to do so.

## Troubleshooting Tips

### Common

Problem	Possible cause → Possible solution
No power.	Vehicle's ignition switch is not on. → <b>Turn your vehicle's ignition switch to ACC or ON.</b> Cables are not correctly connected. → <b>Connect cables correctly.</b> Power connector is not correctly connected. → <b>Connect the power connector to the terminal that is always active.</b> Power connector is not correctly connected. → <b>Connect the power connector to your vehicle's ACC source.</b> Grounding wire is not correctly connected. → <b>Connect the grounding wire to a metal part of the vehicle.</b>
No sound.	Mute is set to ON. → <b>Set it to OFF.</b> Cables are not correctly connected. → <b>Connect cables correctly.</b>
Noise.	The ground lead is not connected properly. → <b>Connect the ground lead properly.</b>

### Radio

Problem	Possible cause → Possible solution
Much noise in FM stereo and monaural broadcasts.	Station is too far, or signals are too weak. → <b>Select other stations of higher signal level.</b> The radio antenna is not extended enough. → <b>Extend fully the radio antenna.</b>
Preset station is reset.	Battery cable is not correctly connected. → <b>Connect the battery cable to the terminal that is always active.</b>

## ■ Sound Setting

Problem	Possible cause → Possible solution
No sound from left, right, front, or rear speaker.	Left and right balance, or front and rear balance is off on one side. → <b>Adjust BAL/FAD as appropriate.</b>
	Cables are not correctly connected. → <b>Connect the cables correctly.</b>
Left and right sounds are reversed in stereo listening.	The right speaker wire is connected to the left speaker and the left speaker wire to the right speaker. → <b>Connect the speaker wires to the correct ones.</b>

## Product Servicing

If the suggestions in the charts do not solve the problem, we recommend that you take it to your nearest authorized Panasonic Servicenter. The product should be serviced only by a qualified technician.

# Maintenance

## Care of the Unit

### ☐ Cleaning this Unit

Use a dry, soft cloth to wipe.

### ☐ Caution on Cleaning

Never use solvents such as benzene, thinner as they may mar the surface of the unit.

Your product is designed and manufactured to ensure the minimum of maintenance. Use a soft cloth for routine exterior cleaning. Never use benzene, thinner, or other solvents.

### Warning

Use fuses of the same specified rating (**15 A**). Using substitutes or fuses with higher ratings, or connecting the unit directly without a fuse could cause fire or damage to the unit. **If the replaced fuse fails, contact your nearest authorized Panasonic Servicer.**

# Speaker Connections

### Caution

Please follow the instructions given below. Failure to do so will cause damage to the unit and speakers.

#### <Right>

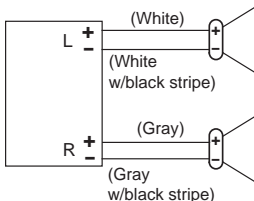

- Use ungrounded speaker only.
- The maximum speaker input should be 37 W or more. (If used with the optional power amplifier, the speaker input should be higher than the maximum amplifier output.)
- The speaker impedance should be 4 - 8  $\Omega$ .
- This unit uses the BTCL circuit, so each speaker should be connected separately using parallel vinyl insulated cords.
- The speaker cords and the power amplifier unit should be kept away (about 30 cm apart) from the antenna and antenna extension cord.

#### <Wrong>

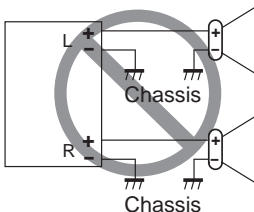

- Never connect the speaker cord to the body of the car.

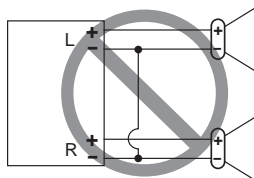

- Do not use a 3-wire type speaker system having a common earth lead.

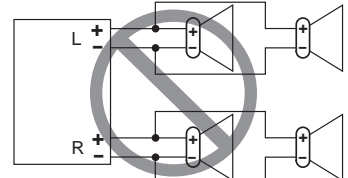

- Do not connect more than one speaker to one set of speaker leads.



# Installation Guide



## WARNING

❑ This installation information is designed for experienced installers and is not intended for non-technical individuals. It does not contain warnings or cautions of potential dangers involved in attempting to install this product.

Any attempt to install this product in a vehicle by anyone other than a qualified installer could cause damage to the electrical system and could result in serious personal injury or death.

❑ If your vehicle is equipped with air bag and/or anti-theft systems, specific procedures may be required for connection and disconnection of the battery to install this product. Before attempting installation of this electronic component, contact your vehicle dealer or manufacturer to determine the required procedure and strictly follow their instructions.

**FAILURE TO FOLLOW THE PROCEDURE MAY RESULT IN THE UNINTENDED DEPLOYMENT OF AIR BAGS OR ACTIVATION OF THE ANTI-THEFT SYSTEM RESULTING IN DAMAGE TO THE VEHICLE AND PERSONAL INJURY.**

## ❑ Overview

This product should be installed by a professional. However, if you plan to install this product yourself, your first step is to decide where to install it. The instructions in these pages will guide you through the remaining steps: (Please refer to the "WARNING" statement above.)

- Identify and label the car wires.
- Connect the vehicle wires to the wires of the power connector.
- Install the unit in the dashboard.
- check the operation of the unit.

If you encounter problems, please consult your nearest professional installer.



## Caution

This unit operates with a 12 V DC negative ground auto battery system only. Do not attempt to use it in any other system. Doing so could cause serious damage.

Before you begin installation, look for the items which are packed with your unit.

- **Operating Instructions** (including "Limited Warranty" and "Customer Services Directory").  
.....Keep for future reference in case the product needs servicing.
- **Installation Hardware** .....Needed for in-dash installation.

## ❑ Dashboard Specifications

Thickness Min. 4.75 mm { $\frac{3}{16}$ "}  
Max. 5.56 mm { $\frac{7}{32}$ "}

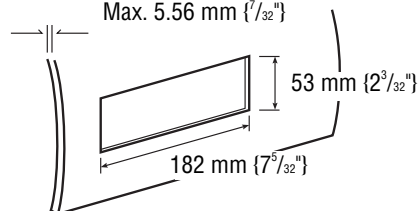

# Installation (continued)

## Precautions

### Warning

If your vehicle is equipped with air bag and/or anti-theft systems, specific procedures may be required for connection and disconnection of the battery to install this product.

Before attempting installation of this electronic component, contact your vehicle dealer or manufacturer to determine the required procedure and strictly follow their instructions.

**FAILURE TO FOLLOW THE PROCEDURE MAY RESULT IN THE UNINTENDED DEPLOYMENT OF AIR BAGS OR ACTIVATION OF THE ANTI-THEFT SYSTEM RESULTING IN DAMAGE TO THE VEHICLE AND PERSONAL INJURY.**

- Disconnect the cable from the negative  $\ominus$  battery terminal (see warning and caution below).
- Remove Mounting Collar ① from the main unit temporarily, which are already mounted at shipment.\*

### Caution

Various settings that have been stored in the memory in other on-board equipment (vehicle navigation etc.) may be lost if the battery terminals are disconnected.

Therefore, we recommend to make a record of or to back up the settings before disconnecting the terminals. After completing installation of the main unit, set the equipment again according to the record.

- Unit should be installed in a horizontal position with the front end up at a convenient angle, but not more than 30°.

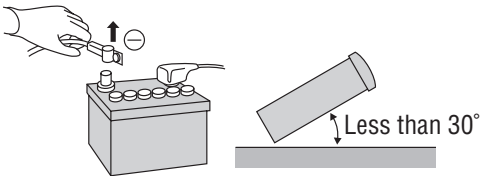

## Dashboard Installation

### Installation Opening

This unit can be installed in any dashboard having an opening as shown below. The dashboard should be 4.75 mm {3/16"} – 5.56 mm {7/32"} thick in order to be able to support the unit.

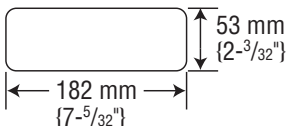

## Installation Hardware

No.	Item	Diagram	Q'ty
①	Mounting Collar*		1
②	Plain washer (5 mm $\varnothing$ )		2
③	Spring Washer (5 mm $\varnothing$ )		2
④	Hex. Nut (5 mm $\varnothing$ )		2
⑤	Rear Support Strap		1
⑥	Hex. Bolt (5 mm $\varnothing$ x 25 mm)		1
⑦	Toothed Lock Washer (5 mm $\varnothing$ )		1
⑧	Removal Tool (U-shaped)		2

### (a) Using the rear support strap ⑤

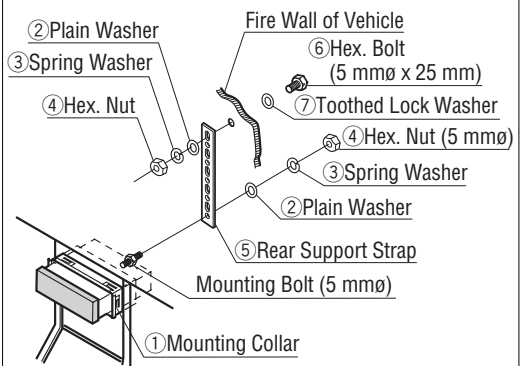

### (b) Using the rubber cushion (option)

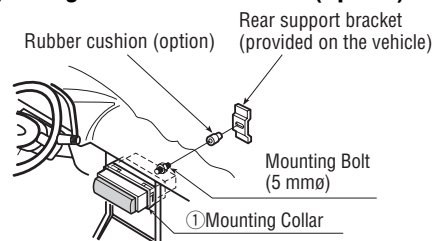

## Caution

- We strongly recommend that you wear gloves for installation work to protect yourself from injuries.
- When bending the mounting tab of the mounting collar with a screwdriver, be careful not to injure your hands and fingers.

First complete the electrical connections, and then check them for correctness. (→ page 20)

**The included Mounting Collar ① is designed specially for this unit. Do not use it to attach any other model.**

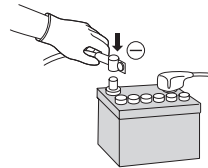
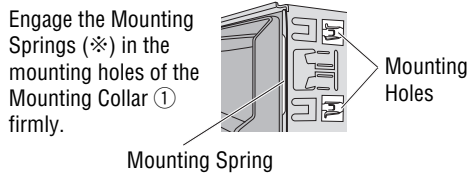
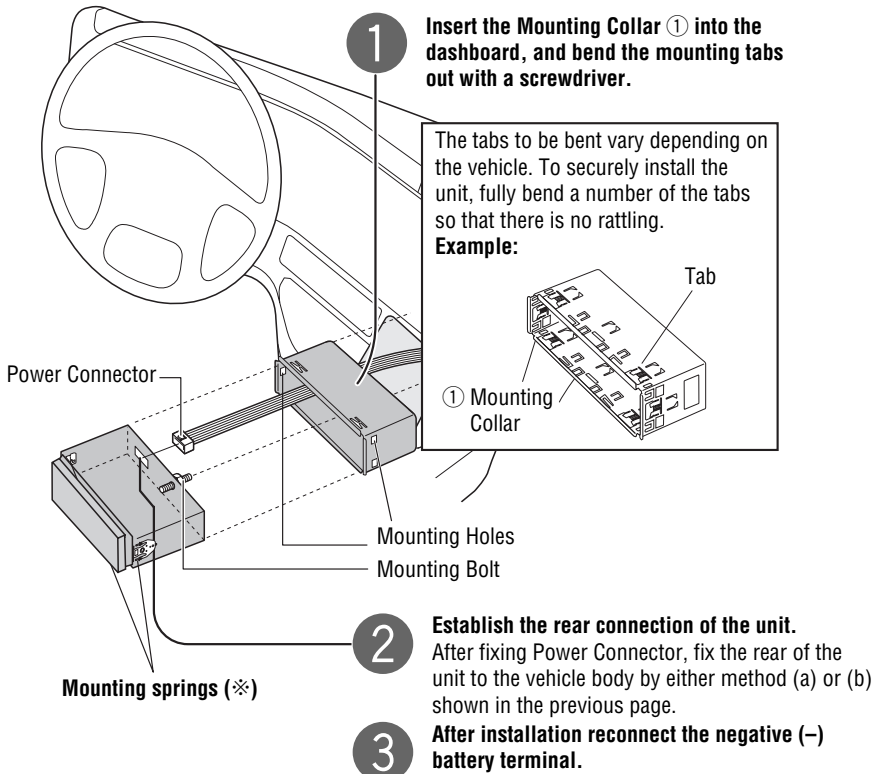

## To Remove the Unit from the vehicle's dashboard

Insert each Removal Tool ⑧ and pull.

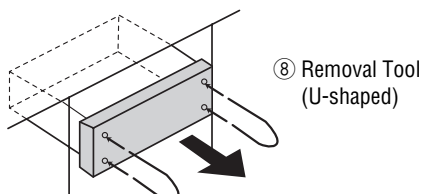

**Note:** Do not lose Removal Tools. They will be needed to remove the unit from the vehicle's dashboard.

# Electrical Connections

## ⚠ Caution

- This wiring information is for experienced technical individual, for safety reason, please your dealer wire this connection.
- This product is designed to operate with a 12 V DC, negative ground battery system.
- To prevent damage to the unit, be sure to follow the connection diagram below.
- Do not insert the power connector into the unit until the wiring is completed.
- Be sure to insulate any exposed wires from a possible short-circuit from the vehicle chassis. Bundle all cables and keep cable terminals free from touching any metal parts.
- Remember, if your vehicle has a drive computer or a navigation computer, the data of its memory maybe erased when the battery terminals are disconnected.

## □ Wiring Diagram

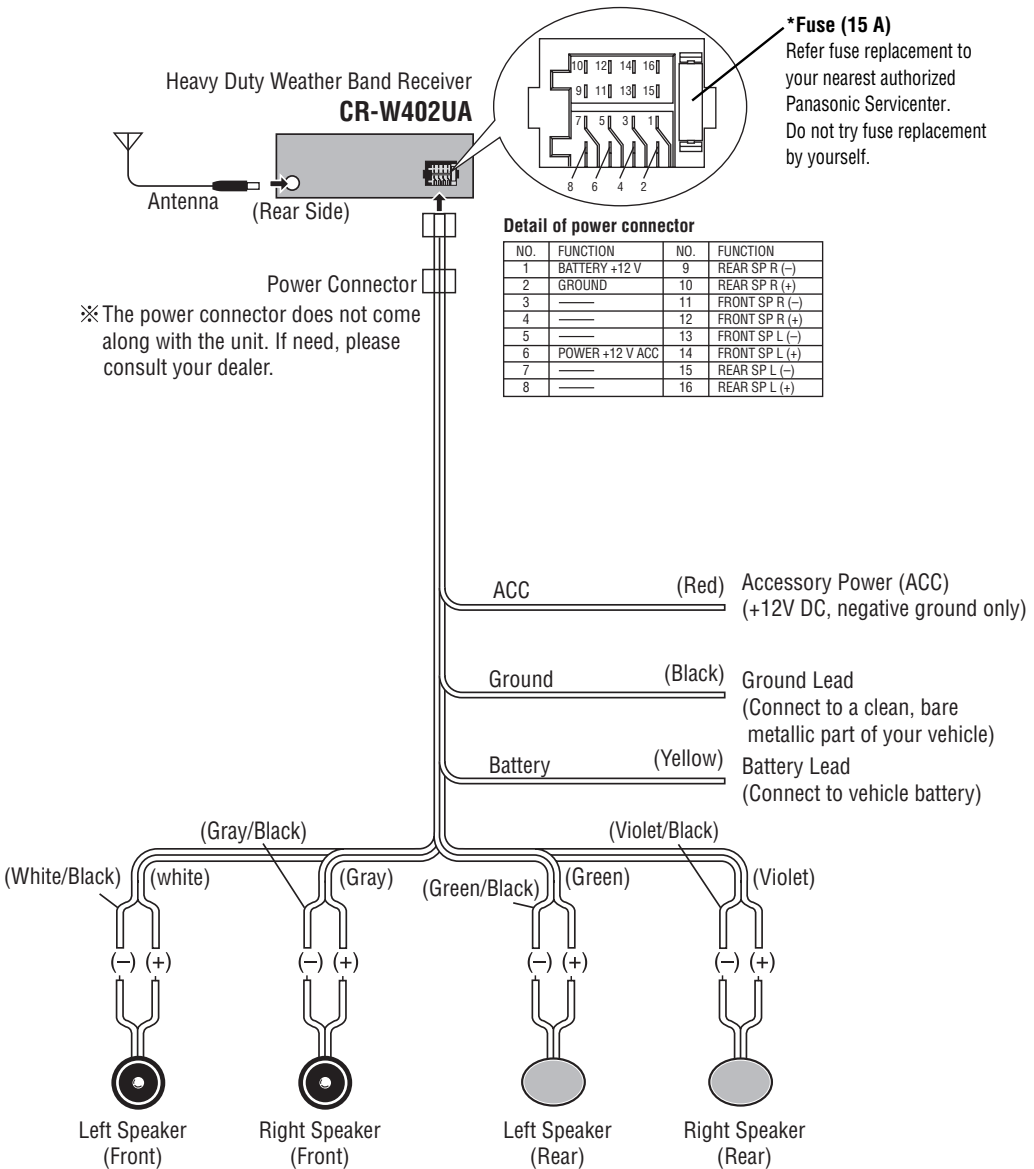

# Specifications

## □ General

Power Supply:	12 V DC (11 V-16 V) test Voltage 14.4 V, Negative ⊖ ground
Current consumption:	Less than 2.5 A (0.5 W 4-speaker)
Maximum Power Output:	37 W × 4 channels at 400 Hz, Volume Control maximum
Tone adjustment range:	
Bass:	± 12 dB at 100 Hz
Treble:	± 12 dB at 10 kHz
Power Output:	18 W per channel into 4 ohms, 40 to 30,000 Hz at 3 % THD
Suitable Speaker Impedance:	4 – 8 Ω
Dimensions (W × H × D):	178 × 50 × 150 mm {7" × 1-15/16" × 5-7/8"}
Weight:	0.85 kg {1.87 lbs.}

## □ FM Stereo Radio

Frequency Range:	87.9 – 107.9 MHz
Usable Sensitivity:	12 dBf (1.1 μV/ 75 Ω, S/N 30 dB)
50 dB Quieting Sensitivity:	17 dBf (1.8 μV/ 75 Ω)
Frequency Response:	30 – 15,000 Hz ±3 dB
Alternate Channel Selectivity:	75 dB
Stereo Separation:	35 dB at 1 kHz
Signal/Noise Ratio:	70 dB (Mono)

## □ AM Radio

Frequency Range:	530 kHz – 1,710 kHz
Usable Sensitivity:	28 dB/μV (25 μV, S/N 20 dB)

## □ Weather Band Radio

Frequency Range:	162.400 – 162.550 MHz
Usable Sensitivity:	3 dB/μV (S/N 20 dB)
Signal/Noise Ratio (40 dB/μV):	50 dB

Above specifications comply with EIA standards.

Power Output: 16 W RMS x 4 Channels at 4 Ω and ≤ 1% THD+N Signal to Noise Ratio: 70 dBA (reference: 1 W into 4 Ω)
---



**Note:** Specifications and the design are subject to modification without notice due to improvements in technology.





**Panasonic Consumer Electronics Company,  
Division of Panasonic Corporation of North  
America**

One Panasonic Way, Secaucus, New Jersey  
07094

<http://www.panasonic.com>

©Panasonic Corporation 2008

YFM264C170CA PTW0808-1128

Printed in China



## Free Manuals Download Website

<http://myh66.com>

<http://usermanuals.us>

<http://www.somanuals.com>

<http://www.4manuals.cc>

<http://www.manual-lib.com>

<http://www.404manual.com>

<http://www.luxmanual.com>

<http://aubethermostatmanual.com>

Golf course search by state

<http://golfingnear.com>

Email search by domain

<http://emailbydomain.com>

Auto manuals search

<http://auto.somanuals.com>

TV manuals search

<http://tv.somanuals.com>