

Panasonic

Operating Instructions

Network Camera

Indoor Use Only

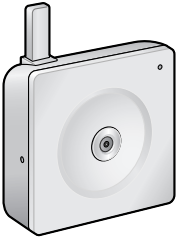

Model No. **BL-C20**



Please read this manual before using, and save this manual for future reference.

Main Features

Wireless Communication

This Network Camera is compatible with a wireless system based on IEEE 802.11b/g. Wireless installation is playing an ever increasing role in flexible communication. The use of encryption ensures security on this kind of network. Communication via Ethernet cable is also available.

Digital zoom feature^{*1}

This camera has a 10× digital zoom feature. This feature allows you to increase or decrease the size of objects on the Single Camera screen, the Multi Camera screen, and the Buffered Image screen. This makes it easy to view distant objects.^{*2} A mouse wheel operation or clicking the right mouse button increase or decrease the size of the object.

Color Night View Mode

The color night view mode provides better image quality and low light performance (4 lx^{*3}).

Multi-Camera Support

The Multi-Camera page displays the moving images from up to 4 cameras. This camera allows you to switch between 3 sets of 4 cameras. Additionally, static images from a maximum of 12 cameras can be displayed on a single page.

DynamicDNS Service Support

DynamicDNS service allows you to access the camera over the Internet with a domain name of your choice (e.g. bob.viewnetcam.com) instead of a global IP address.

Multi-Language Display

The Top page, Single Camera and Multi-Camera page can be displayed in English, French, German, Italian, Spanish, Russian, Simplified Chinese, Korean or Japanese. The Setup, Maintenance and Support pages are displayed only in English, Japanese, French or Simplified Chinese.

Motion Detection feature

The camera has a Motion Detection feature that detects movement, such as people, based on the preset threshold and sensitivity of the camera. You can buffer the camera images, transfer images to an FTP server or send E-mails using the Motion Detection function as a trigger.

^{*1} This feature is not available when viewing on a mobile phone.

^{*2} As the magnification increases, the image quality decreases.

^{*3} The brightness about 1 m away under auxiliary fluorescent light. When the object darkens, color night view mode is automatically enabled. The frame rate and the image quality decrease in color night view mode. Also, images of moving people or animals may be blurred.

Trademarks

- Adobe, Acrobat and Reader are either registered trademarks or trademarks of Adobe Systems Incorporated in the United States and/or other countries.
- Microsoft, Windows, Hotmail and ActiveX are either registered trademarks or trademarks of Microsoft Corporation in the United States and/or other countries.
- Screen shots reprinted with permission from Microsoft Corporation.
- All other trademarks identified herein are the property of their respective owners.
- This software is based in part on the work of the Independent JPEG Group.

Abbreviations

- UPnP is the abbreviation for "Universal Plug and Play".
- "Network Camera" is called "camera" in this manual.
- "Setup CD-ROM" is called "CD-ROM" in this manual.

Precaution

Information on Disposal for Users of Waste Electrical & Electronic Equipment (private households)



This symbol on the products and/or accompanying documents means that used electrical and electronic products should not be mixed with general household waste.

For proper treatment, recovery and recycling, please take these products to designated collection points, where they will be accepted on a free of charge basis. Alternatively, in some countries you may be able to return your products to your local retailer upon the purchase of an equivalent new product.

Disposing of this product correctly will help to save valuable resources and prevent any potential negative effects on human health and the environment which could otherwise arise from inappropriate waste handling. Please contact your local authority for further details of your nearest designated collection point.

Penalties may be applicable for incorrect disposal of this waste, in accordance with national legislation.

For business users in the European Union

If you wish to discard electrical and electronic equipment, please contact your dealer or supplier for further information.

Information on Disposal in other Countries outside the European Union

This symbol is only valid in the European Union.

If you wish to discard this product, please contact your local authorities or dealer and ask for the correct method of disposal.

Informations relatives à l'évacuation des déchets, destinées aux utilisateurs d'appareils électriques et électroniques (appareils ménagers domestiques)



Lorsque ce symbole figure sur les produits et/ou les documents qui les accompagnent, cela signifie que les appareils électriques et électroniques ne doivent pas être jetés avec les ordures ménagères.

 Pour que ces produits subissent un traitement, une récupération et un recyclage appropriés, envoyez-les dans les points de collecte désignés, où ils peuvent être déposés gratuitement. Dans certains pays, il est possible de renvoyer les produits au revendeur local en cas d'achat d'un produit équivalent.

En éliminant correctement ce produit, vous contribuerez à la conservation des ressources vitales et à la prévention des éventuels effets négatifs sur l'environnement et la santé humaine qui pourraient survenir dans le cas contraire.

Afin de connaître le point de collecte le plus proche, veuillez contacter vos autorités locales.

Des sanctions peuvent être appliquées en cas d'élimination incorrecte de ces déchets, conformément à la législation nationale.

Utilisateurs professionnels de l'Union européenne

Pour en savoir plus sur l'élimination des appareils électriques et électroniques, contactez votre revendeur ou fournisseur.

Informations sur l'évacuation des déchets dans les pays ne faisant pas partie de l'Union européenne

Ce symbole n'est reconnu que dans l'Union européenne.

Pour vous débarrasser de ce produit, veuillez contacter les autorités locales ou votre revendeur afin de connaître la procédure d'élimination à suivre.

Benutzerinformationen zur Entsorgung von elektrischen und elektronischen Geräten (private Haushalte)



Entsprechend den grundlegenden Firmengrundsetzen der Panasonic-Gruppe wurde ihr Produkt aus hochwertigen Materialien und Komponenten entwickelt und hergestellt, die recycelbar und wieder verwendbar sind.



Dieses Symbol auf Produkten und/oder begleitenden Dokumenten bedeutet, dass elektrische und elektronische Produkte am Ende ihrer Lebensdauer vom Hausmüll getrennt

entsorgt werden müssen.

Bringen Sie bitte diese Produkte für die Behandlung, Rohstoffrückgewinnung und Recycling zu den eingerichteten kommunalen Sammelstellen bzw. Wertstoffsammelhöfen, die diese Geräte kostenlos entgegennehmen.

Die ordnungsgemäße Entsorgung dieses Produkts dient dem Umweltschutz und verhindert mögliche schädliche Auswirkungen auf Mensch und Umwelt, die sich aus einer unsachgemäßen Handhabung der Geräte am Ende Ihrer Lebensdauer ergeben könnten.

Genauere Informationen zur nächstgelegenen Sammelstelle bzw. Recyclinghof erhalten Sie bei Ihrer Gemeindeverwaltung.

Für Geschäftskunden in der Europäischen Union

Bitte treten Sie mit Ihrem Händler oder Lieferanten in Kontakt, wenn Sie elektrische und elektronische Geräte entsorgen möchten. Er hält weitere Informationen für sie bereit.

Informationen zur Entsorgung in Ländern außerhalb der Europäischen Union

Dieses Symbol ist nur in der Europäischen Union gültig.

Informazioni per gli utenti sullo smaltimento di apparecchiature elettriche ed elettroniche obsolete (per i nuclei familiari privati)



Questo simbolo sui prodotti e/o sulla documentazione di accompagnamento significa che i prodotti elettrici ed elettronici usati non devono essere mescolati con i rifiuti domestici generici.

Per un corretto trattamento, recupero e riciclaggio, portare questi prodotti ai punti di raccolta designati, dove verranno accettati gratuitamente. In alternativa, in alcune nazioni potrebbe essere possibile restituire i prodotti al rivenditore locale, al momento dell'acquisto di un nuovo prodotto equivalente. Uno smaltimento corretto di questo prodotto contribuirà a far risparmiare preziose risorse ed evitare potenziali effetti negativi sulla salute umana e sull'ambiente, che potrebbero derivare, altrimenti, da uno smaltimento inappropriato. Per ulteriori dettagli, contattare la propria autorità locale o il punto di raccolta designato più vicino.

In caso di smaltimento errato di questo materiale di scarto, potrebbero venire applicate delle penali, in base alle leggi nazionali.

Per gli utenti aziendali nell'Unione Europea

Qualora si desideri smaltire apparecchiature elettriche ed elettroniche, contattare il rivenditore o il fornitore per ulteriori informazioni.

Informazioni sullo smaltimento in nazioni al di fuori dell'Unione Europea

Questo simbolo è valido solo nell'Unione Europea.

Qualora si desideri smaltire questo prodotto, contattare le autorità locali o il rivenditore e chiedere informazioni sul metodo corretto di smaltimento.

Información sobre la eliminación para los usuarios de equipos eléctricos y electrónicos usados (particulares)



La aparición de este símbolo en un producto y/o en la documentación adjunta indica que los productos eléctricos y electrónicos usados no deben mezclarse con la basura doméstica general.

Para que estos productos se sometan a un proceso adecuado de tratamiento, recuperación y reciclaje, llévelos a los puntos de recogida designados, donde los admitirán sin coste alguno.

En algunos países existe también la posibilidad de devolver los productos a su minorista local al comprar un producto nuevo equivalente.

Si desecha el producto correctamente, estará contribuyendo a preservar valiosos recursos y a evitar cualquier posible efecto negativo en la salud de las personas y en el medio ambiente que pudiera producirse debido al tratamiento inadecuado de desechos.

Póngase en contacto con su autoridad local para que le informen detalladamente sobre el punto de recogida designado más cercano.

De acuerdo con la legislación nacional, podrían aplicarse multas por la eliminación incorrecta de estos desechos.

Para empresas de la Unión Europea

Si desea desechar equipos eléctricos y electrónicos, póngase en contacto con su distribuidor o proveedor para que le informe detalladamente.

Información sobre la eliminación en otros países no pertenecientes a la Unión Europea

Este símbolo sólo es válido en la Unión Europea.

Si desea desechar este producto, póngase en contacto con las autoridades locales o con su distribuidor para que le informen sobre el método correcto de eliminación.

Информация по обращению с отходами для стран, не входящих в Европейский Союз



Действие этого символа распространяется только на Европейский Союз. Если Вы собираетесь выбросить данный продукт, узнайте в местных органах власти или у дилера, как следует поступать с отходами такого типа.

在欧盟以外其它国家的废物处置信息



此符号仅在欧盟有效。
如果要废弃此产品，请与当地机构或经销商联系，获取正确的废弃方法。

EU 가 아닌 국가에서 제품을 폐기하려는 경우



이 기호는 EU 에만 해당합니다.
이 제품을 폐기하려면 지역 기관이나 대리점에 연락하셔서 올바른 폐기 방법을 문의하십시오.

Informace pro uživatele k likvidaci elektrických a elektronických zařízení (domácnosti)



Tento symbol na produktech anebo v průvodních dokumentech znamená, že použité elektrické a elektronické výrobky nesmí být přidány do běžného komunálního odpadu.

Ke správné likvidaci, obnově a recyklaci doručte tyto výrobky na určená sběrná místa, kde budou přijata zdarma. Alternativně v některých zemích můžete vrátit své výrobky místnímu prodejci při koupi ekvivalentního nového produktu.

Správnou likvidací tohoto produktu pomůžete zachovat cenné přírodní zdroje a napomáháte prevenci potenciálních negativních dopadů na životní prostředí a lidské zdraví, což by mohly být důsledky nesprávné likvidace odpadů. Další podrobnosti si vyžádejte od místního úřadu nebo nejbližšího sběrného místa.

Při nesprávné likvidaci tohoto druhu odpadu mohou být v souladu s národními předpisy uděleny pokuty.

Pro podnikové uživatele v zemích Evropské unie

Chcete-li likvidovat elektrická a elektronická zařízení, vyžádejte si potřebné informace od svého prodejce nebo dodavatele.

Informace k likvidaci v ostatních zemích mimo Evropskou unii

Tento symbol je platný jen v Evropské unii.

Chcete-li tento výrobek zlikvidovat, vyžádejte si potřebné informace o správném způsobu likvidace od místních úřadů nebo od svého prodejce.

Oplysninger til brugerne om afhændelse af elektriske apparater og elektronisk udstyr (private husholdninger)



Når produkter og/eller medfølgende dokumenter indeholder dette symbol, betyder det, at elektriske apparater og elektronisk udstyr ikke må smides ud sammen med det almindelige husholdningsaffald.

For at sikre en korrekt behandling, indsamling og genbrug, skal du aflevere disse produkter på dertil indrettede indsamlingssteder, hvor de vil blive modtaget uden ekstra omkostninger. I nogle lande er der også mulighed for, at du kan indlevere dine produkter hos den lokale forhandler, hvis du køber

et nyt og tilsvarende produkt.

Hvis du afhænder dette produkt på korrekt vis, vil det være med at spare på de værdifulde naturlige råstoffer og forhindre eventuelle negative påvirkninger på folkesundheden og miljøet, hvilket ellers kunne blive følgerne af en forkert håndtering af affaldet. Kontakt de lokale myndigheder for at få yderligere oplysninger om, hvor du kan finde det nærmeste indsamlingssted.

I visse lande vil en forkert afhændelse af affaldet medføre en bødestraf i henhold til de gældende bestemmelser på området.

Professionelle brugere i EU

Hvis du ønsker at smide elektriske apparater eller elektronisk udstyr ud, skal du kontakte din forhandler eller leverandør for at få yderligere oplysninger.

Oplysninger om afhændelse i lande uden for EU

Dette symbol er kun gyldigt i EU.

Hvis du ønsker at afhænde dette produkt, skal du rette henvendelse til de lokale myndigheder eller din forhandler. Her kan du få oplysninger om, hvordan du bedst kommer af med produktet.

Tietoja sähkö- ja elektroniikkalaitteiden hävittämisestä (kotitaloudet)



Tämä symboli tuotteissa ja/tai niiden käyttöohjeissa osoittaa, että käytettyjä sähkö- ja elektroniikkalaitteita ei saa hävittää tavallisen kotitalousjätteen mukana.

Jotta laitteet käsitellään asianmukaisesti, toimita ne kierrätyspisteisiin, jotka vastaanottavat tällaisia laitteita ilmaiseksi. Joissakin maissa kuluttajat voivat myös palauttaa käytetyt laitteet paikalliselle jälleenmyyjälle, jos he ostavat tilalle uuden vastaavanlaisen tuotteen.

Tämän tuotteen asianmukainen hävittäminen säästää luonnonvaroja ja estää mahdollisesti muutoin syntyviä ympäristö- ja terveysongelmia. Lähistöllä sijaitsevista kierrätyspisteistä saa lisätietoja paikallisilta viranomaisilta.

Jätelaissa ja rikoslaisissa on säädetty rangaistus roskaamisesta ja lainvastaisesta hävittämisestä.

Yrityskäyttäjät Euroopan unionissa

Jos haluat hävittää sähkö- ja elektroniikkalaitteita, kysy lisätietoja jälleenmyyjältä tai tavarantoimittajalta.

Tietoja jätteiden käsittelystä Euroopan unionin ulkopuolella

Tämä symboli on käytössä vain Euroopan unionissa.

Jos haluat hävittää tämän tuotteen, tiedustele oikeaa hävitystapaa paikallisilta viranomaisilta tai jälleenmyyjältä.

Πληροφορίες για την απόρριψη ηλεκτρικών και ηλεκτρονικών συσκευών (οικιακής χρήσης)



Αυτή η σήμανση στα προϊόντα και/ή στα συνοδευτικά τους έντυπα υποδηλώνει ότι τα εν λόγω ηλεκτρικά και ηλεκτρονικά προϊόντα δεν πρέπει να απορριφθούν μαζί με οικιακά απορρίμματα.

Προκειμένου να πραγματοποιηθεί η κατάλληλη επεξεργασία και ανακύκλωση, αποσύρετε αυτά τα προϊόντα σε ανάλογα σημεία περισυλλογής, όπου θα γίνουν δεκτά χωρίς χρέωσή σας.

Εναλλακτικά, σε ορισμένες χώρες, μπορείτε να επιστρέψετε τα προϊόντα σε τοπικά καταστήματα με σκοπό την αγορά ανάλογου

νέου προϊόντος.

Η ορθή απόρριψη αυτού του προϊόντος βοηθάει στην εξοικονόμηση πολύτιμων φυσικών πόρων και στην αποφυγή τυχόν αρνητικών επιπτώσεων για την ανθρώπινη υγεία και το περιβάλλον, οι οποίες μπορεί να προκληθούν από λανθασμένη διαχείριση του εν λόγω απορρίμματος.

Επικοινωνήστε με τις τοπικές αρχές για περισσότερες πληροφορίες σχετικά με το πλησιέστερο ανάλογο σημείο περισυλλογής.

Ενδέχεται να επιβληθούν κυρώσεις για λανθασμένη απόρριψη του εν λόγω προϊόντος, σύμφωνα με τη νομοθεσία της χώρας σας.

Προϊόντα επαγγελματικής χρήσης, Ευρωπαϊκή Ένωση

Αν επιθυμείτε να απορρίψετε ηλεκτρικό και ηλεκτρονικό εξοπλισμό, επικοινωνήστε με τον πωλητή ή τον προμηθευτή για περισσότερες πληροφορίες.

Πληροφορίες για την απόρριψη ηλεκτρικών και ηλεκτρονικών συσκευών σε χώρες εκτός της Ευρωπαϊκής Ένωσης

Αυτή η σήμανση ισχύει μόνο στην Ευρωπαϊκή Ένωση.

Αν επιθυμείτε να απορρίψετε αυτό το προϊόν, επικοινωνήστε με τις τοπικές αρχές ή καταστήματα πώλησης για να πληροφορηθείτε σχετικά με την ορθή διαδικασία απόρριψης.

Informatie over het weggoien van elektrische en elektronische apparatuur (particulieren)



Dit symbool betekent in Europa dat gebruikte elektrische en elektronische producten niet bij het normale huishoudelijke afval mogen.

Lever deze producten in bij de aangewezen inzamelingspunten, waar ze gratis worden geaccepteerd en op de juiste manier worden verwerkt, teruggewonnen en hergebruikt. In Nederland kunt u uw producten bij uw winkelier inleveren bij de aanschaf van een vergelijkbaar nieuw product. Wanneer u dit product op

de juiste manier als afval inlevert, spaart u waardevolle hulpbronnen en voorkomt u potentiële negatieve gevolgen voor de volksgezondheid en het milieu, die anders kunnen ontstaan door een onjuiste verwerking van afval. Neem contact op met uw gemeente voor meer informatie over het dichtstbijzijnde inzamelingspunt of raadpleeg www.nvmp.nl, www.ictoffice.nl of www.stibat.nl.

Voor zakelijke gebruikers in de Europese Unie

Neem voor het weggoien van elektrische en elektronische apparatuur contact op met uw leverancier voor verdere informatie.

Informatie over verwijdering van afval in landen buiten de Europese Unie

Dit symbool is alleen geldig in de Europese Unie.

Neem wanneer u dit product wilt weggoien, contact op met de lokale overheid of uw leverancier en vraag wat de juiste verwijderingsmethode is.

Informasjon for brukerne om kassering av elektrisk og elektronisk utstyr (private husholdninger)



Når et produkt og/eller medfølgende dokumenter er merket med dette symbolet, betyr det at det elektriske eller elektroniske utstyret ikke bør kasseres sammen med vanlig husholdningsavfall.



For at det kasserte utstyret skal bli behandlet, gjenvunnet og resirkulert på riktig måte, må du bringe det til nærmeste innsamlingspunkt eller gjenvinningsstasjon. I enkelte land kan du alternativt returnere produktene dine til den lokale

forhandleren, eventuelt mot kjøp av et tilsvarende nytt produkt.

Hvis du kasserer dette produktet på riktig måte, bidrar til du til å bevare verdifulle ressurser og til å motvirke de negative virkningene på miljøet og den menneskelige helse som kan forårsakes av feilaktig avfallsbehandling. Ta kontakt med de lokale myndigheter hvis du ønsker ytterligere informasjon om ditt nærmeste innsamlingspunkt.

Feilaktig kassering av dette utstyret kan kanskje bøtelegges, avhengig av nasjonale lover og regler.

For bedriftskunder i den Europeiske Union

Hvis du ønsker å kassere elektrisk og elektronisk utstyr, må du kontakte forhandleren eller leverandøren din for å få mer informasjon.

Informasjon om kassering i land utenfor den Europeiske Union

Dette symbolet er kun gyldig i den Europeiske Union.

Hvis du ønsker å kassere dette produktet, må du ta kontakt med forhandleren eller de lokale myndigheter og spørre dem om hvordan det skal kasseres på riktig måte.

Informacja dla użytkowników o pozbywaniu się urządzeń elektrycznych i elektronicznych (dotyczy gospodarstw domowych)



Przedstawiony symbol umieszczony na produktach lub dołączonej do nich dokumentacji informuje, że niesprawnych urządzeń elektrycznych lub elektronicznych nie można wyrzucać razem z odpadami gospodarczymi.

 Prawidłowe postępowanie w razie konieczności pozbycia się urządzeń elektrycznych lub elektronicznych, utylizacji, powtórnego użycia lub odzysku podzespołów polega na przekazaniu urządzenia do wyspecjalizowanego punktu zbiórki. W niektórych krajach produkt można oddać lokalnemu dystrybutorowi podczas zakupu innego urządzenia.

Prawidłowa utylizacja urządzenia umożliwi zachowanie cennych zasobów i uniknięcie negatywnego wpływu na zdrowie i środowisko, które może być zagrożone przez nieodpowiednie postępowanie z odpadami. Szczegółowe informacje o najbliższym punkcie zbiórki można uzyskać u władz lokalnych. Nieprawidłowa utylizacja odpadów zagrożona jest karami przewidzianymi w odpowiednich przepisach lokalnych.

Użytkownicy w krajach Unii Europejskiej

W razie konieczności pozbycia się urządzeń elektrycznych lub elektronicznych, prosimy skontaktować się z najbliższym punktem sprzedaży lub z dostawcą, którzy udzielą dodatkowych informacji.

Pozbywanie się odpadów w krajach poza Unią Europejską

Taki symbol jest ważny tylko w Unii Europejskiej.

Information om återvinning för användare av elektronisk utrustning (privatpersoner)



Om denna symbol finns på produkterna och/eller medföljande dokumentation, betyder det att förbrukade elektriska och elektroniska produkter inte ska blandas med vanliga hushållssopor.



För korrekt hantering, inhämtning och återvinning, ska dessa produkter lämnas på återvinningscentraler, där de tas emot utan kostnad. I vissa länder kan du som ett alternativ lämna in dina produkter hos återförsäljaren, när du köper en motsvarande, ny

produkt.

Om denna produkt återvinns på ett korrekt sätt sparas värdefulla resurser och eventuellt negativa effekter på den mänskliga hälsan och miljön förhindras, vilket kan bli fallet vid felaktig återvinning. Kontakta din lokala myndighet för mer information om var din närmsta återvinningsstation finns. Böter kan tillämpas vid felaktig kassering i enlighet med lagstiftningen i landet.

För företagsanvändare inom den Europeiska gemenskapen

Om ni vill kassera elektrisk eller elektronisk utrustning, vänligen kontakta er återförsäljare eller leverantör för mer information.

Information om återvinning i länder utanför den Europeiska gemenskapen

Denna symbol gäller bara inom den Europeiska gemenskapen.

Om du vill kassera denna produkt ska du kontakta de lokala myndigheterna eller din återförsäljare, och fråga om korrekt förfarande.

Kullanılmayan Elektrikli ve Elektronik Aletlerin Elden Çıkarılmasına İlişkin Bilgi (bireysel kullanıcılar)



Ürünlerde ve/veya ürünle birlikte gelen dokümanlarda yer alan bu simge, ömrü sona ermiş elektrikli ve elektronik ürünlerin genel ev çöpüne karıştırılmaması gerektiğini ifade eder.

Uygun biçimde toplanmaları, işlenmeleri ve geri dönüştürülmeleri için lütfen bu tür ürünleri, bunlar için öngörülen ve ücretsiz olarak kabul edilen toplama noktalarına götürün.

Ayrıca bazı ülkelerde eski ürününüzü, yeni eşdeğer bir ürün

satın aldığınız yerel satıcınıza teslim edebilirsiniz.

Ürünün doğru bir şekilde elden çıkarılması, değerli kaynakları korumaya yardımcı olacak ve yanlış biçimde atık gidermenin insan sağlığına ve çevreye verebileceği olası negatif etkileri önleyecektir. Çevrenizdeki en yakın toplama noktasına ilişkin daha ayrıntılı bilgi almak için lütfen yerel yetkililere başvurun.

Ürünlerin uygun biçimde elden çıkarılmaması durumunda, ilgili ülkenin yasal düzenlemelerine bağlı olarak cezalar uygulanabilir.

Avrupa Birliği dahilindeki kurumsal kullanıcılar için

Elektrikli ve elektronik aletlerinizi elden çıkarmak istiyorsanız, ayrıntılı bilgi için lütfen satıcınıza veya tedarikçinize başvurun.

Avrupa Birliği dışındaki ülkelerde atık gidermeye ilişkin bilgi

Bu simge yalnızca Avrupa Birliği sınırları içerisinde geçerlidir.

Bu ürünü elden çıkarmak istiyorsanız, lütfen yerel yetkililere veya satıcınıza başvurun ve uygun atık giderme yöntemi konusunda bilgi alın.

Camera Feature Locations

Front View

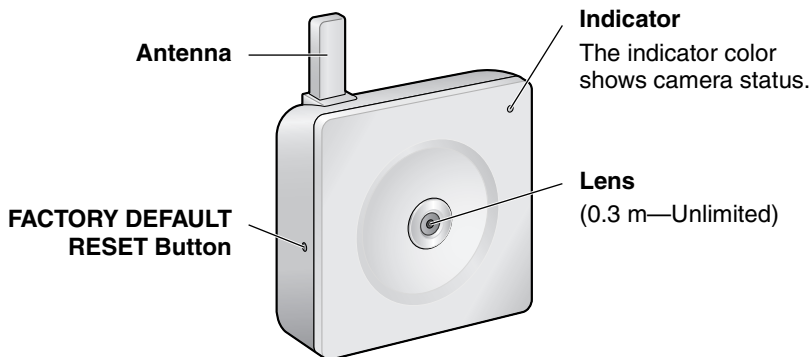

Indicator Display^{*1}

Power on	Not on LAN	Orange → Orange blinking
	On LAN	Orange → Orange blinking → Green blinking → Green
Normal Operation ^{*2}		Green
Automatic Setup	Setting	Green blinking
	Finished setting	Green
Using DHCP	Getting IP address ^{*3}	Orange blinking → Green blinking
	Got IP address	Green
Updating Firmware		Orange blinking
FACTORY DEFAULT RESET button pressed		Orange blinking → Turning off (about 5 seconds) → The status when turned on (The camera is reset to factory default status after 1 minute.)
UPnP™ Failure		Orange blinking (About a 2-second interval)
Internal Failure		Red blinking ^{*4}

^{*1} The information below varies depending on the indicator settings (see page 110).

^{*2} The indicator turns orange if the camera is not connected to the LAN.

^{*3} The indicator blinks orange if the camera is not connected to the LAN.

^{*4} See page 4 of Troubleshooting on the CD-ROM.

Rear View

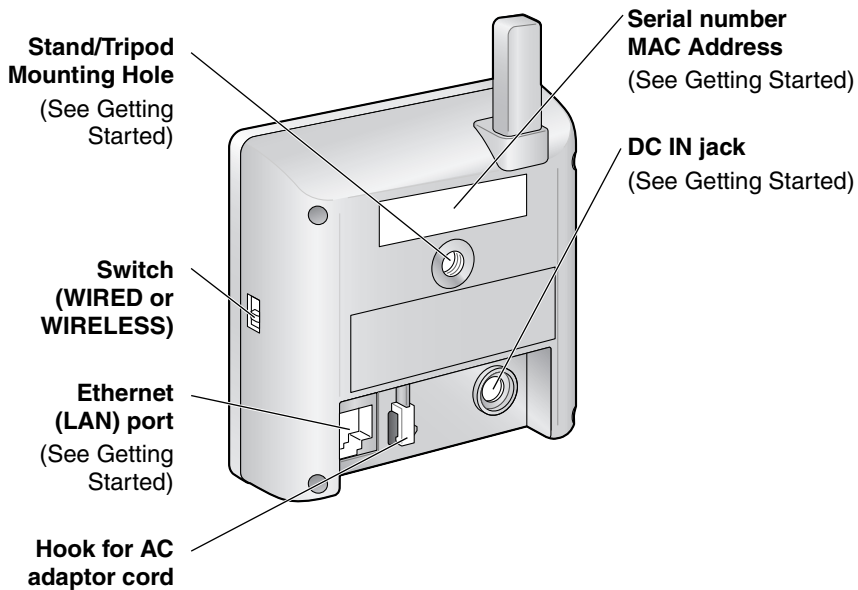

Table of Contents

1	Camera Monitoring.....	24
1.1	Accessing the Camera.....	24
1.2	Viewing the Single Camera page.....	26
1.2.1	Displaying the Banner	30
1.2.2	Auto Centering the Image (Click to Center).....	30
1.2.3	Zooming In and Out.....	31
1.2.4	Capturing a Still Image	32
1.2.5	Using the Operation Bar	33
1.3	Viewing the Multi-Camera page	34
1.4	Viewing the Buffered Image page	36
1.4.1	Deleting Buffered Images	38
1.5	Viewing Still Images on Your Mobile Phone.....	39
1.5.1	Enabling or Disabling the Buffer/Transfer on Your Mobile Phone	41
2	Using the Camera's Basic Features	42
2.1	Setup Page of the Camera.....	42
2.2	Connecting the Camera to Your Network.....	45
2.3	Using Wireless LAN	50
2.4	Using UPnP™ (Universal Plug and Play)	53
2.4.1	Connecting the Camera to a Router that Supports UPnP™	54
2.4.2	Connecting the Camera to a Router that does not Support UPnP™	55
2.5	Registering with the DynamicDNS service	56
2.5.1	DynamicDNS Service.....	60
2.6	Setting the Date and Time	62
2.7	Changing Camera Settings.....	64
3	Registering Users.....	66
3.1	Changing the Authentication Setting and Administrator User Name and Password.....	66
3.2	Logging in to the Camera.....	70
3.3	Creating, Modifying or Deleting General Users.....	71
4	Buffering or Transferring Images.....	73
4.1	Procedures of Buffering or Transferring Images	73
4.2	Buffering or Transferring Images by Timer	74

4.3	Buffering or Transferring Images by Motion Detection Signal	84
4.4	Setting the Motion Detection	97
4.5	Setting Sensor Log Notification	100
5	Using Other Features	103
5.1	Changing Initial Settings on the Single Camera page or the Multi-Camera page	103
5.2	Configuring Multiple Cameras	106
5.3	Specifying Operation Time	108
5.4	Changing the Indicator Display	110
6	Camera Maintenance	111
6.1	Maintenance page	111
6.1.1	Confirming the Status	112
6.1.2	Confirming the Wireless Status	112
6.1.3	Confirming Session Status	112
6.1.4	Confirming Sensor Logs	113
6.1.5	Restarting the Camera	113
6.1.6	Updating the Camera Firmware	114
6.1.7	Creating a Configuration File	117
6.1.8	Loading Settings from a Configuration File	118
6.1.9	Resetting the Camera to Factory Default	119
6.2	Support page	120
6.2.1	The Help page	120
6.2.2	The Wireless Help page	121
6.2.3	Product Information	121
6.2.4	Support Information	121
6.3	FACTORY DEFAULT RESET Button	122
7	Other Information	123
7.1	Default Setting List	123
7.2	Cleaning	132
7.2.1	Cleaning the Main Unit	132
7.2.2	Cleaning the Lens	132
7.3	Setting an IP Address on Your PC	133
7.4	Using Setup Program	134
7.5	Setting Your PC	141
7.5.1	Setting Proxy Server Settings on a Web Browser	141

7.5.2	Setting UPnP™ to Display Camera Shortcut in My Network Places.....	144
7.5.3	Setting the Internet Temporary File Setting on the Web Browser.....	144
7.6	ASCII Character Table	145
7.7	File Size and Number of Buffered Images	146
7.8	Specifications.....	149
Index.....		151

1 Camera Monitoring

1.1 Accessing the Camera

1. Start up the web browser on your PC.
2. Enter "**http://IP Address (or URL):Port Number**" on the address bar, and press [Enter] on the keyboard.
 - When the port number is 80 (default), you do not need to include the port number in the address. See page 47 for details about the port number.
 - If the camera image is not displayed, see page 9 and page 10 of Troubleshooting on the CD-ROM.

E.g. `http://192.168.0.253:50000`

`http://* * * *.viewnetcam.com:50000`

3. The Enter Network Password window is displayed. Enter the user name and password that you set previously, and click [OK].

Note

When [Permit access from guest users] is set on the Security: Administrator page (see page 66), the authentication window will not be displayed.

4. Click the following tabs to display each page.

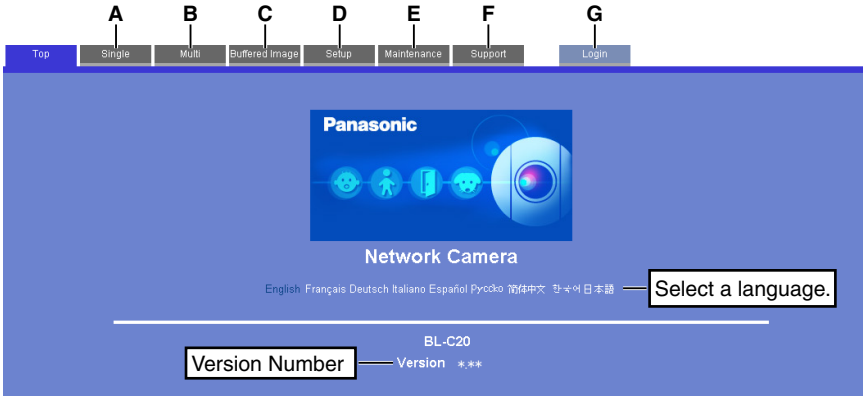

A To Single Camera page (page 26)

B To Multi-Camera page (page 34)

C To Buffered Image page (page 36)

D To Setup page (page 42)

E To Maintenance page (page 111)

F To Support page (page 120)

G To log in to the camera (page 70)

Note

When users other than an administrator are accessing the camera, the [Setup] and [Maintenance] tabs are not displayed. Additionally, when [Do not permit access from guest users] or [Permit access from guest users (mobile only)] is set on the Security: Administrator page (see page 66), the [Login] tab will not be displayed.

1.2 Viewing the Single Camera page

1. Access the camera (see page 24).
 - The Top page is displayed.
2. Click the [Single] tab at the top of the page.
 - When the Security Warning window is displayed, click [Yes] (see page 28).
 - See page 29 for the Security Warning window when using Microsoft® Windows® XP Service Pack 2.

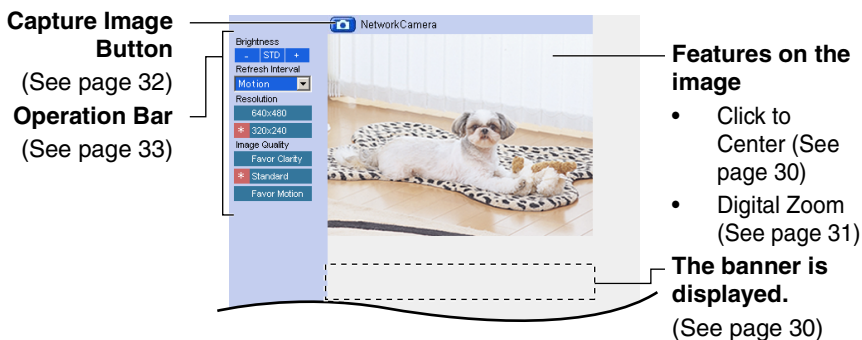

3. Close the web browser.

Note

- While viewing images under fluorescent lighting, the image may appear noisy or experience flicker if the incorrect AC power setting was selected. Select the frequency that is used in your area (see page 64).
- When the camera image is not displayed immediately or correctly, click [Refresh] at the tool bar on the web browser. The image will be refreshed.
- The digital zoom can be operated only when displaying video (Motion JPEG).
- The refresh interval is set to [Motion] by default. The setting can be changed on the operation bar (see page 33).
- The refresh interval may change depending on the network condition, PC performance, what object you view and the number of simultaneous users.
- When displaying video (Motion JPEG), the camera allows up to 20 simultaneous accesses. The 21st user will see a gray screen. Access to play buffered images is also included in the maximum number.
- To reduce the data traffic, set up [Limit Continuous Motion JPEG] on the Image Display page (see page 103). The video (Motion JPEG) can be automatically changed to refreshing still images. Images of moving subject are blurred or not displayed.

- When the camera transmits a dark scene, the camera image may become white, or horizontal lines may be displayed on the screen. This is one of the characteristics of a CMOS sensor. This is not a malfunction.
- To display the Single Camera page directly, add it to the [Favorites] on the web browser.
- To view dark images, select [Enable] (default) at Color Night View on the Camera Setup page. The image will be brighter, but the refresh interval may increase and image quality may decrease in a dark place. (See page 64)
- The video (Motion JPEG) may stop since the wireless communication may be disconnected depending on the environment. Click [Refresh] on the web browser when the communication is disconnected.
- If ActiveX® Controls (see page 28 or page 29) cannot be installed, download them from the Panasonic Network Camera support website at <http://panasonic.co.jp/pcc/products/en/netwkcaml/>

Error messages and screen color

When general or guest users access the Single Camera page outside the Operation Time, or when over 20 (the maximum number) users access the page simultaneously, a gray screen and error messages will be displayed on the page.

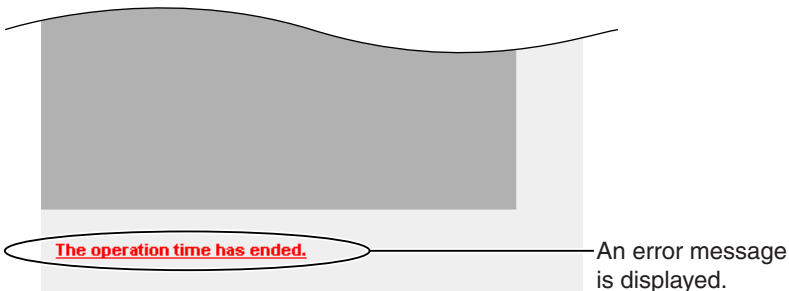

Error Message	Cause and Remedy
The operation time has ended.	When general or guest users access the Single Camera page outside the Operation Time, a gray screen will be displayed. Clicking [Refresh] on the web browser displays an error message. Consult your administrator about the Operation Time.
The maximum number of accesses has been exceeded.	When [Motion] is selected for the Refresh Interval, up to 20 users can access the camera simultaneously. For the 21st user, a gray screen and an error message will be displayed on the Single Camera and Buffered Image pages. Wait for a moment, and click [Refresh] on the web browser, or change the value for the Refresh Interval.

Security Warning window

When trying to view a video (Motion JPEG) for the first time, a Security Warning for ActiveX Controls will be displayed. When using Windows 2000 or Windows XP, log in as an administrator to install ActiveX Controls and enable video (Motion JPEG) viewing.

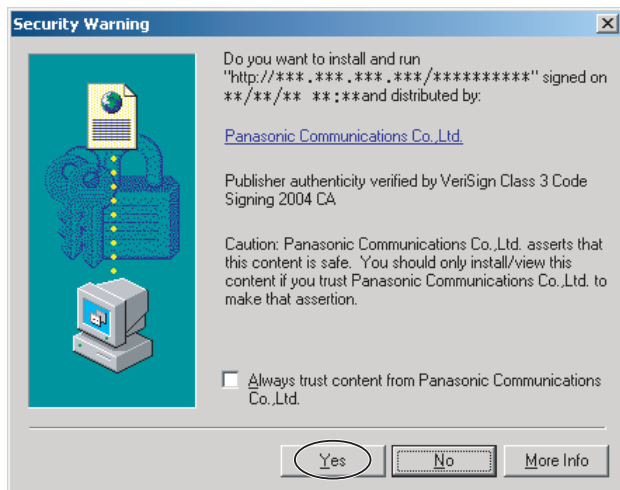

If you cannot install ActiveX Controls or you cannot see the video (Motion JPEG) using Internet Explorer

- In Internet Explorer, click [Tools]→[Internet Options]→[Security] tab and click [Custom level].
 - (1) Check "Prompt" in "Download signed ActiveX Controls".
 - (2) Check "Enable" in "Run ActiveX Controls and plug-ins".
- ActiveX Controls can be installed from the CD-ROM.
 - (1) Restart the PC.
 - (2) Confirm that Internet Explorer is closed.
 - (3) Double-click "ocx\ActiveXInst.exe" on the CD-ROM.

Note

- When the IP address was changed for the camera, enter it on the address bar.
- Video (Motion JPEG) may not be displayed. Wait for a moment.
- If you use a proxy server, set the web browser not to access the proxy server (see page 141).
- In some corporate network environments, a firewall may be used for security purposes. This may prevent motion video (Motion JPEG) from being displayed. In this situation we recommend:
 - Contacting your network administrator.
 - Using regularly refreshed images rather than video (Motion JPEG).

Security Warning window on Microsoft Windows XP Service Pack 2

To view a video (Motion JPEG), ActiveX Controls must be installed.
Follow the steps shown below to install ActiveX Controls.

1. Click the warning displayed above the tabs, and click [Install ActiveX Control...].

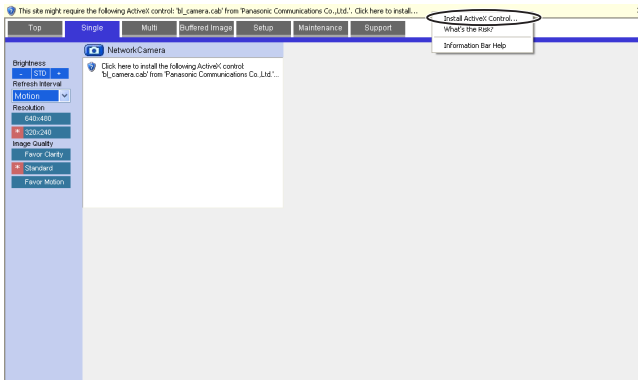

2. Click [Install].

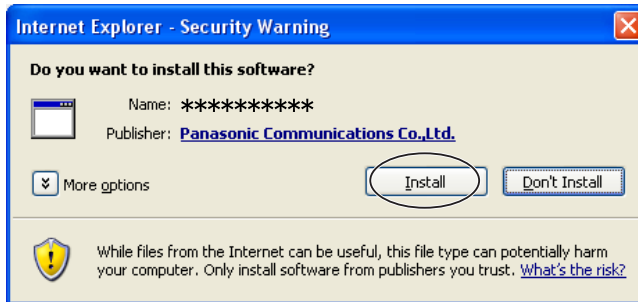

1.2.1 Displaying the Banner

An image and its linked website can be specified for a banner. To display the banner, the Banner Display settings need to be set on the Image Display page (see page 103). Clicking the banner displays the website of the set URL Link. The Banner Display is not enabled as the default.

1.2.2 Auto Centering the Image (Click to Center)

Using your mouse, click any portion of the camera image when using the digital zoom. The image will automatically move to place the selected point in the center of the screen.

1. Move the cursor to the desired point.



2. Click it.
 - The clicked point is centered.



Note

- A clicked position may deviate from the center depending on the position.
- Images can only be moved within the page when magnification is $\times 1$.

1.2.3 Zooming In and Out

This camera has 10× digital zoom feature that uses ActiveX Controls. The digital zoom feature can be used while playing video (Motion JPEG) on the Single Camera, Multi-Camera and Buffered Image pages. The digital zoom feature can be operated by rotating the mouse wheel or clicking the right mouse button.

Note

- The Click to Center feature is available while zooming in or out. Images can only be moved within the page when magnification is $\times 1$.
- As the magnification increases, the image quality decreases.
- This feature is not available when viewing on a mobile phone.
- When camera images are buffered and transferred, the camera images are not zoomed in and out.

Clicking the right mouse button

Moving the mouse up or down while pressing the right mouse button zooms in and out.

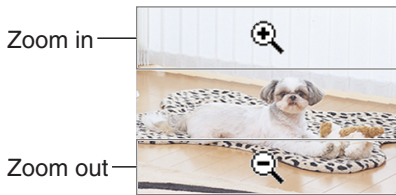

Rotating the mouse wheel

On a screen, rotating the mouse wheel away from you zooms in, and rotating it towards you zooms out.

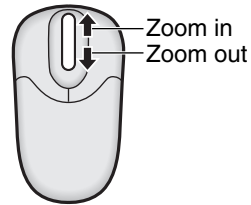

Note

The performance of the mouse varies according to your OS.

1.2.4 Capturing a Still Image

Still images can be saved on your PC.

1. Select an image resolution to display an image.
2. Click the Capture image button.

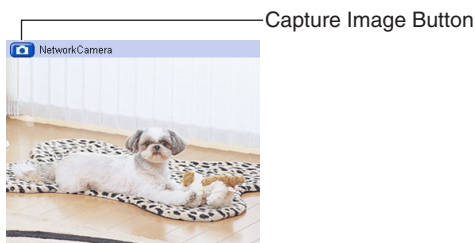

- The camera image opens in another window.
3. Right-click the image, and select [Save Picture As...].

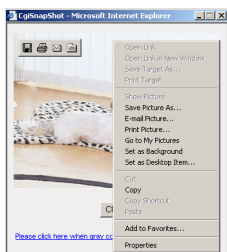

- The Save as dialog box is displayed.
4. Specify a folder, enter the file name and click [Save].
 - The camera image is saved in the folder.
 5. Click [Close].

1.2.5 Using the Operation Bar

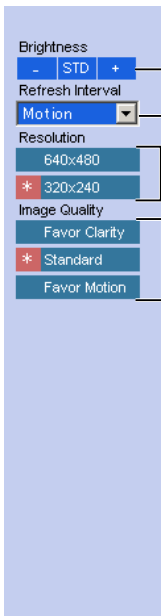

Brightness: Adjusts image brightness in nine steps including [STD] (Standard). Clicking [-] or [+] darkens or brightens the image respectively.

Refresh Interval: Sets a refresh interval. (Motion—60-second interval)

Resolution: Selects [640 × 480] or [320 × 240] (default) pixels.

Image Quality: Selects the image quality.

- [Favor Clarity] optimizes the image for good clarity (The motion may be slow down).
- [Standard] keeps the standard quality. (default)
- [Favor Motion] optimizes the image for motion display (The image quality may decrease).

1.3 Viewing the Multi-Camera page

To view multiple cameras on the Multi-Camera page, you need to configure each camera on the Multi-Camera Setup page (see page 106).

1. Access the camera (see page 24).
 - The Top page is displayed.
2. Click the [Multi] tab at the top of the page.



- The Multi-Camera page can display up to 12 camera images.

Capture Image Button (See page 32)

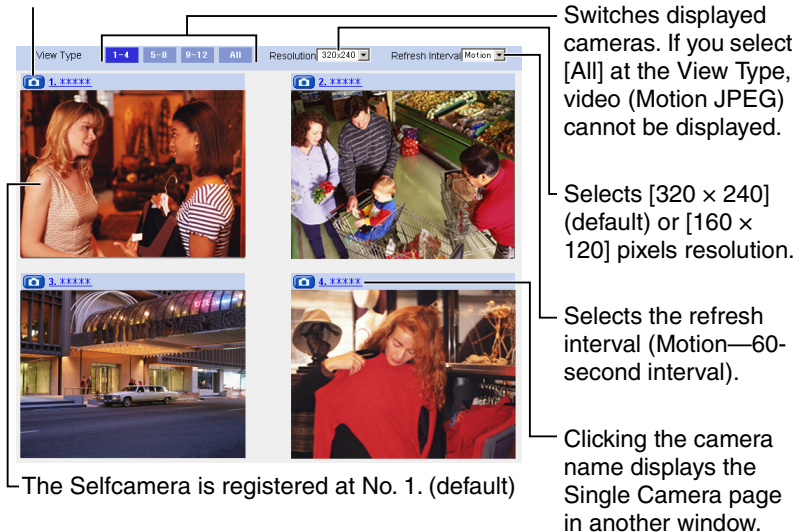

The screenshot shows a web browser interface for viewing multiple cameras. At the top, there are controls for 'View Type' (with buttons for 1-4, 5-8, 9-12, and All), 'Resolution' (set to 320x240), and 'Refresh Interval' (set to Motion). Below these are four camera thumbnails labeled 1 through 4. Callout lines point to these elements with the following text:

- Switches displayed cameras. If you select [All] at the View Type, video (Motion JPEG) cannot be displayed.
- Selects [320 × 240] (default) or [160 × 120] pixels resolution.
- Selects the refresh interval (Motion—60-second interval).
- Clicking the camera name displays the Single Camera page in another window.

The Selfcamera is registered at No. 1. (default)

3. Close the web browser.

Note

- The digital zoom feature and the Click to Center feature can be used for video (Motion JPEG) only.
- When selecting [All] for the View Type, all images are displayed in 160 × 120 pixels resolution.
- 640 × 480-pixel images cannot be displayed on the Multi-Camera page.
- When viewing video (Motion JPEG), we recommend using an Ethernet switching hub instead of a repeater hub to prevent degradation in video display.
- Due to network congestion or the number of accesses, the refresh interval may increase.
- If the refresh interval is too long, restrict the bandwidth on the Network page (see page 48). The refresh interval should improve.
- To reduce the data traffic, set up [Limit Continuous Motion JPEG] on the Image Display page (see page 103). The video (Motion JPEG) can be automatically changed to refreshing still images. Images of moving subject are blurred or not displayed.
- When viewing 4 cameras on the Multi-Camera page, you may need 3 to 4 Mbps bandwidth. If sufficient bandwidth is not available, the refresh interval may increase.
- The Click to Center feature can be used while using the digital zoom.

When an image is not displayed on the Multi-Camera page

- Confirm that the global IP address is specified correctly for each camera and that each camera is connected to the Internet. For Internet access, local IP addresses (192.168.***.**) cannot be used. (See page 11 of Troubleshooting on the CD-ROM)
- Confirm the settings on the Multi-Camera Setup page (see page 106).
- Confirm that the web browser is not accessing a proxy server (see page 141).

When setting [Do not permit access from guest users] or [Permit access from guest users (mobile only)] on the Security: Administrator page

- An authentication window is displayed when accessing the camera. Enter the administrator's or the general user's user name and password.
- When you view images from several cameras on the Multi-Camera page, an authentication window is displayed for each camera that has security settings enabled. Enter the administrator's or general user's user name and password registered for each camera.

1.4 Viewing the Buffered Image page

To buffer images in the camera's internal memory, you need to set up the image transfer settings (see page 74 or page 84). Buffered images can be viewed on this Buffered Image page.

1. Access the camera (see page 24).
 - The Top page is displayed.
2. Click the [Buffered Image] tab at the top of the page.



3. Click the trigger number.

The trigger number is displayed (see page 74 or page 84).

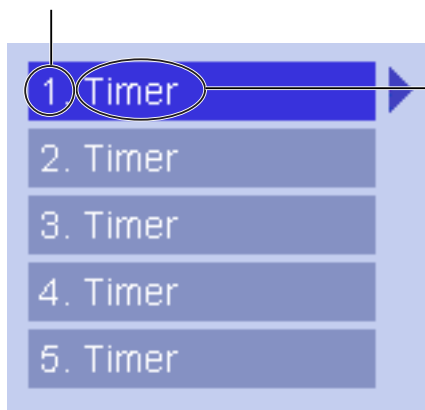

The trigger is displayed
(see page 74 or page 84).

4. Display images by clicking buttons below.



The date and time when the images were buffered are displayed.

Month (Sep), day (20), hour (02), minute (58), second (15), millisecond (120), AM/PM (PM), the number and the total number of frames (1/10) are displayed.

[Play]:

The buffered images are displayed in sequence.

[<Prev] or [Next>]:

The previous or next image is displayed.

[<100], [<10] or [10>], [100>]:

The 10th or 100th image before or after the current image appears.

Note

- The buffered images are displayed chronologically.
- Still images (not being played) from the Buffered Image page can be saved. Put the cursor on the image, and right-click it. Then select [Save Picture As...].
- The maximum number of buffered images changes depending on resolution, image quality and the specific images the camera is buffering. At 320 × 240 pixels resolution and standard quality, the camera can buffer about 250 frames.
If 3 triggers are enabled [maximum 5 triggers], the internal memory capacity is divided into 3 sections. In this case, each trigger can buffer about 80 frames. See page 146 for more details regarding the internal memory capacity.
- The digital zoom can be used while viewing buffered images (while playing video [Motion JPEG]).
- The Click to Center feature can be used while using the digital zoom.

1.4.1 Deleting Buffered Images

If you intend to delete images for each transfer method, click [Delete Buffered Images] on the Trigger page (see page 74 or page 84).

Note

- If you are buffering images to the internal memory, the following operations also delete all buffered images.
 - Turning off the camera.
 - Saving the Date and Time page.
 - Restarting, updating firmware or resetting the camera to factory default.
 - Changing the Enable/Disable settings on the Image Buffer/Transfer page (see page 41, page 74 or page 84).

1.5 Viewing Still Images on Your Mobile Phone

Still images can be viewed over the Internet from a compatible mobile phone.

Enter "**http://IP address (or URL):Port Number/mobile**" on a mobile phone and press [OK].

- When the port number is set to 80 (default), it is not required.

E.g. `http://***.***.***.***:50000/mobile`
 (or `***.***.***.***.***.***.***.***:50000/mobile`)

- Allow access from the Internet to access the camera from mobile phones.
- When an authentication window is displayed, enter the administrator's or general user's user name and password.
- A still image is displayed. (Video [Motion JPEG] cannot be displayed.)

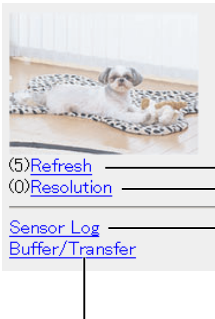

- Pressing 5 will refresh the image.
- 160 × 120 resolution is displayed on the first access. Pressing 0 switches the resolution to 320 × 240.
- Displays up to 50 Logs in order of time (only for an administrator).

An administrator can enable or disable the Image Buffer/Transfer setting from your mobile phone (see page 41).

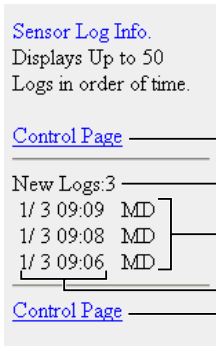

- Goes to the control page.
- Displays the number of new logs.
- MD: Motion Detection
- Displays the date and time.
- Goes to the control page.

Note

- If the image is not displayed properly, try the following 2 URLs.
 1. **http:// IP address(or URL):Port Number/MobileH** for HTML.
(or * * * * *.viewnetcam.com:50000/MobileH)
 2. **http:// IP address(or URL):Port Number/MobileX** for XHTML.
(or * * * * *.viewnetcam.com:50000/MobileX)
- Some mobile phones are not compatible with Panasonic Network Cameras. Some phones may allow viewing only on port 80, and some may not support password authentication. See the Panasonic Network Camera support website below for a list of mobile phones, and their level of compatibility with the Panasonic Network Camera.
- Some mobile phones display images at a decreased size.
- If [Permit access from guest users] or [Permit access from guest users (mobile only)] is selected, users can access mobile phone-specific screens via a mobile phone or PC without the need for authentication.
- Only administrators can operate the Sensor log and Buffer/Transfer.

Panasonic Network Camera support website:

<http://panasonic.co.jp/pcc/products/en/netwkcam/>

1.5.1 Enabling or Disabling the Buffer/Transfer on Your Mobile Phone

1. Access camera images from your mobile phone, and log in as an administrator (see page 39).
2. Select [Buffer/Transfer].
3. Select a trigger number that you want to enable or disable.
Example: Enabling the Buffer/Transfer setting (No.1).

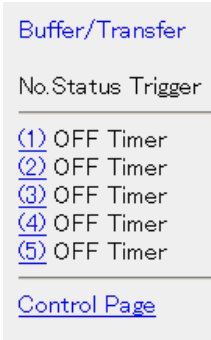

- Selecting [Control Page] changes to the previous page.

4. Select [Save].

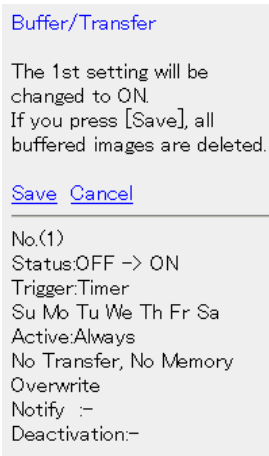

- Selecting [Save] enables or disables the buffer/transfer settings, and all buffered images will be deleted.
- Selecting [Cancel] takes you back to the previous page without saving changes.

2 Using the Camera's Basic Features

2.1 Setup Page of the Camera

1. Access the camera (see page 24).
 - The Top page is displayed.

Note

- When [Permit access from guest users] is set on the Security: Administrator page, click the [Login] tab (see page 70) and log in as an administrator.
- When users other than an administrator are accessing the camera, the [Setup] and [Maintenance] tabs are not displayed.

2. Click the [Setup] tab at the top of the page.

Top | Single | Multi | Buffered Image | **Setup** | Maintenance | Support

Basic

- (1) **Network**
- (2) Wireless
- (3) LANP
- (4) DynamicDNS
- (5) Date and Time
- (6) Camera

Account

- (7) Administrator
- (8) General User

Buffer/Transfer

- (9) Trigger
- (10) Motion Detection
- (11) Sensor Log

Advanced

- (12) Image Display
- (13) Multi-Camera
- (14) Operation Time
- (15) Indicator Control

Network

Set up network configuration.
 Select "Automatic Setup" if you connect the camera to the router and wish to set it up automatically.
 Select "Static" if you wish to assign a static IP address to the camera.
 Select "DHCP" if you are using the DHCP function of your router or ISP.

Connection Mode		
Connection Mode	Current Setting	
Automatic Setup	X	Configure network settings automatically
Static		Assign static IP address to the camera.
DHCP		Get IP address from DHCP server

Basic

- (1) **Network** Configures network settings to connect the camera to the network (see page 45).
 - (2) **Wireless** Configure a wireless network (see page 50).
 - (3) **UPnP** Enables automatic port forwarding and creates a shortcut to the camera (see page 53).
 - (4) **DynamicDNS** Registers with the DynamicDNS service (see page 56).
 - (5) **Date and Time** Sets the date and time, automatic time adjustment and summer (daylight saving) time settings (see page 62).
 - (6) **Camera** Sets camera name, white balance, AC power source frequency and color night view (see page 64).
-

Account

- (7) **Administrator**^{*1} Sets authentication and administrator security (user name and password) (see page 66).
 - (8) **General User**^{*1} Sets general user security (user name and password) and access levels (see page 71).
-

Buffer/Transfer

- (9) **Trigger** Sets image buffer or transfer by timer or motion detection (see page 74 or page 84).
 - (10) **Motion Detection** Sets the threshold and sensitivity for motion detection (see page 97).
 - (11) **Sensor Log** Sets the information required to send log notifications by e-mail (see page 100).
-

Advanced

- | | |
|---------------------------------------|--|
| (12) Image Display | Sets the resolution, image quality and refresh interval of the Single Camera and Multi-Camera page, Limit Continuous Motion JPEG setting ^{*1} , language and banner display (see page 103). |
| (13) Multi-Camera^{*1} | Sets the camera IP address or host name, and camera name on the Multi-Camera page (maximum 12 cameras) (see page 106). |
| (14) Operation Time | Sets the time period to display camera images (see page 108). |
| (15) Indicator Control | Sets the indicator display (see page 110). |
-

^{*1} If you change the [Administrator], [General User], [Multi-Camera] page settings or Limit Continuous Motion JPEG setting, changes will not be applied to video (Motion JPEG) viewers. Restart the camera to apply changes to all video viewers.

2.2 Connecting the Camera to Your Network

The Network page offers three options to configure the camera.

- [Automatic Setup] automatically assigns an unused IP address to the camera, and uses UPnP™ (Universal Plug and Play) to configure your router.
 - [Static] allows the user to use a specific IP address.
 - [DHCP] is offered for ISPs that require this option.
1. Click [Network] on the Setup page.
 2. Click a connection mode.

Connection Mode	
Connection Mode	Current Setting
Automatic Setup	Most common mode of setup.
Static	Uses a static IP address.
DHCP	Uses ISP DHCP server function.

- See below for details of each connection mode.
3. Enter each parameter in the relevant data field.

Automatic Setup

The camera automatically obtains the network settings (subnet mask, default gateway and DNS server address) using the router's DHCP feature. The camera also automatically searches for an unused IP address on your network. If you select [Yes] for Allow Access from the Internet, the camera automatically enables port forwarding using UPnP™. In this case, the camera automatically searches for an unused port number on your network in the order of 80, then from 50000 to 50050.

Allow Access from the Internet
<input type="radio"/> Yes
<input checked="" type="radio"/> No
Max. Bandwidth Usage
Unlimited ▾
Connection Type
Auto Negotiation ▾

- Clicking [Cancel] takes you back to the previous page without saving changes.

DHCP Setup

Network Configuration from Setup Program	
<input checked="" type="checkbox"/> Enable	
Internet Connection	
Port No.	<input type="text" value="80"/>
Host Name	<input type="text"/>
Default Gateway	
Default Gateway	<input type="text"/>
DNS	
DNS Server 1	<input type="text"/>
DNS Server 2	<input type="text"/>
Max. Bandwidth Usage	
<input type="text" value="Unlimited"/>	
Connection Type	
<input type="text" value="Auto Negotiation"/>	
<input type="button" value="Save"/> <input type="button" value="Cancel"/>	

Static Setup

Network Configuration from Setup Program	
<input checked="" type="checkbox"/> Enable	
Internet Connection	
Port No.	<input type="text" value="80"/>
IP Address	<input type="text" value="192.168.0.253"/>
Subnet Mask	<input type="text" value="255.255.255.0"/>
Default Gateway	
Default Gateway	<input type="text"/>
DNS	
DNS Server 1	<input type="text"/>
DNS Server 2	<input type="text"/>
Max. Bandwidth Usage	
<input type="text" value="Unlimited"/>	
Connection Type	
<input type="text" value="Auto Negotiation"/>	
<input type="button" value="Save"/> <input type="button" value="Cancel"/>	

- Clicking [Cancel] takes you back to the previous page without saving changes.

4. Click [Save] when finished.

- The new settings are saved.
- When finished, the following page is displayed.

New settings are saved.

New settings are saved. Please restart the camera.

Note.(1)All the buffered images will be erased when restarted.
 (2)Please use Setup Program to find out the camera on your network when you select "Automatic Setup" or "DHCP".

Note

The current network settings are shown on the Status page in the Maintenance section (see page 112).

5. Click [Restart].

- The camera restarts, and the Top page is displayed.
- When the camera is restarted, all buffered images in the internal memory are deleted.
- Checking [Yes] for [Allow Access from the Internet] on [Automatic Setup] may not display the Top page, since the port number may change. Use the Setup Program to access the camera.

Note

If you do not know the camera IP address when setting [Automatic Setup] or [DHCP Setup], it can be searched for by using the Setup Program (see page 134).

Setting	Description
Allow Access from the Internet (Automatic Setup Only)	<ul style="list-style-type: none"> The Allow Access from the Internet setting automatically configures the router's Port Forwarding setting (some routers call it "Address Translation", "Static IP Masquerade", "Virtual Server" or "Port Mapping"). To enable Internet access to the camera, check [Yes]. In this case, the camera automatically searches for an unused port number on your network in the order of 80, then from 50000 to 50050. To disable Internet access to the camera, check [No].
Network Configuration from Setup Program (Static/DHCP Only)	<ul style="list-style-type: none"> To prohibit the Setup Program from changing the network settings, uncheck the box.
Port Number (Static/DHCP Only)	<ul style="list-style-type: none"> The default port number is 80. When you use multiple cameras with a router on your network, each camera must be assigned its own port number (see page 55 "2.4.2 Connecting the Camera to a Router that does not Support UPnP™"). <ul style="list-style-type: none"> Do not set the following port numbers. FTP: 20 and 21, Telnet: 23, SMTP: 25, DNS: 53, POP3: 110, HTTPS: 443, ICQ: 4000 and IRC: 6661—6667. Enter a number between 1—65535. Some ISPs do not allow you to use port 80. Ask your ISP or network administrator about which port numbers are accessible over the Internet.
<ul style="list-style-type: none"> IP address Subnet Mask (Static Only)	<ul style="list-style-type: none"> If your ISP or network administrator specifies an IP address and subnet mask, enter them in each data field. If you use the camera on a LAN, set an IP address with the same class as your PC (see page 133). Set 4 numbers (0—255) and 3 periods, such as "192.168.0.253". Note that "0.0.0.0" and "255.255.255.255" are not available.

Setting	Description
Host Name (DHCP Only)	<ul style="list-style-type: none"> • If your ISP uses the DHCP function, which automatically assigns an IP address to the camera, enter the ISP-assigned host name. (The host name may be used as an authentication.) • Enter ASCII characters for the host name (see page 145). Note that [Space], ["], ['], [&], [<] and [>] are not available.
Default Gateway ¹ (Static/DHCP Only)	<ul style="list-style-type: none"> • If you have been assigned a Default Gateway address by your ISP or network administrator, enter it in this data field. • Set 4 numbers (0—255) and 3 periods, such as "192.168.0.253". Note that "0.0.0.0" and "255.255.255.255" are not available.
DNS Server Address ¹ (Static/DHCP Only)	<ul style="list-style-type: none"> • The DNS server address is required in the following situations: <ul style="list-style-type: none"> – Transferring camera images by E-mail or FTP – Setting cameras by their host names on the Multi-Camera Setup page – Using the DynamicDNS service – Using the sensor log notification • If you have been assigned a DNS server addresses by your ISP or network administrator, enter them in this data field. There are usually two addresses. • Set 4 numbers (0—255) and 3 periods, such as "192.168.0.253". Note that "0.0.0.0" and "255.255.255.255" are not available.
Max. Bandwidth Usage	<ul style="list-style-type: none"> • The bandwidth can be restricted. • Select a maximum bandwidth from [Unlimited] to [0.1 Mbps]. <p>Note</p> <p>Set a maximum bandwidth referring to the following file sizes. These are examples for a JPEG file of standard image quality. File sizes may change depending on the image quality or the brightness of the object.</p> <p>160 × 120 pixels: About 3 KB (24 Kbit) 320 × 240 pixels: About 10 KB (80 Kbit) 640 × 480 pixels: About 18 KB (144 Kbit)</p>

Setting	Description
Connection Type	<ul style="list-style-type: none">• Select [Auto Negotiation] normally. For wireless connection, [Auto Negotiation] must be selected. If the camera cannot be accessed, see page 9 of Troubleshooting on the CD-ROM.

- *1 If the IP address is automatically obtained from a DHCP server, this field does not need to be set.

2.3 Using Wireless LAN

Wireless communication is possible by adjusting the settings of the wireless LAN to those of the wireless router. Take a note of the settings and save them for reference. For more information about wireless settings, please refer to <http://panasonic.co.jp/pcc/products/en/netwkcaml/>

1. Click [Wireless] on the Setup page.
2. Set each parameter for Wireless Configuration.

Wireless Configuration	
SSID	NetCam*****
Communication mode	<input type="radio"/> 802.11b <input checked="" type="radio"/> 802.11b/g <input type="radio"/> 802.11g exclusive

Setting	Description
SSID	<ul style="list-style-type: none"> • The SSID must be set to match the SSID your wireless router or wireless LAN uses. The SSID is limited to 32 characters (alpha numeric) and is case sensitive.
Communication mode	<ul style="list-style-type: none"> • 802.11b: There are a lot of 802.11b-compliant products and they are inexpensive. They are widely prevalent, so it is likely that 802.11b will match your existing wireless devices. • 802.11b/g (default): This mode supports both the 802.11b and 802.11g wireless LAN standards. It is the communication mode that is easiest to install on your existing wireless LAN. • 802.11g exclusive: This mode communicates using 802.11g only. It does not support the mixed standard mode of 802.11b/g, so it allows the use of original features of 802.11g.¹⁾

¹⁾ Even if "802.11g exclusive" is in use, the existence of other wireless devices using a 2.4 GHz bandwidth—including 802.11b wireless devices— may make the baud rate on the 802.11g slower.

3. Set each parameter for Encryption.

Setting	Description
Cipher	<ul style="list-style-type: none"> Select to encrypt or not encrypt. To prevent unauthorized users from reading data, selecting [WEP] is recommended.
WEPKey Selection	<ul style="list-style-type: none"> The checked WEPKey is used as the standard WEPKey. Check the same WEPKey as the one selected for the router.
WEPKey1—4	<ul style="list-style-type: none"> Select one from [HEX, 10 characters 64 bit], [HEX, 26 characters 128 bit], [HEX, 32 characters 152 bit], [ASCII 5 characters 64 bit], [ASCII 13 characters 128 bit] or [ASCII 16 characters 152 bit]. Selecting [WEP] at Cipher enables you to set WEPKey1—4. One or all of the four keys can be set. Check the same key number as set to the wireless router, and set the same encryption as at the wireless router. <p><Example></p> <p>HEX, 10 characters 64 bit : 012345abcd</p> <p>HEX, 26 characters 128 bit : 0123456789abcdef012345abcd</p> <p>HEX, 32 characters 152 bit : 0123456789abcdef0123456789abcdef</p> <p>ASCII 5 characters 64 bit : 012yz</p> <p>ASCII 13 characters 128 bit : 0123456uvwxyz</p> <p>ASCII 16 characters 152 bit : 0123456789uvwxyz</p>

Note

- Some wireless devices do not support the WEP 152 bit encryption.
 - The camera supports only open system authentication. If the wireless router or access point is set to shared key authentication, set it to auto or open system.
4. Click [Save] when finished.
 - The new settings are saved.
 - When finished, "Success!" is displayed.
 5. Click [Go to Wireless configuration page].
 - The Wireless page is displayed.
 6. Set the switch to WIRELESS.

Note

- Encryption helps protect data within wireless LAN from third parties.
- Enter both the MAC addresses for the camera itself and the camera's wireless module to enable the MAC address filtering feature on the wireless router. The wireless module MAC address is one value higher than the camera MAC address.
- It takes about 1 minute for the new settings to become effective.
- It is not possible to access the camera simultaneously by both wired and wireless connection.
- To communicate using wireless connection, set up the camera using wired connection and flip the switch from WIRED to WIRELESS as shown below.
- Even if the camera is set to wired connection, it emits electrical waves for about 5 minutes after the power has been on. During this time, the router's wireless indicator is on or blinking. Electrical waves will stop being transmitted after about 5 minutes.

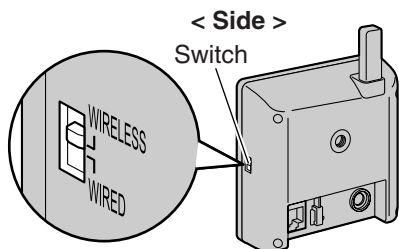

- When you switch from WIRED to WIRELESS or vice versa, restart the camera. Some routers may also need to be restarted after switching.

2.4 Using UPnP™ (Universal Plug and Play)

UPnP™ can automatically configure your router to make it accessible from the Internet. In order to use this feature, your router needs to support UPnP™, and it must be enabled. UPnP™ is disabled on most routers by default. See <http://panasonic.co.jp/pcc/products/en/netwkcam/> and your router's manual for details of how to enable UPnP™. After UPnP™ is enabled on the router, set [Enable] for auto port forwarding.

1. Click [UPnP] on the Setup page.
2. Set up UPnP.

The screenshot shows a web interface for configuring UPnP. It has two main sections: 'Auto Port Forwarding' and 'Display Shortcut Icon in My Network Places'. Each section has radio buttons for 'Enable' and 'Disable'. In the first section, 'Disable' is selected. In the second section, 'Enable' is selected. At the bottom of the form is a 'Save' button.

Setting	Description
Auto Port Forwarding	<ul style="list-style-type: none"> If the network setting is [Static] or [DHCP], enabling auto port forwarding allows you to access the camera from the Internet. <p>Note</p> <p>If the network setting is [Automatic Setup], also enable [Allow Access from the Internet] on the Network page (see page 47).</p>
Display Shortcut Icon in My Network Places	<ul style="list-style-type: none"> Enabling this creates a shortcut to the camera in the My Network Places folder. <p>Note</p> <p>To enable this feature when using Windows XP or Windows Me, enable the UPnP™ Windows component beforehand (see page 144).</p>

3. Click [Save] when finished.
 - The new settings are saved.
 - When finished, "Success!" is displayed.
4. Click [Go to UPnP page].
 - The UPnP page is displayed.

2.4.1 Connecting the Camera to a Router that Supports UPnP™

To allow access from the Internet with a router supporting UPnP™, follow the procedures shown in Getting Started.

Note

- On some routers, the UPnP™ feature is disabled by default. Enable your router's UPnP™ feature following the router manual before you set up the camera. See the Panasonic Network Camera support website at <http://panasonic.co.jp/pcc/products/en/netwkcaml> for details.
- If a maximum idle time is set in PPPoE or PPTP connection with your ISP, disable it on the router. See the router manual for details.

2.4.2 Connecting the Camera to a Router that does not Support UPnP™

To allow access from the Internet with a router that does not support UPnP™, follow the procedures below.

1. Select [Static] on the Network page.

- (1) Access the camera (see page 24).
- (2) Click the [Setup] tab at the top of the page.
- (3) Select [Static] on the Network page.
 - The Static IP Address Configuration page is displayed. Make a note of the IP address and port number, since they are required to enable port forwarding on the router.

Note

You must assign a unique IP address and a unique port number to each camera in the LAN.

- (4) Click [Save] without changing the settings.
- (5) Click [Restart].

2. Enable port forwarding^{*1} on the router.

Using the IP address and port number noted on step 1-(3), enable port forwarding on the router. See the router manual for how to enable port forwarding.

3. Register with the DynamicDNS service.

Port Forwarding feature^{*1}

The port forwarding feature is required to allow camera access from the Internet with a router that does not support UPnP™. It exchanges a local IP address for a global one.

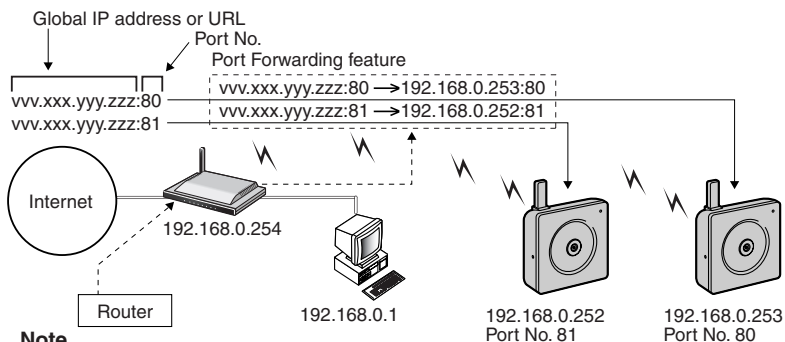

Note

The IP addresses shown above may differ from those offered on your home network.

^{*1} "Port forwarding" may be called "Address translation", "Static IP Masquerade", "Virtual server" or "Port mapping" in other products.

2.5 Registering with the DynamicDNS service

DynamicDNS is a service that allows you to assign an easy-to-remember name to the camera, for example, similar to your favorite website. It also allows you to easily access the camera, even when your ISP changes the IP address. Panasonic Communications recommends that you register with a DynamicDNS to access the camera from the Internet. See <http://www.viewnetcam.com> for details about the Viewnetcam.com service.

1. Click [DynamicDNS] on the Setup page.
 - When you select [Disable] or [Viewnetcam.com] (see page 56)
 - When you select [User-specified DynamicDNS] (see page 58)

When you select [Disable]

2. Click [Save].

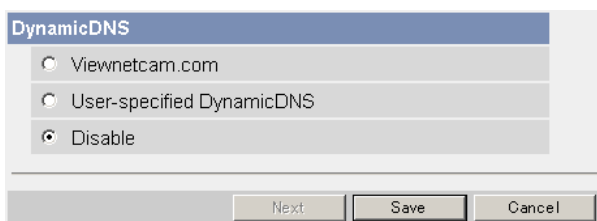

The screenshot shows a web interface titled "DynamicDNS". It contains three radio button options: "Viewnetcam.com", "User-specified DynamicDNS", and "Disable". The "Disable" option is selected, indicated by a filled radio button. Below the options are three buttons: "Next", "Save", and "Cancel".

- The DynamicDNS service is disabled.
- Clicking [Cancel] cancels your settings without saving changes.

When you select [Viewnetcam.com]

2. Click [Next].

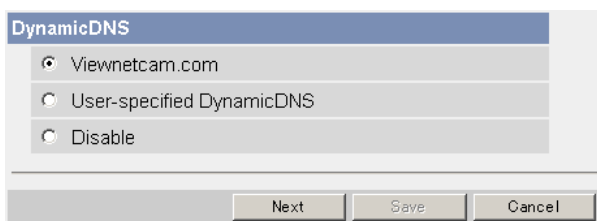

The screenshot shows a web interface titled "DynamicDNS". It contains three radio button options: "Viewnetcam.com", "User-specified DynamicDNS", and "Disable". The "Viewnetcam.com" option is selected, indicated by a filled radio button. Below the options are three buttons: "Next", "Save", and "Cancel".

- Clicking [Cancel] cancels your settings without saving changes.

3. Click [Save].

- Clicking [Cancel] cancels your settings without saving changes, and the DynamicDNS window is displayed.

Setting	Description
Personal (Camera) URL	<ul style="list-style-type: none"> • The camera's personal URL will be displayed after you register with the Viewnetcam.com service.
Your Account Link	<ul style="list-style-type: none"> • The URL required to register with the Viewnetcam.com service is displayed. Clicking [Your Account Link] item name displays the Viewnetcam.com registration website.

4. Click [OK].

- When finished, "Success!" is displayed.
- The new settings are saved.

5. Click [Go to Viewnetcam.com page].

- The Viewnetcam.com page is displayed.

6. Click **Your Account Link**.

- The Viewnetcam.com registration website is displayed.

Note

- When the Viewnetcam.com registration website is not displayed, confirm that the URL is displayed in the right column next to Your Account Link. If the URL is not displayed, follow the procedures below.

1. Wait for a moment, then click [Refresh] on the web browser.
2. Confirm that your network (your PC and camera) is connected to the Internet.

- Personal (Camera) URL is available after registering with the Viewnetcam.com service.
- If port forwarding is not enabled or your network is not connected to the Internet, the Viewnetcam.com service is not available.

7. Register with the Viewnetcam.com service following the instructions on the website.

- The Viewnetcam.com page is displayed.

8. Access your camera with the registered URL from the Internet (see page 24).
 - When the Top page is displayed, Viewnetcam.com registration is complete.

Note

- It may take a maximum of 30 minutes for the registered URL to work.
- If "Expired" is displayed for the Personal (Camera) URL on the Viewnetcam.com page or for the Camera URL at Viewnetcam.com on the Status page, restart the camera. After that, confirm that your registered URL is displayed on the pages.

Confirming Internet access

Due to the router's specifications, the image may not be displayed even if you access the camera from your PC on the same LAN as the camera. In this case, try:

- Accessing from a PC on another network (see page 24)
- Accessing from your mobile phone (see page 39)

When you select [User-specified DynamicDNS]

2. Click [Next].

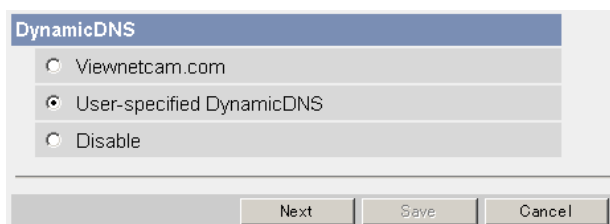

- Clicking [Cancel] cancels your settings without saving changes.

3. Set each parameter.

- Clicking [Cancel] cancels your settings without saving changes.
- DynamicDNS information can be obtained from companies in the DynamicDNS service industry.

Setting	Description
DynamicDNS Server URL ¹	Input URL acquired from the DynamicDNS service industry company. Enter 1—255 characters. The URL must be started with "http://".
Updating time	Specify the updating time.
User Name ²	Input User Name acquired from the DynamicDNS service industry company. Enter up to 63 characters.
Password ²	Input Password acquired from the DynamicDNS service industry company. Enter up to 63 characters.

¹ Note that [Space] and ["] are not available.

² Note that ["] and [:] are not available.

4. Click [Save] after finished.

- The new settings are saved.
- When finished, "Success!" is displayed.

5. Click [Go to DynamicDNS page].

- The DynamicDNS page is displayed.

Note

- It may take several minutes for the registered URL to connect.
- Some DynamicDNS services may not connect.

Confirming Internet access

Due to the router's specifications, the image may not be displayed even if you access the camera from your PC on the same LAN as the camera. In this case, try:

- Accessing from a PC on another network (see page 24)
- Accessing from your mobile phone (see page 39)

2.5.1 DynamicDNS Service

DynamicDNS allows you to choose an easy-to-remember address (such as "bob.viewnetcam.com") that can be used to view images from your camera over the Internet.

What are the advantages of DynamicDNS service?

In order to view camera images over the Internet, you need to know your camera's global IP address. However, many Internet Service Providers (ISPs) assign their customers a "dynamic" IP address that changes monthly, weekly, or each time they log on. Unless you have been assigned a static IP address (an IP address that does not change periodically) by your ISP, you may find it difficult to access your camera over the Internet. The Viewnetcam.com service allows you to access your camera even if your assigned global IP address changes.

How the DynamicDNS service works

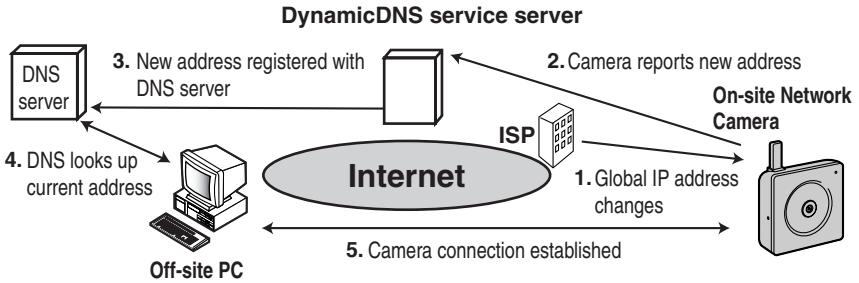

1. Your ISP assigns a global IP address to your Internet access account that changes periodically. This is the address needed to access the camera over the Internet.
2. When your ISP-assigned global IP address changes, your camera automatically notifies the DynamicDNS service server of the new address in the DynamicDNS. The camera notifies the DynamicDNS service server of the new address in DynamicDNS in the following cases.
 - When starting the camera
 - When an update interval time has been set
 - When clicking the [Save] button
3. The DynamicDNS server contacts the Domain Name System (DNS) server and registers your new global IP address to your chosen DynamicDNS address (such as "bob.viewnetcam.com").
4. When you enter your DynamicDNS address in your web browser while away from home or the office, the DNS server looks up the global IP address assigned to your DynamicDNS address.
5. The DNS server finds your current global IP address and allows you to connect to your camera.

Note

- Ask your ISP about what type of IP address you are using.
- Some ISPs assign you a local IP address. In this case, the DynamicDNS service cannot be used.
- If the camera is using a port number other than 80, the port number must be specified at the end of the DynamicDNS URL. For example:
 - Using port 80: [http://\(Cameraname\).viewnetcam.com](http://(Cameraname).viewnetcam.com)
 - Using any other port: [http://\(Cameraname\).viewnetcam.com:Port Number](http://(Cameraname).viewnetcam.com:Port Number)

2.6 Setting the Date and Time

The Date and Time page allows you to set and confirm the date and time. The date and time are used for the settings of the trigger setting, sensor log, operation time and Buffered Image page.

Note

Saving a new date and time deletes all buffered images on the internal memory.

1. Click [Date and Time] on the Setup page.
2. Set each parameter.
 - Set [Automatic Time Adjustment] to synchronize the time automatically with an NTP server.

Time Setting			
Date	Month <input type="text" value="Jan"/>	Day <input type="text" value="1"/>	Year <input type="text" value="00"/>
Format	<input type="text" value="AM/PM"/>	<input type="text" value="24H"/>	
Time	Hour <input type="text" value="12"/>	Minute <input type="text" value="51"/>	<input type="text" value="AM"/>
Automatic Time Adjustment			
<input type="checkbox"/> Enable			
NTP Server Address or Host Name	<input type="text"/>		
Time Zone	<input type="text" value="GMT 00:00 Western Europe Time"/>		
Adjust Clock for Daylight Saving Time			
<input type="checkbox"/> Enable			
Start Day:	Month <input type="text" value="Mar"/>	Weekday <input type="text" value="Last Sunday"/>	Hour <input type="text" value="1"/> <input type="text" value="AM"/>
End Day:	Month <input type="text" value="Oct"/>	Weekday <input type="text" value="Last Sunday"/>	Hour <input type="text" value="1"/> <input type="text" value="AM"/>
<input type="button" value="Save"/>		<input type="button" value="Cancel"/>	

- Clicking [Cancel] cancels your settings without saving changes.

Setting	Description
Time Setting	<ul style="list-style-type: none"> Set the date and format (AM/PM or 24 H). The interface and available values depend on the format. The date and time are used for the settings of the trigger setting, sensor log, operation time and Buffered Image page. Note that the format for the subject and file name of E-mails by E-mail or FTP transfer can only be 24 h.
Automatic Time Adjustment	<ul style="list-style-type: none"> NTP (Network Time Protocol) server synchronizes the camera's internal clock automatically every day. Check the box to enable it. Set the NTP server IP address. Set 4 numbers (0—255) and 3 periods, such as "192.168.0.253". Note that "0.0.0.0" and "255.255.255.255" are not available. Set a host name (1—255 characters). Note that [Space], ["], ['], [&], [<] and [>] are not available. Select your time zone. <p>Note</p> <p>The camera will not synchronize to the NTP server if there is more than a 1 hour difference between the NTP server time and the camera's current time. This is to protect the camera's time setting from fraudulent NTP server tampering, incorrect time information, etc.</p>
Adjust Clock for Daylight Saving Time	<ul style="list-style-type: none"> During summer time, the internal clock is turned forward an hour. The clock will shift one hour forward at the set time on the Start Day, and move back one hour at the set time on the End Day. Check the box to enable it. <p>Note</p> <p>An "s" is inserted between the date and time of the time stamp when this feature is enabled. The time stamp is printed on images transferred by the Image Transfer feature.</p>

- Click [Save] when finished.
 - The new settings are saved.
 - When finished, "Success!" is displayed.
- Click [Go to Date and Time page].
 - The Date and Time page is displayed.

Note

Date and time settings become incorrect depending on the length of time the camera is turned on and its internal temperature. Using the Automatic Time Adjustment is recommended.

2.7 Changing Camera Settings

The Camera page allows you to set the camera name, white balance, AC power source frequency and color night view.

1. Click [Camera] on the Setup page.
2. Set each parameter.

The screenshot shows a web interface for camera settings. It is organized into four main sections, each with a blue header:

- Camera Name:** A text input field containing "NetworkCamera".
- White Balance:** A dropdown menu currently set to "Auto".
- AC Power Source Frequency:** Two radio button options: "50Hz" (which is selected) and "60Hz".
- Color Night View:** Two radio button options: "Enable" (which is selected) and "Disable".

At the bottom right of the form are two buttons: "Save" and "Cancel".

- Clicking [Cancel] cancels your settings without saving changes.

Setting	Description
Camera Name	<ul style="list-style-type: none"> • The camera name is displayed on the Single Camera page. • Enter ASCII characters (see page 145) or characters from other languages (1—15 characters for a 1-byte character and 1—7 characters for a 2-byte character). Note that [Space], ["], ['], [&], [<], and [>] are not available.

Setting	Description
White Balance	<p>Select from the following options.</p> <ul style="list-style-type: none"> • Auto (default) — Automatic adjustment • Fixed Indoor — Electric bulb (2800 K) • Fixed Fluorescent (White) — White (3600 K) • Fixed Fluorescent (Daylight) — Daylight (4000 K) • Fixed Outdoor — Solar light (6000 K) <p>Note</p> <p>The kelvin (symbol: K) is the standard unit for color temperature.</p>
AC Power Source Frequency	<ul style="list-style-type: none"> • This setting may correct flickering caused by power line frequency. <ul style="list-style-type: none"> – 50 Hz (default) – 60 Hz
Color Night View	<ul style="list-style-type: none"> • In the color night view mode, the camera image becomes brighter in a low illuminance. The camera image returns to normal operation in a bright location. • If you enable the color night view mode, refresh interval may increase. • Subjects that are moving in low illumination may be blurred, not distinguished, or not displayed. <p>Note</p> <p>When the camera transmits a dark scene, the camera image may become white, or horizontal lines may be displayed on the screen. This is one of the characteristics of a CMOS sensor. This is not a malfunction.</p>

3. Click [Save] when finished.
 - The new settings are saved.
 - When finished, "Success!" is displayed.
4. Click [Go to Camera page].
 - The Camera page is displayed.

3 Registering Users

3.1 Changing the Authentication Setting and Administrator User Name and Password

The Security: Administrator page allows you to change authentication, and the administrator's user name and password. An authentication window allows registered users to access the camera.

Note

- If you access the camera for the first time, the window for setting the administrator's user name and password is displayed. Make a note of the user name and password so that you will not forget them.
- The user name and password should be secured at your own responsibility. Pay attention to the following points.
 - Set a user name and password with as many characters as possible.
 - Change the password regularly.
- Setting [Permit access from guest users] (permitting access without a User Name or Password) or [Permit access from guest users (mobile only)] (permitting access without a User Name or Password) at General Authentication risks the images being viewed by third parties. Control the contents of the images accordingly.

IMPORTANT

- It is important to limit access to the camera by use of a unique User Name and a secret Password. Since the camera is accessed through the Internet it is possible that the camera could be accessed by unknown individuals, including those who are commonly known as "crackers" to whom you do not want to allow access. The use of a unique User Name and a Password known only to you will help insure that only authorized individuals are given access to the camera. You have the option of proceeding without a User Name and Password, but it is strongly recommended that you utilize these protections.
1. Click [Administrator] on the Setup page.

2. Set each parameter.

- Clicking [Cancel] cancels your settings without saving changes.

Setting	Description
<p>General Authentication</p>	<p>Authentication has 3 phases.</p> <ul style="list-style-type: none"> • If you set [Permit access from guest users], the camera does not display the authentication window in camera access. All guest users can view images without a user name and password. <p>Note</p> <p>If you set [Permit access from guest users], [Login] tab is displayed at the top of the page. After you log in as an administrator (see page 70), the Setup page and the Maintenance page can be accessed.</p>  <ul style="list-style-type: none"> • If you set [Permit access from guest users (mobile only)], an authentication window is not displayed even if you access the mobile phone page. All guest users can view images without a user name and password. • If you set [Do not permit access from guest users], an authentication window is displayed to access the camera. Users must enter the user name and password.

Setting	Description
User Name/ Password	<ul style="list-style-type: none"> • User Name (6 to 15 characters): Enter the user name. • Password (6 to 15 characters): Enter the password. <p>Note</p> <p>The password must be different from the user name.</p> <ul style="list-style-type: none"> • Retype Password: Reenter the password. • Enter ASCII characters (see page 145). Note that [Space], ["], ['], [&], [<], [>] and [:] are not available.

Note

- When setting authentication, set the user name and password, and save them.
- When users other than an administrator are accessing the camera, the [Setup] and [Maintenance] tabs will not be displayed.
- The user name and password are case sensitive.

3. Click [Save] when finished.

- The new settings are saved.
- When finished, "Success!" is displayed.

4. Click [Go to Security: Administrator page].

- The Security: Administrator page is displayed.

Note

When the user name and password have been changed, the camera displays an authentication window. Enter the user name and password, and click [OK].

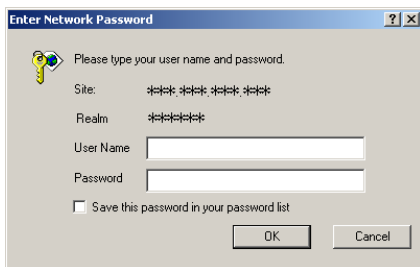

Administrator/General Users/Guest Users

The camera has 3 user levels (administrator, general users and guest users).

Items	Administrator	General Users	Guest Users
User Name and Password	Required	Required	Not Required
Number of Users	1	50	—
Accessible Pages	All Pages	Pages Except For Setup and Maintenance page	Pages Except For Setup and Maintenance page
Access Level	All Operations	Access level can be set for each general user (see page 71).	Access level can be set for guest users (see page 71).

Note

Guest users mean unregistered users. Set [Permit access from guest users] or [Permit access from guest users (mobile only)] on the Security: Administrator page (see page 66) to allow access from guest users.

3.2 Logging in to the Camera

If you set [Permit access from guest users] on the Security: Administrator page, [Login] tab is displayed at the top of the page. After you log in as an administrator, the Setup page and the Maintenance page can be accessed.

1. Click [Login] tab at the top of the page.



2. Check a login mode, and click [Login].

Note

The authentication window is displayed. Enter the user name and password set for General Users or Administrator.

3. Enter a valid user name and password according to the Login mode selected in step 2, and click [OK].

3.3 Creating, Modifying or Deleting General Users

The General User page allows you to create, modify or delete general users. Up to 50 general users can be registered. The access level is set for each general user. If you set [Permit access from guest users] or [Permit access from guest users (mobile only)] on the Security: Administrator page, the access level can be set for guest users.

Note

For general users, the Setup and Maintenance tabs are not displayed.

1. Click [General User] on the Setup page.
2. To create a general user, click [Create].
 - When setting [Do not permit access from guest users]
 - When setting [Permit access from guest users] or [Permit access from guest users (mobile only)]

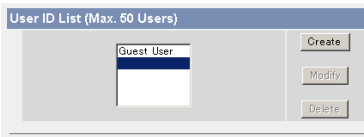

- To change the settings of general users or guest users, select their name and click [Modify]. The modification page is displayed.
- To delete a general user, select the name and click [Delete]. The confirmation page is displayed.

3. Set each parameter.

- Settings for general users
- Settings for guest users

The screenshot shows a web form with two main sections. The first section, titled 'Input User Name and Password', contains three input fields: 'User Name (6 to 15 Characters)', 'Password (6 to 15 Characters)', and 'Retype Password'. The second section, titled 'Access Level', contains two radio button options: 'Level 1 (Camera viewing only)' and 'Level 2 (Camera viewing and Brightness control)'. At the bottom of the form are 'Save' and 'Cancel' buttons.

The screenshot shows a web form titled 'Access Level'. It contains two radio button options: 'Level 1 (Camera viewing only)' and 'Level 2 (Camera viewing and Brightness control)'. At the bottom of the form are 'Save' and 'Cancel' buttons.

- Clicking [Cancel] takes you back to the previous page without saving changes.

Setting	Description
User ID List	<ul style="list-style-type: none"> • Up to 50 general users can be registered. • The list is used to modify or delete general user settings.
User Name/ Password	<ul style="list-style-type: none"> • User Name (6 to 15 characters): Enter the user name. • Password (6 to 15 characters): Enter the password. <p>Note</p> <p>The password must be different from the user name.</p> <ul style="list-style-type: none"> • Retype Password: Reenter the password. • Enter ASCII characters (see page 145). Note that [Space], ["], ['], [&], [<], [>] and [:] are not available.
Access Level	<p>An access level is set for each general user.</p> <ul style="list-style-type: none"> • Level 1 : Only the camera images can be viewed. • Level 2 : The camera images can be viewed and the brightness can be adjusted.

4. Click [Save] when finished.
 - The new settings are saved.
 - When finished, "Success!" is displayed.
5. Click [Go to General User page].
 - The General User page is displayed.

4 Buffering or Transferring Images

4.1 Procedures of Buffering or Transferring Images

The procedures from this page to page 96 described the settings of the image buffer or transfer. See the procedures below to understand the general outline of the settings.

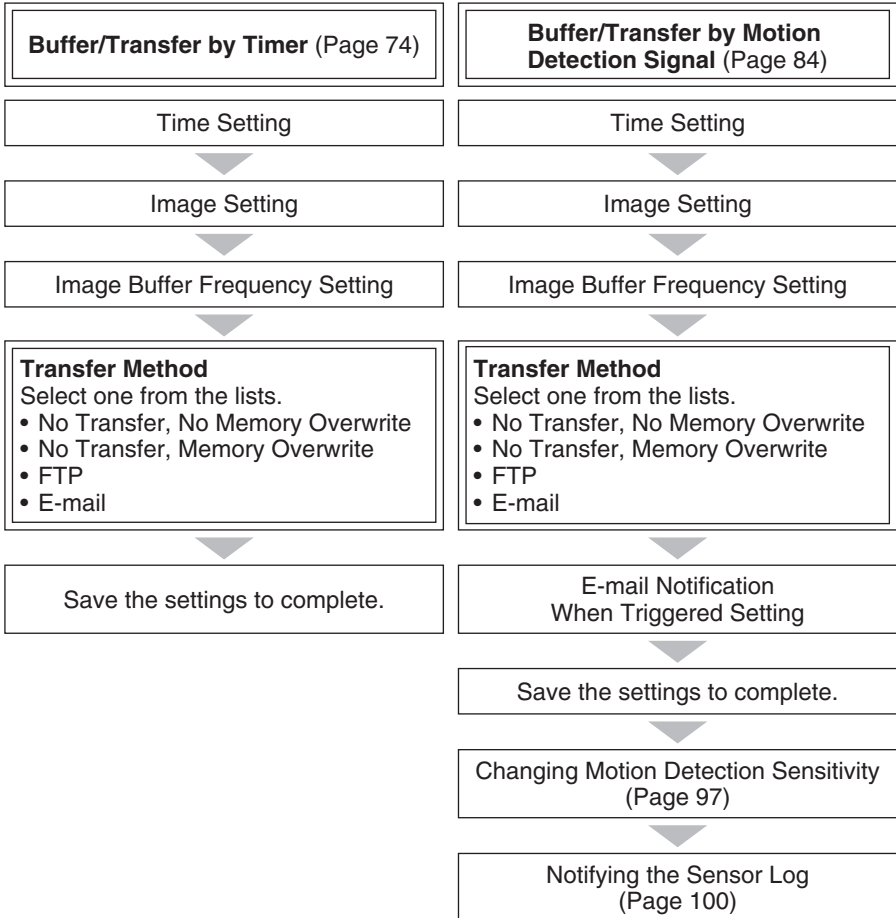

4.2 Buffering or Transferring Images by Timer

The Trigger page allows you to enable image buffer/transfer by E-mail or FTP.

1. Click [Trigger] on the Setup page.
2. Click a **No.** to enable buffer/transfer.

Trigger													
No.	Status	Trigger	Sun	Mon	Tue	Wed	Thu	Fri	Sat	Active Time of Trigger	Transfer Method	Notify	Deactivation
1	OFF	Timer	X	X	X	X	X	X	X	Always	No Transfer, No Memory Overwrite	-	-
2	OFF	Timer	X	X	X	X	X	X	X	Always	No Transfer, No Memory Overwrite	-	-
3	OFF	Timer	X	X	X	X	X	X	X	Always	No Transfer, No Memory Overwrite	-	-
4	OFF	Timer	X	X	X	X	X	X	X	Always	No Transfer, No Memory Overwrite	-	-
5	OFF	Timer	X	X	X	X	X	X	X	Always	No Transfer, No Memory Overwrite	-	-

3. Check [Enable Image Buffer/Transfer], and select [Timer] for the trigger, and click [Next>].

Note

- Click [Delete Buffered Images] to delete images already buffered.
- Click [Save] to save the settings. The buffered images will be deleted.
- Clicking [Cancel] takes you back to the Trigger page without saving changes.

Setting	Description
Enable Image Buffer/Transfer	<ul style="list-style-type: none"> • Check the box to enable the Trigger setting. Uncheck the box to disable it.

Setting	Description
Trigger	<ul style="list-style-type: none"> Selecting [Timer] enables the camera to buffer/transfer images during the specified date and time by timer. Selecting [Motion Detection] enables the camera to buffer/transfer images when the motion is detected during the specified date and time.

4. Set the time, and click [Next>].

Note

The timer works by an internal clock. Set the date and time before using timer buffer/transfer (see page 62).

- Clicking [<Back] takes you back to the previous page.
- Clicking [Cancel] takes you back to the Trigger page without saving changes.

Setting	Description
Day of the week	<ul style="list-style-type: none"> Check the box to enable the day. Uncheck the box to disable it.
Active Time of Trigger	<ul style="list-style-type: none"> To set a trigger time, check the time option and set a time period. Check the [Always] option if you are not specifying a time period.

5. Set the image settings, and click [Next>].

- Clicking [<Back] takes you back to the previous page.
- Clicking [Cancel] takes you back to the Trigger page without saving changes.

Setting	Description
Image Resolution	<ul style="list-style-type: none"> Select an image resolution (640 × 480, 320 × 240 (default) or 160 × 120 pixels) for the buffer/transfer.
Image Quality	<ul style="list-style-type: none"> Select the image quality. [Favor Clarity] optimizes for good quality. [Standard] offers standard quality. (default) [Favor Motion] optimizes for enhanced motion. [Mobile Phone] is for a transfer to a mobile phone. <p>Note 640 × 480 pixels cannot be set for a transfer to a mobile phone.</p>

6. Set the image buffer frequency, and click [Next>].

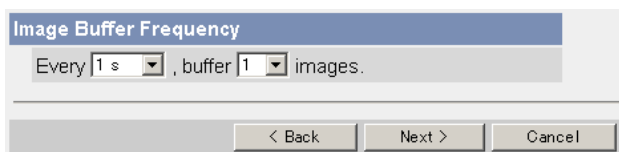

Note

Due to the network environment, object and the number of simultaneous accesses, the camera may not record the number of images that you set. In this case, set the image buffer frequency longer.

- Clicking [<Back] takes you back to the previous page.
- Clicking [Cancel] takes you back to the Trigger page without saving changes.

Setting	Description
Image Buffer Frequency	<ul style="list-style-type: none"> Select an image buffer frequency to buffer or transfer the image. (1 image per hour—15 images per second)

7. Select the transfer method, and click [Next>].

The screenshot shows a menu titled "Transfer Method" with the following options:

- No Transfer, No Memory Overwrite
- No Transfer, Memory Overwrite
- FTP
- E-mail

At the bottom of the menu are three buttons: "< Back", "Next >", and "Cancel".

- Clicking [<Back] takes you back to the previous page.
- Clicking [Cancel] takes you back to the Trigger page without saving changes.

Note

If you transfer images by E-mail or FTP, confirm that the default gateway and DNS server addresses are assigned correctly (see page 45).

Setting	Description
No Transfer, No Memory Overwrite	• If the internal memory is full, the camera stops buffering.
No Transfer, Memory Overwrite	• If the internal memory is full, the camera deletes the old images, and continues to buffer the image.
FTP	• The camera transfers the image to an FTP server (see page 78).
E-mail	• The camera transfers the image by E-mail (see page 80).

When you set [FTP] for Transfer Method

Select [FTP], and click [Next>]. The following page is displayed.

FTP	
Server IP Address or Host Name	<input type="text"/>
Port No. (Usually Use 21)	<input type="text" value="21"/>
Login ID (0 to 63 Characters)	<input type="text"/>
Password (0 to 63 Characters)	<input type="password"/>
Login Timing	<input type="text" value="Every Time"/>
Upload File Name (1 to 234 Characters)	<input type="text"/>
Overwrite setting	<input type="text" value="Overwrite File"/>
Data Transfer Method	<input type="text" value="Passive Mode"/>

- Clicking [<Back] takes you back to the previous page.
- Clicking [Cancel] takes you back to the Trigger page without saving changes.

Setting	Description
Server IP Address or Host Name ¹	<ul style="list-style-type: none"> If you set a server IP address, set 4 numbers (0—255) and 3 periods, such as "192.168.0.253". Note that "0.0.0.0" and "255.255.255.255" are not available. Or set a host name (1—255 characters).
Port No.	<ul style="list-style-type: none"> Enter a number (1—65535). Usually set to 21.
Login ID ²	<ul style="list-style-type: none"> If your ISP requires a login ID, set it (0—63 characters).
Password ²	<ul style="list-style-type: none"> If your ISP requires a password, set it (0—63 characters).
Login Timing	<ul style="list-style-type: none"> Select the login setting for the FTP server. If you set [One Time] and the image buffer frequency value is set within 1 minute, the camera logs in to the server only once. This can reduce transfer time.
Upload File Name ¹	<ul style="list-style-type: none"> Set a file name on the FTP server to receive the transferred files. Enter 1—234 characters. Entering "\" creates directories for a file. (E.g. NetworkCamera\image)
Overwrite Setting	<ul style="list-style-type: none"> Selecting [Overwrite File] overwrites the image on the server with a newer image. Selecting [Save as New File with Time Stamp] saves the image attaching time stamps on the file name, and the images are not overwritten. (E.g. <u>image20050101093020500</u>.jpg) The underlined numbers mean "9h30min20s500ms on January 1, 2005". The letter "s" is inserted after the day when referring to a summer time zone.
Data Transfer Method	<ul style="list-style-type: none"> Select [Passive Mode] normally. If the transfer does not work, select [Active Mode] and check the operation.

¹ Note that [Space], ["], ['], [&], [<] and [>] are not available.

² Note that [""] is not available.

When you set [E-mail] for Transfer Method

Select [E-mail], and click [Next>]. The following page is displayed.

E-mail Transfer	
SMTP Server IP Address or Host Name	<input type="text"/>
Port No. (Usually Use 25)	<input type="text" value="25"/>
Reply E-mail Address	<input type="text"/>
Destination E-mail Address 1	<input type="text"/>
Destination E-mail Address 2	<input type="text"/>
Destination E-mail Address 3	<input type="text"/>
Subject (Up to 44 Characters)	<input type="text"/>
Text (Up to 63 Characters)	<input type="text"/>
How to authenticate	
<input type="radio"/> No authentication	
<input type="radio"/> POP before SMTP authentication	
POP3 Server IP Address or Host Name	<input type="text"/>
Port No. (Usually Use 110)	<input type="text" value="110"/>
Login ID (1 to 63 Characters)	<input type="text"/>
Password (0 to 63 Characters)	<input type="text"/>
<input type="radio"/> SMTP authentication	
Login ID (1 to 63 Characters)	<input type="text"/>
Password (0 to 63 Characters)	<input type="text"/>
<input type="button" value=" < Back"/> <input type="button" value=" Save"/> <input type="button" value=" Cancel"/>	

- Clicking [<Back] takes you back to the previous page.
- Clicking [Cancel] takes you back to the Trigger page without saving changes.

Note

- The camera works only with an SMTP (Simple Mail Transfer Protocol) server. It does not work with mail servers like "Hotmail®" that use a web browser.
- The date and time (24-h format) is automatically attached to the subject on the E-mail. The file name is "image.jpg".
E.g. When the "camera" is entered on the subject:
"camera:20050101093020500".
The underlined numbers mean "9 h 30 min 20 s 500 ms on January 1, 2005".
The letter "s" is inserted after the day when referring to a summer time zone.

Setting	Description
SMTP Server IP Address or Host Name ¹	<ul style="list-style-type: none"> If you set a server IP address, set 4 numbers (0—255) and 3 periods, such as "192.168.0.253". Note that "0.0.0.0" and "255.255.255.255" are not available. Or set a host name (1—255 characters).
Port No.	<ul style="list-style-type: none"> Enter a number (1—65535). Usually set to 25.
Reply E-mail Address ²	<ul style="list-style-type: none"> Set the sender's E-mail address. We recommend you to set the administrator's E-mail address.
Destination E-mail Address ² 1—3	<ul style="list-style-type: none"> Set up to 3 destination E-mail addresses.
Subject ²	<ul style="list-style-type: none"> Enter a subject with ASCII characters (see page 145) or characters from other languages (0—44 characters for a 1-byte character and 0—22 characters for a 2-byte character).
Text ²	<ul style="list-style-type: none"> Enter text with ASCII characters (see page 145) or characters from other languages (0—63 characters for a 1-byte character and 0—31 characters for a 2-byte character). Note that [end-of-line] key is not available.

Setting	Description
How to authenticate	<p>You can select the authentication method: [No authentication], [POP before SMTP authentication] and [SMTP authentication]. POP server authentication may be required by your ISP. In that case, set POP before SMTP authentication.</p> <ul style="list-style-type: none"> • No authentication: No authentication when sending an e-mail. • POP before SMTP authentication: Some SMTP servers that send e-mails do not have an authentication feature. Therefore, the camera uses the authentication of a POP server that receives e-mails, before sending e-mails. <p>– POP3 Server IP Address or Host Name¹: If you set a server IP address, set 4 numbers (0—255) and 3 periods, such as "192.168.0.253". Note that "0.0.0.0" and "255.255.255.255" are not available. Or set a host name (1—255 characters).</p> <p>– Port No.: Enter a number (1—65535). Usually set to 110.</p> <p>– Login ID²: If your ISP requires a login ID to log in to a POP3 server, set it (1—63 characters).</p> <p>– Password²: If your ISP requires a password to log in to a POP3 server, set it (0—63 characters).</p> <ul style="list-style-type: none"> • SMTP authentication: Users are authenticated by user name and password on the SMTP server. Your ISP must support the SMTP authentication. Only the LOGIN and PLAIN authentication mechanisms are supported. <p>– Login ID²: If your ISP requires a login ID to log in to an SMTP server, set it (1—63 characters).</p> <p>– Password²: If your ISP requires a password to log in to an SMTP server, set it (0—63 characters).</p>

¹ Note that [Space], ["], ['], [&], [<] and [>] are not available.

² Note that [""] is not available.

8. Confirm the settings, and click [Save].
 - The new settings are saved.
 - When finished, "Success!" is displayed.
9. Click [Go to Trigger page].
 - The Trigger page is displayed.

Note

- If you are buffering images to the internal memory, the following operations also delete all buffered images.
 - Turning off the camera.
 - Saving the Date and Time page.
 - Restarting, updating firmware or resetting the camera to factory default.

4.3 Buffering or Transferring Images by Motion Detection Signal

The Trigger page allows you to enable image buffer/transfer by E-mail or FTP.

Note

- The level of motion detection depends on resolution, image quality, and the object being viewed. Check the level by performing motion detection recording. (See page 97)
- Enabling Motion Detection delays the frame rate of the camera.
- A change to light or wind conditions may detect motions accidentally.
- Motion Detection may not work in dark areas.
- Objects moving fast may not be detected.

1. Click [Trigger] on the Setup page.
2. Click a **No.** to enable buffer/transfer.

Trigger													
No.	Status	Trigger	Sun	Mon	Tue	Wed	Thu	Fri	Sat	Active Time of Trigger	Transfer Method	Notify	Deactivation
1	OFF	Timer	X	X	X	X	X	X	X	Always	No Transfer, No Memory Overwrite	-	-
2	OFF	Timer	X	X	X	X	X	X	X	Always	No Transfer, No Memory Overwrite	-	-
3	OFF	Timer	X	X	X	X	X	X	X	Always	No Transfer, No Memory Overwrite	-	-
4	OFF	Timer	X	X	X	X	X	X	X	Always	No Transfer, No Memory Overwrite	-	-
5	OFF	Timer	X	X	X	X	X	X	X	Always	No Transfer, No Memory Overwrite	-	-

3. Check [Enable Image Buffer/Transfer], select [Motion Detection] for the trigger, and click [Next>].

Trigger Setting

Enable Image Buffer/Transfer

Trigger: Motion Detection

Note

- Click [Delete Buffered Images] to delete images already buffered.
- Click [Save] to save the settings. The buffered images will be deleted.
- Clicking [Cancel] takes you back to the Trigger page without saving changes.

Setting	Description
Enable Image Buffer/Transfer	<ul style="list-style-type: none"> • Check the box to enable the Trigger setting. Uncheck the box to disable it.
Trigger	<ul style="list-style-type: none"> • Selecting [Timer] enables the camera to buffer/transfer images during the specified date and time by timer. • Selecting [Motion Detection] enables the camera to buffer/transfer images when the motion is detected during the specified date and time.

4. Set the time, and click [Next>].

Note

The timer works by an internal clock. Set the date and time before using timer buffer/transfer (see page 62).

- Clicking [<Back] takes you back to the previous page.
- Clicking [Cancel] takes you back to the Trigger page without saving changes.

Setting	Description
Day of the week	<ul style="list-style-type: none"> • Check the box to enable the day. Uncheck the box to disable it.
Active Time of Trigger	<ul style="list-style-type: none"> • To set a trigger time, check the time option and set a time period. Check [Always] if you are not specifying a time period.

5. Set the image settings, and click [Next>].

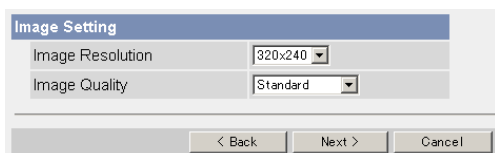

- Clicking [<Back] takes you back to the previous page.
- Clicking [Cancel] takes you back to the Trigger page without saving changes.

Setting	Description
Image Resolution	<ul style="list-style-type: none"> • Select an image resolution (640 × 480, 320 × 240 (default) or 160 × 120 pixels) for the buffer/transfer.
Image Quality	<ul style="list-style-type: none"> • Select the image quality. [Favor Clarity] optimizes for good quality (The motion may be slow down). [Standard] offers standard quality. (default) [Favor Motion] optimizes for enhanced motion (The image quality may decrease). [Mobile Phone] is for a transfer to a mobile phone. <p>Note 640 × 480 pixels cannot be set for a transfer to a mobile phone.</p>

6. Set the image buffer frequency and the Motion deactivation time, and click [Next>].

The screenshot shows a configuration menu with two main sections:

- Image Buffer Frequency:**
 - Enable Pre-trigger Image Buffer
 - Every 1 s , buffer 1 images. Total 1 images.
 - Enable Post-trigger Image Buffer
 - Every 1 s , buffer 1 images. Total 1 images.
- Motion deactivation time setting:**
 - Motion deactivation time: None

At the bottom, there are three buttons: < Back, Next >, and Cancel.

Note

Due to the network environment, object and the number of simultaneous accesses, the camera may not record the number of images that you set. In this case, set the image buffer frequency longer.

- Clicking [<Back] takes you back to the previous page.
- Clicking [Cancel] takes you back to the Trigger page without saving changes.

Setting	Description
Enable Pre-trigger Image Buffer	<ul style="list-style-type: none"> • Check the box to enable the setting. The camera buffers or transfers the image right before the motion detection signal is detected. • Set an interval, number of images to buffer and total number (see page 146). The number of buffered images may not match the total number due to memory capacity, image resolution, image quality or what object you view.
Enable Post-trigger Image Buffer	<ul style="list-style-type: none"> • Check the box to enable the setting. The camera buffers or transfers the image right after the motion detection signal is detected. • Set an interval, number of images to buffer and total number (see page 146). The number of buffered images may not match the total number due to memory capacity, image resolution, image quality or what object you view.

Setting	Description
Motion deactivation time	<ul style="list-style-type: none"> • Set the length of time during which the Motion Detection cannot be triggered after saving images temporarily or transmitting them. This function is recommended to prevent sending too many E-mails to a mobile phone. • After detecting motions, the camera does not detect motions during motion deactivation time, so some images may not be captured. <p>Note</p> <p>The internal memory cannot buffer images during motion deactivation time. Because of this, images taken before detection are not saved in internal memory, and so cannot be received. Depending on the settings for image buffer/transfer, even if it is set to, for example, take "1 image per second, and store 10 images, before detection", since the images are not stored in internal memory, if the Motion Detection detects something directly after the end of motion deactivation time, the images may not be saved. Ten seconds after the end of motion deactivation time, images can be received as specified in the settings (see page 96).</p>

7. Select the transfer method, and click [Next>].

The screenshot shows a dialog box titled "Transfer Method". It contains four radio button options:

- No Transfer, No Memory Overwrite
- No Transfer, Memory Overwrite
- FTP
- E-mail

 At the bottom of the dialog, there are three buttons: "< Back", "Next >", and "Cancel".

- Clicking [<Back] takes you back to the previous page.
- Clicking [Cancel] takes you back to the Trigger page without saving changes.

Note

If you transfer images by E-mail or FTP, confirm that the default gateway and DNS server addresses are assigned correctly (see page 45).

Setting	Description
No Transfer, No Memory Overwrite	<ul style="list-style-type: none"> • If the internal memory is full, the camera stops buffering.
No Transfer, Memory Overwrite	<ul style="list-style-type: none"> • If the internal memory is full, the camera deletes the old images, and continues to buffer the image.
FTP	<ul style="list-style-type: none"> • The camera transfers the image to an FTP server (see page 90).
E-mail	<ul style="list-style-type: none"> • The camera transfers the image by E-mail (see page 92).

When you set [FTP] for Transfer Method

Select [FTP], and click [Next>]. The following page is displayed.

FTP	
Server IP Address or Host Name	<input type="text"/>
Port No. (Usually Use 21)	<input type="text" value="21"/>
Login ID (0 to 63 Characters)	<input type="text"/>
Password (0 to 63 Characters)	<input type="text"/>
Login Timing	<input type="text" value="Every Time"/>
Upload File Name (1 to 234 Characters)	<input type="text"/>
Overwrite setting	<input type="text" value="Overwrite File"/>
Data Transfer Method	<input type="text" value="Passive Mode"/>

- Clicking [<Back] takes you back to the previous page.
- Clicking [Cancel] takes you back to the Trigger page without saving changes.

Setting	Description
Server IP Address or Host Name ¹	<ul style="list-style-type: none"> If you set a server IP address, set 4 numbers (0—255) and 3 periods, such as "192.168.0.253". Note that "0.0.0.0" and "255.255.255.255" are not available. Or set a host name (1—255 characters).
Port No.	<ul style="list-style-type: none"> Enter a number (1—65535). Usually set to 21.
Login ID ²	<ul style="list-style-type: none"> If your ISP requires a login ID, set it (0—63 characters).
Password ²	<ul style="list-style-type: none"> If your ISP requires a password, set it (0—63 characters).
Login Timing	<ul style="list-style-type: none"> Select the login setting for the FTP server. If you set [One Time] and the image buffer frequency value is set within 1 minute, the camera logs in to the server only once. This can reduce transfer time.
Upload File Name ¹	<ul style="list-style-type: none"> Set a file name on the FTP server to receive the transferred files. Enter 1—234 characters. Entering "\" creates directories for a file. (E.g. NetworkCamera\image)
Overwrite Setting	<ul style="list-style-type: none"> Selecting [Overwrite File] overwrites the image on the server with a newer image. Selecting [Save as New File with Time Stamp] saves the image attaching time stamps on the file name, and the images are not overwritten. (E.g. <u>image20050101093020500</u>.jpg) The underlined numbers mean "9h30min20s500ms on January 1, 2005". The letter "s" is inserted after the day when referring to a summer time zone.
Data Transfer Method	<ul style="list-style-type: none"> Select [Passive Mode] normally. If the transfer does not work, select [Active Mode] and check the operation.

¹ Note that [Space], ["], ['], [&], [<] and [>] are not available.

² Note that ["] is not available.

When you set [E-mail] for Transfer Method

Select [E-mail], and click [Next>]. The following page is displayed.

E-mail Transfer	
SMTP Server IP Address or Host Name	<input type="text"/>
Port No. (Usually Use 25)	<input type="text" value="25"/>
Reply E-mail Address	<input type="text"/>
Destination E-mail Address 1	<input type="text"/>
Destination E-mail Address 2	<input type="text"/>
Destination E-mail Address 3	<input type="text"/>
Subject (Up to 44 Characters)	<input type="text"/>
Text (Up to 63 Characters)	<input type="text"/>
How to authenticate	
<input checked="" type="radio"/> No authentication	
<input type="radio"/> POP before SMTP authentication	
POP3 Server IP Address or Host Name	<input type="text"/>
Port No. (Usually Use 110)	<input type="text" value="110"/>
Login ID (1 to 63 Characters)	<input type="text"/>
Password (0 to 63 Characters)	<input type="text"/>
<input type="radio"/> SMTP authentication	
Login ID (1 to 63 Characters)	<input type="text"/>
Password (0 to 63 Characters)	<input type="text"/>
<input style="margin-right: 10px;" type="button" value=" < Back "/> <input style="margin-right: 10px;" type="button" value=" Next > "/> <input style="margin-right: 10px;" type="button" value=" Cancel "/>	

- Clicking [<Back] takes you back to the previous page.
- Clicking [Cancel] takes you back to the Trigger page without saving changes.

Note

- The camera works only with an SMTP (Simple Mail Transfer Protocol) server. It does not work with mail servers like "Hotmail" that use a web browser.
- The date and time (24-h format) is automatically attached to the subject on the E-mail. The file name is "image.jpg".
E.g. When the "camera" is entered on the subject:
"camera:20050101093020500".
The underlined numbers mean "9 h 30 min 20 s 500 ms on January 1, 2005". The letter "s" is inserted after the day when referring to a summer time zone.

Setting	Description
SMTP Server IP Address or Host Name ¹	• If you set a server IP address, set 4 numbers (0—255) and 3 periods, such as "192.168.0.253". Note that "0.0.0.0" and "255.255.255.255" are not available. Or set a host name (1—255 characters).
Port No.	• Enter a number (1—65535). Usually set to 25.
Reply E-mail Address ²	• Set the sender's E-mail address. We recommend you to set the administrator's E-mail address.
Destination E-mail Address ² 1—3	• Set up to 3 destination E-mail addresses.
Subject ²	• Enter a subject with ASCII characters (see page 145) or characters from other languages (0—44 characters for a 1-byte character and 0—22 characters for a 2-byte character).
Text ²	• Enter text with ASCII characters (see page 145) or characters from other languages (0—63 characters for a 1-byte character and 0—31 characters for a 2-byte character). Note that [end-of-line] key is not available.

Setting	Description
How to authenticate	<p>You can select the authentication method: [No authentication], [POP before SMTP authentication] and [SMTP authentication]. POP server authentication may be required by your ISP. In that case, set POP before SMTP authentication.</p> <ul style="list-style-type: none"> • No authentication: No authentication when sending an e-mail. • POP before SMTP authentication: Some SMTP servers that send e-mails do not have an authentication feature. Therefore, the camera uses the authentication of a POP server that receives e-mails, before sending e-mails. <p>– POP3 Server IP Address or Host Name¹: If you set a server IP address, set 4 numbers (0—255) and 3 periods, such as "192.168.0.253". Note that "0.0.0.0" and "255.255.255.255" are not available. Or set a host name (0—255 characters).</p> <p>– Port No.: Enter a number (1—65535). Usually set to 110.</p> <p>– Login ID²: If your ISP requires a login ID to log in to a POP3 server, set it (1—63 characters).</p> <p>– Password²: If your ISP requires a password to log in to a POP3 server, set it (0—63 characters).</p> <ul style="list-style-type: none"> • SMTP authentication: Users are authenticated by user name and password on the SMTP server. Your ISP must support the SMTP authentication. Only the LOGIN and PLAIN authentication mechanisms are supported. <p>– Login ID²: If your ISP requires a login ID to log in to an SMTP server, set it (1—63 characters).</p> <p>– Password²: If your ISP requires a password to log in to an SMTP server, set it (0—63 characters).</p>

¹ Note that [Space], ["], ['], [&], [<] and [>] are not available.

² Note that [""] is not available.

8. After you confirm the settings and click [Next>], set E-mail notification and click [Next>].

E-mail notification when triggered

Disable

Enable

< Back Next > Cancel

- If you select [Enable], the E-mail Notification When Triggered page is displayed. Enter the settings referring to page 92 — page 94.

Setting	Description
Disable	<ul style="list-style-type: none"> • The camera does not send an E-mail notification when buffering or transferring images.
Enable	<ul style="list-style-type: none"> • The camera sends an E-mail notification up to 3 destinations when buffering or transferring images.

9. Click [Save] after confirming the settings.
- The new settings are saved.
 - When finished, "Success!" is displayed.

10. Click [Go to Trigger page].

- The Trigger page is displayed.

Note

- If you set a short interval when transferring to a mobile phone, many E-mails will be sent, which may lead to a large phone bill. Therefore, we recommend you to set a long interval. 1 image per minute frequency is recommended.
- Motion Detection transfer stops operating until after the camera finishes all transfers. For example, if the camera transfers 3 images per minute and 6 images in total by setting 1 minute for motion deactivation time, the sensor will follow the pattern below.

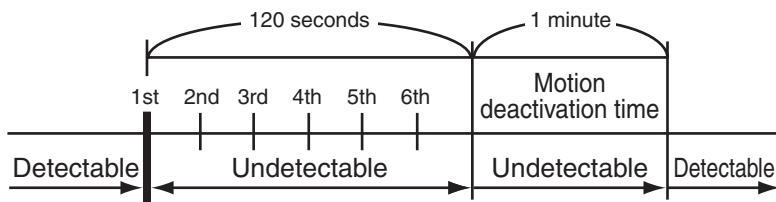

A Motion Detection signal is detected.

- If you are buffering images to the internal memory, the following operations also delete all buffered images.
 - Turning off the camera.
 - Saving the Date and Time page.
 - Restarting, updating firmware or resetting the camera to factory default.

4.4 Setting the Motion Detection

The Motion Detection page allows you to adjust the sensitivity of Motion Detection.

Threshold: If the threshold is set low, this function detects nearly all movements.

Sensitivity: If you set sensitivity high, the amplitude of the motion detection bar gets jumpy.

1. Click [Motion Detection] on the Setup page.
2. Click the Motion Detection bar in Threshold to set the threshold level.

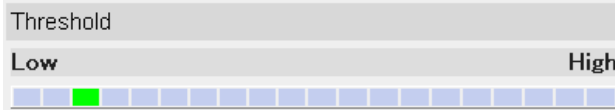

3. Click the Motion Detection bar in Sensitivity to set the sensitivity level.

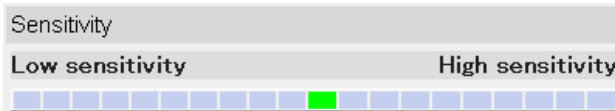

4. Click [Save] to save the settings.
 - Clicking [Cancel] cancels your settings without saving changes.
5. Click [Go to Motion Detection page].
 - The Motion Detection page is displayed.

Setting	Description
Threshold	<ul style="list-style-type: none"> • Adjusts the threshold for Motion Detection. As the value is set lower, the sensor will detect motions of smaller changes.
Sensitivity	<ul style="list-style-type: none"> • Adjusts the sensitivity for Motion Detection. As the value is set higher, the amplitude of the Motion Detection bar will become greater.

Preview

Display the current threshold and detection level.

- The threshold is the line between the green and red bar.
- The detection level is the line between the dark red and light red color.
- The Threshold and Sensitivity settings are enabled after saving, and reflected in preview.

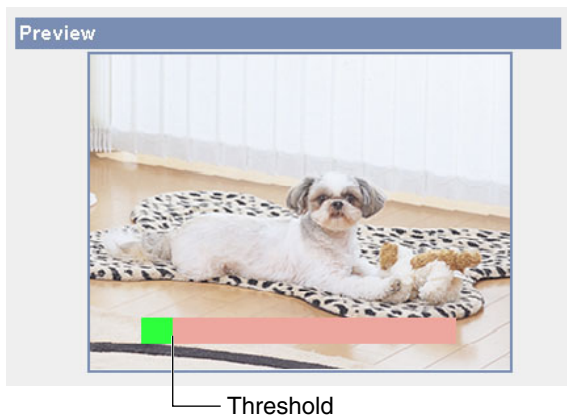

Note

No responsibility will be taken by our company with respect to consequences resulting from the use of the Motion Detection feature. The Motion Detection feature is not suitable and not recommended for uses that require a high reliability constantly such as surveillance, etc.

What is the threshold?

The threshold is the minimum value for the camera to detect motions on the image during the motion detection buffering. Setting the threshold lower allows subtler changes to be detected. Setting the threshold higher allows only bigger changes that might occupy half the image to be detected.

What is the sensitivity?

The sensitivity is the level of brightness detected as motion by the camera. A high sensitivity setting enables the camera to detect slight brightness changes. Lower the sensitivity to make the camera detect only big brightness changes.



Threshold setting is displayed.

The detection level exceeds the threshold when motions are detected.

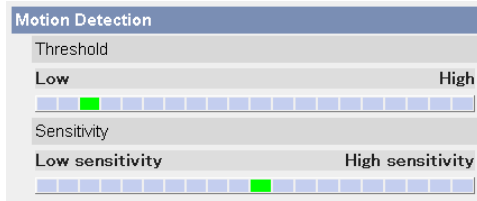

Note

Lowering the threshold and increasing sensitivity enable the camera to easily detect slight movements on parts of the image.

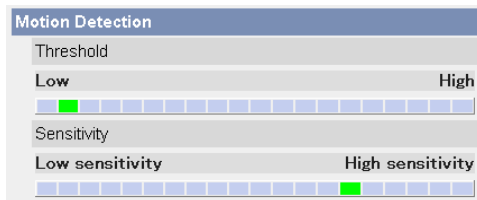
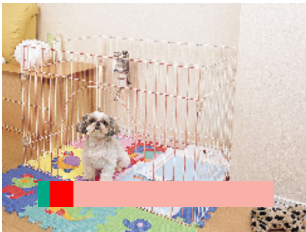

Note

- Motion Detection is activated by changes in the outline of objects and brightness changes. This feature is designed to alleviate false detections due to overall brightness changes caused by sunlight. But in some cases, the camera may falsely detect rapid brightness changes by artificial light such as fluorescent light. In other cases, the motion detection function on the Network Camera Recorder may detect objects and brightness changes. The way to detect motion differs between the camera and the Network Camera Recorder. Additionally, if the object's color is similar to the color of the background, motion can be hard to detect.
- The detection level depends on the object, resolution, or image quality. Confirm the condition on the Preview window following the procedure above.

4.5 Setting Sensor Log Notification

A sensor log sent once a day at a specified time can be checked. To enable Sensor Log, set Motion Detection for Trigger Setting and check [Enable].

- Click [Sensor Log] on the Setup page.
 - When enabling the image/buffer transfer setting and selecting Motion Detection in the Trigger page, the Sensor log window is displayed.
- Set each parameter.

A setup of operation							
<input checked="" type="radio"/> Disable <input type="radio"/> Enable(When there is no new-arrival sensor log Disable) <input type="radio"/> Enable(When there is no new-arrival sensor log Enable)							
Active Time							
Sun	Mon	Tue	Wed	Thu	Fri	Sat	Time
<input checked="" type="checkbox"/>	<input checked="" type="checkbox"/>	<input checked="" type="checkbox"/>	<input checked="" type="checkbox"/>	<input checked="" type="checkbox"/>	<input checked="" type="checkbox"/>	<input checked="" type="checkbox"/>	PM 12 h 0 min
Notice setup of a sensor log							
SMTP Server IP Address or Host Name		<input type="text"/>					
Port No. (Usually Use 25)		<input type="text" value="25"/>					
Reply E-mail Address		<input type="text"/>					
Destination E-mail Address 1		<input type="text"/>					
Destination E-mail Address 2		<input type="text"/>					
Destination E-mail Address 3		<input type="text"/>					
Subject (Up to 44 Characters)		<input type="text" value="Sensor Log"/>					
How to authenticate							
<input checked="" type="radio"/> No authentication <input type="radio"/> POP before SMTP authentication							
POP3 Server IP Address or Host Name		<input type="text"/>					
Port No. (Usually Use 110)		<input type="text" value="110"/>					
Login ID (1 to 63 Characters)		<input type="text"/>					
Password (0 to 63 Characters)		<input type="text"/>					
<input type="radio"/> SMTP authentication							
Login ID (1 to 63 Characters)		<input type="text"/>					
Password (0 to 63 Characters)		<input type="text"/>					
Save				Cancel			

- Click [Save].
 - Clicking [Cancel] cancels your settings without saving changes.

4. Click [Go to Sensor Log page].
- The Sensor log is displayed.

Note

New sensor logs are deleted to click [Save].

Setting	Description
A setup of operation	<ul style="list-style-type: none"> • Sensor log operation can be set here.
Time	<ul style="list-style-type: none"> • Set the day of the week and time to send sensor logs via E-mail.
SMTP Server IP Address or Host Name ¹	<ul style="list-style-type: none"> • If you set a server IP address, set 4 numbers (0—255) and 3 periods, such as "192.168.0.253". Note that "0.0.0.0" and "255.255.255.255" are not available. Or set a host name (1—255 characters).
Port No.	<ul style="list-style-type: none"> • Enter a number (1—65535). Usually set to 25.
Reply E-mail Address ²	<ul style="list-style-type: none"> • Set the sender's E-mail address. We recommend you to set the administrator's E-mail address.
Destination E-mail Address 1-3 ²	<ul style="list-style-type: none"> • Set up to 3 destination E-mail addresses.
Subject ²	<ul style="list-style-type: none"> • Enter a subject with ASCII characters (see page 145) or characters from other languages (0—44 characters for a 1-byte character and 0—22 characters for a 2-byte character).

Setting	Description
How to authenticate	<p>You can select the authentication method: [No authentication], [POP before SMTP authentication] and [SMTP authentication]. POP server authentication may be required by your ISP. In that case, set POP before SMTP authentication.</p> <ul style="list-style-type: none"> • No authentication: No authentication when sending an e-mail. • POP before SMTP authentication: Some SMTP servers that send e-mails do not have an authentication feature. Therefore, the camera uses the authentication of a POP server that receives e-mails, before sending e-mails. <p>– POP3 Server IP Address or Host Name¹: If you set a server IP address, set 4 numbers (0—255) and 3 periods, such as "192.168.0.253". Note that "0.0.0.0" and "255.255.255.255" are not available. Or set a host name (0—255 characters).</p> <p>– Port No.: Enter a number (1—65535). Usually set to 110.</p> <p>– Login ID²: If your ISP requires a login ID to log in to a POP3 server, set it (1—63 characters).</p> <p>– Password²: If your ISP requires a password to log in to a POP3 server, set it (0—63 characters).</p> <ul style="list-style-type: none"> • SMTP authentication: Users are authenticated by user name and password on the SMTP server. Your ISP must support the SMTP authentication. Only the LOGIN and PLAIN authentication mechanisms are supported. <p>– Login ID²: If your ISP requires a login ID to log in to an SMTP server, set it (1—63 characters).</p> <p>– Password²: If your ISP requires a password to log in to an SMTP server, set it (0—63 characters).</p>

¹ Note that [Space], ["], ['], [&], [<] and [>] are not available.

² Note that [""] is not available.

5 Using Other Features

5.1 Changing Initial Settings on the Single Camera page or the Multi-Camera page

The Image Display page allows you to change the initial settings (display settings when a user accesses the camera) for the Single Camera, Multi-Camera, Limit Continuous Motion JPEG, Language and Banner Display.

1. Click [Image Display] on the Setup page.
2. Set each parameter.

Single Camera	
Image Resolution	320x240
Image Quality	Standard
Refresh Interval	Motion
Multi-Camera	
Image Resolution	320x240
Image Quality	Standard
Refresh Interval	Motion
Limit Continuous Motion JPEG	
Limit time of Continuous Motion JPEG	Unlimited
Refresh Interval	30 s
Language	
Language	English
Banner Display	
<input type="checkbox"/> Enable	
Banner user	All users
Image URL (1 to 127 Characters)	<input type="text"/>
Link URL (0 to 127 Characters)	<input type="text"/>
<input type="button" value="Save"/> <input type="button" value="Cancel"/>	

- Clicking [Cancel] cancels your settings without saving changes.

Setting	Description
Image Resolution	<ul style="list-style-type: none"> Select the image resolution. 640 × 480 pixels (only for the Single Camera page) 320 × 240 pixels (default) 160 × 120 pixels (only for the Multi-Camera page)
Image Quality	<ul style="list-style-type: none"> Select the image quality. [Favor Clarity] optimizes for good quality (The motion may be slow down). [Standard] offers standard quality. (default) [Favor Motion] optimizes for enhanced motion (The image quality may decrease).
Refresh Interval	<ul style="list-style-type: none"> Select a refresh interval. (Motion, 3 s, 5 s, 10 s, 30 s, and 60 s)
Limit Continuous Motion JPEG <ul style="list-style-type: none"> Limit time of Continuous Motion JPEG Refresh Interval 	<ul style="list-style-type: none"> Set the time to change the video (Motion JPEG) to still images. (10 seconds—Unlimited) Set a refresh interval after the image is changed to still images. (3-second interval—60-second interval)
Language	<ul style="list-style-type: none"> Select the initial language from English, Japanese, French, German, Italian, Spanish, Simplified Chinese, Russian or Korean. The selected language is displayed as the initial language on the Top, Single Camera, Multi-Camera and Buffered Image pages. If you select English, Japanese, French or Simplified Chinese, all pages can be changed. But if you select another language, the Setup, Maintenance and Support pages are displayed in English.

Setting	Description
<p>Banner Display</p> <ul style="list-style-type: none"> • Banner user • Image URL^{*1} • Link URL^{*1} 	<p>When checked to [Enable], the setting will be enabled. When unchecked, the setting will be disabled.</p> <p>Note</p> <ul style="list-style-type: none"> • When the Banner Display is enabled, the camera accesses the Image URL every time the Single Camera page is displayed. The intermittent and continuous switching of the Single page burdens the PC that stores the image linked with the URL. • If the image URL linked with an image stored in a PC that requires an authentication is set, the authentication window will be displayed when displaying the Single page. <ul style="list-style-type: none"> • All users : The banner can be displayed for all users. • Administrator only : The banner can be displayed for the administrator only. • General user only : The banner can be displayed for the general users only. <ul style="list-style-type: none"> • Enter the image URL you want to display as a banner. When [Enable] is checked, enter the image URL. (1—127 characters) • Enter the target URL you want to display when clicking the banner. (0—127 characters)

*1 Note that [Space], ["], ['], [&], [<], and [>] are not available.

3. Click [Save] when finished.
 - The new settings are saved.
 - When finished, "Success!" is displayed.
4. Click [Go to Image Display page].
 - The Image Display page is displayed.

5.2 Configuring Multiple Cameras

The Multi-Camera Setup page allows you to configure camera IP addresses and camera names to view multiple images on the Multi-Camera page. These configurations are required to use the Multi-Camera page. Up to 12 cameras can be configured. The Selfcamera is registered at No. 1 by default.

1. Click [Multi-Camera] on the Setup page.
2. Click **Add**.

No.	Display	IP Address or Host Name	Port No.	Camera Name
1	On	selfcamera	--	*****
Add				

Note

- If you click the camera number, the modification page is displayed. Camera settings can be modified or deleted here.
- If you configured multiple cameras, you can change the camera number. Select the number, and click [Move].

Change Camera Order

From No. To No.

3. Set each parameter.

Add Camera

Display	<input checked="" type="checkbox"/> On
IP Address or Host Name	<input style="width: 90%;" type="text"/>
Port No. (1 to 65535)	<input style="width: 40%;" type="text"/>
Camera Name (1 to 15 characters)	<input style="width: 80%;" type="text"/>

Clicking this link, enters this camera's settings.

- Clicking [Cancel] cancels your settings without saving changes.
- By clicking [Clicking this link, enters this camera's settings.], the settings of the Selfcamera are entered automatically. "selfcamera" is displayed for the IP Address or Host Name, "--" is displayed for the Port No., and the model no. is displayed for the Camera Name.

Setting	Description
Display	<ul style="list-style-type: none"> Check this box to enable the camera.
IP Address ¹ or Host Name ²	<ul style="list-style-type: none"> Set an IP address or host name to enable the camera.
Port No.	<ul style="list-style-type: none"> Set a port number (1—65535).
Camera Name ³	<ul style="list-style-type: none"> This camera name is displayed only on the Multi-Camera page.

¹ Set 4 numbers (0—255) and 3 periods, such as "192.168.0.253". Note that "0.0.0.0" and "255.255.255.255" are not available.

² Enter ASCII characters for the host name (see page 145). Note that [Space], ["], ['], [#], [&], [%], [=], [+], [?], [<] and [>] are not available. Enter 1—255 characters.

³ You can enter ASCII characters (see page 145) or characters from other languages (1—15 characters for a 1-byte character and 1—7 characters for a 2-byte character). Note that [Space], ["], ['], [#], [&], [%], [=], [+], [?], [:], [<], and [>] are not available.

Note

- If your camera will only be accessed on your local network, use each camera's local IP address and port number.
- If you intend to access your camera from the Internet, you must use each camera's host name (global IP address) and the port number.

4. Click [Save] when finished.

- The new settings are saved.
- The Multi-Camera Setup page is displayed.

5.3 Specifying Operation Time

The Operation Time page allows you to limit the time that the camera is in use. The camera image turns to a gray screen outside operation time.

Note

- Your privacy may be compromised if the time period is set incorrectly. Confirm the time period after the setup.
- If you access the camera as an administrator, you can view the image outside the time period.

- Click [Operation Time] on the Setup page.
- Click a **No.** to set the operation time.

Operation Time									
No.	Status	Sun	Mon	Tue	Wed	Thu	Fri	Sat	Operation Time
1	Disable	X	X	X	X	X	X	X	Always
2	Disable	X	X	X	X	X	X	X	Always
3	Disable	X	X	X	X	X	X	X	Always
4	Disable	X	X	X	X	X	X	X	Always
5	Disable	X	X	X	X	X	X	X	Always
6	Disable	X	X	X	X	X	X	X	Always
7	Disable	X	X	X	X	X	X	X	Always

Note

If No. 1—7 are disabled, the camera can always be operated.

- Check [Enable], set the time, and click [Save].

Operation Time									
Enable	Sun	Mon	Tue	Wed	Thu	Fri	Sat	Operation Time	
<input type="checkbox"/>	<input checked="" type="checkbox"/>	<input checked="" type="checkbox"/>	<input checked="" type="checkbox"/>	<input checked="" type="checkbox"/>	<input checked="" type="checkbox"/>	<input checked="" type="checkbox"/>	<input checked="" type="checkbox"/>	<input checked="" type="radio"/> Always	<input type="text" value="AM"/> <input type="text" value="12"/> <input type="text" value="h"/> <input type="text" value="0"/> <input type="text" value="min"/> to <input type="text" value="AM"/> <input type="text" value="12"/> <input type="text" value="h"/> <input type="text" value="0"/> <input type="text" value="min"/>
<input type="button" value="Save"/> <input type="button" value="Cancel"/>									

- Clicking [Cancel] takes you back to the previous page without saving changes.

Setting	Description
Enable	<ul style="list-style-type: none"> Check the box to enable the setting. Uncheck the box to disable it.
Day of the week	<ul style="list-style-type: none"> Check the box to enable the day. Uncheck the box to disable it.
Operation Time	<ul style="list-style-type: none"> To set an operation time, check the time option and set a time period. Check the [Always] option if you are not specifying a time period.

4. Click [Save] when finished.
- The new settings are saved.
 - The Operation Time page is displayed.

About Operation Time

In the operation time settings, the enabled settings take priority over the disabled settings. Therefore, if Monday or Tuesday is disabled in a setting but enabled in other settings, the camera can be operated on both Monday and Tuesday.

No.	Status	Sun	Mon	Tue	Wed	Thu	Fri	Sat	Operation Time
1	Enable	X	X		X	X	X	X	Always
2	Enable	X		X	X	X	X	X	Always

5.4 Changing the Indicator Display

The Indicator Control page allows you to select an operation for the indicator. There are three options.

- Turn indicator on when camera is on.
 - Turn indicator on during camera access.
 - Never turn indicator on.
1. Click [Indicator Control] on the Setup page.
 2. Select an option.

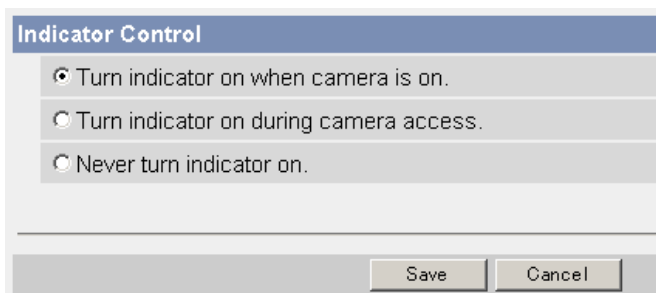

Setting	Description
Turn indicator on when camera is on.	<ul style="list-style-type: none"> • The indicator always turns on or blinks (see page 19).
Turn indicator on during camera access.	<ul style="list-style-type: none"> • The indicator turns green when the camera is being accessed.
Never turn indicator on.	<ul style="list-style-type: none"> • The indicator always turns off.

- Clicking [Cancel] cancels your settings without saving changes.

Note

- See page 19 for the Indicator Display table.
 - Selecting [Never turn indicator on] keeps indicator always off.
3. Click [Save] when finished.
 - The new settings are saved.
 - When finished, "Success!" is displayed.
 4. Click [Go to Indicator Control page].
 - The Indicator Control page is displayed.

6 Camera Maintenance

6.1 Maintenance page

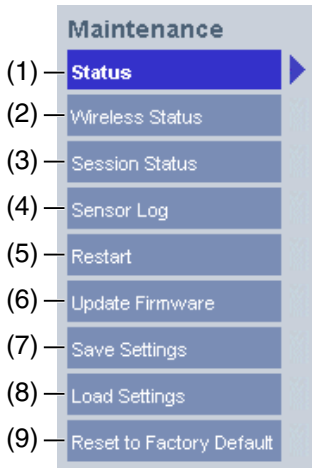

Maintenance

- | | | |
|-----|---------------------------------|--|
| (1) | Status | Displays the camera settings and status (see page 112). |
| (2) | Wireless Status | Displays wireless information (see page 112). |
| (3) | Session Status | Displays information on access to the camera (see page 112). |
| (4) | Sensor Log | Displays sensor logs (see page 113). |
| (5) | Restart | Restarts the camera (see page 113). |
| (6) | Update Firmware | Updates the camera firmware (see page 114). |
| (7) | Save Settings | Creates a configuration file (see page 117). |
| (8) | Load Settings | Loads settings from a configuration file (see page 118). |
| (9) | Reset to Factory Default | Resets the camera to its default settings (see page 119). |
-

6.1.1 Confirming the Status

The Status page allows you to check the status of the camera. The status information provides support for troubleshooting.

Clicking [Status] displays the following page.

Version	
Displays Hardware/Firmware Version.	
Model	*****
Firmware(Boot)	* **
Firmware(Application)	* **

Note

See the Panasonic Network Camera support website at <http://panasonic.co.jp/pcc/products/en/netwkcaml/> for details about status information.

6.1.2 Confirming the Wireless Status

The Wireless Status page allows you to check the status of the wireless connection. The wireless status information provides support for troubleshooting regarding wireless connection.

Clicking [Wireless Status] displays the following page.

Wireless information	
Status of Wireless module	No Link to Wireless Router.
Firmware version (Wireless)	*****

6.1.3 Confirming Session Status

Displays the information of clients connected to the camera.

Clicking [Session Status] displays the following page.

Number of Sessions			
Show number of motion sessions.			
Div	Max Sessions	Now Sessions	
Motion	20	0	
List of Sessions			
Display max: 20 tables connecting now.			
Connect time	Access to	Addr:Port	User

6.1.4 Confirming Sensor Logs

Displays up to 50 Sensor Logs in chronological order. Old logs will be overwritten by new ones.

1. Click [Sensor Log] on the Maintenance page.
2. Sensor Logs are displayed.

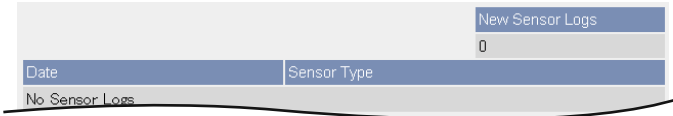

Note

If the camera is restarted, all sensor logs are deleted.

Item	Description
New Sensor Logs	<ul style="list-style-type: none"> • Displays the number of new sensor logs.
Date	<ul style="list-style-type: none"> • Displays the date and time when the Motion Detection is activated.
Sensor Type	<ul style="list-style-type: none"> • Displays the Trigger Setting (Motion Detection) on the Trigger page.

6.1.5 Restarting the Camera

It is possible to restart the camera by disconnecting the AC adaptor from the power outlet and reconnecting it again. The camera can also be restarted on the Restart page.

Note

When the camera is restarted, the buffered images and sensor logs will be deleted.

1. Click [Restart] on the Maintenance page.
2. Click [Restart].



- Restarting takes about 90 seconds. The Top page is displayed when finished.

6.1.6 Updating the Camera Firmware

The Update Firmware page allows you to update the camera's firmware. If new firmware is available, install it into the camera.

Note

- Do not turn off the power during a firmware update.
 - All buffered images and sensor logs on the internal memory will be deleted after the firmware update.
 - The firmware version is displayed on the Top page and the Status page.
1. Download the new firmware from the Panasonic Network Camera support website at <http://panasonic.co.jp/pcc/products/en/netwkcaml/>, and save it on your PC.
 2. Click [Update Firmware] on the Maintenance page.
 3. Click [Update Firmware].
 - The procedure can take up to 8 minutes.



- The camera restarts. Restart operation takes up to 90 seconds.

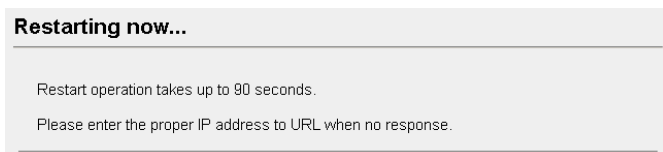

- The Update page is displayed after about 90 seconds. The firmware update process takes about 7 minutes.

Please enter or browse the firmware file name for update.

File Name

The firmware update process takes about 7 minutes via "File Upload", "Flash-ROM Writing", and "Restart", automatically. To cancel the firmware update, please push "Cancel".

Caution: Never turn off the power, during the firmware update process.

4. Click [Browse...].
 - A dialog box is displayed to select the firmware.
5. Select the firmware (including directory information) and click [Open].
 - The firmware file name is displayed.
6. Confirm the firmware file name, and click [Update Firmware].
 - Clicking [Cancel] takes you back to the Top page without updating the firmware.
 - The following message is displayed during the update. Wait about 5 minutes.

Updating firmware.

Please wait about 5 minutes.

Caution: Never turn off the power, during the firmware update process.

- The camera restarts automatically after the update.

Restarting now...

Restart operation takes up to 90 seconds.

Please enter the proper IP address to URL when no response.

- The Top page is displayed after about 90 seconds.

7. Confirm that the version number on the Top page is updated.



- If the version number is updated, the firmware update is complete.

6.1.7 Creating a Configuration File

A configuration file can be saved on your PC. You can load camera settings from the configuration file on the Load Settings page (see page 118).

Note

The saved image has contains private information. It is important to prevent leaks of private information.

1. Click [Save Settings] on the Maintenance page.
2. Click [Save].



3. Click [Save] on the File Download dialog box.
4. Specify the location, and click [Save] on the Save As dialog box.

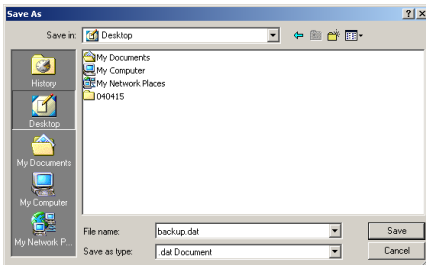

- The configuration file is saved at that location.

Note

- The file extension (.dat) cannot be changed. If you change it, the settings cannot be loaded.
- If you try to update the camera, create a configuration file after updating the firmware. If there is a firmware version difference between the camera that you create a configuration file from and the camera that you try to load settings to, the settings may not have been loaded to the camera.

6.1.8 Loading Settings from a Configuration File

Camera settings can be loaded from a configuration file. If you reset the camera to factory default, the camera can load previously used settings from a configuration file.

Note

- The configuration file also saves network settings. When settings are loaded, the network settings are also loaded.
- If you try to update the camera, create a configuration file after updating the firmware. If there is a firmware version difference between the camera that you create a configuration file from and the camera that you try to load settings to, the settings may not have been loaded to the camera.

1. Click [Load Settings] on the Maintenance page.
2. Click [Browse...].

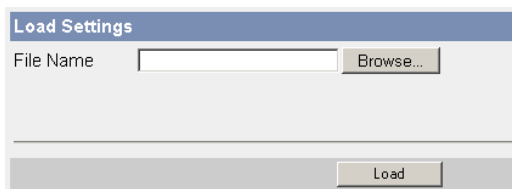

3. Select the configuration file on the Choose file dialog box, and click [Open].

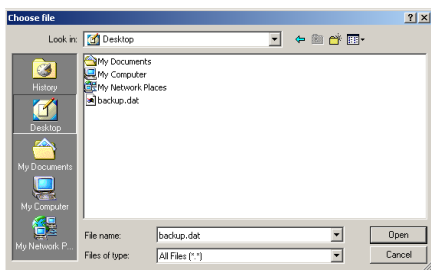

- The file name is displayed in the data field.
4. Confirm the file name, and click [Load].
 5. Click [Restart].
 - The camera restarts, and the Top page is displayed.

6.1.9 Resetting the Camera to Factory Default

All camera settings are reset to factory default when the Execute button is clicked. To restore the wireless connection, access the camera by using a wired connection and set up the wireless configuration (see Getting Started).

1. Click [Reset to Factory Default] on the Maintenance page.
2. Click [Execute].

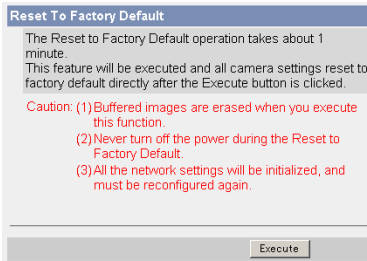

- The indicator blinks orange, and then turns off for 5 seconds.
- All camera settings (user name, password, IP address, subnet mask, etc.) are reset to factory default.
- If the camera is reset to factory default, the network connection mode changes to [Automatic Setup]. Reconfigure the camera referring to Getting Started.

Note

- Do not turn off the camera during the reset operation.
- The internal clock will not be reset, but the time format will return to AM/PM mode (see page 62).
- See page 123—page 131 for the default settings.
- Pressing the FACTORY DEFAULT RESET button resets the camera to factory default (see page 122).
- All buffered images on the internal memory are deleted when resetting the camera to factory default.
- The reset operation takes about 1 minute.
- If the camera is restarted, all sensor logs are deleted.

6.2 Support page

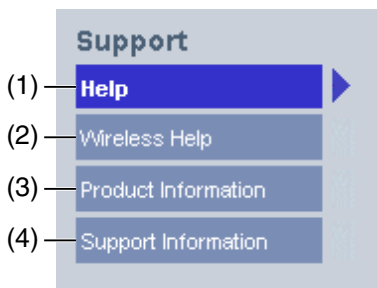

Support

- | | |
|--------------------------------|--|
| (1) Help | Displays the Help page (see page 120). |
| (2) Wireless Help | Displays the Wireless Help page (see page 121). |
| (3) Product Information | Displays the product information website (see page 121). |
| (4) Support Information | Displays the support information website (see page 121). |
-

6.2.1 The Help page

The Help page displays explanations for each of the following features. Clicking [Help] on the Support page displays the following page.

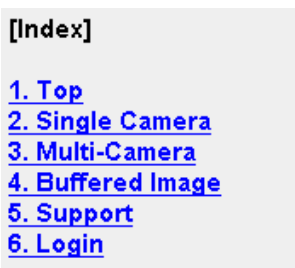

6.2.2 The Wireless Help page

The Wireless Help page explains Wireless Basic configuration, Wireless Cipher configuration and Wireless Status.

Clicking [Wireless Help] on the Support page displays the following page.

[Index]

- [1. Wireless Basic configuration](#)
- [2. Wireless Cipher configuration](#)
- [3. Wireless Status](#)

Note

[Wireless Help] is displayed only when logging in as an administrator.

6.2.3 Product Information

See the Panasonic Network Camera support website for product information.

Clicking [Product Information] on the Support page displays the URL, click it.

Note

If the camera is not connected to the Internet, the website cannot be displayed.

6.2.4 Support Information

See the Panasonic Network Camera support website for support information.

Clicking [Support Information] on the Support page displays the URL, click it.

Note

If the camera is not connected to the Internet, the website cannot be displayed.

6.3 FACTORY DEFAULT RESET Button

There is a FACTORY DEFAULT RESET button on the side of the camera.

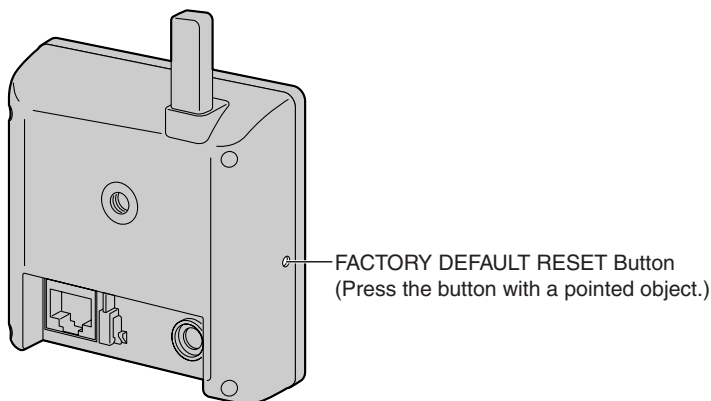

Pressing the FACTORY DEFAULT RESET button resets the camera to factory default. If you lose your user name and password, use this button to reset the camera. To restore the wireless connection, access the camera by using a wired connection and set up the wireless configuration (see Getting Started).

- To reset the camera, press the FACTORY DEFAULT RESET button for 1 second when the camera is on.
- The indicator blinks orange, and then turns off for 5 seconds.
- Do not turn off the camera during the reset operation. The reset operation takes about 1 minute.

Note

- The internal clock will not be reset, but the time format will return to AM/PM mode (see page 62).
- See page 123—page 131 for the default settings.
- All buffered images on the internal memory are deleted when resetting the camera to factory default.
- If the camera is restarted, all sensor logs are deleted.

7 Other Information

7.1 Default Setting List

Basic

	Items	Default	Required	Note
Network	Connection Mode	Automatic Setup	-	Automatic Setup/Static/DHCP
	Allow Access from the Internet (Automatic Setup only)	No	-	-
	Network Configuration from Setup Program (Static/DHCP only)	Enable	-	-
	Port No. (Static/DHCP only)	80	-	20, 21, 25 and 110 is not available.*2
	IP address (Static only)	192.168.0.253	When setting Static	*1
	Subnet Mask (Static only)	255.255.255.0	When setting Static	*1
	Host Name (DHCP only)	[Blank]	When setting DHCP (Not always required)	0—63 characters *4
	Default Gateway (Static/DHCP only)	[Blank]	When using Gateway	*1
	DNS Server 1 DNS Server 2 (Static/DHCP only)	[Blank]	When using DNS	*1
	Max. Bandwidth Usage (Mbps)	Unlimited	-	0.1, 0.2, 0.3, 0.5, 1 or Unlimited
Connection Type	Auto Negotiation	-	Auto Negotiation, 100 Mbps/Full Duplex, 100 Mbps/Half Duplex, 10 Mbps/Full Duplex, 10 Mbps/Half Duplex	

	Items	Default	Required	Note
Wireless	Communication mode	802.11b/g	-	-
	(Channel)	Auto	-	-
	SSID	NetCam****	-	Up to 32 characters, signs or numbers
	(Speed)	Auto	-	-
	Encryption (WEP)	No encryption	-	-
	Authentication	Open System	-	-
	WEPKey 1—4	ASCII 13 Characters 128 bit [Blank]	-	-
UPnP	Auto Port Forwarding	Disable	-	-
	Display Shortcut Icon in My Network Places	Enable	-	-
Dynamic DNS	DynamicDNS	Disable	-	Viewnetcam.com/ User-specified DynamicDNS/ Disable
	DynamicDNS Server URL	[Blank]	When using User-specified DynamicDNS	1—255 characters*8
	Updating time	10 min		At the time of starting/10, 30 (min), 1, 3, 6, 12, 24 (h)
	User Name	[Blank]		0—63 characters*9
	Password	[Blank]		0—63 characters*9

	Items	Default	Required	Note
Date and Time	Time Setting	AM/PM	-	AM/PM/24 H
	Automatic Time Adjustment	No check	When using NTP	-
	NTP Server Address or Host Name	[Blank]	When using NTP	1—255 characters*4
	Time Zone	GMT -00:00	When using NTP	-
	Adjust Clock for Daylight Saving Time	No check	-	-
	Start Day	Mar, Last Sunday, 1 AM	-	-
	End Day	Oct, Last Sunday, 1 AM	-	-
Camera	Camera Name	Network Camera	Required	1—15 characters *6
	White Balance	Auto	-	Auto/Fixed Indoor/ Fixed Fluorescent (White)/Fixed Fluorescent (Daylight)/Fixed Outdoor
	AC Power Source Frequency	50Hz	-	50Hz/60Hz
	Color Night View	Enable	-	Enable/Disable

Account

Items		Default	Required	Note
Security: Administrator	General Authentication	Do not permit access from guest users	-	-
	User Name	[Blank]	When setting administrator	6—15 characters *3
	Password	[Blank]	When setting administrator	6—15 characters *3
	Retype Password	[Blank]	When setting administrator	6—15 characters *3
General User	User ID List	[Blank]	-	-
	User Name	[Blank]	When setting general user	6—15 characters *3
	Password	[Blank]	When setting general user	6—15 characters *3
	Retype Password	[Blank]	When setting general user	6—15 characters *3
	Access Level	Level 2	-	Level 1, Level 2

Buffer/Transfer

	Items	Default	Required	Note
Trigger	Status	Off	-	-
	Trigger	Timer	-	Timer/Motion Detection
	Active Time of Trigger	Always	-	-
	Image Setting (Image Resolution)	320 × 240	-	160 × 120, 320 × 240, 640 × 480
	Image Quality	Standard	-	Favor Clarity, Standard, Favor Motion, Mobile phone
	Image Buffer Frequency	Every 1 s, buffer 1 image.	-	1 image per hour—15 images per second
	Motion deactivation time	None	When selecting Motion Detection	None, 10, 30 (s), 1, 3, 5, 10 (min)
	Transfer Method	No Transfer, No Memory Overwrite	-	-
	Notify	Disable	When selecting Motion Detection	-
Motion Detection	Threshold	Third blocks from the left	-	-
	Sensitivity	Center	-	-

Items		Default	Required	Note
Sensor Log	A setup of operation	Disable	When selecting Motion Detection in Trigger.	Disable/ Enable(When there is no new-arrival sensor log: Disable)/ Enable(When there is no new-arrival sensor log: Enable)
	Active Time	Checked		-
	Time	PM 12 h 0 min		AM/PM, 1–12 (h), 0/10/20/30/40/50 (min)
	Notice setup of a sensor log	[Blank]		-
	Port No. (SMTP)	25		*2
	Port No. (POP)	110		*2
	Subject	Sensor Log		-
	How to authenticate	No authentication		No authentication/ POP before SMTP authentication/ SMTP authentication

Advanced

	Items	Default	Required	Note
Image Display	Single Camera Image Resolution	320 × 240	-	320 × 240 or 640 × 480
	Single Camera Image Quality	Standard	-	Favor Clarity, Standard or Favor Motion
	Single Camera Refresh Interval	Motion	-	3, 5, 10, 30, 60 (s) or Motion
	Multi-Camera Image Resolution	320 × 240	-	160 × 120 or 320 × 240
	Multi-Camera Image Quality	Standard	-	Favor Clarity, Standard or Favor Motion
	Multi-Camera Refresh Interval	Motion	When reducing traffic	3, 5, 10, 30, 60 (s) or Motion
	Limit time of Continuous Motion JPEG	Unlimited	-	Unlimited/10, 30 (s), 1, 5, 10, 30, 60 (min)
	Refresh Interval	30 s	-	3, 5, 10, 30, 60 (s)
	Language	English	-	English/Japanese/ French/German/ Italian/Spanish/ Simplified Chinese/Russian/ Korean
	Banner Display	No check	When displaying the banner	-
	Banner user	All users	-	All users/ Administrator only/General user only
	Image URL	[Blank]	-	1—127 Characters*4
Link URL	[Blank]	-	0—127 Characters*4	

	Items	Default	Required	Note
Multi-Camera	Multi-Camera	No.1 Selfcamera	-	-
	Display	Checked	When setting Multi-Camera	-
	IP Address or Host Name	selfcamera	When setting Multi-Camera	IP address*1 Host name*5 is 1—255 characters.
	Port No.	--	When setting Multi-Camera	20, 21, 25 and 110 are not available.*2
	Camera Name	BL-C20	When setting Multi-Camera	1—15 characters *7
	Change Camera Order	From No.1 To No.1	-	No.1—No.12
Operation Time	Operation Time	Always	-	-
Indicator Control	Indicator Control	Turn indicator on when camera is on	-	Turn indicator on when camera is on./Turn indicator on during camera access./Never turn indicator on.

- *1 Set 4 numbers (0—255) and 3 periods, such as "192.168.0.253". Note that "0.0.0.0" and "255.255.255.255" are not available.
- *2 Set the number of 1—65535.
- *3 Enter ASCII characters (see page 145). Note that [Space], ["], ['], [&], [<], [>] and [:] are not available.
- *4 Enter ASCII characters for the host name (see page 145). Note that [Space], ["], ['], [&], [<], and [>] are not available.
- *5 You can enter a ASCII characters (see page 145). Note that [Space], ["], ['], [#], [&], [%], [=], [+], [?], [<], and [>] are not available.
- *6 You can enter a ASCII characters (see page 145) or characters from other languages (1—15 characters for a 1-byte character and 1—7 characters for a 2-byte character). Note that [Space], ["], ['], [&], [<], and [>] are not available.
- *7 You can enter a ASCII characters (see page 145) or characters from other languages (1—15 characters for a 1-byte character and 1—7 characters for a 2-byte character). Note that [Space], ["], ['], [#], [&], [%], [=], [+], [?], [<], and [>] are not available.
- *8 [Space] and ["] are not available.
- *9 ["] and [:] are not available.

7.2 Cleaning

Only clean the camera after it has been turned off by disconnecting the AC adaptor.

7.2.1 Cleaning the Main Unit

After taking away the dust on the main unit, wipe it with a soft, dry cloth.

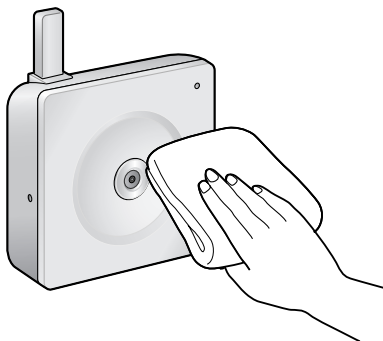

Note

- Do not use alcohol, polishing powder, cleanser, benzine, thinner, wax, petroleum products or hot water to wipe the camera. Also avoid glass cleaner, pesticide or hair spray. They may cause change in the shape or color of the camera.
- Do not directly touch the lens. Fingerprints may cause an unclear image.

7.2.2 Cleaning the Lens

A dusty lens may cause unclear images. Remove the dust with a cotton bud.

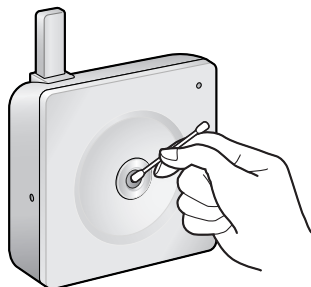

Note

Do not touch the lens directly. Fingerprints may cause an unclear image.

7.3 Setting an IP Address on Your PC

Your PC's IP address can be assigned by following the procedures below.

1. Display the TCP/IP Properties window.
 - The steps are different depending on your OS.

OS	Steps
Windows XP	[Start] (→[Settings])→[Control Panel]→[Network and Internet Connections]→[Network Connections]→[Local Area Connection] in use→[Properties]→Select Internet Protocol [TCP/IP]→[Properties]→[Use the following IP address]
Windows 2000	[Start]→[Settings]→[Control Panel]→[Network and Dial-up Connections]→[Local Area Connection] in use →[Properties]→Select Internet Protocol [TCP/IP] →[Properties]→[Use the following IP address]
Windows Me, Windows 98SE	[Start]→[Settings]→[Control Panel]→[Network]→Select [TCP/IP] with adaptor in use→[Properties]→[IP Address] →[Specify an IP address]

- When using Windows XP and Windows 2000, log in as an administrator to access the TCP/IP Properties window.
2. Enter the IP address and subnet mask.
 3. Click [OK].
 - In Windows Me or Windows 98SE, the PC needs to be restarted to enable the settings.

Local IP Address

A local IP address is a network ID that is not used on the Internet. Local IP Addresses are classified into Class A, Class B and Class C, as shown below. Set an IP address within the range specified in the class corresponding to your local network.

Class	Subnet Mask	Local IP Address
Class A	255. 0. 0. 0	10. 0. 0. 1 — 10. 255. 255. 254
Class B	255. 255. 0. 0	172. 16. 0. 1 — 172. 31. 255. 254
Class C	255. 255. 255. 0	192. 168. 0. 1 — 192. 168. 0. 254

7.4 Using Setup Program

The Setup Program can be used for the following purposes.

- Finding the IP address and port number of the camera connected to your network.
- Setting up the camera automatically.
- Setting camera names manually. Configuring the Static or DHCP setting.
- Displaying the Setup page.

Finding the camera

1. Insert the CD-ROM into the CD-ROM drive of your PC.
 - If the Panasonic Network Camera Setup window does not appear, click "setup.exe" on the CD-ROM.
2. Click [Camera Setup].

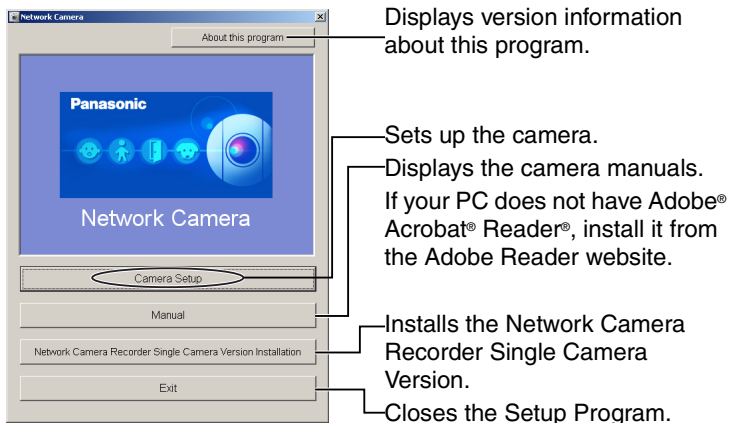

- If the following dialog box is displayed, click [Unblock].



- You can find the camera IP address and port number by looking up the MAC address of your camera.

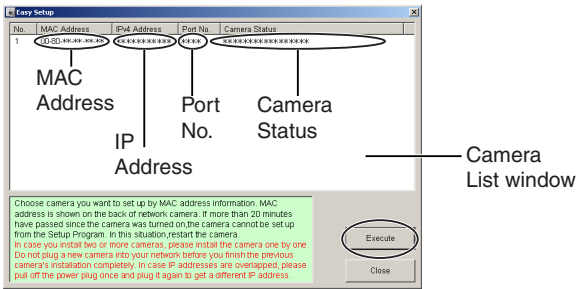

Note

- When trying to find multiple cameras, the MAC address on the rear side verifies which camera you are setting up.
- See page 138 for details about setup from the MAC address.

Automatic Setup (Local or Internet Access) or Manual Setup

1. Click [Execute] on the Camera List window shown on page 135.
2. Click the corresponding button.

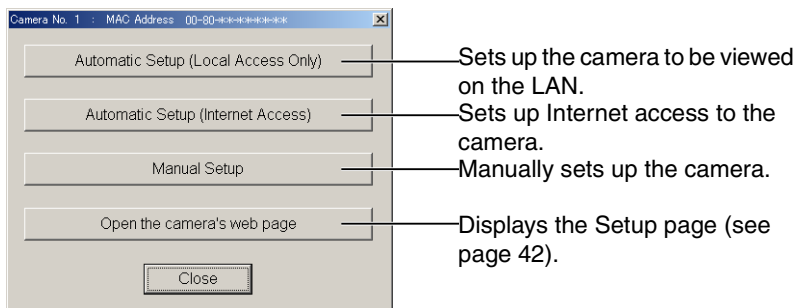

Note

See Getting Started for local and Internet access setup.

Manual Setup window

Set up each parameter referring to page 47 and page 49.

- If more than 20 minutes have passed since the camera was turned on, the camera cannot be set up from the Setup Program. If the camera cannot be set up, restart the camera.

Manual Setup

Camera Name: NetworkCamera

Port Number: 80

Static

IP Address: 192 . 168 . 0 . 253

Subnet Mask: 255 . 255 . 255 . 0

DHCP

Host Name: _____

Default Gateway: * . * . * . *

DNS Server1: * . * . * . *

DNS Server2: * . * . * . *

Band Width: Unlimited

Set up Port forwarding(*1) on the router to access the camera from the Internet.
 (*1) Port forwarding is sometimes called "Address translation", "Static IP Masquerade", "Virtual server" or "Port mapping".

Save Close

- If "Camera setup completed" is displayed, click [Close] to finish Manual Setup.

3. Close all Setup windows.

Setting up the Camera Using the MAC Address on the Setup Program

The Setup Program may not list any cameras due to your firewall or antivirus software settings on your PC. If you cannot disable your firewall or antivirus software, you can set up the camera using the camera MAC address as shown below.

1. Enter the camera MAC address in the data field, and click [Set up camera].

Note

The camera's MAC address can be found on the sticker affixed to the rear of the camera (see page 20).

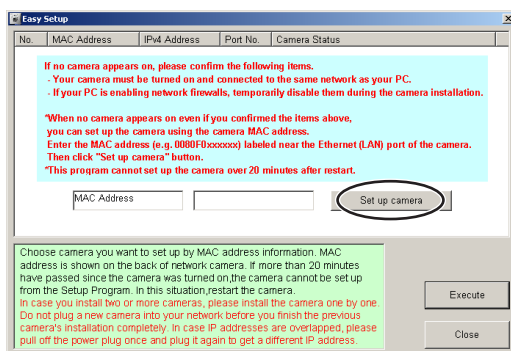

2. After confirming the network settings, click [OK].

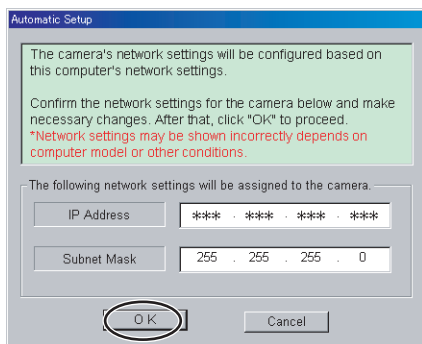

- After about a minute, the Security: Administrator page is displayed.

3. Enter the user name and password, and click [Save].

4. The Enter Network Password window is displayed. Enter the user name and password that you set above, and click [OK].

5. When the Single Camera page is displayed, the setup is complete.

- If a Security Warning window is displayed, click [Yes] (see page 28).
- See page 29 for Security Warning window when using Microsoft Windows XP Service Pack 2.

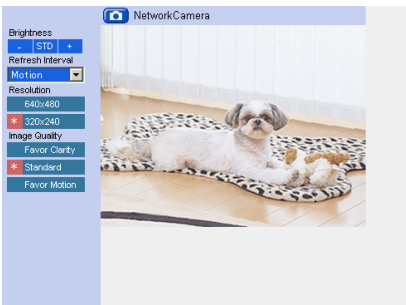

6. Configure wireless configuration (see page 50).

Note

- See page 26 for the Single Camera page.
- If you will enable Internet access to the camera, follow the procedures below.
- **When you are using a router that supports UPnP™**
 1. Enable the Auto Port Forwarding feature on the UPnP™ page (see page 53).
 2. Register with the DynamicDNS service on the DynamicDNS page (see page 56).
 3. Confirm that the camera can be accessed from the Internet (see page 24).
If you cannot access the camera, see page 9 of Troubleshooting on the CD-ROM.
- **When you are using a router that does not support UPnP™**
Follow the procedures shown on page 55.

7.5 Setting Your PC

7.5.1 Setting Proxy Server Settings on a Web Browser

If a proxy server is not used, these settings are not required. If you are using a proxy server, perform the proxy server settings below.

- To communicate with a camera installed within a LAN, changing the web browser settings is recommended.
- The firewall of a proxy server in a corporate environment may prevent access to the camera. Consult your network administrator.

Note

- A proxy server is used to protect your network when connected to the Internet.
- If the camera is accessed via a proxy server, problems may occur. Consult your network administrator before installing the camera.
- If the camera is accessed via a proxy server, the refresh interval may be increased.

How to Set Proxy Server Settings

The example is Internet Explorer 6.0.

1. Start up Internet Explorer.
2. Click [Tools]→[Internet Options...].

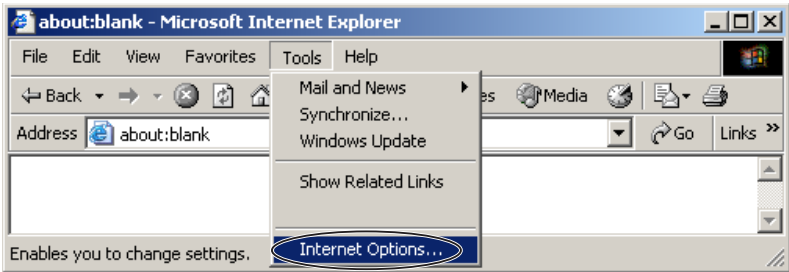

3. Click the [Connections] tab, and click [LAN Settings].

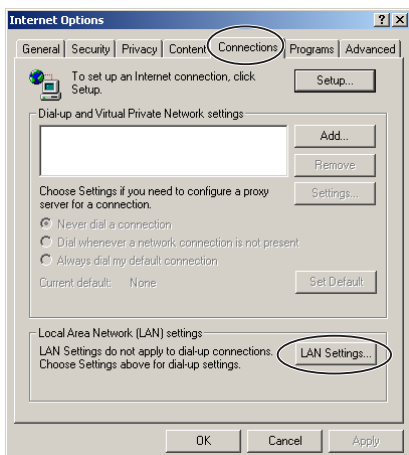

4. See if the Use a proxy server for your LAN check box is checked or not. If checked, click [Advanced...].

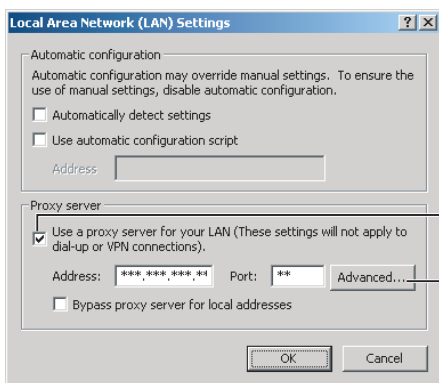

See if this check box is checked or not.
If checked, click [Advanced...].

- If not checked, click [Cancel]. Proxy settings are not required.

5. Enter the camera's IP address into the Do not use proxy server for addresses beginning with data field (e.g.: 192.168.0.253).

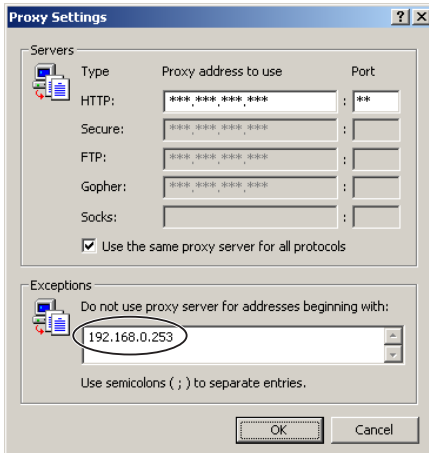

6. Click [OK].

7.5.2 Setting UPnP™ to Display Camera Shortcut in My Network Places

To display the camera shortcut in the My Network Places folder, a Windows component should be added. Enable UPnP™ (Universal Plug and Play) following the steps below.

OS	Steps
Windows XP	[Start] (→[Settings])→[Control Panel]→[Add or Remove Programs]→[Add/Remove Windows Components]→Select [Networking Services]→[Details]→Check [UPnP User Interface]→[OK]→[Next]→Complete
Windows XP Service Pack 2	[Start] (→[Settings])→[Control Panel]→[Add or Remove Programs]→[Add/Remove Windows Components]→Select [Networking Services]→[Details]→Check [Internet Gateway Device Discovery and Control Client] and [UPnP User Interface]→[OK]→Complete
Windows Me	[Start]→[Settings]→[Control Panel]→[Add/Remove Programs]→[Windows Setup] tab→Select [Communication]→[Details]→Check [Universal Plug and Play]→[OK]→[OK]→[Restart]→Complete

Note

This feature is only available when using Windows XP or Windows Me.

7.5.3 Setting the Internet Temporary File Setting on the Web Browser

An old image may be displayed. In this case, change the web browser settings following the steps below.

[Tools]→[Internet Options]→[General] tab→[Settings] in the Temporary Internet files→Check [Every visit to the page] in the Check for newer versions of stored pages→[OK]→[OK]→Complete

7.6 ASCII Character Table

(space)	0	@	P	`	p
!	1	A	Q	a	q
"	2	B	R	b	r
#	3	C	S	c	s
\$	4	D	T	d	t
%	5	E	U	e	u
&	6	F	V	f	v
'	7	G	W	g	w
(8	H	X	h	x
)	9	I	Y	i	y
*	:	J	Z	j	z
+	;	K	[k	{
,	<	L	\	l	
-	=	M]	m	}
.	>	N	^	n	~
/	?	O	_	o	

7.7 File Size and Number of Buffered Images

The following table shows the relationship between the file size of the image and the maximum number of buffered images.

Note

The following file sizes are shown at their maximum value.

Resolution	Items	Capture	Favor Clarity	Standard	Favor Motion	Mobile phone ^{*1}
640 × 480 (pixels)	File Size	About 60 KB	About 50 KB	About 33 KB	About 20 KB	-
	Buffered Images	-	About 80	About 120	About 200	-
320 × 240 (pixels)	File Size	About 30 KB	About 25 KB	About 16 KB	About 8 KB	About 8 KB
	Buffered Images	-	About 160	About 250	About 500	About 500
160 × 120 (pixels)	File Size	About 10 KB	About 7 KB	About 5 KB	About 3 KB	About 3 KB
	Buffered Images	-	About 570	About 800	About 1330	About 1330

*1 The values shown are the file sizes when transferring to a mobile phone.

The number of Buffer/Transfer images

The maximum number of images that can be buffered/transferred depends on resolution or image quality. When one or more settings are enabled in Trigger, the maximum number of buffered images will be divided equally between each enabled setting. As the images are saved on the internal memory, even if images cannot be transferred due to server or network failure, the maximum number of buffered/transferred images will remain the same.

Example

Image Resolution: 320×240, Image Quality: Standard

The maximum number of buffered images for each setting = About 250 ÷ The number of enabled settings

The number of enabled settings	1	2	3	4	5
The maximum number of buffered images for each setting	About 250	About 120	About 80	About 60	About 50

When [Motion Detection] is set in Trigger, and both [Enable Pre-trigger Image Buffer] and [Enable Post-trigger Image Buffer] are checked in Image Buffer Frequency

- When checking [No Transfer, Memory Overwrite] for the Transfer Method:
The number of the pre-triggered images that can be buffered is one third of the maximum number of buffered images for each setting.

Example

Image Resolution: 320x240, Image Quality: Standard

The number of enabled settings	1	2	3	4	5
The maximum number of buffered images for each setting (A)	About 250	About 120	About 80	About 60	About 50
The maximum number of [Enable Pre-trigger Image Buffer] images (B) [Approx one third of (A)]	About 80	About 40	About 25	About 20	About 15
The actual number of buffered images (C)	About 170	About 80	About 55	About 40	About 35

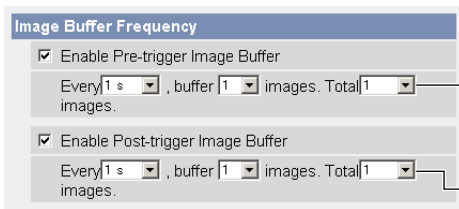

(B) The number of [Enable Pre-trigger Image Buffer] images (B) must follow: $(B) < (A) \times 1/3$

(D) The total number of the [Enable Pre-trigger Image Buffer] images (B) and the [Enable Post-trigger Image Buffer] images (D) must follow: $(B) + (D) < (A) - (B)$

Example

The maximum number of buffered images for each setting (A): About 250 images
 The maximum number of [Enable Pre-trigger Image Buffer] images (B): About 80 images

- A specified number of [Enable Pre-trigger Image Buffer] images (B: about 80 images) are buffered at specified intervals in the Pre-trigger memory (β) set aside for this purpose.
- When motion is detected, the images in the Pre-trigger memory (β) are moved to the buffered image memory (γ) so that they can be seen by the user. Post-trigger images are stored in the buffered image memory (γ).
- The Pre-trigger memory (β) is used for buffering new Pre-trigger images and not storing buffered images.

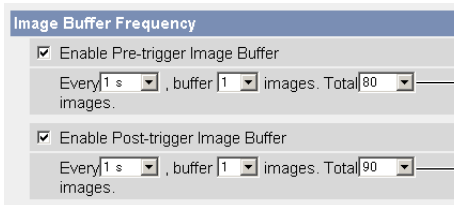
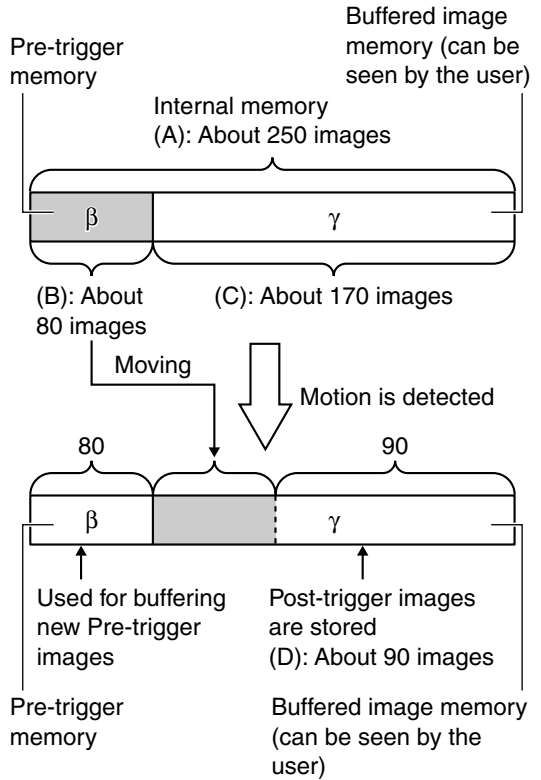

(B)

(D): Must be 90 or below.

7.8 Specifications

Network Camera

Items	Specifications
Zoom	10× digital zoom
Image Sensor	1/4-inch CMOS Sensor 320,000 pixels
Illuminance	4—10,000 lx (when color night view mode is enabled) 10—10,000 lx (when color night view mode is disabled)
White Balance	Auto/Manual
Focus	Fixed 0.3 m—Infinity
Caliber Ratio (F No.)	F2.8
Viewing Angle	Horizontal axis: 53 °, Vertical axis: 41 °
Exposure	Auto

Other Specifications

Items	Specifications
Video Compression	JPEG (3 Levels)
Video Resolution	640 × 480, 320 × 240 (default), 160 × 120
Buffered Image ¹	About 250 frames (320 × 240), standard
Frame rate ²	Max. 7.5 frames/second (640 × 480) Max. 15 frames/second (320 × 240 or 160 × 120)
Supported Protocols	TCP, UDP, IP, HTTP, FTP, SMTP, DHCP, DNS, ARP, ICMP, POP3, NTP, UPnP™
Message Transfer Condition	Timer or Motion Detection
Image Transfer Method	SMTP ³ , FTP
Interface	Wired: 10Base-T/100Base-TX Ethernet RJ-45 connector × 1 Wireless: IEEE 802.11b/g (Embedded)

Other Specifications

Items	Specifications
Indicator Display	Power/Network Communication/Camera operation/ Ethernet link
Dimension (HWD)	About 85 mm × About 85 mm × About 35.5 mm
Weight	165 g (Only the unit)
Power Supply	AC adaptor (Cord Length: About 3 m) Input: PQLV206CEY: 100—240 V AC, 50/60 Hz PQLV206EY: 220—240 V AC, 50/60 Hz Output: 9 V DC, 750 mA Consumption: About 4.6 W
Temperature	Operation: +5 °C to +40 °C Storage: 0 °C to +50 °C
Humidity	Operation: 20 %—80 % (No Condensation) Storage: 20 %—90 % (No Condensation)

^{*1} The maximum number of frames changes depending on the image quality and resolution.

^{*2} Frame rate may slow down depending on the network environment, PC performance, image quality or what object you view.

^{*3} POP before SMTP authentication and SMTP authentication (PLAIN and LOGIN) are supported. SMTP authentication (CRAM-MD5) is not supported.

Wireless Specifications

Items	Specifications
Communication mode (Communication Standard)	IEEE 802.11b, 802.11b/g, 802.11g exclusive
Data Transfer Mode	IEEE 802.11b: Direct Sequence Spectrum Spread (DS-SS) IEEE 802.11g: Orthogonal Frequency Division Multiplexing (OFDM)
Frequency Range	2.412—2.472 GHz
Channel	1—13
Security	WEP (64/128/152 bit), SSID

Index

A

Abbreviations 3
 ActiveX Controls 28
 Administrator/General Users/Guest
 Users 69
 ASCII Character Table 145

B

Buffered Image page 36

C

Camera Access 24
 Camera page 64
 Capture Image Button 32
 Cleaning 132
 Click to Center 30

D

Date and Time page 62
 Default Setting List 123
 Digital zoom feature 2
 DynamicDNS 56, 60

E

Encryption 51

F

FACTORY DEFAULT RESET
 Button 122

G

General User page 71

H

Help page 120

I

IEEE 802.11b/g 50

Image Display page 103
 Indicator Control page 110

L

Load Settings page 118
 Login 70

M

Maintenance page 111
 Mobile phone 39
 Motion Detection 84, 97
 Multi-Camera page 34
 Multi-Camera Setup page 106

N

Network page 45

O

Operation Bar 33
 Operation Time page 108

P

Product Information page 121

R

Reset to Factory Default page 119
 Restart page 113

S

Save Settings page 117
 Security: Administrator page 66
 Sensor Log 100, 113
 Session Status 112
 Setup page 42
 Setup Program 134
 Single Camera page 26
 Specifications 149
 SSID 50
 Status page 112

Support Information page 121

Support page 120

T

Timer Image Buffer/Transfer 74

Top page 25

Trademarks 3

U

Update Firmware page 114

UPnP page 53

W

WEP 51

Wireless Help page 121

Wireless page 50

Wireless Status page 112

The information in this document is subject to change without notice.

Panasonic Communications Co., Ltd.

1-62, 4-chome, Minoshima, Hakata-ku, Fukuoka 812-8531, Japan

Copyright:

This material is copyrighted by Panasonic Communications Co., Ltd., and may be reproduced for internal use only. All other reproduction, in whole or in part, is prohibited without the written consent of Panasonic Communications Co., Ltd.

© 2006 Panasonic Communications Co., Ltd. All Rights Reserved.

PQQX14971ZA KK0206YR0 (CE)

Free Manuals Download Website

<http://myh66.com>

<http://usermanuals.us>

<http://www.somanuals.com>

<http://www.4manuals.cc>

<http://www.manual-lib.com>

<http://www.404manual.com>

<http://www.luxmanual.com>

<http://aubethermostatmanual.com>

Golf course search by state

<http://golfingnear.com>

Email search by domain

<http://emailbydomain.com>

Auto manuals search

<http://auto.somanuals.com>

TV manuals search

<http://tv.somanuals.com>