

Panasonic

Operating Instructions

3 CCD Color Camera Head

Model No. **GP-US522HA**

GP-US532HA

3 CCD Color Camera CCU

Model No. **GP-US522CUA**



Lens : Purchased locally
Cable: Option

Before attempting to connect or operate this product,
please read these instructions carefully and save this manual for future use.

CONTENTS

PREFACE	3
FEATURES	3
PRECAUTIONS	4
MAJOR OPERATING CONTROLS AND THEIR FUNCTIONS	5
Camera Head	5
Camera Control Unit	5
CONNECTIONS	9
SETUP	11
1. CAMERA SETUP MENU	11
2. SETUP OPERATION	11
SETTING PROCEDURES	13
PREVENTION OF BLOOMING AND SMEAR	22
SPECIFICATIONS	23
OPTIONAL ACCESSORIES	24

Caution:

Before attempting to connect or operate this product, please read the label on the bottom.

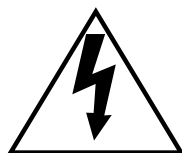
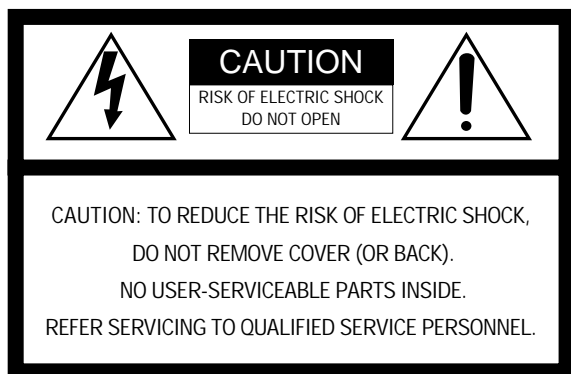

SA 1965

The lightning flash with arrowhead symbol, within an equilateral triangle, is intended to alert the user to the presence of uninsulated "dangerous voltage" within the product's enclosure that may be of sufficient magnitude to constitute a risk of electric shock to persons.



SA 1966

The exclamation point within an equilateral triangle is intended to alert the user to the presence of important operating and maintenance (servicing) instructions in the literature accompanying the appliance.

For U.S.A

NOTE: This equipment has been tested and found to comply with the limits for a Class A digital device, pursuant to Part 15 of the FCC Rules. These limits are designed to provide reasonable protection against harmful interference when the equipment is operated in a commercial environment. This equipment generates, uses, and can radiate radio frequency energy and, if not installed and used in accordance with the instruction manual, may cause harmful interference to radio communications.

Operation of this equipment in a residential area is likely to cause harmful interference in which case the user will be required to correct the interference at his own expense.

FCC Caution: To assure continued compliance, (example - use only shielded interface cables when connecting to computer or peripheral devices). Any changes or modifications not expressly approved by the party responsible for compliance could void the user's authority to operate this equipment.

The serial number of this product may be found on the bottom of the unit.

You should note the serial number of this unit in the space provided and retain this book as a permanent record of your purchase to aid identification in the event of theft.

Model No. _____

Serial No. _____

WARNING:

To reduce the risk of fire or electric shock, do not expose this appliance to rain or moisture.

PREFACE

Panasonic's GP-US522/532 Industrial Digital Signal Processing Color 3-CCD Camera overcomes space limitations that have complicated many video applications. The GP-US522/532 incorporates Three 380 000-pixels (768 (H) x 494 (V)) Interline Transfer CCDs to give you a remarkable 800 lines (750 lines for GP-US532) of horizontal reso-

lution and a S/N ratio is 62 dB. This means a color picture with high visual information content, for excellent image detail.

Because it features digital signal processing, the GP-US522/532 provides an exceptionally stable picture.

FEATURES

1. High-performance micro prism optical system with three IT CCDs
2. 800 lines of horizontal resolution for GP-US522 and 750 lines for GP-US532
3. Signal to noise ratio of 62 dB
4. Minimum scene illumination with + 18 dB gain of 5 lx at F2.8 for GP-US522 and 9 lx at F2.2 for GP-US532
5. Auto Tracing White Balance (ATW), Auto White Balance Control (AWC) or Manual White Balance Control are selectable
6. Automatic Setting of Black Balance (ABC) or Manual Setting
7. Gen-Lock capability
8. SMPTE color bar generator
9. Automatic Gain Control (AGC) and Electronic Light Control(ELC) are available
10. Automatic (AUTO), Step (STEP) and Manual (MANU) setting of Electronic shutter modes are selectable
11. 12V DC operation
12. RGB and S-Video Outputs
13. Character Generator Input
14. 2 SCENE files are selectable

PRECAUTIONS

1. Do not attempt to disassemble the camera or camera control unit.

To prevent electric shock, do not remove screws or covers.

There are no user-serviceable parts inside. Ask a qualified service person for servicing.

2. Handle the camera and the camera control unit with care.

Do not abuse the camera and the camera control unit. Avoid striking, shaking, etc. The camera could be damaged by improper handling or storage.

3. Do not expose the camera or camera control unit to rain or moisture, or try to operate it in wet areas.

Turn the power off immediately and ask a qualified service person for servicing. Moisture can damage the camera and the camera control unit, and also create the danger of electric shock.

4. Do not drop anything inside the camera or camera control unit.

Dropping a metal part for example inside the camera and camera control unit could permanently damage the unit.

5. Do not crush or pinch the camera cable.

Avoid tight bends in the camera cable.

6. Never face the camera toward the sun.

Do not aim the camera at bright objects. Whether the camera is in use or not, never aim it at the sun or other extremely bright objects. Otherwise, blooming or smear may be caused.

7. Do not use strong or abrasive detergents when cleaning the camera or the camera control unit body.

Use a dry cloth to clean the camera or the camera control unit when dirty.

In case the dirt is hard to remove, use a mild detergent and wipe gently.

8. Clean the faceplate with care.

Do not clean the faceplate with strong or abrasive detergents. Use lens tissue or a cotton tipped applicator and ethanol.

9. Put the lens cap on the camera after using the camera.

After using the camera, turn the power of the camera control unit off, and put the lens cap on the camera head.

10. Do not connect units other than the camera head to the GP-US522CUA camera control unit.

Other connections may result in improper operation.

11. Do not operate the camera and the camera control unit beyond the specified temperature, humidity, or power source ratings.

Use the camera and the camera control unit under conditions where temperature is between 0°C - +45°C (32°F - 113°F), and humidity is below 90%. The input power resource is 12 V DC.

12. Ask a qualified service person for installation.

All necessary procedures with regards to installation of this product should be made by qualified service person or system installer.

Cautions

1. Connecting or disconnecting the camera cable to/from the camera control unit or camera head must be done after turning off the power of the camera control unit.
2. Use GP-CA522/4 (4 m/13 ft) camera cable only for connection between the camera head and camera control unit. Do not extend the cable.

MAJOR OPERATING CONTROLS AND THEIR FUNCTIONS

Camera Head

1. Lens Mount

This is used to attach the special C-mount lens for GP-US522 and the C-mount lens for GP-US532.

2. Camera Cable Connector

This 24-pin connector is used to connect the optional camera cable GP-CA522/4 to the camera control unit.

3. Camera Mounting Screw Hole

This hole (1/4" - 20) is used to mount the camera onto a mounting bracket.

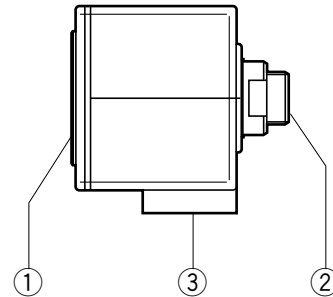

Camera Control Unit

[Front Panel]

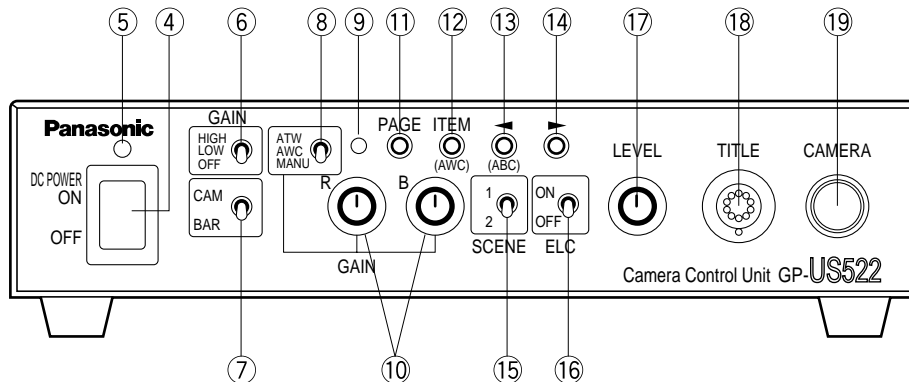

4. Power ON/OFF Switch (DC POWER ON/OFF)

This switch turns the power of this unit and the power supply for the camera head on or off.

5. Power Indicator (POWER)

This indicator lights up red when the power switch is turned on.

6. Automatic/Manual Gain Selector Switch (GAIN HIGH/LOW/OFF)

This selector is used to select the gain of video amplifier as follows.

The mode can be selected in the SET UP menu.

Refer to page 16.

MODE	POSITION OF SW	GAIN
AUTO	HIGH	Maximum +18 dB
	LOW	Maximum +9 dB
	OFF	0 dB
MANU	HIGH	+18 dB (Fixed)
	LOW	+9 dB (Fixed)
	OFF	0 dB

7. Camera/Color Bar Selector (CAM/BAR)

This selector is used to select either the video signal or the SMPTE color bar signal which is output from the video output connector (VIDEO), YC (S-VIDEO) output connector or RGB (D-SUB, 9-pin) output connector.

CAM :The video signal from the camera is output.

BAR : The SMPTE color bar signal is output.

Set this switch to BAR when making video monitor adjustments and recording the color bar signal.

8. White Balance Selector (ATW/AWC/MANU)

This selector is used to select one of the following white balance modes.

ATW: In this mode, the color temperature is monitored continuously and thereby white balance is set automatically.

AWC: In this mode, accurate white balance is obtained.

The white balance settings are as follows:

1. Aim the camera at white chart.
2. Press the ITEM (AWC) button on the front panel to set the white balance.
3. When the auto white balance is completed, the auto warning indicator first blinks and then goes off.

If the auto warning indicator remains lit, repeat the above procedure for setting the auto white balance.

MANU: The white balance can be adjusted manually with the red gain (R GAIN) and blue gain controls (B GAIN).

9. Auto Warning Indicator

This indicator blinks while the white balance or black balance is being automatically set. This indicator lights continuously when the white balance or black balance is set improperly. In this case, follow the auto white balance or black balance setting procedure.

10. Red and Blue Gain Controls (R GAIN/B GAIN)

These controls are used to manually adjust the white balance.

These controls only work when the white balance selection switch (ATW/AWC/MANU) is set to MANU.

Turn the controls clockwise to increase the red and blue signal levels, and counterclockwise to decrease.

11. Page Button (PAGE)

This button is used to display the SETUP MENU by pressing it for 2 seconds or more, and to change the parameters in the SETUP MENU.

12. Item Button (ITEM/AWC)

While the SETUP menu is displayed, this button is used to move the cursor to the downward.

Normally, when the white balance selection switch (ATW/AWC/MANU) is set to AWC, this button is used to set the automatic white balance control (AWC).

13. Left Button (◀/ABC)

While the SETUP menu is displayed, this button is used to move the cursor to the left.

Normally, this button is used to set the automatic black balance control (ABC).

14. Right Button (▶)

This button is used to move the cursor to the right in the SETUP menu.

15. Scene File Selector (SCENE)

This selector is used to select the scene files.

16. Electronic Light Control ON/OFF Selector (ELC ON/OFF)

This selector is used to select the electronic light control from followings.

ON : Enables Electronic Light Control (ELC) mode and disables Electronic Shutter Speed (SHUTTER) mode.

OFF : Enables Electronic Shutter Speed (SHUTTER) mode and disables Electronic Light Control (ELC) mode.

Note :

- Confirm the setting of the ELC and SHUTTER parameters on the SETUP menu.

17. Electronic Shutter Speed Control (LEVEL)

This control is used to set the target value of Electronic Shutter Speed between 1/60 and 1/10 000 second together with the ELC ON/OFF switch.

18. Title Input Connector (TITLE)

This connector is used to connect the optional Character Generators WJ-KB30 or WJ-KB50.

Note :

The Black & White characters of the generator are mixed with the video signal and are obtained at VIDEO OUT, S-VIDEO (Y/C) OUT and RGB/SYNC OUT connectors.

Colourization of characters is not available.

19. Camera Cable Connector (CAMERA)

This 20-pin connector is used for connection with the camera head via the optional camera cable GP-CA522/4.

Fasten the camera cable to this connector firmly. If not, noise may be appeared.

Caution

Connecting or disconnecting the camera cable to/from the camera control unit or camera head must be done after turning off the Power of the camera control unit.

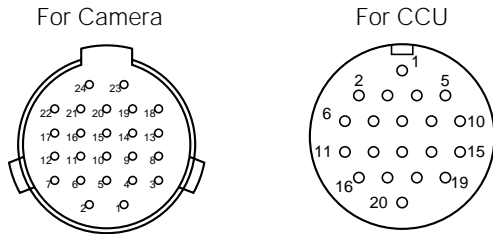

Camera Head Side		Camera Control Unit Side	
1	+15V Input	1	Ground (GND)
2	Ground (GND)	2	Not used
3	Chip Select Input	3	PBLK Input
4	+25 Input	4	+9V Output
5	-9V Input	5	-9V Output
6	B Signal Output	6	28MHz Output
7	RGB Ground (GND)	7	CPOB Input
8	Serial Data Input	8	RGB Ground (GND)
9	Serial Clock Input	9	+5V Output
10	CCD Select Output	10	B Signal Input
11	G Signal Output	11	Serial Clock Output
12	R Signal Output	12	VD Output
13	VD Input	13	Chip Select Output
14	CPOB Output	14	+25 Output
15	HD Input	15	R Signal Input
16	+9V Input	16	Serial Data Output
17	+5V Input	17	HD Output
18	PBLK Output	18	G Signal Input
19	Not used	19	+15V Output
20	Not used	20	CCD Select Input
21	Not used		
22	Not used		
23	28MHz Input		
24	Not used		

[Rear Panel]

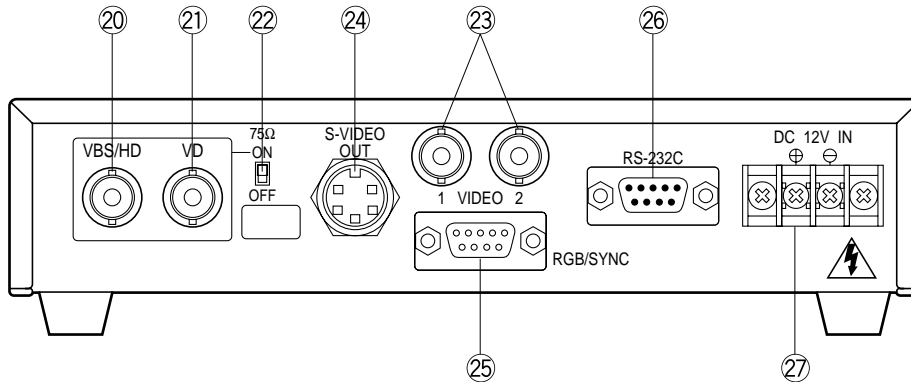

20. Gen-lock Signal Input Connector (VBS/HD)

The color video signal of the camera is automatically synchronized with the gen-lock signal (Composite Signal, Black Burst Signal or Video Sync) when either signal is supplied to this connector. The gen-lock signal is used for system reference.

Caution :

If the gen-lock signal is jittery (as in the case of a VCR playback picture), the camera cannot be synchronized properly.

(External HD and VD Mode)

The horizontal and vertical pulse of the color video signal is synchronized with the external HD fed to this connector and external VD fed to the VD input connector.

21. Gen-Lock Signal Input Connector (VD)

Supply the external vertical drive (VD) pulse to this connector.

22. Gen-Lock Video 75 Ω Termination ON/OFF Switch (75 Ω ON/OFF)

When looping through the gen-lock video signal with a BNC "T" adapter, set this switch to OFF. When not looping through, set this switch to ON.

23. Video Output Connector (VIDEO 1,2)

A 1.0V[p-p]/75 Ω composite video signal is provided at this connector.

24. S-Video Output Connector (S-VIDEO OUT)

The luminance (Y) and chrominance (C) signals for VCR or monitor are provided at this connector.

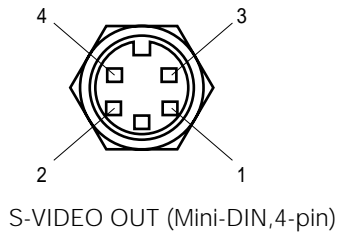

Pin No.	Description
1	Y Ground
2	C Ground
3	Y Signal Output (0.714V[p-p](Y level)/75 Ω)
4	C Signal Output (0.286V[p-p](Burst Level)/75 Ω)

25. RGB/SYNC Output Connector (RGB/SYNC)

The red, green, blue, sync and composite video signals are provided at this connector.

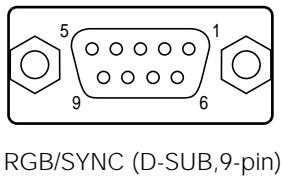

Pin No.	Description
1	Ground(GND)
2	Ground (GND)
3	Red (R) Output (0.7V[p-p]/75 Ω)
4	Green (G) Output (0.7V[p-p]/75 Ω)
5	Blue (B) Output (0.7V[p-p]/75 Ω)
6	Composite Video Output (1.0V[p-p]/75 Ω)
7	Sync (SYNC) Output (4.0V[p-p] or 0.3V[p-p]/75 Ω)
8	Ground (GND)
9	Ground (GND)

26. RS-232C Connector (RS-232C)

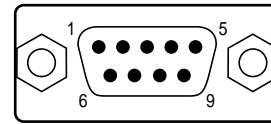

Pin No	Signal
	RS-232C
1	Ground
2	TXD
3	RXD
4	DSR
5	Ground
6	DTR
7	CTS
8	RTS
9	Ground

Note: Refer this connection to a qualified service person or system installer.

27. 12V DC Input Terminals (12V DC IN)

These terminals accept an external DC power source supplying nominal power of 12V DC, 0.7A.

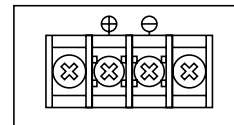

Cautions :

1. Connect to 12V DC (11.5 V - 16 V) class 2 power supply only.
2. To prevent fire or electric shock hazard, use a UL listed wire VW-1, Style 1007 cable for 12 V DC input terminals.

CONNECTIONS

Cautions :

1. Keep the DC POWER ON/OFF switch in the OFF position until all connections have been properly made.
2. Connect the camera head and camera control unit.

Internal Sync Operation

1. Connect the camera cable between the camera head and the camera control unit.
2. Connect the coaxial cable with BNC connectors between the video output connector of the camera control unit and the video monitor or VCR.

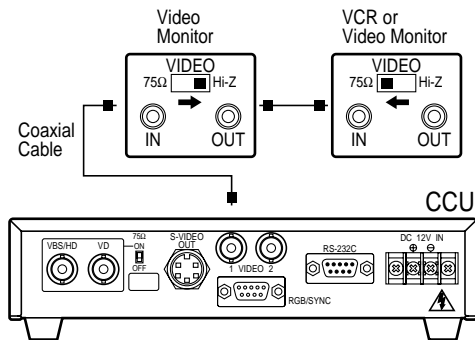

3. Connect the power cable between the DC 12 V input terminals and the 12 V DC power supply unit (obtained locally).

- The maximum cable length between camera control unit and power supply unit is calculated as follows:

$$11.5 \text{ V DC} < V_A - (R \times 0.42 \times L) < 16 \text{ V DC}$$

L : Cable length (meter)

R : Resistance of copper wire (Ω /meter)

V_A : DC output voltage of power supply unit

$$L \text{ standard} = V_A - 12 / 0.42 \times R \text{ (meter)}$$

$$L \text{ minimum} = V_A - 16 / 0.42 \times R \text{ (meter)}$$

$$L \text{ maximum} = V_A - 11.5 / 0.42 \times R \text{ (meter)}$$

Cautions :

1. Connect to 12 V DC (11.5 V - 16 V) class 2 power supply only.
2. To prevent fire or electric shock hazard, use a UL listed wire VW-1, Style 1007 cable for 12 V DC input terminals.

Gen-lock Operation

1. Connect the camera cable between the camera head and the camera control unit.
2. Connect the coaxial cable with BNC connectors between the video output connector of the camera control unit and the video input connector of Special Effects Generator (SEG), and between the VBS/HD input connector of the camera control unit.

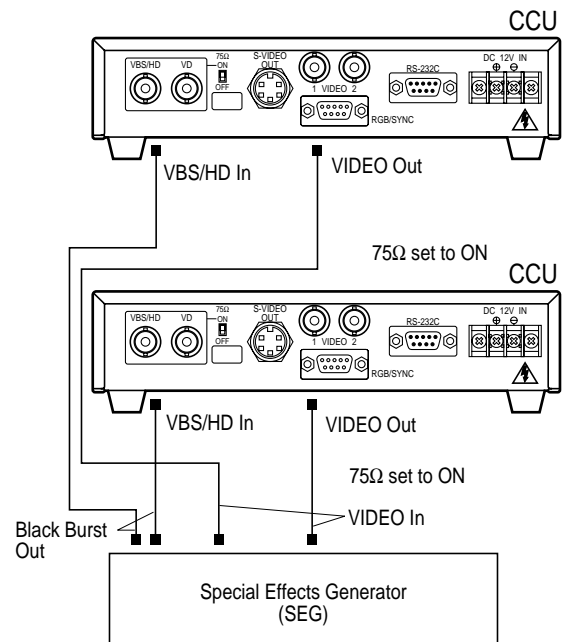

3. Connect the power cable between the DC 12 V input terminals and the 12V DC power supply unit (obtained locally).

Cautions :

1. Connect to 12 V DC (11.5 V - 16 V) class 2 power supply only.
2. To prevent fire or electric shock hazard, use a UL listed wire VW-1, Style 1007 cable for 12 V DC input terminals.

Mounting the Lens

Caution :

Keep the POWER ON/OFF switch of the camera control unit in the OFF position throughout the installation.

Lens Mount

1. Remove the front cap of the camera head and confirm that the surface of the optical filter of the camera head is clean.
If the surface of the optical filter is dirty clean it with a blower brush which is for film camera lenses (available at your local camera store).
2. Mount the C-mount lens by turning it clockwise onto the lens mount of the camera head.

Cautions:

- Do not use any lens which has more than 1/8" (3.5mm) of protrusion for lens mounting. (GP-US522)
- Do not open the lens iris wider than the F2.8 stops. (GP-US522)
- Do not open the lens iris wider than the F2.2 stops. (GP-US532)

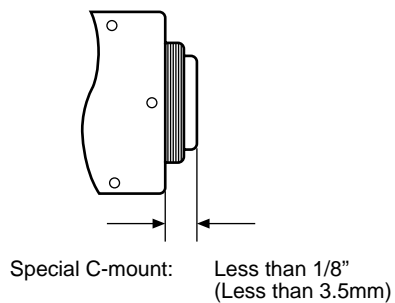

SETUP

1. CAMERA SETUP MENU

This camera utilizes a user setup menu that is displayed on-screen. The setup menu contains various items that form a tree-type structures as shown below.

It is described in the following section: "2. SETUP OPERATION".

Note:

The SETUP menu is output from the VIDEO 1, 2 connectors, the S-VIDEO OUT connector, and the RGB/SYNC connector.

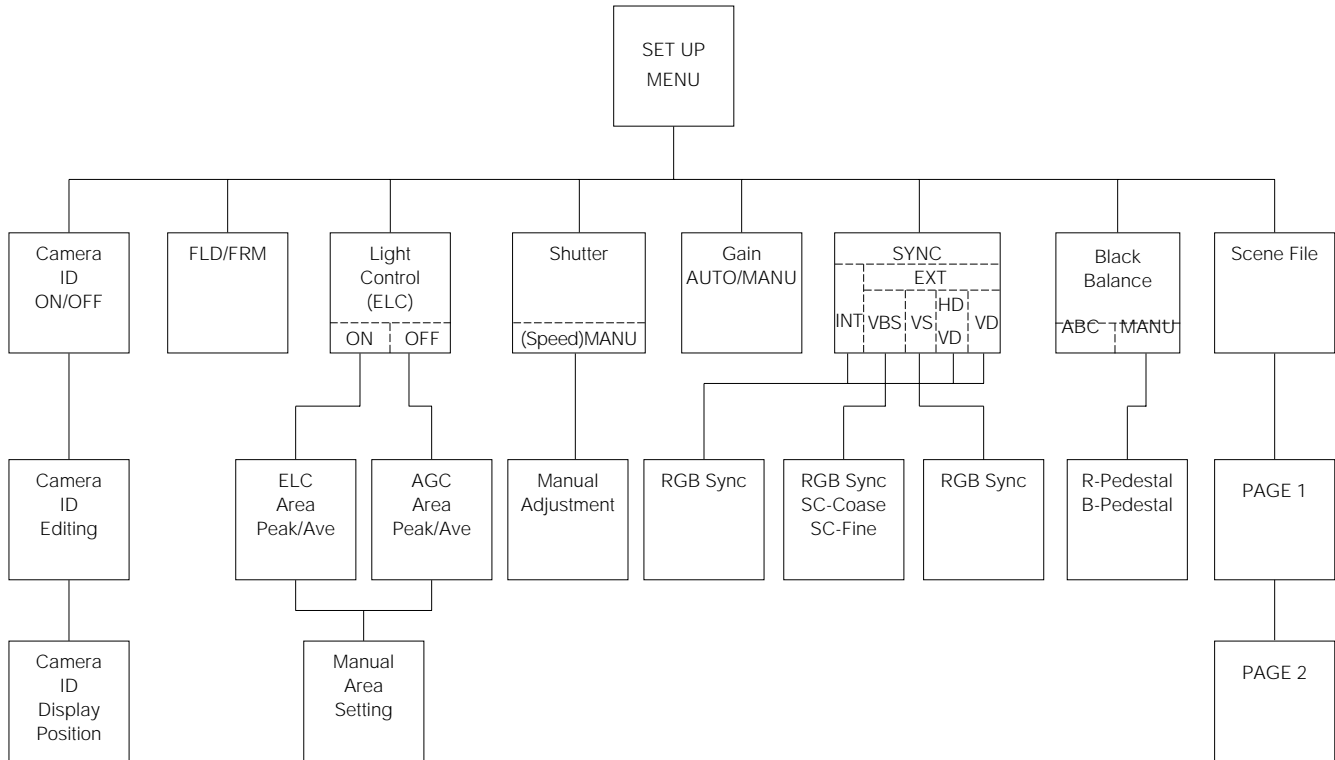

2. SETUP OPERATION

This camera utilizes a user setup menu (SETUP) that is displayed on the monitor. To set items on the SETUP menu, use the following buttons on the front panel of the camera control unit.

Page Button (PAGE) :

This button used to display the SETUP menu. Use this button to select an item.

Item Button (ITEM) :

This button is used to move the cursor downwards.

Left Button (◀) :

This button is used to move the cursor to the left. Use this button to select or adjust the parameters of the selected item. The parameter changes each time this button is pressed.

Right Button (▶) :

This button is used to move the cursor to the right. Use this button to select or adjust the parameters of the selected item. The parameter changes each time this button is pressed.

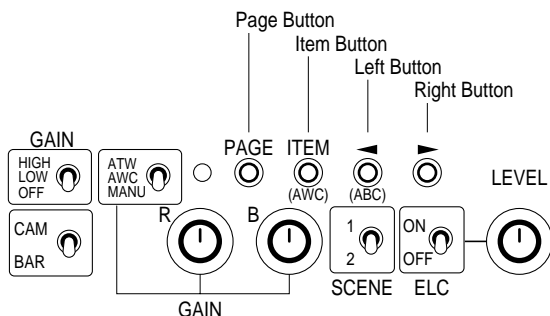

- **Opening the SETUP menu**

Press the PAGE button for a few seconds.

```
  ** SET UP **  
  
CAMERA ID      *OFF  
FLD/FRM        FLD  
ELC            *OFF  
SHUTTER        OFF  
GAIN           AUTO  
SYNC           INT  
BLACK BAL      ABC  
SCENE FILE     *SCENE1  
  
END
```

- **Editing the SETUP menu**

To edit the SETUP menu (change settings), press the ITEM button to move the cursor to an item, and press ◀ and ▶ to change its parameter. After completing all the settings, move the cursor to END at the bottom line, and press the PAGE button. The new values are stored in the EEPROM (Electric Erasable and Programmable Read Only memory). These values remain valid until new values are stored, even if the power of the camera control unit is off.

```
  ** SET UP **  
  
CAMERA ID      *OFF  
FLD/FRM        FLD  
ELC            *OFF  
SHUTTER        OFF  
GAIN           AUTO  
SYNC           INT  
BLACK BAL      ABC  
SCENE FILE     *SCENE1  
  
END
```

- **All Reset Operation**

All Reset allows you to reset all setup menu items to the factory settings if you are unsure about the correct settings. Proceed as follows:

1. Repeat the above procedures to display the SETUP menu.
2. Move the cursor to END at the bottom line.
3. Press both ◀ and ▶ for a few seconds. The SETUP menu disappears on the monitor screen and the auto warning indicator lights red.

At this time, all adjustments and parameters are reset to the factory default settings. The auto warning indicator goes off if AWC or ABC is performed.

SETTING PROCEDURES

1. Camera Identification (CAMERA ID)

You can use the camera identification (CAMERA ID) to assign a name to the camera. The camera ID consists of up to 16 alphanumeric characters. You can select whether to have the camera ID displayed on the monitor screen or not.

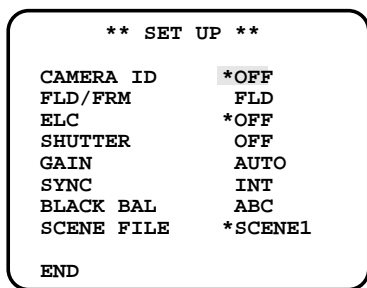

To edit the CAMERA ID

1. Move the cursor to the CAMERA ID parameter.
2. Press the PAGE button. The CAMERA ID menu appears. The cursor on the letter "A" starts blinking.

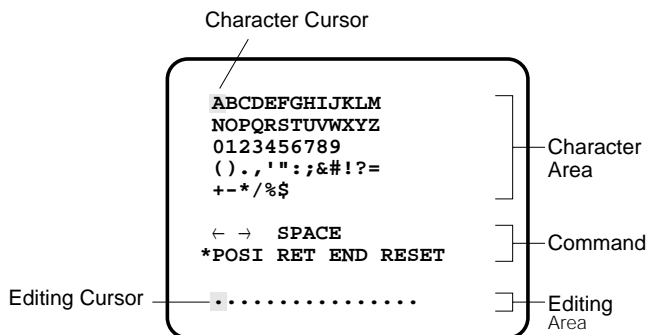

3. Move the character cursor to a character you want by pressing ITEM, ◀ or ▶.
4. After selecting the character, press the PAGE button. The selected character appears in the editing area. (The editing cursor in the editing area moves to the right automatically at this moment.)
5. Repeat the steps above until all characters are edited.

To enter a blank space in the CAMERA ID

Move the character cursor to SPACE and press the PAGE button.

To edit a specific character in the CAMERA ID

1. Move the character cursor to ← or → then press the PAGE button to move the editing cursor to the character to be edited in the editing area.
2. Move the character cursor to the character area and select a new character.
3. Press the PAGE button to set the CAMERA ID.

To erase all characters in the editing area

Move the character cursor to RESET and press the PAGE button. All characters in the editing area disappear.

To determine the display position of the CAMERA ID

1. Move the cursor to POSI, and press the PAGE button. The display shown below appears and the CAMERA ID starts blinking.

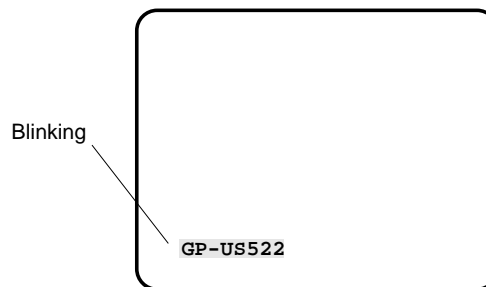

2. Move the CAMERA ID to the desired position by pressing ◀, ▶ or the ITEM button.
3. Press the PAGE button to fix the position of the CAMERA ID. The mode returns to the previous CAMERA ID menu.

Notes:

- The CAMERA ID stops at the edges of the monitor screen.
- The CAMERA ID moves faster if any of ◀, ▶ or the ITEM button is kept pressed for a second or longer.

To return to the SETUP menu

Move the cursor to RET and press the PAGE button. The SETUP menu appears.

To display the CAMERA ID on the monitor screen

Move the cursor to CAMERA ID in the SETUP menu and select ON.

2. Field/Frame Charging Mode Setting (FLD/FRM)

You can select the charging mode from FIELD or FRAME.

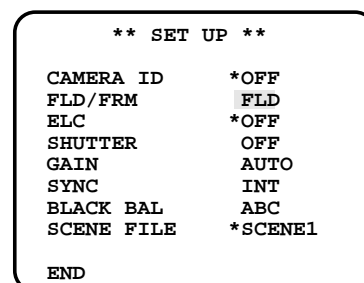

1. Move the cursor to the FLM/FRM parameter.

2. Select FLM (field) or FRM (frame).

Note:

When FRM is selected, ELC is set to OFF automatically.

3. Electronic Light Control Setting (ELC)

The electronic light control function eliminates interference by strong background lighting which makes the camera picture dark, such as a spotlight. In the ELC mode, more photometric weight is given to the desired point of the screen (to where the important object is located).

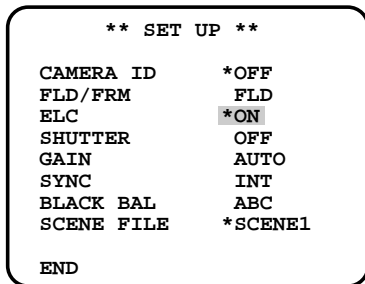

3-1. ELC detection control area setting (ELC CONT)

1. Select ON for the ELC ON/OFF selector on the front panel of the camera control unit. Then confirm the ELC parameter is ON.

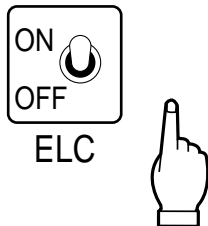

2. Move the cursor to the ELC parameter and press the PAGE button. The ELC CONT menu appears.

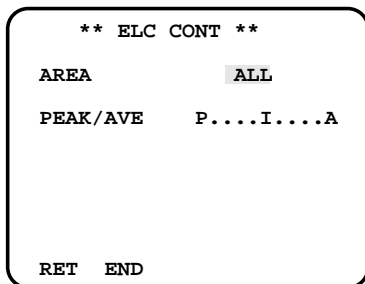

3. Move the cursor to the AREA parameter and select the desired detection area. You can select the desired detection area from followings.

ALL: All areas on the monitor screen are detected.

MANU: Detection areas are selectable manually. See below for details.

CENTER: The photometric weight is given to the center of the monitor screen.

S CIRCLE (Small Circle): The photometric weight is given to the area within a small circle in the center of the monitor screen.

M CIRCLE (Medium Circle): The photometric weight is given to the area within a medium large circle in the center of the monitor screen.

L CIRCLE (Large Circle): The photometric weight is given to the area within a large circle in the center of the monitor screen.

Each time you press ◀ or ▶, the parameter changes as follows.

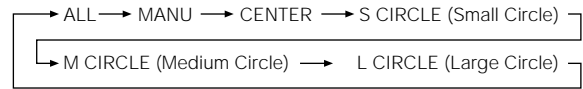

ALL

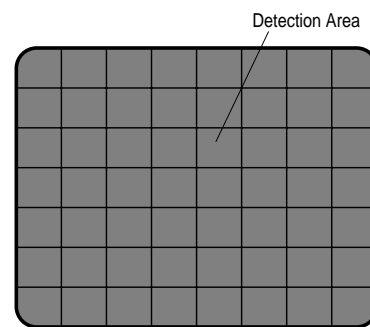

CENTER

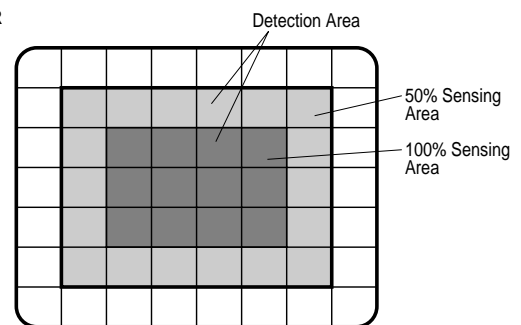

S CIRCLE (Small Circle)

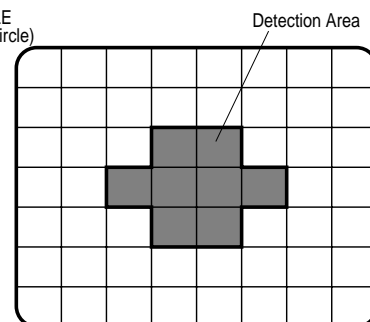

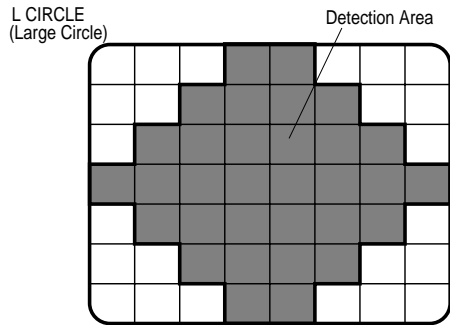
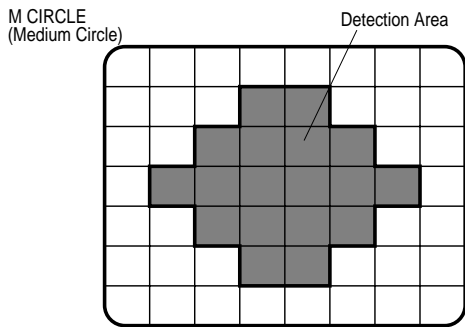

Note: Detection areas are not displayed on the monitor.

3-1-1. Manual setting of the ELC detection control area (MANU)

You can mask areas on the monitor screen to block the strong brightness manually. Follow the steps below:

Notes:

The manual mask setting field is only displayed on VIDEO1, 2 and S-VIDEO OUT. It is not displayed on RGB/SYNC output.

1. Move the cursor to the AREA parameter on the ELC CONT menu.
2. Select MANU and press the PAGE button. The manual mask setting field appears.

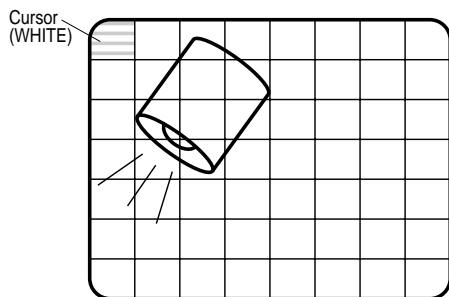

3. Select the area where backlight is bright by pressing ◀, ▶ or the ITEM button.

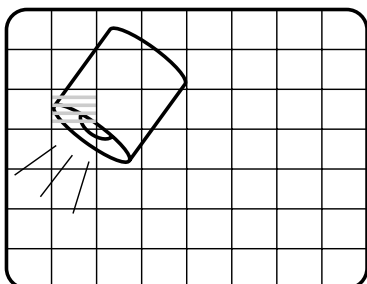

4. Press the PAGE button to mask that area. The mask turns white. (When the cursor is moved on an area that has already been masked, the mask and cursor start blinking.)

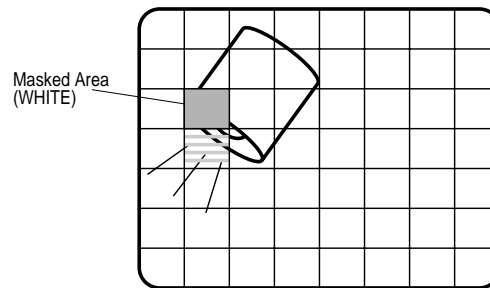

Note: A masked area will be excluded from ELC detection.

5. Repeat the steps 3 and 4 to complete masking. To cancel masking, move the cursor to that area and press the PAGE button.

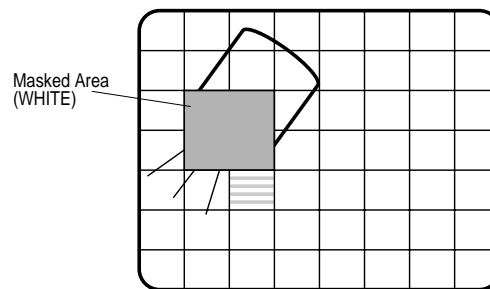

6. After masking is completed, press the PAGE button for a second or more. The ELC CONT menu appears.

3-1-2. Peak and Average Weight Control (PEAK/AVE)

1. Move the cursor to the PEAK/AVE parameter. The "I" cursor starts blinking.

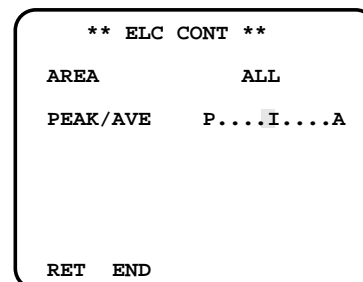

2. Move the "I" cursor to set the detection value. When the "I" cursor is moved to the P (peak) side, the peak value is detected. When the "I" cursor is moved to the A (average) side, the average value is detected.

3-2. AGC detection control area setting (AGC CONT)

1. Set the ELC ON/OFF selector on the front panel of the camera control unit to the OFF position. Then confirm that the ELC parameter is OFF.

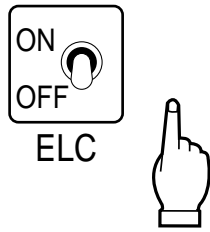

2. Move the cursor to the ELC parameter and press the PAGE button. The AGC CONT menu appears.

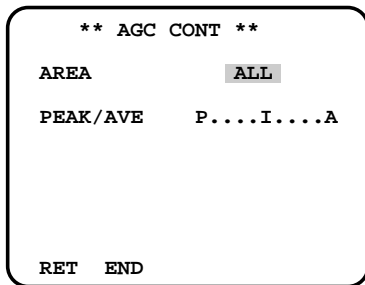

3. Follow step 3 described for "3-1. ELC detection control area setting (ELC CONT)" to select the desired detection area (AREA).
4. Follow steps 1 and 2 described for "3-1-2. Peak and Average Weight Control (PEAK/AVE)" to set the detection value.

4. Electronic Shutter Speed Setting (SHUTTER)

Note: When ON is selected for ELC on the SETUP menu, this item is not available. To select the electronic shutter speed, select OFF for ELC on the SETUP menu.

You can select the electronic shutter speed of 1/100, 1/250, 1/500, 1/1 000, 1/2 000, 1/4 000 or 1/10 000 seconds. The shutter speed can also be set manually.

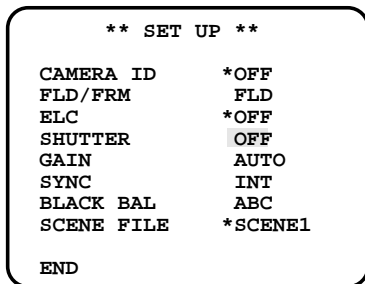

1. Move the cursor to the SHUTTER parameter.
2. Select the shutter speed or MANU for manual setting from the following.

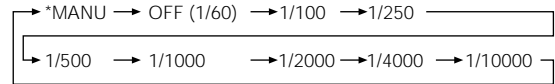

3. When you have selected MANU, press the PAGE button. The SHUTTER menu appears and the MANU SET parameter starts blinking.

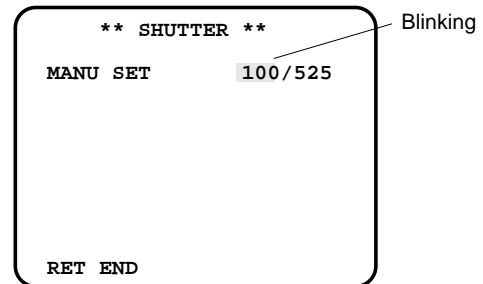
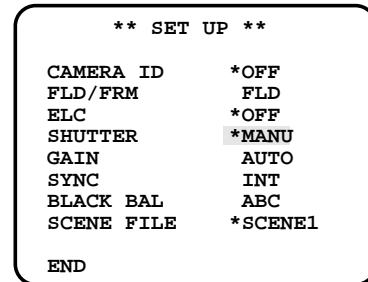

4. Select the desired electronic shutter speed by pressing ◀ or ▶. The adjustable range is 1/525-261/525 lines.

5. Gain Control Setting (GAIN)

You can set the gain (brightness level portion of an image) to automatic level adjustment (AUTO) or manual level adjustment (MANU).

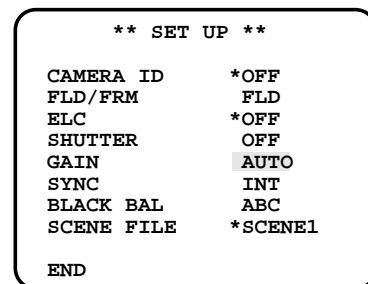

1. Move the cursor to the GAIN parameter.
2. Select AUTO or MANU. The gain of the video amplifier is changed according to the position of the automatic/manual gain selector (HIGH/LOW/OFF) on the front panel of the camera control unit.

If you select AUTO, the gain of the amplifier changes as follows.

Position	Gain
HIGH	Maximum +18 dB
LOW	Maximum +9 dB
OFF	0 dB

When you select MANU, the gain of the amplifier changes as follows.

Position	Gain
HIGH	+18 dB (Fixed)
LOW	+9 dB (Fixed)
OFF	0 dB

6. Synchronization Setting (SYNC)

This model accepts the VBS signal (color composite video or blackburst signal) and VS signal (B/W composite video or composite sync signal) for gen-lock operation.

It also accepts the combined vertical (VD) and horizontal (HD) drive pulse, and the vertical drive pulse (VD) only.

```

** SET UP **

CAMERA ID      *OFF
FLD/FRM        FLD
ELC             *OFF
SHUTTER        OFF
GAIN           AUTO
SYNC           *INT
BLACK BAL      ABC
SCENE FILE     *SCENE1

END

```

Important Notices:

- The sync mode priority is as follows:
 - Color composite video signal (VBS)
 - B/W composite video signal (VS)
 - HD/VD signal
 - VD signal
 - Internal sync (INT)
- When the internal sync (INT) mode is to be used, no gen-lock input signal should be supplied to the gen-lock input connector on the rear panel of the camera control unit.
- When the VBS or VS gen-lock mode is to be used, supply the gen-lock input signal to the gen-lock input connector on the rear panel of the camera control unit.
- The VBS gen-lock mode has its own menu for horizontal and subcarrier phase adjustments. When the cable length of the video output or the gen-lock input is changed, horizontal and subcarrier phase must be re-adjustable.

- The VS gen-lock mode has its own menu for horizontal and subcarrier phase adjustments. When the cable length of the video output or the gen-lock input is changed, the horizontal phase must be re-adjusted.
- When the HD/VD or VD pulse is to be used, supply them to the VBS/HD connector and the VD connector on the rear panel of the camera control unit.

6-1. Internal Sync Mode (INT)

RGB Sync Output Level Adjustment (RGB SYNC)

- Move the cursor to the SYNC parameter.
- Press the PAGE button. The SYNC menu appears on the monitor screen.

```

** SYNC **

RGB SYNC      0.3V

RET  END

```

- Move the cursor to the RGB SYNC parameter.
- Select 4.0V or 0.3V according to the RGB monitor input level.

6-2. VBS Gen-lock Mode (EXT(VBS))

- Move the cursor to the SYNC parameter.
- Connect the coaxial cable for the blackburst or composite color video signal to the gen-lock input connector.
- Confirm that the INT parameter changed to EXT(VBS) on the menu.

Caution: The gen-lock input signal should meet the EIA RS-170A specifications and should not contain jitter, such as a VCR playback signal, as it could disturb synchronization.

```

** SET UP **

CAMERA ID      *OFF
FLD/FRM        FLD
ELC             *OFF
SHUTTER        OFF
GAIN           AUTO
SYNC           *EXT(VBS)
BLACK BAL      ABC
SCENE FILE     *SCENE1

END

```

- After confirming that the cursor is on EXT(VBS), press the PAGE button. The SYNC menu appears on the monitor screen.

```

** SYNC **
RGB SYNC      0.3V
H PHASE       -....I....+
SC COARSE     1(1--4)
SC FINE       -I.....+
RET  END

```

- Move the cursor to the RGB SYNC parameter.
- Select 4.0V or 0.3V according to the RGB monitor input level.

Horizontal Phase Adjustment (H PHASE)

- Move the cursor to H PHASE. The cursor starts blinking.
- Supply the video output signal of the camera to be adjusted and the reference gen-lock input signal to a dual-trace oscilloscope.
- Set the oscilloscope to the horizontal sync portion on the oscilloscope.
- Adjust the horizontal phase by pressing ◀ or ▶. The adjustable range is 0-1.5 μs.

Note: To reset H PHASE to the values preset at the factory, press ◀ and ▶ simultaneously. The H PHASE is reset at the factory setting.

Subcarrier Coarse Phase Adjustment (SC COARSE)

- Move the cursor to SC COARSE parameter on the SYNC menu. The cursor starts blinking.
- Press ◀ or ▶ to match the color (hue) of the camera's video signal, when observed at the output of the Special Effect Generator (SEG) or Switcher, as closely as possible the color of the original scene. (The SC COARSE adjustment can be incremented in steps of 90 degrees (4 steps) by pressing ◀ or ▶.)

Note:

After the fourth step, the adjustment returns to the first step.

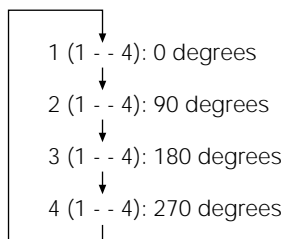

Subcarrier Fine Phase Adjustment (SC FINE)

- Move the cursor to SC FINE on the SYNC menu. The cursor starts blinking.
- Press ◀ or ▶ to match the color (hue) of the camera's video signal, when observed at the output of the Special Effect Generator (SEG) or Switcher, as closely as possible the color of the original scene. The SC FINE adjustment has a range of 90 degrees of color shift.

Notes:

- When the "I" cursor reaches the "+" end, it jumps back to "-". At the same time, SC COARSE is incremented by one step to enable a continuous adjustment. The reverse takes place when the "I" cursor reaches the "-" end.
For more accurate adjustment, supply both the original camera video output signal and the effect output video signal (program output video signal) of the special effects generator (SEG) to a vectorscope and compare the chroma phase of both signals.
- To reset SC FINE to the values preset at the factory, press ◀ and ▶ simultaneously. The SC FINE is reset at the factory setting.

6-3. VS Gen-lock Mode (EXT(VS))

- Move the cursor to the SYNC parameter.
- Connect the coaxial cable for the composite sync or composite B/W video signal to the gen-lock input connector.
- Confirm that the INT parameter changed to EXT(VS) on the menu.

Caution: The gen-lock input signal should meet the EIA RS-170 specifications and should not contain jitter, such as a VCR playback signal, as it could disturb synchronization.

```

** SET UP **
CAMERA ID      *OFF
FLD/FRM        FLD
ELC            *OFF
SHUTTER        OFF
GAIN           AUTO
SYNC           *EXT(VS)
BLACK BAL      ABC
SCENE FILE     *SCENE1
END

```

- After confirming that the cursor is on EXT (VS), press the PAGE button. The phase adjustment menu appears on the monitor screen.

```

** SYNC **
RGB SYNC      0.3V
H PHASE       -....I....+
RET  END

```

- Move the cursor to the RGB SYNC parameter.
- Select 4.0V or 0.3V according to the RGB monitor input level.
- Move the cursor to H PHASE. The cursor starts blinking.

- Supply the video output signal of the camera to be adjusted and the reference gen-lock input signal to a dual-trace oscilloscope.
- Set the oscilloscope to the horizontal rate and expand the horizontal sync portion on the oscilloscope.
- Adjust the horizontal phase by pressing ◀ or ▶. The adjustable range is 0-1.5 μs.

6-4. External HD/VD Mode (HD/VD)

- Move the cursor to the SYNC parameter.
- Connect the coaxial cable for the external HD and VD signal to the gen-lock input connector and the VD input connector respectively.
- Confirm that the INT parameter changed to EXT (H/V) on the menu.
- Move the cursor to the RGB SYNC parameter.
- Select 4.0V or 0.3V according to the RGB monitor input level.

```

** SET UP **

CAMERA ID      *OFF
FLD/FRM        FLD
ELC             *OFF
SHUTTER        OFF
GAIN           AUTO
SYNC           *EXT (H/V)
BLACK BAL      ABC
SCENE FILE     *SCENE1

END

```

6-5. External VD Mode (VD)

- Move the cursor to the SYNC parameter and select INT.
- Connect the coaxial cable for the external VD signal to the VD input connector.
- Confirm that the INT parameter changed to EXT (VD) on the menu.
- Move the cursor to the RGB SYNC parameter.
- Select 4.0V or 0.3V according to the RGB monitor input level.

```

** SET UP **

CAMERA ID      *OFF
FLD/FRM        FLD
ELC             *OFF
SHUTTER        OFF
GAIN           AUTO
SYNC           *EXT (VD)
BLACK BAL      ABC
SCENE FILE     *SCENE1

END

```

7. Black Balance Setting (BLACK BAL)

Under low light conditions, correct setting of the black balance is required for producing correct colours.

Once the black balance has been set correctly, the setting is maintained in memory.

This setting will not be lost even if the camera control unit is turned off. However, for best results, it is recommended that the black balance adjustment be carried out when the camera has not been used for a long period of time.

There are two black balance control mode. Auto black balance control (ABC) can be selected on the front panel and manual control (MANU) on this menu.

7-1. Auto Black Balance Setting (BLACK BAL)

- Move the cursor to the BLACK BAL parameter and select ABC.

```

** SET UP **

CAMERA ID      *OFF
FLD/FRM        FLD
ELC             *OFF
SHUTTER        OFF
GAIN           AUTO
SYNC           INT
BLACK BAL      ABC
SCENE FILE     *SCENE1

END

```

- Attach the lens cap on the camera lens.
- Move the cursor to END and press the PAGE button to close the SETUP menu.
- Press the ◀ (ABC) button on the front panel of the camera control unit. The auto black balance setting is performed.
- When the auto black balance is completed, the auto warning indicator first blinks and then goes off. If the indicator remains lit, repeat the above procedure for setting the auto black balance (ABC).

7-2. Manual Black Balance Control Setting(MANU)

- Move the cursor to the BLACK BAL parameter and select MANU.

```

** SET UP **

CAMERA ID      *OFF
FLD/FRM        FLD
ELC             *OFF
SHUTTER        OFF
GAIN           AUTO
SYNC           INT
BLACK BAL      *MANU
SCENE FILE     *SCENE1

END

```

2. Press the PAGE button. The BLACK BAL menu (manual black balance setting menu) appears.

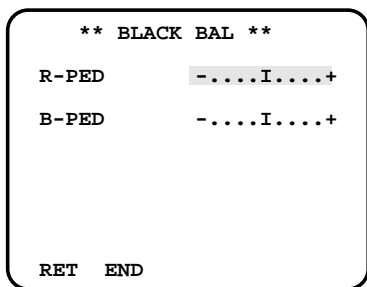

3. Move the cursor to R-PED. The cursor starts blinking.
4. Attach the lens cap on the camera lens.
5. While observing the vector scope or waveform monitor, adjust the red pedestal level (R-PED) for minimum carrier by pressing ◀ or ▶.
6. Move the cursor to B-PED. The cursor starts blinking.
7. While observing the vector scope or waveform monitor, adjust the blue pedestal level (B-PED) for minimum carrier by pressing ◀ or ▶.

Note: To reset the pedestal level to the factory setting, move the cursor to R-PED or B-PED and press the ◀ and ▶ button simultaneously for a second or more. The R-PED or B-PED level value reset to the factory setting.

8. Scene File Setting (SCENE FILE)

This menu allows for you to adjust and set 16 items for the video signal of the camera to meet your requirements.

You can store two sets of values in two different scene files.

Use the Scene File Selector on the front panel of the camera control unit to select SCENE FILE 1 or SCENE FILE 2.

1. Move the cursor to the SCENE FILE parameter and select SCENE 1.

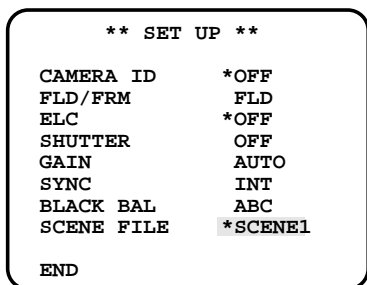

2. Press the PAGE button. The SCENE FILE menu appears.

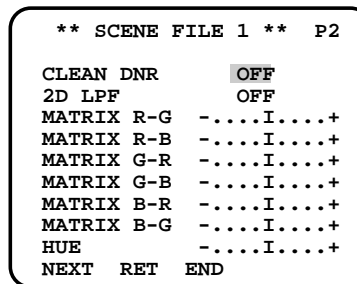
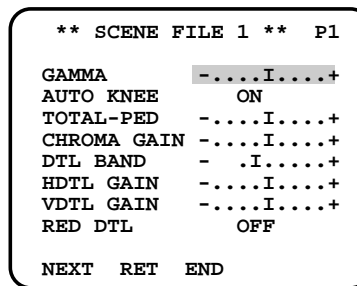

There are 2 pages for SCENE FILE (P1 and P2). On page 1 (P1), you can set the following items:

- Gamma Correction (GAMMA)
- Auto Knee ON/OFF (AUTO KNEE)
- Total Pedestal Level Control (TOTAL-PED)
- Chrominance Level Control (CHROMA GAIN)
- Detail Band Control (DTL BAND)
- Horizontal Detail Gain Control (HDTL GAIN)
- Vertical Detail Gain Control (VDHL GAIN)

On page 2 (P2), you can set the following items:

- Red Detail ON/OFF (RED DTL)
- Clear Digital Noise Reduction Control (CLEAN DNR)
- 2 Dimension Low Pass Filter (2D LPF)
- 6 Chroma Matrix Controls (MATRIX R-G), (MATRIX R-B), (MATRIX G-R), (MATRIX G-B), (MATRIX B-R), (MATRIX B-G)
- Chroma Phase Control (HUE)

To turn the page

Move the cursor to NEXT and press the PAGE button.

Returning to the SETUP menu

Move the cursor to RET and press the PAGE button.

8-1. Gamma Correction (GAMMA)

1. Move the cursor to the GAMMA parameter. The "I" cursor starts blinking.
2. While observing the waveform monitor or the color video monitor, adjust the gamma level.
When the "I" cursor is at the end of the "+" side, gamma correction is set to OFF.
When the "I" cursor is at the end of the "-" side, black stretch (BLACK STRET) is set.

8-2. Auto Knee ON/OFF (AUTO KNEE)

1. Move the cursor to the AUTO KNEE parameter.
2. Select ON or OFF for the auto knee mode.

8-3. Total Pedestal Level Control (TOTAL-PED)

1. Move the cursor to the TOTAL-PED parameter. The "I" cursor starts blinking.
2. While observing the waveform monitor or the color video monitor, adjust the total pedestal level (black level).
Move the "I" cursor to the "+" side to make the image brighter.
Move the "I" cursor to the "-" side to make the image darker.

8-4. Chrominance Level Control (CHROMA GAIN)

1. Move the cursor to the CHROMA GAIN parameter. The "I" cursor starts blinking.
2. While observing the waveform monitor or the color video monitor, adjust the chroma level.

8-5. Detail Band Control (DTL BAND)

1. Move the cursor to the DTL BAND parameter. The "I" cursor starts blinking.
2. While observing the color video monitor, adjust the aperture level.
Move the "I" cursor to the "+" side to raise the frequency.
Move the "I" cursor to the "-" side to lower the frequency.

8-6. Horizontal Detail Gain Control (HDTL GAIN)

1. Move the cursor to the HDTL GAIN parameter. The "I" cursor starts blinking.
2. While observing the color video monitor, adjust the aperture level.
Move the "I" cursor to the "+" side to make the image sharper.
Move the "I" cursor to the "-" side to make the image softer.
When the "I" cursor is at the end of the "-" side, the horizontal detail level is set to OFF.

8-7. Vertical Detail Gain Control (VDTL GAIN)

1. Move the cursor to the VDTL GAIN parameter. The "I" cursor starts blinking.
2. While observing the color video monitor, adjust the aperture level.
Move the "I" cursor to the "+" side to make the image sharper.
Move the "I" cursor to the "-" side to make the image softer.
When the "I" cursor is at the end of the "-" side, the vertical detail level is set to OFF.

8-8. Red Detail ON/OFF (RED DTL)

1. Move the cursor to the RED DTL parameter.
2. Select ON or OFF for the RED DTL mode.
When ON is selected, the red detail is enhanced.

8-9. Clear Digital Noise Reduction Control (CLEAN DNR)

1. Move the cursor to the CLEAN DNR parameter.
2. Select OFF, LOW or HI for the CLEAN DNR mode.

8-10. 2 Dimension Low Pass Filter (2D LPF)

1. Move the cursor to the 2D LPF parameter.
2. Select ON or OFF for the 2D LPF mode.

8-11. 6 Chroma Matrix Controls

(MATRIX R-G)
(MATRIX R-B)
(MATRIX G-R)
(MATRIX G-B)
(MATRIX B-R)
(MATRIX B-G)

1. Move the cursor to the desired matrix item. The "I" cursor starts blinking.
2. While observing the vectorscope or the color video monitor, adjust the matrix level.

8-12. Chroma Phase Control (HUE)

1. Move the cursor to the HUE parameter. The "I" cursor starts blinking.
2. While observing the vectorscope or the color video monitor, adjust the chroma phase (hue).

To reset to the factory setting

Any of the above settings except AUTO KNEE, RED DTL, CLEAN DNR and 2D LPF, can be reset to the factory settings.

Move the cursor to the desired item and press ◀ and ▶ simultaneously for a second and more.

PREVENTION OF BLOOMING AND SMEAR

When the camera is aimed towards spotlights or other bright lights or light reflecting objects, smear or blooming may appear.

Therefore the camera should be operated carefully in the vicinity of extremely bright objects to avoid smear or blooming.

If the camera is aimed at the sun or very bright light, such as laser beam, for a long period of time, the CCD image sensor may be burned in and blemishes (white or black dots) appears on the monitor screen

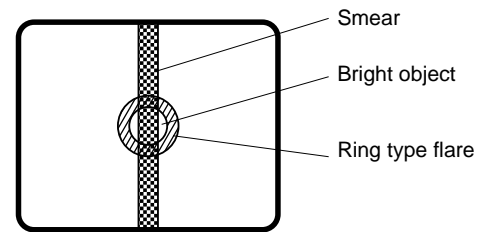

SPECIFICATIONS

Pick-up System:	Micro prism system
Image Sensor:	Three 1/2" interline transfer (IT) super high sensitivity CCDs (GP-US522) Three 1/3" interline transfer (IT) super high sensitivity CCDs (GP-US532)
Pixels:	768 (Horizontal) x 494 (Vertical)
Scanning Standard:	525 lines, 60 fields, 30 frames
Synchronizing System:	Internal or External (Gen-Lock), automatically switchable
Internal:	EIA standard
	External (Gen-Lock) Input: VBS/VS/HD/VD is selectable SC Phase for Gen-Lock (VBS): Free adjustable over 360° H Phase for Gen-Lock (VS): Adjustable
Video Outputs:	Video Output: BNC Connector x 2 1.0V[p-p] NTSC composite/75 Ω Y/C (S-VIDEO) Output: S-VIDEO Connector x 1 0.714V[p-p] Luminance level (Y)/75 Ω (S-VIDEO connector) 0.286V[p-p] Burst Level (C)/75 Ω (S-VIDEO connector) RGB/SYNC Output: D-SUB 9-pin Connector x 1 R/G/B: 0.7V[p-p] each/75 Ω SYNC: 4V[p-p]/75 Ω or 0.3V[p-p]/75 Ω selectable VIDEO: NTSC composite/75 Ω
Required Illumination:	2000 lx at F11.0, 3200 K (GP-US522) 2000 lx at F8.0, 3200 K (GP-US532)
Minimum Illumination:	5 lx (0.5 foot candle) at F2.8 with +18 dB gain, 30 IRE level (GP-US522) 9 lx (0.9 foot candle) at F2.2 with +18 dB gain, 30 IRE level (GP-US532)
Signal-to-Noise Ratio:	62 dB (Typical, Luminance) without aperture and gamma
Horizontal Resolution:	800 lines at center (Y signal) (GP-US522) 750 lines at center (Y signal) (GP-US532)
White Balance:	ATW (Automatic Tracing White Balance Control), AWC (Automatic White Balance Control) and Manual
Black Balance:	ABC (Automatic Black Balance) and Manual
Color Bar:	SMPTE color bar with 7.5% set-up
Electronic Shutter:	AUTO: Adjustable between 1/60 - 1/10 000s STEP: Selectable 1/60(OFF), 1/100, 1/250, 1/500, 1/1 000, 1/2 000, 1/4 000 and 1/10 000s SYNCHRO SCAN: Selectable from 1/525 to 254/525 line
Gain Selection:	AGC and Gain Up (Selectable)
Switches:	Power On/Off (POWER), Camera/Color Bar Selection (CAM/BAR), Gain Up Selection (OFF/LOW/HIGH (0/+9/+18 dB)), White Balance Selection (ATW/AWC/MANU), ELC (Electronic Light Control) On/Off, PAGE, ITEM (AWC), ◀ (ABC) and ▶
Controls:	R Gain, B Gain and ELC LEVEL
Computer Interface:	RS-232C : D-SUB 9-pin Connector x 1
Lens Mount:	Special C Mount (GP-US522) C Mount (GP-US532)
Power Source:	12 V DC
Power Consumption:	8.4 W
Ambient Operating Temperature:	32°F - 113°F (0°C - +45°C)
Ambient Operating Humidity:	30 % - 90 %
Dimensions	
Camera Head:	34 (W) x 44 (H) x 52 (D) mm
(Excluding Mounting Adaptor)	[1-5/16" (W) x 1-11/16" (H) x 2" (D)]
CCU:	206.5 (W) x 44 (H) x 250 (D) mm
(Excluding Rubber Foot and Connector)	[8-1/8" (W) x 1-11/16" (H) x 9-1/2" (D)]
Weights	
Camera Head:	110 g (0.24 lbs)
CCU:	1.7 kg (3.74 lbs)

Dimensions and Weights indicated are approximate
Specifications are subject to change without notice

OPTIONAL ACCESSORIES

Camera Cable GP-CA522/4
Character Generators WJ-KB30, WJ-KB50

Panasonic Security & Digital Imaging Company A Division of Matsushita Electric Corporation of America Industrial / Medical Group

Executive Office: One Panasonic Way 3E-7, Secaucus, New Jersey 07094
TEL: (201) 392-6674 / FAX: (201) 348-5346

Regional Office

Northeast: 43 Hartz Way, Secaucus, NJ 07094 (201) 348-7303
Southern: 1225 Northbrook Parkway, Suite 1-160, Suwanee, GA 30124 (770) 338-6838
Midwest: 1707 North Randall Road, Elgin, IL 60123 (847) 468-5200
Southwest: 8105 Beitsline Road, Suite 100, Irving, TX 75063 (214) 915-1333
Western: 6550 Katella Ave., Cypress, CA 90630 (714) 373-7265

Panasonic Canada Inc.

5770 Ambler Drive, Mississauga,
Ontario, L4W 2T3 Canada (905)624-5010

Panasonic Sales Company Division of Matsushita Electric of Puerto Rico Inc.

Ave. 65 de Infanteria. Km. 9.5
San Gabriel Industrial Park, Carolina,
Puerto Rico 00985 (809)750-4300

Free Manuals Download Website

<http://myh66.com>

<http://usermanuals.us>

<http://www.somanuals.com>

<http://www.4manuals.cc>

<http://www.manual-lib.com>

<http://www.404manual.com>

<http://www.luxmanual.com>

<http://aubethermostatmanual.com>

Golf course search by state

<http://golfingnear.com>

Email search by domain

<http://emailbydomain.com>

Auto manuals search

<http://auto.somanuals.com>

TV manuals search

<http://tv.somanuals.com>