

Panasonic

4 Channel Power Amplifier

Model: **CY-PA4003W**

2 Channel Power Amplifier

Model: **CY-PA2003W**

Digital Mono Amplifier

Model: **CY-PAD1003W**



(CY-PA4003W)

Operating Instructions



- Please read these instructions carefully before using this product and keep this manual for future reference.

Safety Information

- Read the operating instructions for the unit and all other components of your car audio system carefully before using the system. They contain instructions about how to use the system in a safe and effective manner. Panasonic assumes no responsibility for any problems resulting from failure to observe the instructions given in this manual.



Warning

This pictograph intends to alert you to the presence of important operating instructions. Failure to heed the instructions may result in severe injury or death.

- This manual uses pictographs to show you how to use the product safely and to alert you to potential dangers resulting from improper connections and operations. The meaning of the pictographs are explained below. It is important that you fully understand the meanings of the pictographs in order to use this manual and the system properly.



Caution

This pictograph intends to alert you to the presence of important operating instructions. Failure to heed the instructions may result in injury or material damage.

Please follow the laws and regulations of your province or country for installation of the unit.

This unit cannot be used alone. This unit is a power amplifier for use with Panasonic car audio products and speakers. For more details about safety information, refer to the operating instructions for the connected devices.

For power connection, use the optional power cord specially designed for use with Panasonic car-audio/AV system. Power cord kit (option): CA-PAC75



Warning

Observe the following warnings when using the unit.

- Use the proper power supply.**
This product is designed for operation with a negative grounded 12 V DC battery system. Never operate this product with other battery system, especially a 24 V DC battery system.
- Do not disassemble or modify the unit.**
Do not disassemble, modify the unit or attempt to repair the product yourself. If the product needs to be repaired, consult your dealer or an authorised Panasonic Service Center.
- Do not use the unit when it is out of order.**
If the unit is out of order (no power, no sound) or in an abnormal state (has foreign objects in it, is exposed to water, is smoking, or smells), turn it off immediately and consult your dealer.
- Refer fuse replacement to qualified service personnel.**
When the fuse blows out, eliminate the cause and have it replaced with the fuse prescribed for this unit by a qualified service engineer. Incorrect replacement of the fuse may lead to smoke, fire, and damage to the product.
- When replacing one fuse which has blown, replace other fuses at the same time.**
In some cases, fuses may deteriorate without failing. Using different substitutes or fuses with higher ratings, or connecting the unit directly without a fuse, could cause fire or damage to the unit. If the replacement fuse fails, contact your nearest Panasonic Service Center for service.



Warning

Observe the following warnings when installing.

- Disconnect the lead from the negative (–) battery terminal before installation.**
Wiring and installation with the negative (–) battery terminal connected may cause electrical shock and injury due to a short circuit. Some cars equipped with the electrical safety system have specific procedures of battery terminal disconnection.
- FAILURE TO FOLLOW THE PROCEDURE MAY LEAD TO THE UNINTENDED ACTIVATION OF THE ELECTRICAL SAFETY SYSTEM RESULTING IN DAMAGE TO THE VEHICLE AND PERSONAL INJURY OR DEATH.**
- Never use safety-related components for installation, grounding, and other such functions.**
Do not use safety-related vehicle components (fuel tank, brake, suspension, steering wheel, pedals, airbags, etc.) for wiring or fixing the product or its accessories.
- Check for piping, gasoline tank, electric wiring, and other items before installing the product.**
If you need to open a hole in the vehicle chassis to attach or wire the product, first check where the wire harness, gasoline tank, and electric wiring are located. Then open the hole from outside if possible.
- After installation and wiring, you should check the normal operation of other electrical equipment.**
The continuation of their using in abnormal conditions may cause fire, electrical shock or a traffic accident.
- In the case of installation to an airbag-equipped car, confirm warnings and cautions of the vehicle manufacturer before installation.**
- Make sure the leads do not interfere with driving or getting in and out of the vehicle.**
Failure to heed this caution may result in an accident and/or injury.



Caution

Observe the following cautions when using this unit.

- Turn off the power supply before changing the switch setting.**
- Keep the sound volume at an appropriate level.**
Keep the volume level low enough to be aware of road and traffic conditions while driving.
- This unit is designed for use exclusively in automobiles.**
- Do not operate the unit for a prolonged period with the engine turned off.**
Operating the audio system for a long period of time with the engine turned off will drain the battery.
- Do not expose the unit to direct sunlight or excessive heat.**
Otherwise these will raise the interior temperature of the unit, and it may lead to smoke, fire, or other damage to the unit.
- Do not use the product where it will be exposed to water, moisture, or dust.**
Exposure of the unit to water, moisture, or dust may lead to smoke, fire, or other damage to the unit. Make especially sure that the unit does not get wet in car washes or on rainy days.
- Stop to use the unit when the red indicator (PROTECT) lights up.**
If the red indicator lights up, this unit will automatically shut down. Confirm the speaker and other audio system's wiring.
- Do not touch the heat dissipation region of the amplifier.**
If this unit is operated at a high output continuously, the upper side of the unit will get very hot. Do not touch it nor place anything on top of the unit.
- Contact your local dealer for information about battery capacity. (If there is not enough battery capacity, increase the number of batteries.)**
Depending on the way you use this unit, (using at high volume for extended periods, increasing the number of amplifiers etc.) there may be insufficient battery capacity. There is a danger that the battery will run flat, or other electronic parts may stop operating.
- Do not knock anything against this unit when loading or unloading objects from the trunk.**
Doing so will cause damage to this unit.

Caution

Observe the following cautions when installing.

Refer wiring and installation to qualified service personnel.

Installation of this unit requires special skills and experience. For maximum safety, have it installed by your dealer. Panasonic is not liable for any problems resulting from your own installation of the unit.

Follow the instructions to install and wire the product.

Not following the instructions to properly install and wire the product could cause an accident or fire.

Take care not to damage the leads.

Prevent them from getting caught in the vehicle chassis, screws, and moving parts such as seat rails. Do not scratch, pull, bend or twist the leads. Do not run them near heat sources or place heavy objects on them. If leads must be run over sharp metal edges, protect the leads by winding them with vinyl tape or similar protection.

Use the designated parts and tools for installation.

Use the supplied or designated parts and appropriate tools to install the product. The use of parts other than those supplied or designated may result in internal damage to the unit. Faulty installation may lead to an accident, a malfunction or fire.

Do not install the product where it is exposed to strong vibrations or is unstable.

Avoid slanted or strongly curved surfaces for installation. If the installation is not stable, the unit may fall down while driving and this can lead to an accident or injury.

We strongly recommended you to wear gloves for installation work to protect yourself from injuries.

Failure to heed this caution may result in an accident and/or injury.

Be sure to grip both sides of this unit securely before attempting to move it.

Since this unit is quite heavy, the unit may fall down and this can lead to an accident or injury.

Cover the unused terminals with insulating tape to prevent them from short circuiting.

When an extension lead is used, it should be as thick and short as possible; connect it firmly with insulating tape.

Wire breaks and short circuits can cause electrical shock or fire.

Use the spacer included when installing the unit so that the fan and air hole on the base side of the unit are not covered. <CY-PAD1003W>

If the fan and air hole on the base side of the unit are covered, the unit will become extremely hot and may fail.

Caution for mounting the unit:

Never mount the unit in any of the following locations to avoid damage due to overheating;

- Near the heater port.
- Places like the dashboard or rear deck, where it may be exposed to direct sunlight.

Do not mount the unit near the door, where it could be exposed to rain.

Keep a safe distance between the unit and other electronic equipment.

When a short circuit occurs, such as in the speaker output terminal, etc. the overload protection circuit will operate. This circuit protects the power amplifier from further damage when a short circuit occurs. Operation will temporarily stop. In this case, check the cause of the short-circuit and if the problem is fixed, normal operation will resume.

Since the power amplifier has a very large output, the unit should be installed in the trunk of your car.

Do not install this unit under a carpet, otherwise the unit may fail because of immature heat dissipation.

In case more than one power amplifier is used, make sure to employ the power cord and the fuse having the current capacity larger than the total current corresponding to the maximum consumption powers of all the amplifiers.

Caution for the power cord (option):

Follow an expert's instruction for the use of the cord separately sold.

For the power, make sure to use the battery lead (yellow) separately sold and specially designed for Panasonic car-audio/AV system, and to connect directly to the car battery. Use the cord having the fuse capacity larger than that of this unit. Connect the power cord and other cords corresponding to the power supply after all the connections to the speaker are completed.

Keep the battery lead (yellow) away from the speaker cord.

Make sure to use the ground lead (black) separately sold and specially designed for car audio system, and to connect it to the metal portion of the car chassis.

Wire the battery lead (yellow), the ground lead (black), the speaker cords, and this unit with as much distance as possible from the antenna, the antenna cords and the car stereo (car radio).

If the ground wire is common to both left/right and front/rear speaker wirings, this unit cannot be used. Always use the independent lead wire for the speakers to be used. In this case, redo the wiring.

Caution for the speaker cord (option):

The speaker cords and the power amplifier unit should be kept away from the antenna and antenna extension cord.

Do not directly ground the speaker cords; do not share the negative leads of multiple speakers.

When using the RCA cords, keep away from the speaker cords.

Caution for the speaker (option):

Use speakers with a suitable maximum input.

In case of 4-channel/3-channel connection <CY-PA4003W>:

Use speakers with the impedance of 2–8 Ω.

In case of 2-channel/stereo connection:

Use speakers with the impedance of 4–8 Ω.

Before Reading These Instructions

Panasonic welcomes you to our constantly growing family of electronic products owners. We endeavor to give you the advantages of precise electronic and mechanical engineering, manufactured with carefully selected components, and assembled by people who are proud of the reputation their work has built for our company. We know this product will bring you many hours of enjoyments, and after you discover the quality, value and reliability we have built into it, you too will be proud to be a member of our family.

CY-PA4003W 4 Channel Power Amplifier

CY-PA2003W 2 Channel Power Amplifier

CY-PAD1003W Digital Mono Amplifier

Differences among 3 Models

This Operating instruction manual is for 3 models CY-PA4003W, CY-PA2003W and CY-PAD1003W. All illustrations throughout this manual represent model CY-PA4003W unless otherwise specified. The following table describes the differences among 3 models.

Features	Models	CY-PA4003W	CY-PA2003W	CY-PAD1003W
Speaker connection		4/3/2-channel speaker	2/1-channel speaker	1-channel speaker
Maximum power output		250 W×4 channel	600 W×2 channel	1 100 W×1 channel
Input channel		4-channel	2-channel	2-channel
4CH/2CH input selection		Yes	No	No
HPF (High Pass Filter)		Yes	Yes	No
Subsonic filter switch		No	No	Yes
Fuse		35 A×2	25 A×3	25 A×3
Speaker input connector		2 (1 for front speaker, 1 for rear speaker)	1 (for left/right speaker)	1 (for left/right speaker)

Accessories

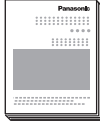
Item	Diagram	Qty.
Operating Instructions (YEFM285832A)		1
Installation Hardware (screws, cords, etc.) (page 20)		

Note:

- The number in parenthesis underneath each accessory part name is the part number for maintenance and service.
- Accessories and their parts numbers are subject to modification without prior notice due to improvements.

Before Use

- Check the connections according to the manual of the device you have connected, and switch on the connected device's power supply.
- Adjust the GAIN to a satisfactory volume. (page 11, 12)
- Refer to individual instruction and installation manuals for each device for detailed installation and wiring.

Contents

English

2

Safety Information	2
Before Reading These Instructions ...	6
Before Use	7
Features	8
Location of Controls	10
Speaker System Setting <CY-PA4003W>	14
Speaker System Setting <CY-PA2003W>	17
Speaker System Setting <CY-PAD1003W>	18
Note for Bridge Speaker Connection	19
Installation	20
Wiring	22
Wiring <CY-PA4003W>	24
RCA	24
SPEAKERS INPUT	25
Wiring <CY-PA2003W>	26
RCA	26
SPEAKERS INPUT	27
Wiring <CY-PAD1003W>	28
RCA	28
SPEAKERS INPUT	29
Troubleshooting	30
Maintenance	32
Specifications	32

Features

CY-PA4003W

250 W × 4 channel maximum power output

Total 1 000 W maximum power output

An amplifier connected to the 4-, 3- or 2-channel speaker

2CH/4CH input selection:

The 4-channel speaker output is available under the 2-channel speaker input setting.

Low-Pass Filter for subwoofer, High Pass Filter:

Switchover of LPF/OFF/HPF is available.

CY-PA2003W

600 W × 2 channel maximum power output

Total 1 200 W maximum power output

Low-Pass Filter for subwoofer, High Pass Filter:

Switchover of LPF/OFF/HPF is available.

CY-PAD1003W

1 100 W × 1 channel maximum power output

Low-Pass Filter for subwoofer:

Switchover of LPF/OFF is available.

<Common features of 3 models>

High Level Speaker Input connection:

The high-quality playback sound is produced when connecting the unit to the speaker output lead of the Head Unit.

Use it when the Head Unit is not equipped with the terminal for the RCA output lead.

Bass boost control system:

The bass boost circuit is employed to play back the deep bass on the front and rear speakers.

Crossover Frequency Control:

The frequency band in the treble and the bass, which are played back on the front and rear speakers, can be adjusted.

RCA output terminals:

Equipped with RCA output for adding a power amplifier.

5.1-channel Surround System (Combination with other Panasonic car audio products)

You can enjoy a powerful 5.1-channel surround system by connecting Head Unit (CQ-VD7003W, CQ-VD6503W, option), 4-channel amplifier (CY-PA4003W) and monaural amplifier for subwoofer (CY-PAD1003W).

For more details, refer to the operating instructions for the connected devices.

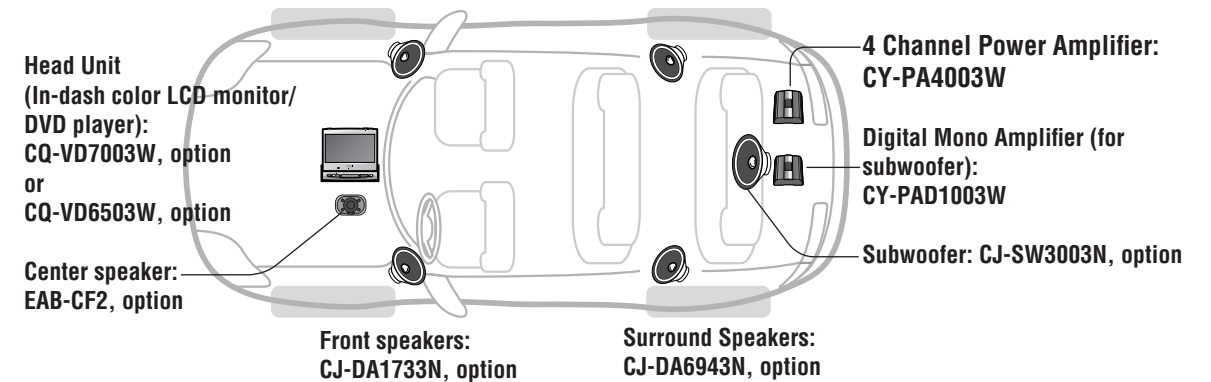

Location of Controls

<CY-PA4003W>

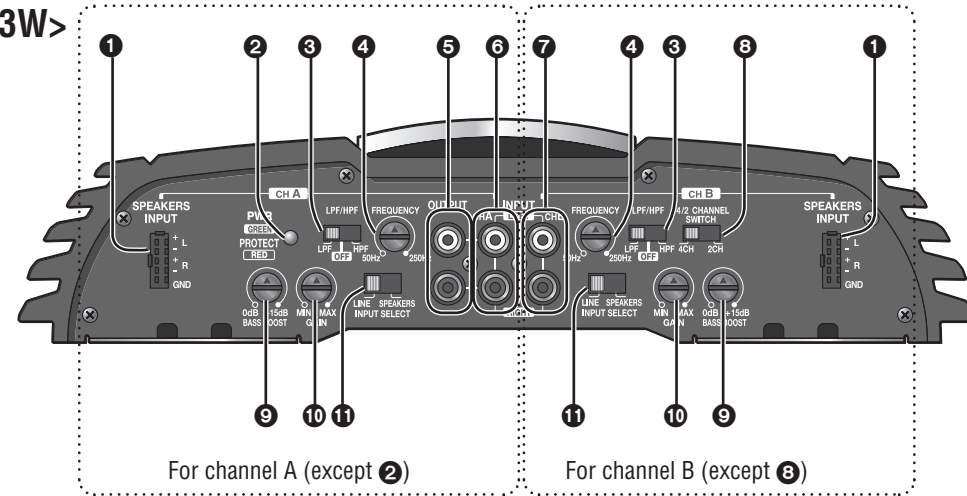

⚠ Caution

- Turn off the power supply before changing the switch setting.
- Stop to use the unit when the red indicator (PROTECT) lights up.

If the red indicator lights up, this unit will automatically shut down. Confirm the speaker and other audio system's wiring.

1 High level speaker input terminal (SPEAKERS INPUT)

When connecting Head Unit without RCA output terminals.

2 Power/protection indicator (PWR/PROTECT)

Lights green: When the Head Unit power is on.
Lights red:

- When the speaker cords are short-circuited.
- When the speaker output line comes contact with the car grounding wire.
- When this unit fails and the speaker output generates a DC power source.
- When the amplifier internally creates a high-pitched sound.
- When the connection of the Head Unit or this unit is not completed.

3 Crossover filter switch (LPF, OFF, HPF)

LPF (Low Pass Filter): LPF cuts off the treble, and outputs only a low-pitched sound for the subwoofer.
OFF: All frequency bands are output without filtering. Select when a subwoofer is not connected.
HPF (High Pass Filter): Sound is output from the speakers for a high-pitched sound and midrange sound after deleting the low-pitched sound.

4 Crossover frequency control knob (FREQUENCY)

The frequency band of the treble and the bass played back on the front and rear speakers is adjusted.
Setting range: 50 Hz to 250 Hz

5 Speaker output terminals (For CH A)

Equipped with RCA output for adding a power amplifier.
It is not a Speaker input terminal.

6 Channel A input terminals (LEFT, RIGHT)

7 Channel B input terminals (LEFT, RIGHT)

8 Speaker channel select switch (4CH, 2CH)

4CH: When connecting Head Unit with 2 preout leads.
2CH: When connecting Head Unit with 1 preout lead.

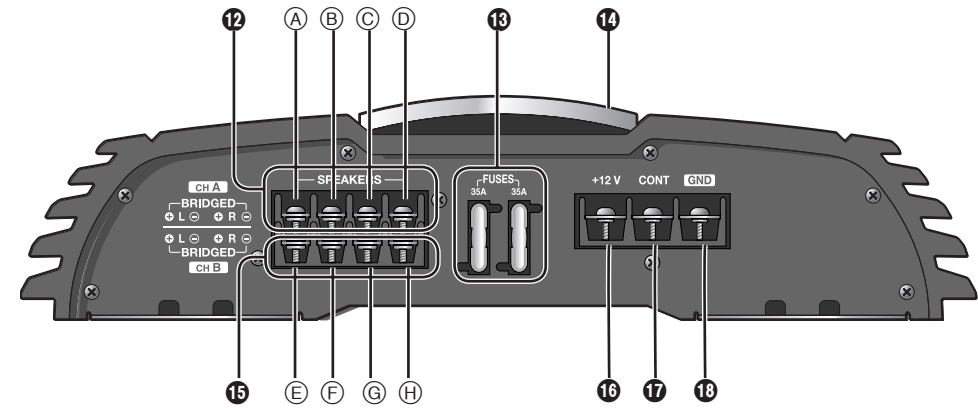

9 BASS BOOST control knob

Turn this knob to boost the 45 Hz frequency sound. It enhances the low-pitched sound.
For some speakers, the sound may be distorted because of the excessive power input to them. In that case, turn down the bass level until the distortion stops.
Setting range: 0 dB to 15 dB

10 GAIN control knob

In some instances, the acoustical output from each speaker may not be balanced properly depending upon the type of speakers or Head Unit being used.
Up: Turn up the knob when the sound volume is not satisfactory even though the volume of the Head Unit is increased.
Down: Turn down the knob when the sound is distorted.

11 Input select switch (LINE, SPEAKERS)

LINE: When using RCA INPUT connectors.
SPEAKERS: When using SPEAKER INPUT connectors.

12 Channel A speaker output connector (SPEAKERS)

- Ⓐ Left Side (+)
- Ⓑ Left Side (-)
- Ⓒ Right Side (+)
- Ⓓ Right Side (-)

13 Fuses (FUSES) (35 A×2)

14 Upper cover

15 Channel B speaker output connector (SPEAKERS)

- Ⓔ Left Side (+)
- Ⓕ Left Side (-)
- Ⓖ Right Side (+)
- Ⓗ Right Side (-)

16 Battery connector (+12 V)

To the car battery, continuous +12 V DC.

17 Amplifier control connector (CONT)

To the head unit's external amplifier control power lead or to the car battery, continuous +12 V DC.

18 Ground connector (GND)

To a clean, bare metallic part of the car chassis.

The upper cover can be reinstalled along with the reinstallation of the main body of the unit, such that the cover is aligned with other devices for neat and better look.

How to dismount:
Unscrew the terminal screw with Allen wrench ③.

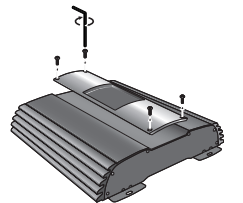

Note:

- Do not insert anything between the upper cover and this unit. Doing so will cause damage to this unit.

Location of Controls (continued)

<CY-PA2003W>

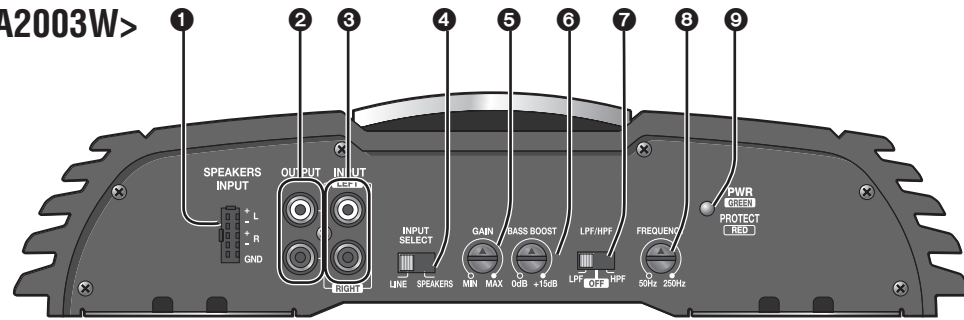

<CY-PAD1003W>

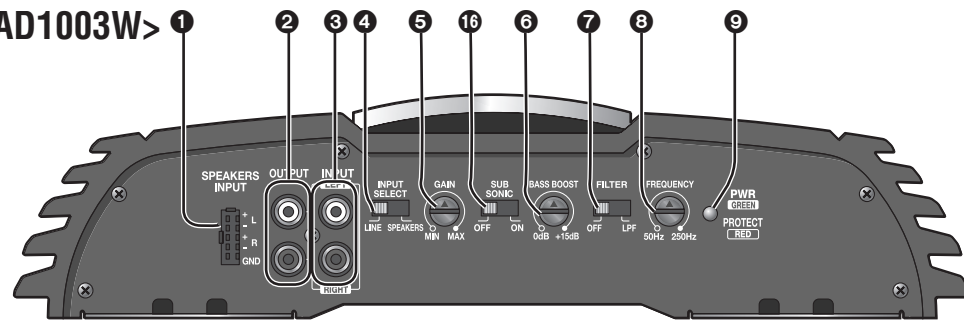

⚠ Caution

- Turn off the power supply before changing the switch setting.
- Stop to use the unit when the red indicator (PROTECT) lights up.
If the red indicator lights up, this unit will automatically shut down. Confirm the speaker and other audio system's wiring.

1 High level speaker input terminal (SPEAKERS INPUT)

When connecting Head Unit without RCA output terminals.

2 Speaker output terminals

Equipped with RCA output for adding a power amplifier.
It is not a Speaker input terminal.

3 Speaker input terminals (LEFT, RIGHT)

4 Input select switch (LINE, SPEAKERS)

LINE: When using RCA INPUT connectors.
SPEAKERS: When using SPEAKER INPUT connectors.

5 GAIN control knob

In some instances, the acoustical output from each speaker may not be balanced properly depending upon the type of speakers or Head Unit being used.
Up: Turn up the knob when the sound volume is not satisfactory even though the volume of the Head Unit is increased.
Down: Turn down the knob when the sound is distorted.

6 BASS BOOST control knob

Turn this knob to boost the 45 Hz frequency sound. It enhances the low-pitched sound.
For some speakers, the sound may be distorted because of the excessive power input to them. In that case, turn down the bass level until the distortion stops.
Setting range: 0 dB to 15 dB

7 Crossover filter switch (LPF, OFF, HPF)

LPF (Low Pass Filter): LPF cuts off the treble, and outputs only a low-pitched sound for the subwoofer. OFF: All frequency bands are output without filtering. Select when a subwoofer is not connected.
<CY-PA2003W>
HPF (High Pass Filter): Sound is output from the speakers for a high-pitched sound and midrange sound after deleting the low-pitched sound.

<CY-PA2003W>

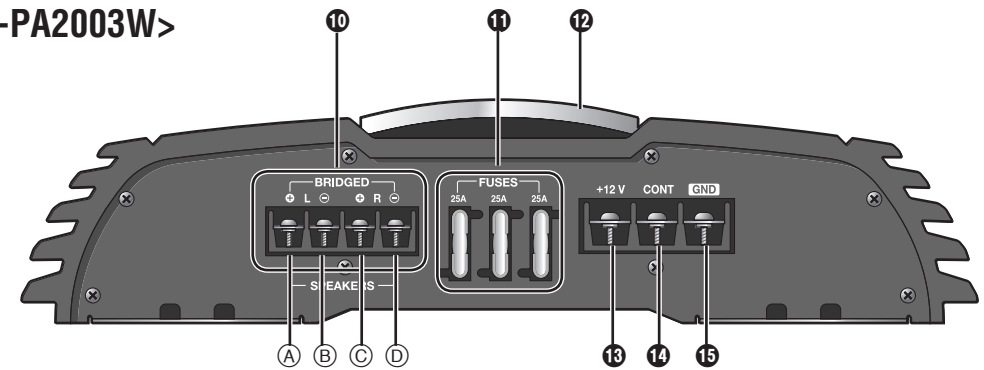

<CY-PAD1003W>

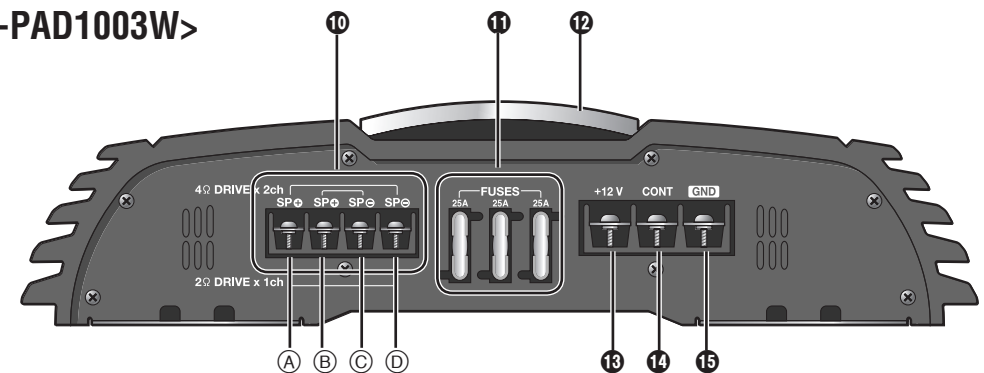

8 Crossover frequency control knob (FREQUENCY)

The frequency band of the treble and the bass played back on the front and rear speakers is adjusted.
Setting range: 50 Hz to 250 Hz

9 Power/protection indicator (PWR/PROTECT)

- Lights green: When the Head Unit power is on.
Lights red:
- When the speaker cords are short-circuited.
 - When the speaker output line comes contact with the car grounding wire.
 - When this unit fails and the speaker SP output generates a DC power source.
 - When the amplifier internally creates a high-pitched sound.
 - When the connection of the Head Unit or this unit is not completed.

10 Speaker output connector

<CY-PA2003W>	<CY-PAD1003W>
(A) Left Side (+)	(A) SP (+)
(B) Left Side (-)	(B) SP (+)
(C) Right Side (+)	(C) SP (-)
(D) Right Side (-)	(D) SP (-)

11 Fuses (FUSES) (25 A×3)

12 Upper cover

13 Battery connector (+12 V)

To the car battery, continuous +12 V DC.

14 Amplifier control connector (CONT)

To the head unit's external amplifier control power lead or to the car battery, continuous +12 V DC.

15 Ground connector (GND)

To a clean, bare metallic part of the car chassis.

16 <CY-PAD1003W>

Subsonic filter switch (OFF, ON)
Switch ON to remove noise from subwoofer.

The upper cover can be reinstalled along with the reinstallation of the main body of the unit, such that the cover is aligned with other devices for neat and better look.

How to dismount:
Unscrew the terminal screw with Allen wrench ③.

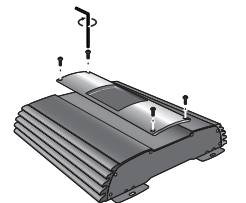

Note:

- Do not insert anything between the upper cover and this unit. Doing so will cause damage to this unit.

Speaker System Setting <CY-PA4003W>

4CH Input

4-channel Speaker System

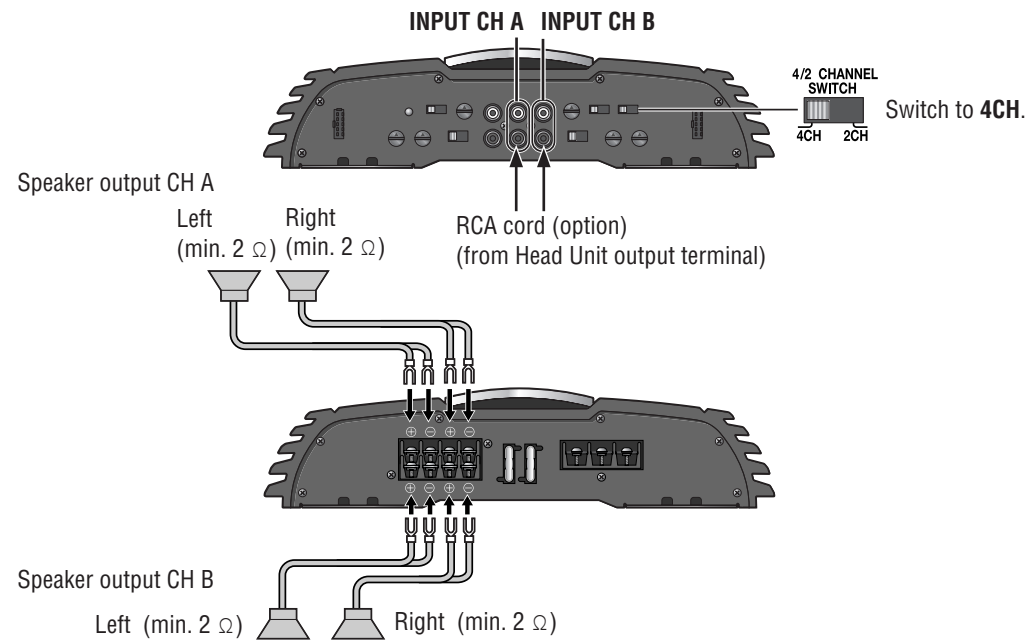

3-channel Speaker System

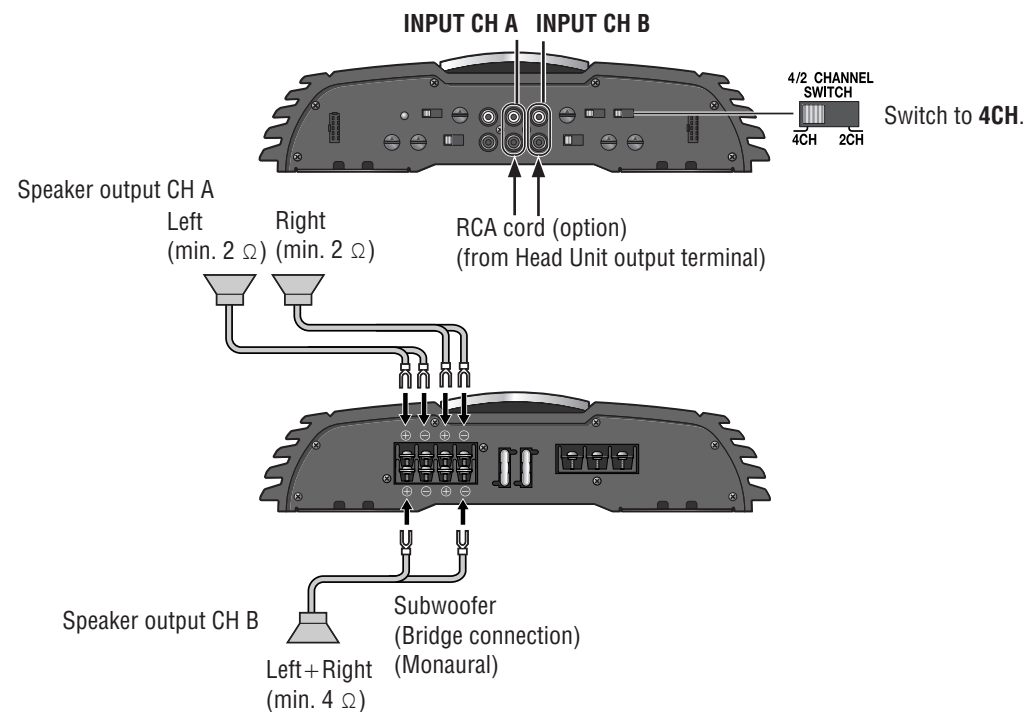

2-channel Speaker System (Monaural)

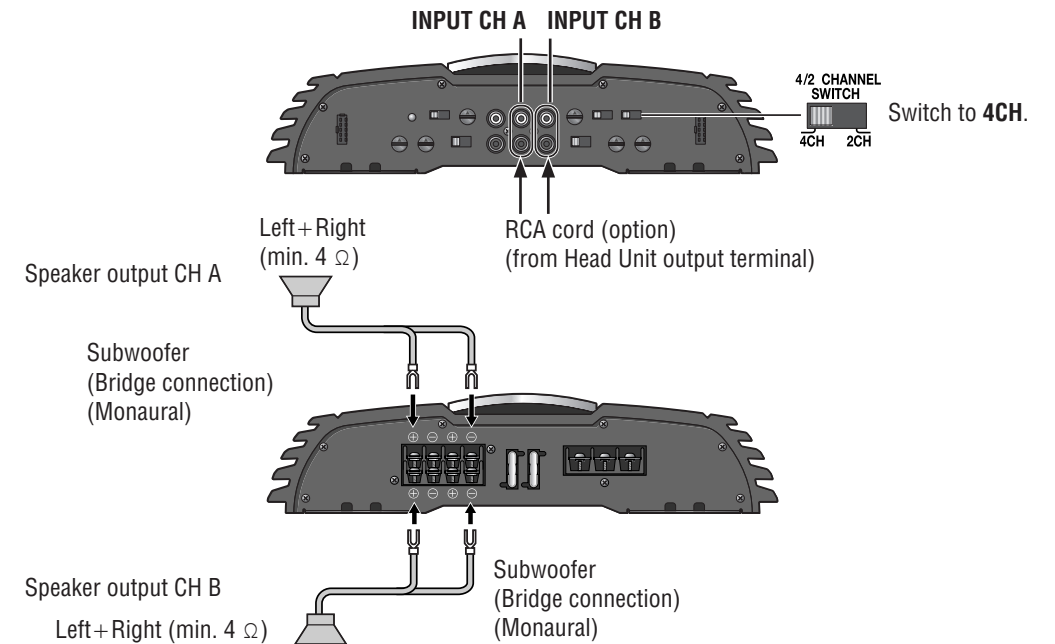

2-channel Speaker System (Stereo)

Special Application

Example: Connecting left channel audio output to CH A and right channel audio output to CH B.

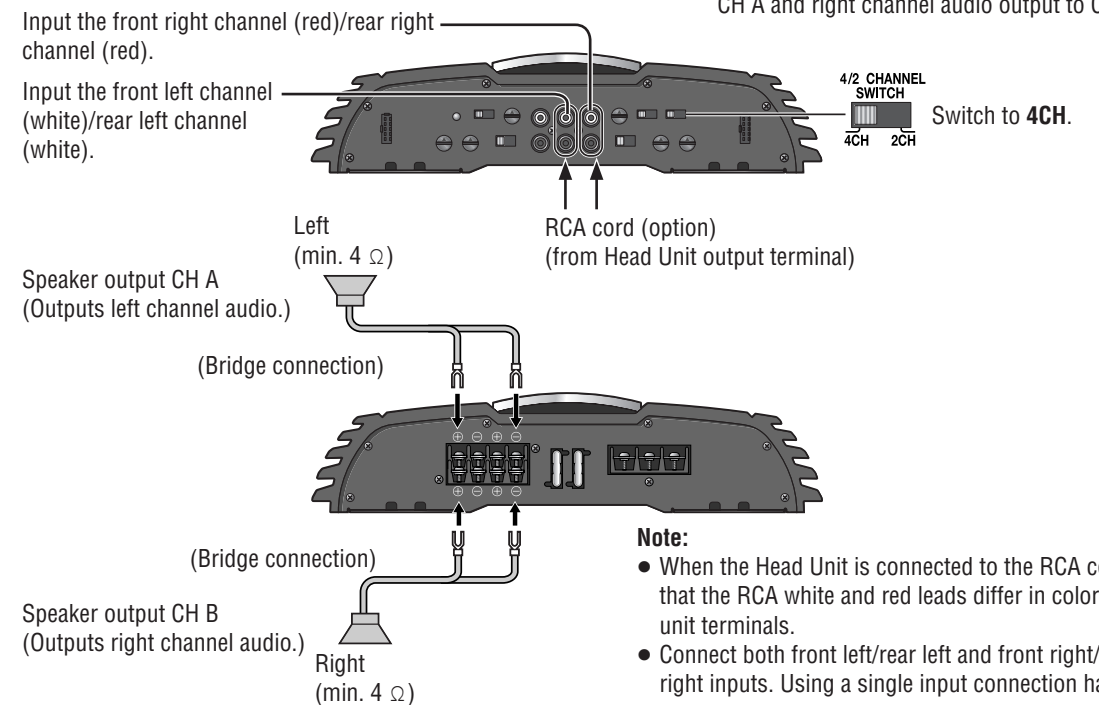

Note:

- When the Head Unit is connected to the RCA cord, note that the RCA white and red leads differ in color from the unit terminals.
- Connect both front left/rear left and front right/rear right inputs. Using a single input connection halves the output.

Speaker System Setting <CY-PA4003W> (continued)

2CH Input

4-channel Speaker System

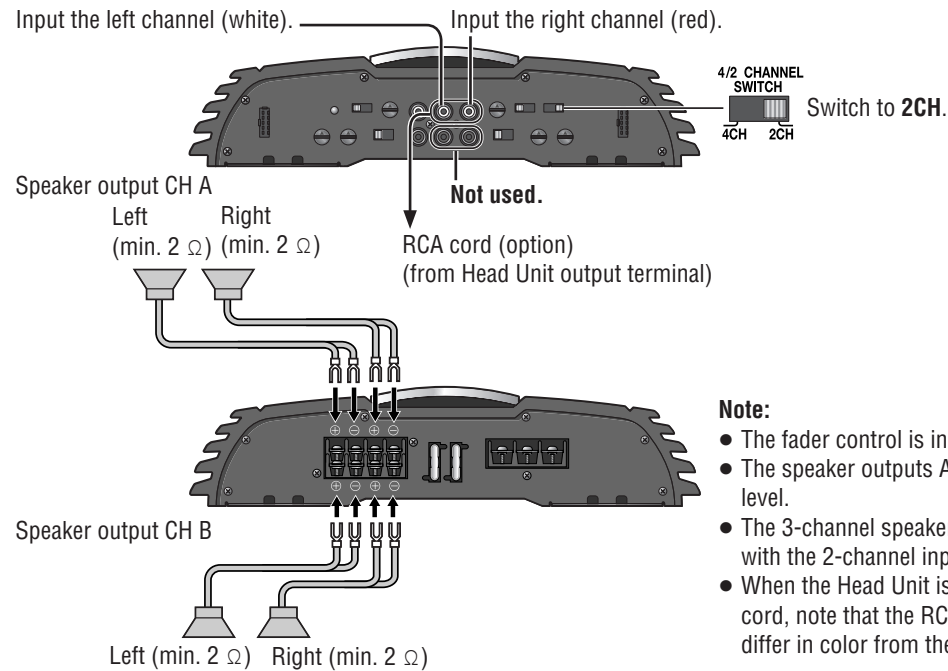

Special Application

Example: If the Head Unit only has a single pre-out, connect it to this unit for 4-channel audio output.

Note:

- The fader control is ineffective.
- The speaker outputs A and B are at the same level.
- The 3-channel speaker output is not allowed with the 2-channel input connection.
- When the Head Unit is connected to the RCA cord, note that the RCA white and red leads differ in color from the unit terminals.

2-channel Speaker System

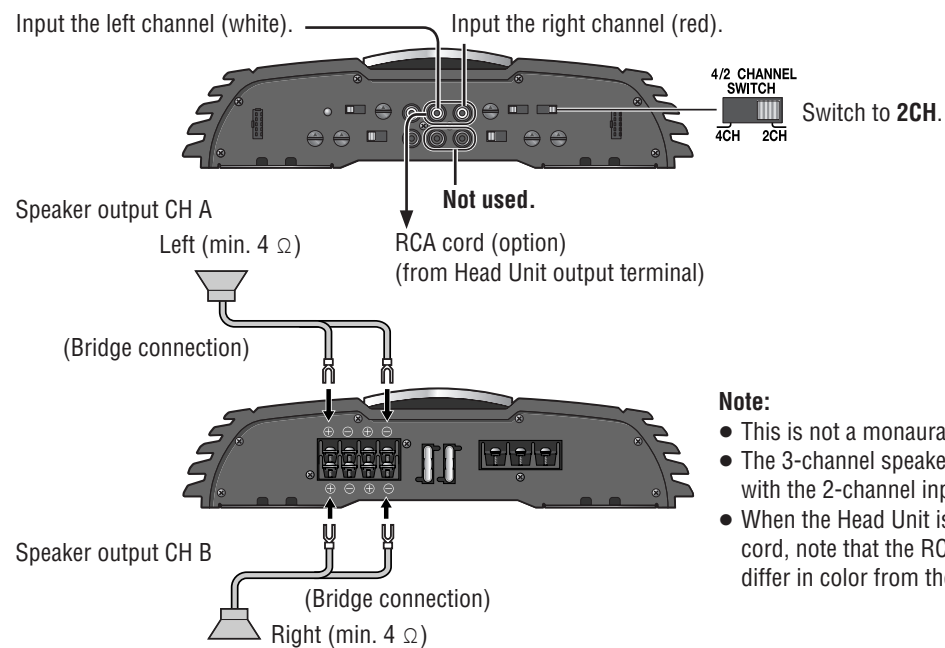

Special Application

Example: If the Head Unit only has a single pre-out, connect it to this unit for 2-channel audio output.

Note:

- This is not a monaural output.
- The 3-channel speaker output is not allowed with the 2-channel input connection.
- When the Head Unit is connected to the RCA cord, note that the RCA white and red leads differ in color from the unit terminals.

Speaker System Setting <CY-PA2003W>

2-channel Speaker System (Stereo)

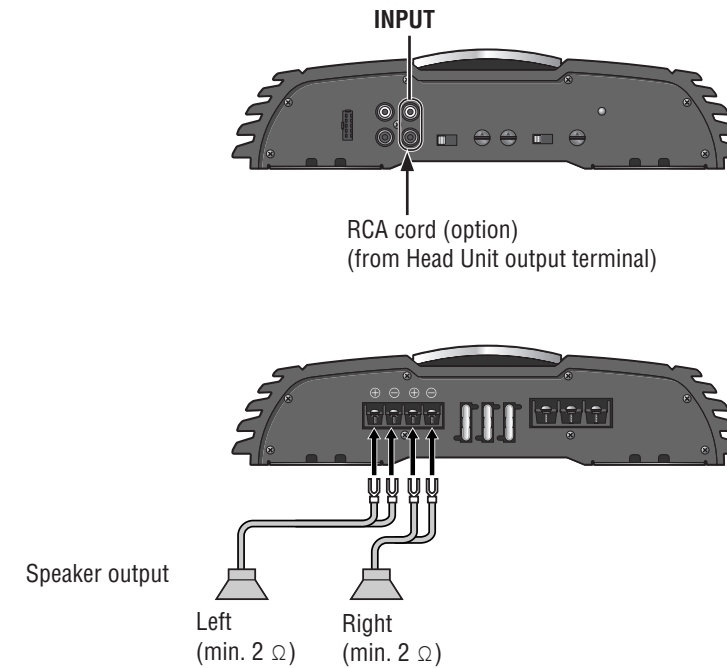

1-channel Speaker System (Monaural)

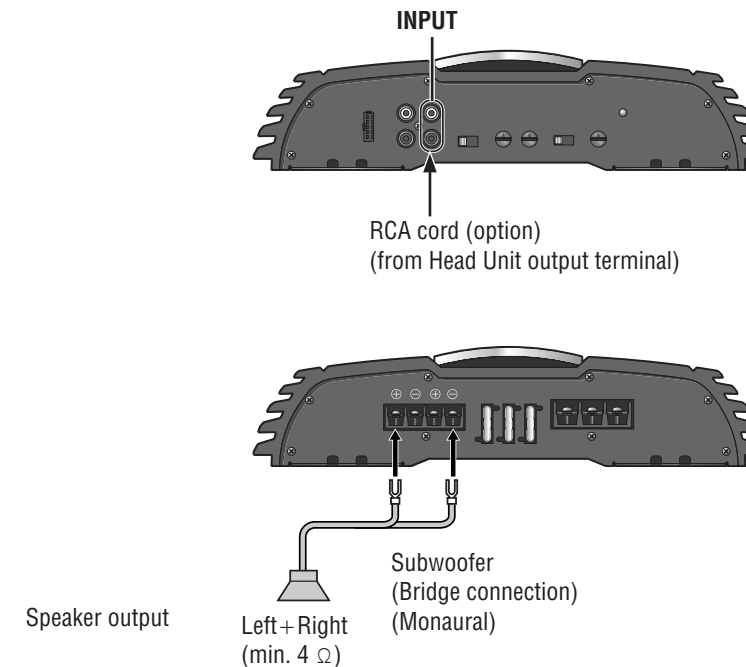

Speaker System Setting <CY-PAD1003W>

2-channel (Monaural) Speaker System

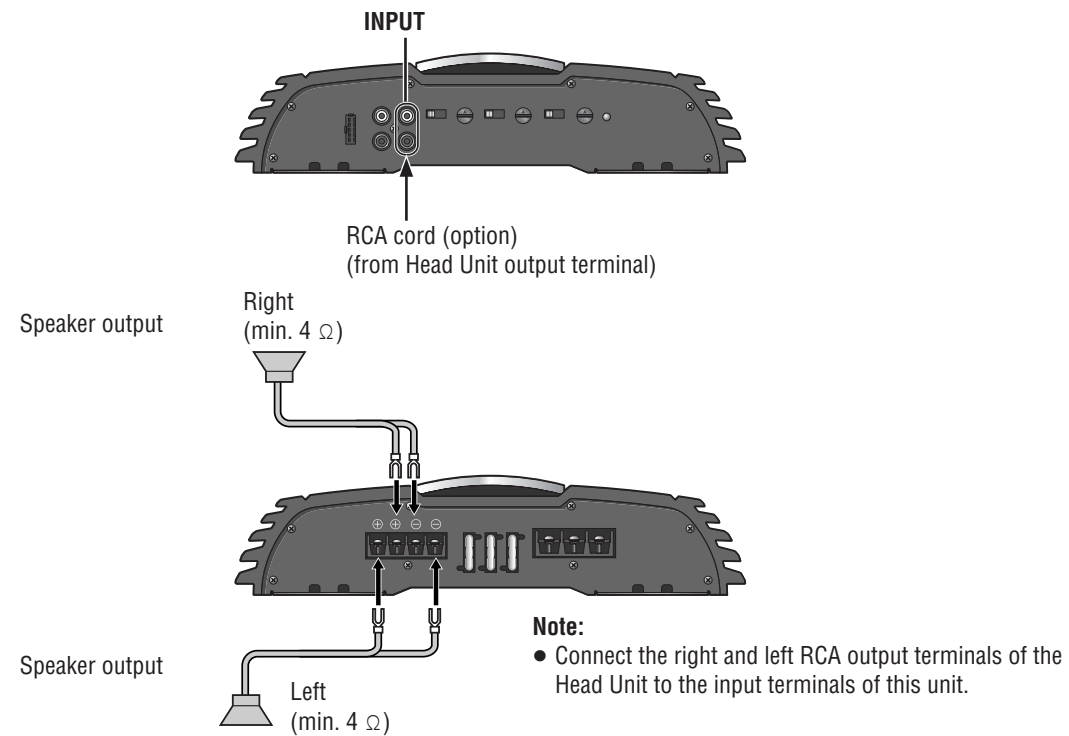

1-channel (Monaural) Speaker System

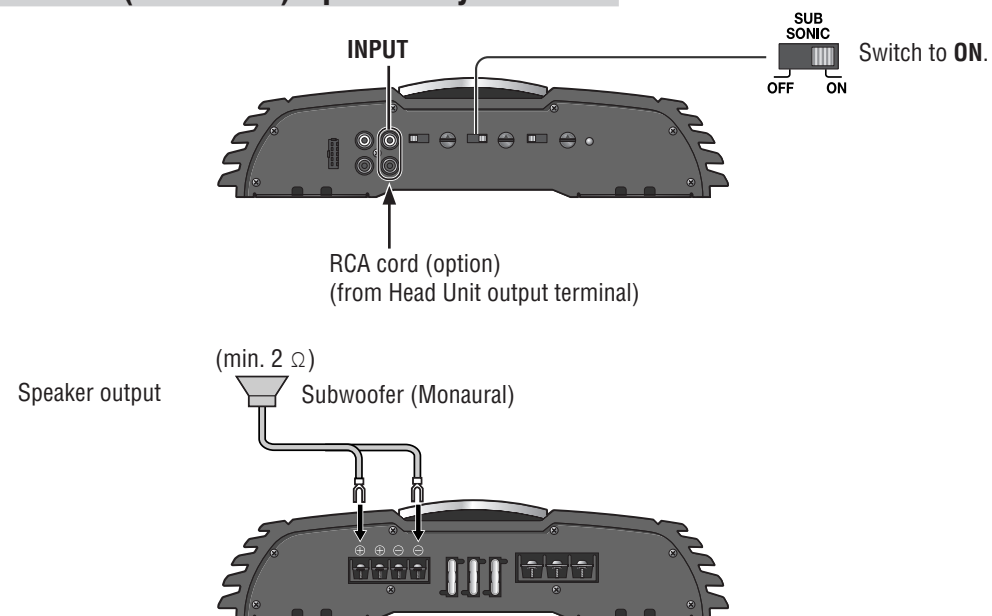

Note for Bridge Speaker Connection

• In case of 2-channel/stereo connection:

In case of multiple speakers to be mounted in a bridge connection, confirm the summed impedance to be 4–8 Ω in order to avoid ignition, smoking, or damage.

Total impedance: 4 Ω

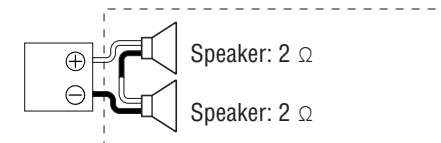

Total impedance: 4 Ω

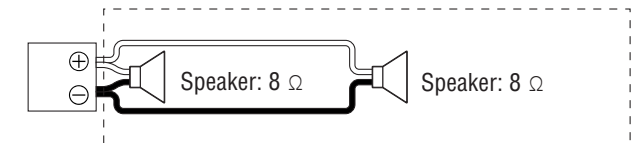

Do not make a connection in such a manner.

Total impedance: 2 Ω

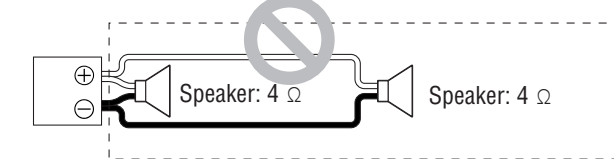

<CY-PA4003W>

Note for RCA Input Connection:

- Selectively assign each front and rear output to either RCA INPUT A or B, in accordance with the system from which the output is coming.
- In case of a single line coming from the RCA output of Head Unit, connect the line to RCA INPUT A. Do not connect it to RCA INPUT B.

Preparation

⚠ Caution

- Please follow the laws and regulations of your province or country for installation of the unit.
- We strongly recommended you to wear gloves for installation work to protect yourself from injuries.
- Be sure to grip both sides of this unit securely before attempting to move it.
Since this unit is quite heavy, the unit may fall down and this can lead to an accident or injury.

- Disconnect the cable from the negative (–) battery terminal (see caution below).

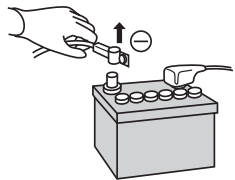

⚠ Caution

- If your car is equipped with air bag and/or anti-theft systems specific procedures may be required for connection and disconnection of the battery to install this product.
- Before attempting installation of this electronic component contact your car dealer or manufacturer to determine the required procedure and strictly follow their instructions.
- FAILURE TO FOLLOW THE PROCEDURE MAY RESULT IN THE UNINTENDED DEPLOYMENT OF AIR BAGS OR ACTIVATION OF THE ANTI-THEFT SYSTEM RESULTING IN DAMAGE TO THE VEHICLE AND PERSONAL INJURY.

Installation Hardware (For Installation)

No.	Item	Diagram	Qty.
①	Tapping Screw (5 mmφ×20 mm)		4
②	Plain Washer (5 mmφ)		4
③	Allen wrench		1

Installation Hardware (For Wiring)

No.	Item	Diagram	Qty.
④	Speaker input connector		2※
⑤	Terminal cover for short-circuit prevention		2

※ CY-PA4003W: 2 (1 for front speaker, 1 for rear speaker)
CY-PA2003W, CY-PAD1003W: 1 (for left/right speaker)

<CY-PAD1003W> Installation Hardware (For Installation)

No.	Item	Diagram	Qty.
⑥	Spacer		4
⑦	Tapping Screw (5 mmφ×40 mm)		4

Note:

- For power connection, use the optional power cord specially designed for use with Panasonic car-audio/AV system.
- Use only the supplied screws for installation. If parts are missing please consult with your Panasonic dealer for advice.

Mounting the Unit

⚠ Caution

- Never mount the unit in any of the following locations to avoid damage due to overheating;
 - Near the heater port.
 - Places like the dashboard or rear deck, where it may be exposed to direct sunlight.
- Do not mount the unit near the door, where it could be exposed to rain.
- You run the risk of interfering with the mounting or causing damage by drilling into the gas tank, a wiring harness, or other component.
- Keep a safe distance between the unit and other electronic equipment.
- If this unit is operated at a high output continuously, the upper side of the unit will get very hot. Do not touch it nor place anything on top of the unit.
- When a short circuit occurs, such as in the speaker output terminal, etc. the overload protection circuit will operate. This circuit protects the power amplifier from further damage when a short circuit occurs. Operation will temporarily stop. In this case, check the cause of the short-circuit and if the problem is fixed, normal operation will resume.
- Since the power amplifier has a very large output, the unit should be installed in the trunk of your car.
- Do not install this unit under a carpet, otherwise the unit may fail because of immature heat dissipation.
- Use the spacer included when installing the unit so that the fan and air hole on the base side of the unit are not covered. <CY-PAD1003W>
If the fan and air hole on the base side of the unit are covered, the unit will become extremely hot and may fail.

Before Mounting the Unit

- 1 Make the temporary connections.
- 2 Confirm the proper operation of the unit.
Confirm the proper connection and setting, and no blowout of the fuses.
- 3 Confirm after the installation of the unit that the spare tires, the jack, the tools, etc. can be picked up without obstruction.

Install the unit to a metallic portion of the car
Since the power amplifier has a very large output, the unit should be installed in the boot of your car.

<CY-PA4003W, CY-PA2003W>

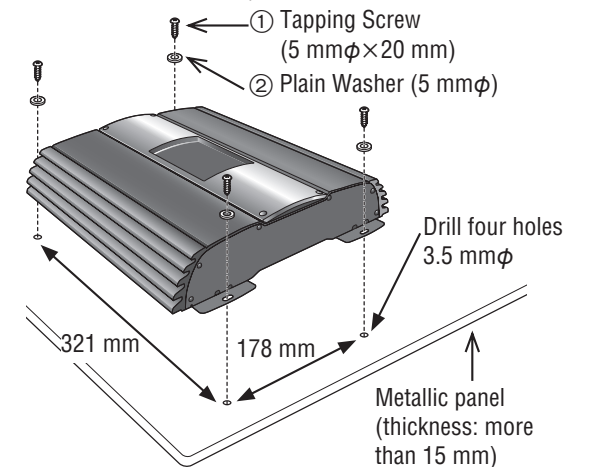

<CY-PAD1003W>

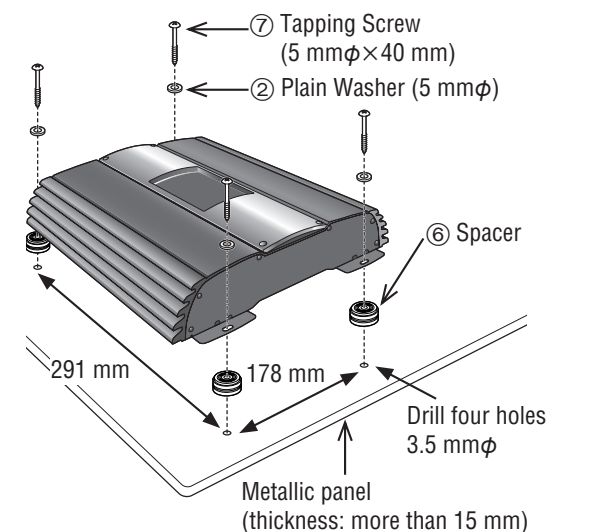

Note:

- If you wish to install the unit without using the spacer included, drill holes in the Metallic panel etc so that the fan and air holes on the base side of the unit are not covered.

Base side of CY-PAD1003W:

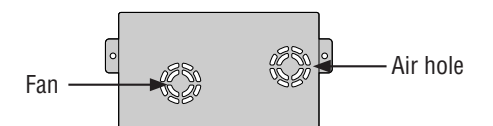

⚠ Caution

- This unit is designed for use in a car having a 12 V negative ground battery system.
- Be sure to insulate any exposed wires to prevent short circuiting with the car chassis. Bundle all cables, and prevent cable terminals from touching any metal parts.
- Note that if your car has a driving computer or a navigation computer, disconnecting the cable from the battery may clear the memory.
- Run the cords avoiding the spots where the temperature can be extremely high.
- Continuous use of a system that exceeds the maximum permissible input levels may damage the speakers.
- Since the power amplifier has a very large output, the unit should be installed in the trunk of your car.
- Do not install this unit under a carpet, otherwise the unit may fail because of immature heat dissipation.

Caution for the power cord (option):

- Follow an expert's instruction for the use of the cord separately sold.
- For the power, make sure to use the battery lead (yellow) separately sold and specially designed for Panasonic car-audio/AV system, and to connect directly to the car battery. Use the cord having the fuse capacity larger than that of this unit. Connect the power cord and other cords corresponding to the power supply after all the connections to the speaker are completed.
- Keep the battery lead (yellow) away from the speaker cord.

- Make sure to use the ground lead (black) separately sold and specially designed for car audio system, and to connect it to the metal portion of the car chassis.
- Wire the battery lead (yellow), the ground lead (black), the speaker cords, and this unit with as much distance as possible from the antenna, the antenna cords and the car stereo (car radio).
- If the ground wire is common to both left/right and front/rear speaker wirings, this unit cannot be used. Always use the independent lead wire for the speakers to be used. In this case, redo the wiring.

Caution for the speaker cord (option):

- The speaker cords and the power amplifier unit should be kept away from the antenna and antenna extension cord.
- Do not directly ground the speaker cords; do not share the negative leads of multiple speakers.
- When using the RCA cords, keep away from the speaker cords.

Caution for the speaker (option):

- Use speakers with a suitable maximum input.
- **In case of 4-channel/3-channel connection <CY-PA4003W>:**
Use speakers with the impedance of 2–8 Ω.
- **In case of 2-channel/stereo connection:**
Use speakers with the impedance of 4–8 Ω.

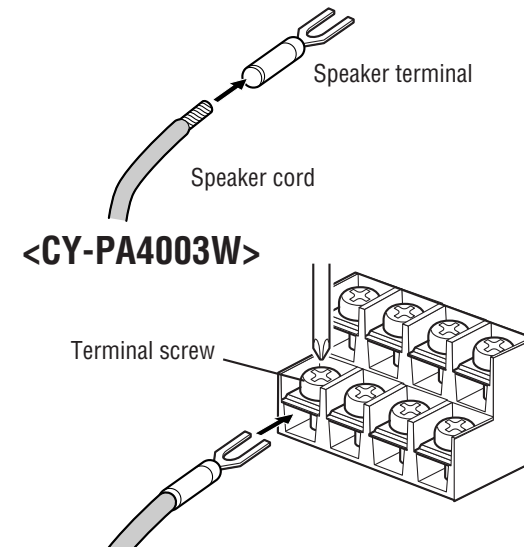
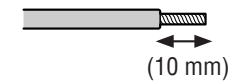
Speaker Output Terminal Screw Connection

- 1 Using a nipper or cutter, expose approximately 10 mm long of the core of the speaker cord and twist its end.
- 2 Attach the speaker terminal onto the speaker cord.
- 3 Unscrew the terminal screw.
- 4 Insert the screw into the terminal of the cord. Securely fasten the screw.

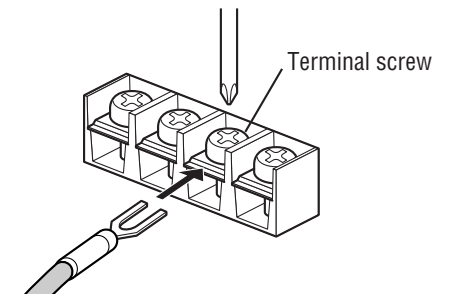
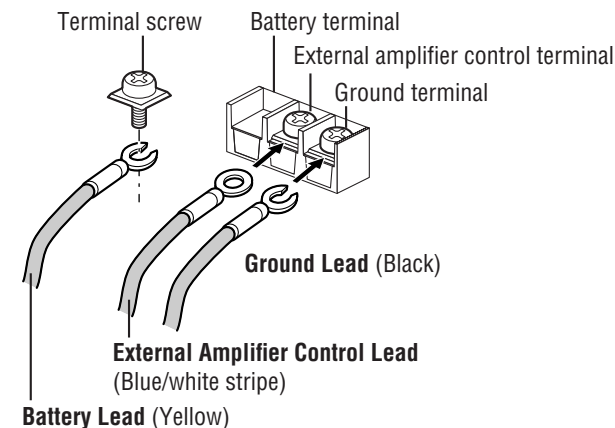
<CY-PA2003W, CY-PAD1003W>**Power Terminal Screw Connection**

For power connection, use the optional battery lead (yellow) specially designed for car-audio system and connect it directly to the car battery. Use the cord having the fuse capacity larger than that of this unit.

Securely tighten each lead with a terminal screw.

- 1 Unscrew the terminal screw.
- 2 Insert the screw into the terminal of the lead. Securely fasten the screw.

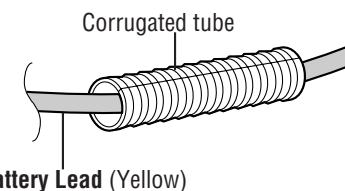

If the battery lead has to be routed through high temperature area, protect it with a corrugated tube (option).

Terminal Cover for Short-circuit Prevention

This terminal cover is for preventing short-circuit between adjacent terminals. Before connecting each lead, pass it through the terminal cover. After connecting the leads to the terminals, cover the speaker output terminals and power terminals with this cover. Make sure that the projections to prevent slipping out are facing down.

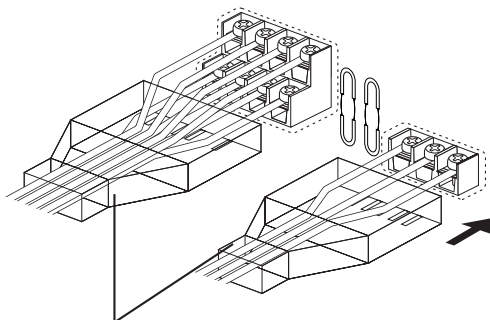
<CY-PA4003W>

⑤ Terminal cover for short-circuit prevention

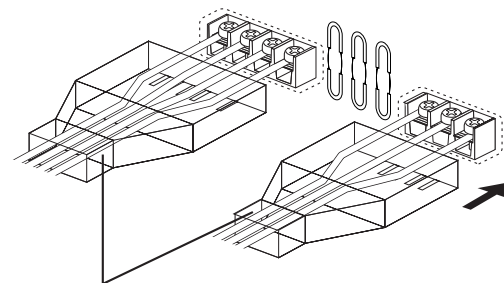
<CY-PA2003W, CY-PAD1003W>

⑤ Terminal cover for short-circuit prevention

Wiring <CY-PA4003W>

Speaker Connections with RCA cord

Example: 4 channel speaker connection (4CH input)

Note for RCA Input Connection:

- Selectively assign each front and rear output to either RCA INPUT A or B, in accordance with the system from which the output is coming.
- In case of a single line coming from the RCA output of Head Unit, connect the line to RCA INPUT A. Do not connect it to RCA INPUT B.

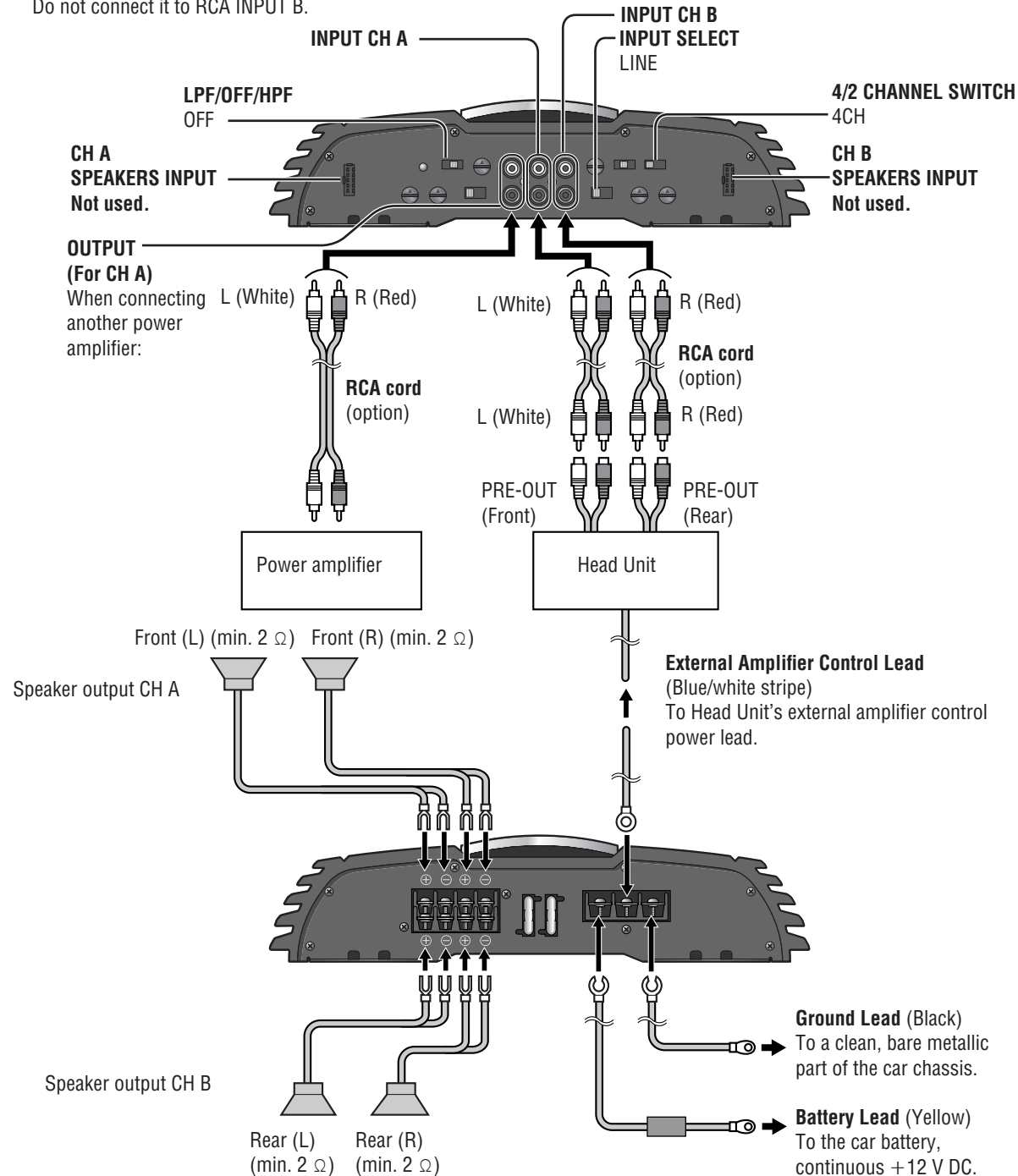

Speaker Connections with SPEAKERS INPUT Connectors

Example: 4 channel speaker connection (4CH input)

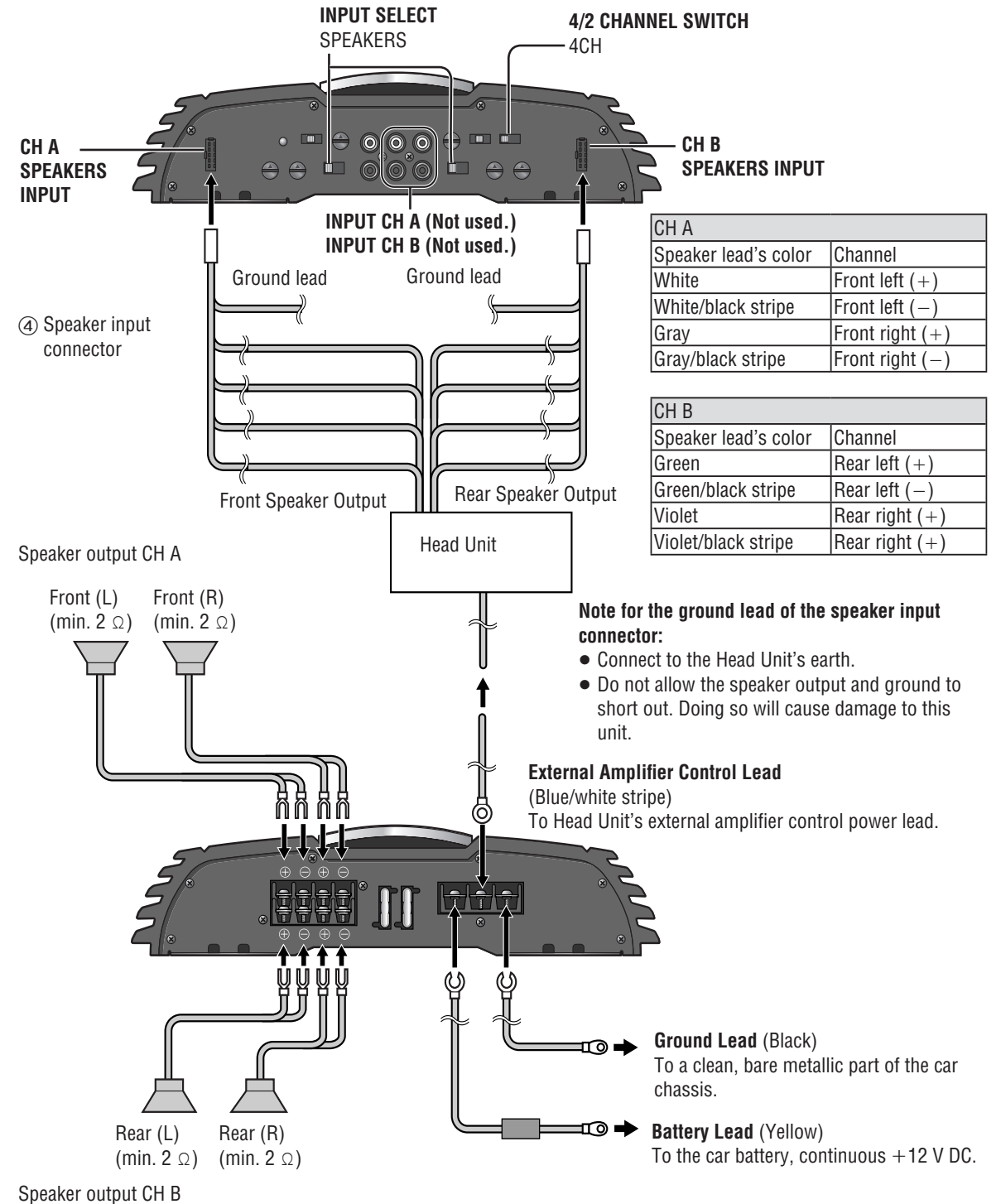

Wiring <CY-PA2003W>

Speaker Connections with RCA cord

Example: 2 channel speaker connection

Speaker Connections with SPEAKERS INPUT Connectors

Example: 2 channel speaker connection

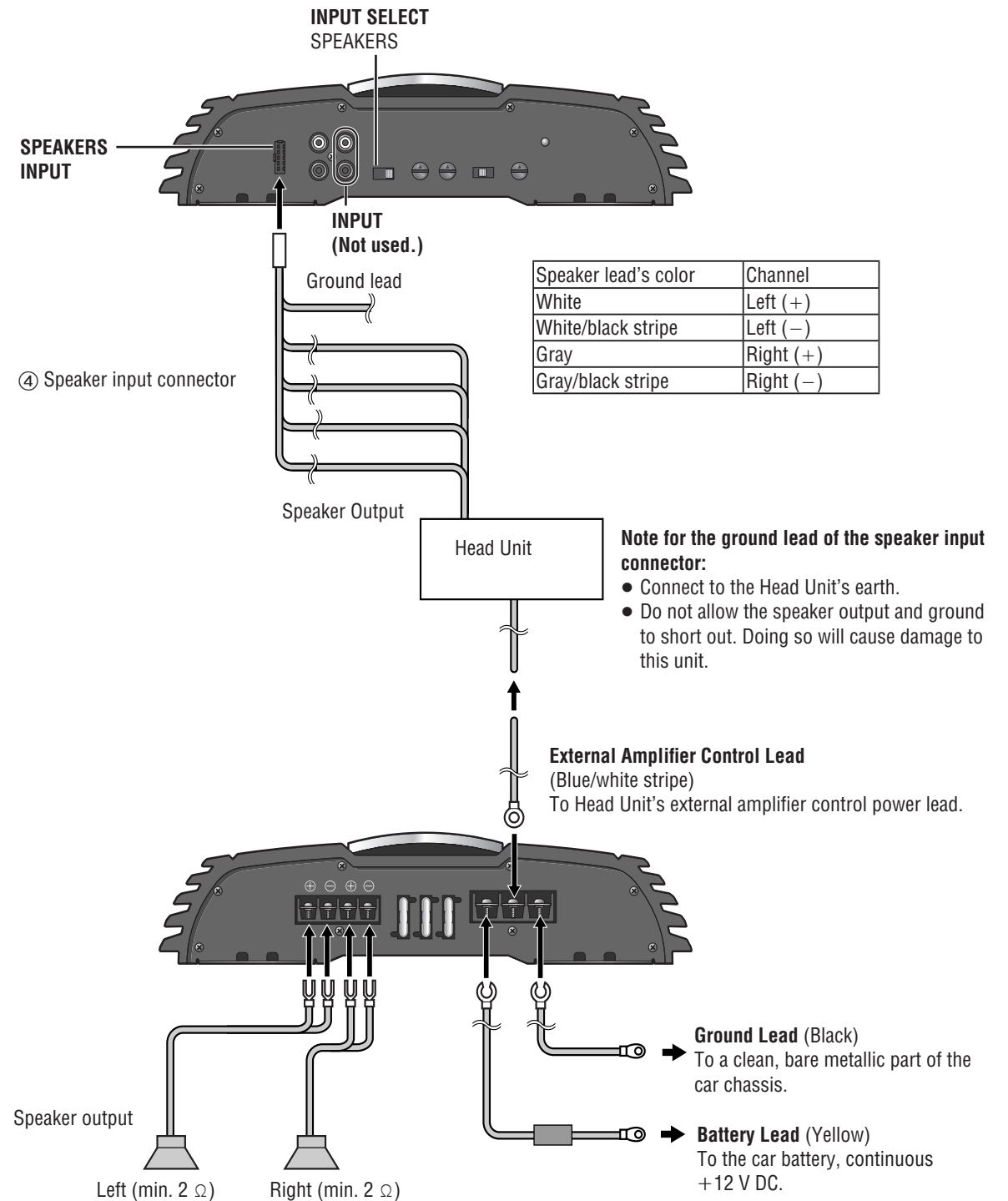
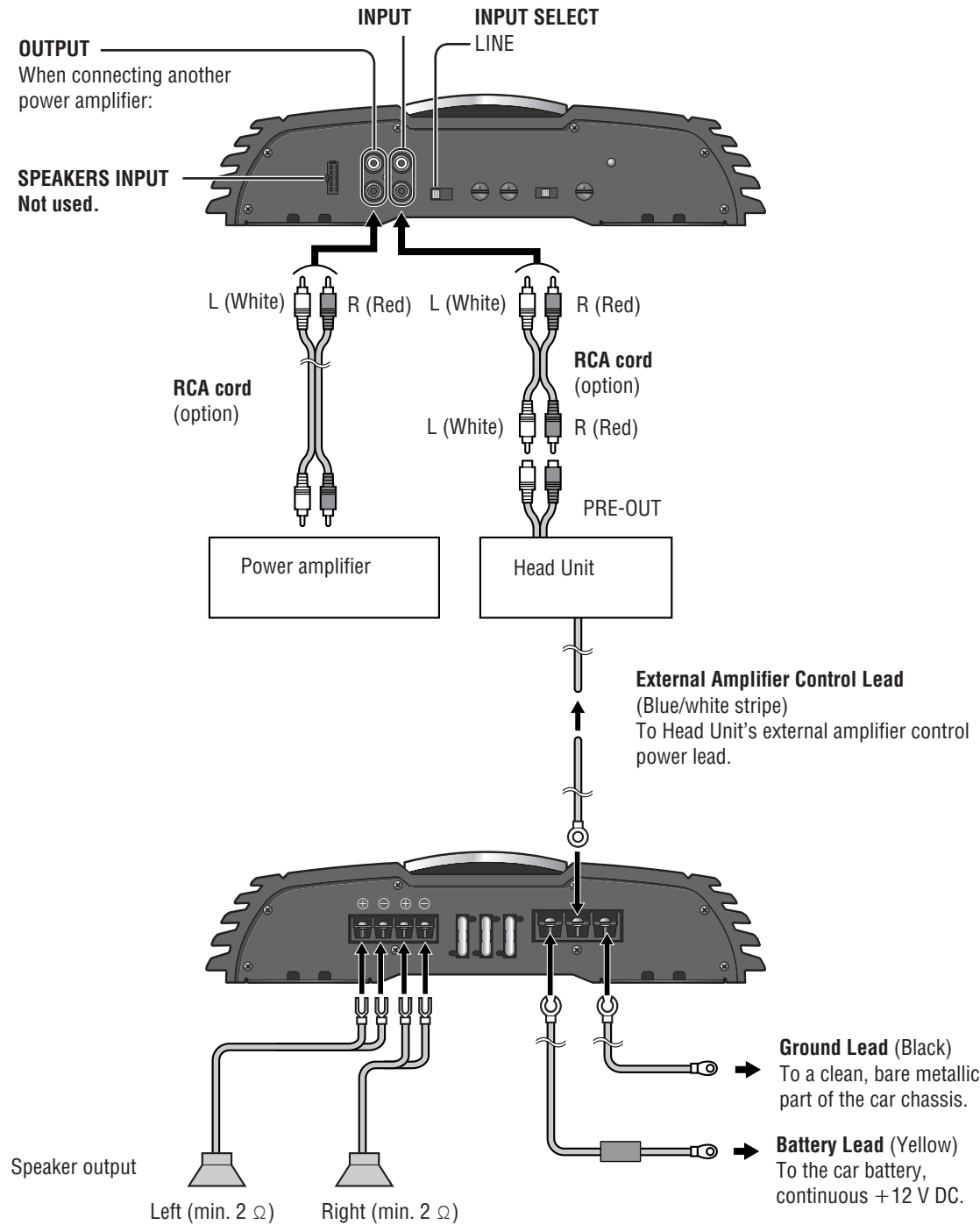

Wiring <CY-PAD1003W>

Speaker Connections with RCA cord

Example: 2 channel Input System

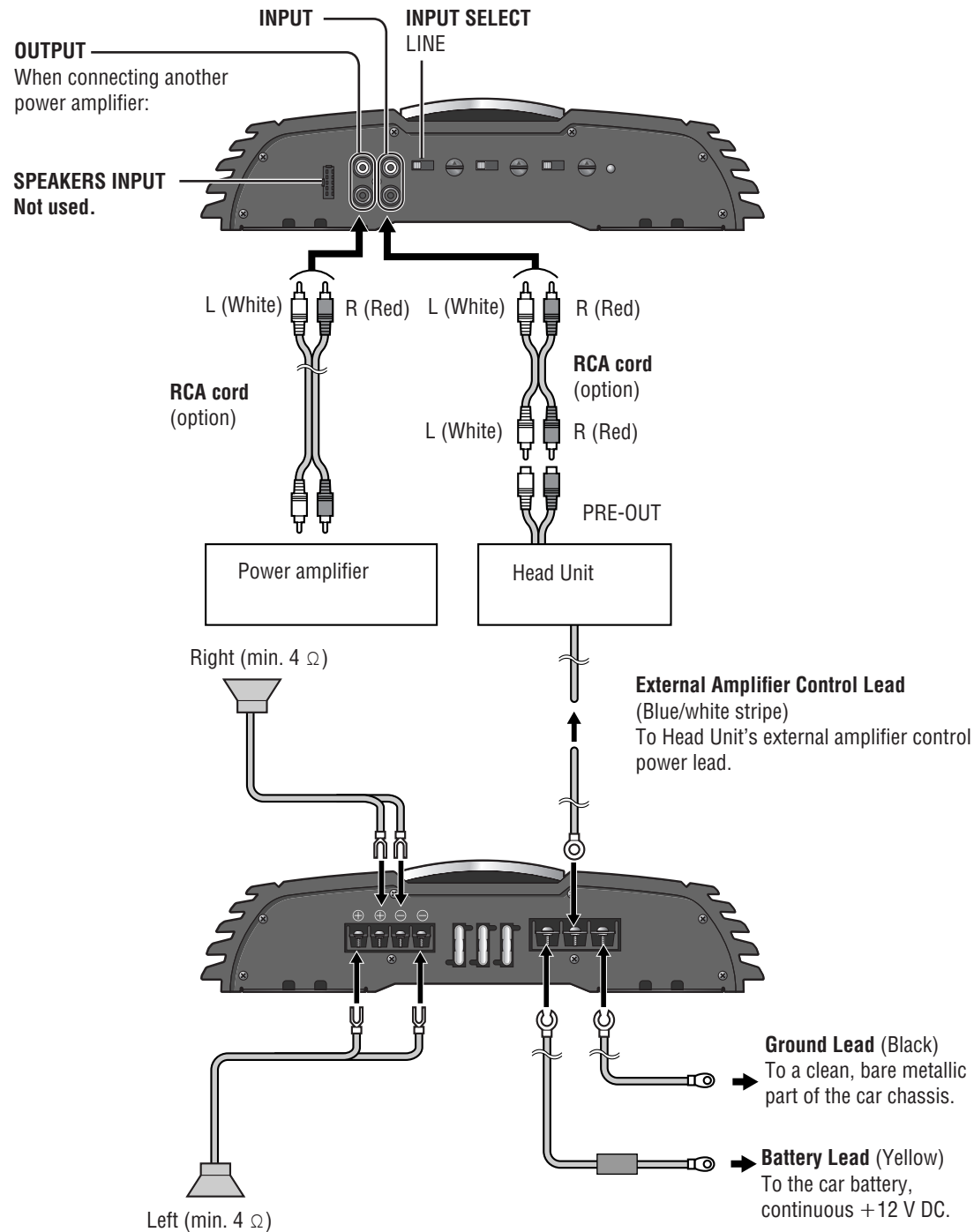

Speaker Connections with SPEAKERS INPUT Connectors

Example: 2 channel Input System

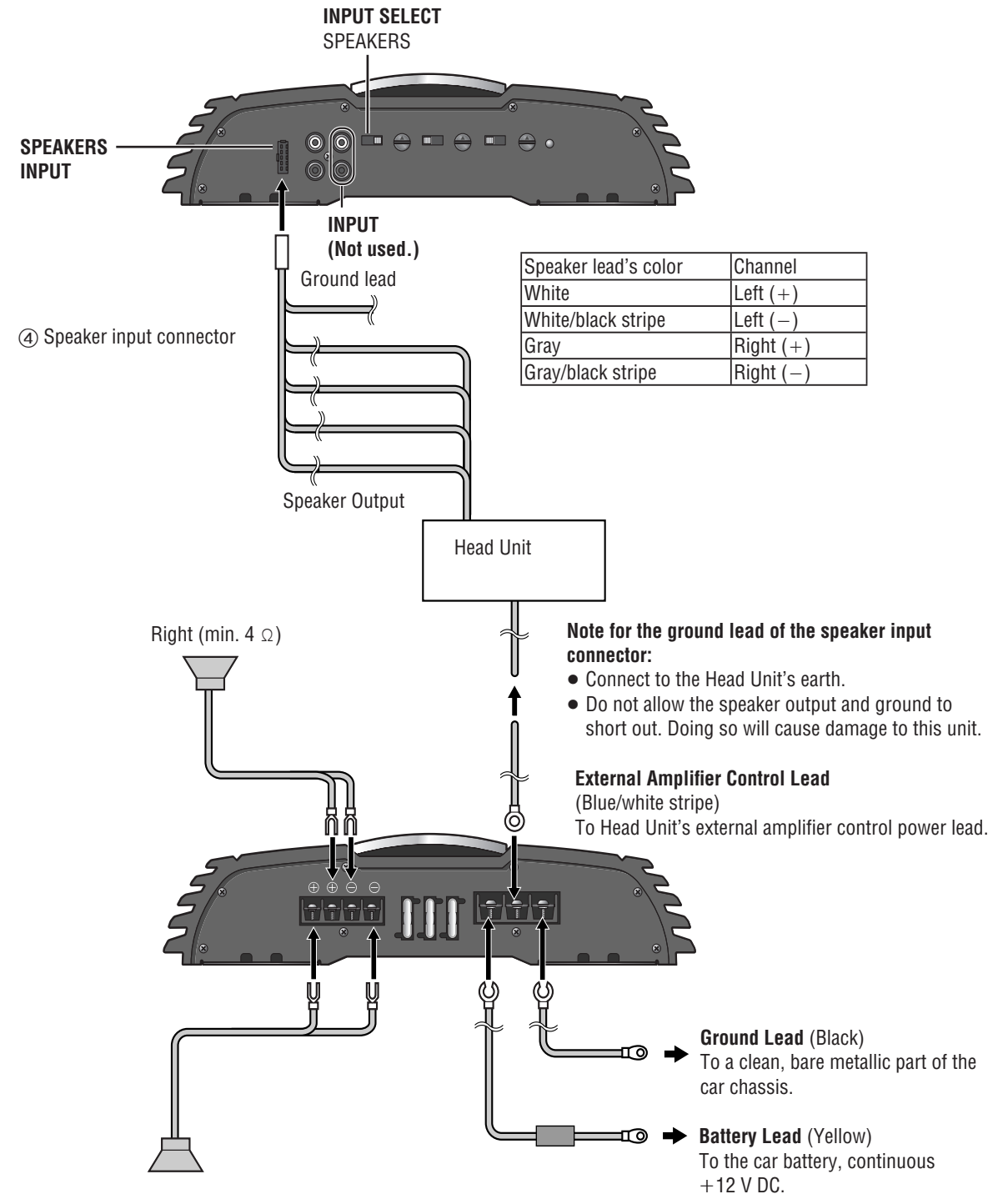

Troubleshooting

If You Suspect Something Wrong

Check and take steps as described below.

If the described suggestions do not solve the problem, it is recommended to take the unit to your nearest authorized Panasonic Service Center. The product should be serviced only by qualified personnel. Please refer checking and repair to professionals.

Panasonic shall not be liable for any accidents arising out of neglect of checking the unit or your own repair after your checking.

Never take measures especially those other than indicated by *italic* letters in "Possible solution" described below because those are too dangerous for users to handle themselves.

Warning

- Do not use the unit in abnormal condition, for example, without sound, or with smoke or foul smell, which can cause ignition or electric shock. Immediately stop using the unit and consult your dealer.
- Never try to repair the unit by yourself because it is dangerous to do so.

Problem	Possible cause → Possible solution
No sound available.	The power cord (battery, power and ground) is connected in the wrong way. → Check the wiring.
	The contact of the ground lead is poor. → Make sure that the ground lead is connected to an unpainted part of the chassis securely.
	The speaker cord is short-circuited. → Check the speaker cord, and replace the fuse.
	The speaker received damage because of too small input capacity. → Obtain the right speaker allowed to connect this unit, and replace the fuse. (page 32)
	The speaker cord is not properly connected. → Properly reconnect so that the polarity matches between the speaker cord and the terminal.
	The speaker cord is bitten with a screw of the vehicle. → Correct the wiring of the speaker cord.
	The knob for sound volume control is not properly adjusted. → Properly adjust it. → Adjust the volume of the Head Unit.
Input Select (LINE/SPEAKERS) is not set in accordance with the speaker output cord of the Head Unit. → Check the Input Select (LINE/SPEAKERS) setting.	

Problem	Possible cause → Possible solution
No sound available. (continued)	There is an electromagnetic-wave generator such as a cellular phone near the unit or its electrical lines. → Keep the electromagnetic-wave generator such as a cellular phone away from the unit and the wiring of the unit. If noise cannot be eliminated due to the wiring harness of the car, consult your dealer.
	Fuse blows out. → Eliminate the cause of fuse blowout and replace the fuse with new one. Consult your dealer.
Bad sound quality (Distorted sound) Noise	The bass is too much enhanced. → Set the bass boost appropriately.
Sound comes out from only either the Front 2CH or the Rear 2CH.	<CY-PA4003W> The 2CH/4CH setting of the speaker input is incorrect. → Set it correctly.
Only the bass is available.	<CY-PA4003W, CY-PA2003W> The Crossover Filter Switch (LPF/OFF/HPF) is turned off. → Set it on LPF or HPF according to the speaker connection.
	<CY-PAD1003W> The Crossover Filter Switch (LPF/OFF) is turned off. → Set it on LPF according to the speaker connection.
Only the treble is available.	The setting of Crossover Frequency Control is incorrect. → Check the Crossover Frequency Control setting.
The Protect lamp lights red.	The speaker cord is short-circuited. → Check the speaker cord, and replace the fuse.
	The speaker received damage because of too small input capacity. → Obtain the right speaker allowed to connect this unit, and replace the fuse. (page 32)
	The speaker cord is not properly connected. → Properly reconnect so that the polarity matches between the speaker cord and the terminal.
	Fuse blows out. → Eliminate the cause of fuse blowout and replace the fuse with new one. Consult your dealer.

Troubleshooting (continued)

Product Servicing

If the suggestions in the charts do not solve the problem, we recommend that you take it to your nearest authorized Panasonic Service Center. The product should be serviced only by a qualified technician.

Replacing the Fuse

Warning

Use fuses of the same specified rating.

CY-PA4003W: 35 A×2

CY-PA2003W: 25 A×3

CY-PAD1003W: 25 A×3

When replacing one fuse which has blown, replace other fuses at the same time.

In some cases, fuses may deteriorate without failing. Using different substitutes or fuses with higher ratings, or connecting the unit directly without a fuse, could cause fire or damage to the unit.

If the replacement fuse fails, contact your nearest Panasonic Service Center for service.

Maintenance

Caution on Cleaning

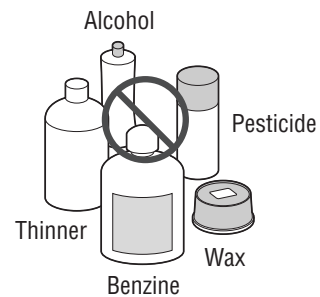

Your product is designed and manufactured to require minimum maintenance. Use a dry soft cloth for routine exterior cleaning. Never use benzine, thinner or other solvents.

Specifications

<CY-PA4003W>

Power Supply:	DC 12 V (11 V–16 V), test voltage 14.4 V, Negative Ground
Current Consumption:	32 A (at 64 W×4)
Speaker Impedance:	4 Ω
Power Output ("EIA" Power):	2-CH: 190 W×2 (20 Hz–20 000 Hz, 1 %, 4 Ω) 3-CH: 64 W×2+190 W (20 Hz–20 000 Hz, 1 %, 4 Ω) 4-CH: 64 W×4 (20 Hz–20 000 Hz, 1 %, 4 Ω)
Maximum Power Output:	2-CH: 220 W×2 (20 Hz–20 000 Hz, 10 %) 3-CH: 85 W×2+220 W (20 Hz–20 000 Hz, 10 %) 4-CH: 85 W×4 (20 Hz–20 000 Hz, 10 %)
Total Harmonic Distortion:	0.08 % (1 000 Hz, at 10 W)
Low Pass Filter:	50 Hz–250 Hz
High Pass Filter:	50 Hz–250 Hz
Bass Boost :	0 dB–15 dB (Middle Frequency: 45 Hz)
Signal to Noise Ratio:	90 dB (IHF, A)
Frequency Response:	20 Hz–20 kHz
Input Sensitivity:	0.2 V–6 V
Input Impedance:	More than 46 kΩ
Dimensions (W×H×D):	280×62×333 mm
Weight:	4.4 kg

Note:

- Specifications and design are subject to modification without notice due to improvements.
- Some figures and illustrations on this manual may be different from your product.

<CY-PA2003W>

Power Supply:	DC 12 V (11 V–16 V), test voltage 14.4 V, Negative Ground
Current Consumption:	44 A (at 200 W×2)
Speaker Impedance:	4 Ω
Power Output ("EIA" Power):	1-CH (Monaural): 480 W×1 (20 Hz–20 000 Hz, 1 %, 4 Ω) 2-CH (Stereo): 200 W×2 (20 Hz–20 000 Hz, 1 %, 4 Ω)
Maximum Power Output:	1-CH (Monaural): 550 W×1 (20 Hz–20 000 Hz, 10 %) 2-CH (Stereo): 260 W×2 (20 Hz–20 000 Hz, 10 %)
Total Harmonic Distortion:	0.08 % (1 000 Hz, at 10 W)
Low Pass Filter:	50 Hz–250 Hz
High Pass Filter:	50 Hz–250 Hz
Bass Boost:	0 dB–15 dB (Middle Frequency: 45 Hz)
Signal to Noise Ratio:	90 dB (IHF, A)
Frequency Response:	20 Hz–20 kHz
Input Sensitivity:	0.2 V–6 V
Input Impedance:	More than 43 kΩ
Dimensions (W×H×D):	280×62×333 mm
Weight:	4.5 kg

Note:

- Specifications and design are subject to modification without notice due to improvements.
- Some figures and illustrations on this manual may be different from your product.

<CY-PAD1003W>

Power Supply:	DC 12 V (11 V–16 V), test voltage 14.4 V, Negative Ground
Current Consumption:	29 A (at 350 W×1)
Speaker Impedance:	4 Ω
Power Output ("EIA" Power):	1-CH (Monaural): 350 W×1 (10 Hz–8 000 Hz, 1 %, 4 Ω)
Maximum Power Output:	1-CH (Monaural): 600 W×1 (10 Hz–8 000 Hz, 10 %)
Total Harmonic Distortion:	0.2 % (1 000 Hz, at 10 W)
Low Pass Filter:	50 Hz–250 Hz
Bass Boost:	0 dB–15 dB (Middle Frequency: 45 Hz)
Subsonic Filter:	20 Hz, –3 dB, 12 dB/oct
Signal to Noise Ratio:	90 dB (IHF, A)
Frequency Response:	10 Hz–8 kHz
Input Sensitivity:	0.2 V–6 V
Input Impedance:	More than 22 kΩ
Dimensions (W×H×D):	280×62×303 mm
Weight:	4.0 kg

Note:

- Specifications and design are subject to modification without notice due to improvements.
- Some figures and illustrations on this manual may be different from your product.

Matsushita Electric Industrial Co., Ltd.
Web Site: <http://panasonic.net>

YEFM285832A FU0106-2046 Printed in China

Free Manuals Download Website

<http://myh66.com>

<http://usermanuals.us>

<http://www.somanuals.com>

<http://www.4manuals.cc>

<http://www.manual-lib.com>

<http://www.404manual.com>

<http://www.luxmanual.com>

<http://aubethermostatmanual.com>

Golf course search by state

<http://golfingnear.com>

Email search by domain

<http://emailbydomain.com>

Auto manuals search

<http://auto.somanuals.com>

TV manuals search

<http://tv.somanuals.com>