

## Home Theater Audio System

Operating Instructions

Model No. **SC-HT07**  
**SC-HT05**

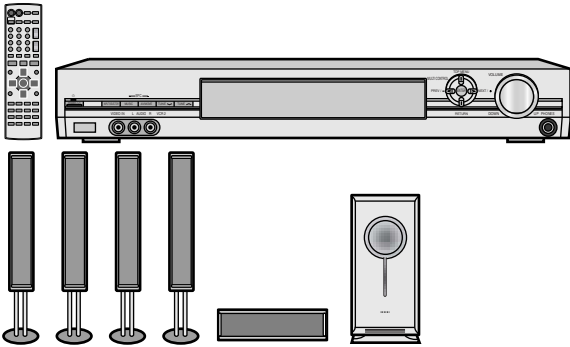

SC-HT07

### Dear customer

Thank you for purchasing this product.  
Before connecting, operating or adjusting this product, please read these instructions completely.  
Please keep this manual for future reference.

SC-HT07 is used in the illustrations unless otherwise mentioned.

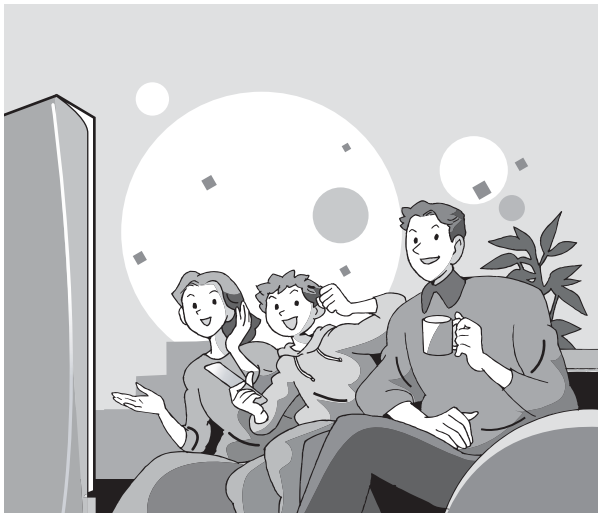

**For U.S.A.**  
As an ENERGY STAR® Partner,\*  
Panasonic has determined that this  
product meets the ENERGY STAR®  
guidelines for energy efficiency.

\*For Canada only: The word "Participant" is used in place of the word "Partner".

## Table of contents

### Before use

<b>IMPORTANT SAFETY INSTRUCTIONS</b> .....	2
<b>Supplied accessories</b> .....	3
<b>Setup flow</b> .....	3

### Setup

<b>Speaker setup (for SC-HT07)</b> .....	4
<b>Speaker setup (for SC-HT07 and SC-HT05)</b> ....	6
<b>Home theater connections</b> .....	8
<b>Other connections</b> .....	10
<b>Settings</b> .....	12

### Operations

<b>Basic operations</b> .....	13
<b>Control guide</b> .....	14
<b>The radio</b> .....	18
<b>Other functions</b> .....	19
<b>Using the VCR2 terminals (for SC-HT07)</b> ....	21
<b>Making a recording</b> .....	21
<b>The RESET function</b> .....	21
<b>Remote control operation guide</b> .....	22
<b>Advance setup</b> .....	24

### Reference

<b>Specifications</b> .....	25
<b>Maintenance</b> .....	25
<b>Listening caution</b> .....	26
<b>Product Service</b> .....	26
<b>Warranty (U.S.A.)</b> .....	27
<b>Troubleshooting guide</b> .....	Back cover

# IMPORTANT SAFETY INSTRUCTIONS

Read these operating instructions carefully before using the unit. Follow the safety instructions on the unit and the applicable safety instructions listed below. Keep these operating instructions handy for future reference.

- 1) Read these instructions.
- 2) Keep these instructions.
- 3) Heed all warnings.
- 4) Follow all instructions.
- 5) Do not use this apparatus near water.
- 6) Clean only with dry cloth.
- 7) Do not block any ventilation openings. Install in accordance with the manufacturer's instructions.
- 8) Do not install near any heat sources such as radiators, heat registers, stoves, or other apparatus (including amplifiers) that produce heat.
- 9) Do not defeat the safety purpose of the polarized or grounding-type plug. A polarized plug has two blades with one wider than the other. A grounding-type plug has two blades and a third grounding prong. The wide blade or the third prong are provided for your safety. If the provided plug does not fit into your outlet, consult an electrician for replacement of the obsolete outlet.
- 10) Protect the power cord from being walked on or pinched particularly at plugs, convenience receptacles, and the point where they exit from the apparatus.
- 11) Only use attachments/accessories specified by the manufacturer.
- 12) Use only with the cart, stand, tripod, bracket, or table specified by the manufacturer, or sold with the apparatus. When a cart is used, use caution when moving the cart/apparatus combination to avoid injury from tip-over.
- 13) Unplug this apparatus during lightning storms or when unused for long periods of time.
- 14) Refer all servicing to qualified service personnel. Servicing is required when the apparatus has been damaged in any way, such as power-supply cord or plug is damaged, liquid has been spilled or objects have fallen into the apparatus, the apparatus has been exposed to rain or moisture, does not operate normally, or has been dropped.





**CAUTION**  
**RISK OF ELECTRIC SHOCK**  
**DO NOT OPEN**



**CAUTION: TO REDUCE THE RISK OF ELECTRIC SHOCK, DO NOT REMOVE SCREWS. NO USER-SERVICEABLE PARTS INSIDE. REFER SERVICING TO QUALIFIED SERVICE PERSONNEL.**



The lightning flash with arrowhead symbol, within an equilateral triangle, is intended to alert the user to the presence of uninsulated "dangerous voltage" within the product's enclosure that may be of sufficient magnitude to constitute a risk of electric shock to persons.



The exclamation point within an equilateral triangle is intended to alert the user to the presence of important operating and maintenance (servicing) instructions in the literature accompanying the appliance.

**WARNING:**  
**TO REDUCE THE RISK OF FIRE, ELECTRIC SHOCK OR PRODUCT DAMAGE, DO NOT EXPOSE THIS APPARATUS TO RAIN, MOISTURE, DRIPPING OR SPLASHING AND THAT NO OBJECTS FILLED WITH LIQUIDS, SUCH AS VASES, SHALL BE PLACED ON THE APPARATUS.**

## THE FOLLOWING APPLIES ONLY IN THE U.S.A.

### CAUTION:

This equipment has been tested and found to comply with the limits for a Class B digital device, pursuant to Part 15 of the FCC Rules.

These limits are designed to provide reasonable protection against harmful interference in a residential installation. This equipment generates, uses and can radiate radio frequency energy and, if not installed and used in accordance with the instructions, may cause harmful interference to radio communications. However, there is no guarantee that interference will not occur in a particular installation. If this equipment does cause harmful interference to radio or television reception, which can be determined by turning the equipment off and on, the user is encouraged to try to correct the interference by one or more of the following measures:

- Reorient or relocate the receiving antenna.
- Increase the separation between the equipment and receiver.
- Connect the equipment into an outlet on a circuit different from that to which the receiver is connected.
- Consult the dealer or an experienced radio/TV technician for help.

Any unauthorized changes or modifications to this equipment would void the user's authority to operate this device.

This device complies with Part 15 of the FCC Rules. Operation is subject to the following two conditions: (1) This device may not cause harmful interference, and (2) this device must accept any interference received, including interference that may cause undesired operation.

System	SC-HT07	SC-HT05
Main unit	SA-HT07	SA-HT05
Front speakers	SB-FS927	SB-PF725
Surround speakers		SB-PS725
Center speaker	SB-PC927	SB-PC725
Subwoofer	SB-WA07	SB-WA05

## Supplied accessories

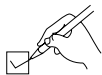

Please check and identify the supplied accessories.

AC power supply cord



(K2CB2CB00006)

System cable



(K1HA25HA0001)

FM indoor antenna



(RSA0007-L)

AM loop antenna



(N1DAAA00002)

Remote control transmitter

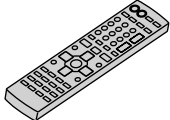

**SC-HT07** (EUR7722KD0)

**SC-HT05** (EUR7722KF0)

Batteries



(x 2)

Speaker cable(s)



**SC-HT07** (REE1203A) (4 m x 1)

**SC-HT05** (REE1203A) (4 m x 3)  
(REE1203C) (10 m x 2)

Sticker sheet



(RQCA1029)

**SC-HT07**

Speaker stands



(x 4)

(RYQ0463A-S)

Stand bases



(x 4)

(RYQ0470-S)

Screws (large and small)



(XSN5+10FN) (x 8)



(XSS6+14FZ) (x 8)

Use the numbers indicated in parentheses when asking for replacement parts.

(Only for U.S.A.)

To order accessories contact 1-800-332-5368 or website

(<http://www.pasc.panasonic.com>) Download from [www.Somanuals.com](http://www.Somanuals.com). All Manuals Search And Download.

## Setup flow

# 1

### Speaker setup

→ page 4

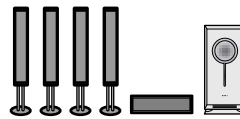

#### Speakers

- Front
- Center
- Surround
- Subwoofer

# 2

### Home theater connections

→ page 8

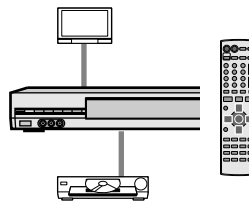

- DVD player
- TV (Monitor)
- Remote control

# 3

### Other connections

→ page 10

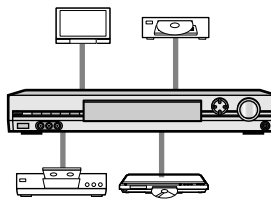

- Antennas
- DVD recorder or VCR
- TV (Input source)
- Cassette deck
- CD player
- Game machine or other AV equipment

# 4

### Settings

→ page 12

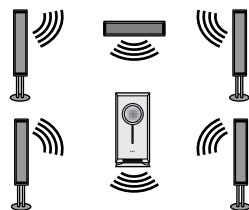

- Speaker output level

### Sit back and enjoy the experience

→ page 13



- Basic operations
- Control guide
- The radio
- Other functions
- Remote control operation guide

# 1

## Speaker setup (for SC-HT07)

### Front and surround speaker assembly

- To prevent damage or scratches, lay a soft cloth and perform assembly on it.
- For assembly, use a Phillips-head screwdriver.

#### 1 Attach the pipe to the base.

##### 1 Thread the speaker cable through the base.

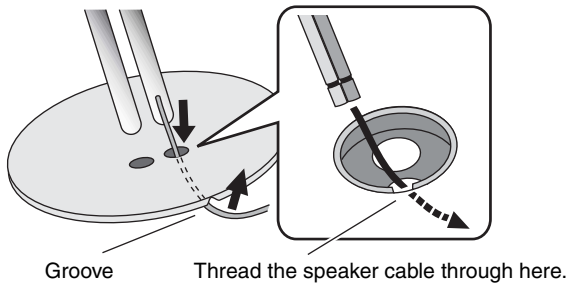

##### 3 Secure the pipe to the base.

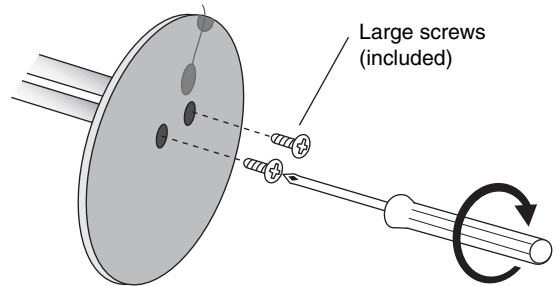

Ensure the screws are securely fastened by lightly tightening the left and right side screws alternately until fully tightened. (The heads of the screws protrude slightly even if you have fully tightened them.)

**The supplied stands are specially designed for attachment to Panasonic SB-FS927 front speakers and surround speakers. Only use as indicated in this setup.**

##### 2 Insert the pipe.

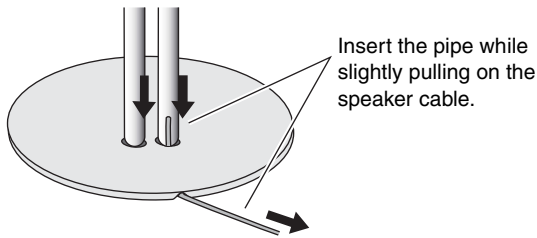

#### 2 Attach the stand to the speaker.

##### 1 Ensure the stand is fastened on straight by lightly tightening the top and bottom screws alternately until fully tightened.

- There is no difference between the right and left speakers and stands.

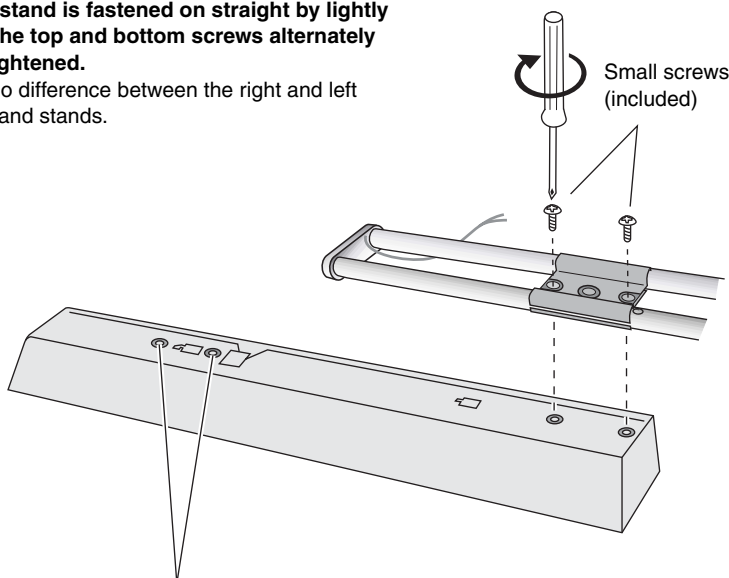

##### For your reference

You can enjoy good acoustics by adjusting the height of the front speaker with the height of the television so the center positions of both are approximately the same.

It is usually better to make the surround speakers a little higher.

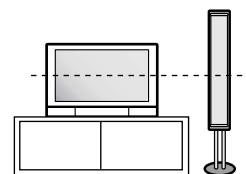

You can also attach to the upper rear of the speaker.

When attached to the upper rear, you can adjust the height of the speakers between 625 mm and 796 mm. When attached to the lower rear, you can adjust the height of the speakers between 968 mm and 1138 mm. (Speaker height adjustment ► procedure 3)

## Supplied accessories

Speaker stands



Stand bases



Screws (large and small)

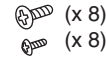

### 3 Adjust the speaker height.

e.g., With the stand attached to the lower rear of the speaker

**Stopper screw**  
Screw to stop mounting plate from moving or sliding below this point.

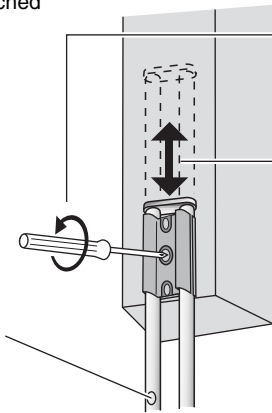

**1 Loosen the attached speaker mounting plate screw until the attached speaker is slightly loose and adjustable.**

- Be careful not to loosen the screw too much or the speaker may detach and fall.

**2 Adjust the position of the pipe.**

- After adjusting the height, tighten the screw on the mounting plate securely.

### 4 Connect the speaker cables.

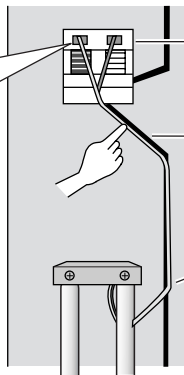
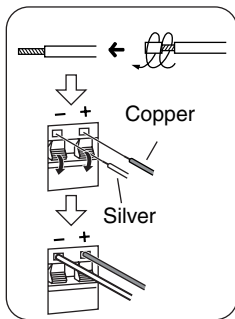

**1 Connect the speaker cables.**

**2 Press the speaker cable into the groove.**

If there is any excess cable, thread it from the opening near the top of the pipe while pulling it from the bottom of the base.

### 5 Fasten the speaker cable to the base.

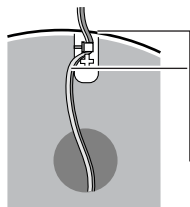

**1 Press the speaker cable and thread between the hooks.**

**2 Fit the speaker cable into the base cover groove as far as possible.**

#### Preventing the speakers from falling over

Attach screw eyes (not included) to secure the speakers to a wall (diagram on the right).

- Obtain the screws appropriate to the walls and pillars to which they are going to be fastened.
- Consult with a qualified housing contractor concerning the appropriate procedure when attaching to a concrete wall or a surface that may not have strong enough support. Improper installation may result in damage to the wall or speakers.

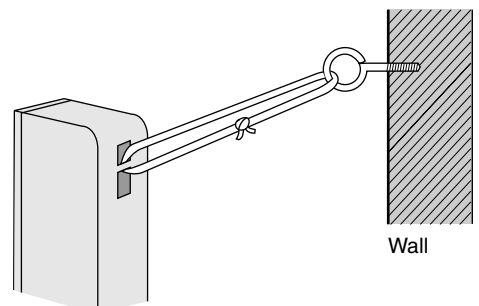

# Speaker setup (for SC-HT07 and SC-HT05)

## Setup and connections of speakers

### 1 Attach the stickers to the speaker cables.

About 10 cm (4")

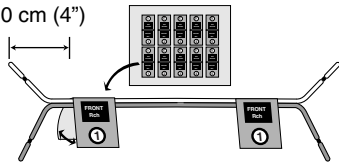

#### SC-HT07

Front and surround speakers (The length of cables are same.)

About 10 cm (4")

- ① Front speaker (L)
- ② Front speaker (R)
- ③ Surround speaker (L)
- ④ Surround speaker (R)
- ⑤ Center speaker

#### SC-HT05

Use the long speaker cables for the surround speakers (SB-PS725).

### 2 Place the speakers.

e.g., SC-HT07

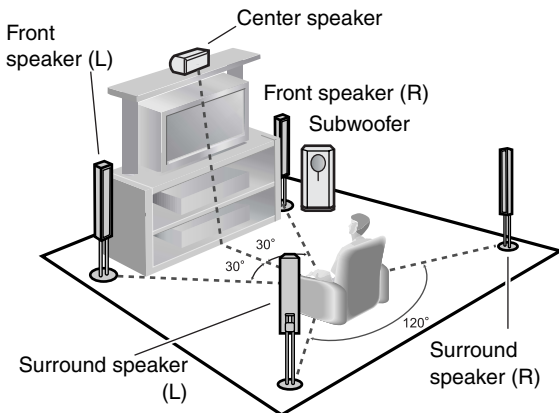

#### SC-HT05

Surround speakers

Place on a shelf or rack.

Place the front, center, and surround speakers at approximately the same distance from the seating position. The angles in the diagram are approximate.

#### Positioning for best effect

How you set up your speakers can affect the bass and the sound field.

Note the following points.

- Place speakers on flat secure bases.
- Placing speakers too close to floors, walls, and corners can result in excessive bass. Cover walls and windows with a thick curtain.

#### Front speakers (left right)

Place on the left and right of the TV at seated ear height so that there is good coherency between the picture and sound.

#### Center speaker

Place underneath or above the center of the TV. Aim the speaker at the seating area.

#### Surround speakers (left right)

Place on the side of or slightly behind the seating area, higher than ear level.

#### Subwoofer

The subwoofer can be placed in any position as long as it is at a reasonable distance from the TV.

Note that some experimentation can yield the smoothest low frequency performance. Placement near a corner can increase the apparent output level, but can result in unnatural bass.

#### Note

Keep your speakers at least 10 mm (13/32") away from the system for proper ventilation.

#### If irregular coloring occurs on your television

The supplied speakers are designed to be used close to a television, but the picture may be affected with some televisions and setup combinations.

#### If this occurs, turn the television off for about 30 minutes.

The television's demagnetizing function should correct the problem. If it persists, move the speakers further away from the television.



#### Caution

- The main unit and supplied speakers are only to be used as indicated in this manual. Failure to do so may lead to damage to the receiver and/or the speakers, and may result in the risk or fire. Consult a qualified service person if damage has occurred or if you experience a sudden change in performance.
- Do not attempt to attach these speakers to walls using methods other than those described in this manual.

**Supplied accessories**

Speaker cable(s)



**SC-HT07** (4 m x 1)  
**SC-HT05** (4 m x 3) (10 m x 2)

Sticker sheet

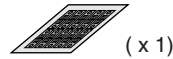

**3** Connect the speaker cables to the subwoofer.

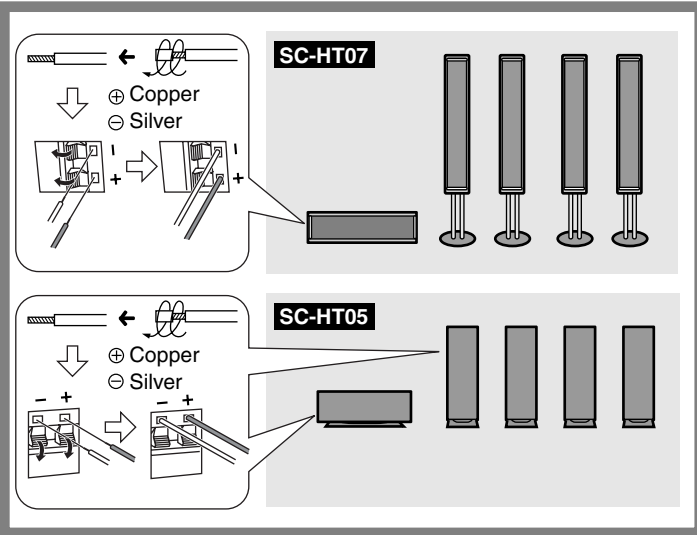

Subwoofer

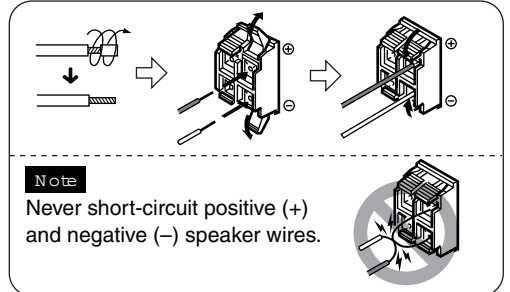
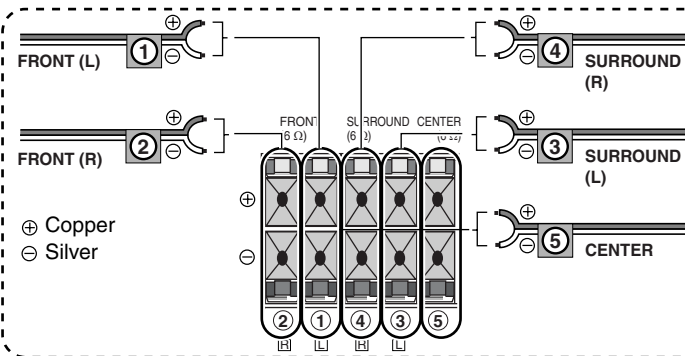
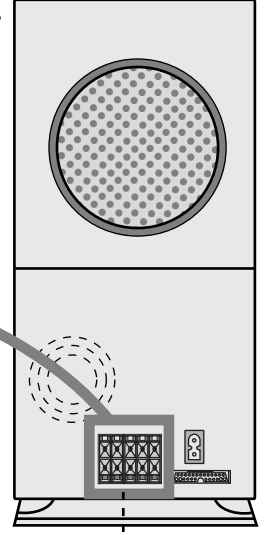

**Other speaker setup options**

**Attaching to a wall**

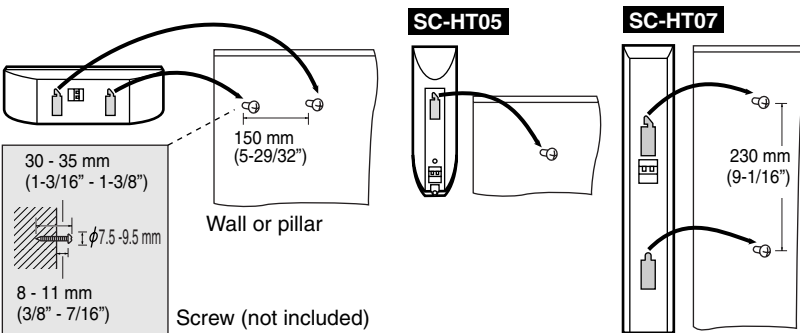

- The wall or pillar on which the speakers are to be attached should be capable of supporting 10 kg (22 lb.) per screw. Consult a qualified building contractor when attaching the speakers to wall. Improper attachment may result in damage to the wall and speakers.
- (SC-HT07) When mounting the front and surround speakers to walls, use a string (not included) to prevent them from a falling (→ page 5). Use of optional speaker cables are recommended for wall mounted front and surround speakers. (You can also remove the speaker cables from the pipes supplied with this system.)

**Fitting optional speaker stands**

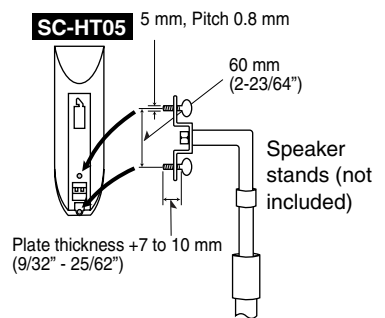

- Observe the diameter and length of the screws and the distance between screws as shown in the diagram.
- The stands must be able to support over 10 kg (22 lb.).
- The stands must be stable even if the speakers are in a high position.



### Other accessories

**Stereo connection cable (not included)**



**Video connection cable (not included)**



Turn off all components before making any connections. To connect equipment, refer to the appropriate operating instructions.

**Note**

The included AC power supply cord is for use with this unit only. Do not use it with other equipment.

**Changing the digital input settings**

You can change the input settings for the digital terminals if necessary. Note the equipment you have connected to the terminals, then change the settings (► page 21).

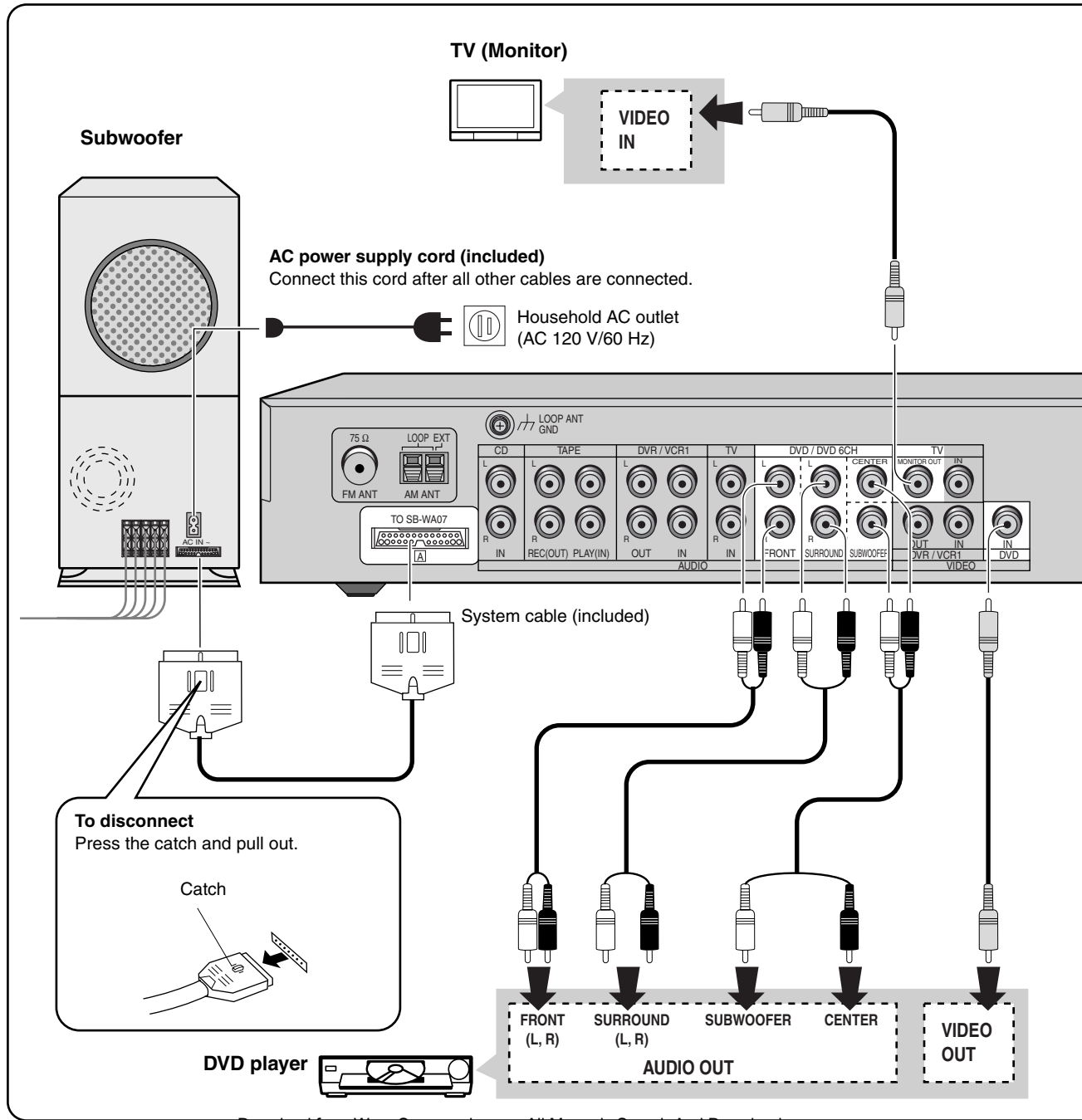



## Supplied accessories

System cable



(x 1)

AC power supply cord



(x 1)

Remote control transmitter

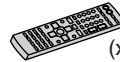

(x 1)

Batteries



(x 2)

### Note

- Use digital connection to enjoy Dolby Digital or DTS.

### Notes on digital input

This unit can decode the following signals:

- Dolby Digital, DTS
- PCM, including PCM with sampling frequencies of 96 or 88.2 kHz

It cannot decode:

- Other digital signals, such as MPEG
- Dolby Digital RF signals from a laser disc player

## The remote control

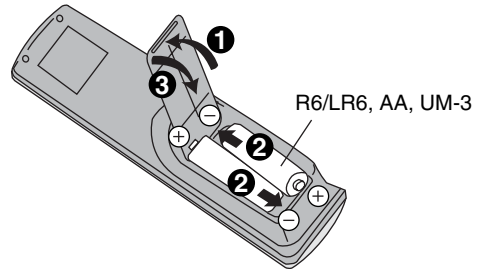

- Insert so the poles (+ and -) match those in the remote control.
- Do not use rechargeable type batteries.

### Use

Aim at the sensor, avoiding obstacles, at a maximum range of 7 m (23 feet) directly in front of the unit.

Remote control signal sensor

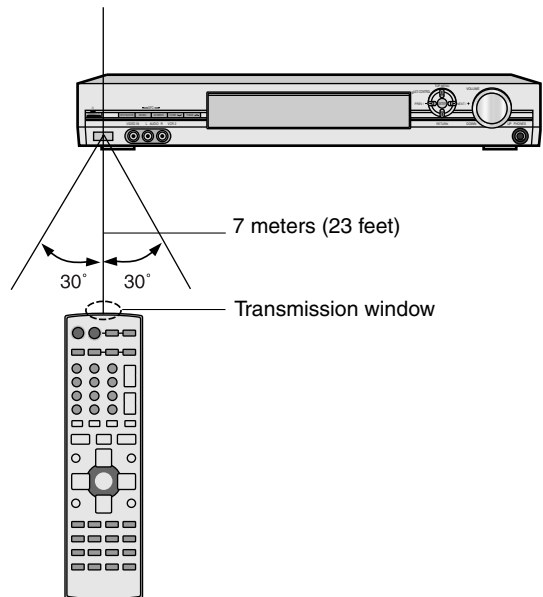

### Note

- Keep the transmission window and the unit's sensor free from dust.
- Operation can be affected by strong light sources, such as direct sunlight, and the glass doors on cabinets.

### SC-HT07



#### S-Video cable (not included)

Used to connect to the S-VIDEO IN terminal on a television.

Used to connect to the S-VIDEO OUT terminal on a DVD player.

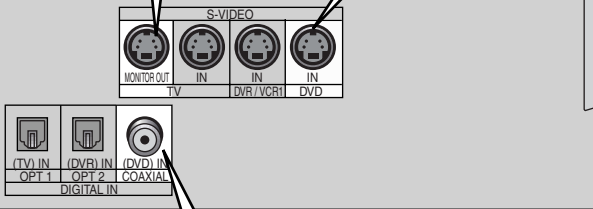

#### Coaxial cable (not included)

Used to connect to the DIGITAL COAXIAL OUT terminal on a DVD player to input audio digital signals.

### Antennas

#### FM indoor antenna (included)

#### AM loop antenna (included)

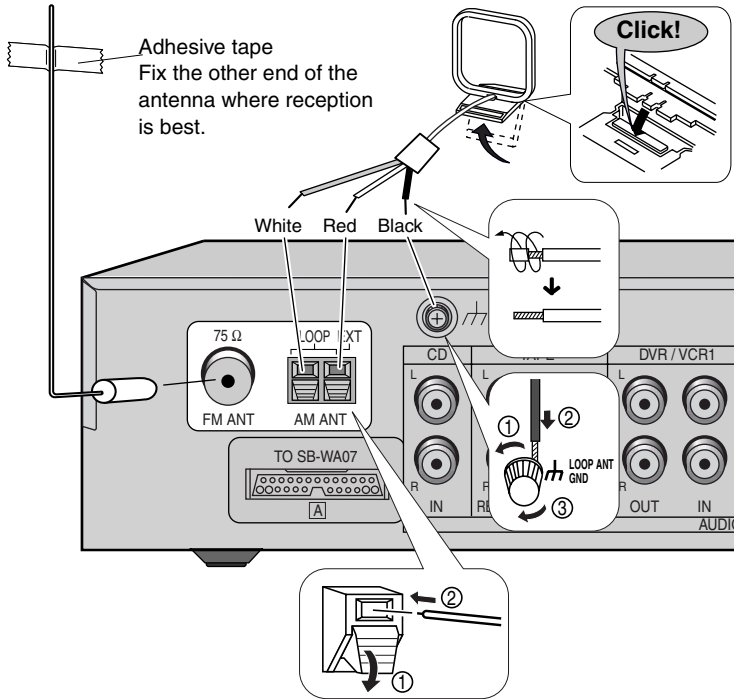

#### For best reception

#### FM outdoor antenna (not included)

- Disconnect the FM indoor antenna.
- The antenna should be installed by a competent technician.

#### FM outdoor antenna

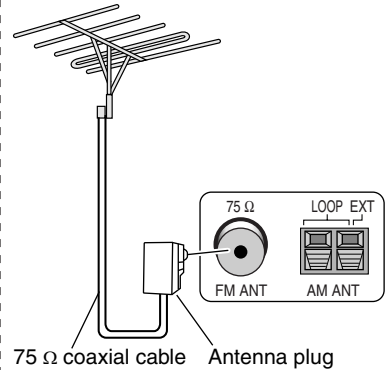

Keep the antenna cord away from DVD players and other cords.

### DVD recorder or VCR

- Do not bend the optical fiber cable.

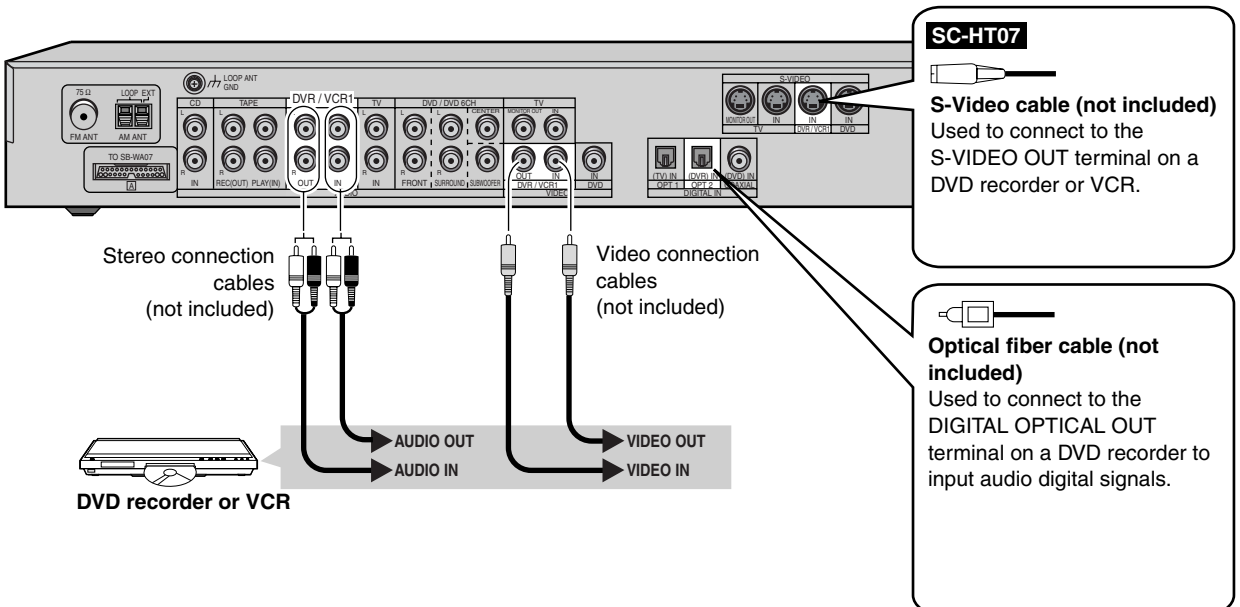

**Supplied accessories**

FM indoor antenna



(x 1)

AM loop antenna



(x 1)

**TV (Input source)**

- Do not bend the optical fiber cable.

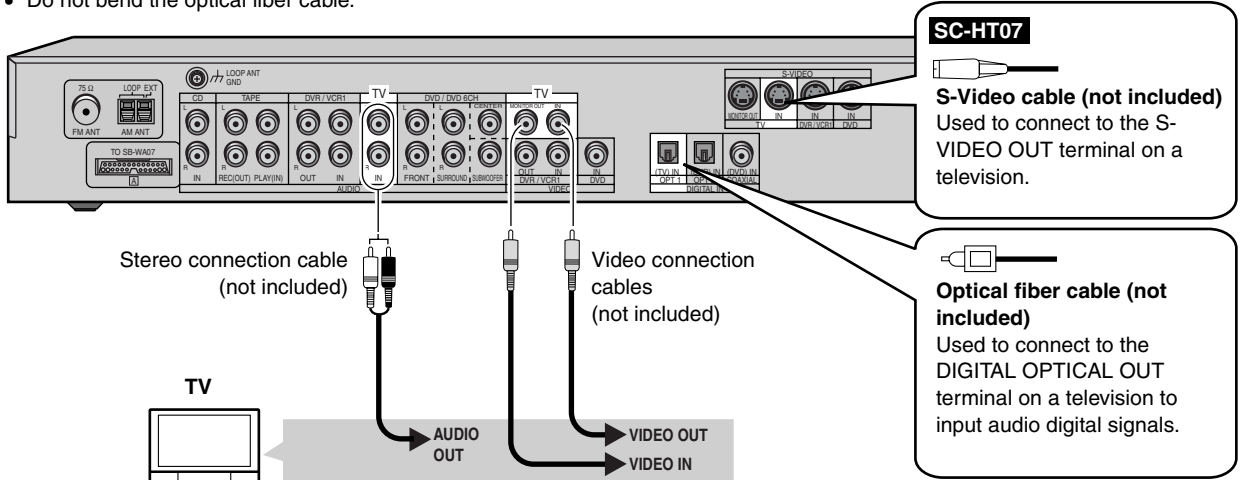

**Cassette deck**

**SC-HT07**

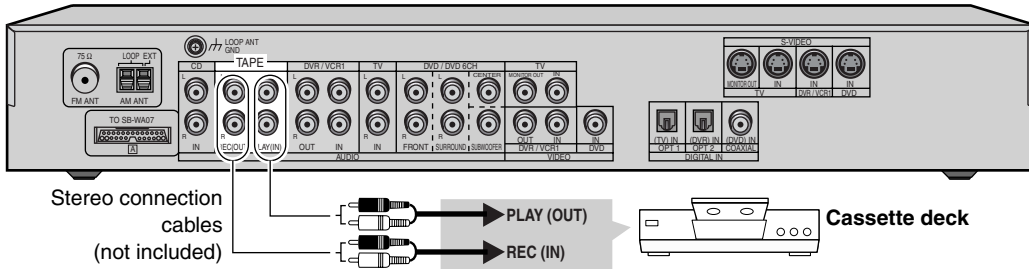

**CD player**

**SC-HT07**

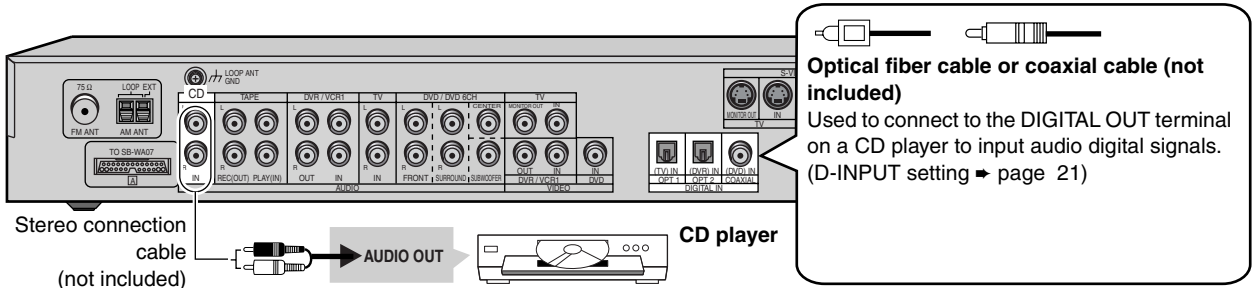





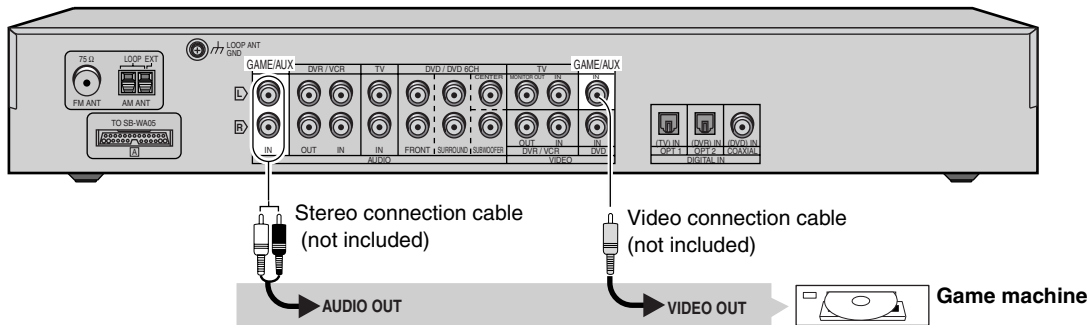

**Game machine or other AV equipment**

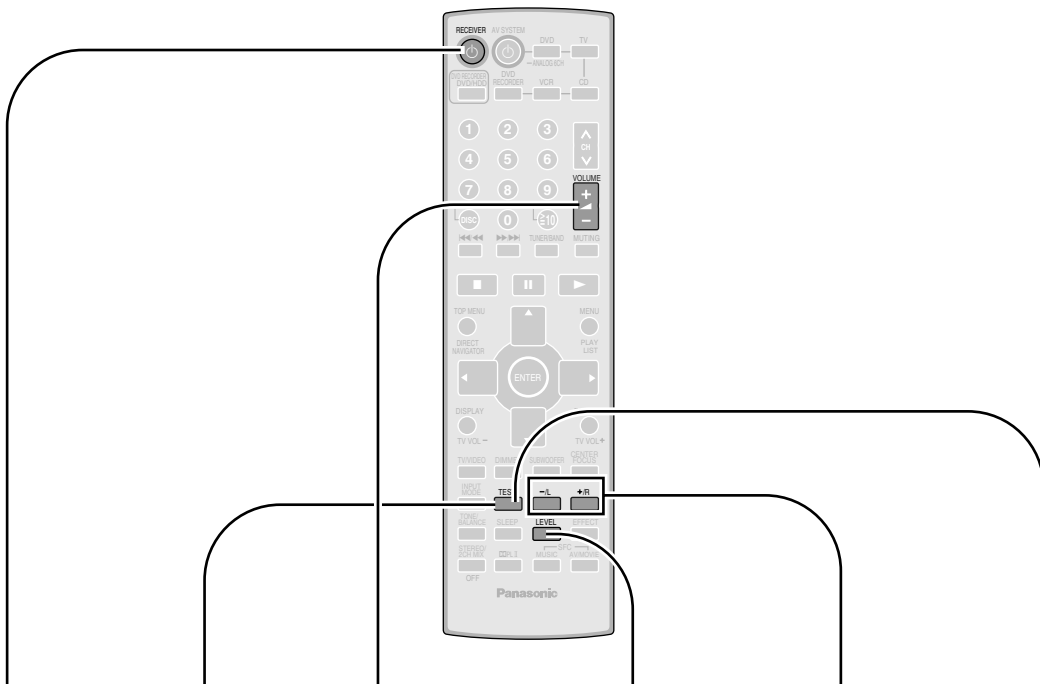
**SC-HT05**



## Adjusting speaker output level



- 1**  
RECEIVER  
  
Switch on.
- 2**  
TEST  
  
Output the signal.
- 3**  
VOLUME  
  
Adjust the main volume.
- 4**  
LEVEL  
  
Select the speaker channel.
- 5**  
-/L    +/R  
  
Adjust the level.  
Repeat steps 4 and 5
- 6**  
TEST  
  
Stop the test signal.

C (center), RS (right surround) and LS (left surround) can be adjusted between  $-10$  dB and  $+10$  dB, with  $0$  dB being the level of the front speakers. Adjust center and surround output to the same apparent level of the front speakers.

For SW (subwoofer), you can select “- -” so there is no output, “MIN” for minimum output, a level between 1 and 19, or “MAX” for maximum output. Adjust subwoofer output so it is balanced with the front speakers.

Subwoofer output is easily influenced by the source. You can also change its level while playing something for better effect  
 ➔ page 19).

# Basic operations

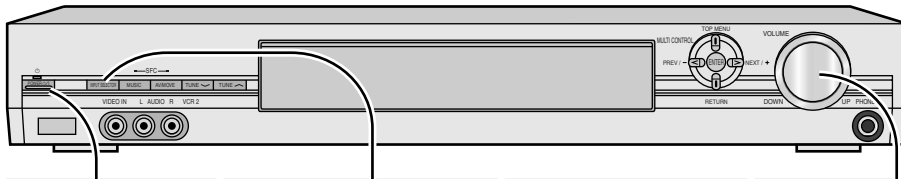

**1**

POWER

**Switch on.**

**2**

INPUT SELECTOR

**SC-HT07**  
TUNER → CD → DVD → TV  
↑  
TAPE ← VCR2 ← DVR/VCR1

**SC-HT05**  
TUNER → DVD → TV  
↑  
GAME/AUX ← DVR/VCR

**3**

**Start play of the source.**  
The unit sets the sound mode to suit the input signal.

**4**

VOLUME

DOWN UP

**Adjust the volume.**

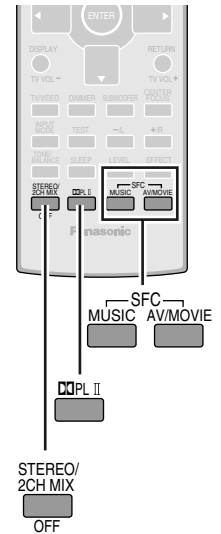

## Sound modes

### Adding surround effects to stereo sources

#### Using Dolby Pro Logic II

Dolby Pro Logic II processor works not only on sources recorded with Dolby Surround, but also on any stereo source.

The following modes are available when using Dolby Pro Logic II

You can make fine surround settings when in the MUSIC or PANORAMA mode. (► page 19)

#### Using the Sound Field Control (SFC)

Enjoy an enhanced sound experience with greater presence and spread by using these SFC modes with PCM or analog stereo sources.

Choose from the following modes.

You can make delay time setting when in the SFC mode. (► page 19)

Dolby Pro Logic II and SFC modes remain in effect until you change them.

- **To return to stereo sound**  
Press [STEREO/2CH MIX].

### Listening to multi-channel sources in stereo

When surround sources are played in this mode, the sounds intended for the other speaker channels are played through the front speakers.

The 2CH MIX mode remains in effect until you change input mode or turn off the unit.

- **To return to stereo sound**  
Press [STEREO/2CH MIX].

	<b>MOVIE</b> Use this mode when playing movie software, especially videotapes, recorded in Dolby Surround.
	<b>MUSIC</b> Adds surround effects to stereo sources.
 	<b>PANORAMA</b> Sound is spread out more so you feel like you are surrounded by music.
	<b>LIVE</b> Brings you up close for "live" stage performance and smoother vocals.
	<b>POP/ROCK</b> For pop, rock, and other music that has a punch to it.
	<b>VOCAL</b> For adding gloss to vocals.
	<b>JAZZ</b> Conveys the exciting and intimate atmosphere of a jazz club.
	<b>DANCE</b> For dance music and other sounds with a strong beat.
	<b>PARTY</b> This mode uses the front and surround speakers so that sound is in stereo regardless of the direction you are facing.
	<b>DRAMA</b> For dramas and other material where dialog is important.
	<b>ACTION</b> For action movies and other material where impact is important.
	<b>SPORTS</b> To make you feel like you were in the stadium.
<b>MUSICAL</b> For musicals and other material where music is important.	
<b>GAME</b> Enjoy gaming with more impact.	
<b>MONO</b> For monaural sound.	

#### Note

- When input is PCM with sampling frequencies of 96 or 88.2 kHz, you cannot add surround effects with Dolby Pro Logic II or SFC.
- When input is Dolby Digital or DTS, you cannot use SFC.

# Control guide

## Main unit

### [SFC, MUSIC, AV/MOVIE]

For selecting sound field control modes.

### [INPUT SELECTOR]

For selecting input.

### Standby indicator [⏻]

When the unit is connected to the AC mains supply, this indicator lights up in standby mode and goes out when the unit is turned on.

### [POWER ⏻/⏻]

Press to switch the unit from on to standby mode or vice versa.

In standby mode, the unit is still consuming a small amount of power.

### Remote control signal sensor

### SC-HT07

### [VCR 2]

Connect equipment like video cameras.

### [TUNE∨, TUNE∧]

For tuning the radio and selecting preset stations.

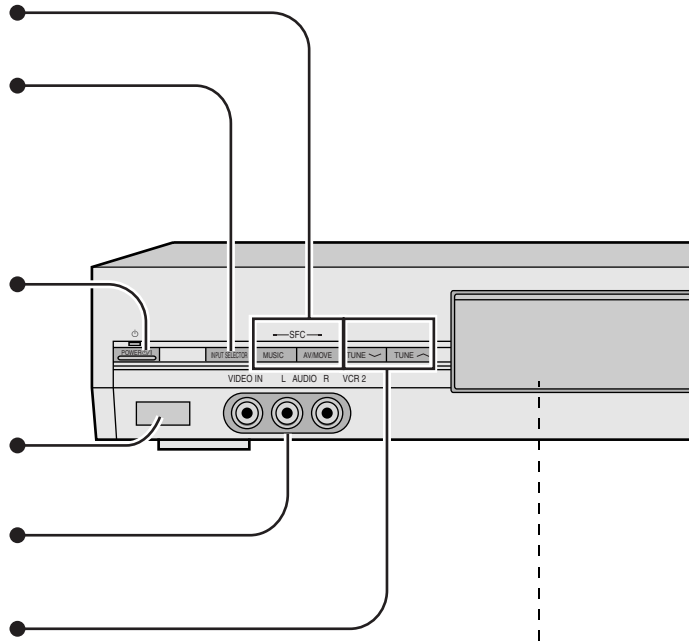

## Display

### [DIGITAL INPUT]

Program format indicators  
Show the channels contained in the digital input signal.

They do not light when input is analog.

**L:** Front left channel

**C:** Center channel

**R:** Front right channel

**LS:** Surround left channel

**S:** If the surround channel is monaural.

**RS:** Surround right channel

**LFE (Low Frequency Effects):** Deep-bass effect.

### [DIGITAL, dts, PRO LOGIC]

Light to indicate the source's input signal and decoding format used.

### [TUNED, M, MONO, ST ]

Radio indicators

**TUNED:** A station is tuned.

**M:** Flashes or lights during presetting.

**MONO:** You have switched to monaural mode with [FM MODE] to improve reception.

**ST:** A stereo FM broadcast is tuned.

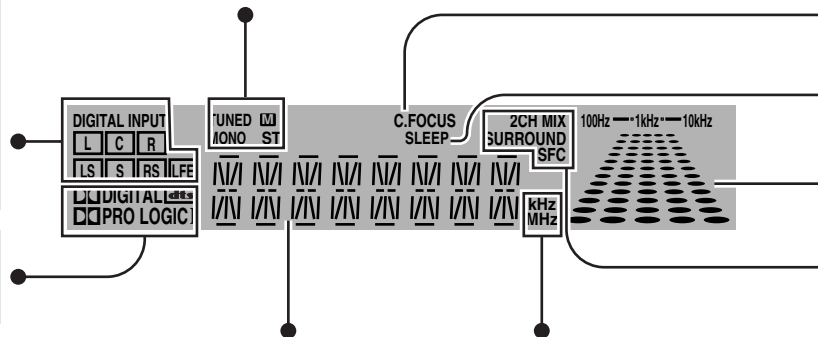

### General display

Shows the input mode, radio frequency, and other general information.

### [kHz, MHz]

Frequency unit indicators  
**kHz:** AM, or PCM sampling frequency  
**MHz:** FM

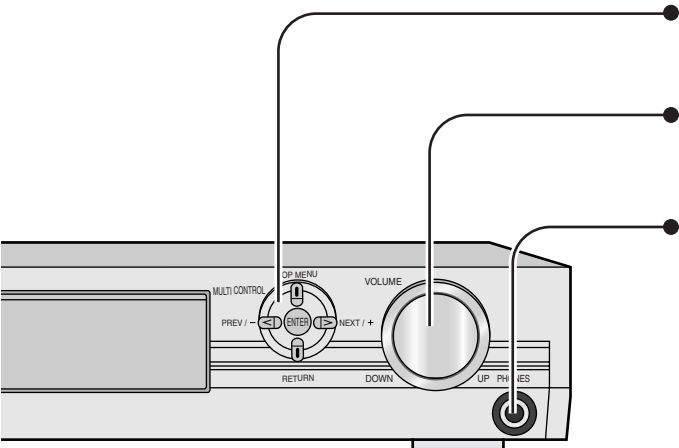

#### [MULTI CONTROL]

For presetting radio stations and various other settings.  
 (→ page 17)

#### [VOLUME]

Volume control.

#### [PHONES]

Headphone jack

Plug type: 3.5 mm (1/8") stereo

- Sound does not come from the speakers if you connect headphones.
- Avoid listening for prolonged periods of time to prevent hearing damage.

#### For your reference

##### • When playing video sources connected to DVD

The picture remains on the screen even if you select an audio source.

Manufactured under license from Dolby Laboratories.

“Dolby”, “Pro Logic” and the double-D symbol are trademarks of Dolby Laboratories.

“DTS” and “DTS Digital Surround” are registered trademarks of Digital Theater Systems, Inc.

#### [C.FOCUS]

Appears when you are using Center Focus

#### [SLEEP]

Sleep timer indicator

#### Spectrum analyzer display

#### [2CH MIX, SURROUND, SFC]

**2CH MIX:** Appears when you are playing a multi-channel source in 2CH MIX mode

**SURROUND:** Appears when you are playing through multiple channels

**SFC:** Appears when you are using an SFC mode



## Remote control

This page describes the buttons used to control this unit.  
See the guide starting page 22 for the buttons that control other units.

### [, RECEIVER]

Standby/on button.

### [1, 2, 3, 4, 5, 6, 7, 8, 9, 0]

To enter radio frequencies and channels.

### [ $\geq 10$ , ENTER]

To enter two digit channels.

### [DISC, DIRECT TUNING]

To enable selection of radio stations by frequency.

### [TUNER/BAND]

For switching between FM and AM.

### [ $\wedge$ , CH, $\vee$ ]

For selecting preset radio channels.

### [DIMMER]

For dimming the unit's display.

### [INPUT MODE]

For selecting AUTO, ANALOG or DIGITAL.

### [STEREO/2CH MIX OFF]

For selecting STEREO or 2CH MIX mode.

### [

For selecting a Dolby Pro Logic II mode: MOVIE, MUSIC or PANORAMA.

### [MUSIC]

For selecting SFC modes: LIVE, POP/ROCK, VOCAL, JAZZ, DANCE or PARTY.

### [AV/MOVIE]

For selecting SFC modes: DRAMA, ACTION, SPORTS, MUSICAL, GAME or MONO.

### [SLEEP]

To start the sleep timer.

### SC-HT07

[DVD, -ANALOG 6CH] [TV]  
[DVD RECORDER] [VCR] [CD]

### SC-HT05

[DVD, -ANALOG 6CH] [TV]  
[DVD RECORDER] [VCR] [GAME/AUX]  
Input mode and remote control mode buttons.

### [DVD, -ANALOG 6CH]

Press and hold and DVD input switches between 6-channel and 2-channel.

### [+, -, VOLUME]

To adjust the volume.

### [MUTING]

To mute the volume.

### [SUBWOOFER]

For selecting subwoofer level.

### [TEST]

To start the speaker test signal.

### [TONE/BALANCE]

To adjust the bass, treble and front speaker balance.

### [LEVEL]

Use when adjusting speaker level.

### [EFFECT]

Use when adjusting Dolby Pro Logic II or SFC effects.

### [-/L, +/R]

First select SLEEP, EFFECT, LEVEL, TONE or BALANCE, then press [-/L] or [+R] to adjust.

### [CENTER FOCUS]

For selecting center focus mode.

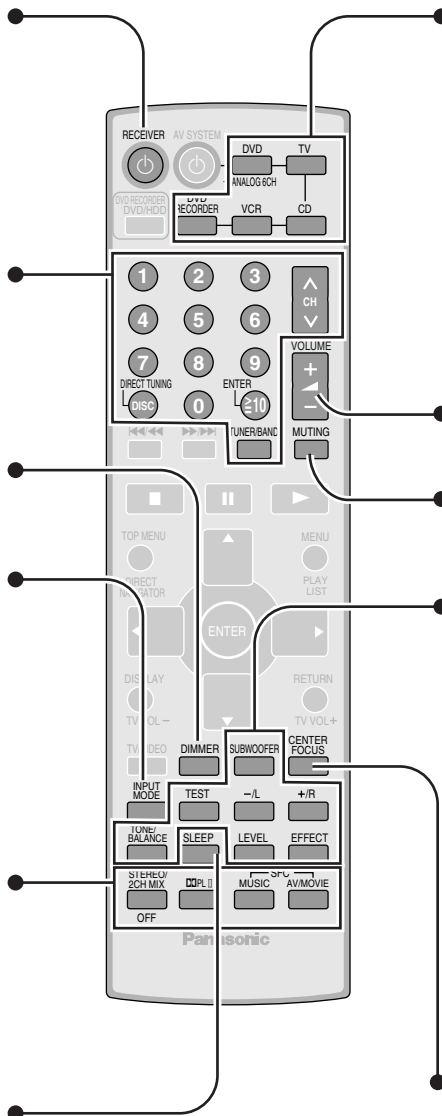

## MULTI CONTROL operations

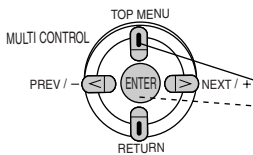

This is an outline of the operations you can perform with the MULTI CONTROL.  
See pages 18, 20, and 21 for details.

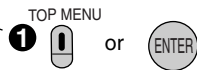

2 Top menu	3 Sub menu (Level 1)	(Level 2)	(Level 3)
<b>TUNER</b> Tuner (Only when input is TUNER)	<b>TUNING</b> Tuning mode  <b>FM MODE</b> FM mode  <b>MEMORY</b> Memory  <b>AUTO MEM</b> Auto memory	<b>MANUAL</b> <b>PRESET</b>  <b>AUTO</b> <b>MONO</b>  <b>CH1</b> ..... <b>CH30</b>  <b>START</b>	
<b>TONE</b> Tone	<b>BASS</b> <b>TREBLE</b>	<b>-10dB</b> ..... <b>0dB</b> ..... <b>+10dB</b>	
<b>BALANCE</b> Balance	<b>L</b> ▽ <b>R</b> ..... <b>L</b> ▽ <b>R</b> ..... <b>L</b> ▽ <b>R</b>		
<b>DIMMER</b> Dimmer	<b>OFF</b>  <b>ON</b>	<b>LEVEL1</b> <b>LEVEL2</b> <b>LEVEL3</b>	
<b>SLEEP</b> Sleep timer	<b>OFF</b> <b>30</b> <b>60</b> <b>90</b> <b>120</b>		
<b>OPTION</b> Option	<b>DR COMP</b> Dynamic range compression  <b>A/D ATT</b> A/D attenuator  <b>SPECTRUM</b> Spectrum display  <b>DTS-PCM</b>	<b>OFF</b> <b>STANDARD</b> <b>MAX</b>  <b>OFF</b> <b>ON</b>  <b>ON</b> <b>OFF</b>  <b>OFF</b> <b>ON</b>	
<b>SETUP</b> Setup	<b>D-INPUT</b> Digital input  <b>RESET</b> Reset	<b>CD</b> <b>TV</b> (SC-HT07)  <b>DVR</b> <b>DVD</b>  <b>NO</b> <b>YES</b>	<b>NONE</b> <b>OPT1</b> (SC-HT07)  <b>OPT2</b> <b>COAX</b>
<b>To exit</b>  <b>EXIT</b>			

- Press [RETURN] to return to the level above.
- Press [TOP MENU] to return to the Top menu.
- Pressing [RETURN] or [TOP MENU] while the Top menu is displayed takes you immediately to EXIT.

**Note**

“TONE” does not appear when using a Dolby Pro LogicII or SFC mode.

# The radio

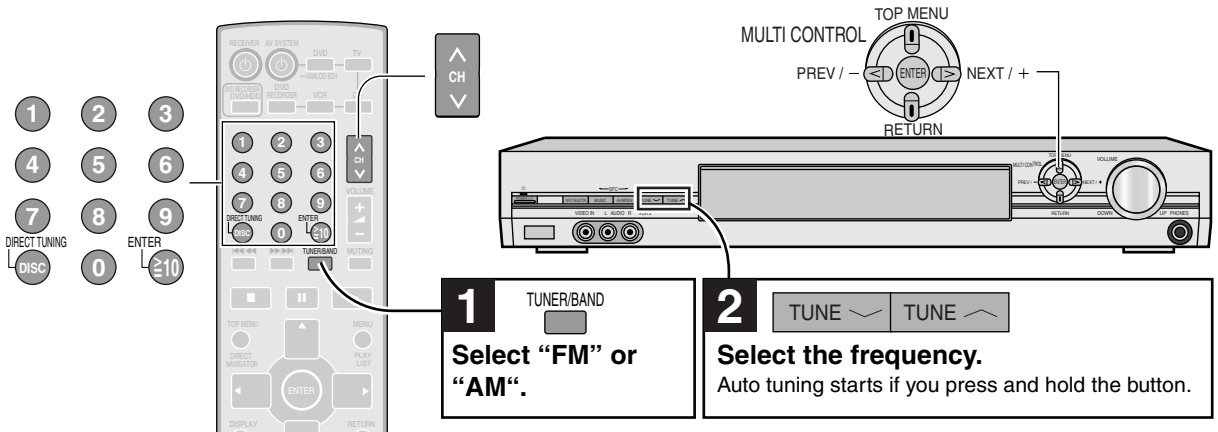

## Direct tuning

Input the frequency of the station.

### Remote control

1. Press [TUNER/BAND] to select "FM" or "AM".
  2. Press [DISC, DIRECT TUNING].
  3. Press the numbered buttons to enter the frequency.  
e.g. To select 107.9 MHz, press [1] → [0] → [7] → [9]
- If you do not press a button while the cursor is flashing, the display returns to the frequency being received.
  - If the frequency has not been input correctly, "ERROR" will be displayed.

## FM mode

You can improve FM reception by switching reception to monaural.

### MULTI CONTROL

1. Press [TOP MENU].
2. Press [<, >] to select "TUNER".  
→ [ENTER]
3. Press [<, >] to select "FM MODE".  
→ [ENTER]
4. Press [<, >] to select "MONO".  
→ [ENTER]  
Select "AUTO" to cancel.

## Automatic presetting

The FM stations the unit can receive are preset in channels 1 to 30. The AM stations the unit can receive are preset in channels 21 to 30. (FM stations are replaced if any were preset in these channels.)

**Preparation:** Tune to either FM 87.9 MHz or AM 530 kHz.

### MULTI CONTROL

1. Press [TOP MENU].
2. Press [<, >] to select "TUNER".  
→ [ENTER]
3. Press [<, >] to select "AUTO MEM".  
→ [ENTER] ("START" lights.) → [ENTER]

During automatic presetting, the memory indicator (M) flashes and the frequency scrolls. The memory indicator and channel numbers are displayed for a second when a station is preset. The last station to be preset is displayed when presetting finishes.

### For your reference

Even if the power supply cord is disconnected from the household AC outlet, the stations remain in memory for approximately two weeks.

## Manual presetting

Preset the stations one at a time.

**Preparation:** Tune to the station you want to preset.

### MULTI CONTROL

1. Press [TOP MENU].
2. Press [<, >] to select "TUNER".  
→ [ENTER]
3. Press [<, >] to select "MEMORY".  
→ [ENTER]
4. Press [<, >] to select a channel.  
→ [ENTER] ("STORED" lights.)

### For your reference

FM stations can also be preset in the MONO mode.

## Selecting channels

### Remote control

Press [V, CH, ^].

or

Press the numbered buttons.

For channels 1 to 9, press the corresponding number.

For channels 10 or over, press [ ≥ 10, ENTER], then the two digits.

e.g. To select channel 21: [ ≥ 10, ENTER] → [2] → [1]

### On the main unit

Switch the tuning mode to "PRESET".

### MULTI CONTROL

1. Press [TOP MENU].
  2. Press [<, >] to select "TUNER".  
→ [ENTER] ("TUNING" lights.) → [ENTER]
  3. Press [<, >] to select "PRESET".  
→ [ENTER]  
Select "MANUAL" to cancel.
- Main unit**
4. Press [TUNE∨, TUNE∧] to select a channel.

# Other functions

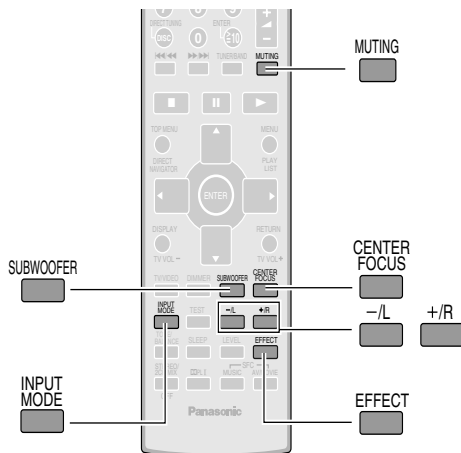

## Center focus

(Disc where the dialogue is recorded in the center channel)  
You can make the sound of the center speaker seem like it is coming from within the television.

Remote control

**Press [CENTER FOCUS].**

“C.FOCUS” lights.

The factory setting is off.

## Subwoofer level

For selecting subwoofer level.

Remote control

**Press [SUBWOOFER].**

Adjust the level in 5 steps:

SW MIN, SW 5, SW 10, SW 15, and SW MAX.

Select SW - - - to stop output.

### Note

Sound can be distorted if you raise the volume while subwoofer level is high. Reduce subwoofer level if this occurs.

## Input mode

This unit automatically detects whether input is digital or analog, but you can fix the input mode.

Remote control

**Press [INPUT MODE] to select "AUTO", "ANALOG" or "DIGITAL".**

## PCM/DTS fix mode

In rare cases, the unit may have trouble recognizing the digital signals on discs.

- With the PCM signals on CDs, this may cause the beginning of a track to be cut off. Engage the PCM FIX mode if this occurs.
- With DTS, the signals may not be recognized at all. Engage the DTS FIX mode if this occurs.

While the input source is selected:

Remote control

**1. Press [INPUT MODE] to select “DIGITAL”**

**2. Press and hold [INPUT MODE] for four seconds.**

The current mode is displayed. Press again to change the mode.

Each time you press the button:

AUTO → PCM FIX → DTS FIX

When a FIX mode is on, the unit cannot process other signals. This may cause noise to be output. Select “AUTO” if this occurs. The mode returns to AUTO when you switch the unit to standby.

### For your reference

If you are playing a DTS CD that contains both DTS and PCM, but it isn't playing properly, then do the following after step 1 above: Use the MULTI CONTROL to enter the “OPTION” – “DTS-PCM” menu and select “YES”. If this causes noise to occur, return the setting to “NO”. (This setting is effective for each digital source.)

## Center Width Control "C-WIDTH"

You can adjust the effect of MUSIC and PANORAMA with the center width control.

This adjustment helps you realize a more natural sound image when listening to music. Move sound out into the front speakers to improve the overall front image, or add sound to the center speaker to fix the center image.

You can choose a level between 0 (the center speaker is dominant) and 7 (center sound is spread out).

The default level is 3.

Remote control

- 1. Press [EFFECT] to select “C-WIDTH”.**
- 2. Press [-/L] or [+/R] to adjust the effect.**

## Dimension Control "DIMEN"

You can adjust the effect of MUSIC and PANORAMA with the dimension control.

You can make up for differences in the output level of the front and surround speakers.

You can choose a level between -3 and +3 — Increase the level to move sound to the front speakers, decrease to move it to the surround speakers.

The default is level 0.

Remote control

- 1. Press [EFFECT] to select “DIMEN”.**
- 2. Press [-/L] or [+/R] to adjust the effect.**

## Delay time

### SFC mode only

By adjusting the delay time, the difference in the distance from the listening position to the front speakers and the distance to the surround speakers can be offset and made equal.

The default is 50 ms. (10 ms – 100 ms)

Remote control

- 1. Press [EFFECT].**
- 2. Press [-/L] or [+/R] to adjust the delay time.**

## Muting

Remote control

**Press [MUTING].**

To cancel

Press [MUTING] again.

Muting is also canceled when the unit is turned off.

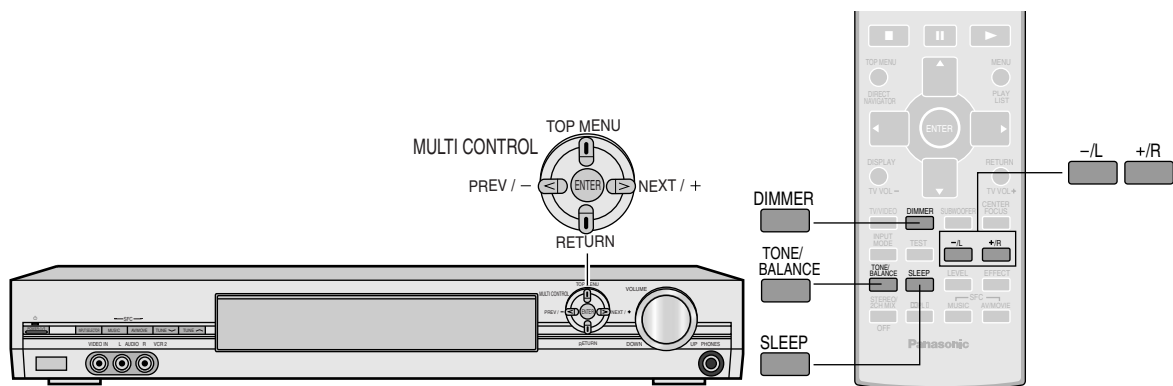

## Tone

You can adjust the level of the bass and treble.

### MULTI CONTROL

1. Press [TOP MENU].
2. Press [<, >] to select "TONE".
  - ➔ [ENTER]
3. Press [<, >] to select "BASS" or "TREBLE".
  - ➔ [ENTER]
4. Press [<, >] to adjust bass/treble.
  - ➔ [ENTER]

### Remote control

Press [TONE/BALANCE] to select "BASS" or "TREBLE".  
Press [-/L] or [+/R] to adjust bass/treble.

### Note

"TONE" does not appear when using a Dolby Pro Logic II or SFC mode.

## Balance

You can adjust the balance of the front speakers.

### MULTI CONTROL

1. Press [TOP MENU].
2. Press [<, >] to select "BALANCE".
  - ➔ [ENTER]
3. Press [<, >] to adjust.
  - ➔ [ENTER]

### Remote control

Press [TONE/BALANCE] to select "BALANCE".  
Press [-/L] or [+/R] to adjust.

## Dimmer

Dim the display for better viewing in a darkened room.

### MULTI CONTROL

1. Press [TOP MENU].
2. Press [<, >] to select "DIMMER".
  - ➔ [ENTER]
3. Press [<, >] to select "ON".
  - ➔ [ENTER]
4. Press [<, >] to select "LEVEL1", "LEVEL2" or "LEVEL3".
  - ➔ [ENTER]

### Remote control

Press [DIMMER] to select dim or bright.

## Dynamic range compression

Change this setting to listen to software recorded with Dolby Digital at low volume (such as late at night) and maintain audio clarity. It reduces the peak level in loud scenes without affecting the sound field.

### MULTI CONTROL

1. Press [TOP MENU].
2. Press [<, >] to select "OPTION".
  - ➔ [ENTER] ("DR COMP" lights.) ➔ [ENTER]
3. Press [<, >] to select "OFF", "STANDARD" or "MAX".
  - ➔ [ENTER]

### OFF:

The software is played with the original dynamic range (factory setting).

### STANDARD:

The level recommended by the producer of the software for household viewing.

### MAX:

The maximum allowable compression (recommended for night viewing).

## A/D attenuator

Turn the A/D attenuator on if "OVERFLOW" lights frequently when using 2-channel analog input.

### MULTI CONTROL

1. Press [TOP MENU].
2. Press [<, >] to select "OPTION".
  - ➔ [ENTER]
3. Press [<, >] to select "A/D ATT".
  - ➔ [ENTER]
4. Press [<, >] to select "ON" or "OFF".
  - ➔ [ENTER]

## Spectrum display

Switch the spectrum analyzer display on or off.

### MULTI CONTROL

1. Press [TOP MENU].
2. Press [<, >] to select "OPTION".
  - ➔ [ENTER]
3. Press [<, >] to select "SPECTRUM".
  - ➔ [ENTER]
4. Press [<, >] to select "ON" or "OFF".
  - ➔ [ENTER]

## Using the VCR2 terminals (for SC-HT07)

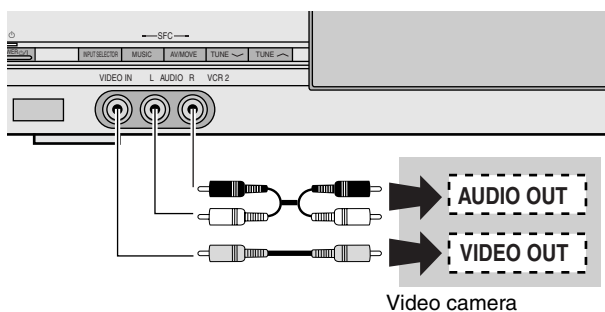

These terminals are convenient for equipment you want to connect only temporarily. Select "VCR2" for input.

## Making a recording

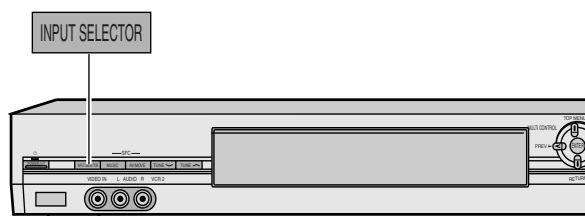

### Recording on other equipment

You can record to a tape deck connected to TAPE REC OUT (SC-HT07), or a DVD recorder/VCR connected to DVR/VCR1 (DVD/VCR) OUT.

1. Press [INPUT SELECTOR] to select the source to be recorded.
2. Begin recording.
3. Start the source to be recorded.

#### Note

- (SC-HT07) With a tape deck, you can record any analogue source except TAPE.
- With a DVD recorder/VCR, you can record any analogue source except DVR/VCR1 (DVR/VCR).
- When you select DVD 6CH INPUT mode, only sound from the front left and right channels is recorded.
- Some sources do not allow digital recording. Connect through the analog terminals and select "ANALOG" input.

## The RESET function

The operation settings for the unit will be initialized to the settings made at the time of shipment.

However, any preset radio stations will not be erased.

#### MULTI CONTROL

1. Press [TOP MENU].
2. Press [<, >] to select "SETUP".
  - ➔ [ENTER]
3. Press [<, >] to select "RESET".
  - ➔ [ENTER]
4. Press [<, >] to select "YES".
  - ➔ [ENTER]

## D-INPUT (Digital input)

Change the setting for the DIGITAL IN terminals (OPT1, OPT2, COAXIAL) on the rear of the unit if the equipment you have connected is different to that labeled.

#### MULTI CONTROL

1. Press [TOP MENU].
2. Press [<, >] to select "SETUP".
  - ➔ [ENTER] ("D-INPUT" lights.) ➔ [ENTER]
3. Press [<, >] to select "CD" (SC-HT07 only), "TV", "DVR" or "DVD".
  - ➔ [ENTER]
4. Press [<, >] to select "NONE" (SC-HT07 only), "OPT1", "OPT2" or "COAX".
  - ➔ [ENTER]

The factory settings are:

#### SC-HT07

CD: NONE  
TV: OPT1  
DVR: OPT2  
DVD: COAX

#### SC-HT05

TV: OPT2  
DVR: COAX

#### Note

You can allocate only one piece of equipment per terminal. So for example if you change "TV" for "OPT1" to "OPT2", "DVR" will automatically switch to "OPT1".

## Sleep timer

The SLEEP timer can turn the unit off after a set time. It does not control any other components.

#### MULTI CONTROL

1. Press [TOP MENU].
2. Press [<, >] to select "SLEEP".
  - ➔ [ENTER]
3. Press [<, >] to select the required time.
 

The display changes as follows:

OFF ↔ 30 ↔ 60 ↔ 90 ↔ 120 (minutes)

  - ➔ [ENTER]

#### Remote control

Press [SLEEP].

Press [-/L] or [+R] to select the required time.

#### To check the setting

Press [SLEEP] on the remote control once.

The time remaining appears.

#### To change a setting

Repeat the procedure from the beginning.

# Remote control operation guide

This remote control can operate Panasonic and Technics audiovisual equipment that have remote control sensors. Note that this remote control cannot operate some equipment and that it may not be able to perform some operations.

DVD



## Watching DVDs

### Switch on

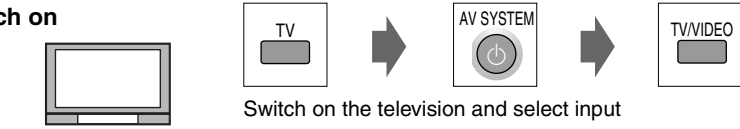

Switch on the television and select input

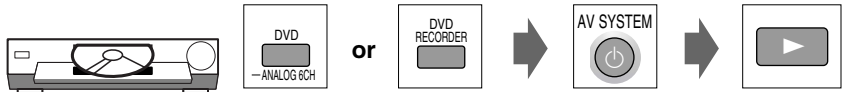

Switch on the player and start play

### Switch off

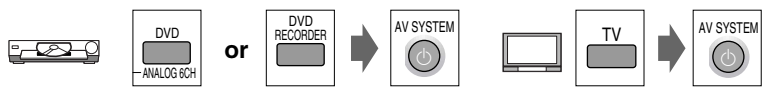

## Operating the DVD player



Show disc menus

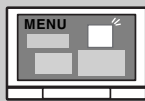

Show disc menus

Select and enter menu items

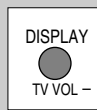

Show player menus

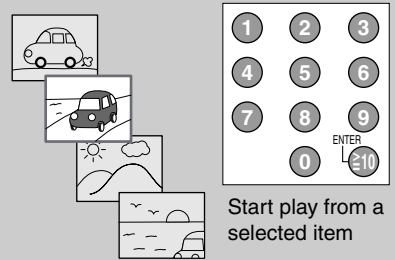

Start play from a selected item

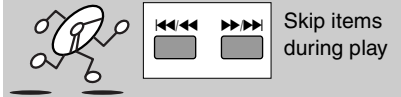

Skip items during play

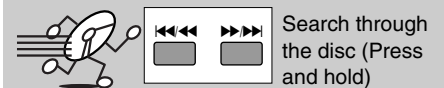

Search through the disc (Press and hold)



Start slow-motion play



To view frame-by-frame



Clear menus or return to previous menus

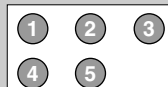

Specify a disc [5-disc changer]



Stop play



Pause play



Switch between DVD and HDD [DVD recorder with HDD]





### Watching TV

#### Switch on

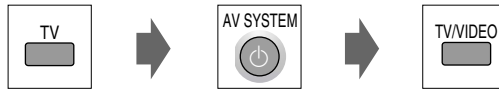
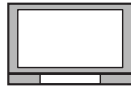

Switch on the television and select input

#### Switch off

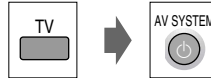

### Operating the TV

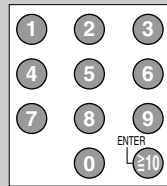
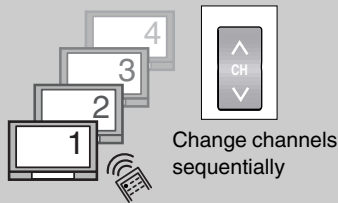

Select channels directly

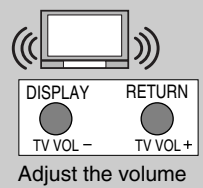

### Watching videotapes

#### Switch on

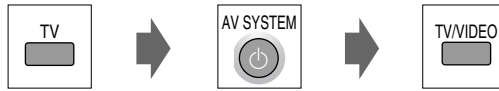

Switch on the television and select input

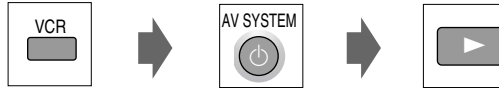
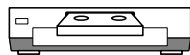

Switch on the player and start play

#### Switch off



### Operating the video deck

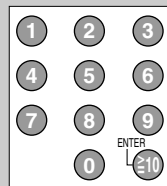
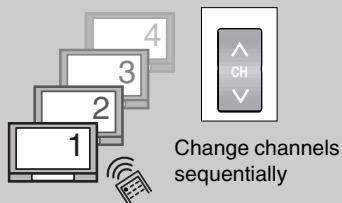

Select channels directly



Rewind or fast-forward



Stop play



Pause play



### Listening to CDs

**Switch on**

Switch on the player and start play

---

**Switch off**

---

### Operating the CD player

**Start play from a selected track**

Start play from a selected track

**Specify a disc [3- or 5-disc changer]**

Specify a disc [3- or 5-disc changer]

**Skip tracks during play**

Skip tracks during play

**Search through the disc (Press and hold)**

Search through the disc (Press and hold)

**Pause play**

Pause play

**Stop play**

Stop play

**Start play from a specified disc [MEGA CD changer] (holds more than 50 discs)**

Start play from a specified disc [MEGA CD changer] (holds more than 50 discs)

## Advance setup (For those with expertise)

You can also change the speaker settings.

### MULTI CONTROL

1. Press [**<**] and [**>**] at the same time.
  2. Press [**<**, **>**] to select the sub menu. ➔ [ENTER]
- If there is a menu in level 2 as well, repeat step 2 to make the settings.

- Press [RETURN] to return to the level above.
- Press [TOP MENU] to return to the Top menu.
- Pressing [RETURN] or [TOP MENU] while the Top menu is displayed takes you immediately to the EXIT menu.

Note

**Change these settings only if necessary.**

	Top menu	Sub menu (Level 1)	Sub menu (Level 2)
SPEAKERS	<b>Optional speakers only</b> Set the size to suit your speakers. (Large: For speakers that can reproduce the bass range below 100 Hz)	FRONT CENTER SURROUND SUB-WFR	SMALL, LARGE NONE, SMALL, LARGE NONE, SMALL, LARGE NO, YES
DISTANCE	Enter the distance of the front, center and surround speakers from the seating position.	FRONT CENTER SURROUND	3 FEET ..... 30 FEET 3 FEET ..... 30 FEET 3 FEET ..... 30 FEET
FILTER	Change the cut-off for bass output from the front speakers	100, 150, 200 (Hz)	
EXIT	Exit		SAVE, NO

# Specifications (IHF'78)

## ■ AMPLIFIER SECTION

### RMS output power of each channel driven

#### 10 % total harmonic distortion

1 kHz front CH	[SC-HT07] 60 W per channel (6 Ω) [SC-HT05] 55 W per channel (6 Ω)
1 kHz surround CH	[SC-HT07] 60 W per channel (6 Ω) [SC-HT05] 55 W per channel (6 Ω)
1 kHz center CH	[SC-HT07] 220 W per channel (6 Ω) [SC-HT05] 160 W per channel (6 Ω)
100 Hz subwoofer CH	[SC-HT07] 240 W per channel (4 Ω) [SC-HT05] 220 W per channel (4 Ω)
<b>Total RMS output power</b>	[SC-HT07] 700 W [SC-HT05] 600 W

### Rated minimum sine wave RMS power output

#### 1 % total harmonic distortion (Dolby Digital mode)

120 Hz-20kHz front CH	[SC-HT07] 35 W per channel (6 Ω) [SC-HT05] 30 W per channel (6 Ω)
120 Hz-20 kHz surround CH	[SC-HT07] 35 W per channel (6 Ω) [SC-HT05] 30 W per channel (6 Ω)
120 Hz-20 kHz center CH	[SC-HT07] 140 W per channel (6 Ω) [SC-HT05] 110 W per channel (6 Ω)
45 Hz-120 Hz subwoofer CH	[SC-HT07] 150 W per channel (4 Ω) [SC-HT05] 140 W per channel (4 Ω)
<b>Total FTC output power</b>	[SC-HT07] 430 W [SC-HT05] 370 W

### Rated minimum sine wave RMS power output

#### 1 % total harmonic distortion (Stereo mode)

120 Hz-20 kHz front CH	[SC-HT07] 35 W per channel (6 Ω) [SC-HT05] 25 W per channel (6 Ω)
45-120 Hz subwoofer CH	140 W per channel (4 Ω)
<b>Total FTC output power</b>	[SC-HT07] 210 W [SC-HT05] 190 W

### Total harmonic distortion

Half power at 1 kHz (Front CH) 0.1 % (6 Ω)

### Input sensitivity

[SC-HT07] DVD, DVR/VCR1, TV, TAPE, CD, VCR2	450 mV, IHF'66
[SC-HT05] DVD, DVR/VCR, TV, GAME/AUX	

### S/N (IHF A)

[SC-HT07] DVD, DVR/VCR1, TV, TAPE, CD, VCR2	75 dB (85 dB, IHF'66)
[SC-HT05] DVD, DVR/VCR, TV, GAME/AUX	

### Input impedance

[SC-HT07] DVD, DVR/VCR1, TV, TAPE, CD, VCR2	22 kΩ
[SC-HT05] DVD, DVR/VCR, TV, GAME/AUX	

### Tone controls

BASS	50 Hz, +10 to -10 dB
TREBLE	20 kHz, +10 to -10 dB

Digital input	OPTICAL	2
	COAXIAL	1

## ■ FM TUNER SECTION

Frequency range	87.9-107.9 MHz
Sensitivity	11.2 dBf (2 μV, IHF '58)
50 dB quieting sensitivity	
MONO	18.3 dBf (4.5 μV, IHF '58)
STEREO	38.3 dBf (45 μV, IHF '58)
Total harmonic distortion	
MONO	0.2 %
STEREO	0.3 %
S/N	
MONO	71 dB
STEREO	65 dB
Frequency response	20 Hz-15 kHz, +1 dB, -2 dB
Image rejection at 98 MHz	40 dB
Stereo separation	
1 kHz	40 dB
10 kHz	30 dB
Antenna terminal	75 Ω (unbalanced)

## ■ AM TUNER SECTION

Frequency range	530-1710 kHz
Sensitivity	450 μV/m
Selectivity	35 dB

## ■ VIDEO SECTION

Output voltage at 1 V input (unbalanced)	1±0.1 Vp-p
Maximum input voltage	1.5 Vp-p
Input/output impedance	75 Ω

## ■ SPEAKER SECTION

Front/Surround speaker  
(SC-HT07:SB-FS927) (SC-HT05:SB-PF725, SB-PS725)

Type	2 way, 2 speaker, bass-ref.
Speaker unit	
Full range	6.5 cm (2-1/2") cone type, 6 Ω
Super tweeter (SB-PC927, SB-PF725)	6 cm (2-3/8") ring shaped dome type, 6 Ω
Tweeter (SB-PS725)	6 cm (2-3/8") cone type, 6 Ω
Input power (IEC)	55 W (Max)
Output sound pressure level	79 dB/W (1.0 m)
Crossover frequency	[SC-HT05] 5 kHz
Frequency range	[SC-HT07] 110 Hz-25 kHz (-16 dB) 130 Hz-22 kHz (-10 dB) [SC-HT05] 95 Hz-41 kHz (-16 dB) 110 Hz-40 kHz (-10 dB)

### Dimensions (W x H x D)

[SC-HT07] 240 x MAX:1138 (MIN:678) x 240 mm (9-7/16" x MAX:44-13/16" (MIN:26-11/16") x 9-7/16")
[SC-HT05] 90 x 240 x 115 mm (3-1/2" x 7-7/16" x 3-17/32")

### Mass

[SC-HT07] 4.2 kg (9.3 lb.)
[SC-HT05] 0.89 kg (1.96 lb.)

### Center speaker (SC-HT07:SB-PC927) (SC-HT05:SB-PC725)

Type	2 way, 3 speaker, bass-ref.
Speaker unit	
Full range	6.5 cm (2-1/2") cone type x 2, 6 Ω
[SC-HT07] Super tweeter	6 cm (2-1/2") ring shaped dome type, 6 Ω
[SC-HT05] Tweeter	6 cm (2-1/2") cone type, 6 Ω
Input power (IEC)	[SC-HT07] 220 W (Max) [SC-HT05] 160 W (Max)
Output sound pressure level	[SC-HT07] 84 dB/W (1.0 m) [SC-HT05] 83 dB/W (1.0 m)
Crossover frequency	5kHz
Frequency range	[SC-HT07] 110 Hz-50 kHz (-16 dB) 130 Hz-46 kHz (-10 dB) [SC-HT05] 92 Hz-41 kHz (-16 dB) 110 Hz-40 kHz (-10 dB)

### Dimensions (W x H x D)

[SC-HT07] 320 x 97 x 93 mm (12-19/32" x 3-13/16" x 3-21/32")
[SC-HT05] 330 x 103 x 117 mm (3-11/16" x 4" x 4-5/8")

### Mass

[SC-HT07] 1.50 kg (3.3 lb.)
[SC-HT05] 1.48 kg (3.2 lb.)

### Active subwoofer (SC-HT07:SB-WA07) (SC-HT05:SB-WA05)

Type	1 way 1 speaker, bass-ref.
Speaker unit (Woofer)	17 cm (6-3/4") cone type, 4 Ω
Input power (IEC)	[SC-HT07] 240 W (Max) [SC-HT05] 220 W (Max)
Output sound pressure level	80 dB/W (1.0 m)
Frequency range	32-220 Hz (-16 dB) 36-190 Hz (-10 dB)

### Dimensions (W x H x D)

209 x 361 x 463 mm (8-7/32" x 14-7/32" x 18-7/32")

### Mass

[SC-HT07] 11.8 kg (26.0 lb.)
[SC-HT05] 11.5 kg (25.4 lb.)

## ■ GENERAL

Power supply	AC 120 V, 60 Hz
Power consumption	
(Main unit)	25 W
(Subwoofer)	[SC-HT07] 290 W [SC-HT05] 250 W
Dimensions (W x H x D) (Main unit)	430 x 68 x 287 mm (16-15/16" x 2-11/16" x 11-9/32")
Mass (Main unit)	2.0 kg (4.4 lb.)

Power consumption in standby mode:	1 W
------------------------------------	-----

### Notes:

- Specifications are subject to change without notice. Mass and dimensions are approximate.
- Total harmonic distortion is measured by the digital spectrum analyzer.

Marking sign is located on bottom of the unit.

## Maintenance

If the surfaces are dirty

To clean this unit, wipe with a soft, dry cloth.

- Never use alcohol, paint thinner or benzene to clean this unit.
- Before using chemically treated cloth, read the instructions that came with the cloth carefully.

# Listening caution



Selecting fine audio equipment such as the unit you've just purchased is only the start of your musical enjoyment. Now it's time to consider how you can maximize the fun and excitement your equipment offers. This manufacturer and the Electronic Industries Association's Consumer Electronics Group want you to get the most out of your equipment by playing it at a safe level. One that lets the sound come through loud and clear without annoying blaring or distortion-and, most importantly, without affecting your sensitive hearing.

We recommend that you avoid prolonged exposure to excessive noise.

Sound can be deceiving. Over time your hearing "comfort level" adapts to higher volumes of sound. So what sounds "normal" can actually be loud and harmful to your hearing.

Guard against this by setting your equipment at a safe level BEFORE your hearing adapts.

To establish a safe level:

- Start your volume control at a low setting.
- Slowly increase the sound until you can hear it comfortably and clearly, and without distortion.

Once you have established a comfortable sound level:

- Set the dial and leave it there.

Taking a minute to do this now will help to prevent hearing damage or loss in the future. After all, we want you listening for a lifetime.

## CAUTION!

DO NOT INSTALL OR PLACE THIS UNIT IN A BOOKCASE, BUILT-IN CABINET OR IN ANOTHER CONFINED SPACE. ENSURE THE UNIT IS WELL VENTILATED. TO PREVENT RISK OF ELECTRIC SHOCK OR FIRE HAZARD DUE TO OVERHEATING, ENSURE THAT CURTAINS AND ANY OTHER MATERIALS DO NOT OBSTRUCT THE VENTILATION VENTS.

## CAUTION!

Do not place anything on top of this unit or block the heat radiation vents in any way. In particular, do not place tape decks or CD/DVD players on this unit as heat radiated from it can damage your software.

User memo:

DATE OF PURCHASE \_\_\_\_\_  
DEALER NAME \_\_\_\_\_  
DEALER ADDRESS \_\_\_\_\_  
TELEPHONE NUMBER \_\_\_\_\_

The model number and serial number of this product can be found on either the back or the bottom of the unit. Please note them in the space provided below and keep for future reference.

MODEL NUMBER \_\_\_\_\_  
SERIAL NUMBER \_\_\_\_\_

## Product Service

1. Damage requiring service – The unit should be serviced by qualified service personnel if:
  - (a) The AC power supply cord or the plug has been damaged; or
  - (b) Objects or liquids have gotten into the unit; or
  - (c) The unit has been exposed to rain; or
  - (d) The unit does not operate normally or exhibits a marked change in performance; or
  - (e) The unit has been dropped or the cabinet damaged.
2. Servicing – Do not attempt to service the unit beyond that described in these operating instructions. Refer all other servicing to authorized servicing personnel.
3. Replacement parts – When parts need replacing ensure the servicer uses parts specified by the manufacturer or parts that have the same characteristics as the original parts. Unauthorized substitutes may result in fire, electric shock, or other hazards.
4. Safety check – After repairs or service, ask the servicer to perform safety checks to confirm that the unit is in proper working condition.

The servicer will require all components to service your system. Therefore, should service ever be necessary, be sure to bring the entire system.

### Product information

For product information or assistance with product operation: In the U.S.A., contact the Panasonic Customer Call Center at 1-800-211-7262, or e-mail [consumerproducts@panasonic.com](mailto:consumerproducts@panasonic.com), or website (<http://www.pasc.panasonic.com>). In Canada, contact Panasonic Canada Inc. Customer Care Centre at 905-624-5505, or visit website ([www.panasonic.ca](http://www.panasonic.ca)), or an authorized Service-ntre closest to you.

# Warranty (U.S.A.)

Panasonic Consumer Electronics Company,  
Division of Matsushita Electric Corporation of America  
One Panasonic Way Secaucus, New Jersey 07094

Panasonic Sales Company, Division of Matsushita Electric  
of Puerto Rico, Inc.,  
Ave. 65 de Infantería, Km. 9.5  
San Gabriel Industrial Park, Carolina, Puerto Rico 00985

## Panasonic/Technics Audio Products Limited Warranty

### Limited Warranty Coverage

If your product does not work properly because of a defect in materials or workmanship, Panasonic Consumer Electronics Company or Panasonic Sales Company (collectively referred to as "the warrantor") will, for the length of the period indicated on the chart below, which starts with the date of original purchase ("warranty period"), at its option either (a) repair your product with new or refurbished parts, or (b) replace it with a new or a refurbished product. The decision to repair or replace will be made by the warrantor.

Product or Part Name	Parts	Labor
Audio Products (except items listed below)	One (1) year	One (1) year
All Audio Racks (cabinets)	Thirty (30) days	Not Applicable
Technics Stand Alone Speakers, Subwoofer Speakers	Three (3) years	Three (3) years
USB Reader-Writer, Personal Computer Card Adapters (in exchange for defective item)	One (1) year	Not Applicable
Accessories: Headphones, Cartridges, Microphones, Adapters	Ninety (90) days	Ninety (90) days
Rechargeable Batteries, DVD-R/-RAM Discs (in exchange for defective item)	Ten (10) days	Not Applicable
SD Memory Cards, Rechargeable Battery Packs (in exchange for defective item)	Ninety (90) days	Not Applicable

During the "Labor" warranty period there will be no charge for labor. During the "Parts" warranty period, there will be no charge for parts. You must carry-in or mail-in your product during the warranty period. If non-rechargeable batteries are included, they are not warranted. This warranty only applies to products purchased and serviced in the United States or Puerto Rico. This warranty is extended only to the original purchaser of a new product which was not sold "as is". A purchase receipt or other proof of the original purchase date is required for warranty service.

### Carry-In or Mail-In Service

For Carry-In or Mail-In Service in the United States call 1-800-211-PANA (1-800-211-7262) or visit Panasonic web site: <http://www.panasonic.com>  
For assistance in Puerto Rico call Panasonic Sales Company (787)-750-4300 or fax (787)-768-2910.

### Limited Warranty Limits And Exclusions

This warranty ONLY COVERS failures due to defects in materials or workmanship, and DOES NOT COVER normal wear and tear or cosmetic damage. The warranty ALSO DOES NOT COVER damages which occurred in shipment, or failures which are caused by products not supplied by the warrantor, or failures which result from accidents, misuse, abuse, neglect, mishandling, misapplication, alteration, faulty installation, set-up adjustments, misadjustment of consumer controls, improper maintenance, power line surge, lightning damage, modification, or commercial use (such as in a hotel, office, restaurant, or other business), rental use of the product, service by anyone other than a Factory Servicenter or other Authorized Servicenter, or damage that is attributable to acts of God.

**THERE ARE NO EXPRESS WARRANTIES EXCEPT AS LISTED UNDER "LIMITED WARRANTY COVERAGE". THE WARRANTOR IS NOT LIABLE FOR INCIDENTAL OR CONSEQUENTIAL DAMAGES RESULTING FROM THE USE OF THIS PRODUCT, OR ARISING OUT OF ANY BREACH OF THIS WARRANTY.** (As examples, this excludes damages for lost time, travel to and from the servicenter, loss of media or images, data or other memory content. The items listed are not exclusive, but are for illustration only.) **ALL EXPRESS AND IMPLIED WARRANTIES, INCLUDING THE WARRANTY OF MERCHANTABILITY, ARE LIMITED TO THE PERIOD OF THE LIMITED WARRANTY.**

Some states do not allow the exclusion or limitation of incidental or consequential damages, or limitations on how long an implied warranty lasts, so the exclusions may not apply to you.

This warranty gives you specific legal rights and you may also have other rights which vary from state to state. If a problem with this product develops during or after the warranty period, you may contact your dealer or Servicenter. If the problem is not handled to your satisfaction, then write to the warrantor's Consumer Affairs Department at the addresses listed for the warrantor.

**PARTS AND SERVICE WHICH ARE NOT COVERED BY THIS LIMITED WARRANTY ARE YOUR RESPONSIBILITY.**

## Customer Services Directory

Obtain Product Information and Operating Assistance; locate your nearest Dealer or Servicenter; purchase Parts and Accessories; or make Customer Service and Literature requests by visiting our Web Site at:

<http://www.panasonic.com/support>

or, contact us via the web at:

<http://www.panasonic.com/contactinfo>

You may also contact us directly at:

1-800-211-PANA (7262),

Monday-Friday 9 am-9 pm; Saturday-Sunday 10 am-7 pm, EST.

For hearing or speech impaired TTY users, TTY: 1-877-833-8855

## Accessory Purchases

Purchase Parts, Accessories and Instruction Books online for all Panasonic Products by visiting our Web Site at:

<http://www.pasc.panasonic.com>

or, send your request by E-mail to:

[npcparts@panasonic.com](mailto:npcparts@panasonic.com)

You may also contact us directly at:

1-800-332-5368 (Phone) 1-800-237-9080 (Fax Only) (Monday – Friday 9 am to 8 pm, EST.)

Panasonic Services Company

20421 84th Avenue South, Kent, WA 98032

(We Accept Visa, MasterCard, Discover Card, American Express, and Personal Checks)

For hearing or speech impaired TTY users, TTY: 1-866-605-1277

## Service in Puerto Rico

Matsushita Electric of Puerto Rico, Inc. Panasonic Sales Company

Factory Servicenter:

Ave. 65 de Infantería, Km. 9.5, San Gabriel Industrial Park, Carolina, Puerto Rico 00985

Phone (787)750-4300, Fax (787)768-2910

# Troubleshooting guide

Before requesting service, make the below checks. If you are in doubt about some of the check points, or if the remedies indicated in the chart do not solve the problem:

**In the U.S.A., contact the Panasonic Customer Call Center at 1-800-211-7262, or e-mail [consumerproducts@panasonic.com](mailto:consumerproducts@panasonic.com), or website (<http://www.pasc.panasonic.com>).**

**In Canada, contact the Panasonic Canada Inc. Customer Care Centre at 905-624-5505, or visit the website ([www.panasonic.ca](http://www.panasonic.ca)), or an authorized Servicentre closest to you.**

Common problems		Pages	
No power.	▶	• Ensure the AC power supply cord and system cable are connected.	8
		• Turn the volume up.	13
		• Check connections to speakers and other equipment.	7-11
No sound.	▶	• Select the correct source.	13
		• Change the D-INPUT setting to suit the type of connection you have made.	21
"F76" appears on the display, and the unit turns off. "FAN LOCK" appears on the display.	▶	• Check that the digital signals can be decoded by this unit.	9
		• Turn PCM FIX or DTS FIX off.	19
		• Determine and correct the cause, then switch the unit on. Causes include: - Shorting (bare wires touching) of positive and negative speaker wires. - Using the subwoofer in a hot environment without proper ventilation. Consult your dealer if the problem occurs again after turning the unit on.	7 -
"F 70" appears on the display.	▶	• Turn the unit off, disconnect the AC power supply cord, and consult your dealer.	-
Sound modes		Pages	
Sound is not heard from the center, surround, or subwoofer speakers. Cannot use Dolby Pro LogicII or SFC.	▶	• Turn 2CH MIX off.	13
		• The source may be stereo. Change the sound mode.	13
	▶	• You cannot use Dolby Pro LogicII or SFC when input is PCM with sampling frequencies of 96 or 88.2 kHz.	13
Radio		Pages	
The radio cannot be tuned in or there is a lot of noise and interference.  There is a lot of noise when listening to AM.	▶	• Connect the appropriate antenna. (You may need an outdoor antenna or one with more elements.)	10
		• Adjust the position of the FM or AM antenna.	10
	▶	• Reduce the treble.	20
	▶	• Turn off nearby televisions, video decks and DVD players.	-
	▶	• Separate the antenna from other cables, leads, and appliances.	-
	▶	• Press [MULTI CONTROL, ENTER] on the main unit so "DEFEAT" appears (the DSP is defeated). This should reduce noise. The unit cannot play multiple channel sound while the DSP is defeated, so repeat this to reengage the DSP.	-

**Panasonic Consumer Electronics Company, Division of Matsushita Electric Corporation of America**  
One Panasonic Way Secaucus, New Jersey 07094  
<http://www.panasonic.com>

**Panasonic Sales Company, Division of Matsushita Electric of Puerto Rico, Inc. ("PSC")**  
Ave. 65 de Infantería, Km. 9.5 San Gabriel Industrial Park, Carolina, Puerto Rico 00985

**Panasonic Canada Inc.**  
5770 Ambler Drive Mississauga, Ontario L4W 2T3  
[www.panasonic.ca](http://www.panasonic.ca)

(En)

## Free Manuals Download Website

<http://myh66.com>

<http://usermanuals.us>

<http://www.somanuals.com>

<http://www.4manuals.cc>

<http://www.manual-lib.com>

<http://www.404manual.com>

<http://www.luxmanual.com>

<http://aubethermostatmanual.com>

Golf course search by state

<http://golfingnear.com>

Email search by domain

<http://emailbydomain.com>

Auto manuals search

<http://auto.somanuals.com>

TV manuals search

<http://tv.somanuals.com>