

Panasonic®

Operating Instructions CD Stereo System

Model No. **SC-NS55**



As an ENERGY STAR® Partner, Panasonic has determined that this product meets the ENERGY STAR® guidelines for energy efficiency.



Table of contents

IMPORTANT SAFETY INSTRUCTIONS ..	3
Placement of speakers.....	3
Getting started	4
Overview of controls	6
Discs	7
FM/AM Radio.....	9
XM® Satellite Radio.....	10
Using the iPod	12
Timer	13
Sound adjustment	14
External unit.....	14
Troubleshooting guide.....	15
Product Service	16
Listening caution.....	16
Specifications	17
Maintenance.....	17
Limited Warranty	18

Español

Preparativos iniciales.....	19
Colocación de los altavoces	19
Controles.....	20
Discos.....	21
FM/AM Radio.....	22
Temporizador	23

If you have any questions contact
In the U.S.A.: 1-800-211-PANA (7262)

SUPPLIED ACCESSORIES

Please check and identify the supplied accessories. Use numbers indicated in parentheses when asking for replacement parts. (As of January 2007)
To order accessories, refer to "Accessory Purchases" on page 18.

1 x Remote control



(N2QAYB000090)

1 x AM loop antenna

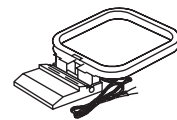

(N1DAAA00001)

1 x AC power supply cord

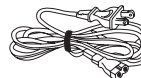

(K2CB2CB00018)

1 x FM indoor antenna

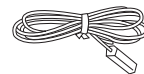

(RSA0007-L1)

2 x Remote control batteries



1 x Universal Dock for iPod

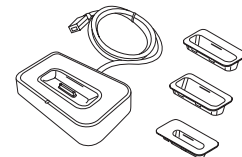

(RFE0205)

Before connecting, operating or adjusting this product, please read the instructions completely. Please keep this manual for future reference.

Operations in these instructions are described using remote control, but you can do the operations with the main unit if the controls are the same.

Your unit may not look exactly as illustrated.

La guía rápida en español se encuentra en la página 19 - 23.

Dear customer

Thank you for purchasing this product.
For optimum performance and safety, please read these instructions carefully.

These operating instructions are applicable to the following system.

System	SC-NS55
Main unit	SA-NS55
Speakers	SB-NS55

The model number and serial number of this product can be found on either the back or the bottom of the unit. Please note them in the space provided below and keep for future reference.

MODEL NUMBER _____
SERIAL NUMBER _____

User memo:

DATE OF PURCHASE _____
DEALER NAME _____
DEALER ADDRESS _____
TELEPHONE NUMBER _____

WARNING:

TO REDUCE THE RISK OF FIRE, ELECTRIC SHOCK OR PRODUCT DAMAGE,

- **DO NOT EXPOSE THIS APPARATUS TO RAIN, MOISTURE, DRIPPING OR SPLASHING AND THAT NO OBJECTS FILLED WITH LIQUIDS, SUCH AS VASES, SHALL BE PLACED ON THE APPARATUS.**
- **USE ONLY THE RECOMMENDED ACCESSORIES.**
- **DO NOT REMOVE THE COVER (OR BACK); THERE ARE NO USER SERVICEABLE PARTS INSIDE. REFER SERVICING TO QUALIFIED SERVICE PERSONNEL.**

CAUTION!

THIS PRODUCT UTILIZES A LASER. USE OF CONTROLS OR ADJUSTMENTS OR PERFORMANCE OF PROCEDURES OTHER THAN THOSE SPECIFIED HEREIN MAY RESULT IN HAZARDOUS RADIATION EXPOSURE. DO NOT OPEN COVERS AND DO NOT REPAIR YOURSELF. REFER SERVICING TO QUALIFIED PERSONNEL.

CAUTION!

DO NOT INSTALL OR PLACE THIS UNIT IN A BOOKCASE, BUILT-IN CABINET OR IN ANOTHER CONFINED SPACE. ENSURE THE UNIT IS WELL VENTILATED. TO PREVENT RISK OF ELECTRIC SHOCK OR FIRE HAZARD DUE TO OVERHEATING, ENSURE THAT CURTAINS AND ANY OTHER MATERIALS DO NOT OBSTRUCT THE VENTILATION VENTS.



CAUTION
RISK OF ELECTRIC SHOCK
DO NOT OPEN



CAUTION: TO REDUCE THE RISK OF ELECTRIC SHOCK, DO NOT REMOVE SCREWS. NO USER-SERVICEABLE PARTS INSIDE. REFER SERVICING TO QUALIFIED SERVICE PERSONNEL.



The lightning flash with arrowhead symbol, within an equilateral triangle, is intended to alert the user to the presence of uninsulated "dangerous voltage" within the product's enclosure that may be of sufficient magnitude to constitute a risk of electric shock to persons.



The exclamation point within an equilateral triangle is intended to alert the user to the presence of important operating and maintenance (servicing) instructions in the literature accompanying the appliance.

FCC Note:

This equipment has been tested and found to comply with the limits for a Class B digital device, pursuant to Part 15 of the FCC Rules.

These limits are designed to provide reasonable protection against harmful interference in a residential installation. This equipment generates, uses and can radiate radio frequency energy and, if not installed and used in accordance with the instructions, may cause harmful interference to radio communications. However, there is no guarantee that interference will not occur in a particular installation. If this equipment does cause harmful interference to radio or television reception, which can be determined by turning the equipment off and on, the user is encouraged to try to correct the interference by one or more of the following measures:

- Reorient or relocate the receiving antenna.
- Increase the separation between the equipment and receiver.
- Connect the equipment into an outlet on a circuit different from that to which the receiver is connected.
- Consult the dealer or an experienced radio/TV technician for help.

Any unauthorized changes or modifications to this equipment would void the user's authority to operate this device.

This device complies with Part 15 of the FCC Rules. Operation is subject to the following two conditions: (1) This device may not cause harmful interference, and (2) this device must accept any interference received, including interference that may cause undesired operation.

Responsible Party:
Panasonic Corporation of North America
One Panasonic Way
Secaucus, NJ 07094

Support Contact:
Panasonic Consumer Electronic Company
Telephone No: 1-800-211-7262

IMPORTANT SAFETY INSTRUCTIONS

Read these operating instructions carefully before using the unit. Follow the safety instructions on the unit and the applicable safety instructions listed below. Keep these operating instructions handy for future reference.

- 1) Read these instructions.
- 2) Keep these instructions.
- 3) Heed all warnings.
- 4) Follow all instructions.
- 5) Do not use this apparatus near water.
- 6) Clean only with dry cloth.
- 7) Do not block any ventilation openings. Install in accordance with the manufacturer's instructions.
- 8) Do not install near any heat sources such as radiators, heat registers, stoves, or other apparatus (including amplifiers) that produce heat.
- 9) Do not defeat the safety purpose of the polarized or grounding-type plug. A polarized plug has two blades with one wider than the other. A grounding-type plug has two blades and a third grounding prong. The wide blade or the third prong are provided for your safety. If the provided plug does not fit into your outlet, consult an electrician for replacement of the obsolete outlet.
- 10) Protect the power cord from being walked on or pinched particularly at plugs, convenience receptacles, and the point where they exit from the apparatus.
- 11) Only use attachments/accessories specified by the manufacturer.
- 12) Use only with the cart, stand, tripod, bracket, or table specified by the manufacturer, or sold with the apparatus. When a cart is used, use caution when moving the cart/apparatus combination to avoid injury from tip-over. 
- 13) Unplug this apparatus during lightning storms or when unused for long periods of time.
- 14) Refer all servicing to qualified service personnel. Servicing is required when the apparatus has been damaged in any way, such as power-supply cord or plug is damaged, liquid has been spilled or objects have fallen into the apparatus, the apparatus has been exposed to rain or moisture, does not operate normally, or has been dropped.

The socket outlet shall be installed near the equipment and easily accessible. The mains plug of the power supply cord shall remain readily operable. To completely disconnect this apparatus from the AC Mains, disconnect the power supply cord plug from AC receptacle.

Marking sign is located on bottom of the unit.

-If you see this symbol-

Information on Disposal in other Countries outside the European Union



This symbol is only valid in the European Union. If you wish to discard this product, please contact your local authorities or dealer and ask for the correct method of disposal.

Placement of speakers



Speakers are designed identically so that no left or right channel orientation is necessary.

Use only the supplied speakers.

The combination of the main unit and speakers provide the best sound. Using other speakers can damage the unit and sound quality will be negatively affected.

Note

- Keep your speakers at least 10 mm ($\frac{13}{32}$ ") away from the system for proper ventilation.
- These speakers do not have magnetic shielding. Do not place them near televisions, personal computers or other devices easily influenced by magnetism.
- You cannot take the front net off the speakers.



Caution

- **Use the speakers only with the recommended system. Failure to do so can damage the amplifier and speakers, and can cause fire. Consult a qualified service person if damage occurs or if a sudden change in performance is apparent.**
- **Do not attach these speakers to walls or ceilings.**

Step 1 - Making the connections

Connect the AM loop antenna.

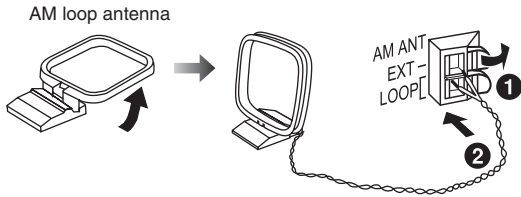

Stand the antenna up on its base. Keep the loose antenna cord away from other wires and cords.

Connect the FM indoor antenna.

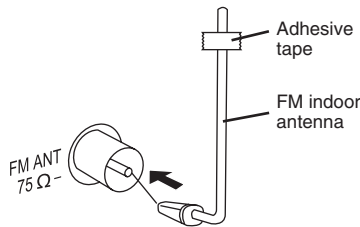

Tape the antenna to a wall or column, in a position with least amount of interference.

Connect the Universal Dock for iPod.

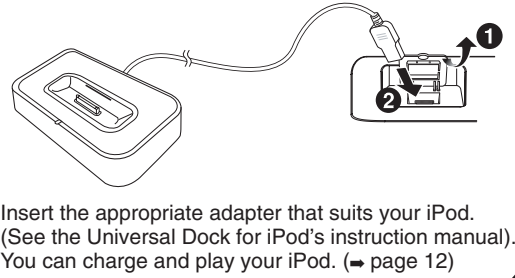

Insert the appropriate adapter that suits your iPod. (See the Universal Dock for iPod's instruction manual). You can charge and play your iPod. (→ page 12)

Optional antenna connections

FM outdoor antenna

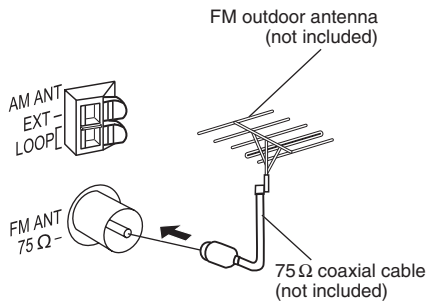

AM outdoor antenna

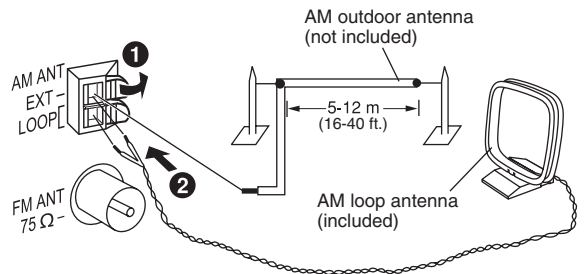

- Never use an outdoor antenna during a lightning storm.
- You can connect the FM outdoor antenna for better reception. Please consult your dealer for installation.
- Disconnect the FM indoor antenna if an FM outdoor antenna is installed.
- Connect the AM outdoor antenna without removing the AM loop antenna. Run 5 to 12 m (16 to 40 feet) of vinyl-covered wire horizontally along a window or other convenient location.

Connect the XM Passport Mini-Tuner and Home Dock. (sold separately)

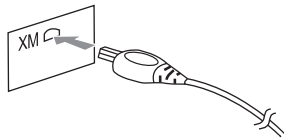

XM Passport Mini-Tuner and Home Dock

To prevent interference with wireless equipment, place the antenna away from other equipment that emits radio waves (such as radio equipment and microwave oven). Refer to page 10 for optimizing the reception.

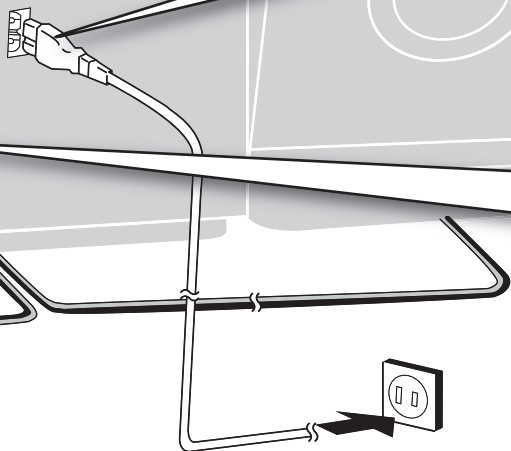

! IMPORTANT

Connect the AC power supply cord only after all other connections have been made.

Connect the AC power supply cord.

The included AC power supply cord is for use with this unit only. Do not use it with other equipment.

Conserving power

The unit consumes approx. 0.5 W even when it is turned off with [POWER ϕ /I]. To save power when the unit is not to be used for a long time, unplug it from the household AC outlet. Remember to reset the radio stations and any other memory items before using the unit again.

Connect the speaker cables.

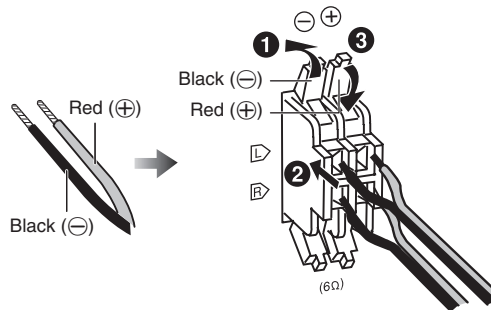

Incorrect connection can damage the unit.

Step 2 - Inserting batteries into the remote control

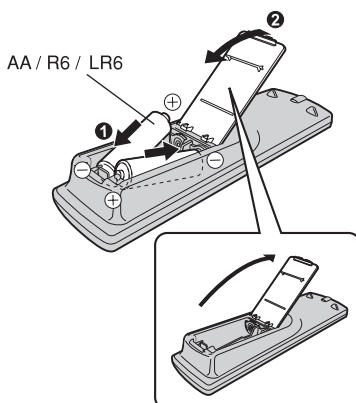

■ Batteries

- Insert so the poles (+ and -) match those in the remote control.
- Remove if the remote control is not going to be used for a long period of time. Store in a cool, dark place.
- Do not use rechargeable type batteries.
- Do not heat or expose to flame.
- Mishandling of batteries in the remote control can cause electrolyte leakage, which may cause a fire.

Do not:

- mix old and new batteries;
- use different types of batteries at the same time;
- take apart or short-circuit;
- attempt to recharge alkaline or manganese batteries;
- use batteries if their covering has been peeled off.

■ Use

Aim at the remote control sensor, avoiding obstacles, at a maximum range of 7 m (23 feet) directly in front of the unit.

Refer to page 6 for remote control signal sensor position.

Overview of controls

Main unit

Refer to the numbers in parentheses for page reference.

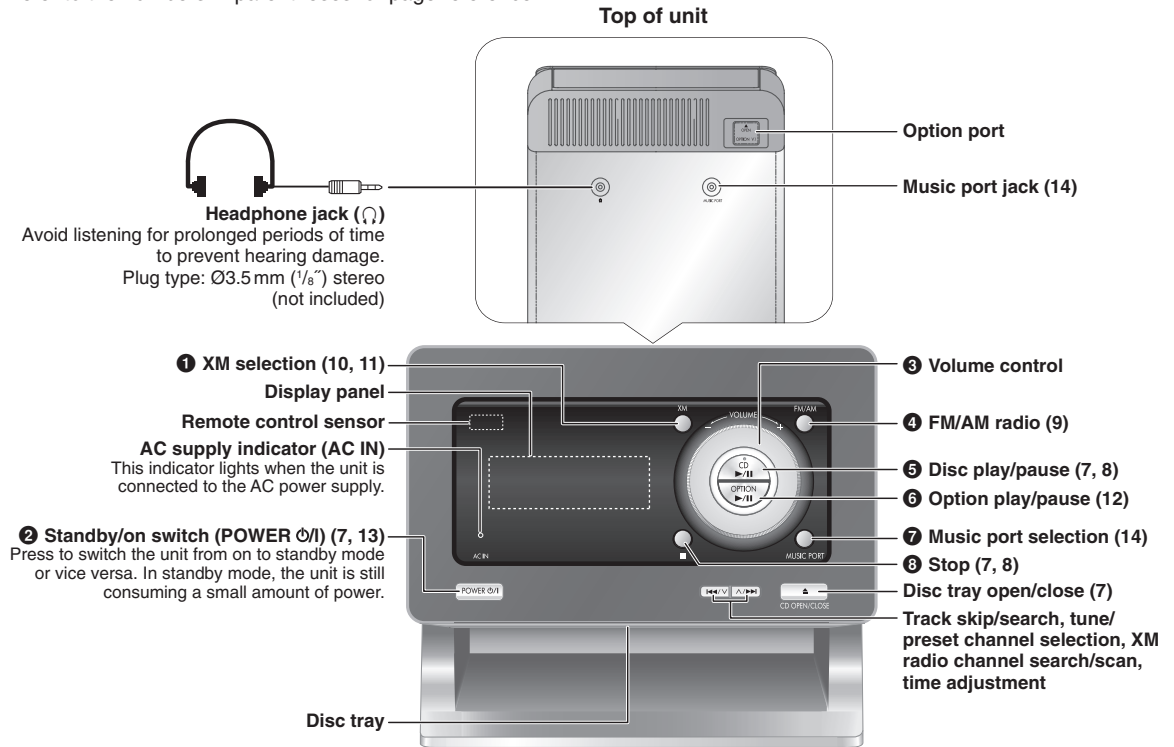

Remote control

Buttons such as 1 function the same as the controls on the main unit.

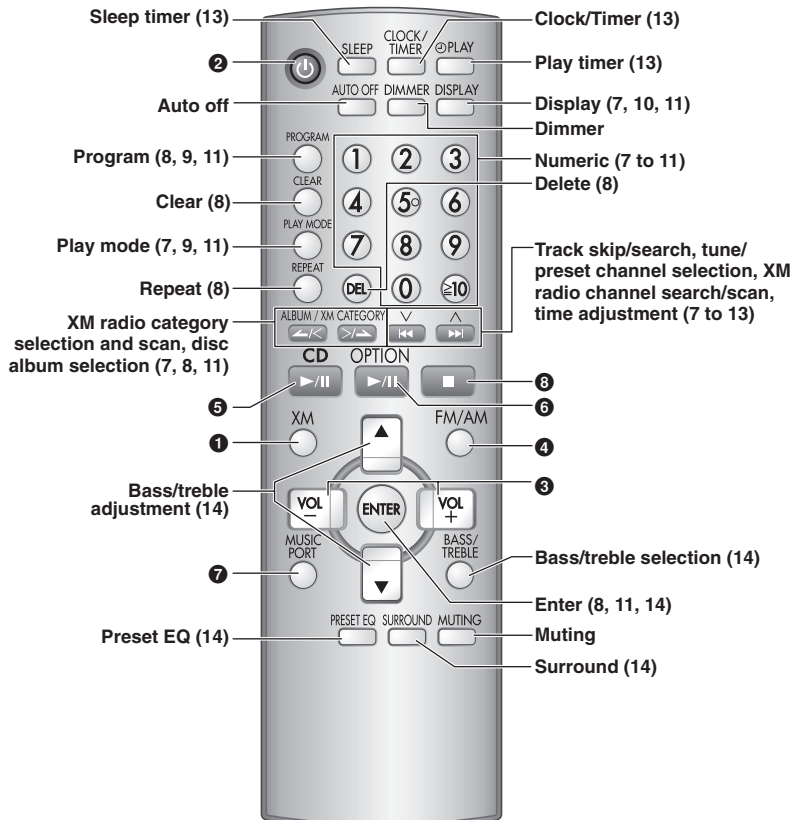

AUTO OFF This function allows you to turn off the unit in **disc** mode only after left unused for 10 minutes.

The setting is maintained even if the unit is turned off.

DIMMER Dims the display panel.

MUTING Mutes the sound.

- Press the button to activate.
- Press again to cancel.

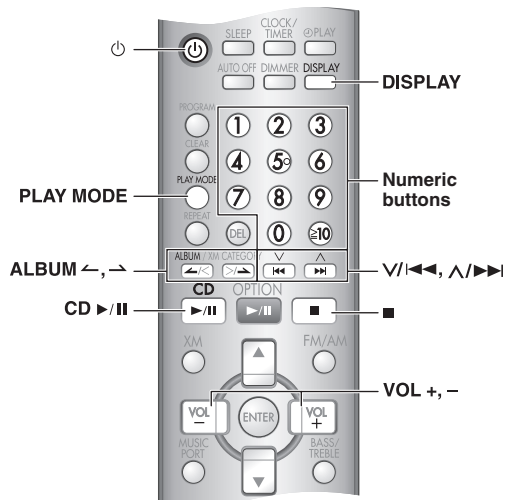

▲ CD OPEN/CLOSE

Basic play

CD MP3

- 1 Press [⏻] to turn the unit on.
- 2 Press [▲ CD OPEN/CLOSE] to open the disc tray and then load the disc. Press [▲ CD OPEN/CLOSE] again to close the tray.

Label must face upward

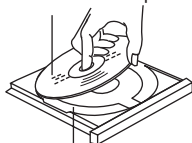

Disc tray

- 3 Press [CD ▶/||] to start play.
- 4 Adjust the volume.

To	Action
stop the disc	Press [■].
pause play	Press [CD ▶/]. Press again to resume play.
skip tracks	Press [∨/⏮] or [∧/⏭].
search through tracks	Press and hold [∨/⏮] or [∧/⏭] during play or pause.
skip album	Press [ALBUM ← or →] in the play mode. Press [ALBUM ← or →] once and then the numeric buttons in the stop mode.

Play Mode function

CD MP3

- 1 Press [CD ▶/||].
- 2 Press [PLAY MODE] to select the desired mode.

Mode	To play
1-TRACK 1TR	one selected track on the disc. Press the numeric buttons to select the track.
1-ALBUM 1ALBUM MP3	one selected album on the disc. Press [ALBUM ← or →] to select the album.
RANDOM RND	a disc randomly.
1-ALBUM RANDOM 1ALBUM RND MP3	all tracks in one selected album randomly. Press [ALBUM ← or →] to select the album.

Note

- During RANDOM or 1-ALBUM RANDOM play, you cannot skip to tracks that have been played.
- The current play mode is cleared when you open the disc tray.

CD

- During RANDOM play, you can search backward or forward only within the current track.

Display function

This function allows you to display the information of the current track.

Press [DISPLAY] repeatedly during play or pause mode.

CD

→ Elapsed play time → Remaining play time →

MP3

→ Elapsed time → Album name → Track name →
ID3 (Artist) ← ID3 (Track) ← ID3 (Album) ←

Note

- Maximum number of displayable characters: approximately 30
- This unit supports ver. 1.0 & 1.1 ID3 tags. Text data that is not supported will not be displayed.
- ID3 is a tag embedded in MP3 tracks to provide information about the track.

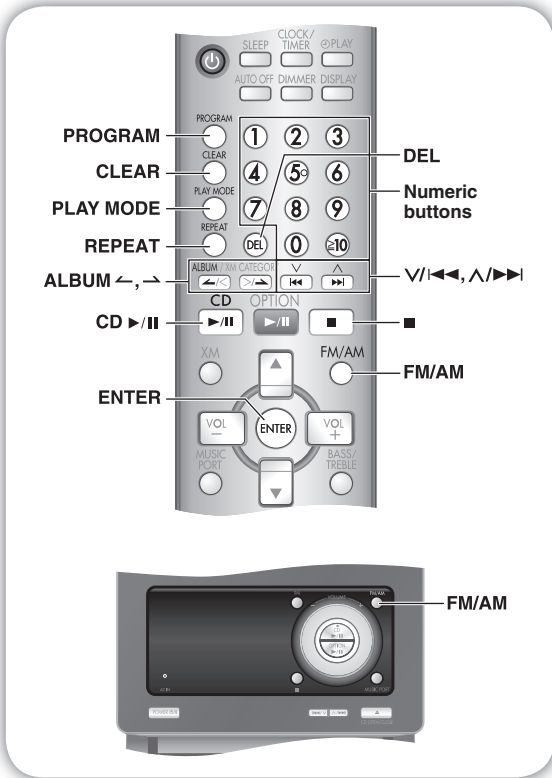

Advanced play

Repeat play

You can repeat program play or other selected play mode.

CD **MP3**

Press **[REPEAT]** before or during play. "REPEAT ON" and "☐" are displayed.

To cancel

Press **[REPEAT]** again.

"REPEAT OFF" is displayed and "☐" is cleared.

Note

- This unit can play MP3 files and CD-DA format audio CD-R/RW that have been finalized.
- It may not be able to play some CD-R/RW depending on the condition of the recording.
- Do not use irregularly shaped discs.
- Do not use discs with labels and stickers that are coming off or with adhesive exuding from under labels and stickers.
- Do not attach extra labels or stickers on the disc.
- Do not write anything on the disc.

CD

- This unit can access up to 99 tracks.
- Choose a CD with this mark:



Program play

This function allows you to program up to 24 tracks.

CD

- 1 Press **[CD ▶/||]** and then **[■]**.
- 2 Press **[PROGRAM]**.
- 3 Press the numeric buttons to select your desired track. Repeat this step to program other tracks.
- 4 Press **[CD ▶/||]** to start play.

MP3

- 1 Press **[CD ▶/||]** and then **[■]**.
- 2 Press **[PROGRAM]**.
- 3 Press **[ALBUM ← or →]** to select your desired album.
- 4 Press **[∨▶▶]** once and then the numeric buttons to select your desired track.
- 5 Press **[ENTER]**. Repeat steps 3 to 5 to program other tracks.
- 6 Press **[CD ▶/||]** to start play.

For two-digit track, press **[≥10]** once, and then the two digits.

For three-digit track, press **[≥10]** twice, and then the three digits.

To	Action
cancel program mode	Press [PROGRAM] in the stop mode.
replay the program	Press [PROGRAM] then [CD ▶/] .
check program contents	Press [∨/∧◀◀] or [∨/∧▶▶] when "PGM" is displayed in the stop mode. To check while programming, press [PROGRAM] twice after "PGM" appears, then press [∨/∧◀◀] or [∨/∧▶▶] .
add to the program	CD Repeat step 3 in the stop mode. MP3 Repeat steps 3 to 5 in the stop mode.
clear the last track	Press [DEL] in the stop mode.
clear all programmed tracks	Press [CLEAR] in the stop mode. "CLR ALL" is displayed.

Note

- When you try to program more than 24 tracks "PGM FULL" appears.
- The program memory is cleared when you open the disc tray.

CD

- During program play, you can search backward or forward only within the current track.

Using DualDiscs

The "CD" sides of DualDiscs do not meet the CD-DA standard so it may not be possible to play them on this unit.

MP3

- Files are treated as tracks and folders are treated as albums.
- This unit can access up to 999 tracks, 255 albums and 20 sessions.
- Disc must conform to ISO9660 level 1 or 2 (except for extended formats).
- To play in a certain order, prefix the folder and file names with the 3-digit numbers in the order you want to play them.

FM/AM Radio

Manual tuning

- 1 Press [FM/AM] to select “FM” or “AM”.
- 2 Press [PLAY MODE] to select “MANUAL”.
- 3 Press [V/◀◀] or [V/▶▶] to select the frequency of the required station.



“ST” is displayed when a stereo FM broadcast is being received.

To tune automatically

Press [V/◀◀] or [V/▶▶] for a moment until the frequency starts changing rapidly. The unit begins auto tuning, stopping when it finds a station.

- Auto tuning may not function when there is excessive interference.
- To cancel auto tuning, press [V/◀◀] or [V/▶▶] once again.

To improve FM sound quality

Press and hold [PLAY MODE] to display “MONO”.



To cancel

Press and hold [PLAY MODE] again until “MONO” disappears.

- MONO is also canceled if the frequency is changed.
- Turn off “MONO” for normal listening.

Memory preset

Up to 20 stations can be set in the FM band and 15 stations in the AM band.

Preparation

Press [FM/AM] to select “FM” or “AM”.

Automatic presetting

Press and hold [PROGRAM] to start presetting.

Manual presetting

- 1 Press [PLAY MODE] to select “MANUAL”.



- 2 Press [V/◀◀] or [V/▶▶] to tune to the required station.
- 3 Press [PROGRAM].
- 4 Press the numeric buttons to select a channel.
The station occupying a channel is erased if another station is preset in that channel.
- 5 Repeat steps 2 to 4 to preset more stations.

Selecting a preset station

Press the numeric buttons to select the channel.

For two digit channels, press [≥10], then the two digits.

OR

- 1 Press [PLAY MODE] to select “PRESET”.
- 2 Press [V/◀◀] or [V/▶▶] to select the channel.

FM allocation setting

By main unit only

This system can also receive FM broadcasts allocated in 0.1 MHz steps.

To change the step to 0.1 MHz

- 1 Press and hold [FM/AM].
After a few seconds the display changes to a flashing display of the current minimum frequency.
- 2 Continue to hold down [FM/AM].
 - When the minimum frequency changes, release the button. To return to the original step, repeat the above steps.
 - After the setting is changed, any previously preset frequency will be cleared.

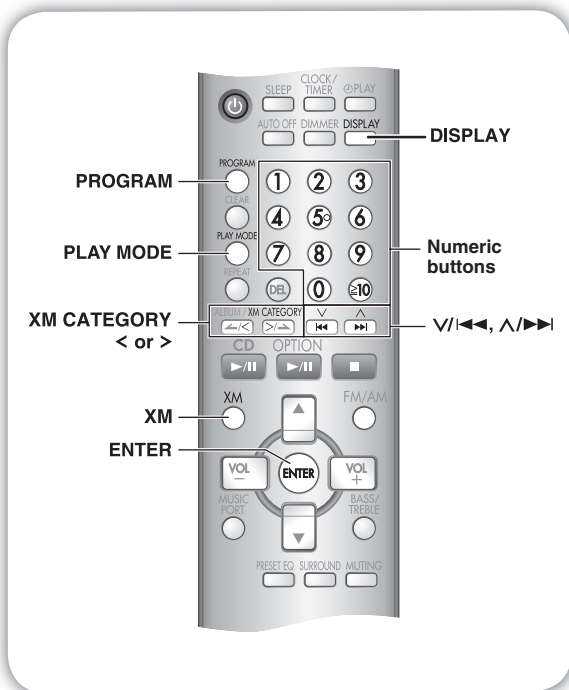

Introducing XM Satellite Radio

XM Satellite Radio is the provider of satellite radio with more than 6 million subscribers. XM offers more than 170 digital radio channels with music, talk, news, sports, comedy, traffic and weather reports. For more information, visit XM on the Web at www.xmradio.com.

How to Subscribe

XM monthly service subscription sold separately. XM Passport Mini-Tuner and Home Dock (includes home antenna) required to receive XM service (sold separately). Installation costs and other fees and taxes, including a one-time activation fee may apply. Subscription fee is consumer only. All fees and programming subject to change. Channels with frequent explicit language are indicated with an XL. Channel blocking is available for XM radio receivers by calling 1-800-XMRADIO (1-800-967-2346). Subscriptions subject to Customer Agreement available at xmradio.com. XM service only available in the 48 contiguous United States. XM Ready is a trademark of XM Satellite Radio Inc. © 2006 XM Satellite Radio Inc. All rights reserved.

- To subscribe, visit XM on the Web at www.xmradio.com or call XM's Listener Care at 1-800-XMRADIO (1-800-967-2346). You should have your Radio ID ready; the Radio ID can be found by selecting channel 0 on the radio.

The XM name and related logos are registered trademarks of XM Satellite Radio Inc. All rights reserved.

Displaying the XM Satellite Radio ID

You can confirm your XM Satellite Radio ID necessary for activating XM Satellite Radio as follows.

- 1 **Connect the XM Passport Mini-Tuner and Home Dock.** (→ page 5)
- 2 **Press [XM].** "ANTENNA" blinks on the display if no XM antenna is detected.
- 3 **Press [0] to select channel "0" to display the Radio ID.** "RADIO ID" is indicated in the display briefly, followed by an 8-digit alphanumeric ID.

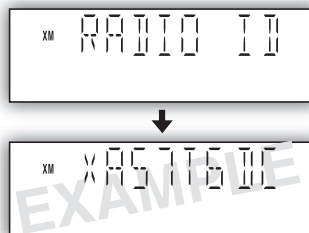

- 4 **Record your XM Satellite Radio ID here for reference:**

--	--	--	--	--	--	--	--

Note

- To avoid ambiguity, the letters I, O, S and F are not used in the ID.
- There is no sound output when "RADIO ID" is displayed.

XM channel 0 is for "RADIO ID" and channel 1 is for "PREVIEW".

Optimizing the XM signal reception

The main unit has a signal strength indicator function that allows you to optimize the XM signal reception.

- 1 **Press [XM].** Ensure the antenna is connected. (→ page 5)
- 2 **Press and hold [DISPLAY] until the XM signal status is displayed.**

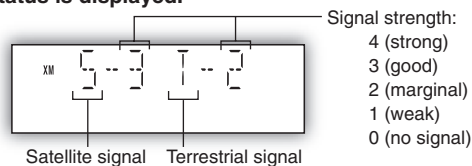

- 3 **Position the antenna for the best possible satellite signal reception.**

As you position the antenna, the display changes depending on the signal strength. If the satellite signal is weak or not available, you can optimize for the terrestrial signal (where available).

- 4 **Press [DISPLAY] to return to the previous display.**

Tips for optimizing reception

- To prevent interference with wireless equipment, place the antenna away from other equipment that emits radio waves (such as radio equipment and microwave ovens).
- Place the antenna near a south-facing window with an unobstructed view of the sky for the best satellite signal reception.
- Refer also to the operating instructions of your XM Passport Mini-Tuner and Home Dock.

Manual tuning

- 1 Press [XM].
- 2 Press [PLAY MODE] to select "MANUAL".
Each time you press the button:

→ MANUAL → PRESET →

- 3 Press [V/◀◀] or [V/▶▶] to select a channel.
Press and hold [V/◀◀] or [V/▶▶] to scan through quickly.

OR

Press the numeric buttons for direct access to an XM channel.

For two-digit channel, press [≥10] once, and then the two digits.

For three-digit channel, press [≥10] twice, and then the three digits.

Note

- You can enter a channel number between 0 to 255.
- If you enter a number that is not valid or selected an unauthorized channel "XM ---" is displayed and the previous channel is selected.
- If you change the playmode for XM, FM and AM playmodes are also set to the newly select playmode, vice versa.

Selecting XM channels by category

XM channels are organized into categories such as Rock, Classical, Country and Dance to make browsing and selecting broadcast content easier.

- 1 Press [PLAY MODE] to select "MANUAL".
- 2 Press [XM CATEGORY < or >] to select a category.
"CAT ON" (CATEGORY ON) is displayed briefly, and then the category of the current XM channel flashes on the display.
Press and hold [XM CATEGORY < or >] to scan through quickly.
- 3 Press [V/◀◀] or [V/▶▶] to select a channel within the category.
Press and hold [V/◀◀] or [V/▶▶] to scan through quickly.
- 4 Press [ENTER] to exit category mode.
"CAT OFF" (CATEGORY OFF) is displayed briefly on the display.

Note

- Category mode will cancel automatically after approximately 15 seconds if there is no user input.
- XM channel selection by category enables you to narrow down your choices to channels belonging to a broadcasting category of your choice and then to select a favorite channel from the chosen category. Available categories vary according to broadcasting hours. The unit does not display categories with no broadcasting XM channel.
- Each XM channel may belong to two categories (Category 1 and Category 2). Both categories are used for channel selection by category.

Memory preset

Channel presetting

Channel presets allow you to quickly and conveniently select your favorite XM channels. Up to 15 XM channels can be stored as channel presets.

- 1 Press [PLAY MODE] to select "MANUAL".
- 2 Press [V/◀◀] or [V/▶▶] or numeric buttons to select a channel.
- 3 Press [PROGRAM].
- 4 Press the numeric buttons to select a channel.
The station occupying a channel is erased if another station is preset in that channel.
- 5 Repeat steps 2 to 4 to preset more stations.

Note

- You can only preset XM stations which you can receive.
- XM channel 0 (RADIO ID) cannot be stored as a channel preset.

Selecting a preset station

- 1 Press [PLAY MODE] to select "PRESET".
- 2 Press [V/◀◀] or [V/▶▶] or numeric buttons to select a channel.

Displaying the XM channel information

The display mode setting can be changed to display information about the broadcast content such as the category, song title or artist's name.

Press [DISPLAY] repeatedly to display:

Example:

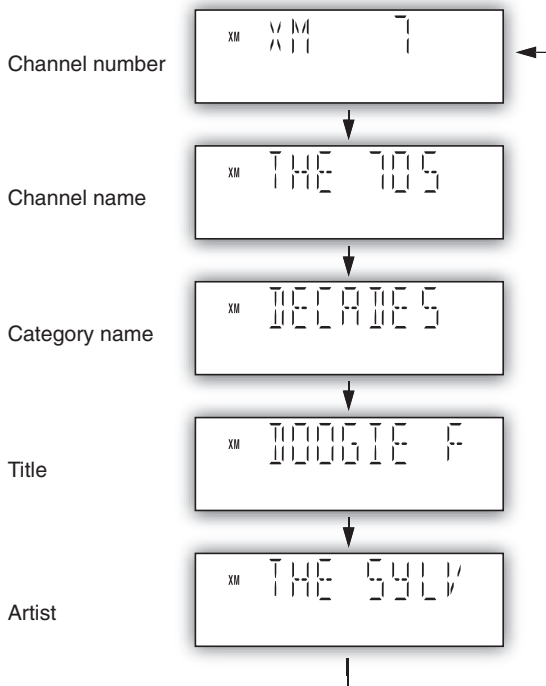

Note

- If there is no text information for the current XM broadcast, "----" is displayed.
- For text information more than 8 characters long (Title or Artist only), after the text has scrolled, press [DISPLAY] to scroll the text again. Press [DISPLAY] while the text is scrolling to change the display mode.

Using the iPod

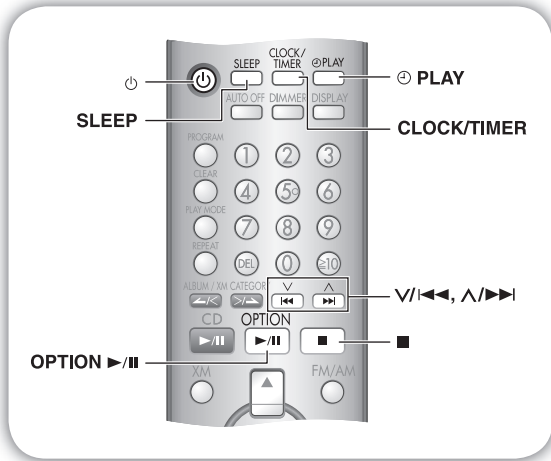

You can charge and play your iPod by putting it in the Universal Dock for iPod that connected to the option port on top of this unit.

Connecting and charging the iPod

Preparation:

Connect the Universal Dock for iPod to the option port. (➔ page 4)

- 1 Insert the appropriate dock adapter into the slot of the Universal Dock for iPod. (See the Dock's instruction manual)
- 2 Place your iPod in the Universal Dock for iPod.

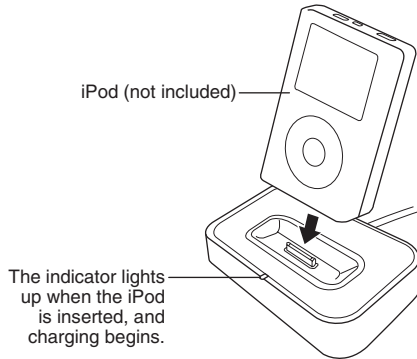

Charging time

iPod nano 1st generation	Until iPod is fully charged
iPod nano 2nd generation (aluminum)	
iPod 5th generation (video)	
iPod 4th generation (color display)	5 hours (fixed)
iPod 4th generation iPod mini	

Note

- "OPTION *" will be shown on the main unit's display during iPod charging in main unit standby mode. It will go off when charging is finished.
For the above models under "fixed 5-hour charging", "OPTION *" continues to be displayed throughout this duration, even when your iPod is fully charged. You can turn off this display by removing the iPod from the dock.
- Compatibility depends on the software version of your iPod.

Play from the iPod

Before place the iPod to the Universal Dock for iPod, turn off the equalizer function (if there is any) of the iPod. Otherwise, the sound from the speaker may be distorted.

- 1 Confirm you iPod connection.
- 2 Press [OPTION ▶/||] to select OPTION as the source.

To	Action
Pause	Press [OPTION ▶/]. Press again to resume.
Skip tracks	Press [V/I◀◀] or [▶▶/∧]
Search through tracks	Press and hold [V/I◀◀] or [▶▶/∧] during play or pause.

Note

- When you select another source or turn off the main unit, the iPod turns off.
- Some features may not be compatible depending on the model or the software version of your iPod.

Compatible iPod

Name	Memory size
iPod nano	2GB, 4GB, 8GB
2nd generation (aluminum)	
iPod 5th generation (video)	60GB, 80GB
iPod 5th generation (video)	30GB
iPod nano 1st generation	1GB, 2GB, 4GB
iPod 4th generation (color display)	40GB, 60GB
iPod 4th generation (color display)	20GB, 30GB
iPod 4th generation	40GB
iPod 4th generation	20GB
iPod mini	4GB, 6GB

Note

Compatibility depends on the software version of your iPod.

iPod is a trademark of Apple Inc., registered in the U.S. and other countries.

Timer

Setting the clock

This is a 12-hour clock.

- 1 Press [CLOCK/TIMER] to select "CLOCK".
Each time you press the button:

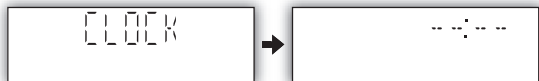
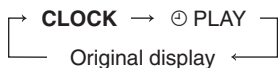

- 2 Within 5 seconds, press [M/◀◀] or [M/▶▶] to set the time.



- 3 Press [CLOCK/TIMER] again to confirm.



Displaying the clock

Press [CLOCK/TIMER] to display the clock for few seconds.

Note

The clock may lose or gain minutes over a period of time. Readjust as necessary.

Using the sleep timer

This function enables you to turn off the unit automatically after the set time.

Press [SLEEP] repeatedly to select your desired time.

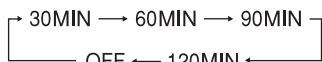

Sleep timer indicator

To cancel

Press [SLEEP] to select "OFF".

Changing the remaining time

Press [SLEEP] to show the remaining time, and press [SLEEP] again to select your desired time.

Note

- The play and sleep timer can be used together.
- The sleep timer always has priority. Be sure not to overlap timer settings.

Using the play timer

You can set the play timer to come on at a certain time to wake you up.

Preparation

Turn the unit on and set the clock.

Prepare the music source you want to listen to; disc, radio, option port or music port source, and set the volume.

- 1 Press [CLOCK/TIMER] repeatedly to select play timer.

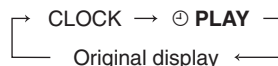

- 2 Within 5 seconds, press [M/◀◀] or [M/▶▶] to set the starting time.

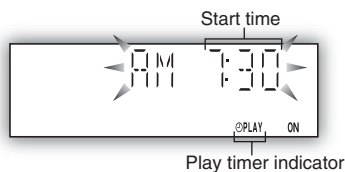

- 3 Press [CLOCK/TIMER] to confirm.

- 4 Repeat steps 2 and 3 to set the finishing time.

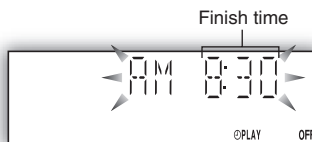

To activate the timer

- 5 Press [⊖PLAY] to turn on the timer.

"⊖PLAY" is displayed.

- 6 Press [⊖] to turn off the unit.

The unit must be off for the timer to operate.

To	Action
change the settings	Repeat steps 1 to 4 and 6.
change the source or volume	1) Press [⊖PLAY] to clear the ⊖PLAY indicator from the display. 2) Make changes to the source or volume. 3) Perform steps 5 and 6.
check the settings (when the unit is on or in standby mode)	Press [CLOCK/TIMER] repeatedly to select ⊖PLAY.
cancel	Press [⊖PLAY] to clear the timer indicator from the display.

Note

- The timer will start at the preset time, with the volume increasing gradually to the preset level.
- The timer comes on at the set time every day if the timer is on.
- The unit must be in the standby mode for the timer to function.
- If you turn the unit off and on again while a timer is functioning, the finish time setting will not be activated.
- Regardless of the channel selection during timer setting, the XM satellite radio always comes on with the previous selected channel.
- If MUSIC PORT or OPTION PORT is selected as the source when the timer comes on, the system turns on and engages MUSIC PORT or OPTION PORT as the source. If you wish to playback from the portable audio equipment, activate the equipment's play mode and increase the volume. (See the portable audio equipment's instruction manual.)

Troubleshooting guide

Before requesting service, make the following checks. If you are in doubt about some of the check points, or if the remedies indicated in the chart do not solve the problem, refer to the "Customer Services Directory" on page 18.

Common problems

No sound.	Turn the volume up. The speaker cords may not be connected properly. Turn the unit off, check and correct the connections and turn the unit on (⇒ page 5).
Sounds unfixed, reversed or come from one speaker only.	Check the speaker connections (⇒ page 5).
Humming heard during play.	An AC power supply cord or fluorescent light is near the cables. Keep other appliances and leads away from this unit's cables.
"ERROR" is displayed.	Incorrect operation performed. Read the instructions and try again.
"- - -" appears on the display.	You plugged the AC power supply cord in for the first time or there was a power failure recently. Set the time (⇒ page 13).
"F76" is displayed.	Check and correct the speaker cord connections (⇒ page 5). If this does not fix the problem, there is a power supply problem. Consult the dealer.

Listening to the radio

Noise is heard. The stereo indicator flickers or doesn't light. Sound is distorted.	Use an outdoor antenna (⇒ page 4).
A beat sound is heard.	Turn the TV off or separate it from the unit.
A low hum is heard during AM broadcast.	Separate the antenna from other cables and cords.

XM Satellite Radio advisory messages

"ANTENNA" is flashing.	The XM Passport Mini-Tuner and Home Dock is not properly connected. Check the connection and make sure the antenna cable not damaged (⇒ page 5).
"UPDATING" is flashing.	The XM Passport Mini-Tuner and Home Dock is being updated with the latest encryption code. Wait a few seconds for the update to complete. You may have selected an XM channel that has been blocked, or is no longer available with your subscription package. If you want to inquire about receiving the channel, call XM's Listener Care at 1-800-XMRADIO (1-800-967-2346).
"NO SIGNAL" is flashing.	The XM signal is too weak. Reorient the XM Passport Mini-Tuner and Home Dock for better reception.
"LOADING" is flashing.	The XM Passport Mini-Tuner and Home Dock is receiving and decoding the broadcast information. Wait a few seconds for loading to complete.
"OFF AIR" is flashing.	The selected XM channel is not currently broadcasting. Select a different channel.
"XM ---" is displayed.	The selected XM channel is not available. Select a different channel.
"XM RADIO" is displayed.	It takes a short time for the XM radio to power up after turning on the main unit, during which time "XM RADIO" is displayed (only when the selected source is XM). Wait a few seconds for this process to complete.
"---" is displayed.	Supplemental text information, such as the song title or artist's name is not available for that particular broadcast. You can change the type of XM channel information that is displayed by pressing [DISPLAY].
You can receive only promotional XM channels.	Your XM Passport Mini-Tuner and Home Dock has not been activated, or your subscription has expired. To activate your XM Passport Mini-Tuner and Home Dock, or to renew your subscription, visit XM on the Web at www.xmradio.com or call XM's Listener Care at 1-800-XMRADIO (1-800-967-2346). You should have your Radio ID ready.

When there is a television set nearby

The picture on the TV disappears or stripes appear on the screen.	The location and direction of the antenna are incorrect. If you are using an indoor antenna, change to an outdoor antenna (⇒ page 4). The TV antenna wire is too close to the unit. Separate the antenna wire of the TV set from the unit.
--	---

Playing discs

The display is wrong or play won't start.	The disc may be upside down (⇒ page 7). Wipe the disc. Replace the disc if it is scratched, warped, or non-standard. Condensation may have formed inside the unit due to a sudden change in temperature. Wait about an hour for it to clear and try again.
"MECH ERR"	Check that the passage of the disc tray is cleared. Remove if anything is placed under the disc tray. Turn off and then turn back on the unit.

The remote control

Remote control doesn't work.	Check that the batteries are inserted correctly (⇒ page 5). Replace the batteries if they are worn.
-------------------------------------	--

Product Service

- 1. Damage requiring service**— The unit should be serviced by qualified service personnel if:
 - (a) The AC power supply cord or the plug has been damaged; or
 - (b) Objects or liquids have gotten into the unit; or
 - (c) The unit has been exposed to rain; or
 - (d) The unit does not operate normally or exhibits a marked change in performance; or
 - (e) The unit has been dropped or the cabinet damaged.
- 2. Servicing**— Do not attempt to service the unit beyond that described in these operating instructions. Refer all other servicing to authorized servicing personnel.
- 3. Replacement parts**— When parts need replacing ensure the servicer uses parts specified by the manufacturer or parts that have the same characteristics as the original parts. Unauthorized substitutes may result in fire, electric shock, or other hazards.
- 4. Safety check**— After repairs or service, ask the servicer to perform safety checks to confirm that the unit is in proper working condition.

The servicer will require all components to service your system.

Therefore, should service ever be necessary, be sure to bring the entire system.

Product information

For product information or assistance with product operation:

Refer to “Customer Services Directory” on page 18.

Listening caution



Selecting fine audio equipment such as the unit you've just purchased is only the start of your musical enjoyment. Now it's time to consider how you can maximize the fun and excitement your equipment offers. This manufacturer and the Electronic Industries Association's Consumer Electronics Group want you to get the most out of your equipment by playing it at a safe level. One that lets the sound come through loud and clear without annoying blaring or distortion—and, most importantly, without affecting your sensitive hearing.

We recommend that you avoid prolonged exposure to excessive noise.

Sound can be deceiving. Over time your hearing “comfort level” adapts to higher volumes of sound. So what sounds “normal” can actually be loud and harmful to your hearing. Guard against this by setting your equipment at a safe level **BEFORE** your hearing adapts.

To establish a safe level:

- Start your volume control at a low setting.
- Slowly increase the sound until you can hear it comfortably and clearly, and without distortion.

Once you have established a comfortable sound level:

- Set the dial and leave it there.

Taking a minute to do this now will help to prevent hearing damage or loss in the future. After all, we want you listening for a lifetime.

Specifications

AMPLIFIER SECTION

FTC OUTPUT POWER both channel driven simultaneously	
10 % Total harmonic distortion (THD)	
60 Hz to 20 kHz	12 W per channel (6 Ω)
RMS OUTPUT POWER both channel driven simultaneously	
10 % Total harmonic distortion (THD)	
1 kHz	15 W per channel (6 Ω)
Input impedance	
MUSIC PORT	12 kΩ
Output impedance	
HEADPHONE	16 to 32 Ω
Phone jack	
Terminal	Stereo, 3.5 mm
Music Port jack	
Terminal	Stereo, 3.5 mm
Option port	Version 1
XM Ready	XM Mini-Tuner and Home Dock

FM TUNER SECTION

Frequency range	87.9 to 107.9 MHz (200 kHz step) 87.5 to 108.0 MHz (100 kHz step)
Sensitivity	0.10 μV (IHF)
S/N 26 dB	1.20 μV
Antenna terminals	75 Ω (unbalanced)
Preset station	FM 20 stations AM 15 stations

AM TUNER SECTION

Frequency range	520 to 1710 kHz (10 kHz step)
Sensitivity	
S/N 20 dB (at 1000 kHz)	447 μV/m

CD SECTION

Disc played [8 cm (3") or 12 cm (5")]	
(1) CD-Audio (CD-DA)	
(2) CD-R/RW (CD-DA, MP3 formatted disc)	
(3) MP3	
Sampling frequency	
CD	44.1 kHz
MP3	32 kHz, 44.1 kHz, 48 kHz
Bit rate	
MP3	32 kbps to 384 kbps
Decoding	16/20/24 bit linear
Pickup	
Beam source	Semiconductor laser
Wavelength	785 nm
Laser power	CLASS 1
Audio output (Disc)	
Number of channels	2 channel
Frequency response	20 Hz to 20 kHz (+1, -2 dB)
Wow and flutter	Below measurable limit
Digital filter	8 fs
D/A converter	MASH (1 bit DAC)

SPEAKER SECTION

Type	1 way, 1 speaker system
Speaker(s)	
FULL RANGE	8 cm (3 ⁵ / ₃₂ ") CONE type 6 Ω
Impedance	6 Ω
Input power (IEC)	15 W (MAX)
Output sound pressure	79.05 dB/W (1.0 m)
Frequency range	55 Hz to 25 kHz (-16 dB) 60 Hz to 20 kHz (-10 dB)
Dimensions (W x H x D)	127 mm x 184 mm x 228 mm (5" x 7 ¹ / ₄ " x 9")
Mass	1.4 kg (3.1 lb.)

GENERAL

Power supply	AC 120 V, 60 Hz
Power consumption	60 W
Dimensions (W x H x D)	212 mm x 184 mm x 308 mm (8 ¹¹ / ₃₂ " x 7 ¹ / ₄ " x 12 ¹ / ₈ ")
Mass	3.4 kg (7.5 lb.)
Operating temperature range	+5°C to +35°C (+41°F to +95°F)
Operating humidity range	5 % to 90 % RH (no condensation)

Power consumption in standby mode 0.5 W (approx.)

Note

- Specifications are subject to change without notice.
Mass and dimensions are approximate.
- Total harmonic distortion is measured by the digital spectrum analyzer.

Maintenance

If the surfaces are dirty

To clean this unit, wipe with a soft, dry cloth.

- Never use alcohol, paint thinner or benzene to clean this unit.
- Before using chemically treated cloth, read the instructions that came with the cloth carefully.

Limited Warranty

Panasonic Consumer Electronics Company,
Division of Panasonic Corporation of North America
One Panasonic Way Secaucus, New Jersey 07094

Panasonic Puerto Rico, Inc.
Ave. 65 de Infantería, Km. 9.5
San Gabriel Industrial Park, Carolina, Puerto Rico 00985

Panasonic Audio Products Limited Warranty

Limited Warranty Coverage

If your product does not work properly because of a defect in materials or workmanship, Panasonic Consumer Electronics Company or Panasonic Puerto Rico, Inc. (collectively referred to as "the warrantor") will, for the length of the period indicated on the chart below, which starts with the date of original purchase ("warranty period"), at its option either (a) repair your product with new or refurbished parts, or (b) replace it with a new or a refurbished product. The decision to repair or replace will be made by the warrantor.

Product or Part Name	Parts	Labor
Audio Products (except items listed below)	One (1) year	One (1) year
USB Reader-Writer, Personal Computer Card Adapters (in exchange for defective item)	One (1) year	Not Applicable
Accessories: Headphones, Cartridges, Microphones, Adapters	Ninety (90) days	Ninety (90) days
Rechargeable Batteries, DVD-R/-RAM Discs (in exchange for defective item)	Ten (10) days	Not Applicable
SD Memory Cards, Rechargeable Battery Packs (in exchange for defective item)	Ninety (90) days	Not Applicable

During the "Labor" warranty period there will be no charge for labor. During the "Parts" warranty period, there will be no charge for parts. You must carry-in or mail-in your product during the warranty period. If non-rechargeable batteries are included, they are not warranted. This warranty only applies to products purchased and serviced in the United States or Puerto Rico. This warranty is extended only to the original purchaser of a new product which was not sold "as is". A purchase receipt or other proof of the original purchase date is required for warranty service.

Carry-In or Mail-In Service

For Carry-In or Mail-In Service in the United States call 1-800-211-PANA (1-800-211-7262) or visit Panasonic web site: <http://www.panasonic.com>
For assistance in Puerto Rico call Panasonic Puerto Rico, Inc. (787)-750-4300 or fax (787)-768-2910.

Limited Warranty Limits And Exclusions

This warranty ONLY COVERS failures due to defects in materials or workmanship, and DOES NOT COVER normal wear and tear or cosmetic damage. The warranty ALSO DOES NOT COVER damages which occurred in shipment, or failures which are caused by products not supplied by the warrantor, or failures which result from accidents, misuse, abuse, neglect, mishandling, misapplication, alteration, faulty installation, set-up adjustments, misadjustment of consumer controls, improper maintenance, power line surge, lightning damage, modification, or commercial use (such as in a hotel, office, restaurant, or other business), rental use of the product, service by anyone other than a Factory Servicenter or other Authorized Servicicer, or damage that is attributable to acts of God.

THERE ARE NO EXPRESS WARRANTIES EXCEPT AS LISTED UNDER "LIMITED WARRANTY COVERAGE". THE WARRANTOR IS NOT LIABLE FOR INCIDENTAL OR CONSEQUENTIAL DAMAGES RESULTING FROM THE USE OF THIS PRODUCT, OR ARISING OUT OF ANY BREACH OF THIS WARRANTY. (As examples, this excludes damages for lost time, travel to and from the servicicer, loss of media or images, data or other memory content. The items listed are not exclusive, but are for illustration only.) **ALL EXPRESS AND IMPLIED WARRANTIES, INCLUDING THE WARRANTY OF MERCHANTABILITY, ARE LIMITED TO THE PERIOD OF THE LIMITED WARRANTY.**

Some states do not allow the exclusion or limitation of incidental or consequential damages, or limitations on how long an implied warranty lasts, so the exclusions may not apply to you.

This warranty gives you specific legal rights and you may also have other rights which vary from state to state. If a problem with this product develops during or after the warranty period, you may contact your dealer or Servicicer. If the problem is not handled to your satisfaction, then write to the warrantor's Consumer Affairs Department at the addresses listed for the warrantor.

PARTS AND SERVICE WHICH ARE NOT COVERED BY THIS LIMITED WARRANTY ARE YOUR RESPONSIBILITY.

Customer Services Directory

Obtain Product Information and Operating Assistance; locate your nearest Dealer or Servicicer; purchase Parts and Accessories; or make Customer Service and Literature requests by visiting our Web Site at:

<http://www.panasonic.com/consumersupport>
or, contact us via the web at:

<http://www.panasonic.com/contactinfo>

You may also contact us directly at:

1-800-211-PANA (7262),

Monday-Friday 9 am-9 pm; Saturday-Sunday 10 am-7 pm, EST.

For hearing or speech impaired TTY users, TTY: 1-877-833-8855

Accessory Purchases

Purchase Parts, Accessories and Instruction Books online for all Panasonic Products by visiting our Web Site at:

<http://www.pstc.panasonic.com>

or, send your request by E-mail to:

npcparts@us.panasonic.com

You may also contact us directly at:

1-800-332-5368 (Phone) 1-800-237-9080 (Fax Only) (Monday-Friday 9 am to 8 pm, EST.)

Panasonic Service and Technology Company

20421 84th Avenue South, Kent, WA 98032

(We Accept Visa, MasterCard, Discover Card, American Express, and Personal Checks)

For hearing or speech impaired TTY users, TTY: 1-866-605-1277

Service in Puerto Rico

Panasonic Puerto Rico, Inc.

Ave. 65 de Infantería, Km. 9.5, San Gabriel Industrial Park, Carolina, Puerto Rico 00985

Phone (787)750-4300, Fax (787)768-2910

Preparativos iniciales

Referirse a las páginas 4 y 5 para las ilustraciones.

Paso 1 - Conexiones

Conecte el cable de alimentación de CA sólo después de haber hecho todas las demás conexiones.

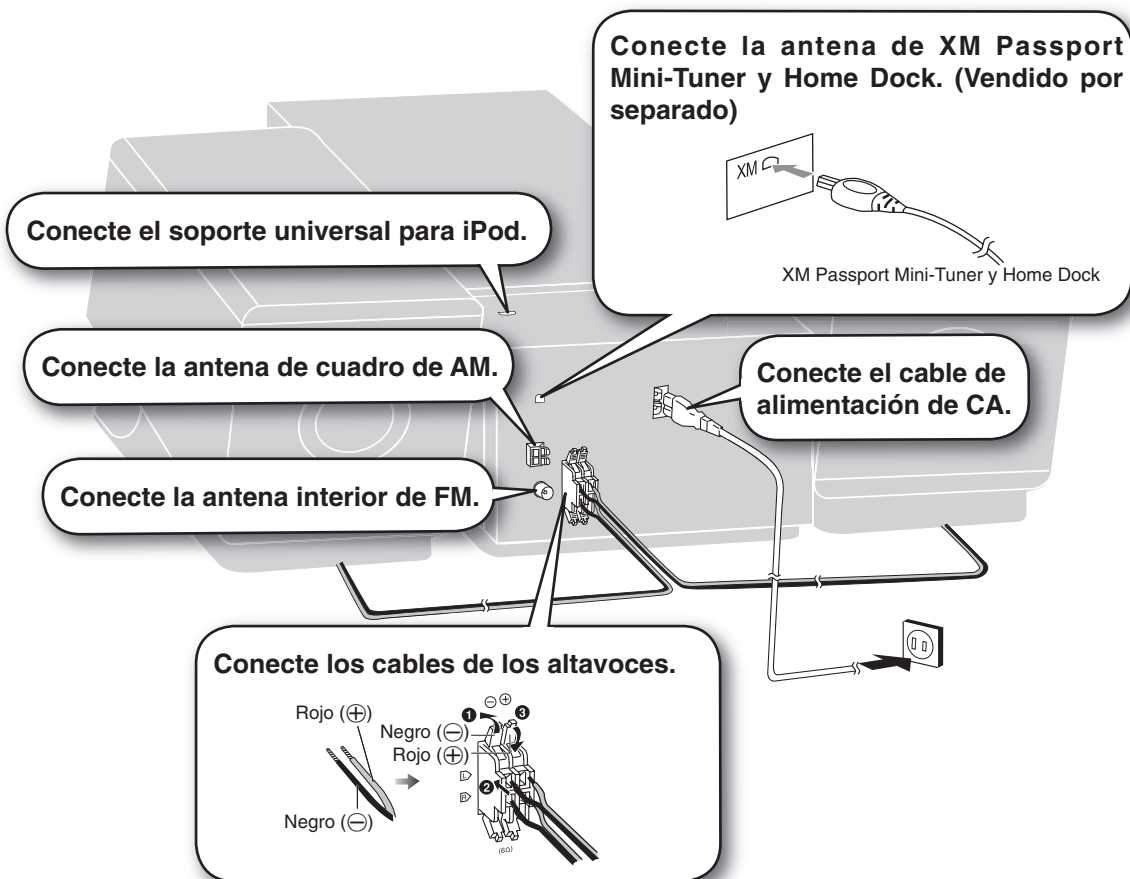

Paso 2 - Introducción de pilas en el mando a distancia

■ Pilas

- Inserte los polos (+ y -) de la forma que se indica en el mando a distancia.
- Retire las pilas si no va a utilizar el mando a distancia durante un periodo de tiempo largo. Guárdelas en un lugar fresco y oscuro.
- No utilice baterías recargables.
- Un mal manejo de pilas en el control remoto puede provocar fugas electrolíticas, que pueden provocar fuego.

■ Utilización

Diríjalo al sensor del mando a distancia, evitando los obstáculos, desde una distancia máxima de 7 m (23 pies) directamente delante del aparato. Consulte la página 19 para ver la posición del sensor de la señal del mando a distancia.

Colocación de los altavoces

Los altavoces han sido diseñados idénticamente por lo que no es necesario orientar el canal derecho o izquierdo.

Utilice solamente los altavoces suministrados.

La combinación de la unidad principal y los altavoces proporcionan el mejor sonido. Utilizando otros altavoces se puede estropear la unidad y el sonido quedará afectado negativamente.

Nota

- Mantenga sus altavoces alejados un mínimo de 10 mm ($^{13}/_{32}$ "") del sistema para tener una ventilación apropiada.
- Estos altavoces no disponen de blindaje magnético. No los ponga cerca de televisores, ordenadores personales u otros dispositivos a los que afecte fácilmente el magnetismo.
- No quite la rejilla frontal de los altavoces.



Precaución

- Use los altavoces sólo con el sistema recomendado. De lo contrario, se podrían dañar el amplificador y los altavoces, y se podría ocasionar un incendio. Consulte a un técnico de servicio especializado si se ha producido algún daño o si se ha producido un cambio repentino en su funcionamiento.
- No instale estos altavoces en paredes ni techos.

Download from www.Somanuals.com. All Manuals Search And Download.

Controles

Aparato principal

Los números entre paréntesis indican la página de referencia.

Parte superior del aparato

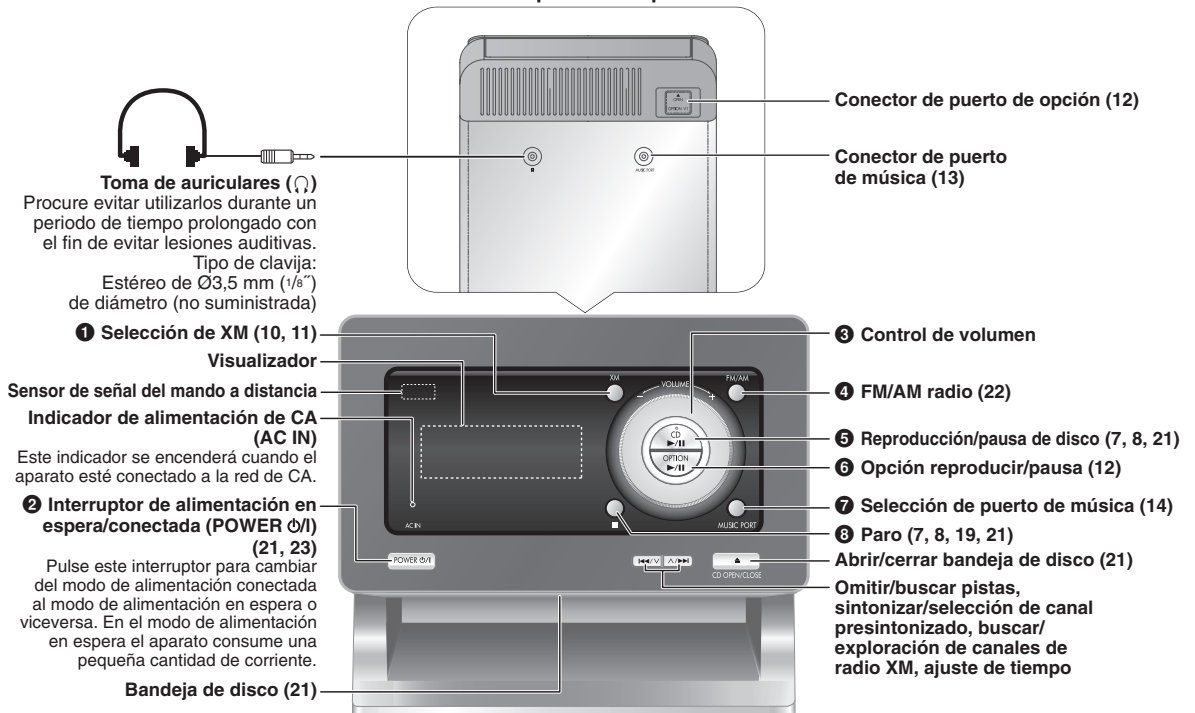

Mando a distancia

Buttons such as 1 function the same as the controls on the main unit.

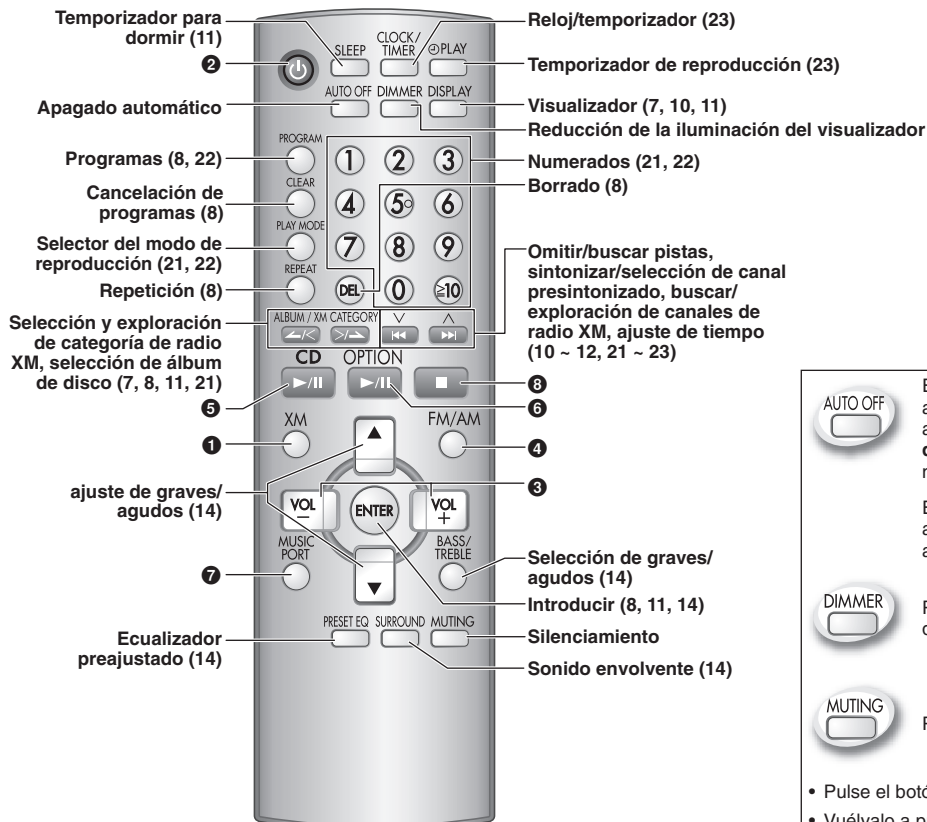

AUTO OFF Esta función de apagado automático le permite apagar el aparato en modo **disco**, sólo después de 10 minutos sin utilizarlo.

El ajuste se mantiene aunque el aparato esté apagado.

DIMMER Para reducir la iluminación del visualizador.

MUTING Para silenciar el sonido.

- Pulse el botón para activarlo.
- Vuélvalo a pulsar para cancelar.

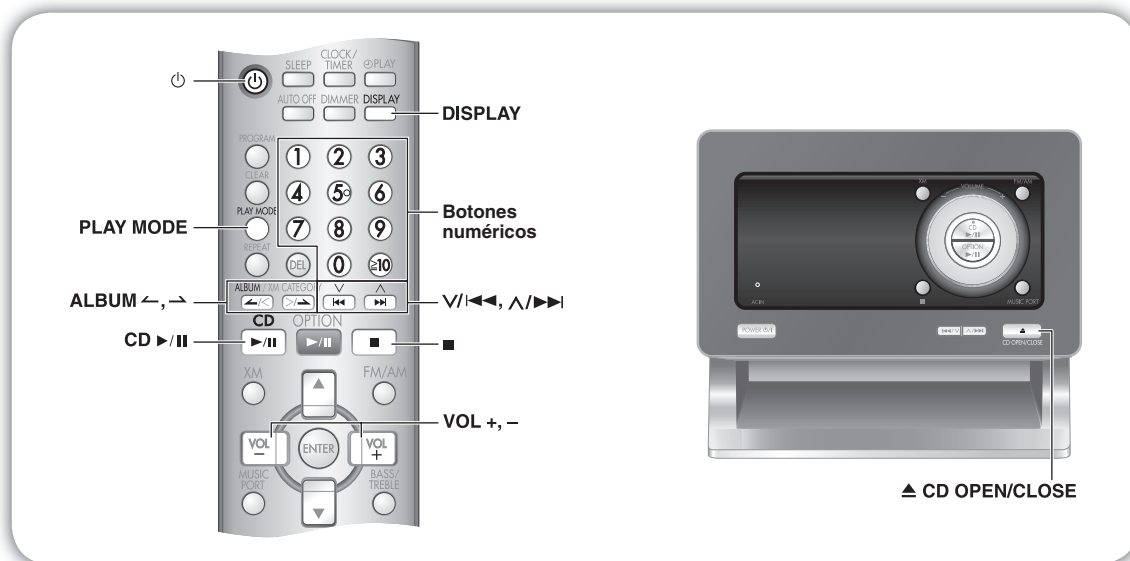

Reproducción básica

CD MP3

- 1 Pulse [⏻] para encender el aparato.
- 2 Pulse [▲ CD OPEN/CLOSE] para abrir la tapa del disco e inserte el disco. Cierre la tapa.



La etiqueta tiene que estar hacia arriba

- 3 Pulse [CD ▶/||] para iniciar la reproducción.
- 4 Ajuste el volumen.

Para	Acción
stop the disc	Pulse [■].
pause play	Pulse [CD ▶/]. Vuelva a pulsar para reanudar la reproducción.
skip tracks	Pulse [V/ ◀◀] o [V/▶▶].
search through tracks	Mantenga pulsado [V/ ◀◀] o [V/▶▶] durante la reproducción o la pausa.
skip album	Pulse [ALBUM ◀ o ▶] en el modo de reproducción. Pulse [ALBUM ◀ o ▶] una vez y los botones numéricos en el modo de parada.

CD

MP3

Función de modo de reproducción

CD MP3

- 1 Pulse [CD ▶/||].
- 2 Pulse [PLAY MODE] para seleccionar el modo deseado.

Modo	Para reproducir
1-TRACK 1TR	una melodía seleccionada del disco. Pulse las teclas numéricas para seleccionar la pista.
1-ALBUM 1ALBUM MP3	un álbum seleccionado del disco. Pulse [ALBUM ◀ o ▶] para seleccionar el álbum.
RANDOM RND	un disco aleatoriamente.
1-ALBUM RANDOM 1ALBUM RND MP3	todas las pistas de un álbum seleccionado aleatoriamente. Pulse [ALBUM ◀ o ▶] para seleccionar el álbum.

Nota

- Durante la reproducción RANDOM o 1-ALBUM RANDOM, no puede saltar pistas que ya han sido reproducidas.

CD

- Durante la reproducción RANDOM, podrá buscar hacia delante o hacia atrás dentro de la pista actual solamente.

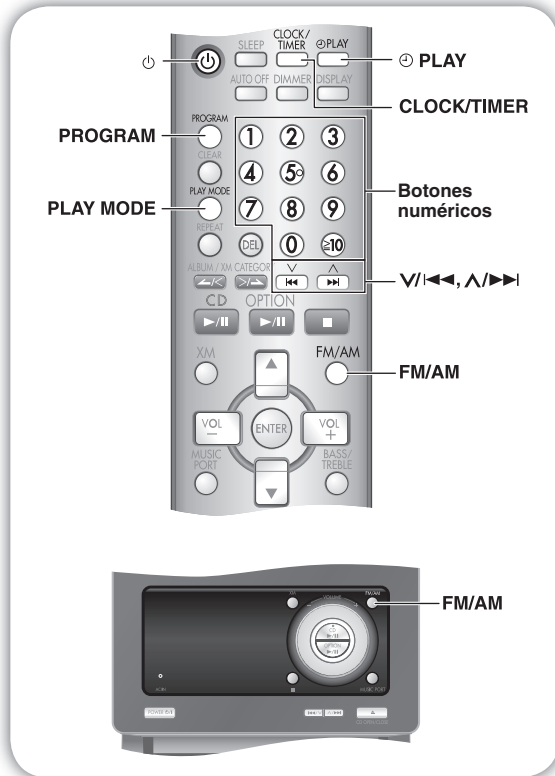

Sintonización manual

- 1 Pulse [FM/AM] para seleccionar "FM" o "AM".
- 2 Pulse [PLAY MODE] para seleccionar "MANUAL".
- 3 Pulse [V/◀◀] o [▶▶/∧] para seleccionar la frecuencia de la emisora requerida.



Se visualizará "ST" cuando esté siendo recibida una emisora estéreo por FM.

Para sintonizar automáticamente

Pulse [V/◀◀] o [▶▶/∧] hasta que la frecuencia empiece a cambiar rápidamente. El aparato inicia la sintonización automática y se detendrá cuando encuentre una emisora.

- La sintonización automática tal vez se interrumpa cuando las interferencias sean excesivas.
- Para cancelar la sintonización automática, pulse una vez más [V/◀◀] o [▶▶/∧].

Para mejorar la calidad del sonido de FM

Mantenga pulsado [PLAY MODE] para visualizar "MONO".

Para cancelar

Mantenga pulsado [PLAY MODE] otra vez hasta que "MONO" desaparezca.

- MONO también se cancelará si se cambia la frecuencia.
- Deje "MONO" apagado para la escucha normal.

Grabación de emisoras en memoria

Se pueden presintonizar un máximo de 20 emisoras en la banda FM y 15 en la banda AM.

Preparación

Pulse [FM/AM] para seleccionar "FM" o "AM".

Presintonización automática

Mantenga pulsado [PROGRAM] para iniciar la presintonización.

Presintonización manual

- 1 Pulse [PLAY MODE] para seleccionar "MANUAL".
- 2 Pulse [V/◀◀] o [▶▶/∧] para seleccionar la emisora deseada.
- 3 Pulse [PROGRAM].
- 4 Pulse los botones numéricos para seleccionar el canal. La emisora que ocupa un canal se borrará si se presintoniza otra emisora en ese canal.
- 5 Repita los pasos del 2 al 4 para preestablecer más emisoras.

Selección de una emisora presintonizada

Pulse los botones numéricos para seleccionar el canal. Para canales de dos dígitos, pulse [≥10], y a continuación los dos dígitos.

0

- 1 Pulse [PLAY MODE] para seleccionar "PRESET".
- 2 Pulse [V/◀◀] o [▶▶/∧] para seleccionar el canal.

Ajuste de la asignación de FM

Aparato principal solamente

Este sistema le permite recibir emisiones de FM asignadas en pasos de 0,1 MHz.

Para cambiar el paso a 0,1 MHz

- 1 Mantenga pulsado [FM/AM]. Después de unos segundos, la visualización cambiará a una visualización parpadeante de la frecuencia mínima actual.
- 2 Continúe pulsando [FM/AM].
 - Si la frecuencia mínima cambia, suelte el botón. Para volver al paso original, repita los pasos anteriores.
 - Después de cambiar el ajuste de "asignación", las frecuencias previamente preajustadas en la memoria se borrarán.

Temporizador

Puesta en hora

Éste es un reloj de sistema de 12 horas.

- 1 Pulse [CLOCK/TIMER] para seleccionar "CLOCK".
Cada vez que pulse el botón:

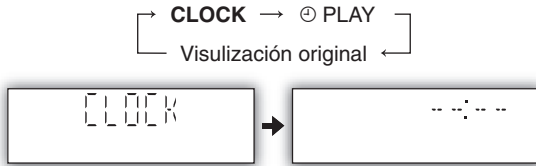

- 2 Entre 5 segundos, pulse [V/◀◀] o [V/▶▶] para ajustar la hora.



- 3 Pulse [CLOCK/TIMER] para terminar de poner la hora.



Visualización del reloj

Pulse [CLOCK/TIMER] para visualizar el reloj durante unos segundos.

Nota

El reloj puede atrasarse o adelantarse en un plazo de tiempo. Si es necesario vuelva a ponerlo en hora.

Utilización del temporizador de reproducción

Puede ajustar el temporizador para que se encienda a una hora determinada para despertarle.

Preparación

Encienda el aparato y ponga en hora el reloj.
Prepare la fuente musical que desea escuchar: disco, radio o fuente de puerto de musica y ajuste el volumen.

- 1 Pulse [CLOCK/TIMER] repetidamente para seleccionar el temporizador de reproducción.

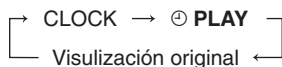

- 2 Entre 5 segundos, pulse [V/◀◀] o [V/▶▶] para ajustar la hora de inicio.



- 3 Pulse [CLOCK/TIMER] para confirmar.
- 4 Repita los pasos 2 y 3 para ajustar la hora de finalización.

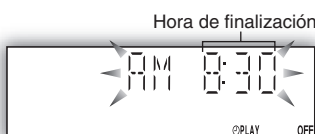

Para activar el temporizador

- 5 Pulse [⊖PLAY] para conectar el temporizador.
"⊖PLAY" se muestra en pantalla.

- 6 Pulse [⊖] para apagar el aparato.
El aparato debe estar apagado para que funcionen los temporizadores.

Para	Acción
cambiar la configuración	Repetir los pasos de 1 a 4 y 6.
cambiar la fuente o el volumen	1) Pulse [⊖PLAY] para cancelar el ⊖PLAY indicador del visualizador. 2) Cambie la fuente o el volumen. 3) Realice los pasos 5 y 6.
compruebe la configuración (si el aparato está encendido o está en modo de espera)	Pulse [CLOCK/TIMER] repetidamente seleccione ⊖PLAY.
cancelar	Pulse [⊖PLAY] para cancelar el temporizador indicadores del visualizador.

Nota

- El temporizador se pondrá en marcha a la hora programada y el volumen aumentará gradualmente hasta el nivel seleccionado.
- Si el temporizador está activo, se encenderá todos los días a la hora fijada.
- El aparato debe estar en modo de espera para que el temporizador funcione.
- Si apaga el aparato y lo vuelve a encender mientras está funcionando un temporizador, no se activará el ajuste de tiempo de terminación.
- Si se selecciona el puerto música (MUSIC PORT) o puerto opcional (OPTION PORT) como fuente cuando el temporizador avance, el sistema se enciende y se utilice el puerto de música (MUSIC PORT) o puerto opcional (OPTION PORT) como fuente. Si desea reproducir o grabar desde el equipo reproductor portátil de audio, sólo ha de activar el modo reproducir del equipo reproductor y aumente el volumen. (Ver el manual de instrucciones del reproductor portátil de audio.)

**Panasonic Consumer Electronics
Company, Division of Panasonic
Corporation of North America**
One Panasonic Way Secaucus,
New Jersey 07094
<http://www.panasonic.com>

Panasonic Puerto Rico, Inc.
Ave. 65 de Infantería, Km. 9.5
San Gabriel Industrial Park, Carolina,
Puerto Rico 00985



Free Manuals Download Website

<http://myh66.com>

<http://usermanuals.us>

<http://www.somanuals.com>

<http://www.4manuals.cc>

<http://www.manual-lib.com>

<http://www.404manual.com>

<http://www.luxmanual.com>

<http://aubethermostatmanual.com>

Golf course search by state

<http://golfingnear.com>

Email search by domain

<http://emailbydomain.com>

Auto manuals search

<http://auto.somanuals.com>

TV manuals search

<http://tv.somanuals.com>