

SLIM POWER RELAY WITH HIGH INRUSH CURRENT CAPABILITY TV-8 CERTIFIED

LK-T RELAYS

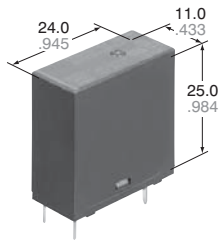

FEATURES

1. High inrush current capability

1) Operating load capability:
inrush 118 A, steady 8 A

2) UL/C-UL TV-8 approved

2. High insulation resistance

1) Creepage distance and clearances between contact and coil: Min. 6 mm .236 inch (In compliance with IEC65)

2) Surge withstand voltage between contact and coil: 10,000 V or more

3. High noise immunity realized by the card separation structure between contact and coil

4. Conforms to the various safety standards

UL, C-UL, TÜV, and SEMKO approved

SPECIFICATIONS

Contact

Arrangement	1 Form A	
Initial contact resistance (By voltage drop 6 V DC 1 A)	Max. 100 mΩ	
Contact material	AgSnO ₂ type	
Rating (resistive load)	Nominal switching capacity	5 A 277 V AC
	Max. switching power	1,385 V A
	Max. switching voltage	277 V AC
	Max. switching current	8 A (120V AC)
Expected life (min. operations)	Min. switching capacity*1 (Reference value)	100 mA, 5 V DC
	Mechanical (at 180 cpm)	10 ⁶
Expected life (min. operations)	Electrical (at 20 cpm) (at rated load)	10 ⁵

Coil

Nominal operating power	250 mW
-------------------------	--------

#1 This value can change due to the switching frequency, environmental conditions, and desired reliability level, therefore it is recommended to check this with the actual load.

Remarks

*1 Measurement at same location as "Initial breakdown voltage" section.

*2 Detection current: 10mA

*3 Wave is standard shock voltage of $\pm 1.2 \times 50\mu\text{s}$ according to JEC-212-1981

*4 Excluding contact bounce time.

*5 Half-wave pulse of sine wave: 11 ms; detection time: 10 μs

*6 Half-wave pulse of sine wave: 6 ms

*7 Detection time: 10 μs

*8 The upper operation ambient temperature limit is the maximum temperature that can satisfy the coil temperature rise value. Refer to 1. Usage, transport and storage conditions in NOTES on page 3.

Characteristics

Max. operating speed	20 cpm (at rated load)	
Initial insulation resistance*1	Min. 1,000 MΩ (at 500 V DC)	
Initial *2 breakdown voltage	Between open contacts	1,000 Vrms for 1 min.
	Between contact and coil	4,000 Vrms for 1 min.
Initial surge voltage between contact and coil*3	10,000 V	
Operate time*4 (at nominal voltage)	Max. 15ms (at 20°C 68°F)	
Release time (without diode)*4 (at nominal voltage)	Max. 5ms (at 20°C 68°F)	
Temperature rise (at 70°C)	Max. 35°C with nominal coil voltage and at 5 A contact carrying current (resistance method)	
Shock resistance	Functional*5	200 m/s ² {approx. 20 G}
	Destructive*6	1,000 m/s ² {approx. 100 G}
Vibration resistance	Functional*7	10 to 55Hz at double amplitude of 1.5mm
	Destructive	10 to 55Hz at double amplitude of 1.5mm
Conditions for operation, transport and storage*8 (Not freezing and condensing at low temperature)	Ambient temp.	-40°C to +70°C -40°F to +158°F
	Humidity	5 to 85% R.H.
	Air pressure	86 to 106 kPa
Unit weight	Approx. 12 g .42 oz	

TYPICAL APPLICATIONS

- Audio visual equipment
- Flat TVs and audio equipment, etc.
- Office equipment
- Home appliances

ORDERING INFORMATION

Ex. LKT 1a F — 12V

Contact arrangement	Protective construction	Coil voltage(DC)
1a: 1 Form A	F: Flux-resistant type	5, 9, 12, 24V

UL/C-UL, TÜV, SEMKO, TV-8 approved type is standard.

Notes: 1. Standard packing Carton: 100 pcs. Case: 500 pcs.

2. 3 V, 6 V, and 18 V DC types are also available. Please consult us for details.

TYPES AND COIL DATA (at 20°C 68°F)

Part No.	Nominal voltage, V DC	Pick-up voltage, V DC (max.) (Initial)	Drop-out voltage, V DC (min.) (Initial)	Coil resistance, Ω (±10%)	Nominal operating current, mA (±10%)	Nominal operating power, mW	Maximum allowable voltage, V DC (at 20°C 68°F)
LKT1aF-5V	5	(Initial) 3.5	(Initial) 0.5	100	50	250	6.5
LKT1aF-9V	9	(Initial) 6.3	(Initial) 0.9	324	27.8	250	11.7
LKT1aF-12V	12	(Initial) 8.4	(Initial) 1.2	576	20.8	250	15.6
LKT1aF-24V	24	(Initial) 16.8	(Initial) 2.4	2,304	10.4	250	31.2

DIMENSIONS

mm inch

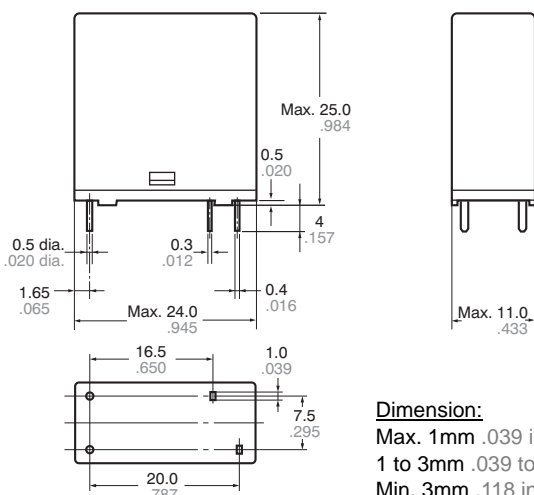

PC board pattern (Bottom view)

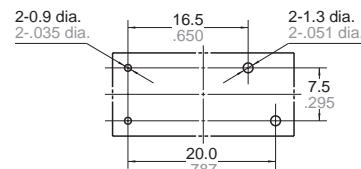

Tolerance: ±0.1 ±.004

Schematic (Bottom view)



REFERENCE DATA

1. Max. switching power (AC resistive load)

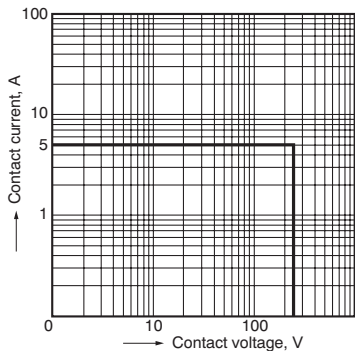

2. Coil temperature rise

Sample: LKT1aF-12V, 6 pcs.
Point measured: coil inside
Contact current: 0 A, 5A

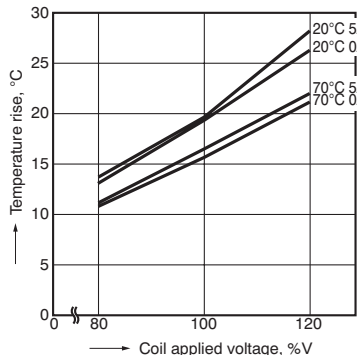

3. Ambient temperature characteristics and coil applied voltage

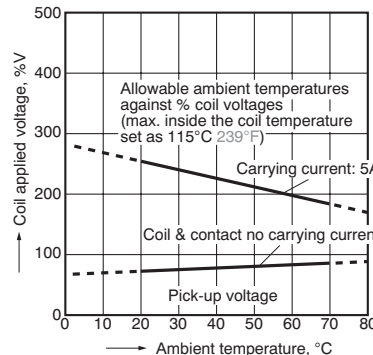

4-(1). Electrical life test

(5 A 277 V AC, resistive load)
Sample: LKT1aF-12V, 6 pcs.
Operation frequency: 20 times/min.
(ON/OFF = 1.5s: 1.5s)
Ambient temperature: 20°C 68°F

Circuit:

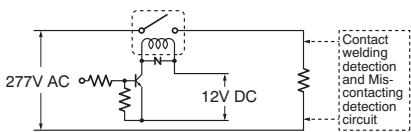

Change of pick-up and drop-out voltage

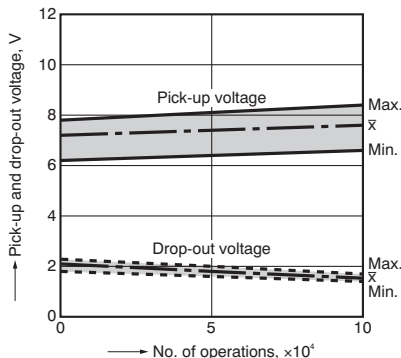

Change of contact resistance

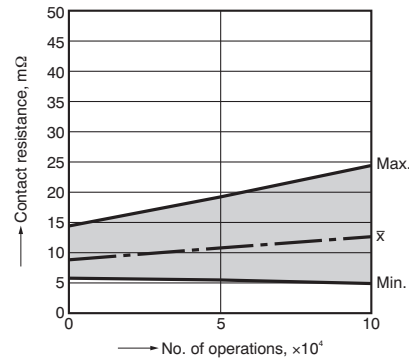

4-(2). Electrical life test (UL508 TV-8 rating test)

Sample: LKT1aF-12V, 6 pcs.

• Overload test

Load: 12 A 120 V AC (60 Hz),
Inductive load ($\cos\phi = 0.75$)
Operation frequency: 6 times/min
(ON : OFF = 1 s : 9 s)
No. of operations: 50 ope.

• Endurance test

Load: 8A 120 V AC (960 W lamp load),
(Inrush: 118 A)
Operation frequency: 1 times/min
(ON : OFF = 1 s : 59 s)
No. of operations: 25,000 ope.

Change of pick-up and drop-out voltage

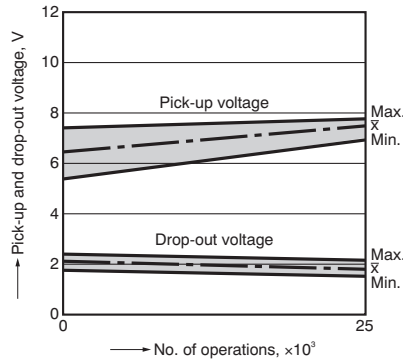

Change of contact resistance

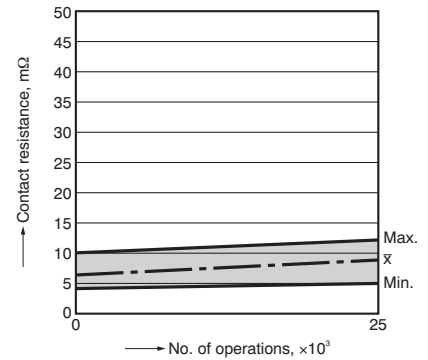

NOTES

1. Usage, transport and storage conditions

1) Temperature:

-40 to +70°C -40 to +158°F

2) Humidity: 5 to 85% RH

(Avoid freezing and condensation.)

The humidity range varies with the temperature. Use within the range indicated in the graph below.

3) Atmospheric pressure: 86 to 106 kPa

Temperature and humidity range for usage, transport, and storage

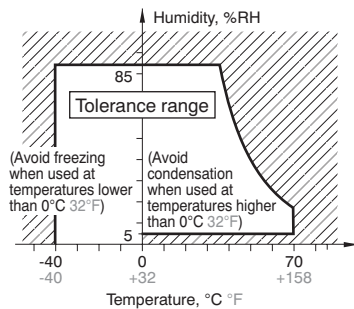

4) Condensation

Condensation forms when there is a sudden change in temperature under high temperature and high humidity conditions. Condensation will cause deterioration of the relay insulation.

5) Freezing

Condensation or other moisture may freeze on the relay when the temperatures is lower than 0°C 32°F. This causes problems such as sticking of movable parts or operational time lags.

6) Low temperature, low humidity environments

The plastic becomes brittle if the relay is exposed to a low temperature, low humidity environment for long periods of time.

2. Solder and cleaning conditions

1) Please obey the following conditions when soldering automatically.

(1) Preheating: Within 120°C 248°F (solder surface terminal portion) and within 120 seconds

(2) Soldering iron: 260°C±5°C 500°F±41°F (solder temperature) and within 6 seconds (soldering time)

2) Since this is not a sealed type relay, do not clean it as is. Also, be careful not to allow flux to overflow above the PC board or enter the inside of the relay.

3. Certification

1) This relay is UL and C-UL certified (File No. E43149).

UL, C-UL rating: TV-8

2) This relay is certified by TUV as an electromagnetic relay that complies with VDE0435 (File No. B040413461035).

(1) TUV rating: 8A, 250 V to $\cos\phi = 1.0$

(2) The terminals of this relay can only be connected with solder.

(3) This relay is certified by SEMKO (File No. 400968).

SEMKO rating: 3/100A 250 V AC, 5/40A 250 V AC

4. Others

1) For precautions regarding use and explanations of technical terminology, please refer to "Relay Technical Information".

2) To ensure good operation, please keep the voltage on the coil ends to $\pm 5\%$ (at 20°C 68°F) of the rated coil operation voltage. Also, please be aware that the pick-up voltage and drop-out voltage may change depending on the temperature and conditions of use.

3) Keep the ripple rate of the nominal coil voltage below 5%.

4) The cycle lifetime is defined under the standard test condition specified in the JIS* C 5442 standard (temperature 15 to 35°C 59 to 95°F, humidity 25 to 75%). Check this with the real device as it is affected by coil driving circuit, load type, activation frequency, activation phase, ambient conditions and other factors.

Also, be especially careful of loads such as those listed below.

(1) When used for AC load-operating and the operating phase is synchronous.

Rocking and fusing can easily occur due to contact shifting.

(2) High-frequency load-operating
When high-frequency opening and closing of the relay is performed with a load that causes arcs at the contacts, nitrogen and oxygen in the air is fused by the arc energy and HNO_3 is formed. This can corrode metal materials.

Three countermeasures for these are listed here.

- Incorporate an arc-extinguishing circuit.
- Lower the operating frequency
- Lower the ambient humidity

5) Heat, smoke, and even a fire may occur if the relay is used in conditions outside of the allowable ranges for the coil ratings, contact ratings, operating cycle lifetime, and other specifications. Therefore, do not use the relay if these ratings are exceeded.

6) If the relay has been dropped, the appearance and characteristics should always be checked before use.

7) Incorrect wiring may cause unexpected events or the generation of heat or flames.

For Cautions for Use, see [Relay Technical Information](#).

Free Manuals Download Website

<http://myh66.com>

<http://usermanuals.us>

<http://www.somanuals.com>

<http://www.4manuals.cc>

<http://www.manual-lib.com>

<http://www.404manual.com>

<http://www.luxmanual.com>

<http://aubethermostatmanual.com>

Golf course search by state

<http://golfingnear.com>

Email search by domain

<http://emailbydomain.com>

Auto manuals search

<http://auto.somanuals.com>

TV manuals search

<http://tv.somanuals.com>