

Quick Reference Guide

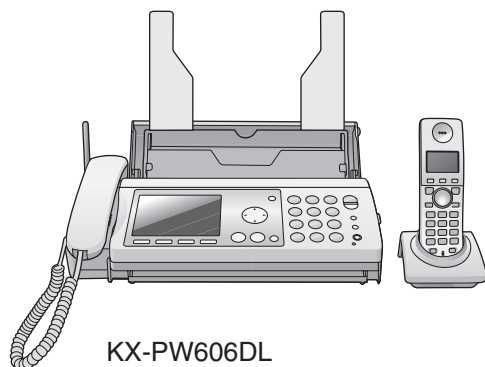

KX-PW606DL

Model No. **KX-PW606DL**
KX-PW606DW
KX-PW616DL
KX-PW616D

Main unit: KX-PW606
 KX-PW616
 Portable handset: KX-FKN514

Thank you for purchasing a Panasonic facsimile.

Table of Contents

Finding the controls	2
Installations and connections	4
Setting the date and time.....	7
Setting your facsimile telephone number	7
Setting your logo	8
Character input and command key table	9
Voice guide.....	10
Automatic dialing on the main unit	11
Automatic dialing on the portable handset (KX-FKN514)	13
Intercom	14
Sending faxes	15
Receiving faxes	16
Operating the built-in answering device	19
Night mode.....	20
Call block	21
Specifications	22

- This guide explains some basic features and operations, but not all of them. For further details, see the Japanese operating instructions.
- This product is designed for use in Japan.
Panasonic cannot provide service for this product if used outside Japan.
- Any details given in this guide are subject to change without notice.

This unit is equipped with the voice guide features. (Japanese only)
For details about voice guide, please see page 10.

Finding the controls

Main unit

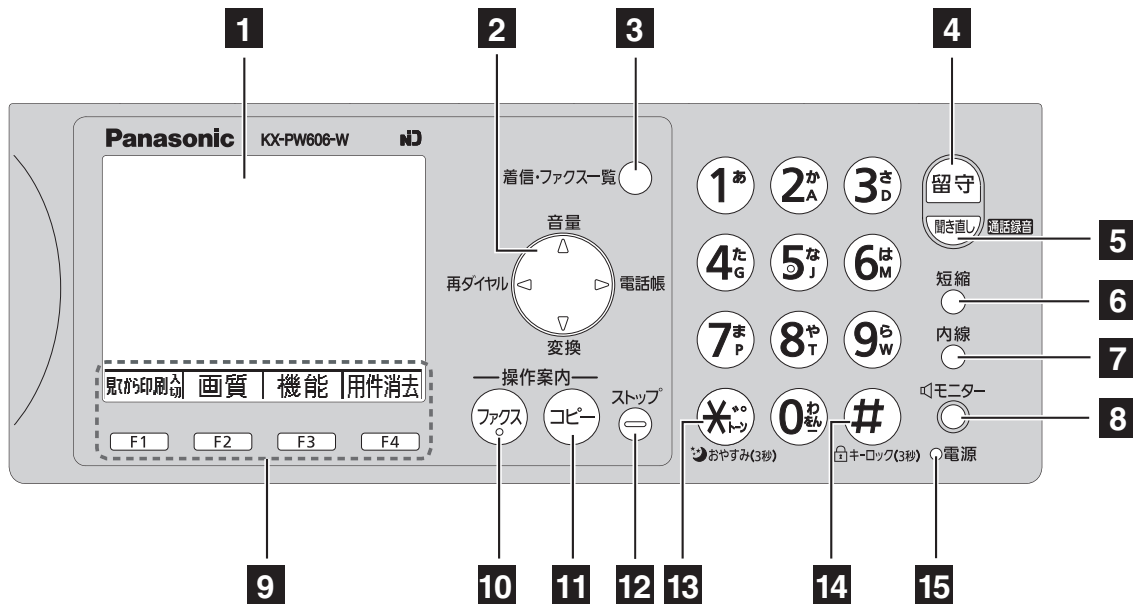

1 Liquid crystal display

- The display turns off after about 2 minutes of inactivity.
- PW606 has a monochrome display.
- PW616 has a color display.

2 Volume/Change/Redial/Phonebook key



- To adjust the volume.
- To change Hiragana into Kanji.



To redial the phone numbers in the redial list. The last 10 phone numbers dialed are stored in memory.



To use the phonebook.

3 Call/Fax List button starts a search in

- the Number Display (Caller ID) log.
 - the fax list stored in memory.
- Call/Fax List** indicator lights when
- a call was missed. (For Number Display service users.)
 - a fax was stored in memory.

4 Auto Answer button & indicator

- light on: answering device activated.
- light off: used as a regular telephone.

5 Replay button plays back recorded messages.

Record button records a telephone conversation.

6 Speed Dialer button

7 Intercom button

8 Monitor button

9 Multi-operation buttons refer to the function displayed on the display panel.

10 Fax button starts faxing.

11 Copy button starts copying.

12 Stop button

13 Tone button switches to tone dialing.

Night mode button

14 Sharp button

Key lock button can lock the main unit so that no calls or settings can be made. To turn key lock on, press this button for about 3 seconds until a single beep is heard.

- “**鍵キロック**” is displayed.
- To turn key lock off, press this button for about 3 seconds.





15 Power indicator

Finding the controls



Portable handset (KX-FKN514)

Ringer indicator flashes when you are receiving an incoming call or a call is put on hold.

How to use key

-  電話帳 ● To use the phonebook.
-  再ダイヤル ● To redial the phone numbers in the redial list. The last 10 phone numbers dialed are stored in memory.
-  音量/変換 ● To adjust the volume.
-  音量/変換 ● To change Hiragana into Kanji.

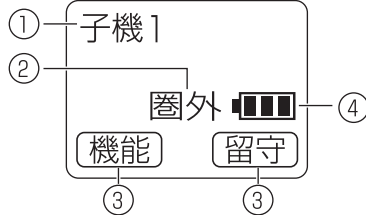

Liquid crystal display

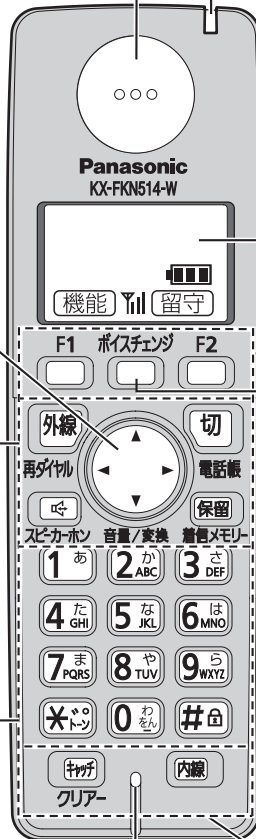

- 
- ① Portable handset number (and name)
 - ② No link to the main unit
 - ③ Function menu that is controlled by  or 
 - ④ Battery strength

Earpiece



How to use buttons

- F1  and F2  buttons refer to the function displayed on the bottom of the display. They function differently depending on the mode.

-  ボイスチェンジ ● To change your voice.
-  ● To mute your voice to the other party by pressing this button for about 2 seconds. (To release the mute, press this button again.)

 外線 ● To make/answer calls.

 切 ● To end a call.

● To end or exit from editing or other operations.

 保留 ● To put a call on hold.

 着信メモリー ● To start a search in the Number Display log. (For Number Display service users.)

 スピーカーホン ● To use the speakerphone.

Dial buttons

 * 〆 Tone button

● To switch to tone dialing.

 # 〆 Sharp button

Key lock button

- To lock the portable handset so that no calls or settings can be made. To turn key lock on, press this button for about 3 seconds until a single beep is heard.
- “ キーロック” is displayed.
- To turn key lock off, press this button for about 3 seconds.

Microphone

(Do not cover the microphone while talking.)

 キャッチ ● For call waiting service users.

 クリアー ● To clear letters/numbers.

 内線 ● To page the main unit and/or portable handset(s).

Installations and connections

Installing the ink film

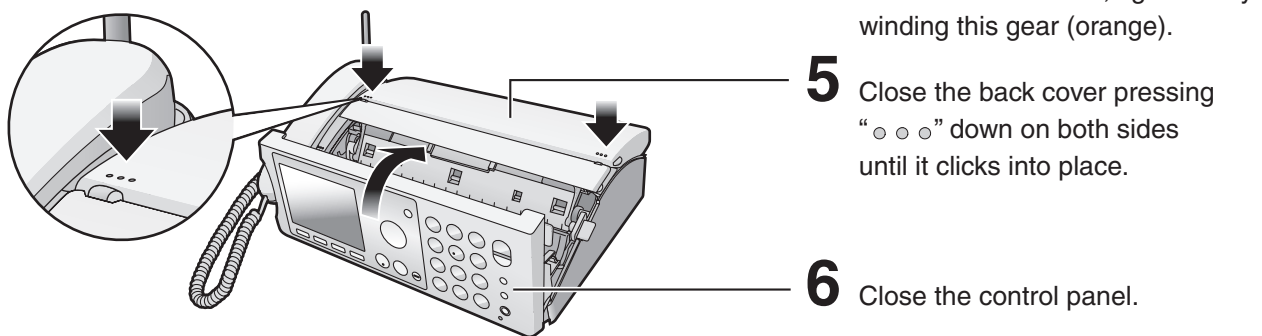
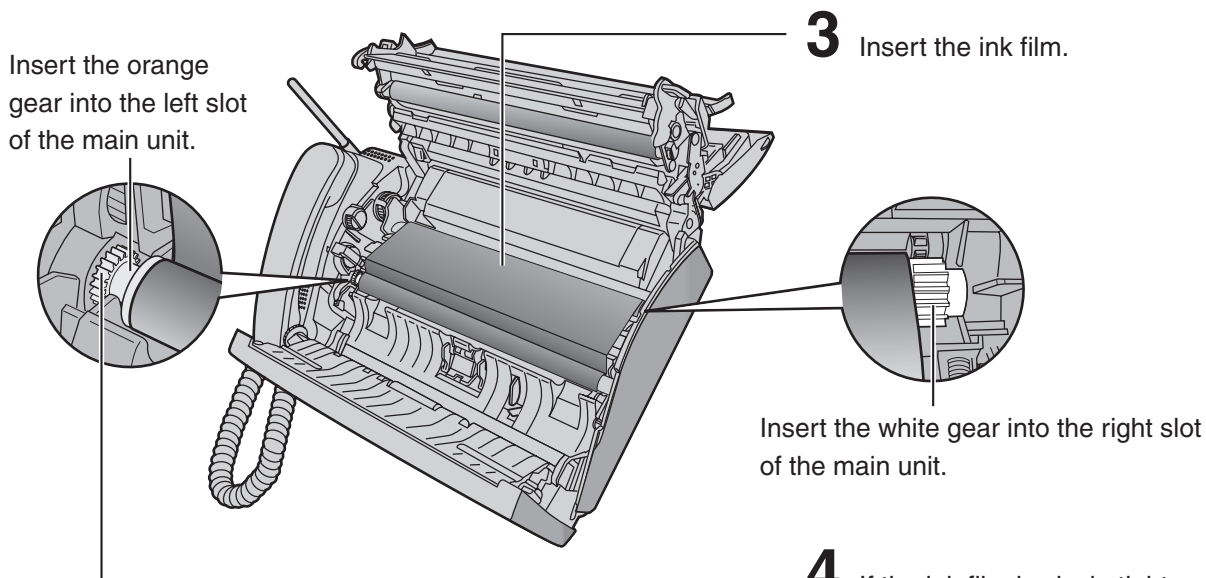
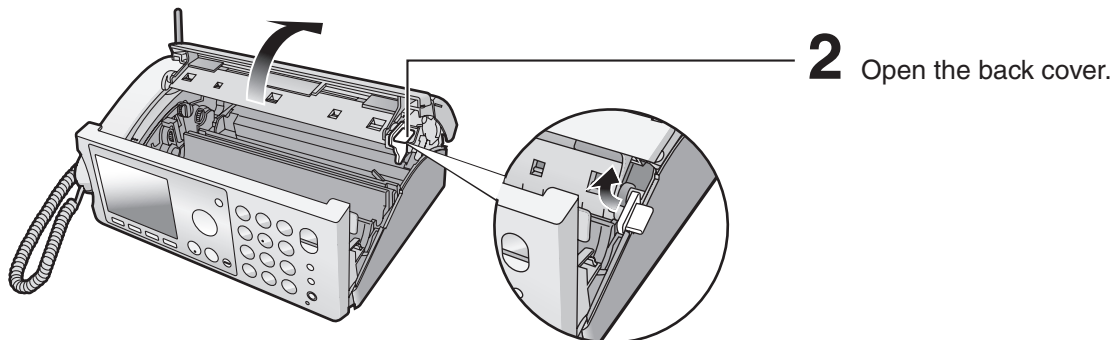
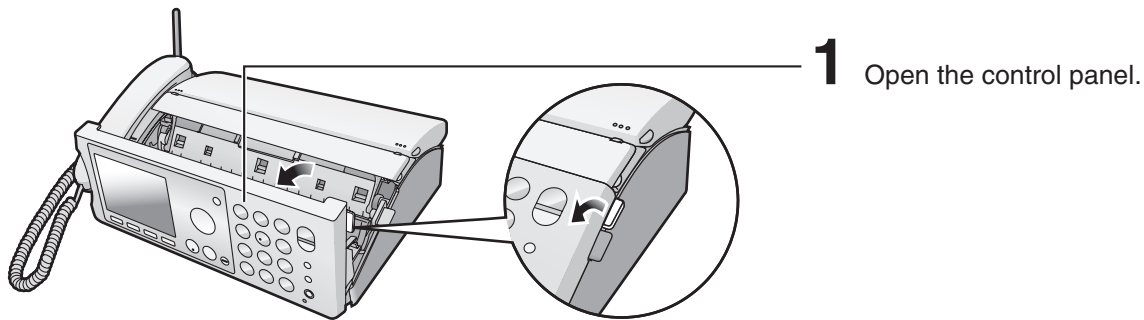

- When the unit runs out of ink film, the following message will be displayed.

フィルムがなくなりました U23
交換してください
品番：KX-FAN190

Install a new ink film.

Replacement ink film:	
KX-FAN190 (15 m)	¥714
KX-FAN190W (15 m X 2)	¥1,208

· As of February 2007.

· Tax included.

Installations and connections

Installing recording paper (A4 size)

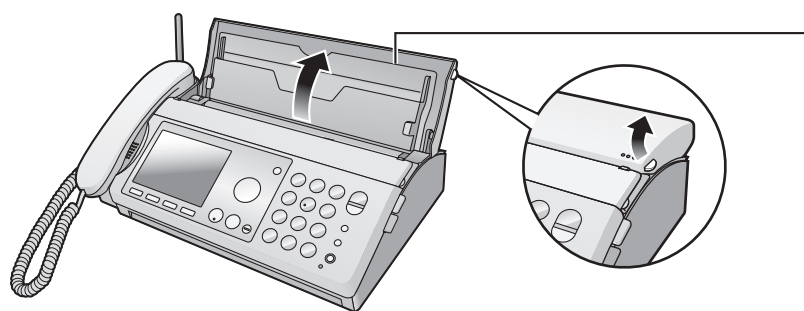

1 Open the recording paper tray.

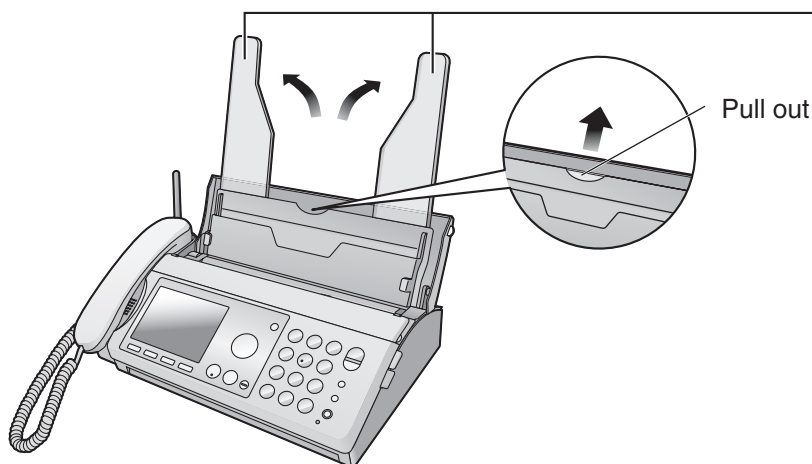

2 Set up the recording paper stands.

Pull out the front stand first.

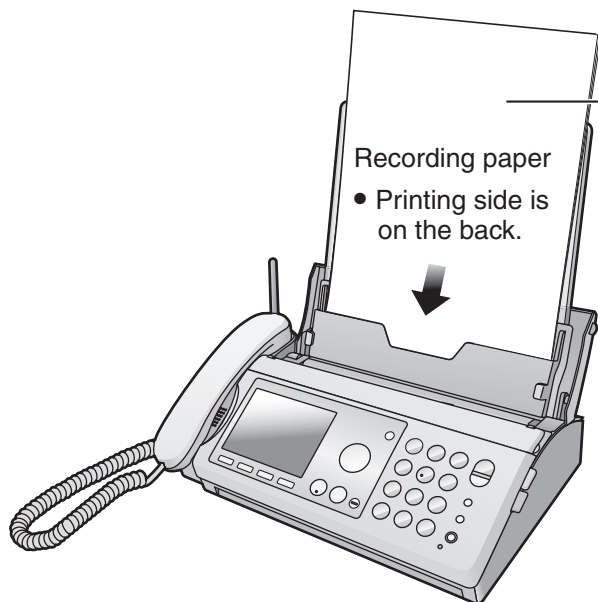

3 Insert the recording paper into the recording paper tray. (Up to 15 sheets)

- Fan the stack of recording paper.

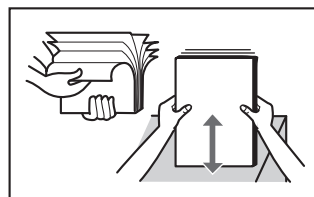

Folding the recording paper tray

① Remove the recording paper and fold the recording paper stands in.



② Close the recording paper tray.



Installations and connections

Connecting the main unit

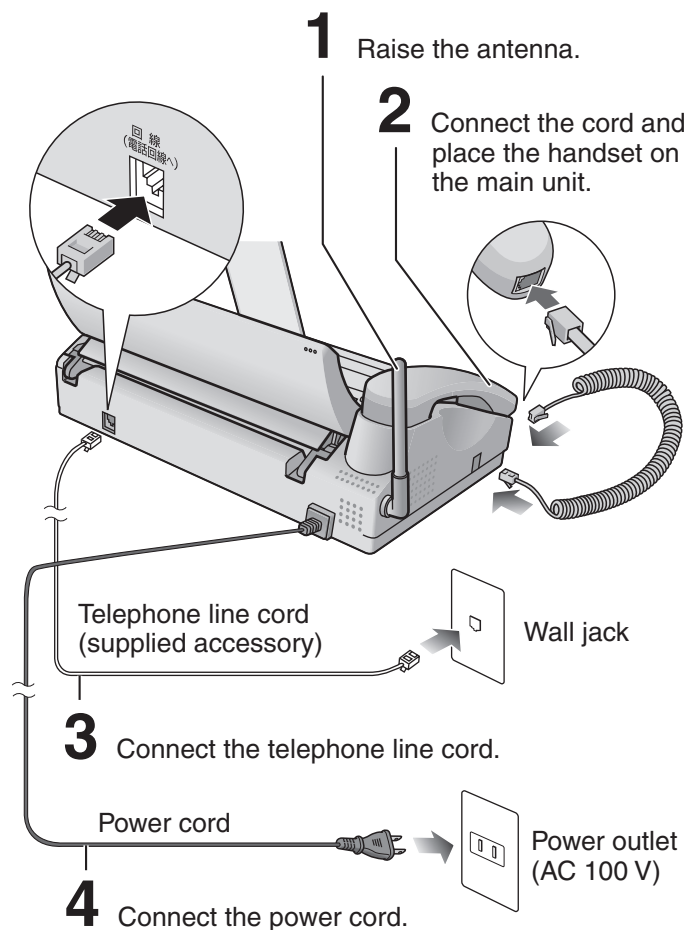

After the Power On...

- ① This unit will automatically select the dialing mode (Tone/Pulse).
- ② When the following is displayed, press
ストップ (Stop). 選んでケータイ
あり, なし

If you can not make a call...

Set the dialing mode with the main unit.

1. Press **機能** (F3) (Function).
2. Press **# 0 7 9**.
3. Press **⬆** (Search button) repeatedly until the desired setting is selected.

Example :

回線種別
自動, フォン, 20, 10

- フォン: Tone
- 20 : Pulse (20 PPS)
- 10 : Pulse (10 PPS)
- 自動 : Auto (Default)

4. Press **決定** (F3) (Set).
5. Press **ストップ** (Stop).

Setting up the portable handset (KX-FKN514)

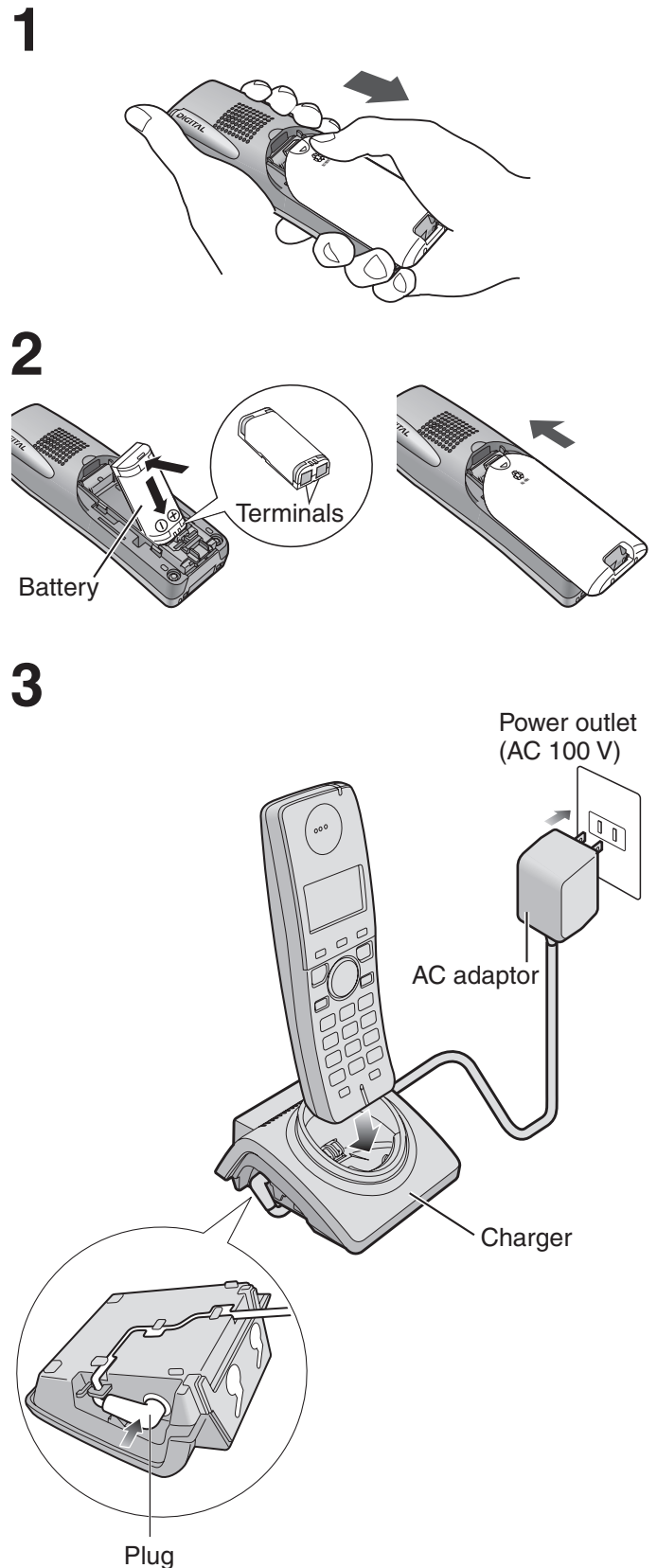

Setting the date and time

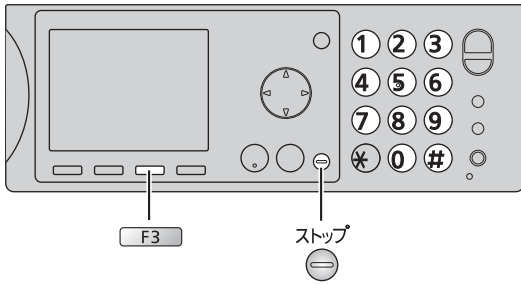

1 Press **機能** (Function).

最初の設定
 呼出音とベル回数
 音声の設定
 電話帳の設定

2 Press **# 0 0 1**.

Example : 2007年09月30日
 15:00
 — Cursor

3 Enter the correct year/month/day.
Example: October 1, 2007
 Press **2 0 0 7 1 0 0 1**.

2007年10月01日
 15:00

4 Enter the correct hour/minute in a 24-hour clock entry.
Example: 15:45 (3:45 PM)
 Press **1 5 4 5**.

2007年10月01日
 15:45

5 Press **決定** (Set).

登録しました



2007年10月01日
 15:45

6 Press **ストップ** (Stop).

Example : 用件 0件
 ファクス 0件

Setting your facsimile telephone number

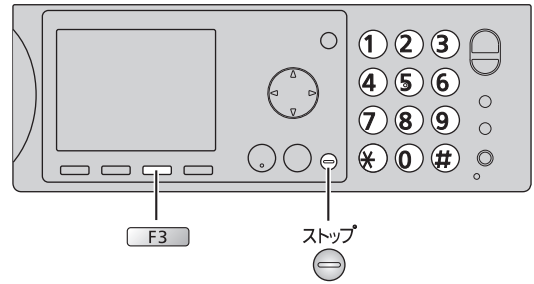

1 Press **機能** (Function).

最初の設定
 呼出音とベル回数
 音声の設定
 電話帳の設定

2 Press **# 0 0 4**.

あなたの電話番号?

3 Enter your facsimile telephone number, up to 20 digits.

Example: +098 7654.. あなたの電話番号?
 +098 7654..

- The *** (Tone)** button replaces the digit with “+”.
- The **#** button replaces the digit with a space.

4 Press **決定** (Set).

登録しました



あなたの電話番号?
 +098 7654..

5 Press **ストップ** (Stop).

Example : 用件 0件
 ファクス 0件

Setting your logo

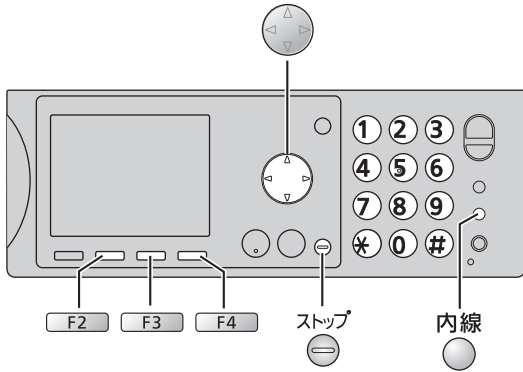

1 Press **機能** (F3) (Function).

最初の設定
呼出音とベル回数
音声の設定
電話帳の設定

2 Press **#** **0** **0** **2**.

名前 (印刷用)? [かな]
Cursor

3 Enter your logo, up to 30 characters, using the dial keypad.

- To enter English characters easily, press **文字切替** (F2) (Character input mode) repeatedly and select “英” (English and sign input mode).
- For details, see the table on page 9 for instructions.

Example: Micah

1. Press **6** once.

名前 (印刷用)? [英]
M
Cursor

2. Press **4** six times.

名前 (印刷用)? [英]
Mi

3. Press **2** six times.

名前 (印刷用)? [英]
Mic

4. Press **右** to move the cursor to the next space and press **2** four times.

名前 (印刷用)? [英]
Mica

5. Press **4** five times.

名前 (印刷用)? [英]
Micah

4 Press **決定** (F3) (Set).

登録しました



名前 (印刷用)? [英]
Micah
-

5 Press **ストップ** (Stop).

Example : 用件 0件
ファクス 0件

Character input and command key table

Pressing the dial keys will select a character as shown below.

Character		Hiragana	Katakana	English	Numbers
Display of the main unit and the portable handset		[かな]	[カナ]	[英]	[数]
Dial key					
(Main unit) ①	(Portable handset KX-FKN514) ①	あいうえお あいうえお	アイウエオ アイウエオ	@ . _ - & \$ ¥ % + = ~ ^	1
②	②	かきくけこ	カキクケコ	A B C a b c	2
③	③	さしすせそ	サシスセソ	D E F d e f	3
④	④	たちつてとっ	タチツテトツ	G H I g h i	4
⑤	⑤	なにぬねの	ナニヌネノ	J K L j k l	5
⑥	⑥	はひふへほ	ハヒフヘホ	M N O m n o	6
⑦	⑦	まみむめも	マミムメモ	P Q R S p q r s	7
⑧	⑧	やゆよやゆよ	ヤユヨヤユヨ	T U V t u v	8
⑨	⑨	らりるれろ	ラリルレロ	W X Y Z w x y z	9
⑩	⑩	わをんー! ? ()	ワヲンー! ? ()	! ? / - * # , ; : . ' " () [] { } < > 「 」	0
✳	✳	ゝ っ っ っ		、 。	
Command keys		文字切替 F2	(Main unit), F2 (Portable handset)	Used to change the character input mode.	
			(Main unit), (Portable handset)	Used to move the cursor to the left and right.	
		消去 F4	(Main unit), (Portable handset)	Used to delete a character.	
		内線 	(Main unit), (Portable handset)	Used to insert a space.	

- The characters on the display are somewhat different from those shown in the character input and command key table.

Voice guide

Operation guide

The unit starts the following voice guidance in Japanese:

Operations	To cancel the operation guide
Send a fax	機能 F3 → # 0 2 1 → (Select “なし”) → 決定 F3 → ストップ
Copy	
Add entries to the phonebook	
Store phonebook entries in the speed dialer	機能 F3 → # 1 6 7 → (Select “なし”) → 決定 F3 → ストップ
Make a call using the phonebook/redial/ speed dialer/call memory	
Change a ink film	機能 F3 → # 1 7 3 → (Select “なし”) → 決定 F3 → ストップ
Select fax documents from the main unit memory	機能 F3 → # 1 7 7 → (Select “なし”) → 決定 F3 → ストップ

Reading-out dial

The unit announces the number dialed in Japanese, when you make a call with the main unit.

• To cancel the reading-out dial

機能 F3 → # 1 3 0 → (Select “なし”) → 決定 F3 → ストップ

Automatic dialing on the main unit

Storing names and telephone numbers in the phonebook

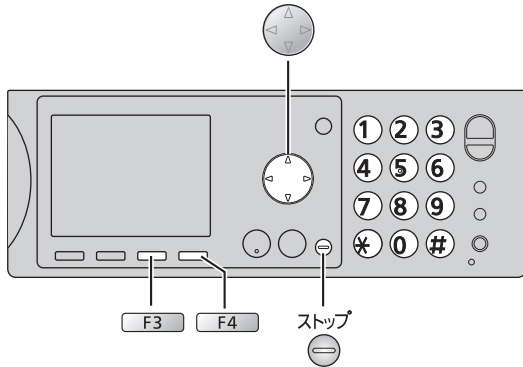

1 Press (Phonebook).

- “XXX” shows the remaining station numbers you can store.
- You can program up to 150 stations, including 4 pre-programmed stations.

電話帳空き XXX件
登録は[登録] 押す
検索は[▼,▲] 押す

2 Press (Register).

3 Enter the name, up to 20 characters (see the table on page 9 for instructions).

4 Press (Set) 2 times.

5 Enter the telephone number, up to 24 digits.
• To correct a mistake, press (Erase).

6 Press (Set).

7 Enter the group number (① to ⑨).

8 Press (Set).

- To program other items, repeat steps 3 to 8.

9 Press (Stop) to exit the program.

Making a voice call using the phonebook

1 Press (Phonebook).

2 Press (Search button) repeatedly until the desired name is displayed.

3 Lift the handset.

Editing a stored name or number in the phonebook

1 Press (Phonebook).

2 Press (Search button) repeatedly until the desired name is displayed.

3 Press (Edit).

4 Edit the name (see the table on page 9 for instructions).

- If you do not need to edit the name, skip to step 5.

5 Press (Set).

6 Edit the kana.

- If you do not need to edit the kana, skip to step 7.

7 Press (Set).

8 Edit the telephone number.

- If you do not need to edit the telephone number, skip to step 9.

9 Press (Set).

10 Edit the group number.

- If you do not need to edit the group number, skip to step 11.

11 Press (Set).

12 Press (Stop).

Automatic dialing on the main unit

Storing names and telephone numbers in the speed dialer

You can store up to 9 names and telephone numbers which are stored in the phonebook. The dialing buttons (① to ⑨) function as memory stations.

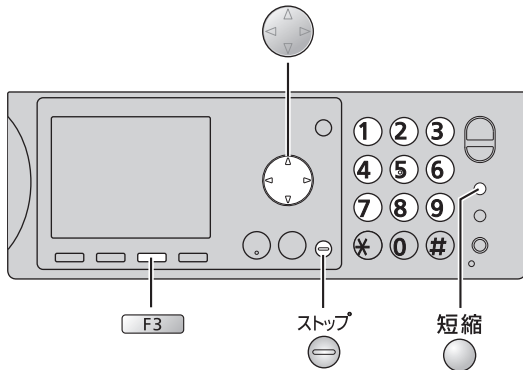

1 Press **短縮** (Speed dialer).

2 Press the memory station number (① to ⑨).

Example: speed dialer 1



Memory station number

3 Press **登録** (Register).

4 Press **検索** (Search button) repeatedly until the desired name is displayed.

5 Press **決定** (Set).

• To program other items, repeat steps 2 to 5.

6 Press **ストップ** (Stop) to exit the program.

Making a voice call using the speed dialer

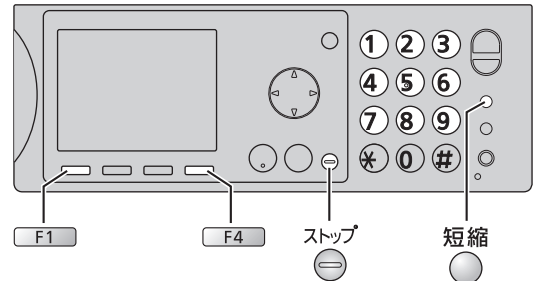

1 Press **短縮** (Speed dialer).

2 Press the memory station number (① to ⑨).

3 Lift the handset.

Erasing a stored name and number in the speed dialer

1 Press **短縮** (Speed dialer).

2 Press the memory station number (① to ⑨).

3 Press **消去** (Erase) and **はい** (Yes).

4 Press **ストップ** (Stop) to exit the program.

Automatic dialing on the portable handset (KX-FKN514)

Storing names and telephone numbers in the phonebook

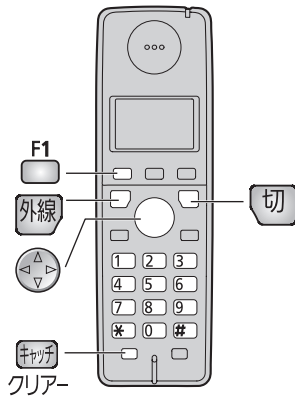

1 Press 電話帳 (Phonebook).

検索は
[▼,▲]を押す

2 Press .

- “XXX” shows the remaining station numbers you can store.
- You can program up to 150 stations, including 4 pre-programmed stations.

名前?
空き XXX件

3 Enter the name, up to 20 characters (see the table on page 9 for instructions).

4 Press 2 times.

5 Enter the telephone number, up to 24 digits.

- To correct a mistake, press (Flash/Clear).

6 Press .

7 Enter the group number (to .

8 Press .

- To program other items, repeat steps 3 to 8.

9 Press (Off) to exit the program.

Making a voice call using the phonebook

1 Press 電話帳 (Phonebook).

2 Press (Search button) repeatedly until the desired name is displayed.

3 Press (Talk).

Editing a stored name or number in the phonebook

1 Press 電話帳 (Phonebook).

2 Press (Search button) repeatedly until the desired name is displayed.

3 Press .

4 Edit the name (see the table on page 9 for instructions).

- If you do not need to edit the name, skip to step 5.

5 Press .

6 Edit the kana.

- If you do not need to edit the kana, skip to step 7.

7 Press .

8 Enter the correct telephone number.

- If you do not need to edit the telephone number, skip to step 9.

9 Press .

10 Edit the group number.

- If you do not need to edit the group number, skip to step 11.

11 Press .

12 Press (Off) to exit the program.

Intercom

An intercom is available between the portable handsets or between the main unit and portable handset(s).

Using the main unit:

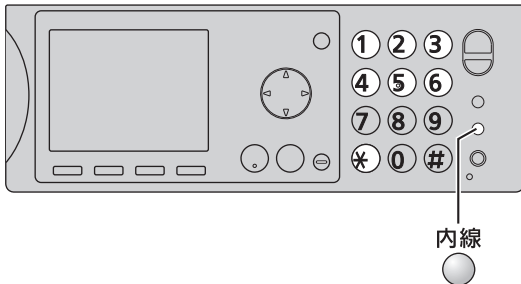

1 ■ For single portable handset users

- ① Lift the handset.

電話番号?

- ② Press  (Intercom).

子機1 呼出中

■ For multiple portable handset users

- ① Lift the handset.

- ② Press  (Intercom).

- ③ Call the portable handset(s) in the following ways:

- To call a specific portable handset, press the portable handset number (① to ⑥) which you want to call.
- To call all the portable handsets, press .

2 Start talking.

Example : 子機1 内線通話中

3 Replace the handset to end the intercom call.

Using the portable handset (KX-FKN514):

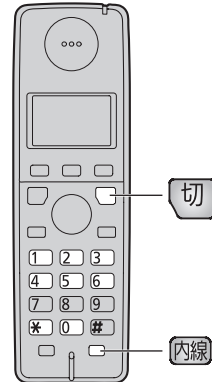



1 ■ For single portable handset users

Press  (Intercom).

■ For multiple portable handset users

- ① Press  (Intercom).

- ② Call the main unit and/or portable handset(s) in the following ways:

- To call a specific portable handset, press the portable handset number (① to ⑥) which you want to call.
- To call the main unit, press .
- To call the main unit and all the portable handsets, press .

2 Start talking.



内線通話中

3 Press (Off) to end the intercom call.

Sending faxes

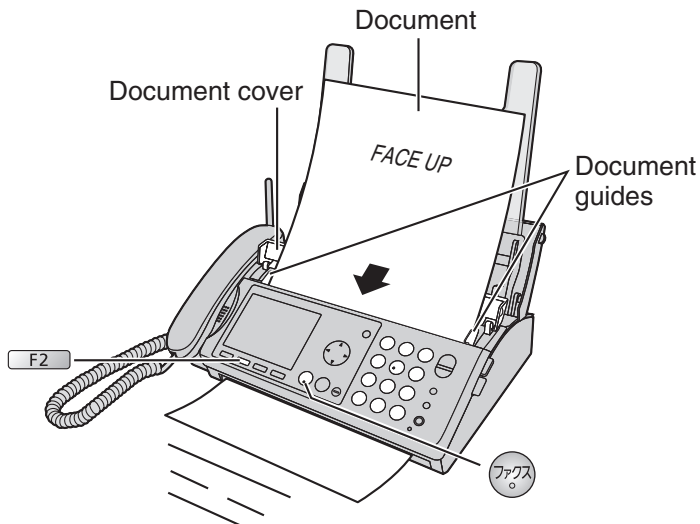
Sending a fax manually





- 1 Open the document cover, and adjust the width of the document guides to the size of the document.
- 2 Insert the document (up to 5 pages) FACE UP until a single beep is heard.
- 3 If necessary, press  (Resolution) repeatedly to select the desired setting (see below).
- 4 Press  (Fax).
- 5 Dial the fax number.
- 6 Press  (Fax).
 - The unit will start fax transmission.

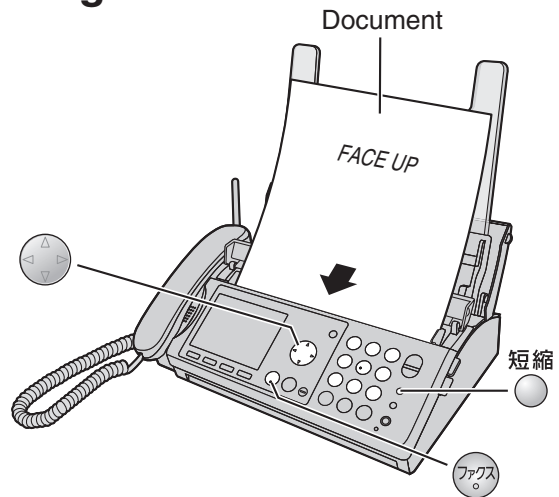

Sending a fax using automatic dialing



Using the phonebook

- 1 Insert the document (up to 5 pages) FACE UP until a single beep is heard.
- 2 Press  (Phonebook).
- 3 Press  (Search button) repeatedly until the desired name is displayed.
- 4 Press  (Fax).
 - The unit will start fax transmission.

Using the speed dialer

- 1 Insert the document (up to 5 pages) FACE UP until a single beep is heard.
- 2 Press  (Speed dialer).
- 3 Press the memory station number (① to ⑨).
- 4 Press  (Fax).
 - The unit will start fax transmission.

To select the resolution

Select the desired resolution according to the type of document, by pressing  (Resolution) repeatedly.

- | | |
|--------|---|
| 画質=ふつう | (Standard) for printed or typewritten originals with normal-sized characters. |
| 画質=小さい | (Fine) for originals with minute printing. |
| 画質=写真 | (Photo) for originals containing photographs. |

Receiving faxes

You can select beforehand whether to receive faxes by “Receive in memory” or “Receive on recording paper”.

Receive in memory: The received fax will be stored in memory. You can check the contents on the display, (Default setting) then print them if necessary.

Receive on recording paper: The received fax will be printed on recording paper.

■ Setting/canceling “Receive in memory”

Press  見から印刷切.

(Changes each time it is pressed.)



見から印刷 : Receive in memory

With no display: Receive on recording paper

Receiving a fax manually (AUTO ANSWER off)

Using the main unit:

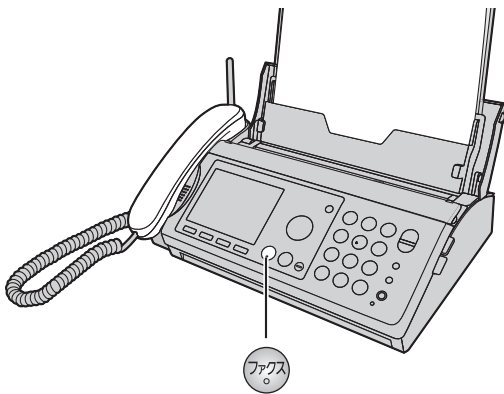

1 When you hear a ring, lift the handset to answer the call.

2 When:
 – document reception is required,
 – a fax calling tone (slow beep) is heard, or
 – no sound is heard,
 press  (Fax), then replace the handset.

- The unit will start fax reception.

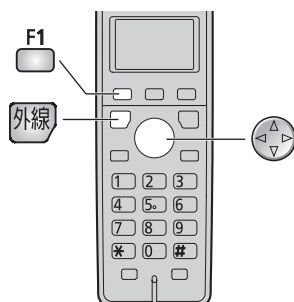

Using the portable handset (KX-FKN514):



1 When you hear a ring, lift the portable handset from the charger to answer the call.

- If the portable handset is not set on the charger, press  (Talk).

2 When:
 – document reception is required,
 – a fax calling tone (slow beep) is heard, or
 – no sound is heard,
 press .



3 Press  (Search button) repeatedly until the “ファクス受信” is displayed, then press .

4 Press .

- The main unit will start fax reception.

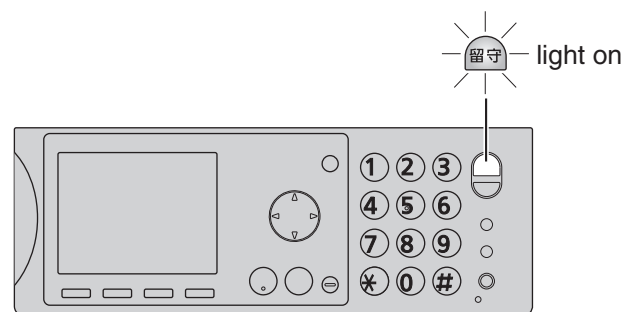
Receiving a fax automatically (AUTO ANSWER on)



1 If the  (Auto answer) light is off, turn it on by pressing .

2 When receiving a call, the unit will receive a fax document or record a voice message automatically depending on the caller's request.

Receiving faxes

Display when faxes are received in memory

When new faxes are received in memory, 着信・ファクス一覧 (Call/Fax list) will be on.

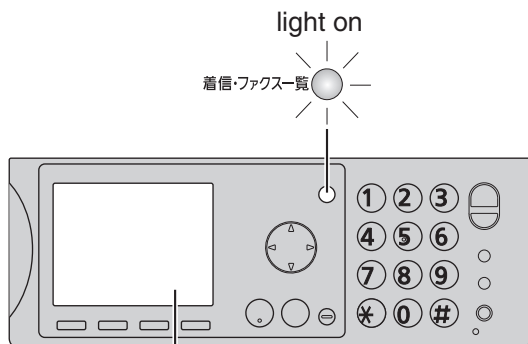

The number of faxes stored in memory is displayed.

Example :

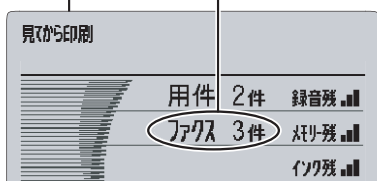

Viewing faxes stored in memory

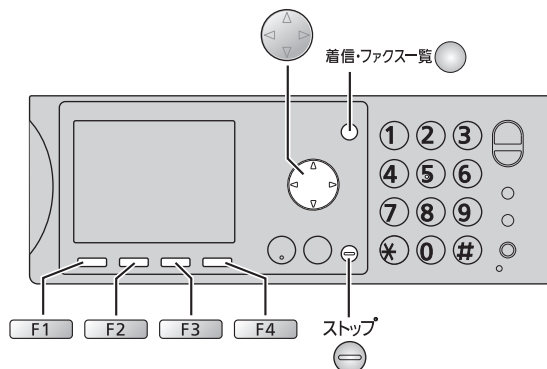

1 Press 着信・ファクス一覧 (Call/Fax list) and ファクス一覧 (Fax list).

2 Press (Search button) to select the desired fax to display.



3 Press 表示 (Display) to see the fax (see below for detail).
• To print the displayed page, press ページ印刷 (Print a Page).

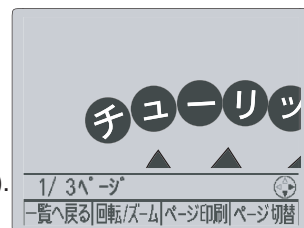

4 To view other faxes, press 一覧へ戻る (Return) and repeat steps 2-3. To exit the program, press ストップ (Stop).

Information about display

■ To scroll display contents

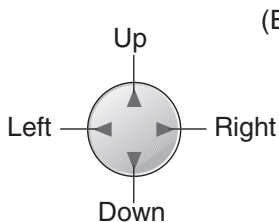

(Example)

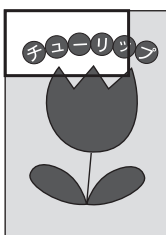

The display contents can be scrolled up, down, left and right.

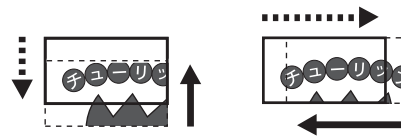

■ To enlarge or reduce content

Press 回転/ズーム (Turn/Zoom) (F2) (Zoom) to enlarge or reduce the display content in the following order:
Normal → Enlarge(double size) → Reduce(half size) → Normal...

■ Scroll pages

To show the next page: Press ページ切替 (Scroll page) (F4) (Next page).

To show the previous page: Press ページ切替 (Scroll page) (F4) (Previous page).

■ To turn display contents

Press 回転/ズーム (Turn/Zoom) (F2) (Turn).

(Example)

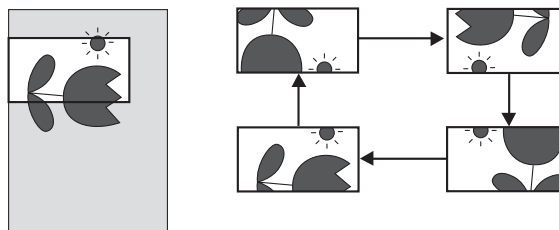

Receiving faxes

Printing a specific fax stored in memory

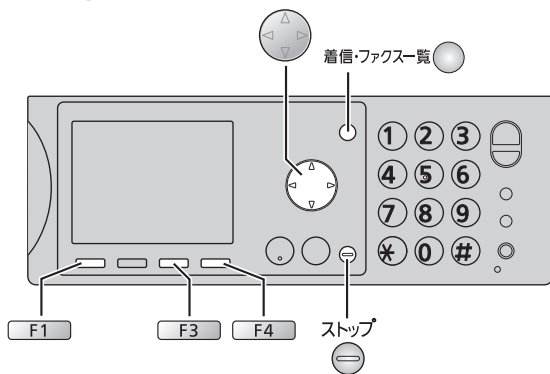

1 Press **着信・ファクス一覧** (Call/Fax list) and **ファクス一覧** (Fax list).

2 Press **検索** (Search button) to select the desired fax to print, then press **印刷** (Print).

3 After printing, the following is displayed.

Do you delete the printed contents? 印刷した内容を消去しますか?

• If you want to delete the fax, press **はい** (Yes).

消去しました

• If you want to hold the fax, press **いいえ** (No).

4 Press **ストップ** (Stop).

Deleting a specific fax stored in memory

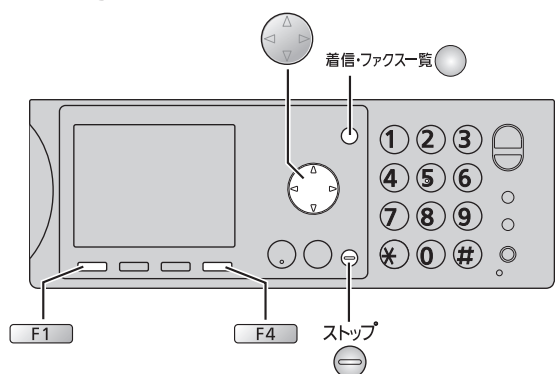

1 Press **着信・ファクス一覧** (Call/Fax list) and **ファクス一覧** (Fax list).

(未読) 1 / 3件
 10月 1日(月) 12:34 5枚
 松下太郎
 0987654321

2 Press **検索** (Search button) to select the desired fax to delete.

3 Press **消去** (Delete).

消去しますか?

Do you delete the fax ?

or 消去しますか?
未読の内容があります

Do you delete the new fax ?

4 If you want to delete the fax, press **はい** (Yes).

消去しました

• If you want to hold the fax, press **いいえ** (No).

5 If you want to delete other faxes, repeat steps 2–4.

6 Press **ストップ** (Stop).

Operating the built-in answering device

Recording your own greeting message

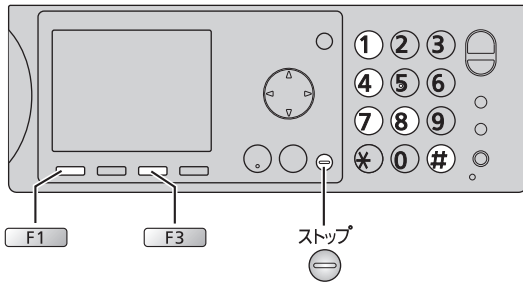

You can record your own greeting message. When receiving a call, it will be played to callers instead of the pre-recorded Japanese greeting message.

1 Press **機能** (Function) **F3**.

2 Press **#** **1** **4** **7**.

自作応答録音

3 Press **決定** (Set) **F3**.

4 Lift the handset.

5 Press **決定** (Set) **F3** and speak your greeting message after a beep, up to 16 seconds, to the handset.

6 Press **終了** (End) **F3** or **ストップ** (Stop) and replace the handset.

- Your greeting message will be played back automatically.

Erasing your own greeting message

1 Press **機能** (Function) **F3**.

2 Press **#** **1** **4** **8**.

自作応答消去

3 Press **決定** (Set) **F3**.

4 Press **はい** (Yes) **F1**.

- The pre-recorded Japanese greeting message will be played when you receive a call.

Activating the answering device

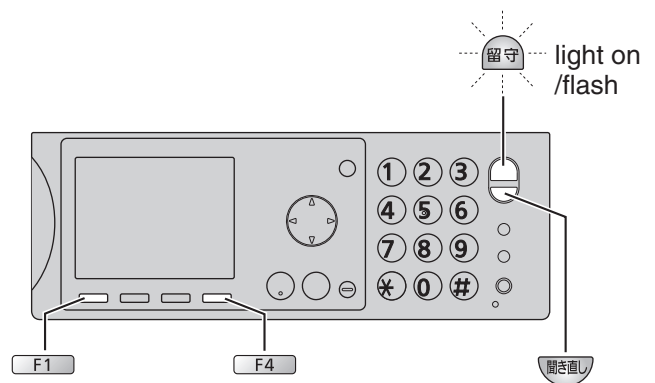

1 Turn the **留守** (Auto answer) light on by pressing **留守**.

2 When receiving a call, a greeting message will be played and the unit will record a voice message.
• To record your own greeting message, see left.

Listening to recorded messages

When new messages are recorded, the **留守** (Auto answer) light will flash.

Press **留守** to listen to recorded messages.

After the messages are played back, the following will be displayed.

- To erase the messages, press **はい** **F1**.
- To save the messages, press **いいえ** **F4**.

再生した用件を
消去しますか?

Listening to all of the recorded messages

Press **聞き直し** (Replay).

After the messages are played back, the following will be displayed.

すべて消去しますか?

- To erase the messages, press **はい** (Yes) **F1**.
- To save the messages, press **いいえ** (No) **F4**.

Erasing a specific message

Press **用件消去** (Erase) **F4** while listening to the message you want to erase, then press **はい** (Yes) **F1**.

Erasing all of the recorded messages

1 Press **用件消去** (Erase) **F4**.

すべて消去しますか?

2 Press **はい** (Yes) **F1**.

Operating the built-in answering device

Operating the answering device from a remote location

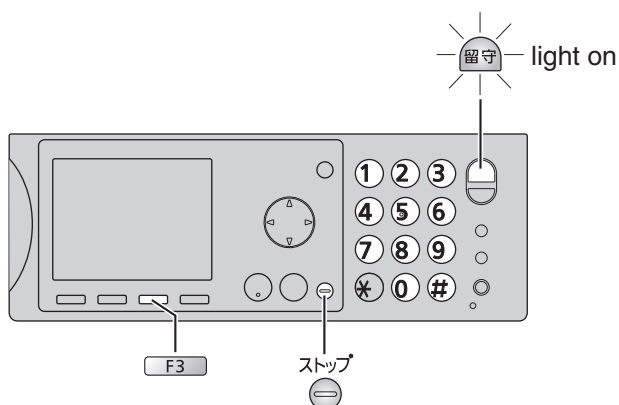

Preparation: Programming the remote operation ID

1. Press ^{機能} **F3** (Function).
2. Press **# 0 0 6**.
3. Enter any 4-digit number (remote operation ID) except * or #.

Example :

留守電暗証番号 ?
1234

4. Press ^{決定} **F3** (Set).
5. Press ^{ストップ} **⊖** (Stop).

Operation: Listening to a recorded message from a remote location

Turn the **留守** (Auto answer) light on before you go out. Remote operations are available only from a touch tone telephone.

1. Call your unit.
2. Enter the remote operation ID during the greeting message.
3. Press **2** or wait 4 seconds.
 - Only the new recorded messages will be played back.
 - To listen to all the recorded messages, press **4** after the new messages have been played back.

Night mode

Turn on the night mode

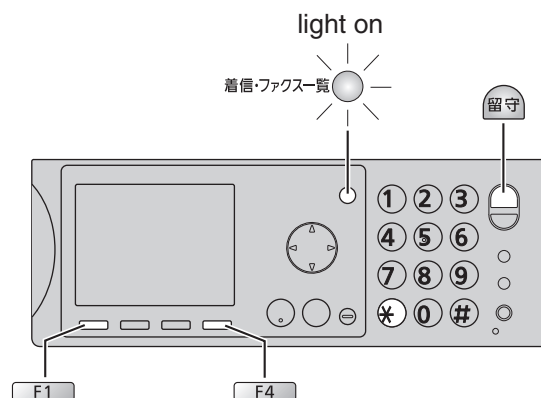

Press *** (Night mode)** for about 3 seconds.

- “**おやすみ**” is displayed and **留守** lights on.
- When a call is received during night mode, the unit will handle the call silently, either by storing the received fax into memory or by recording the caller's message.
- Night mode allows you to select a block of time during which the unit will not ring for outside calls or make sounds when you change the settings. This feature is useful when you do not want to be disturbed, for example, while sleeping.

Listening to recorded messages

When new messages are recorded, the **留守** (Auto answer) light will flash.

Press **留守** to listen to recorded messages.

After the messages are played back, the following will be displayed.

再生した用件を
消去しますか?

- To erase the messages, press ^{はい} **F1** (Yes).
- To save the messages, press ^{いいえ} **F4** (No).

Printing received fax documents

When new faxes are received, the **着信・ファクス一覧** light will turn on.

To print the faxes, see "Printing a specific fax stored in memory" on page 18.

Turn off the night mode

Press *** (Night mode)** for about 3 seconds.

Call block

Blocking the incoming calls

Using the main unit:

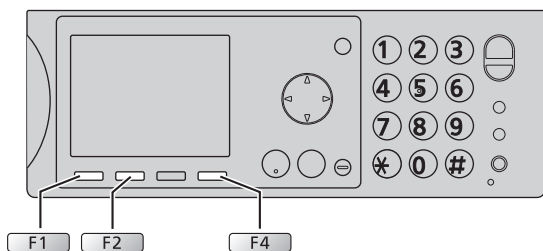

To block a call using a message

While the unit is ringing, press **通話拒否** (Block).

OR

While you are on an incoming call, press **通話拒否** (Block), then press **音声** (Voice).

- The unit announces a message to the caller 2 times, then hangs up automatically. The message is announced in Japanese and means “We’re sorry, but your call cannot be connected.”

To block a call using chimes

1 While you are on an incoming call, press **通話拒否** (Block).

2 Press **チャイム** (Chime).

- Chimes are heard by the caller.

3 Explain to the caller that a visitor came and hang up.

For Number Display service subscribers

If you subscribe to Number Display service, the message heard by the caller will change according to the caller’s situation.

Example :

If the caller requested not to send caller’s information, the message heard by the caller will change to mean
“Your phone number is blocked by service provider.
Please call again with adding ‘186’ to the beginning of the phone number.”

When the following is displayed after pressing **通話拒否** (Block), you can set the unit to block the call from the same telephone number.

■ To block the call, press **はい** (Yes). **迷惑設定しますか?**

■ To cancel blocking, press **いいえ** (No).

• When the following is displayed, press **いいえ** (No) to cancel.

拒否設定しますか?

Using the portable handset (KX-FKN514):

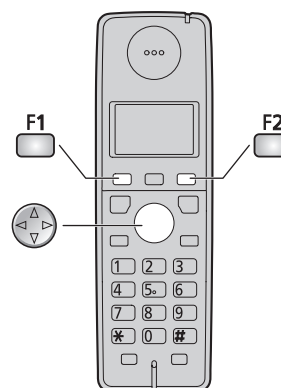

1 Press **F1** while the unit is ringing or while you are on an incoming call.

2 Press **Search button** repeatedly until the “**通話拒否**” is displayed.

3 Press **F1** 2 times.

- The unit announces a message to the caller 2 times, then hangs up automatically. The message is announced in Japanese and means “We’re sorry, but your call cannot be connected.”

For Number Display service subscribers

If you subscribe to Number Display service, the message heard by the caller will change according to the caller’s situation.

Example :

If the caller requested not to send caller’s information, the message heard by the caller will change to mean
“Your phone number is blocked by service provider.
Please call again with adding ‘186’ to the beginning of the phone number.”

When the following is displayed after operating step 1 to 3, you can set the unit to block the call from the same telephone number.

■ To block the call, press **F1**.

■ To cancel blocking, press **F2**.

**迷惑設定
しますか?**

• When the following is displayed, press **F2** to cancel.

**拒否設定
しますか?**

Specifications

KX-PW606DL KX-PW606DW KX-PW616DL KX-PW616D	Main unit	Portable handset (KX-FKN514)	Battery charger
Power supply	AC 100 V (50 Hz/60 Hz)	Ni-MH battery (Part no. KX-FAN52) DC 2.4 V, 830 mAh	AC adaptor (Part no. PFAP1009) AC 100 V (50 Hz/60 Hz) DC 7.5 V, 100 mA
Power consumption	Transmission: Approx. 10 W Reception: Approx. 15 W Copy: Approx. 18 W Stand by: Approx. 1.3 W (When the F-net service is not in use.) Maximum(*1): Approx. 130 W	/	<ul style="list-style-type: none"> • Charging: Approx. 1.8 W • Stand by: Approx. 0.5 W
Dimensions (H x W x D)	Approx. 86 X 296 X 191 mm (without handset, projections) Approx. 265 X 296 X 231 mm (recording paper tray opened, without handset, projections)	Approx. 155 X 48 X 34 mm	Approx. 58 X 87 X 95 mm
Mass (Weight)	Approx. 2.4 kg (10 m ink film installed)	Approx. 146 g (battery installed)	Approx. 90 g
Operating environment	5 °C – 35 °C, 45 % – 85 % RH (Relative Humidity)		

KX-PW606DL KX-PW606DW KX-PW616DL KX-PW616D	Main unit
Applicable line	Public Switch Telephone Network (Tone/Pulse), F-Net, NCC Lines
DC resistance	275 Ω
Compatibility	G3 compatible
Document size	A4–A5 (Max. 210 mm in width, Max. 600 mm in length)
Effective scanning size	208 mm (A4)
Effective printing size	202 mm (A4 size plain paper)
Transmission time	Approx. 15 s/page (Original mode) (*2)
Modem speed	9,600 / 7,200 / 4,800 / 2,400 bps; Automatic fallback
Halftone level	64-level
Scanning density	Horizontal: 8 pels/mm Vertical : 7.7 lines/mm (Fine/Photo), 3.85 lines/mm (Standard)
Scanner type	Contact image sensor
Printer type	Thermal transfer printing on plain paper
Data compression system	Modified Huffman (MH), Original mode
Recording paper size	A4: 210 mm x 297 mm (Plain paper)
Answering device	Greeting message: Digital recording system (up to 16 sec) Pre-recording greeting message ICM Recording: Digital recording system (Approx. 12 min. in total) (*3)
Memory capacity	Max. Approx. 50 pages (Only receiving fax etc.) (*4) Max. Approx. 12 min. (Only recording message) (*3)

*1 When copying a 100 % black document.

*2 Transmission speed is based on an A4-size document of 700 characters sent in standard resolution at 9,600 bps. The actual transmission speed depends upon the contents of the page, resolution, telephone line conditions and capability of the other party's machine.

*3 If there is a silent pause, the total recording time will be longer.

*4 The memory capacity is based on an A4-size document of 700 characters.

Free Manuals Download Website

<http://myh66.com>

<http://usermanuals.us>

<http://www.somanuals.com>

<http://www.4manuals.cc>

<http://www.manual-lib.com>

<http://www.404manual.com>

<http://www.luxmanual.com>

<http://aubethermostatmanual.com>

Golf course search by state

<http://golfingnear.com>

Email search by domain

<http://emailbydomain.com>

Auto manuals search

<http://auto.somanuals.com>

TV manuals search

<http://tv.somanuals.com>