

Panasonic

Integrated Telephone System
with Single Micro Cassette

EASA-PHONE

MODEL NO. **KX-T2396BA**

OPERATING INSTRUCTIONS



Please read before use.

AUTO-LOGIC

Matsushita Electric Industrial Co., Ltd.
Central P. O. Box 288, Osaka 530-91, Japan

Printed in Japan

PQQX6594ZA F0492Q0 (XNZ)

Download from www.Somanuals.com. All Manuals Search And Download.

Table of contents

Table of contents	1-2
Location of controls	3-6
Enclosures	7
Inserting the tape	8
Connection	9-10
Initial preparation	11-15
Selector settings	11-12
Recording an Outgoing Message (OGM)	13-14
Checking your recorded OGM	15
Using your answering machine	15

TELEPHONE

Making and answering calls	17-18
Making calls with the handset	17
Making calls with the MONITOR button (on-hook dialling)	17
Redialling	18
Answering calls	18
Automatic Dialling	19-20
Making calls using the upper memory location	19
Making calls using the lower memory location	20
Storing the telephone numbers	21-24
Storing into the upper memory location	22
Storing into the lower memory location	23
Correcting an error while storing	24
Confirming a stored number	24
Erasing a stored number	24

WARNING:

TO PREVENT FIRE OR SHOCK HAZARD, DO NOT EXPOSE THIS PRODUCT TO RAIN OR ANY TYPE OF MOISTURE.

When a failure occurs which results in the internal parts becoming accessible, disconnect the AC adaptor immediately and return this unit to authorized service center.

If there is any trouble, disconnect the unit from the telephone line and connect a known working phone. If the known working phone operates properly, do not reconnect the unit to the telephone line until the trouble has been repaired. If the known working phone does not operate properly, consult with a telephone company.

Other operation	25-27
Recall	25
Setting the Timed Recall (Flash)	26
Hold	27
Pause	27
Combination dialling	27

ANSWERING MACHINE

Setting up for answering machine	29-30
Recording from the beginning of the ICM part of the tape	30
Recording after the messages you have heard	30
Listening to the recorded messages	31-32
Playing back the tape from the beginning	32
Remote operation	33-35
Remote code number	33
Playing back all the messages	34
Resetting the tape for future message	35
Recording a marker message	35
Setting the answer mode remotely	35
Recording a memo message	36
Recording a conversation (2-way recording)	37
Monitoring the incoming calls	38
Troubleshooting guide	39-40
Wall mounting	41
Maintenance	42-43
Safety instructions	44

QUICK REFERENCE CARD for tone remote control can be found on this page.

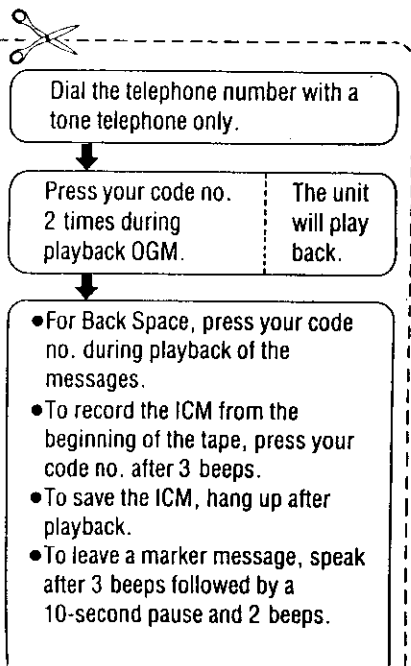

Location of controls

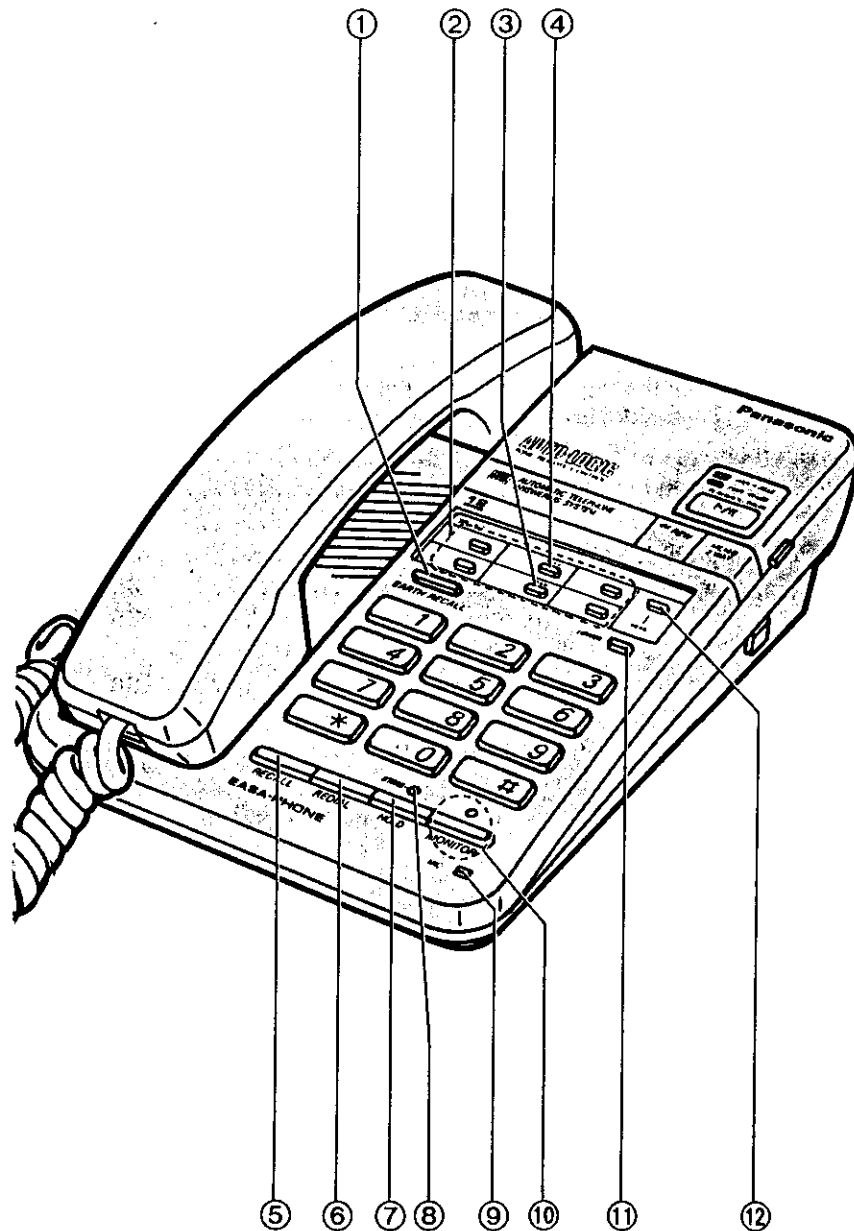

Safety instructions

Take special care to follow the safety suggestions listed below.

Safety

- 1) Power Source: The unit should be connected to a power supply only of the type described in the operating instructions or as marked on the unit.
- 2) Nonuse Periods: When the unit is not used, turn the power off. When left unused for a long period of time, the unit should be unplugged from the household AC outlet.

Installations

Environment

- 1) Water and Moisture: Do not use this unit near water—for example, near a bath tub, washbowl, sink, etc. Damp basements should also be avoided.
- 2) Heat: The unit should be situated away from heat sources such as radiators, kitchen range, etc. It also should not be placed in rooms where the temperature less than 5°C (41°F) or greater than 40°C (104°F)

Placement

- 1) Stacking: Do not place heavy objects on top of this unit.
- 2) Foreign Material: Care should be taken so that objects do not fall into and liquids are not spilled into the unit. Do not subject this unit to excessive smoke, dust, mechanical vibration, or shock.
- 3) Surface: Place the unit on a flat, level surface.
- 4) Magnetism: The unit should be situated away from equipment or devices that generate a strong magnetic field.



KX-T2396BA QUICK REFERENCE CARD FOR TONE REMOTE CONTROL

To set the answer mode remotely.

1. Dial the phone number and wait for 15 rings.
 - The unit will answer and play the OGM.
2. Hang up the handset.
 - The unit will be ready to answer the next phone call.

When you press any button, press firmly for 1–2 seconds.

Your remote code no. _____

Cassette tape

- For optimum sound quality and performance, we recommend that you **use the opposite side (side-2) after six months and replace the tape with a new one every year**, assuming that the unit answers about ten calls a day.
- Never place a cassette tape near a magnetic source, such as a magnet or a TV set, because it may erase or break the recorded message on the tape.
- Slack in the tape can be tightened by rotating the tape reel with an instrument like a pencil, as shown.

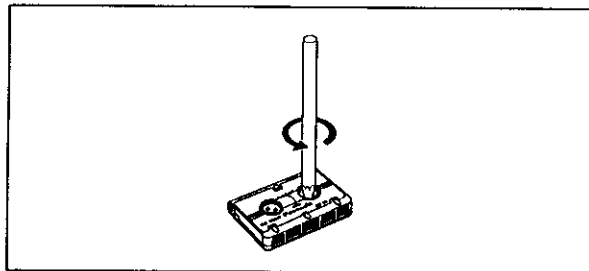

Cassette panel installation

If the panel comes off, replace it by pushing as shown.

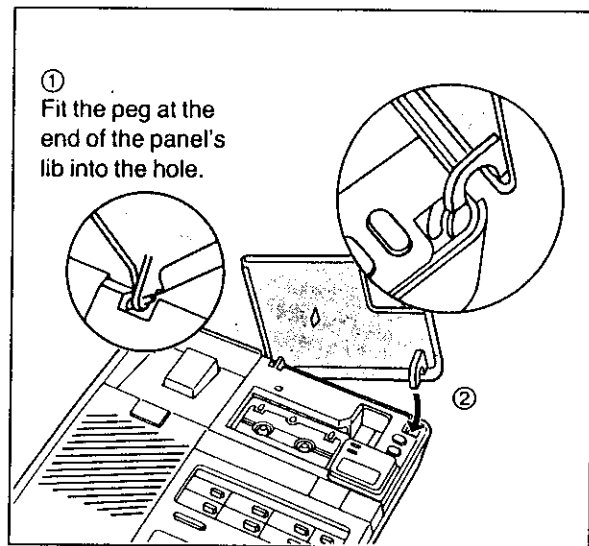

- ① Fit the peg at the end of the panel's lip into the hole.

- ① EARTH RECALL Button (page 25):
Used to access some feature of your host PBX which has earth recall facility.
- ② Direct Call Buttons (page 19):
Used to store phone numbers and to make calls using one touch dialling.
- ③ CLEAR Button (page 24):
Used to clear the memory while storing telephone number.
- ④ PAUSE Button (page 27):
Used to enter a pause in phone numbers when programming.
- ⑤ RECALL (Timed Break Recall) Button (page 25):
Used to access some of the feature of your host PBX which has timed break register recall facility.
- ⑥ REDIAL Button (page 18):
Used to redial the last dialled phone number.
- ⑦ HOLD Button (page 27):
Used to put the calling party on hold during a conversation. It serves as a store button when programming phone numbers.
- ⑧ STORE (HOLD) Indicator (page 22):
It lights or flashes when programming. It also flashes when holding a call.
- ⑨ MIC (Microphone) (page 14)
- ⑩ MONITOR Button and Indicator (page 17):
Used to dial a phone number or monitor the caller's voice while having conversation without using the handset.
- ⑪ LOWER Button (page 20):
Used to select the lower memory location.
- ⑫ PROG (Program) Button (page 22):
Used to start and complete the programming procedure.

Maintenance

Because the head and capstan assemblies are in contact with the tape, dirt and residue from the tape can easily adhere to these parts, causing distortion. These parts should be cleaned periodically in the manner described below.

Clean the head surface, pinch roller and capstan with a cotton swab. If these surfaces are extremely dirty, dampen the cotton swab with alcohol.

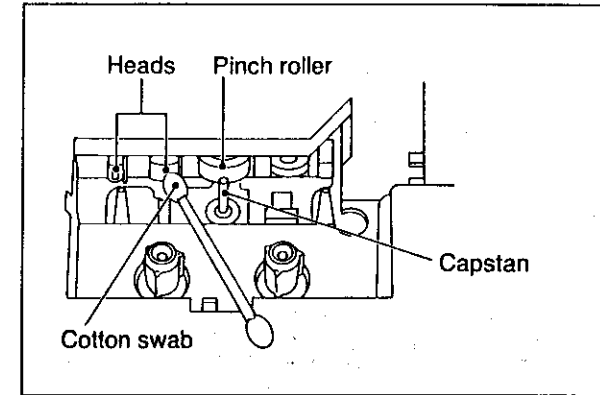
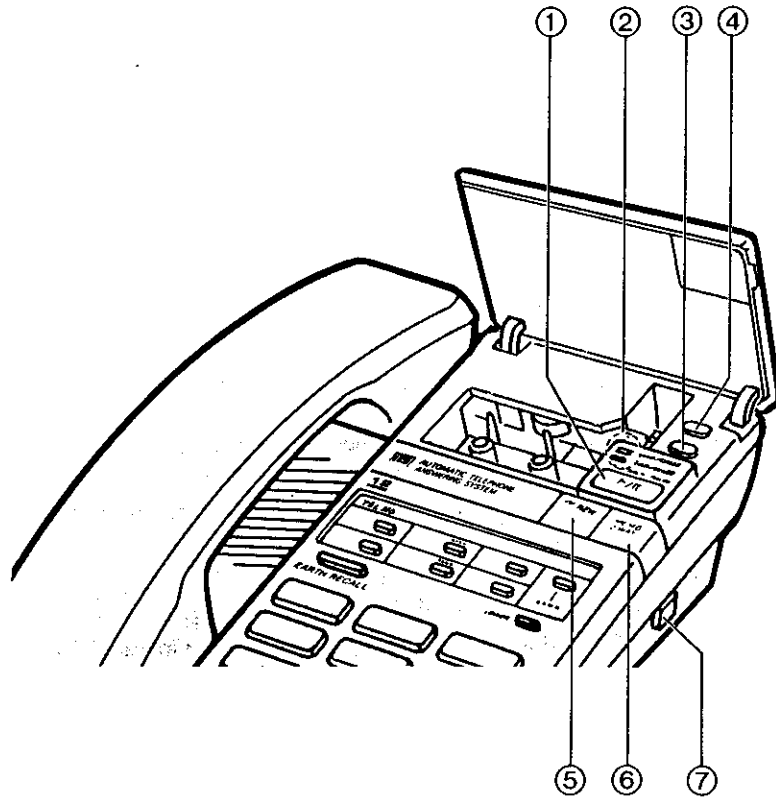

- Do not place magnetic or metal objects, such as a screwdriver, near the head assemblies, as such objects could magnetize the heads.
- Do not oil any part of the unit.

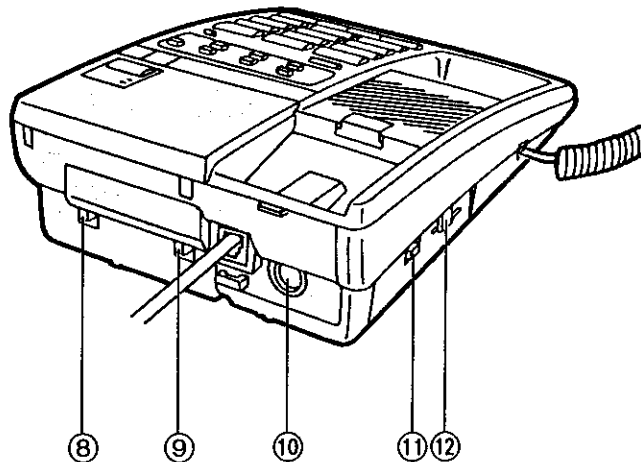

Wall mounting

The unit can be mounted on a wall utilizing the washers and screws provided.

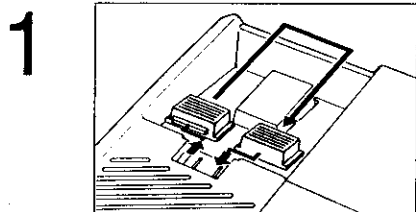

1 Turn around the handset hook.

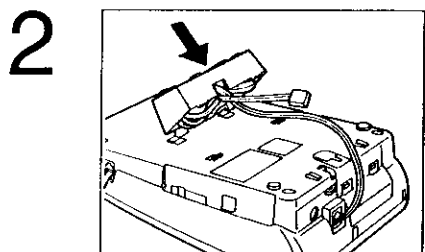

2 Place the wall mount adaptor as shown.

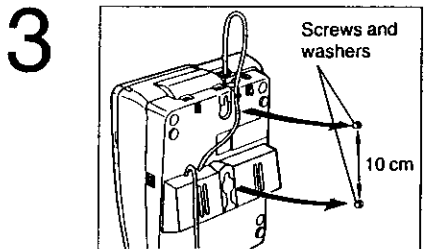

3 Install the screws and washers using the wall template indicated below, then mount the unit eyelets as shown.

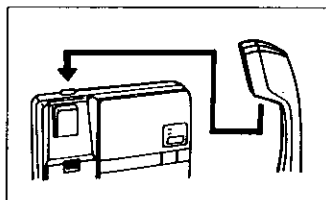

To temporarily place the handset down during a conversation, hook as shown.

Wall Template

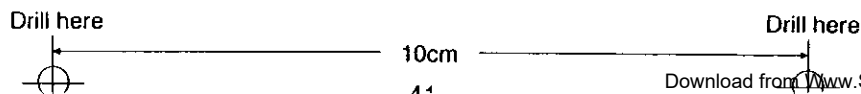

① **PLAYBACK/PAUSE Button** (page 30):
Used to play back the recorded Incoming Messages and to stop the ICM tape temporarily during ICM playback.

② **PWR/IN USE (Power/In use) Indicator** (page 14):
It lights when the unit is powered on, and it flashes while recording message.

ANS/CALLS (Answer/Calls) Indicator (page 29):
It lights when the unit is ready to answer the calls, and it flashes with indicating the number of recorded messages after the message was recorded.

③ **OGM PLAY Button** (page 15):
Used to play the recorded Outgoing Message.

④ **OGM REC (Record) Button** (page 14):
Used to record the Outgoing Message.

⑤ **REW (Rewind) Button** (page 30):
Used to rewind the cassette tape.

⑥ **MEMO/2 WAY Button** (page 36):
Used to record a memo message or a telephone conversation.

⑦ **ANS SYS (Answer System) ON/OFF Switch** (page 12):
Used to turn on and off the unit. The PWR/IN USE indicator light when the unit is turned on.

⑧ **RINGS (Ring times) Selector** (page 12):
Used to select the number of rings that it takes for the unit to answer.

⑨ **VOX SENS (Sensitivity) Selector** (page 12)

⑩ **DC IN Jack** (page 9)

⑪ **RINGER (Ringer volume) Selector** (page 12):
Used to select the ringer volume HIGH, LOW or OFF.

⑫ **VOLUME Control** (page 38):
Used to adjust the sound level for the built-in-speaker.

Enclosures

AC adaptor one
KX-A11BA
(page 10)

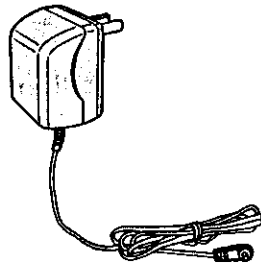

Screw two
Washer two
(page 41)

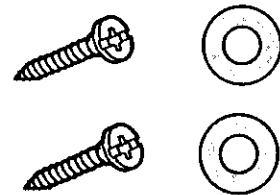

Microcassette tape one
(page 8)

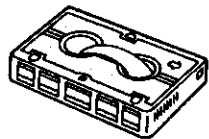

Telephone line cord one
(page 9)

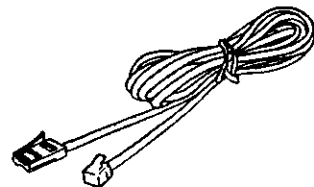

Handset one
(page 10)

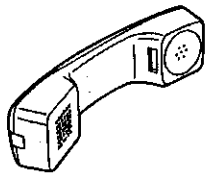

Handset cord one
(page 9)

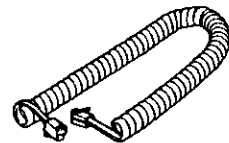

Wall mounting adaptor one
(page 41)

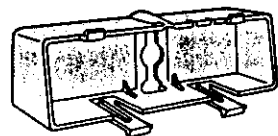

Problems

Cause & Remedy

When the cassette tape is played back, the sound level is low, even if the VOLUME control is turned up fully.

- Clean the heads. (See page 42.)

I want to record the next Incoming Messages after the last previously recorded messages that I have heard.

- Save the old messages. (See "Recording after the messages you have heard" on page 30.)
- In case of remote operation, just hang up.

The unit does not answer remotely.

- If you can hear ring-tone but the unit fails to answer, this is because the power of the unit is turned off. (The unit is not in the answer mode.) Set the unit to the answer mode by call your telephone number and ring for 15 times. (See page 35.)

I try to operate from a remote touch tone phone, but the unit does not respond when I press any button.

- Make sure that you are entering your correct remote code number.
- When you press a button, press firmly for 1–2 seconds.
- In some areas, a remote touch tone phone may not function due to telephone line conditions such as line noise, echo, etc.
- The unit may not respond if a remote touch tone phone (such as mobile telephone, etc.) produces tones that are too short to activate the unit. Please change the telephone.

The ICM tape continues to run after a caller hangs up.

- Set the VOX SENS selector to the "L" position.

Troubleshooting guide

Problem	Cause & Remedy
The unit does not work when I press any buttons.	<ul style="list-style-type: none">● Plug in the AC adaptor again.● The unit is turned off. Press the ANS SYS ON/OFF switch to turn on the unit.
The unit does not ring.	<ul style="list-style-type: none">● The RINGER selector is set to the "OFF" position. Set it to the "HIGH" or "LOW" position.
I try to store the telephone number into memory station, but the storing procedure cannot be done.	<ul style="list-style-type: none">● Be sure that the AC adaptor is connected and handset is on the cradle.
The Outgoing Message is recorded improperly.	<ul style="list-style-type: none">● Record a new Outgoing Message.● Clean the heads. (See page 42.)
When I press the OGM REC button to record my Outgoing Message, the unit does not start recording, and a beep sounds 6 times and the ANS/CALLS indicator flashes.	<ul style="list-style-type: none">● The cassette tape might be broken. Replace it with a new one.
When I record an Outgoing Message, a beep sounds 6 times and the unit stops recording.	<ul style="list-style-type: none">● Re-record your Outgoing Message. Speak clearly and loudly, and do not pause for over 2 seconds while recording.

Inserting the tape

Cassette tape compartment is covered.

1



Open the cassette panel.

2

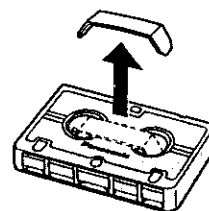

Remove the stopper of the cassette tape.

3

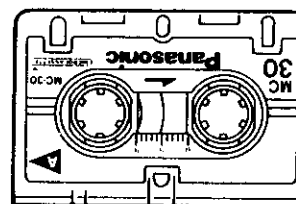

Insert the cassette tape.

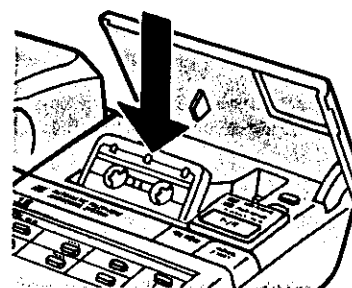

Connection

This unit is designed to be connected as shown.

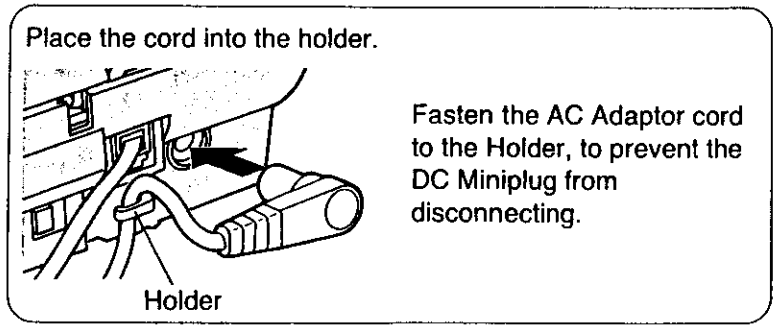
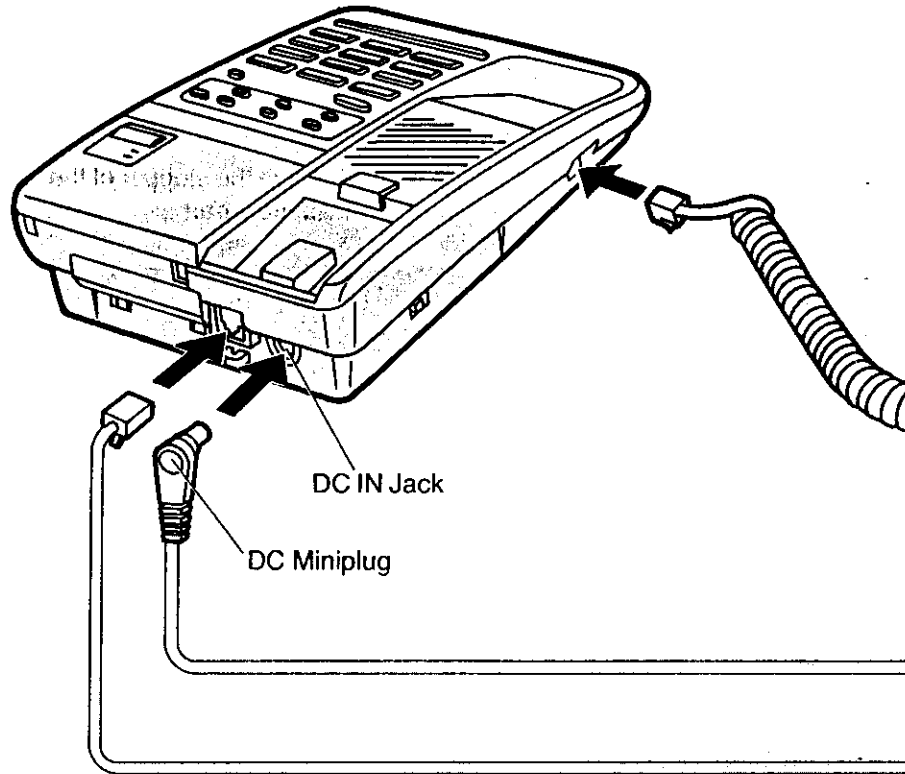

Monitoring the incoming calls

You may leave the unit in answer mode even when you are around. In this case, after the unit has answered, you will monitor the caller speaking. You can interrupt the recording and speak to the caller by simply lifting the handset. The unit will automatically stop recording. After hanging up, the unit will be ready to answer the next phone call.

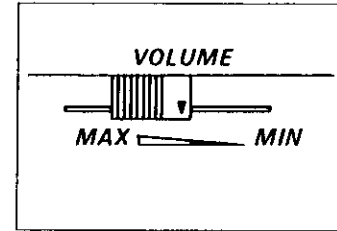

Adjust the VOLUME control if needed.

Recording a conversation (2-way recording)

You can record a telephone conversation.

1

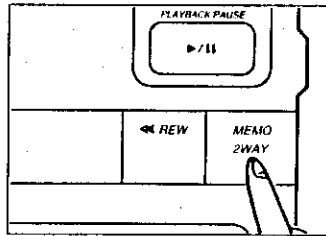

Press the MEMO/2WAY button until a beep sounds during your conversation, and continue speaking.

The PWR/IN USE indicator flashes and the ANS/CALLS indicator lights is on. A beep will be heard every 15 seconds.

2

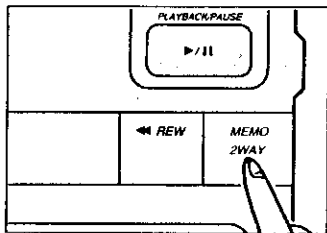

Press the MEMO/2WAY button again when you finish recording.

The PWR/IN USE indicator light is on and the ANS/CALLS indicator goes out. The unit rewinds and resets the tape, and be ready to answer the next phone call. The ANS/CALLS indicator flashes to show that the conversation was recorded.

- The recorded conversation can be played back either manually or remotely just like any other recorded Incoming Messages.

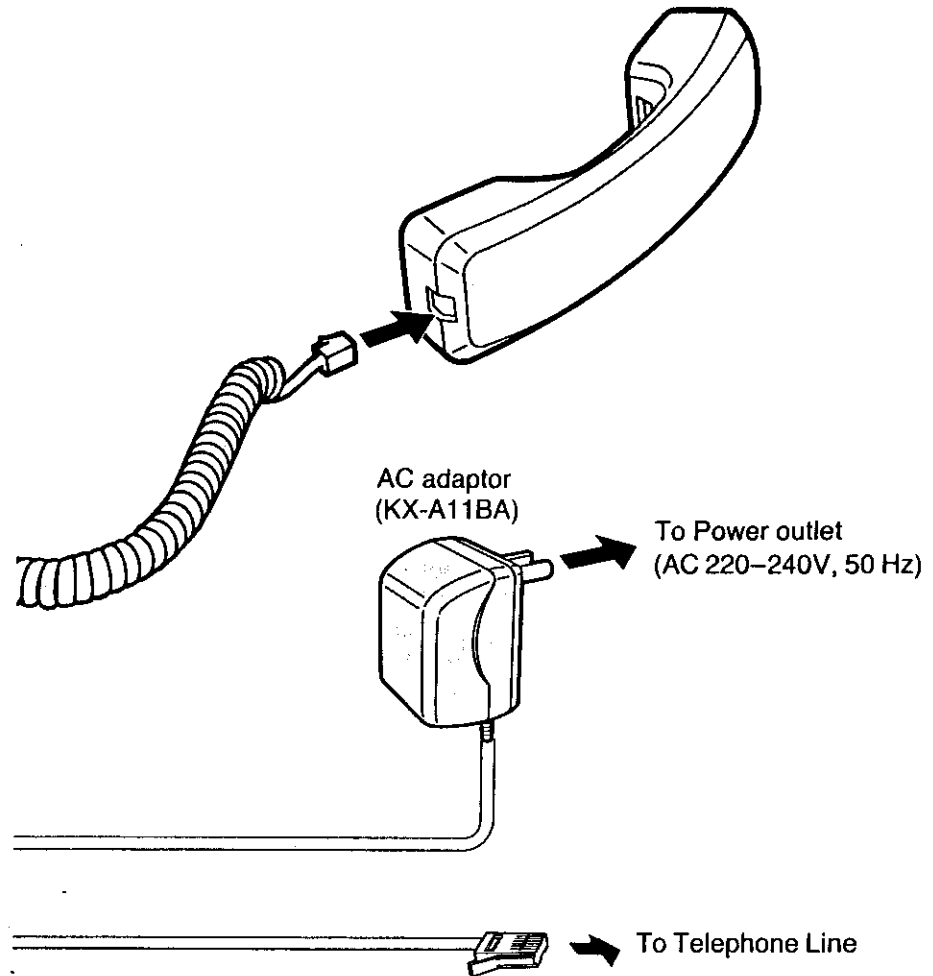

- Be sure to insert the tape before connecting the AC adaptor.
- If a power failure takes place, the unit can be used as a typical telephone.
- Be sure to use the included AC adaptor Panasonic Model KX-A11BA.
- While you are operating the unit, the case of the AC adaptor may feel warm. This is a normal condition.

Initial preparation

Selector settings

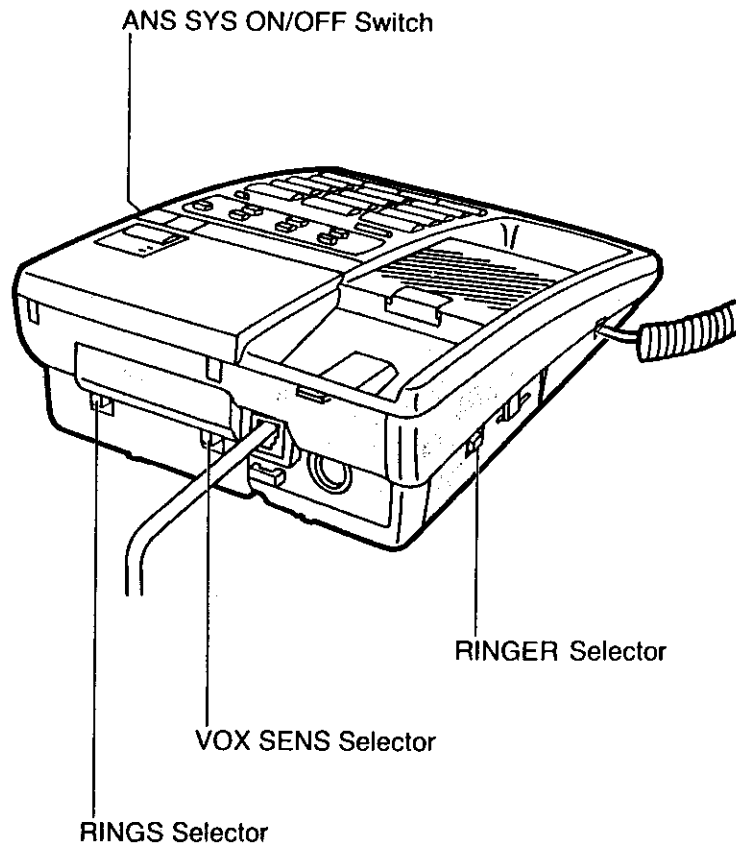

Function of the AUTO setting (TOLL SAVER)

When you call the unit from an outside phone, the number of rings that it takes for the unit to answer tells you if there are any new messages.

If the unit answers on the 2nd ring: There is at least one new message.

If the unit answers on the 4th ring: There are no new messages.

Hang up immediately when you hear the 3rd ring. Because the 3rd ring indicates there are no new messages. This will save you the toll charge for the call.

Recording a memo message

If you want to leave a memo message for someone, you can record it on the tape. It can then be played back either manually or remotely just like any other recorded Incoming Messages.



1

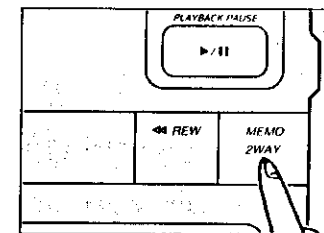

Press the MEMO/2WAY button until a beep sounds.

A series of short beeps will be heard followed by a long beep.

2

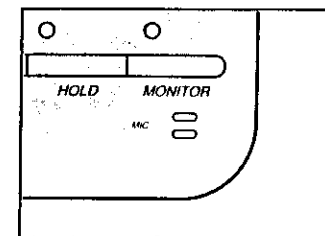

Immediately after the long beep, speak loudly and clearly, about 20 cm away from the microphone.

The PWR/IN USE indicator flashes. Your recording time is up to 2 minutes 20 seconds.

3

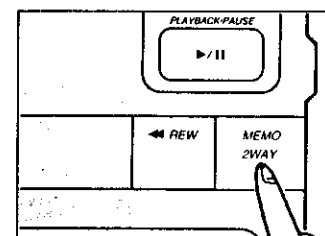

Press the MEMO/2WAY button again when you finished recording.

The unit rewinds the tape to the beginning, and is ready to answer the next phone calls.

The PWR/IN USE indicator light is on and the ANS/CALLS indicator flashes to show that your message was recorded.

Resetting the tape for future message

After listening to the messages, you can reset the tape and record new messages from the beginning.

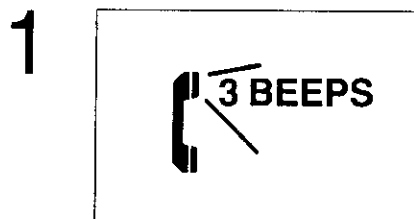

Wait for 3 beeps after the last message.

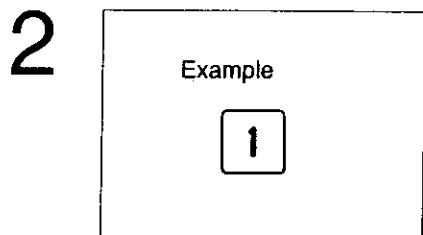

Press the code number within 10 seconds of hearing 3 beeps.

The unit will rewind the tape to the beginning. Future messages will be recorded and the old messages will be lost.

Recording a marker message

After listening to all your messages, you can leave a message on the same call. When replay is finished, wait for 3 beeps indicating the end of the last message. Then wait about 10 seconds for another 2 beeps indicating that the tape is ready for recording. Leave your message after the last 2 beeps. Hang up when finished.

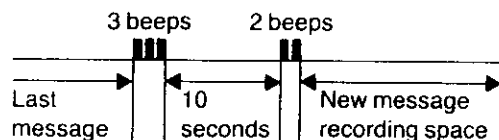

Setting the answer mode remotely

You can easily set the answer mode from a remote telephone.

1. Call your unit and let the telephone ring 15 times.
2. The unit will answer, and the OGM will be heard, then hang up.
The unit will be ready to answer the next phone call.

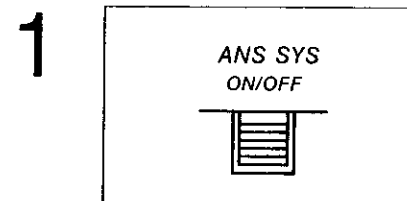

ANS SYS ON/OFF Switch

Press the switch to turn on the unit. The PWR/IN USE indicator light is on, and the unit resets the cassette tape.

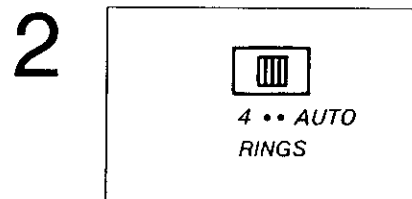

RINGS Selector

4: The unit answers on the 4th ring.

AUTO: See "TOLL SAVER" on page 11.

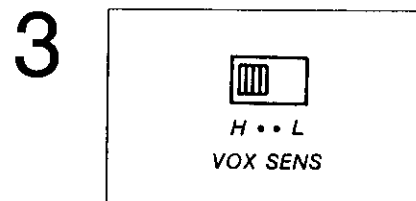

VOX SENS Selector

If either the tape continues to run after a caller has placed his handset or there are long pauses between or after messages, set the selector to the position "L".

(Normally the switch is preset to the position "H".)

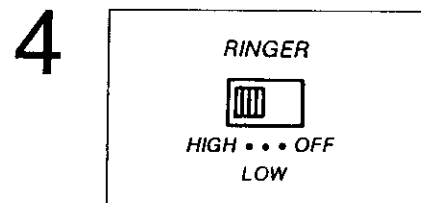

RINGER Selector

Set the selector to the "HIGH" or "LOW" position. When setting to the "OFF" position, the unit does not ring.

■ Timed Recall (Flash) Setting

The timing of recall signal is preset to "450 msec".

If you set the Timed Recall, refer to "Setting the Timed Recall (Flash)" on page 26.

Recording an Outgoing Message (OGM)

The Outgoing Message is an announcement to tell the caller that you are out, and asks to leave a message.

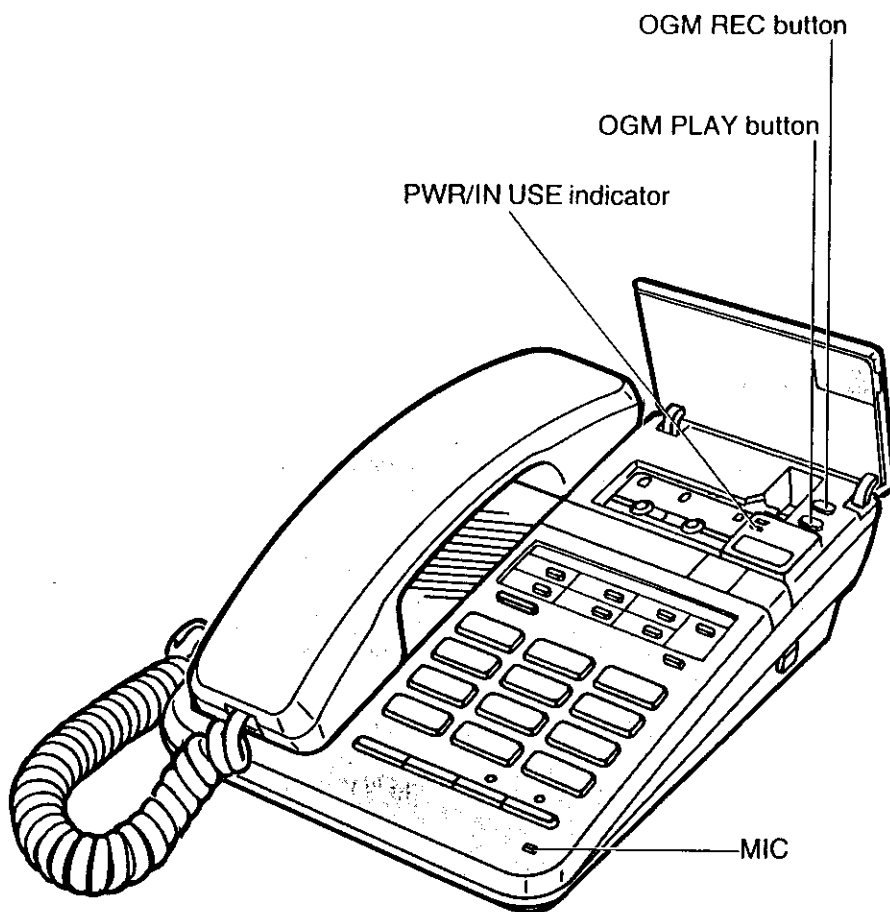

Sample OGM

"Hello, this is Paul Smith. I'm out now, but if you leave a message I'll call you back. **You will hear a series of short beeps then a long beep will be heard. Speak after the long beep. You have 2 minutes 20 seconds.**"

- Please record the bold-faced sentence surely on the OGM.
- Caller's recording time is up to 2 minutes 20 seconds.
- A series of short beeps lasts while the tape is preparing for recording, and a long beep means the tape is ready.

Playing back all the messages

1

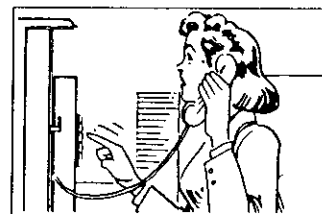

Call your unit.

2

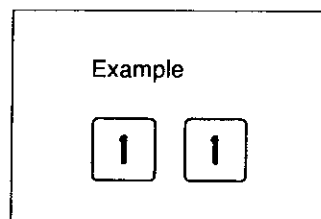

Dial your code number (for example, 1) for 1–2 seconds 2 times while the OGM is being played.

ie, Press code number twice

The unit rewinds the tape and plays back all the recorded messages. After the last message, 3 beeps will sound and you may hang up. Messages are automatically saved after hanging up.

To rewind during playback

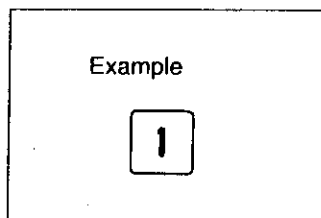

Dial the code number (for example, 1) for 1–2 seconds.

The unit rewinds the tape for a few seconds and starts playback.

Note:

When you press a button, press firmly for 1–2 seconds.

The unit may not respond if a remote touch tone phone (such as mobile telephone, etc.) produces tones that are too short to activate the unit.

Remote operation

You can retrieve the recorded Incoming Messages from a remote location with a touch tone phone by simply dialling your own remote code number.

Remote code number

A remote code number for you is preset and indicated on the bottom of the unit.

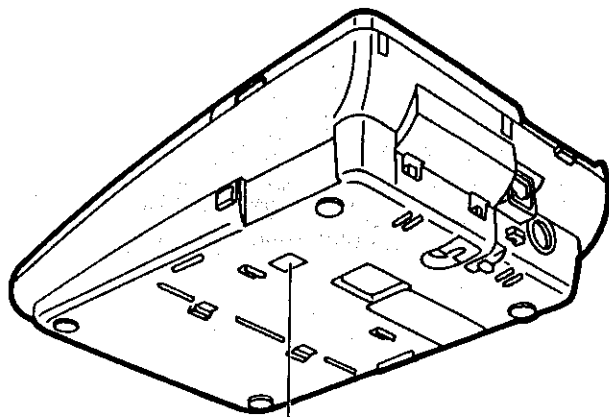

REMOTE CODE

The remote code number is indicated on the label.

Confirm that the PWR/IN USE indicator light is on.
Your OGM can be up to 30 seconds long.

CAUTION:

Do not pause for over 2 seconds during recording.
If 6 beeps sound, start over from step 1 again after the unit stops rewinding.

1

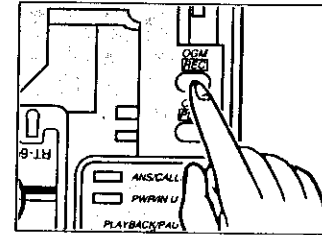

Press the OGM REC button, then release it.

2



Immediately after the long beep, speak clearly and loudly, about 20 cm away from the microphone.

The PWR/IN USE indicator flashes.

3

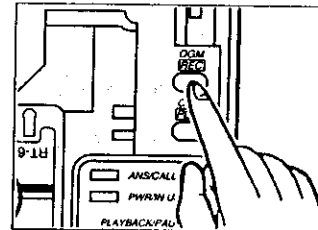

Press the OGM REC button again when you finish recording.

The unit rewinds the tape, and will be ready to answer the calls after 10 seconds.

NOTE:

When there is no room left on the tape to continue recording the caller's message, a beep will sound 6 times after the OGM or during the callers' recording. If you want to inform this to the caller, please record next sentences additionally in your outgoing message.

**"If the beep sounds 6 times, your message will not be recorded.
Should this happen, please call back tomorrow."**

Checking your recorded OGM

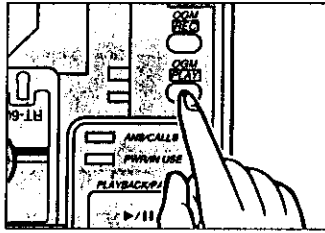

Press the OGM PLAY button.

Press the OGM PLAY button again if you want to stop the operation halfway.

The unit will be ready to answer the calls after 10 seconds.

Playing back the tape from the beginning

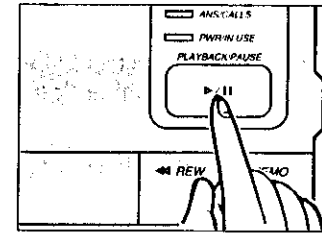

Press the PLAYBACK/PAUSE button.

The unit rewinds the tape and plays back your messages. 3 beeps will be heard indicating the end of the last message. After 10 seconds, the unit will rewind the tape, and new message will be recorded from the beginning of the ICM part of the tape.

Adjust volume, if needed.

Using your answering machine

After having done all the preparations for this unit (including connection), the unit resets the tape, and 10 seconds later, the ANS/CALLS indicator light is on.

Now your unit is ready to answer the phone call.

(The unit is set to the answer mode.)

Then it will record the callers' messages.

To pause during playback

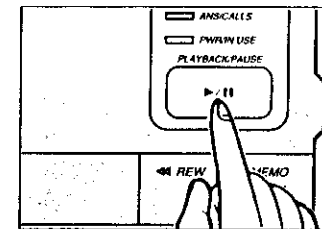

Press the PLAYBACK/PAUSE button during playback to pause the unit.

The PWR/IN USE indicator flashes (pause mode).

Press the PLAYBACK/PAUSE button again to restart playback.

To rewind during playback

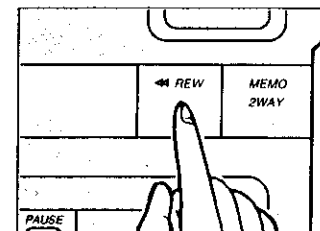

Press the REW button to rewind the tape to the desired location.

The unit will play back the message again after you release the REW button.

If you keep pressing the REW button until the unit rewinds to the beginning of the tape, a beep will be heard. In this case, the unit has been reset to the answer mode.

Listening to the recorded messages

When an Incoming Message (ICM) has been recorded, the ANS/CALLS indicator will flash in groups. The amount of flashes indicates the number of messages recorded up to 15 times. (Three flashes followed by a pause means that 3 messages were recorded.)

In case of power interruption, the ANS/CALLS indicator will flash slowly.

TELEPHONE

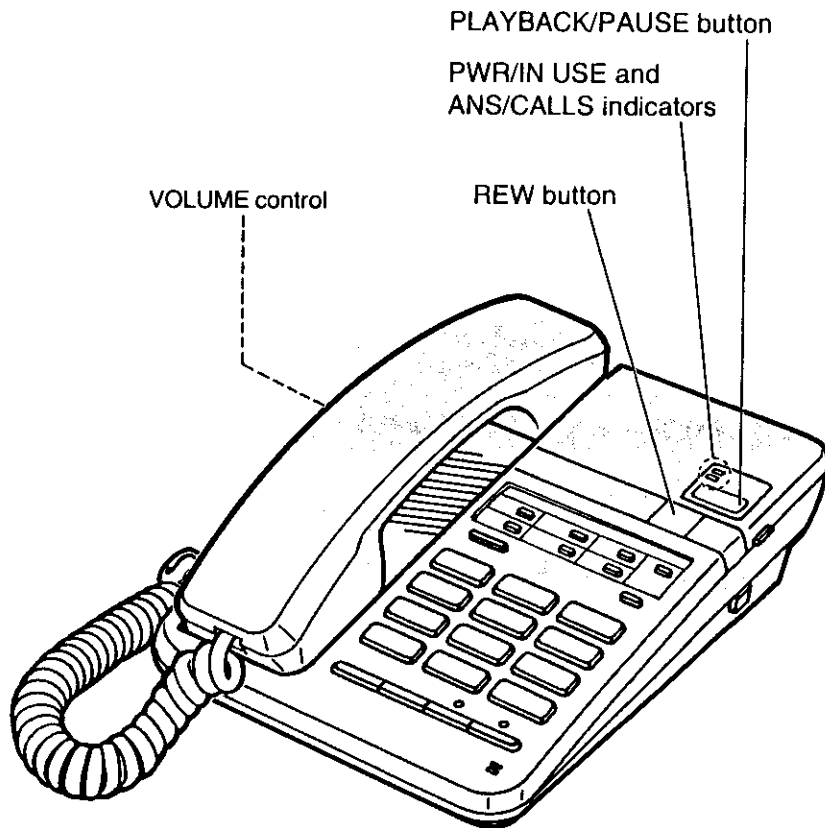

AUTO-LOGIC

At the touch of the PLAYBACK/PAUSE button, the unit will automatically rewinds and play back all the recorded messages. 10 seconds after playback, the unit will reset the tape and be ready to record incoming calls automatically.



Making and answering calls

Making calls with the handset

1. Lift the handset, and identify the dial tone.
2. Dial the telephone number.

Making calls with the MONITOR button (on-hook dialling)

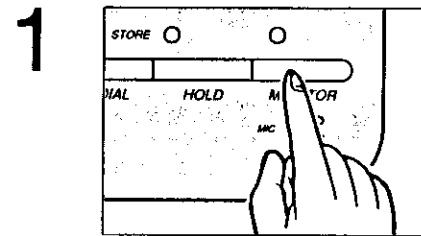

Press the MONITOR button, and identify the dial tone.

The MONITOR indicator light is on.

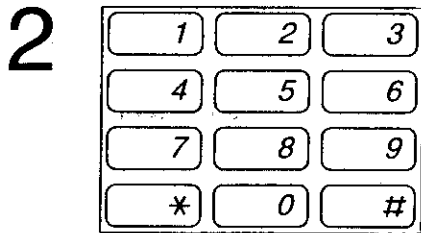

Dial the telephone number.



When the other party answers, lift the handset and speak to the other party.

Hang up the handset when your conversation is over.
The MONITOR indicator light is off.

Recording from the beginning of the ICM part of the tape

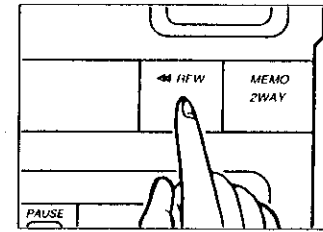

Press the REW button until the unit stops rewinding (a beep sounds), then release it.

OR

After ICM playback, leave the unit as it is. The unit has been reset to the answer mode.

New messages are recorded over the old messages.

Recording after the messages you have heard

When you want to record the next Incoming Messages (ICMs) after the last recorded message, or after a desired position of the tape, save the messages you have heard.

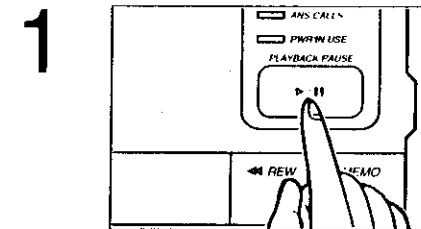

Press the PLAYBACK/PAUSE button to play back the tape to the end of the message you want to save.

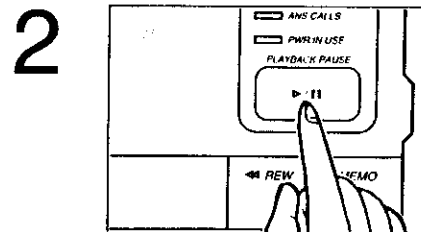

Press the PLAYBACK/PAUSE button again to pause the unit.

The PWR/IN USE indicator flashes. (Pause mode)

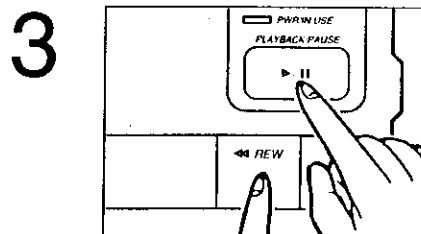

Press the REW button and the PLAYBACK/PAUSE button simultaneously.

The PWR/IN USE and the ANS/CALLS indicator lights are on. New calls will be recorded after the message(s) you have saved.

Setting up for answering machine

Press the ANS SYS ON/OFF switch to turn on the unit. The PWR/IN USE indicator light is on. 10 seconds after, the ANS/CALLS indicator light is on and the unit is ready to answer the next phone call.

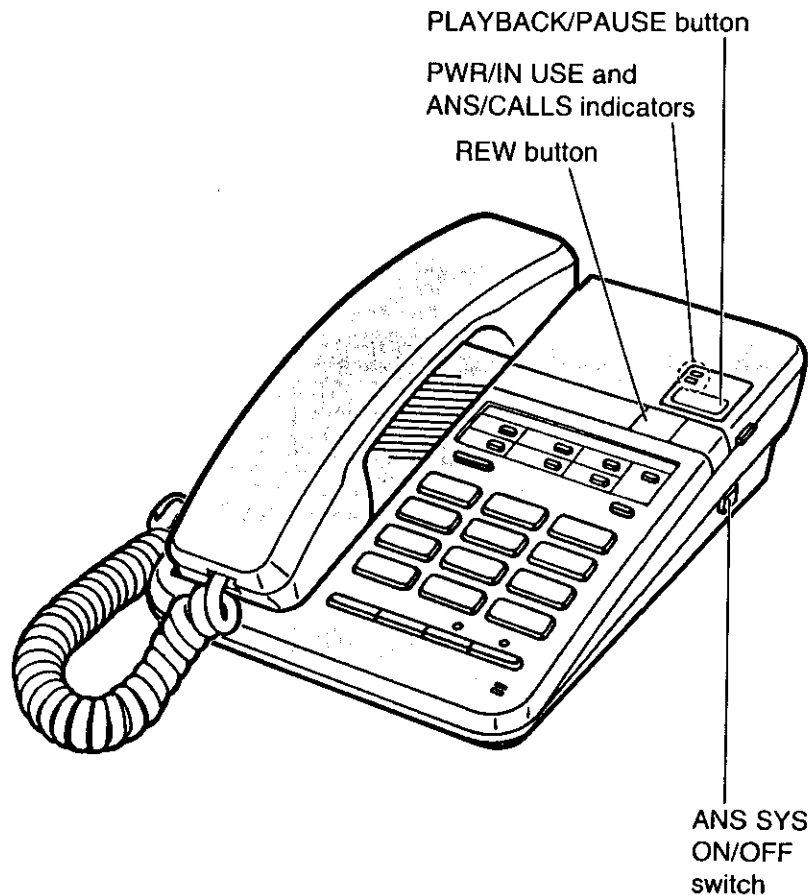

Redialling

The unit can redial the last dialed number automatically. The REDIAL button will store the last dialed number into memory up to 32 digits.

1

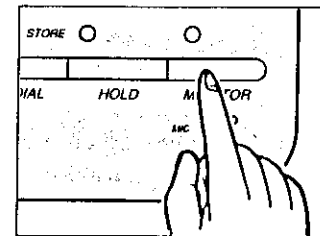

Lift the handset or press the MONITOR button, and identify the dial tone.

2

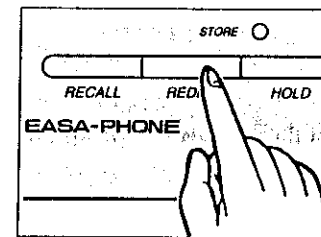

Press the REDIAL button.

You can redial once.

You can redial soon after dialling the telephone number by pressing the REDIAL button without hanging up.

Answering calls

When the telephone rings, lift the handset and start speaking.

- Answer mode:
When a call is received, the unit answers the call and record the Incoming Message.
- If you do not want the unit to answer the call, press the ANS SYS ON/OFF switch to turn off the unit. The PWR/IN USE indicator light will go out.
- Caller's recording time is limited to 2 minutes 20 seconds.

Automatic dialling

There are 6 direct call buttons including CLEAR and PAUSE. Each button consists of 2 memory locations (upper and lower). You can store 12 numbers up to 32 digits.

CAUTION:

Do not press any direct call buttons before storing the telephone number. This is to prevent misoperation of automatic dialling function. Refer to "Storing the telephone numbers" on pages 21 to 24.

Making calls using the upper memory location

1

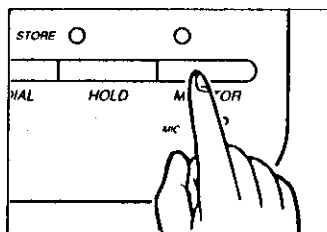

Lift the handset or press the MONITOR button, and identify the dial tone.

2

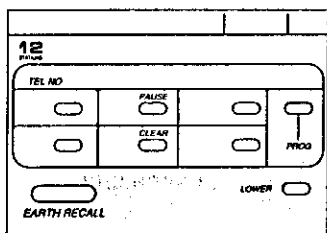

Press the direct call button in which the number that you want to dial is stored.

ANSWERING MACHINE

At first, please record your Outgoing Message before using your unit as an answering machine. (For Outgoing Message recording, see page 14.)

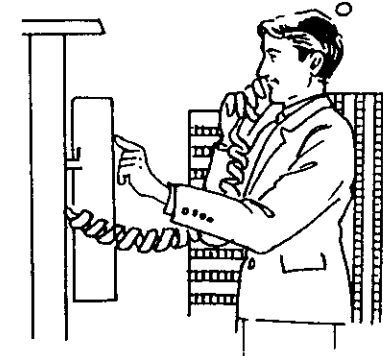
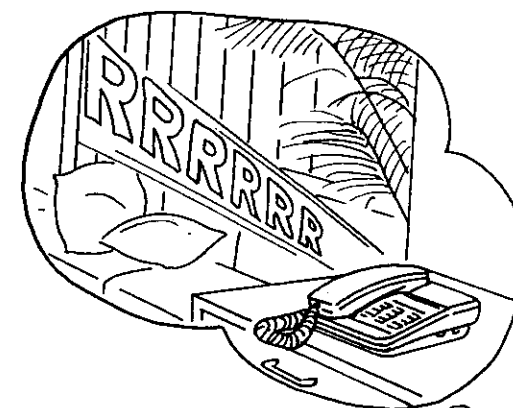

Hold

The HOLD button is used to keep a call on hold while having a conversation.

Press the HOLD button while having a conversation.

The HOLD indicator flashes.

You may place the handset on the cradle.

Releasing a hold

- If the handset is off-hook; press the HOLD button again.
- If the handset is on the cradle (on-hook); lift the handset or press the MONITOR button.
- When using another telephone connected on the same line; lift the handset of the other telephone. If the hold is not released, press the hookswitch of the other telephone for about one second.

Pause

The PAUSE button is helpful in the automatic dialling when accessing an outside line. To use this function, store "pause" with the telephone number into the memory station beforehand.

While storing the telephone number into the memory, one pause is required when waiting for an outside dial tone.

Example:

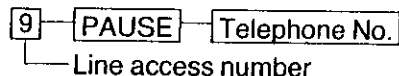

Press once (3.5 seconds pause)
Press twice (7 seconds pause)

Combination dialling

A telephone number with more than 32 digits can be stored into two memory stations. For dialling, follow the next:

1. Lift the handset, and identify the dial tone.
2. Press the direct call button "1".
3. Press the direct call button "2".

Instead of using two memory stations, you can store a part of the telephone number into one memory station, and the other part can be dialled manually.

1. Lift the handset, and identify the dial tone.
2. Press the station key, wait for dialling to stop, then dial manually.

Making calls using the lower memory location

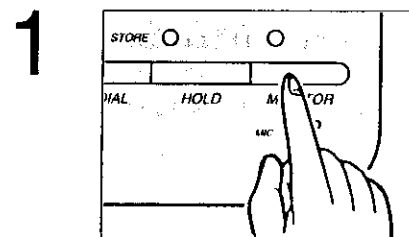

Lift the handset or press the MONITOR button, then identify the dial tone.

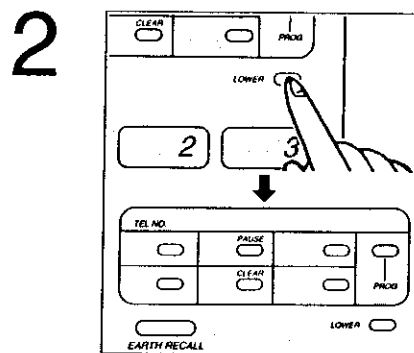

Press the LOWER button, then press the direct call button in which the number that you want to dial is stored.

If you press the LOWER button by mistake when you want to use the upper location, you must hang up and then dial again.

Memory card

Use a pencil or a ball-point pen to fill in the station directory with station name. (You can use the reverse side for writing, too)
Remove the cover using an instrument with a pointed end, like a pen.

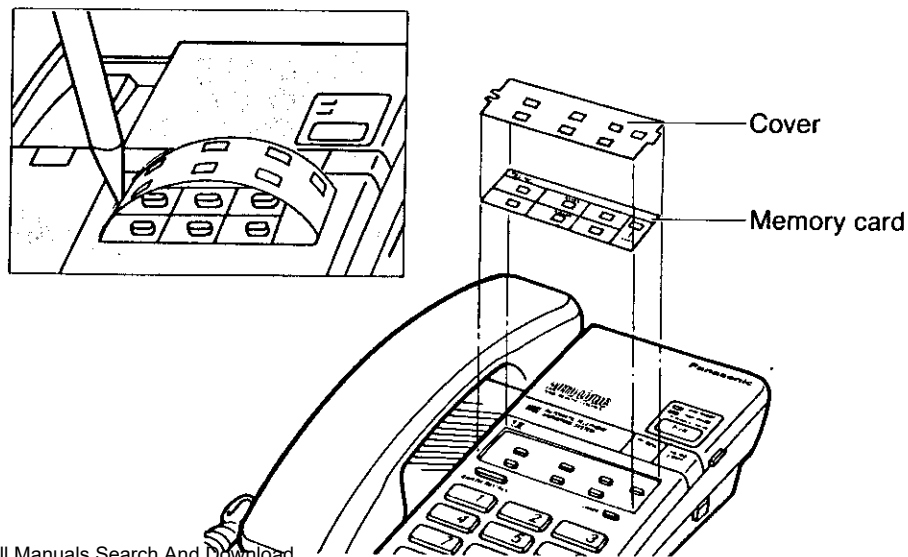

Storing the telephone numbers

Make sure that the handset is on the cradle, the MONITOR indicator is off and the AC adaptor is connected. When you store a telephone number into memory, pressing 0 through 9, #, *, PAUSE, or RECALL button counts as 1 digit.

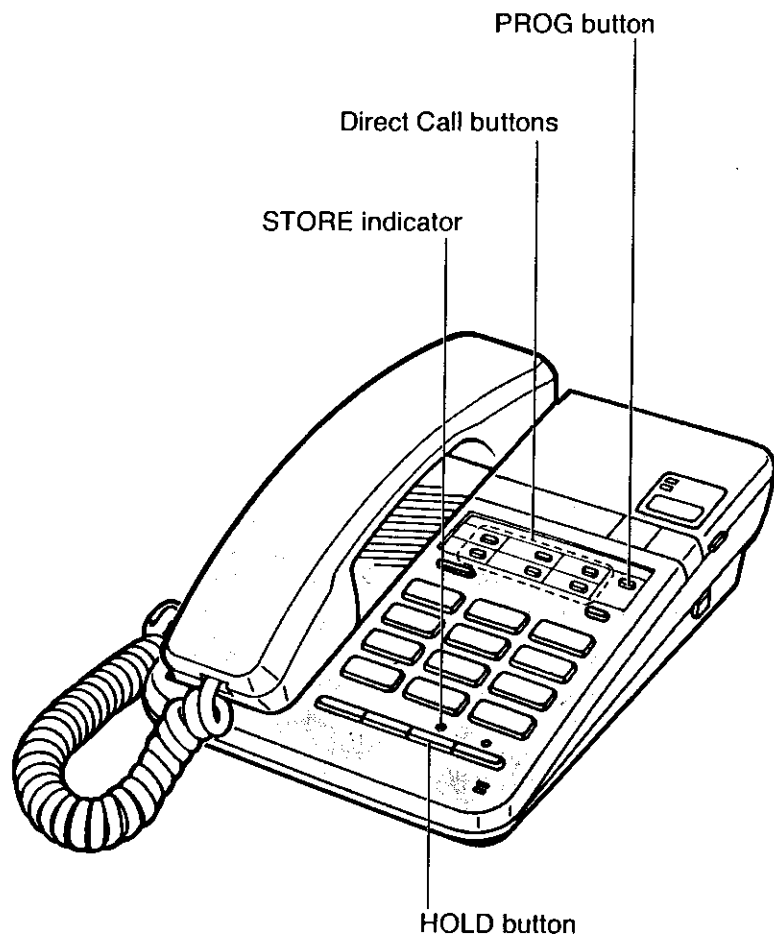

Setting the Timed Recall (Flash)

The timing of recall signal must be within the requirement from your Central Office or Host PBX. Depending on your PBX, you may have to reprogram the recall signal. 3-digit numbers (100 through 950 msec, every 50 msec) are available for the recall signal—100, 150, 200,...950 msec. The timing of recall signal is preset to "450 msec".

To program the timing of recall signal

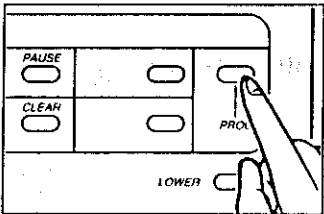
- 

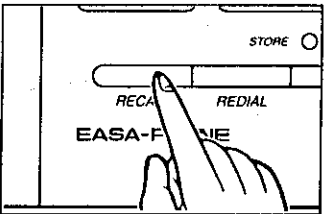
1 Press the PROG button.
The STORE indicator light is on.
- 

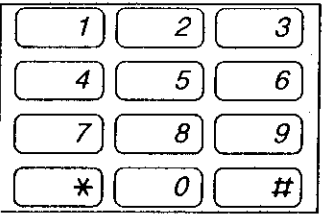
2 Press the RECALL button.
The STORE indicator goes out.
- 

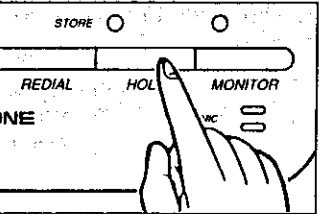
3 Enter the 3-digit number that your PBX requires.
(For example, to program 600 msec for recall signal, enter "600".)
- 

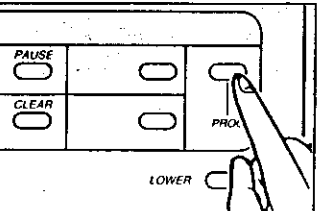
4 Press the HOLD button.
The STORE indicator light is on.
- 

5 Press the PROG button after storing all the numbers.
The STORE indicator light goes out.

Other operation

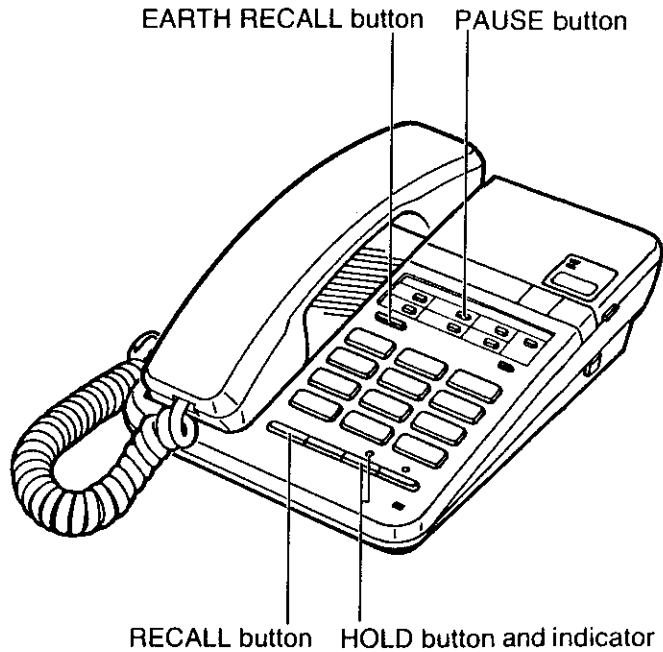

Recall

The RECALL and EARTH RECALL buttons are used to access special telephone services such as call waiting service or call forwarding. Use these buttons properly depending on the type of the PBX that your unit is connected to.

Use the RECALL button for PBX with Timed Break register recall facility.

The timing of the recall signal can be changed by programming, see page 26.

Use the EARTH RECALL button for PBX with Earth Recall facility.

Example: Call waiting

1. During conversation, another party calls and you hear a tone.
2. Press the RECALL or EARTH RECALL button.

The first conversation is placed on hold and the second call can be answered.

To speak to the first caller again (the second caller is placed on hold), press the button again.

You may access some features of your host PBX using the RECALL button in a dialling operation.

Storing into the upper memory location

1

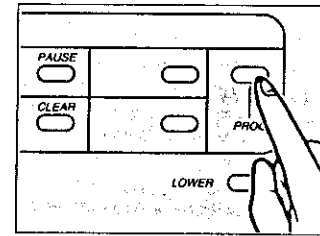

Press the PROG button.

The STORE indicator light is on.

2

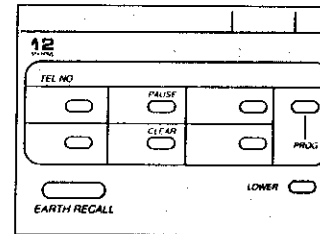

Press the direct call button.

The STORE indicator light goes out.

3

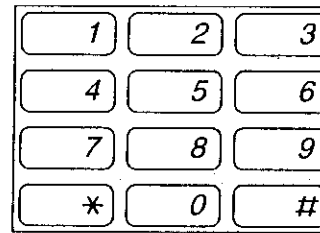

Dial the telephone number that you want to store, up to 32 digits.

4

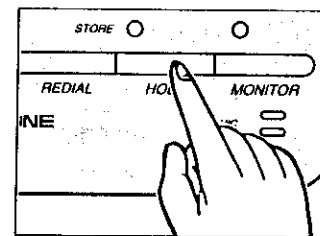

Press the HOLD button to store the number into memory.

The STORE indicator light is on. To store other numbers in succession, repeat from step 2.

5

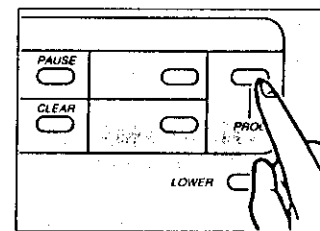

Press the PROG button after storing all the numbers.

The STORE indicator light goes out.

Storing into the lower memory location

1

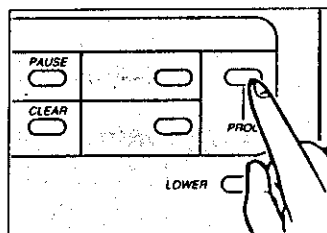

Press the PROG button.

The STORE indicator light is on.

2

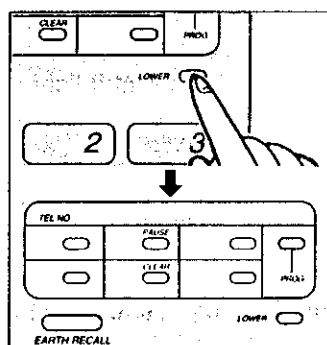

Press the LOWER button (the STORE indicator flashes), then press the direct call button.

The STORE indicator light goes out.

3

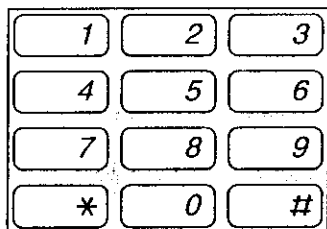

Dial the telephone number that you want to store, up to 32 digits.

4

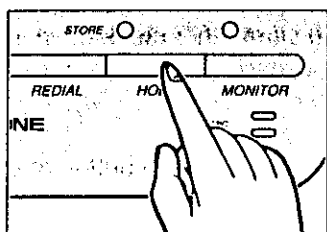

Press the HOLD button.

The STORE indicator light is on. To store other numbers in succession, repeat from step 2.

5

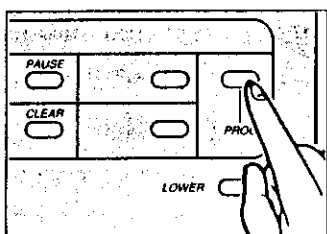

Press the PROG button after storing all the numbers.

The STORE indicator light goes out.

Correcting an error while storing

If you notice an error before pressing the HOLD button;

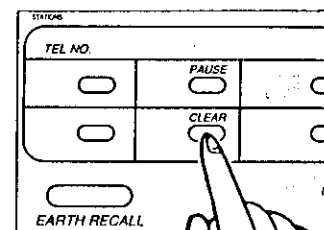

Press the CLEAR button.

Repeat from step 2 of the storing procedure.

Confirming a stored number

Store the same number into the same station. When you press the HOLD button, you hear a beep once or twice.

- Twice: The number newly stored is the same as that was previously stored.
- Once: The number newly stored is different from the one that was previously stored. Reprogram the correct number.

Erasing a stored number

1. Press the PROG button.
2. Press the direct call button in which the number that you want to erase is stored.
3. Press the HOLD button.
4. Press the PROG button.

When you want to erase the number stored into the lower memory location, press the LOWER button then press the direct call button at step 2 of the above procedure.

Free Manuals Download Website

<http://myh66.com>

<http://usermanuals.us>

<http://www.somanuals.com>

<http://www.4manuals.cc>

<http://www.manual-lib.com>

<http://www.404manual.com>

<http://www.luxmanual.com>

<http://aubethermostatmanual.com>

Golf course search by state

<http://golfingnear.com>

Email search by domain

<http://emailbydomain.com>

Auto manuals search

<http://auto.somanuals.com>

TV manuals search

<http://tv.somanuals.com>