

Panasonic

Cordless Phone

Model No. **KX-T4046NZ**

Operating Instructions



D **DYNAMIC
SOUND FOCUS
PLUS**

Getting Started

Basic Operation

Advanced Operation

Useful Information

PLEASE READ BEFORE USE AND SAVE.

Charge the battery for about 10 hours before initial use.

Before Initial Use

Thank you for purchasing the Panasonic cordless telephone.

For your future reference

Serial No. _____

Date of purchase _____

(found on the bottom of the unit)

Name and address of dealer _____

Accessories

AC Adaptorone
(p. 7)

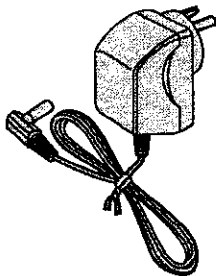

Telephone Line Cordone
(p. 7)



Wall Mounting Adaptor.....one
(p. 9)

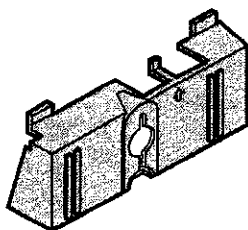

For Best Performance

Battery Charge

To power the handset, charge the battery for about **10 hours** before initial use (p. 8).

The battery is beneath this cover.

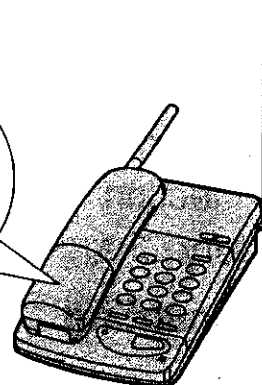

Operating Distance/Noise

Calls are transmitted between the base unit and the handset using wireless radio waves. **For maximum distance and noise free operation**, the recommended base unit location is:

Away from electrical appliances such as a TV, radio, or personal computer.

In a **HIGH** and **CENTRAL** location with no obstructions such as walls.

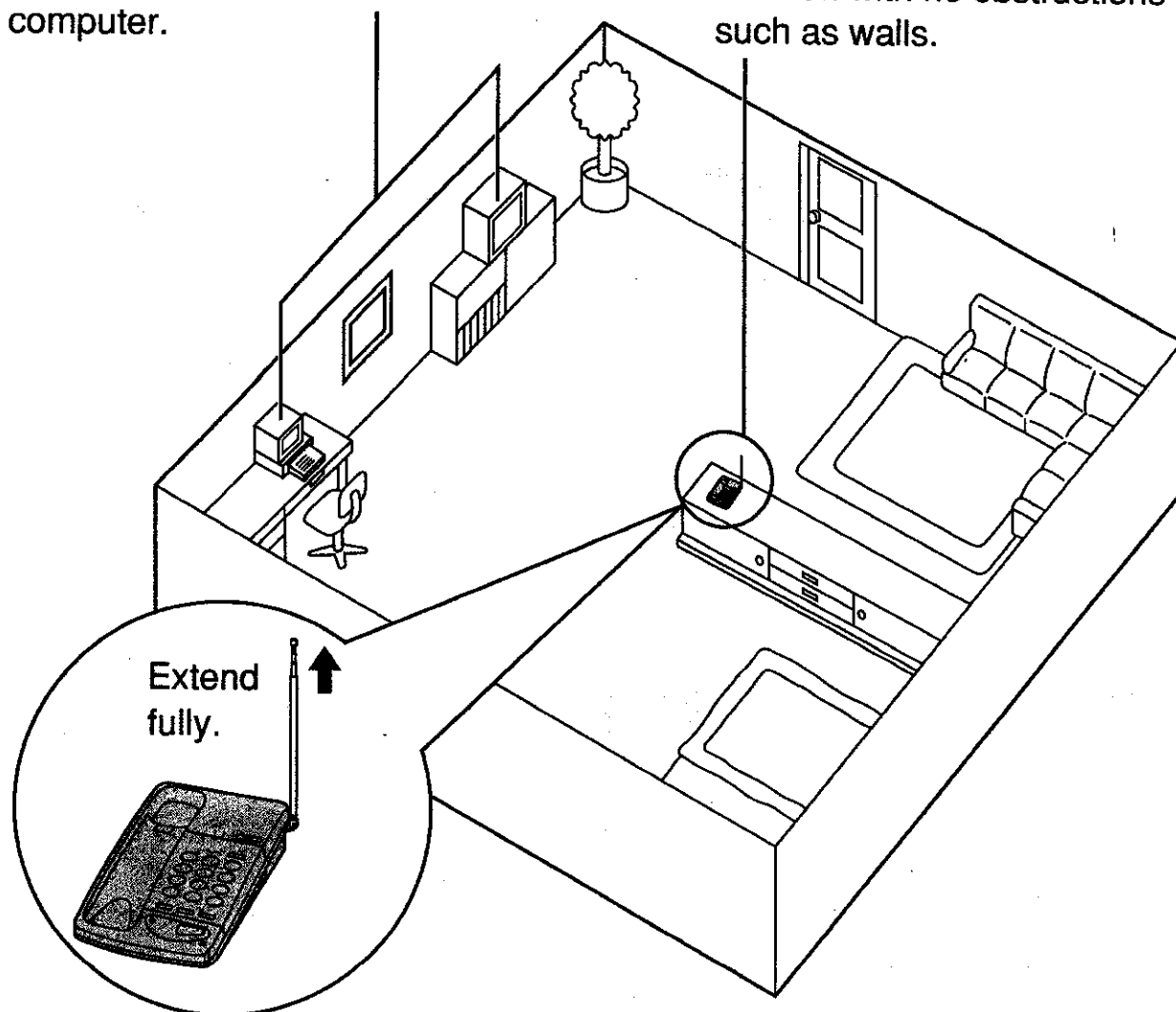

Contents

Getting Started

Location of Controls	5
Setting Up	7
Connection	7
Battery Charge	8
Wall Mounting	9

Basic Operation

Making/Answering Calls	10
Making Calls with the Handset	10
Answering Calls with the Handset	11
Making Calls with the Base Unit	12
Answering Calls with the Base Unit	13
Automatic Dialing	14
Storing Phone Numbers in Memory	14
Dialing a Stored Number	15

Advanced Operation

Intercom	16
Transferring a Call Using Intercom	17
Special Features	18
Automatic Security Code Setting	18
For Call Waiting Service Users	18
If Your Unit is Connected to a PBX	18
RECALL Button	19

Useful Information

Battery Replacement	20
Adding Another Phone	20
Before Requesting Help	21
Safety Instructions	23

Location of Controls



Handset

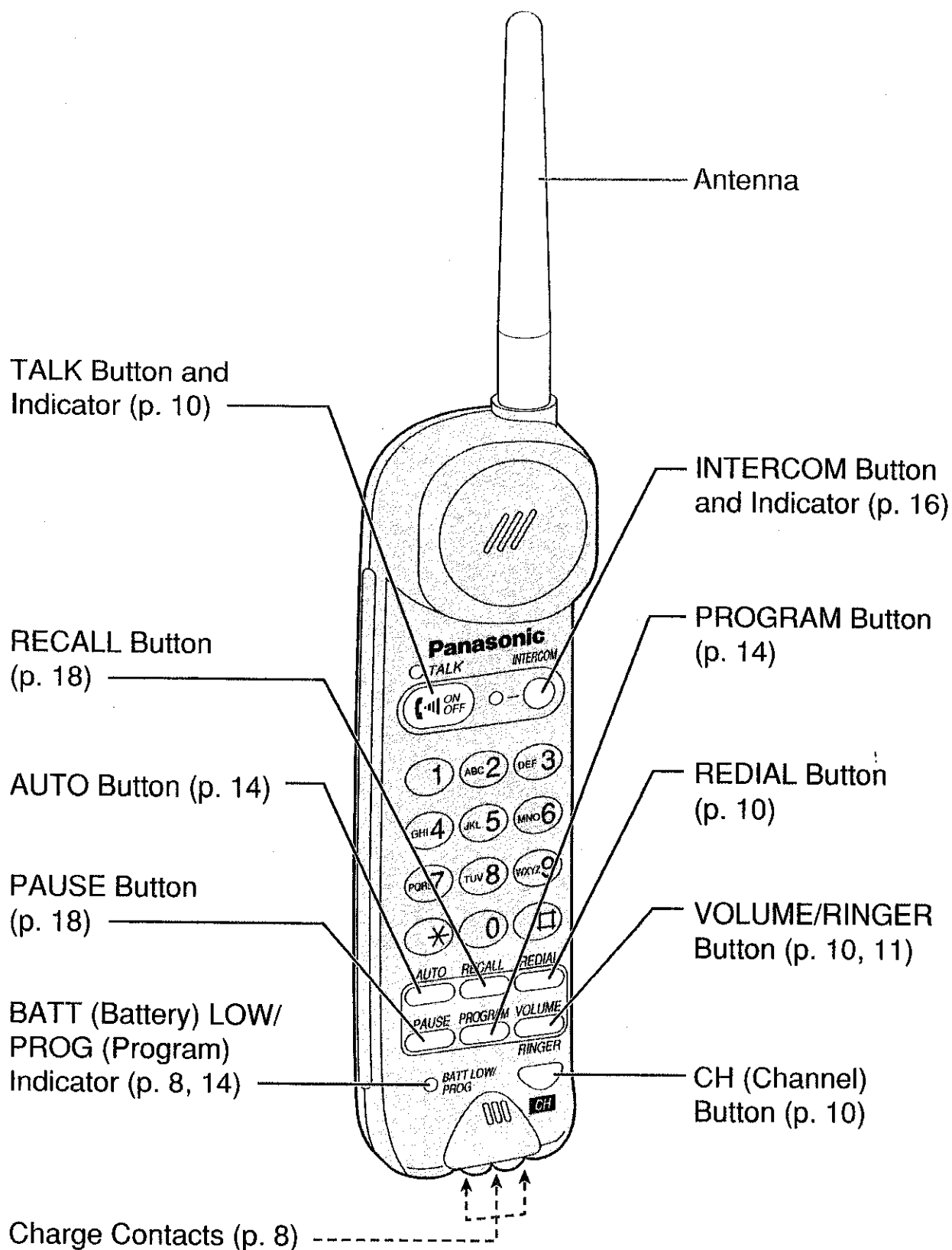

➔ Location of Controls

Base unit

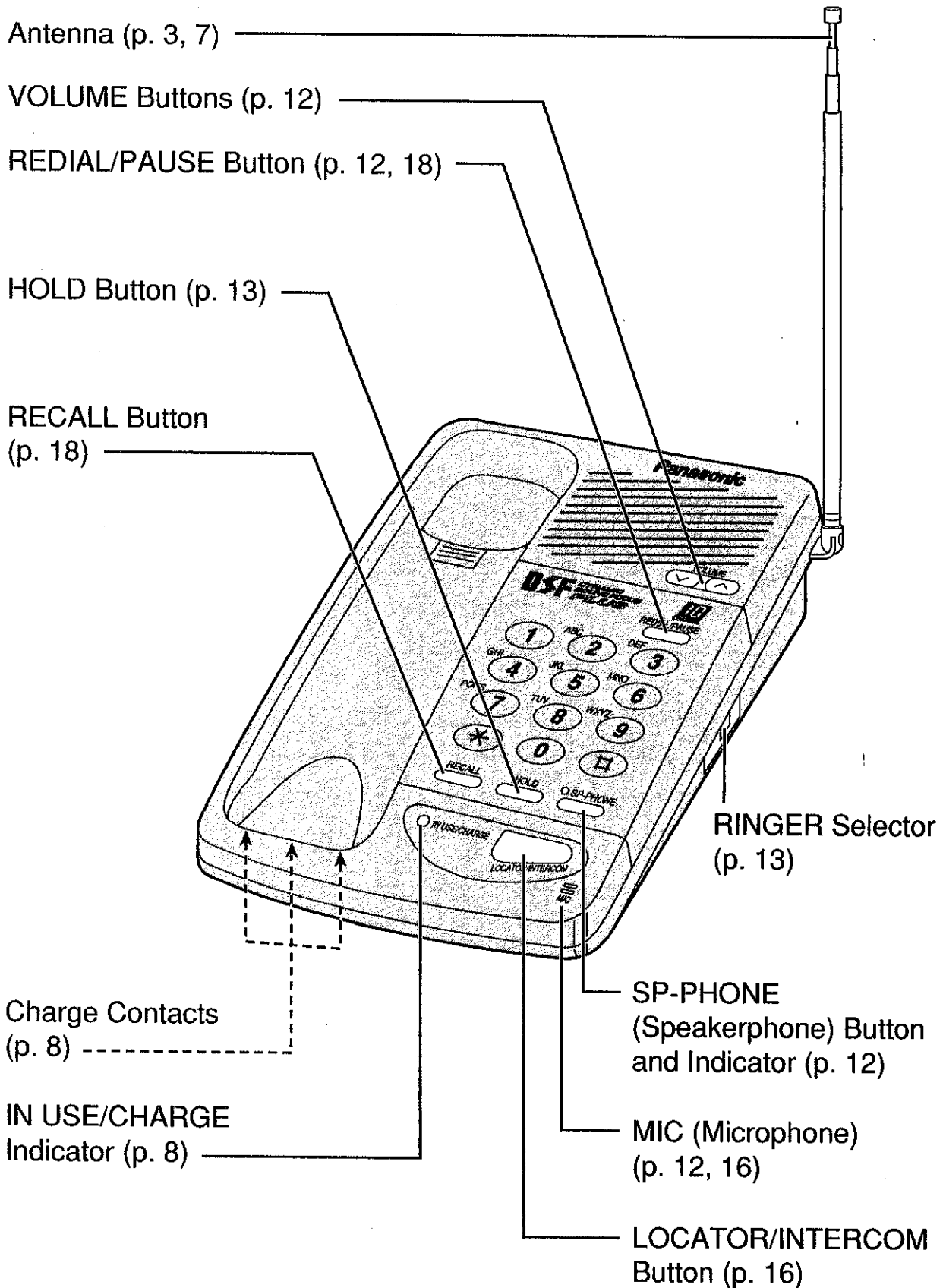

Setting Up



Connection

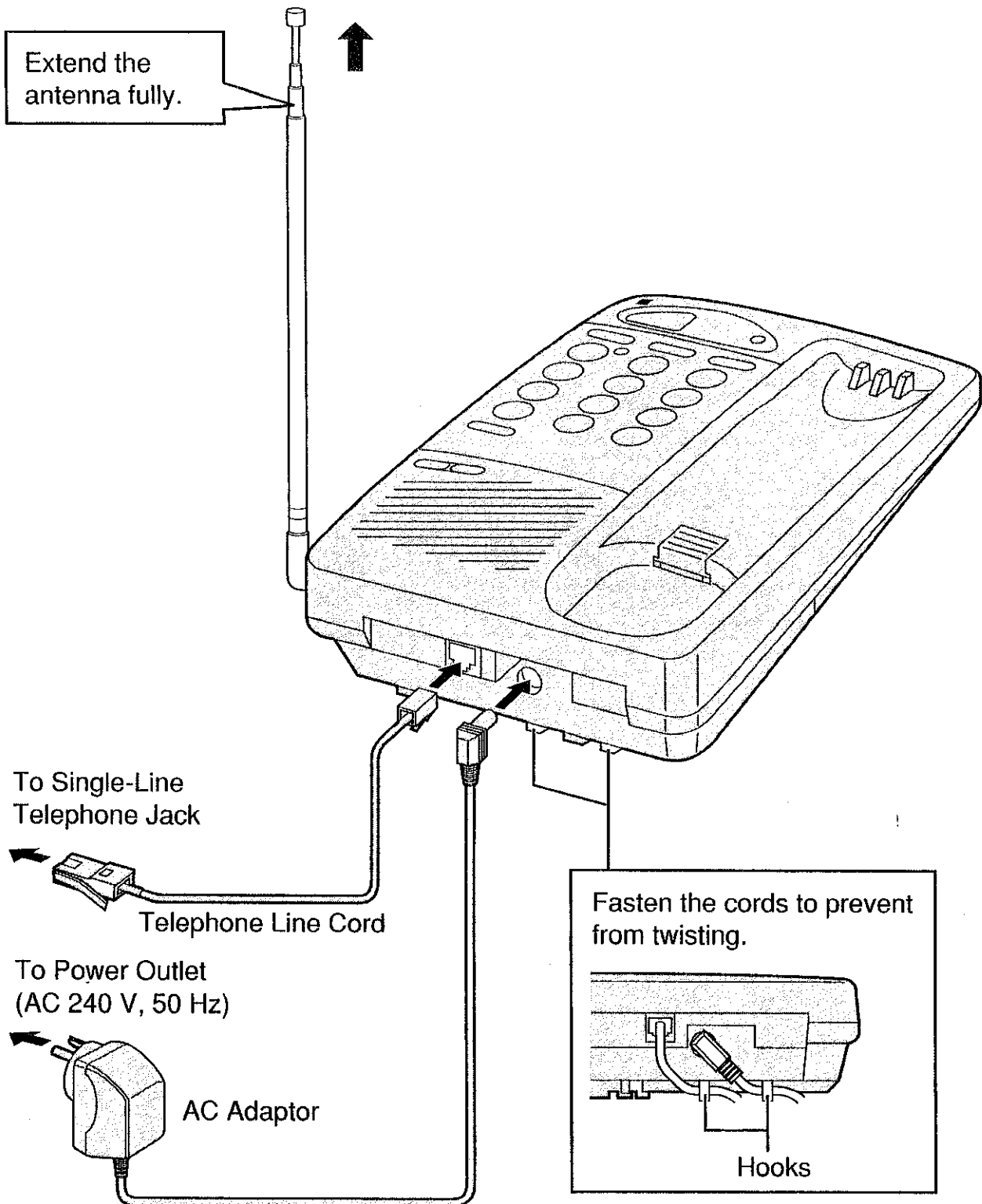

- USE ONLY Panasonic AC ADAPTOR KX-A11BA.
- The AC adaptor must remain connected at all times. (It may feel warm during use. This is normal.)
- If you connect a reserve telephone on the same line, see page 20.
- KX-T4046NZ is not designed to be used with rotary (pulse dialing) services.

➔ Setting Up

Battery Charge

Place the handset on the base unit for about **10 hours**.

- The IN USE/CHARGE indicator lights.

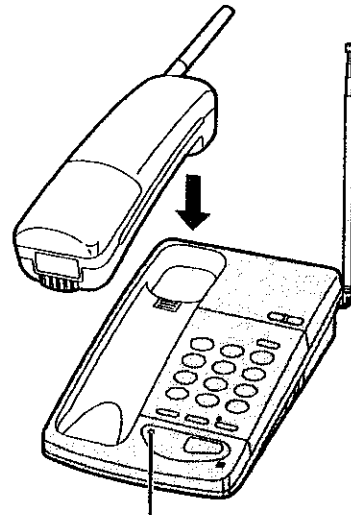

IN USE/CHARGE Indicator

Recharge

When the BATT LOW/PROG indicator flashes or the unit beeps intermittently, recharge the battery.

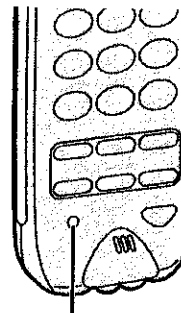

BATT LOW/PROG Indicator

Standard battery life

If your Panasonic battery is fully charged;

While in use (TALK)	Up to about 8 hours
While not in use (Stand-By)	Up to about 30 days

- Battery life may vary depending on usage conditions and ambient temperature.
- **Clean the handset and the base unit charge contacts with a soft dry cloth once a month**, or the battery may not charge properly.
- Once the battery is fully charged, you do not have to place the handset on the base unit until the BATT LOW/PROG indicator flashes.
- The battery cannot be overcharged.

Wall Mounting

This unit can be mounted on a wall.

- 1 Set the handset guide.
 - ① Push to remove.
 - ② Rotate 180°.
 - ③ Replace with the tab facing upwards.

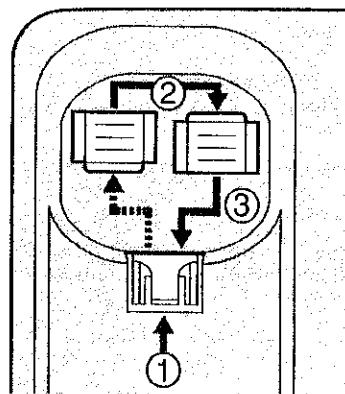

- 2 Connect the AC adaptor.

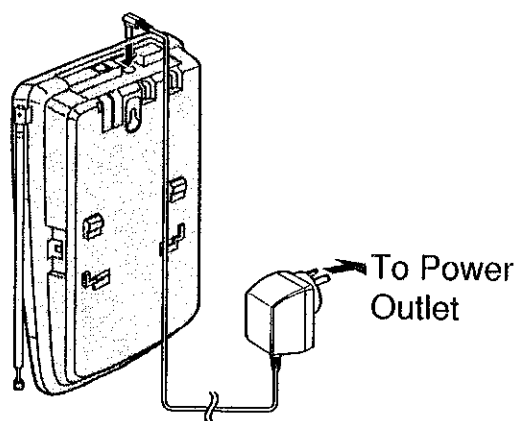

- 3 Tuck the telephone line cord inside the wall mounting adaptor, then push it in the direction of the arrow.

- The word "UP" should face upward.

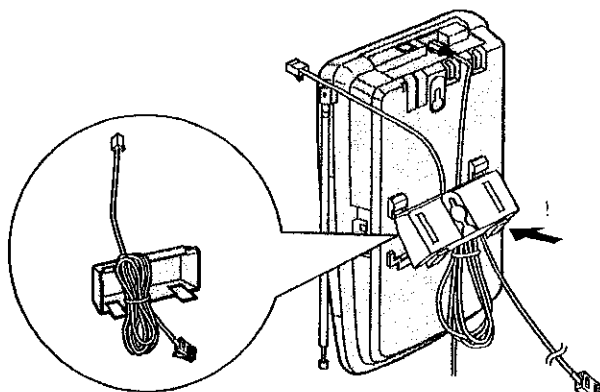

- 4 Install screws using the wall template below. Connect the telephone line cord. Mount the unit, then slide it down.

- Extend the antenna fully.

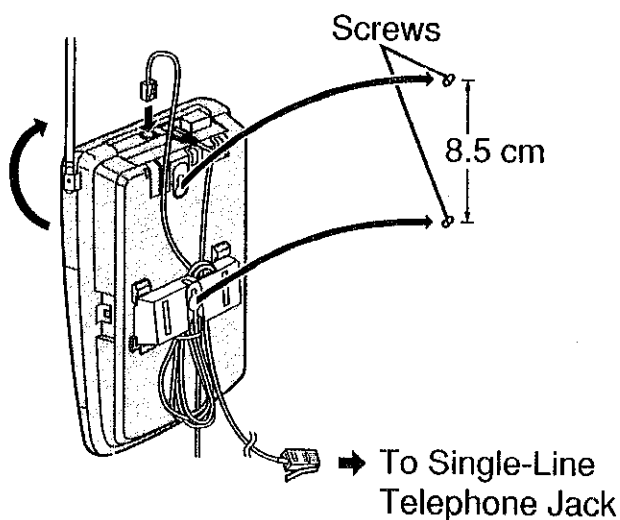

Wall Template

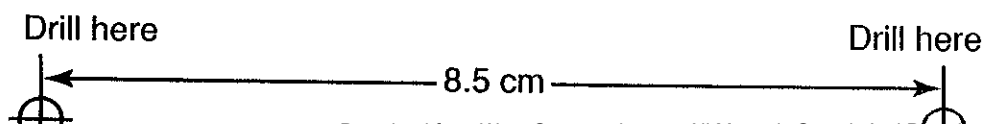

➔ Making/Answering Calls

Making Calls with the Base Unit

- 1 Press **SP-PHONE**.
 - The indicator lights.
- 2 Dial a telephone number.
- 3 When the other party answers, speak into the **MIC** (microphone).
- 4 To hang up, press **SP-PHONE**.
 - The indicator light goes out.

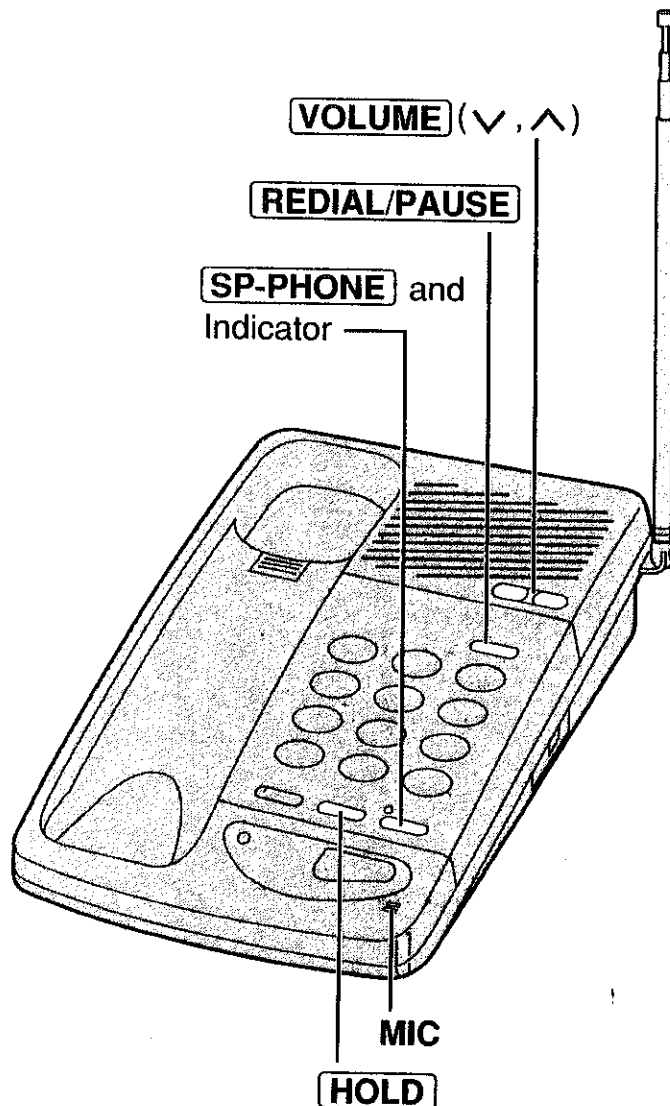

- For best speakerphone performance, use in a quiet room and speak alternately with the caller.
- While using the speakerphone, if the handset is on the base unit, you may switch to the handset by lifting it up.

To redial the last number

Press **SP-PHONE** ➔ **REDIAL/PAUSE**.

To adjust the speaker volume (12 levels)

To increase, press \wedge . To decrease, press \vee .

To put a call on hold

Press **HOLD**.

- The SP-PHONE indicator flashes.
- If you put a call on hold for 6 minutes, a warning tone will sound. The call will be disconnected after a total of 10 minutes.

To release the hold

Press **SP-PHONE** or lift the handset off the base unit.

- If another phone is connected on the same line, you can also release the hold by lifting its handset.

Answering Calls with the Base Unit

- 1 Press **SP-PHONE**.
- 2 Speak into the **MIC**.
- 3 To hang up, press **SP-PHONE**.

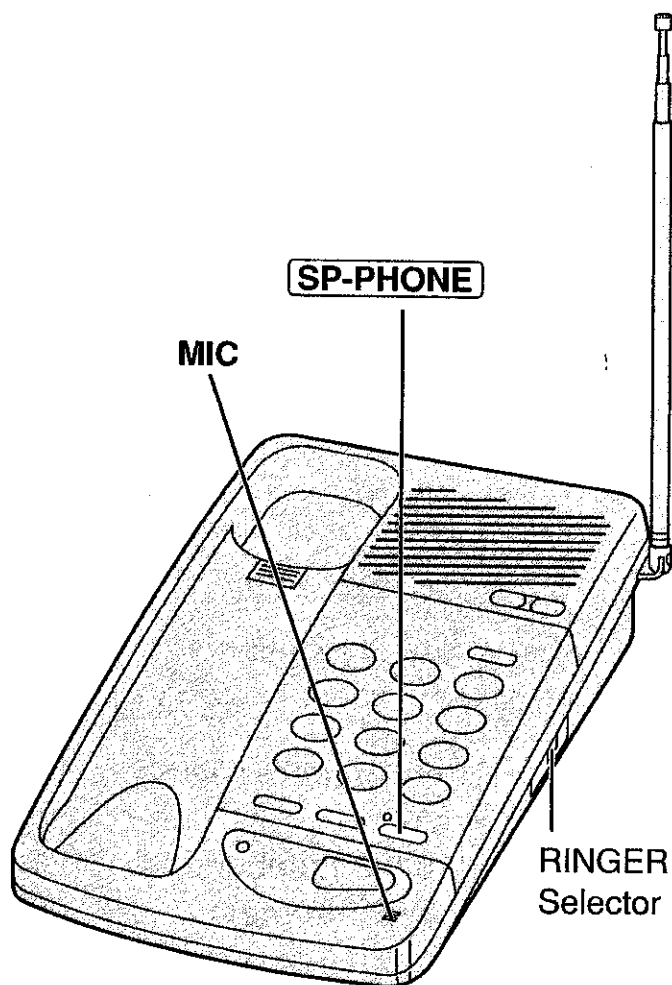

To select the ringer volume

Set the RINGER selector to HIGH, LOW, or OFF.

- When set to OFF, the base unit will not ring.

Automatic Dialing

Storing Phone Numbers in Memory

The handset dialing buttons (0 to 9) function as memory stations. The TALK indicator light must be off.

- 1 Press **PROGRAM**.
 - The BATT LOW/PROG indicator lights.
- 2 Enter a phone number up to 16 digits.
 - If you misdial, press **PROGRAM** to end storing, then restart from step 1.
- 3 Press **AUTO**.

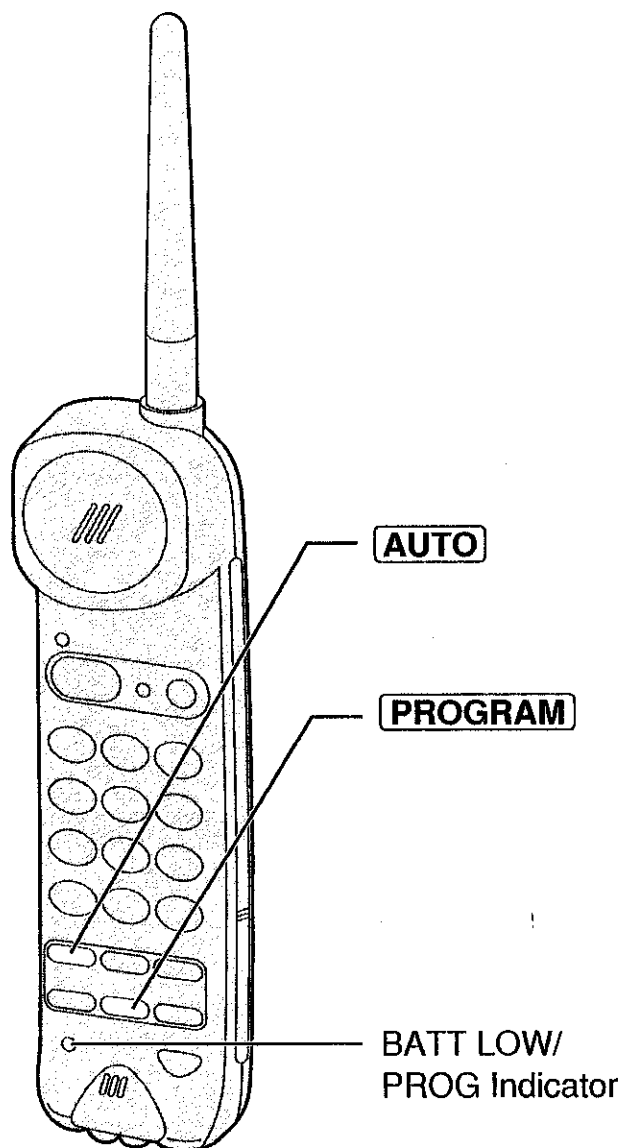

- 4 Press a memory station number (0 to 9).
 - A confirmation tone sounds. (See below.)
 - To store other numbers, repeat steps 1 through 4.

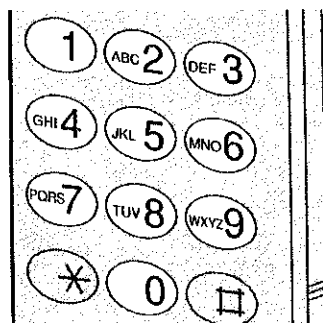

What the confirmation tone means

- 1 beep: The new number is stored.
- 2 beeps: The number is the same as a previously stored one.

To erase a stored number

Press **PROGRAM** ➔ **AUTO** ➔ the memory station number (for the phone number to be erased).

Memory sticker

You may use the included memory sticker as a memorandum for automatic dialing. Write down the names or phone numbers, then attach it to the unit or at a convenient place.

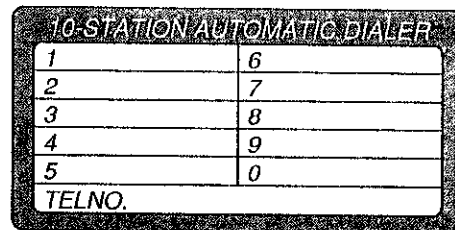

Dialing a Stored Number

- 1 Press **TALK**.
- 2 Press **AUTO**.
- 3 Press the memory station number (0 to 9).
 - The stored number is dialed.

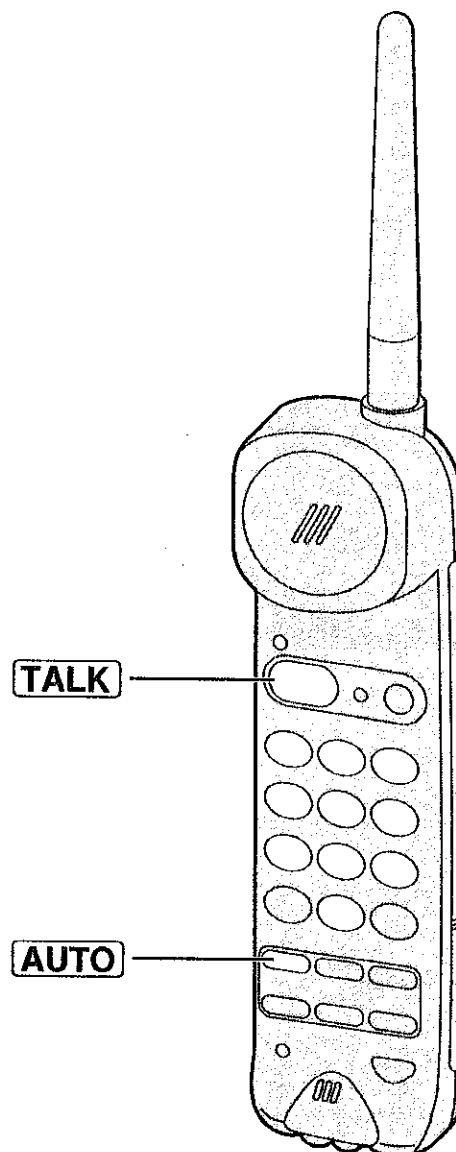

Intercom

A 2-way intercom is available between the handset and the base unit.

Paging the base unit from the handset

- 1 Handset:
Press **INTERCOM**,
then talk.
 - The indicator lights.
- 2 Base unit:
When the other party's voice
is heard, answer through the
MIC.
- 3 Handset:
To end the intercom, press
INTERCOM.

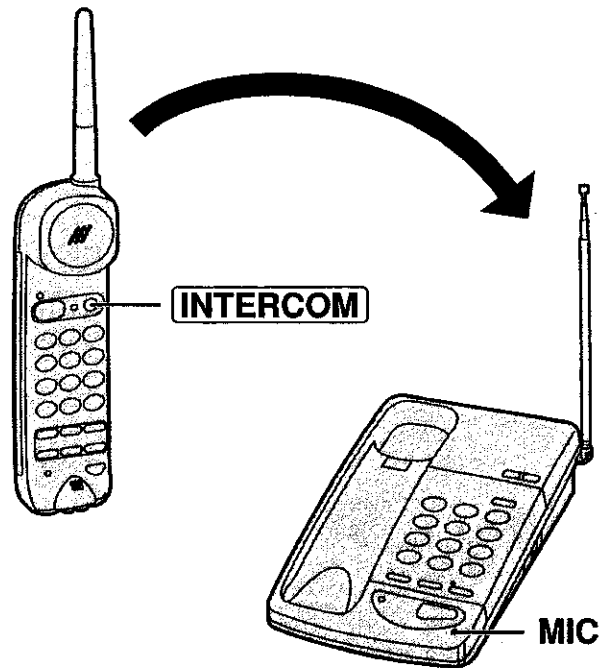

Paging the handset from the base unit (Handset locator)

Using this feature, you can locate the handset if misplaced.

- 1 Base unit:
Press
LOCATOR/INTERCOM.
 - The handset beeps for 1
minute.
 - To stop paging, press
LOCATOR/INTERCOM
again.
- 2 Handset:
Press **INTERCOM** to
answer.
- 3 Base unit:
Speak into the **MIC**.
- 4 Handset:
To end the intercom,
press **INTERCOM**.

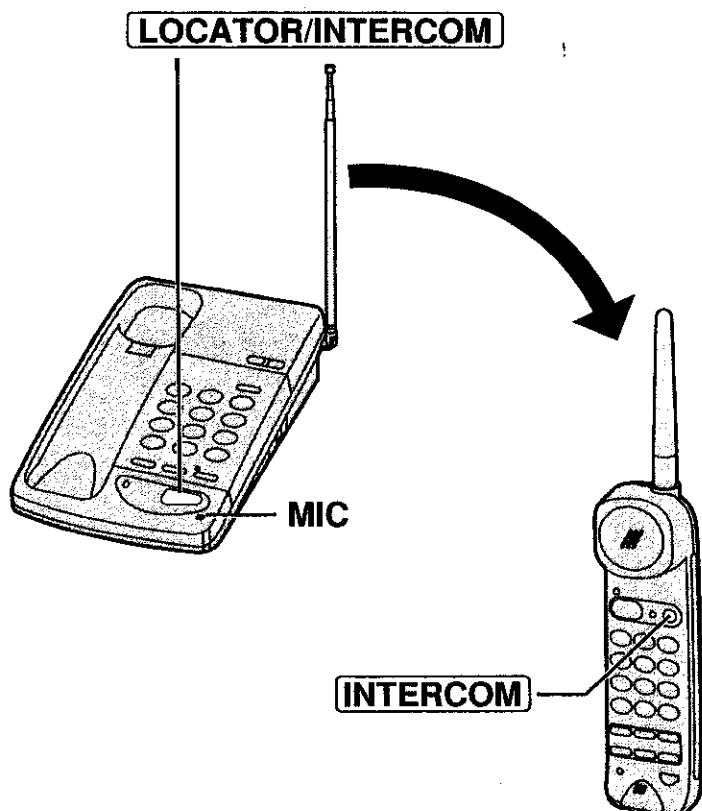

During the intercom:

- Intercom calls can only be ended by the handset.
- If the handset user has difficulty hearing the base unit user, decrease the speaker volume by pressing **∇**.
- If two tones sound, an incoming call has been received. To answer, press **TALK** or **SP-PHONE**. The intercom is ended.

Transferring a Call Using Intercom

The intercom can be used during a call. This feature enables you to transfer the call between the handset and the base unit.

From the handset to the base unit

- 1** Handset:
During a call, press **INTERCOM** then talk.
 - The call is put on hold.
- 2** Base unit:
When the paging party's voice is heard, answer through the **MIC**.
- 3** Base unit:
To answer the call, press **SP-PHONE**.
 - The transfer is completed.
 - The handset user can join the conversation by pressing **TALK**.

From the base unit to the handset

- 1** Base unit:
During a call, press **HOLD**.
 - The SP-PHONE indicator flashes.
- 2** Base unit:
Press **LOCATOR/INTERCOM**.
- 3** Handset:
Press **INTERCOM** to answer the page.
- 4** Handset:
To answer the call, press **TALK**.
 - The transfer is completed.
 - The base unit user can join the conversation by pressing **SP-PHONE**.

Special Features

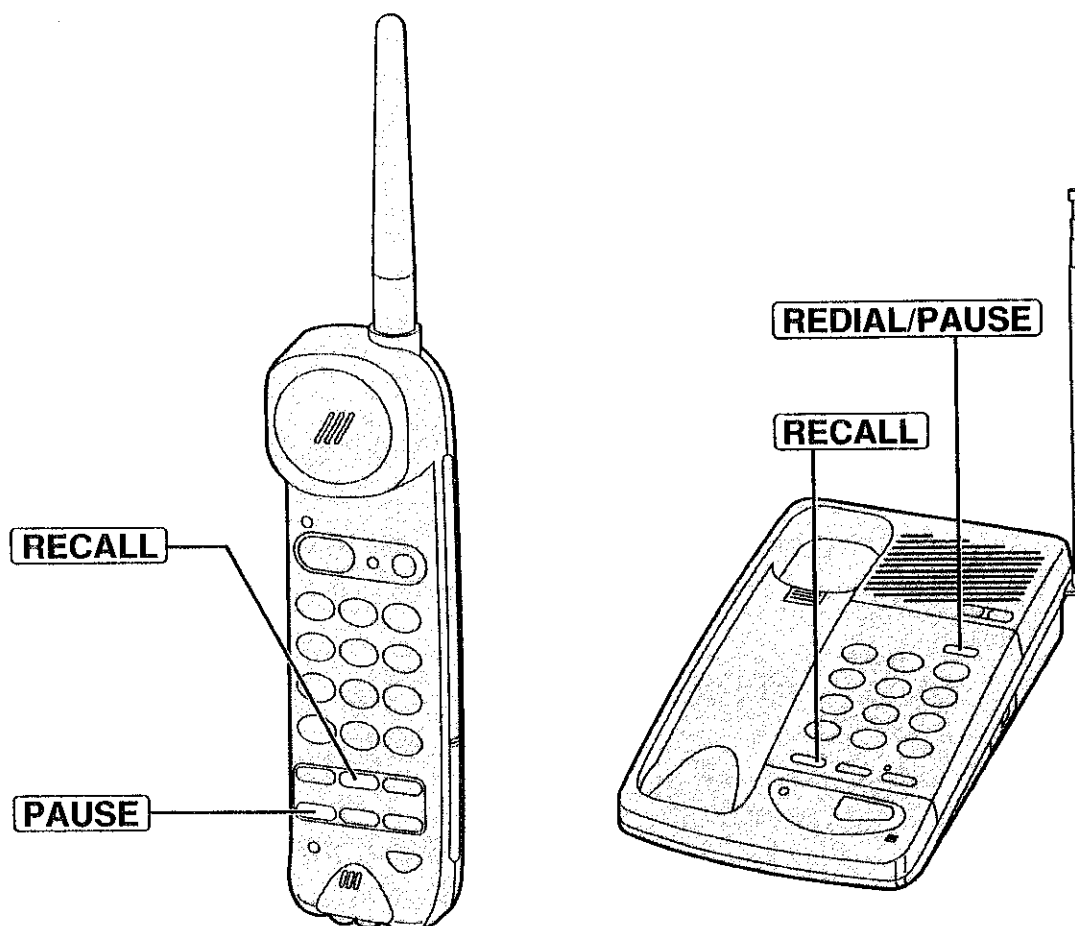

Automatic Security Code Setting

Whenever you place the handset on the base unit, the unit automatically selects one of 65,000 security codes. These codes help to avoid unauthorized use of your telephone line by another cordless telephone.

For Call Waiting Service Users

Press **RECALL** if you hear a call-waiting tone while talking.

- The first call is put on hold and you can answer the second call.
- To return to the first caller, press **RECALL** again.
- Users in New Zealand should adjust the recall time to 600 msec for use with Telecom's Call Waiting Service. See page 19 on how to adjust recall time.

If Your Unit is Connected to a PBX

We recommend you press **PAUSE** or **REDIAL/PAUSE** between the access number for an outside line and the phone number.

- Pressing **PAUSE** or **REDIAL/PAUSE** once creates a 3.5 second pause. This prevents misdialing when you redial or dial a stored number. (**PAUSE** or **REDIAL/PAUSE** counts as one digit.)

RECALL Button

Pressing **RECALL** allows you to use special features of your host PBX such as transferring an extension call or accessing special telephone services (optional) such as call waiting.

For users in New Zealand please change the recall time to 600 msec or if connecting to a PBX consult with your PBX company as to the correct setting.

Selecting the Recall Time

The recall time depends on your telephone exchange or host PBX. You can select from recall times "100, 250, 400 or 600 msec (millisecond)" by programming. The factory preset is "100 msec".

- 1 Press **PROGRAM**.
 - The BATT LOW/PROG indicator lights.
- 2 Press the dialing button (1 to 4).
 - 1: 100 msec 2: 250 msec
 - 3: 400 msec 4: 600 msec
- 3 Press **AUTO**.
- 4 Press **RECALL**.
 - A confirmation tone sounds.
(See below.)

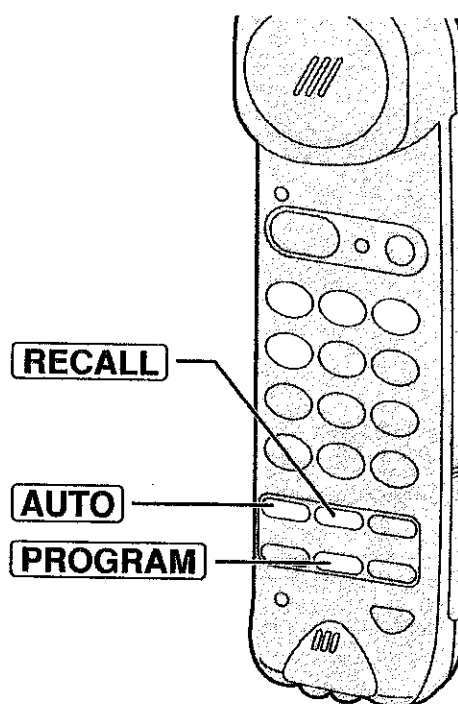

What the confirmation tone means

- 1 beep: The new number is stored.
- 2 beeps: The number is the same as a previously stored one.
- 3 beeps: The number is not correct. Move toward the base unit or place the handset on the base unit. Then try again from the beginning.

- You can access Telecom's "CALL WAITING" service by setting "600 msec".
- If the host PBX cannot be controlled, select a higher recall time.
- For details, consult with your PBX telephone company.

Battery Replacement

If the BATT LOW/PROG indicator flashes after being fully charged, replace with a new Panasonic KX-A36A battery. To prevent memory loss, replace within 5 minutes.

1 Remove the cover.

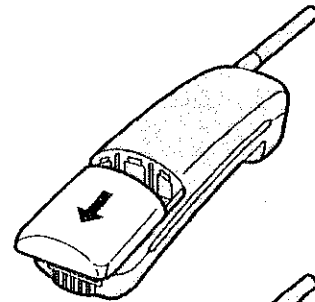

2 Replace the battery, then close the cover.

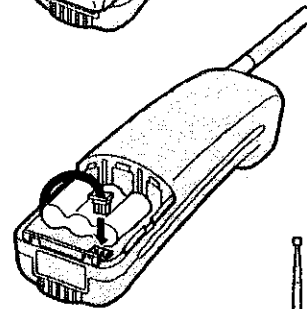

3 Charge the new battery for about 10 hours.

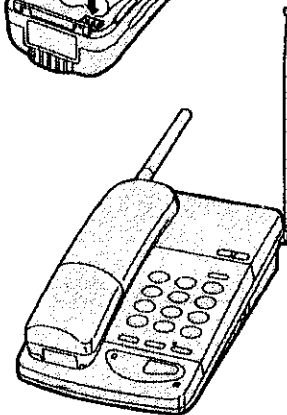

Adding Another Phone

This unit will not function during a power failure. To connect a standard telephone on the same line, use a T-adaptor.

To Single-Line
Telephone Jack

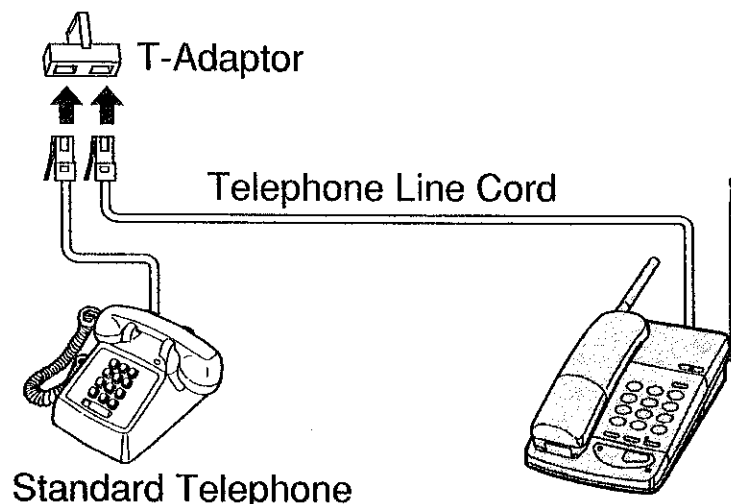

WARNINGNOTICE:

No "111" or other calls can be made from this device during a mains power failure.

- We recommend that a standard phone which can be used in the case of a power failure be connected to the telephone line at all times.

Before Requesting Help



Problem	Remedy
An alarm tone sounds when you press TALK or INTERCOM .	<ul style="list-style-type: none">• You are too far from the base unit. Move closer and try again.• Place the handset on the base unit and try again.• Plug in the AC adaptor.• Clean the charge contacts and charge again.
The unit does not work.	<ul style="list-style-type: none">• Check the setting (p. 7, 8).• Charge the battery fully.• Clean the charge contacts and charge again.• KX-T4046NZ is not designed to be used with rotary (pulse dialing) service.
Static, sound cuts in/out, fades. Interference from other electrical units.	<ul style="list-style-type: none">• Set the handset and the base unit away from other electrical appliances.• Move closer to the base unit.• Extend the base unit antenna fully.• Press CH to change the channel.
The unit stops working during operation.	<ul style="list-style-type: none">• Place the handset on the base unit and unplug the AC adaptor to reset. Plug in, then try again.
The handset does not ring.	<ul style="list-style-type: none">• The ringer volume is OFF. Press VOLUME/RINGER when the TALK indicator light is off.
The base unit does not ring.	<ul style="list-style-type: none">• The RINGER selector is set to OFF. Set to HIGH or LOW.
While using the speakerphone, the calling party complains that your voice is hard to hear.	<ul style="list-style-type: none">• Press ∇ to decrease your voice volume.

➔ Before Requesting Help

Problem	Remedy
You cannot store a phone number in memory.	<ul style="list-style-type: none">• You cannot store a number while the unit is in the talk or intercom mode.• Do not pause for over 30 seconds while storing.
While storing a phone number, the unit starts to ring.	<ul style="list-style-type: none">• To answer the call, press TALK or SP-PHONE. The program will be canceled. Store the number again.
LOCATOR/INTERCOM does not function.	<ul style="list-style-type: none">• The handset is too far from the base unit or is engaged in an outside call.
While using the intercom, two tones sound.	<ul style="list-style-type: none">• A call is being received. To answer, press TALK or SP-PHONE.
My "Call Waiting" service is not activated when the RECALL button is pressed.	<ul style="list-style-type: none">• Change the RECALL time to "600 msec" (p. 19).
REDIAL/PAUSE does not function properly.	<ul style="list-style-type: none">• The button has a double function as either redial or pause. It will redial the last dialed number if pressed at the outset of a call (p. 12). If another number has been dialed first, it will operate as a pause button (p. 18).
The BATT LOW/PROG indicator flashes or the unit beeps intermittently.	<ul style="list-style-type: none">• Charge the battery fully (p. 8).
You charged the battery fully, but the BATT LOW/PROG indicator flashes.	<ul style="list-style-type: none">• Clean the charge contacts and charge again.• Install a new battery (p. 20).
The IN USE/CHARGE indicator never goes out while charging.	<ul style="list-style-type: none">• This is normal.

Safety Instructions

Take special care to follow the safety suggestions listed below.

Safety

- 1) **Power Source:** The unit should be connected to a power supply only of the type described in the operating instructions or as marked on the unit.
- 2) **Nonuse Periods:** When left unused for a long period of time, the base unit should be unplugged from the household AC outlet.

Installations

Environment

- 1) **Water and Moisture:** Do not use this unit near water—for example, near a bath tub, washbowl, sink, etc. Damp basements should also be avoided.
- 2) **Heat:** The unit should be kept away from heat sources such as radiators, kitchen range, etc. It also should not be placed in rooms where the temperature is less than 5°C (41°F) or greater than 40°C (104°F).

Placement

- 1) **Stacking:** Do not place heavy objects on top of this unit.
- 2) **Foreign Material:** Care should be taken so that objects do not fall onto and liquids are not spilled into the unit. Do not subject this unit to excessive smoke, dust, mechanical vibration, or shock.
- 3) **Surface:** Place the unit on a flat surface.

For best performance

- 1) If noise prevents the conversation from being understood at the handset, approach the base unit to lessen the noise.
- 2) The handset should be used at the HIGH volume setting when the reception tone is difficult to hear.
- 3) The handset should be fully recharged on the base unit when the BATT LOW/PROG indicator flashes.
- 4) The handset antenna should not be touched during use because of its high sensitivity.
- 5) The maximum calling distance may be shortened when the unit is used in the following places: Near obstacles such as hills, tunnels, undergrounds, near metal objects such as wire fences, etc.

Free Manuals Download Website

<http://myh66.com>

<http://usermanuals.us>

<http://www.somanuals.com>

<http://www.4manuals.cc>

<http://www.manual-lib.com>

<http://www.404manual.com>

<http://www.luxmanual.com>

<http://aubethermostatmanual.com>

Golf course search by state

<http://golfingnear.com>

Email search by domain

<http://emailbydomain.com>

Auto manuals search

<http://auto.somanuals.com>

TV manuals search

<http://tv.somanuals.com>