

# Panasonic

Cordless Phone

Model No. **KX-T4108-B**

Pulse-or-tone dialing capability

## Operating Instructions



**SOUND CHARGER  
PLUS**

Getting Started

Basic Operation

Advanced Operation

Useful Information

**PLEASE READ BEFORE USE AND  
SAVE.**

Caller ID Compatible

**Charge the battery for 10 hours before initial use.**

# Before Initial Use

---

Please read **IMPORTANT SAFETY INSTRUCTIONS** on pages 44–45 before use. Read and understand all instructions.

*Thank you for purchasing the Panasonic cordless telephone.*

Attach your purchase receipt here.

## For your future reference

Serial No \_\_\_\_\_

(found on the bottom of the unit)

Date of purchase \_\_\_\_\_

Name of dealer \_\_\_\_\_

Dealer's address \_\_\_\_\_

## Accessories

AC Adaptor (p 10)

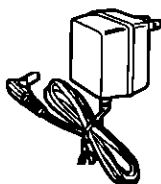

one

Telephone Line Cord (p 10)

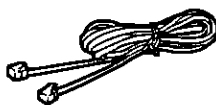

one

Wall Mounting Adaptor (p 13)

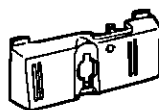

one

# For Best Performance

---

## Battery Charge

To power the handset, charge the battery for 10 hours before initial use (p 11)

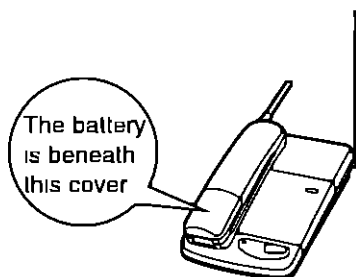

## Operating Distance/Noise

Calls are transmitted between the base unit and the handset using wireless radio waves. For maximum distance and noise free operation, the recommended base unit placement is

Away from electrical appliances such as a TV, radio, or personal computer

In a HIGH and CENTRAL location with no obstructions such as walls

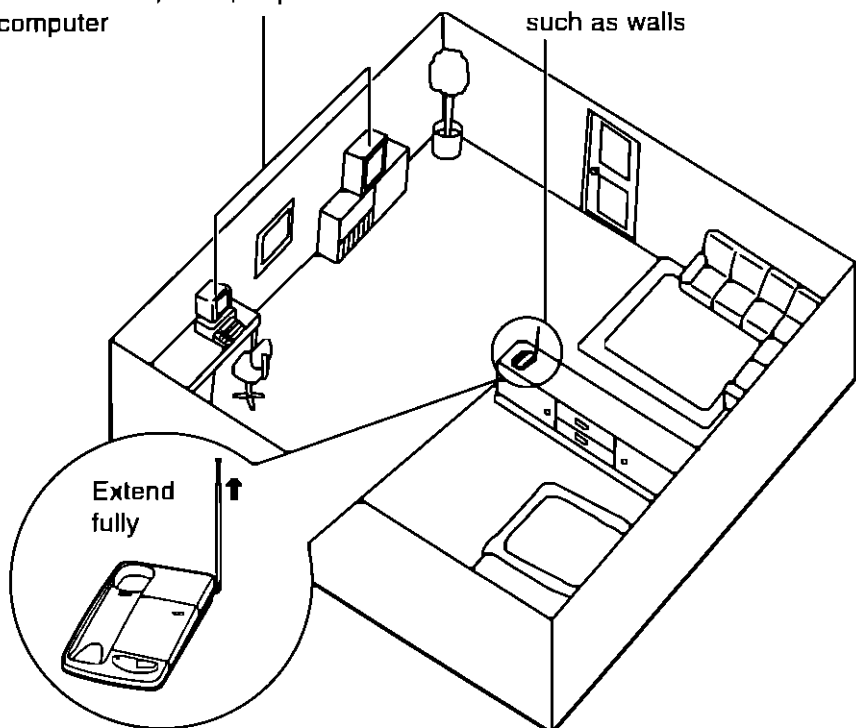

# Contents

## *Getting Started*

<b>Location of Controls</b> .....	6
<b>Display</b> .....	8
<b>Setting Up</b> .....	10
Connection .....	10
Battery Charge .....	11
<b>Wall Mounting</b> .....	13
<b>Preparation for Handset</b> .....	14
Setting the LCD Contrast .....	14
Setting the AUTO TALK Feature to ON .....	15

## *Basic Operation*

<b>Making Calls</b> .....	16
<b>Answering Calls</b> .....	18

## *Advanced Operation*

<b>Special Features</b> .....	20
Handset Locator .....	20
For Call Waiting Service Users .....	21
Temporary Tone Dialing (For Rotary Service Users) .....	21
If Your Unit is Connected to a PBX .....	21
Automatic Security Code Setting .....	21
<b>Caller ID Service</b> .....	22
<b>Using the Caller List</b> .....	24
Viewing the Caller List .....	24
Calling Back from the Caller List .....	26
Editing the Caller's Phone Number .....	27
Storing the Caller List Information in the Directory .....	28
Erasing the Caller List Information .....	29
Storing the Area Code .....	30

---

<b>Using the Directory</b> .....	32
Storing Names and Numbers in the Directory .....	32
Steps for Entering Names and Symbols .....	34
Finding Items in the Directory .....	36
Dialing from the Directory .....	37
Changing an Item in the Directory .....	38
Erasing an Item from the Directory .....	39

## *Useful Information*

<b>Battery Replacement</b> .....	40
<b>Adding Another Phone</b> .....	41
<b>Before Requesting Help</b> .....	42
<b>Important Safety Instructions</b> .....	44
<b>FCC and Other Information</b> .....	46

# Location of Controls

## Handset

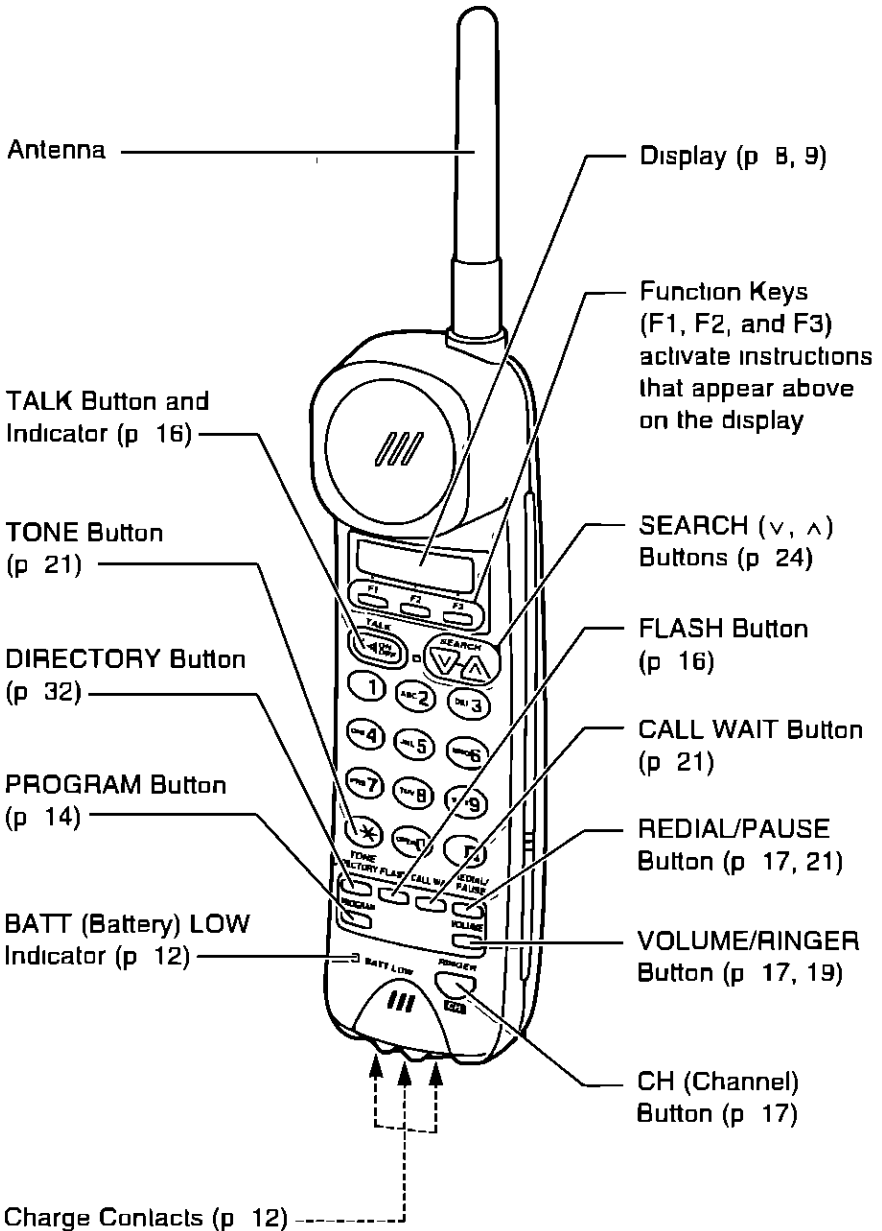

## Base unit

Antenna (p 3, 10)

CALLER ID Indicator (p 24)

DIALING MODE Selector (p 10)

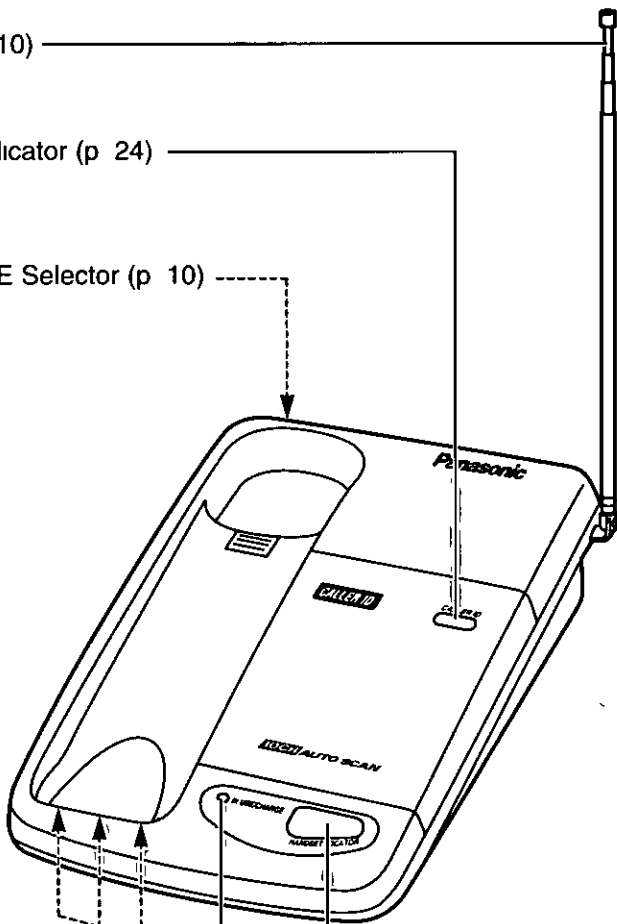

Charge Contacts  
(p 12)

IN USE/CHARGE  
Indicator (p 11, 20)

HANDSET LOCATOR  
Button (p 20)

# Display

---

The handset gives you instructions and information on the display. These are the display prompts on pages 8, 9.

In the battery saver mode, the display is blank until you use the handset (p 11)

12 NEW CALLS  
BATT

The display shows the number of new calls in the stand-by mode. To check the battery strength, press **(F1)** (BATT key).

1112222  
01-06-35

During a conversation, the display counts the call duration.  
(Ex: 1 hour, 6 minutes 35 seconds)

OUT OF RANGE

The handset has lost communication with the base unit (p 42)

BATTERY ( ■ )

When you press **(F1)** (BATT key), the display shows the present battery strength (p 11).  
(Ex: The battery strength is low)

SUSAN HAMMER  
DIAL CLEAR NO

This is a name from the Caller List information. Use the function keys as you need.

021-111-??22  
DIAL EDIT DATE

The received caller's phone number has an error (?).

OUT OF AREA

The caller dialed from an area which does not provide the Caller ID service.

PRIVATE CALLER

The caller has requested not to deliver their information.



END OF NEW CALL  
EXIT

You finished viewing the NEW CALLS in the Caller List To exit, press **(F3)** (EXIT key)

END  
EXIT

At the end of the Caller List when you are pressing **(SEARCH)** (v, ^) To exit, press **(F3)** (EXIT key)

NO CALLERS  
EXIT

The Caller List is empty To exit, press **(F3)** (EXIT key)

ANNE  
DIAL NO

This is a name from the directory item Use the function keys as you need

NO ITEM STORED

There's no stored item at a dialing button you pressed in the directory

MEMORY IS FULL  
CLEAR EXIT

During a storing procedure, the display shows the directory memory is full

SAVE ERROR

During a programming procedure, the handset has lost communication with the base unit Move closer to the base unit

# Setting Up

## Connection

USE ONLY Panasonic AC ADAPTOR KX-A11 The adaptor must remain connected at all times

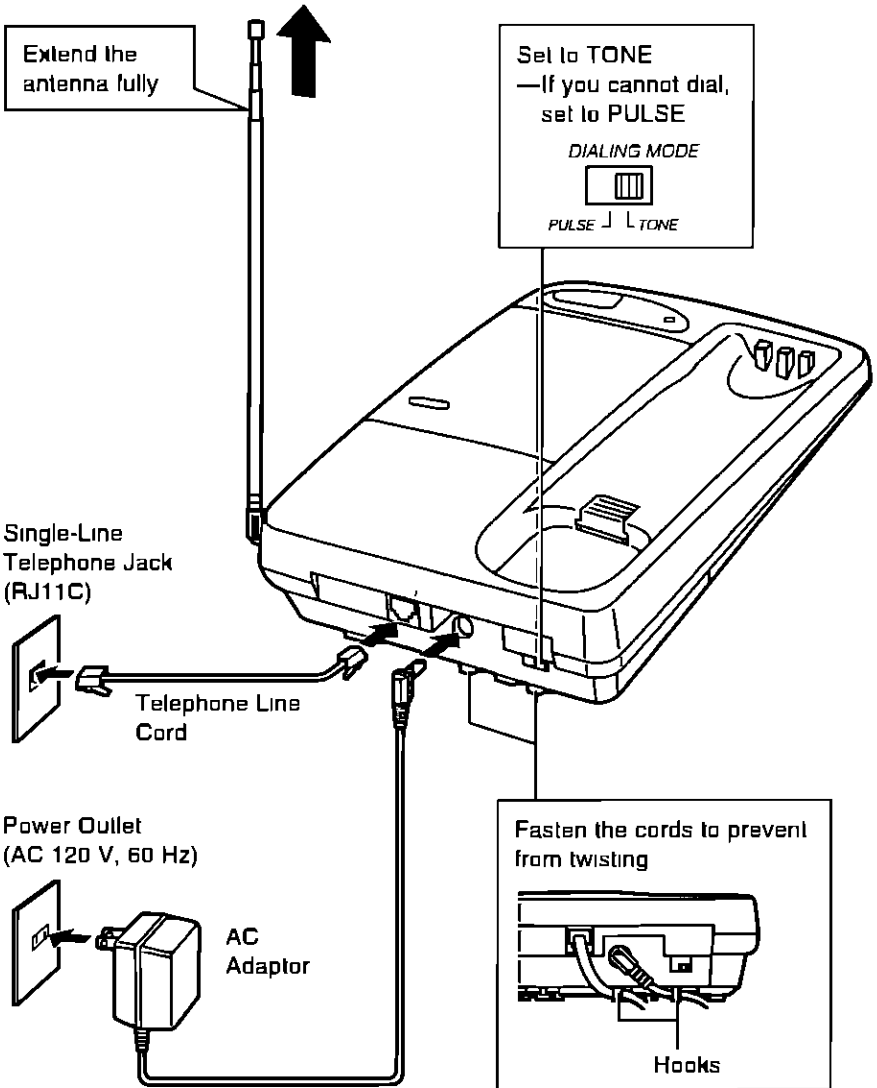

### Notes

- The AC adaptor may feel warm during use This is normal
- If you connect a reserve telephone on the same line, see page 41

## Battery Charge

Place the handset on the base unit for 10 hours

—The IN USE/CHARGE indicator lights

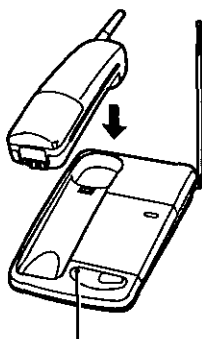

IN USE/CHARGE Indicator

## Battery saver mode

The handset goes into battery saver mode 5 minutes after you finished using the handset (ex such as making a call, viewing the caller list, etc )

In this mode, the display is blank, but the handset receives calls  
To exit the battery saver mode, use the handset again. The display automatically 'wakes up' from 'sleeping'

## To check the battery strength

You can check the present battery strength while the handset is in the battery saver or stand-by mode

Press **F1** (BATT key)

—If the display is blank, press one of the function keys to turn the display on

The display shows the present battery strength as shown in the chart below

Display prompt	Battery strength
{■■■■}	Fully charged
{■■■}	Medium
{■■}	Low

## ► Setting Up

### Recharge

When the BATT LOW indicator flashes or beeps intermittently, recharge the battery

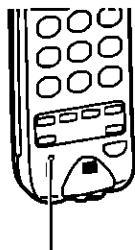

BATT LOW Indicator

### Standard battery life

If your Panasonic battery is fully charged,

While in use (TALK)	Up to about 8 hours
While not in use (Stand-By)	Up to about 14 days

- Battery life may vary depending on usage conditions and ambient temperature
- Clean the charge contacts with a soft cloth once a month, or the battery may not charge properly**
- Once the battery is fully charged, you do not have to place the handset on the base unit until the BATT LOW indicator flashes
- The battery cannot be overcharged

# Wall Mounting

This unit can be mounted on a wall phone plate

- 1** Reverse the handset hook in the cradle so the tab holds the handset

- ① Push to remove
- ② Rotate 180°
- ③ Replace it with the tab facing upwards

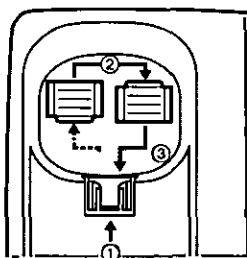

- 2** Connect the AC adaptor  
Tuck the telephone line cord inside the wall mounting adaptor, then push it in the direction of the arrow

—The word “UP” should face upward

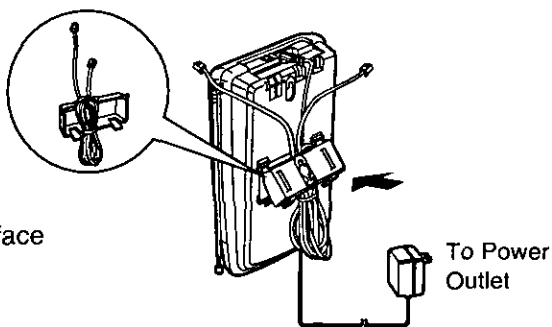

- 3** Connect the telephone line cord  
Mount the unit, then slide down

—Extend the antenna fully

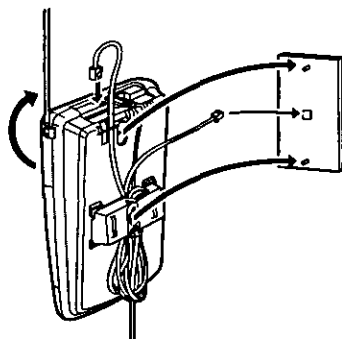

- 4** To charge the battery:  
Place the handset on the handset hook as shown

—The IN USE/CHARGE indicator lights

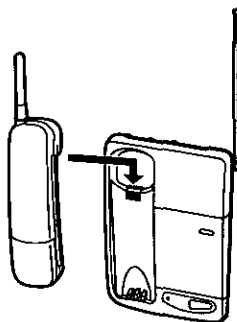

# Preparation for Handset

---

## Setting the LCD Contrast

You can select the LCD contrast among 3 levels (DARK, NORMAL and LIGHT) NORMAL is the factory setting

- 1 Press **PROGRAM**
- 2 Press **F3** (NEXT key)
- 3 Press **F1** (YES key)  
—The current setting flashes on the display
- 4 Select the desired level by pressing one of the function keys  
To select DARK, press **F1** (DARK key)  
To select NORMAL, press **F2** (NORM key)  
To select LIGHT, press **F3** (LIGHT key)  
—The selected setting flashes on the display  
—After a few seconds, the handset returns to the stand-by mode

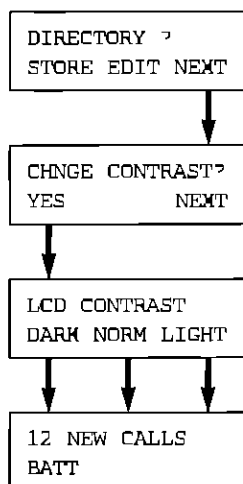

### Note:

- To cancel the programming halfway, press **PROGRAM** Then restart from step 1

## Setting the AUTO TALK Feature to ON

If you set the AUTO TALK feature to ON, you can answer a call by lifting the handset on the base unit without pressing **TALK**. If you want to use this feature, program as follows. OFF is the factory setting.

- 1 Press **PROGRAM**
- 2 Press **F3** (NEXT key) twice until "TALK SWITCHING?" is displayed
- 3 Press **F1** (CHNG key)
  - The current setting flashes on the display
- 4 Press **F1** (ON key)
  - The selected setting flashes on the display
  - After a few seconds, the handset returns to the stand-by mode

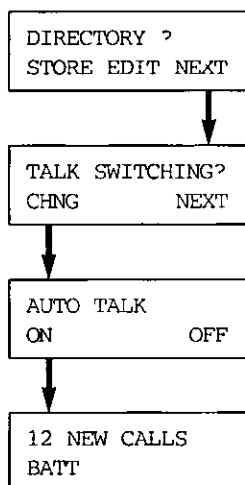

### Notes:

- To cancel the programming halfway, press **PROGRAM**. Then restart from step 1.
- In order to be able to view Caller ID information before answering a call, leave the AUTO TALK feature OFF.
- To set the AUTO TALK feature to OFF, press **F3** (OFF key) in step 4.

# Making Calls

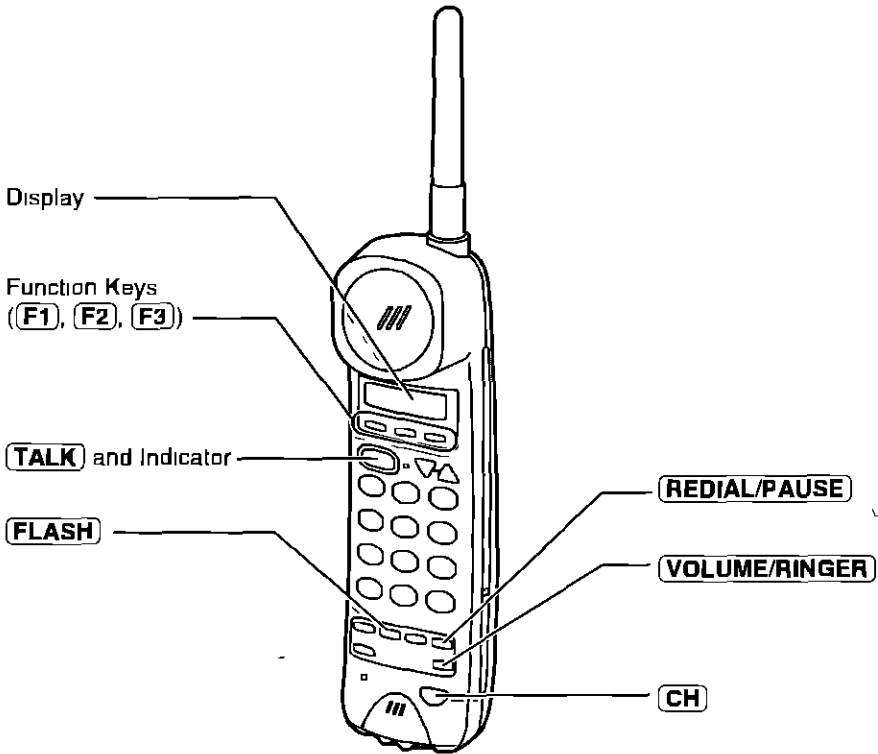

**1** Press **TALK**  
—The indicator lights

**2** Dial a phone number  
—The dialed number is displayed  
—The display starts counting the call duration  
—If you misdial, press **FLASH** firmly then dial again

0001112222

0001112222  
00-00-00

**3** To hang up,  
press **TALK** or place the handset on the base unit  
—The indicator light goes out



### Note:

- If “OUT OF RANGE” is displayed and an alarm tone sounds in step 1, move closer to the base unit or place the handset on the base unit. Then try again.

## To dial after confirming the entered number

- 1 Enter a phone number
  - If you enter a wrong number, press **(F2)** (DELET key) to make a correction by one digit from the right side
  - To cancel, press **(F3)** (EXIT key)
- 2 Press **(F1)** (DIAL key)
  - The display starts counting the call duration

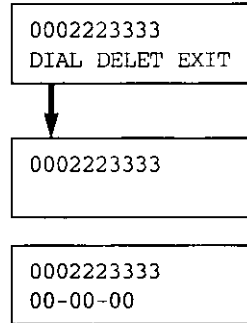

## To redial the last number

Press **(TALK)**, then **(REDIAL/PAUSE)**

## To select the receiver volume

You can select the receiver volume between HIGH and NORMAL during a call. NORMAL is the factory setting.

Press **(VOLUME/RINGER)**

- Each time you press, you hear the next volume setting.

## If noise interferes with the conversation

Press **(CH)** to select a clear channel or move closer to the base unit.

- The selected channel number is displayed.

# Answering Calls

---

If you subscribe to the Caller ID service, the display shows a caller information when a call is received (p 23)

- 1 Press **TALK**
- 2 To hang up, press **TALK** or place the handset on the base unit

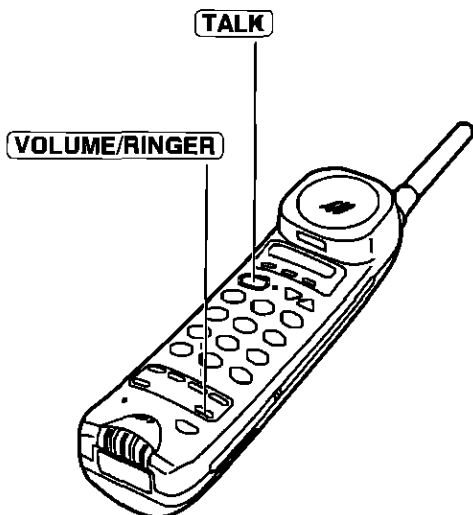

## Auto Talk

If you set the AUTO TALK feature to ON, you can answer a call by lifting the handset on the base unit without pressing **TALK** (p 15)

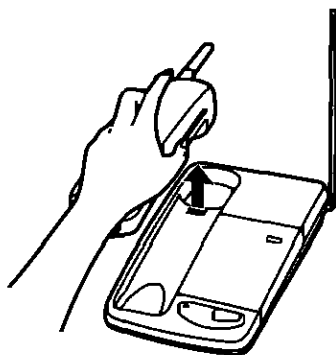

---

## Any Key Talk

You can also answer a call by pressing any dialing button (0 to 9, \*, or #)

## To select the ringer volume

You can select the ringer volume among 3 levels (HIGH, LOW, and OFF) while the handset is in the battery saver or stand-by mode. HIGH is the factory setting.

- 1 Press **VOLUME/RINGER**
  - The current setting flashes on the display
- 2 Select the desired level by pressing one of the function keys
  - To select HIGH, press **F1** (HIGH key)
  - To select LOW, press **F2** (LOW key)
  - To select OFF, press **F3** (OFF key), then **F1** (YES key)
  - The selected setting flashes on the display
  - If you select ringer OFF, the display shows "RINGER OFF" before the handset goes into the battery saver mode

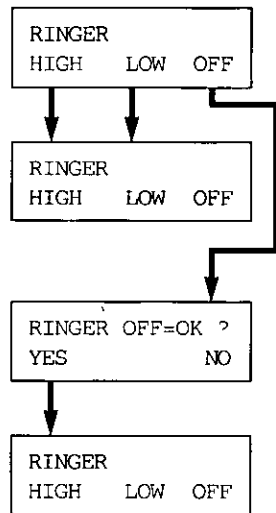

# Special Features

---

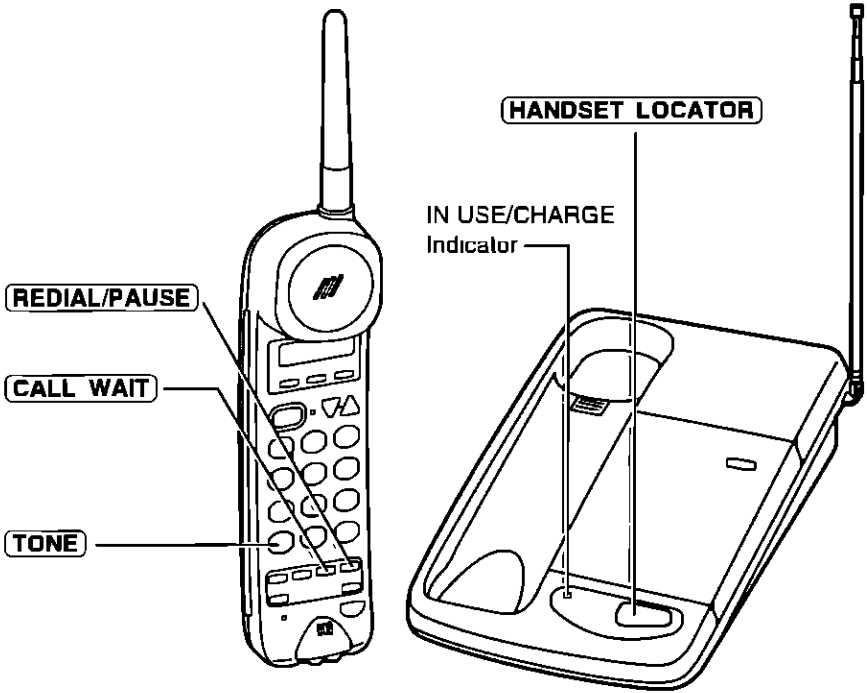

## Handset Locator

You can locate the handset or page a person at the handset with beep tones

Press **HANDSET LOCATOR**

- The handset beeps for 1 minute
- The IN USE/CHARGE indicator flashes

To stop paging, press **HANDSET LOCATOR** again or press **TALK** on the handset twice

---

## For Call Waiting Service Users

- If you hear a call-waiting tone during a call, press **CALL WAIT**.
- The first call is put on hold and you can answer the second call.
  - To return to the first caller, press **CALL WAIT** again.

## Temporary Tone Dialing (For Rotary Service Users)

- Press **TONE** before dialing.
- The dialing mode changes to tone. You can enter numbers to access answering systems, electronic banking services, etc. When you hang up, the mode returns to pulse.

## If Your Unit is Connected to a PBX

- We recommend you press **REDIAL/PAUSE** between the access number for an outside line and the phone number.
- Pressing **REDIAL/PAUSE** once makes a 3.5-second pause. This prevents misdialing when you redial or dial a stored number.

## Automatic Security Code Setting

Whenever you place the handset on the base unit, the unit automatically selects one of 65,000 security codes. These codes help avoid unauthorized use of your telephone line by another cordless telephone.

# Caller ID Service

This unit is compatible with the Caller ID service offered by your local telephone company.

Once you subscribe to the Caller ID service, the information of the party calling you will be displayed after the first ring. You can decide whether to answer it or not after confirming who is calling you.

The unit records information from up to 30 callers, including time and date when these were received, in the Caller List. The Caller List information is sorted from the latest to the oldest call received and when memory is full the unit will automatically erase the oldest call so that the next call is recorded.

Using the list, you can quickly respond to your caller without checking their phone number. Also, you can store the caller's name and number from the Caller List to the directory, to save time dialing or even checking the number in the future.

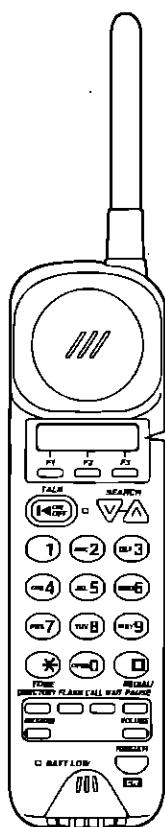

## When you have received 10 new calls:

Press one of the function keys to turn the display on.

The display shows the number of new calls.

10 NEW CALLS  
BATT

After you view the new caller information in the list, the display shows "0".

0 NEW CALL  
BATT

---

## How caller information is displayed when a call is received

- 1 When a call is received, the display shows the caller's name and number after the first ring.

TINA ROBINSON  
000-222-3333

- 2 To answer the call, press **TALK**.  
—The display starts counting the call duration.

TINA ROBINSON

TINA ROBINSON  
00-00-00

### Notes:

- When the unit is connected to a PBX system, you may not receive caller information. Please consult your equipment supplier.
- In some calling areas, the name display service is not executed. For further information, please contact your local telephone company.
- The Caller ID service is currently provided in calling areas by caller identification technology. In some cases, caller information cannot be delivered. In this case, the display will show as follows.

OUT OF AREA

The caller dialed from an area which does not provide the Caller ID service.

PRIVATE CALLER

The caller has requested not to deliver their information.

# Using the Caller List

## Viewing the Caller List

If new calls are received, the CALLER ID indicator flashes slowly on the base unit and the number of new calls with "NEW CALLS" are displayed on the handset. When you get home, confirm the CALLER ID indicator on the base unit or press one of the function keys to check the handset display. You can confirm who has called you as follows:

**1** Press **SEARCH** ( $\vee$  or  $\wedge$ ) once to enter the list

—The newest caller information is displayed

**2** Press **SEARCH** ( $\vee$  or  $\wedge$ ) to move up and down between callers

Press **F3** to move between name, number and time date information

**3** To exit the list, press **F3** (EXIT key) or wait 10 seconds

—The handset returns to the stand-by mode

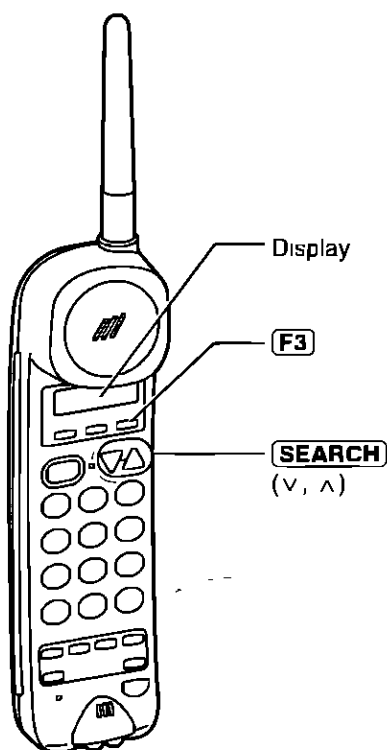

### Notes:

- When you answer a call, the caller information is listed, but is not considered NEW
- Once NEW calls have been checked, they are no longer NEW. The next calls will be listed as NEW
- If more than one call is received from the same caller, the date and time of the last call will be stored
- During a power failure the unit will retain the recorded calls for approximately 1 day





## Ex. When you have received a new call:

1 NEW CALL  
BAIT

Press **(SEARCH)** (v or ^) to enter the list.

To move down between callers, press v (▼).  
To move between name, number, and time date information, press **(F3)** (↔).

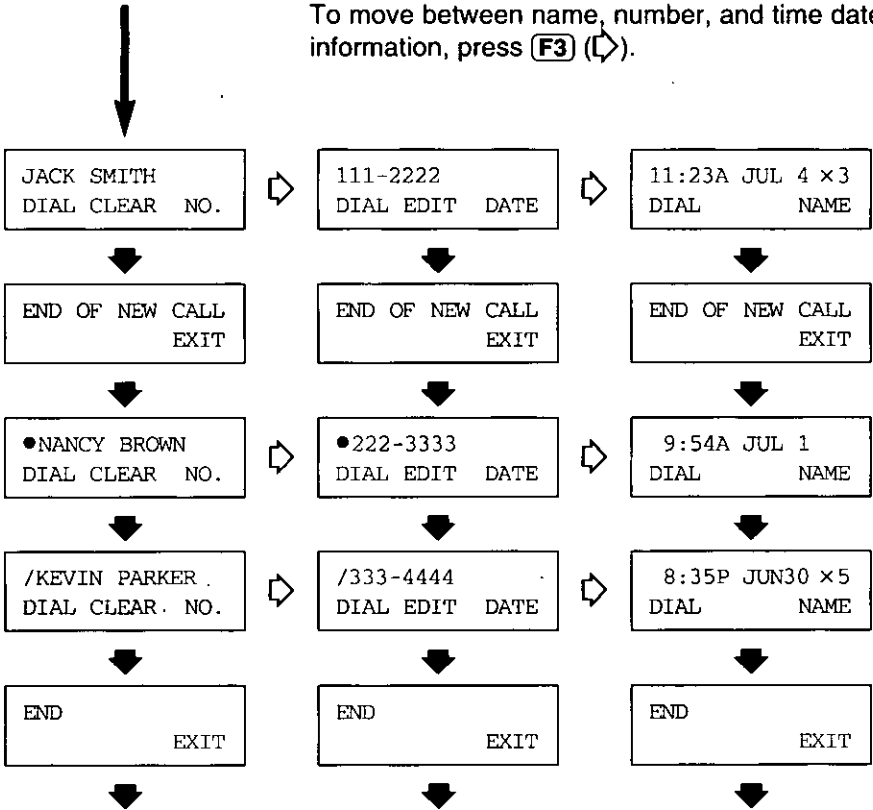

You have finished scrolling down the Caller List once.  
If you press ^, the display returns to the newest caller information.

To exit the Caller List, press **(F3)** (EXIT key) or wait 10 seconds.  
—The handset returns to the stand-by mode.

### Definition of the special marks

- : You have viewed the caller more than once.
- /: It means the caller you called back.
- ×2-×9: The unit counts the number of called times (up to 9).

## ► Using the Caller List

---

### Calling Back from the Caller List

1 Press **SEARCH** (v or ^) once to enter the list

3 NEW CALLS  
BATT

2 Press **SEARCH** (v or ^) repeatedly to search for the desired caller

CINDY TURNER  
DIAL CLEAR NO

3 Press **F1** (DIAL key)  
—The unit obtains a dial tone and automatically dials the displayed phone number

123-456-7890

123-456-7890  
00-00-00

#### Note

—Sometimes you must edit a number before it can be dialed (for example, you may have to add “1” to dial long distance) Changes are not saved in the Caller List (p 27)



## Editing the Caller's Phone Number

The unit edits a phone number into one of 4 patterns by pressing **(F2)** (EDIT key)

- 1 Press **(SEARCH)** (v or ^) once to enter the list
- 2 Press **(SEARCH)** (v or ^) repeatedly to search for the desired caller
- 3 Press **(F3)** (NO key) to display the caller's phone number
- 4 Press **(F2)** (EDIT key) to select an edit pattern  
Each time you press **(F2)** (EDIT key), the phone number is rearranged into a different edit pattern. There are 4 patterns to choose from  
—The underlined part of the area code will flash. You can change the area code by pressing the correct number using the dialing buttons
- 5 Once the edit procedure is completed, continue with storing or call back procedure steps  
To call back, press **(F1)** (DIAL key) (p 26)  
To store information in the directory, press **(PROGRAM)**, then follow the instructions on the display (p 28)

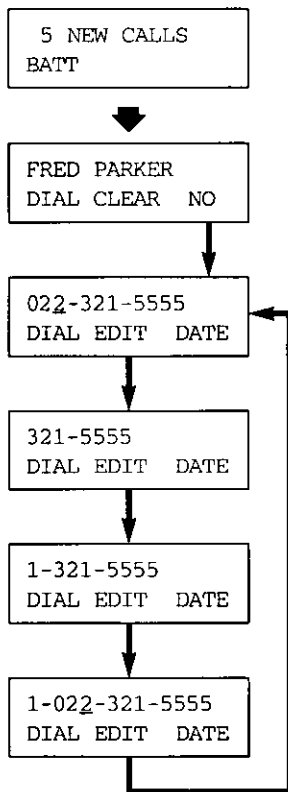

## ► Using the Caller List

### Storing the Caller List Information in the Directory

You can store the caller's name and number from the Caller List to the directory.

1 Press **SEARCH** (v or ^) once to enter the list.

10 NEW CALLS  
BATT

2 Press **SEARCH** (v or ^) repeatedly to search for the caller you want to store in the directory.

0123333  
DIAL EDIT DATE

—If the phone number requires editing, make the required changes (p. 27).

3 Press **PROGRAM**.

SAVE DIRECTORY?  
YES NO

4 Press **F1** (YES key).

—Programming is complete and the display shows "SAVED OK".

SAVING...

**If the caller information you want to store does not have name information, just follow the instructions on the display.**

a) If you do not enter a name, press **F3** (NO key).

SAVE NAME ?  
YES NO

b) If you enter a name, press **F1** (YES key). Then enter the name (p. 34).  
—When finished, press **F3** (SAVE key).

ENTER NAME  
NO.

#### Notes:

—If the display shows "MEMORY IS FULL" in step 3, press **F1** (CLEAR key) to erase other stored items from the directory (p. 39).

—If the display shows "SAVE ERROR", move closer to the base unit and try again. If "SAVE ERROR" still remains, place the handset on the base unit. Then reprogram from step 1.



## Erasing the Caller List Information

After you check the Caller List information, you can erase some or all of them.

### To erase a specific Caller List information

- 1 Press **SEARCH** (v or ^) once to enter the Caller List.
- 2 Press **SEARCH** (v or ^) repeatedly to search for the desired caller.
- 3 Press **F2** (CLEAR key).
- 4 Press **F1** (YES key).
  - The information is erased and the display shows "CLEAR".
  - After a few seconds, the display shows the previous caller information.

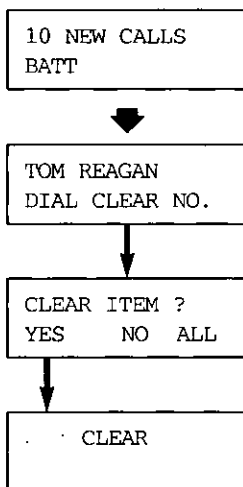

### To erase all of the Caller List information

- 1 Press **SEARCH** (v or ^) once to enter the Caller List.
- 2 Press **F2** (CLEAR key).
- 3 Press **F3** (ALL key).
- 4 Press **F1** (YES key).
  - All of the information is erased and the display shows "ALL CLEAR".
  - After a few seconds, the handset returns to the stand-by mode.

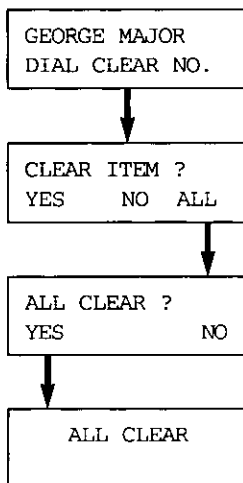

## ► Using the Caller List

### Storing the Area Code

You can store your area code so that incoming local calls are recorded in the Caller List without it. You do not have to remove the area code before storing or call back procedure steps. To program this feature, follow the steps below.

- 1 Press **PROGRAM**
- 2 Press **F3** (NEXT key) three times until "SAVE AREA CODE?" is displayed
- 3 Press **F1** (YES key)  
—To cancel, press **F3** (EXIT key)
- 4 Enter your area code  
—If you enter a wrong number, press **F1** (CANCEL key), then enter the correct number
- 5 When finished, press **F3** (SAVE key)  
—The number is saved and the display shows "SAVED OK"

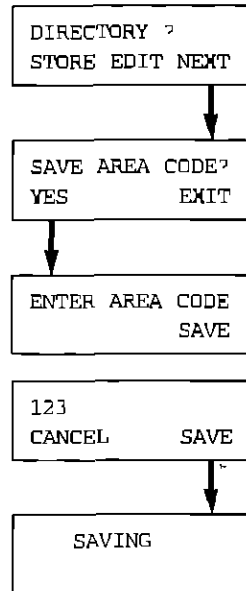

#### Note:

—To cancel the programming halfway, press **PROGRAM**. Then restart from step 1.

---

## To erase the saved area code

- 1 Press **PROGRAM**
- 2 Press **F3** (NEXT key) three times until "SAVE AREA CODE?" is displayed
- 3 Press **F1** (YES key)
- 4 Press **F3** (SAVE key)  
—The saved number is erased and the display shows "SAVED OK"

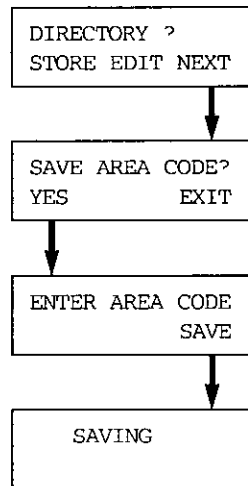

### Note:

—To cancel the programming halfway, press **PROGRAM**. Then restart from step 1.

# Using the Directory

You can store up to 30 names and phone numbers in the directory. All directory items are sorted by the first word in alphabetical order. You can enter a first or last name. Using the directory, you can make a call by selecting a name on the display. If you don't enter a name, the item is sorted by number.

## Storing Names and Numbers in the Directory

You can store a name and number while the handset is in the battery saver or stand-by mode.

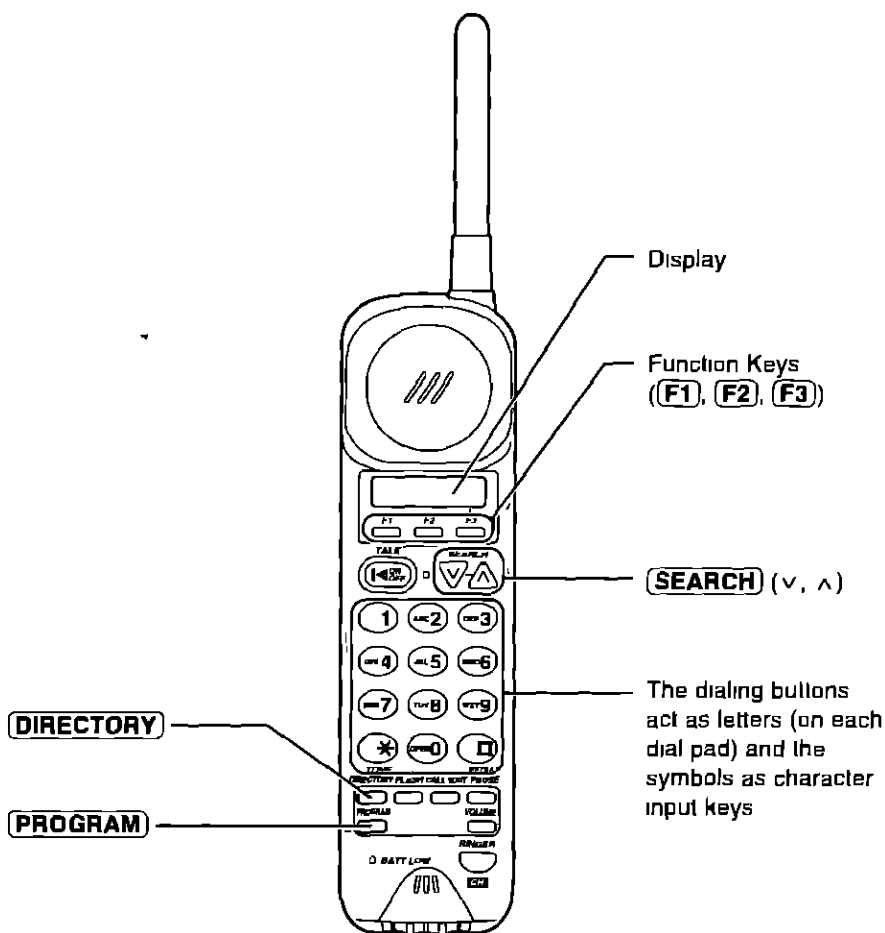





- 1 Press **PROGRAM**
- 2 Press **F1** (STORE key)
  - The display shows the number of stored items in the directory
- 3 Enter a name up to 15 characters with the dialing buttons, **F1** (←) and **F2** (→)
  - See the Steps for entering names and symbols (p 34)
- 4 When finished, press **F3** (NO key)
- 5 Enter a phone number up to 16 digits
  - If you enter a wrong number, press **F1** (CANCEL key), then enter the correct number
  - You can enter a hyphen by pressing **F2** A hyphen counts as one digit
- 6 When finished, press **F3** (SAVE key)
  - The item is saved and the display shows “SAVED OK”

DIRECTORY ?  
STORE EDIT NEXT

DIRECTORY =  
12 ITEMS

ENTER NAME  
NO

ADAMS  
← → NO

ENTER PHONE NO  
-

0987654321  
CANCEL - SAVE

SAVING

### Notes:

- To cancel the programming halfway, press **PROGRAM** Then restart from step 1
- If the display shows “MEMORY IS FULL” in step 2, press **F1** (CLEAR key) to erase other stored items from the directory (p 39)
- If you want to store only a phone number, skip over step 3, then continue with step 4
- If the display shows “SAVE ERROR”, move closer to the base unit and try again If “SAVE ERROR” still remains, place the handset on the base unit Then reprogram from step 1
- During a power failure the unit will retain the information for approximately 1 day

## ► Using the Directory

### Steps for Entering Names and Symbols

The dialing buttons can be used as letters and symbols as character input keys. Pressing each button alternately selects a character as shown below.

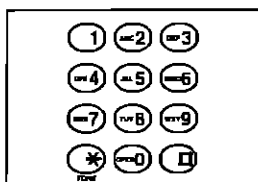

Keys	Number of pressing times								
	1	2	3	4	5	6	7	8	9
①	&	'	(	)	,	-	.	/	1
②	A	B	C	a	b	c	2		
③	D	E	F	d	e	f	3		
④	G	H	I	g	h	i	4		
⑤	J	K	L	j	k	l	5		
⑥	M	N	O	m	n	o	6		
⑦	P	Q	R	S	p	q	r	s	7
⑧	T	U	V	t	u	v	8		
⑨	W	X	Y	Z	w	x	y	z	9
⑩	0	Blank							
*	*								
#	#								



## For example, enter "Tom Jones":

During entering names, the underlined part will flash on the display

1 Press **[8]**

T	←	→	NO
---	---	---	----

2 Press **[6]** six times, then press **[F2]** (→) to move the cursor to the right 

To_	←	→	NO
-----	---	---	----

3 Press **[6]** four times 

Tom	←	→	NO
-----	---	---	----

4 Press **[F2]** (→) twice to enter a blank 

Tom _	←	→	NO
-------	---	---	----

5 Press **[5]**

Tom J	←	→	NO
-------	---	---	----

6 Press **[6]** six times, then press **[F2]** (→) to move the cursor to the right 

Tom Jo_	←	→	NO
---------	---	---	----

7 Press **[6]** five times 

Tom Jon	←	→	NO
---------	---	---	----

8 Press **[3]** five times 

Tom Jone	←	→	NO
----------	---	---	----

9 Press **[7]** eight times 

Tom Jones	←	→	NO
-----------	---	---	----

### Note:

- If you make a mistake while entering names, use **[F1]** (←) or **[F2]** (→) to move the cursor to the incorrect character, then make the correction
- You can delete one digit by pressing **[0]** twice to enter a blank

## ► Using the Directory

### Finding Items in the Directory

- 1 Press **DIRECTORY**
- 2 Press the dialing button of the first letter of the desired name repeatedly (see Index table on page 37)  
Ex To find Frank, press **3** repeatedly until the first item under "F" is displayed
- 3 Press **SEARCH** ( $\vee$  or  $\wedge$ ) to move up and down between items  
Press **F3** to move between name and number
- 4 To leave the directory at any time, press **DIRECTORY**

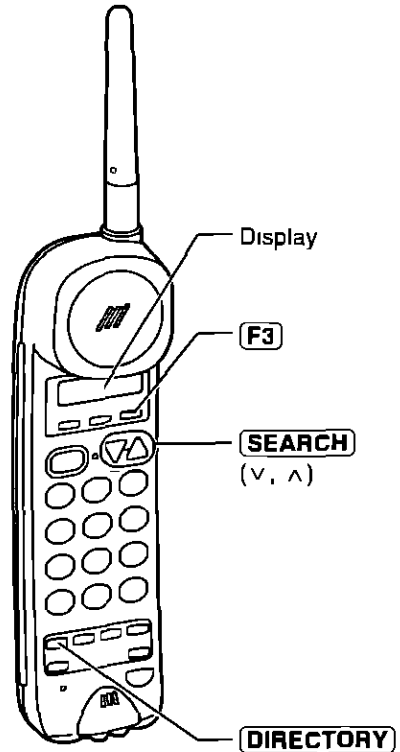

#### Note:

—The item without name information is sorted by number



Keys	Index	Keys	Index
①	1, other symbols	⑦	P, Q, R, S, 7
②	A, B, C, 2	⑧	T, U, V, 8
③	D, E, F, 3	⑨	W, X, Y, Z, 9
④	G, H, I, 4	⑩	0
⑤	J, K, L, 5	*	*
⑥	M, N, O, 6	#	#

## Dialing from the Directory

- 1 Press **DIRECTORY**
- 2 Find the directory item that you want to dial (p 36)
- 3 Press **F1** (DIAL key)  
—The unit obtains a dial tone and automatically dials the number

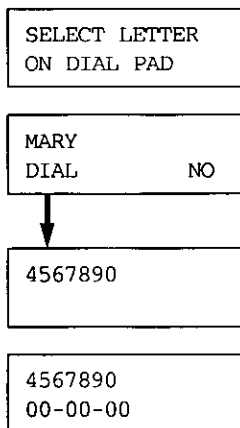

## ► Using the Directory

### Changing an Item in the Directory

- 1 Press **PROGRAM**
- 2 Press **F2** (EDIT key)
- 3 Find the directory item you want to change (p 36)  
Ex "Jane" is changed
- 4 a) If you need to change the name, press **F3** (CHNG key) and change the name with the dialing buttons, **F1** (←) and **F2** (→)  
b) If you don't need to change the name, press **F2** (NO key), then **F3** (CHNG key) and skip to step 7
- 5 When finished, press **F3** (NO key)
- 6 Press **F1** (YES key)  
—If you don't need to change the number, press **F3** (NO key) and programming is complete  
The display shows "SAVED OK"
- 7 Enter the new number up to 16 digits
- 8 When finished, press **F3** (SAVE key)  
—The changed item is saved and the display shows "SAVED OK"

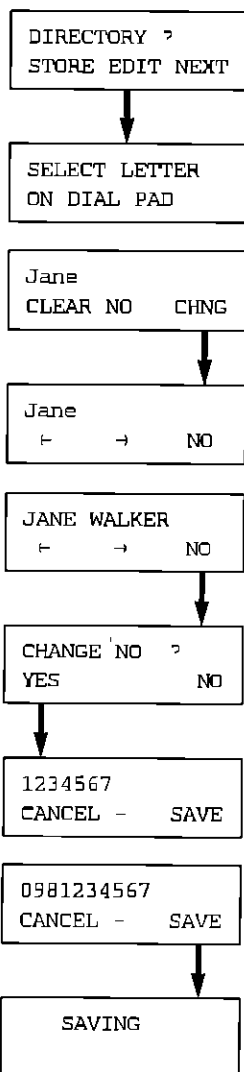

**Notes:**

- To cancel the programming halfway, press **PROGRAM** Then restart from step 1
- If the display shows "SAVE ERROR", move closer to the base unit and try again If "SAVE ERROR" still remains, place the handset on the base unit Then reprogram from step 1

## Erasing an Item from the Directory

- 1 Press **PROGRAM**
- 2 Press **F2** (EDIT key)
- 3 Find the directory item you want to erase (p 36)  
Ex "Helen" is erased
- 4 Press **F1** (CLEAR key)
- 5 Press **F1** (YES key)  
—The item is erased and the display shows "CLEAR"  
—To cancel, press **F3** (NO key)

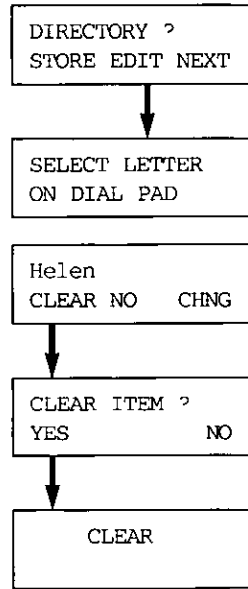

**Note:**

- To cancel the programming halfway, press **PROGRAM** Then restart from step 1

# Battery Replacement

---

If the BATT LOW indicator flashes after being fully charged, replace with a new Panasonic KX-A36A battery (To order, call 1-800-332-5368 ) To prevent memory loss, replace within 5 minutes

- 1 Remove the cover

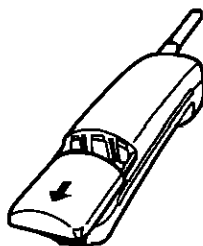

- 2 Replace the battery, then close the cover

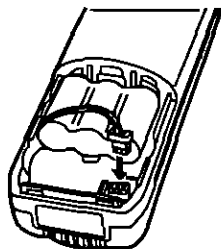

- 3 Charge the new battery for 10 hours

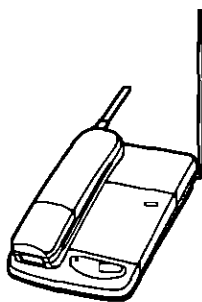

## Attention:

The product that you have purchased contains a rechargeable battery. The battery is recyclable. At the end of its useful life, under various state and local laws, it may be illegal to dispose of this battery into the municipal waste stream. Check with your local solid waste officials for details in your area for recycling options or proper disposal.





# Adding Another Phone

This unit will not function during a power failure. To connect a standard telephone on the same line, use a Panasonic T-adaptor KX-J66 (To order, call 1-800-332-5368 )

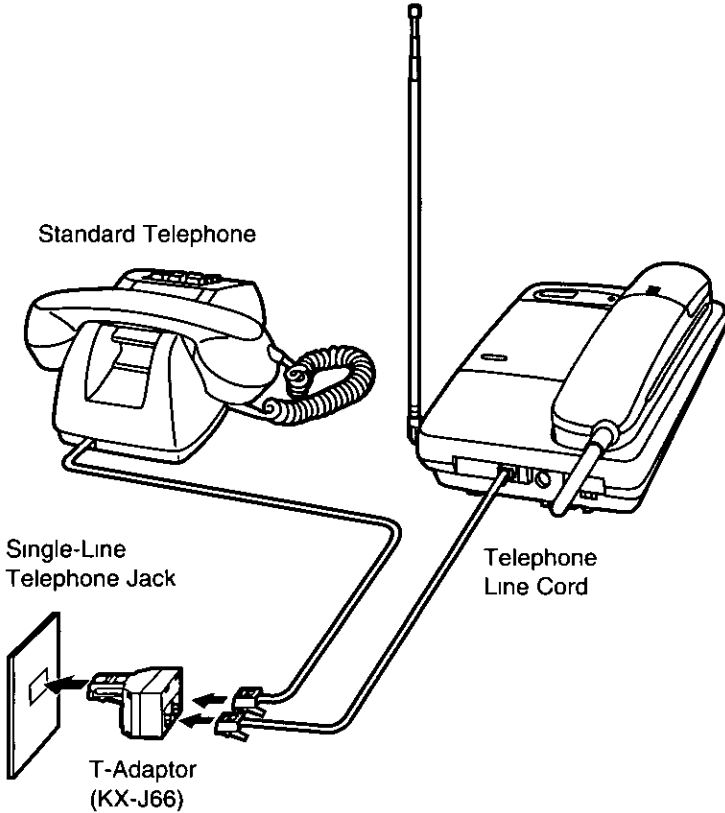

# Before Requesting Help

---

Problem	Remedy
"OUT OF RANGE" is displayed and an alarm tone sounds when you press <b>TALK</b>	<ul style="list-style-type: none"><li>—You are too far from the base unit Move closer and try again</li><li>—Place the handset on the base unit and try again</li><li>—Plug in the AC adaptor</li><li>—Clean the charge contacts and charge again</li></ul>
The unit does not work	<ul style="list-style-type: none"><li>—Check the connection (p 10)</li><li>—Charge the battery fully</li><li>—Clean the charge contacts and charge again</li></ul>
Static, sound cuts in/out, fades Interference from other electrical units	<ul style="list-style-type: none"><li>—Set the handset and the base unit away from other electrical appliances</li><li>—Move closer to the base unit</li><li>—Extend the base unit antenna</li><li>—Press <b>CH</b> to change the channel</li></ul>
The unit does not ring	<ul style="list-style-type: none"><li>—The ringer volume is set to OFF Press <b>VOLUME/RINGER</b> and select HIGH or LOW using <b>F1</b> or <b>F2</b> You cannot select it during a call with the handset</li></ul>
The handset display is blank	<ul style="list-style-type: none"><li>—The handset is in the battery saver mode (p 11) Press one of the function keys to turn the display on</li></ul>
The handset display is still blank after pressing one of the function keys	<ul style="list-style-type: none"><li>—Charge the battery fully</li></ul>
You cannot store a name and phone number in the directory	<ul style="list-style-type: none"><li>—You cannot store a name and number during a call with the handset</li><li>—Do not pause for over 60 seconds while storing</li></ul>

Problem	Remedy
While programming, the unit starts to ring	—To answer the call, press <b>TALK</b> . The program will be cancelled, reprogram again
<b>HANDSET LOCATOR</b> does not function	—The handset is too far from the base unit or is engaged in an outside call
<b>REDIAL/PAUSE</b> does not function properly	—The button has a double function as either redial or pause. It will redial the last number dialed if pressed at the start of a call (p 17). If another number has been dialed first, it will operate as a pause button (p 21).
The BATT LOW indicator flashes or beeps intermittently	—Charge the battery fully
You charged the battery fully, but the BATT LOW indicator flashes	—Clean the charge contacts and charge again —Put in a new battery (p 40)
The unit stops working during operation	—Place the handset on the base unit and unplug the AC adaptor to reset. Plug in, then try again
If you cannot solve your problem	—Call our customer satisfaction center at 201-348-9090

# Important Safety Instructions

---

When using this unit, basic safety precautions should always be followed to reduce the risk of fire, electric shock, or personal injury

- 1 Read and understand all instructions
- 2 Follow all warnings and instructions marked on the unit
- 3 Unplug this unit from wall outlets before cleaning Do not use liquid or aerosol cleaners Use a damp cloth for cleaning
- 4 Do not use this unit near water, for example, near a bath tub, wash bowl, kitchen sink, or the like Never spill any liquid on the unit
- 5 Install this unit securely on a stable surface Serious damage and/or injury may result if the unit falls
- 6 Do not cover slots and openings on the unit They are provided for ventilation and protection against overheating Never place the unit near radiators, or a place where proper ventilation is not available
- 7 Use only the power source as marked on the unit If you are not sure of the type of power supplied to your home, consult your dealer or local power company
- 8 Do not place objects on the power cord Install the unit where no one can step or trip on the cord
- 9 Do not overload wall outlets and extension cords This can result in the risk of fire or electric shock
- 10 Never push any objects into the unit through the slots This may result in the risk of fire or electric shock
- 11 To reduce the risk of electric shock, do not disassemble this unit Take it to an authorized servicer when service is required Opening or removing covers may expose you to dangerous voltages or other risks Incorrect reassembly can cause electric shock when the appliance is subsequently used
- 12 Unplug this unit from the wall outlet and refer servicing to an authorized servicer when the following conditions occur
  - A When the power supply cord or plug is damaged or frayed
  - B If liquid has been spilled into the unit
  - C If the unit has been exposed to rain or water
  - D If the unit does not work normally by following the operating instructions Adjust only controls covered by the operating instructions Improper adjustment of internal controls may require extensive work by an authorized servicer
  - E If the unit has been dropped or physically damaged
  - F If the unit exhibits a distinct change in performance
- 13 During thunderstorms, avoid using telephones except cordless types There may be a remote risk of an electric shock from lightning

- 
- 14 Do not use this unit to report a gas leak, when in the vicinity of the gas leak

## SAVE THESE INSTRUCTIONS

### **CAUTION:**

To reduce the risk of fire or injury to persons, read, understand and follow these instructions

- 1 Use only the battery(ies) specified by the manufacturer
- 2 Do not dispose of the battery(ies) in a fire. They may explode. Check with local waste management codes for special disposal instructions
- 3 Do not open or mutilate the battery(ies). Released electrolyte is corrosive and may cause burns or injury to the eyes or skin. The electrolyte may be toxic if swallowed
- 4 Exercise care in handling batteries in order not to short the battery with conducting materials such as rings, bracelets, and keys. The battery or conductor may overheat and cause burns
- 5 Charge the battery(ies) that are provided or identified for use with this product only in accordance with the instructions and limitations specified in this manual

### **WARNING:**

**TO PREVENT FIRE OR SHOCK HAZARD, DO NOT EXPOSE THIS PRODUCT TO RAIN OR ANY TYPE OF MOISTURE**

# FCC and Other Information

---

If requested by the telephone company, inform them as follows

FCC registration No (found on the bottom of the unit)

Ringer Equivalence 0 2B

The particular telephone line to which the equipment is connected

This unit must not be connected to a coin operated line

If you are on a party line, check with your local telephone company

## **Ringer Equivalence No. (REN)**

The REN is useful in determining the quantity of devices you may connect to your telephone line and still have all of those devices ring when your telephone number is called. In most, but not all areas, the sum of the REN's of all devices connected to one line should not exceed five (5 0). To be certain of the number of devices you may connect to your line, as determined by the REN, you should contact your local telephone company to determine the maximum REN for your calling area.

In the event terminal equipment causes harm to the telephone network, the telephone company should notify the customer, if possible, that service may be stopped.

However, where prior notice is impractical, the company may temporarily cease service providing that they

- (a) Promptly notify the customer
- (b) Give the customer an opportunity to correct the problem with their equipment
- (c) Inform the customer of the right to bring a complaint to the Federal Communication Commission pursuant to procedures set out in FCC Rules and Regulations Subpart E of Part 68

The Telephone Company may make changes in its communications facilities, equipment, operations or procedures, where such action is reasonably required in the operation of its business and is not inconsistent with the rules and regulations in FCC Part 68.

If such changes can be reasonably expected to render any customer terminal equipment incompatible with telephone company communications facilities, or require modification or alteration of such terminal equipment, or otherwise materially affect its use or performance, the customer shall be given adequate notice in writing, to allow the customer an opportunity to maintain uninterrupted service.

When programming emergency numbers and/or making test calls to emergency numbers

- 1 Remain on the line and briefly explain to the dispatcher the reason for the call before hanging up
- 2 Perform such activities in the off-peak hours, such as early morning hours or late evenings

---

**CAUTION:**

Any changes or modifications not expressly approved by the party responsible for compliance could void the user's authority to operate this device.

**Note:**

This equipment has been tested and found to comply with the limits for a Class B digital device, pursuant to Part 15 of the FCC Rules. These limits are designed to provide reasonable protection against harmful interference in a residential installation. This equipment generates, uses, and can radiate radio frequency energy and, if not installed and used in accordance with the instructions, may cause harmful interference to radio communications. However, there is no guarantee that interference will not occur in a particular installation. If this equipment does cause harmful interference to radio or television reception, which can be determined by turning the equipment off and on, the user is encouraged to try to correct the interference by one or more of the following measures:

- Reorient or relocate the receiving antenna.
- Increase the separation between the equipment and receiver.
- Connect the equipment into an outlet on a circuit different from that to which the receiver is connected.
- Consult the dealer or an experienced radio/TV technician for help.

This device complies with Part 15 of the FCC Rules. Operation is subject to the following two conditions: (1) This device may not cause harmful interference, and (2) this device must accept any interference received, including interference that may cause undesired operation.

Privacy of communications may not be ensured when using this phone.

- **Environment**—do not place the unit in room where the temperature is less than 5°C (41°F) or greater than 40°C (104°F). Allow 10 cm (4") clearance around the unit for proper ventilation. Avoid excessive smoke, dust, mechanical vibration, shock, or direct sunlight.
- **Routine care**—wipe the unit with a soft cloth. Do not use benzine, thinner, or any abrasive powder. When you leave the unit unused for long time, unplug the AC adaptor from the outlet.
- **If there is any trouble**—disconnect the unit from the telephone line and connect a known working phone. If the known working phone operates properly, have your unit repaired by one of the authorized Panasonic Factory Service Centers. If the known working phone does not operate properly, consult with your telephone company.

## For product service

- Panasonic Servicenters are listed in the servicenter directory
- Call 1-800-545-2672 for the location of an authorized servicenter

## When you ship the product

- Carefully pack your unit, preferably in the original carton
- Attach a letter, detailing the symptom, to the outside of the carton

### Symptom

---

- Send the unit to an authorized servicenter, prepaid and adequately insured
- Do not send your unit to the Matsushita Consumer Electronics Company listed below or to executive or regional sales offices. These locations do not repair consumer products

- This cordless telephone is designed for use in the United States of America. Sale or use of this product in other countries may violate local laws
- Ce téléphone sans fil est conçu pour être utilisé aux Etats-Unis d'Amerique. La vente ou l'emploi de cet appareil dans certains autres pays peut constituer une infraction a la legislation locale
- Este teléfono sin cordón fue elaborado para uso en los Estados Unidos de América. La venta o el empleo de este producto en ciertos países puede constituir violación de la legislación local
- このコードレス電話機は、日本国外での使用を目的として設計されており、日本国内での使用は法律違反となります。従って、当社では日本国内においては原則として修理などのサービスは致しかねます。

**Matsushita Consumer Electronics Company,  
Division of Matsushita Electric Corporation of America**  
One Panasonic Way, Secaucus, New Jersey 07094

**Panasonic Sales Company ("PSC"),  
Division of Matsushita Electric of Puerto Rico, Inc.**  
Ave 65 de Infantería, Km 9.5, San Gabriel Industrial Park  
Carolina, Puerto Rico 00985



## Free Manuals Download Website

<http://myh66.com>

<http://usermanuals.us>

<http://www.somanuals.com>

<http://www.4manuals.cc>

<http://www.manual-lib.com>

<http://www.404manual.com>

<http://www.luxmanual.com>

<http://aubethermostatmanual.com>

Golf course search by state

<http://golfingnear.com>

Email search by domain

<http://emailbydomain.com>

Auto manuals search

<http://auto.somanuals.com>

TV manuals search

<http://tv.somanuals.com>